

AMERICAN BEE JOURNAL

DEVOTED EXCLUSIVELY TO THE INTERESTS OF HONEY-PRODUCERS

ESTABLISHED 1861
THE OLDEST BEE-PAPER IN AMERICA

Published Weekly, at \$1.00 per annum. Sample Copy sent on Application.

36th Year.

CHICAGO, ILL., JAN. 2, 1896.

No. 1.



Specialty vs. Mixed Bee-Keeping.

BY F. L. THOMPSON.

"I am one of those who hope yet to see a class of amateur bee-keepers on the American continent, who will keep bees for the love of the thing, and not merely for the money they may make out of it."—BEE-MASTER, on page 409 of the Bee Journal for 1895.

"Essays advising that bee-keeping as a business be made a specialty by the persons engaged therein, have been written from

speaking on this subject, with an invitation to everybody, and the seats would be crowded with eager listeners."—R. L. TAYLOR, on page 662 of the Bee Journal for 1895.

In view of the above sentiments, it seems appropriate at this time to inquire whether the keeping of bees by farmers would make them more intellectual than they are.

It must be admitted that in districts where the honey crop is a total failure for one, two, or three years in succession, that specialty cannot well be pursued. But there are left large areas where there is always something every year. Shall bee-keeping in these places be in the hands of a great many side-issue farmers, or would it be of more benefit to the country by being in the hands of specialists?

Let me also say that Bee-Master's words touch a responsive chord in my nature. Very much pleasure and benefit in this world have no connection with money. In spite of the cant of "practical" men (who would do well to confine themselves to business, and not settle every question in heaven and earth by "practical" standards), they can neither be bought nor sold. I prove that every day of my life, and I pity those



Apiary of Mr. J. B. Tucker, Wallingford, Conn.—See page 8.

time to time. The essayists are often eloquent in their advice, but never, I believe, practice what they preach."—W. G. HEWES, quoted with approval by Mr. Abbott, on page 270 of the Bee Journal for 1895.

"Bee-keepers' conventions are not always well attended, because only bee-keepers are invited, and they, in order to attend, must generally go long distances; but let competent men go into the country school-houses, in districts where the farming communities are starving for want of social and intellectual excitement, during the months when they enjoy comparative leisure, to

people who don't see it. But, Bee-Master, don't you think there is as much poetry in three or four colonies as in 20? The argument of poetry and pleasure is not in itself sufficient to turn over the main bulk of bee-keeping from specialists to amateurs.

Mr. Abbott, on page 173 of the Bee Journal for 1895, would solve the question by making a great number of small specialists, letting a younger member of the family have the exclusive care of the bees. He says he is confident that api-

culture can be more successfully conducted as a branch or part of mixed agriculture than in any other way, by so doing. Perhaps it can be; but the trouble is it won't be, as long as human nature remains what it is. General farming necessarily includes a certain amount of hard, rough labor, both in and out of the house, which is enough to stultify the minds of 40 families out of 50 to such a degree that energy enough cannot be summoned to regard the care of bees in any other light than that which one regards milking, cleaning stables or baking bread. I have been there, and know something about it. I will add further, that I believe it the next thing to a sin for most people to get up before six o'clock; but that you can't succeed in general farming unless you do. Under these conditions, the bees and honey-trade are better off in the hands of specialists; and the farmers themselves are better off, if, excepting three or four colonies "to make things homelike," they are not given the additional burden of 20 or 30; and they would be better off still if they each made some one branch of agriculture their main work—dairying, fruits, bee-keeping, grain—so as to give their minds a chance to grow by becoming so familiar with the contingencies of that one branch as to keep ahead of their work, and have time for the relaxing, recreating influence of some *small* hobby, which they may practice for the "love of the thing."

It would be well enough if some member of the family not only had the exclusive care of the bees, but did nothing else to speak of than to take care of them. But in how many families can that be done?

As it is, farmers are the intellectual class. Mr. Abbott himself realizes this on page 590 of the Bee Journal for 1895, and Mr. Taylor realizes it in the quotation above; but they do not seem to see that there is nothing else to make farmers so than their mode of life—their constant round of work which is drudgery just because it is not specialty; and these gentlemen propose, as a remedy, to increase their drudgery!

Specialty means broad-mindedness. It is not possible for a man to get under the surface of one branch without new and fresh ideas of the relations of things, which assist him to a better comprehension of the deeper relations of other branches, than if he was jack-of-all-trades and master of none.

Specialty means happiness. It is the non-specialists who say, "What's life worth living for, if you can't have a little fun now and then?" The specialists have their fun all the time.

I have not before responded to Mr. Abbott's call for specialists, because I had some idea of making chickens add to my income. But I hesitate no longer. I will keep bees for profit and chickens for pleasure—and eggs for my own use; and arise to remark, that for the last two years, with very trifling exceptions, I have been supporting myself on bees exclusively, and expect to continue to do so. Arvada, Colo.



☞ A natural ability and a rational enthusiasm are necessary to make a successful bee-keeper; and therefore, unless a man makes himself thoroughly acquainted with the peculiarities of bees, he is doomed to disappointment should he attempt to give his time and capital to this occupation. —SIMMINS.



California as a Bee-Keeping State.

BY PROF. A. J. COOK.

I know of no better introduction to this series of articles, than some candid statements about California in relation to the bee-keeping industry. If I am a little enthusiastic, I am sure that the facts that I shall pen in this article will warrant my fervor.

First, the bee-keeper, like men of any other pursuit, wishes a pleasant home and surroundings. If his lot falls in Southern California, he has the grandeur of mountain scenery, constant summer, with very few days that know any frost, and about as many weeks that are unpleasantly hot. From October to March a little fire is needed much of the time in early morning and late evening, with an occasional day when a fire all day is pleasant. And, if we may judge from the two seasons of my sojourn, only the month of September is oppressive for its heat; and then less than half the time, so that no one can complain who loves warmth and sunshine.

Warmth and sunshine bring fruit, and so every month in the year, one can have, at very slight expense, the most luscious fresh fruit. Oranges from February to June, strawberries every month, and plenty and cheap from May to No-

vember; blackberries from May to September in profusion, with cherries or plums much of the time; lemons the entire season, and luscious apples and pears all the winter months, or from September to March, and the most delicious apricots, nectarines or peaches from May or June to September. Thus, to the lover of fruit, Southern California comes with wide-open arms to offer the best of all climes and zones. Nor are the social attractions less inviting. Culture, refinement and genuine heart sympathy and regard are most luxurious products of this sunny southland. I never met such Christian courtesy; such a warmth of interest, such hearty fellowship, as I have met since coming to this genial clime. Thus the bee-keeper of Southern California may surround himself with all that makes life rich and full, of the best of comfort and blessing.

Again, no winter problem confronts the Californian bee-keeper. There is not a month in the year that the bees do not gather and even store some honey. The eucalyptus, which is rapidly coming to the very front, as a shade-tree, has scores of species, many very beautiful, and all very rapid growers. Most are good honey-trees, and by proper selection we may secure beautiful species that will give a succession of bloom throughout the year. The only danger comes from starvation, and that never threatens any but the improvident bee-keeper. There are occasional years—about one in five, if we can judge from the past 20 years—when the bees will gather no honey—not even enough to keep them from starvation. Thus every wise bee-keeper will never extract so closely as to run any risk. He will always leave at the close of the season ample food for a year. And then if the 15 to 25 inches of rain which insures a honey crop comes with winter, he will in the spring extract the surplus from the hive, which will surely be cured to the satisfaction of the most fastidious.

Again, as abundant rains insure a crop, the bee-keeper knows in winter what the harvest will be; so there are no long months of fruitless expectation. This fact has further advantage—it prevents buying supplies, unless they are to be needed, and gives one certain warning months in advance that he is to look about for some occupation other than that of bee-keeping.

As I have said, seasons of failure do not come oftener than one year in five; and it looks as if, with suitable forethought, removing bees to regions of alfalfa bloom, or orange orchards, or bean-fields, we may at least secure sufficient stores for the bees even in the "off" years. This is likely to be even more probable with the maturity of the numberless eucalyptus trees now being planted. Last year (1894) was a very dry one—only 11 inches of rainfall here at Claremont, and much less fell in considerable of the bee-keeping range. Fifteen inches is the reported minimum for a honey crop from the usual forage of sage and wild buckwheat. Thus, last year, there was a total dearth of nectar-secretion in many regions. Yet several apiarists in the regions of alfalfa fields secured a fine crop. Others, doubtlessly, could have reaped a similar good fortune had they known the value of alfalfa as a honey-plant, and moved their bees to regions of its bloom.

There are two other features of California apiculture which are unique and very encouraging. I refer to the great production in favorable seasons, and the astonishing number of colonies which can be kept in one locality at such times with profit. The past season, though not one of the very best, illustrates both of these points. In large apiaries of from 200 to 300 or more colonies, the product was from 100 to 150 pounds per colony. Thus several apiarists that I have known of, secured upwards of 30 tons of honey, with less than 500 colonies of bees. With a knowledge of the flora of this section, this is not so hard to understand as the enormous yield of wheat and hay to the acre that is sometimes reported in sections of this State—50 bushels of wheat and 18 tons of hay; for in no sections of my acquaintance are the flowers so long in bloom. White and ball sage are in bloom for two months or more, and the famous wild buckwheat even longer. Thus the nectar is not only very abundant in the flowers, but the latter continue to yield for a very long period of time.

The pioneer bee-keeper of California, and once the largest producer of honey in the world—the celebrated J. S. Harbison, now of San Diego—has demonstrated that ball sage, an excellent honey-plant, can be easily transplanted and made to grow in all the hilly regions of Southern California. As these wide ranges are useless for other purposes, we may hope that the importance of the bee-keeping industry of Southern California may in the future wax rather than wane. The great increase of the eucalyptus plantation will also tend in the same direction.

If the growers of alfalfa were, also, at the same time bee-keepers, or would become partners with bee-keepers, so as to delay cutting the crop a little, till the bloom had offered a

honeyed banquet for the bees; or if some of each cutting was held for seed, there might be still another considerable increase in the honey-product. How few, too, realize at present from the extensive bean-flora of Santa Barbara and Ventura counties. Mr. Mendleson, the past season, secured a fine crop of bean-honey after the regular season was over. I sampled the honey, both comb and extracted, and can speak truly of its excellence. Here, then, is a farther opportunity to increase the honey-resources of our section.

There seems, then, but one serious obstacle in the way of exceptional success in apiculture in Southern California. I refer to the poor market for the honey. Prices range away below what is reasonable and right. Finest grades of extracted honey sell for 3 cents to 4½, when 6 cents is the minimum that should ever be paid for first-class extracted honey. It is not that the consumer gets it at these figures—the low price is due to the system of marketing. Impecunious producers, to secure ready and needy funds, sell at starvation rates, and fix the price. The producers do not propose to suffer this system to continue. They are organizing to control the output as the orange-men are now controlling their product by aid of the Fruit Exchanges. The bee-keepers seem unanimous in the desire to form a honey-exchange. We believe they have the intelligence, the energy, and the wisdom to make a success of the undertaking.

Pomona College, Claremont, Calif., Dec. 12, 1895.



Some Subjects Reviewed and Commented Upon

BY DR. C. C. MILLER.

SWEET CLOVER.—Many thanks to Mr. Stolley for such a satisfactory reply, given on page 805, and I know of only one question I should ask just now if he were within ear-shot. That is as to the quality of sweet clover honey as compared with alfalfa. I know what alfalfa tastes like, but I never tasted anything that was called sweet clover honey without just a little uneasiness as to whether it was the genuine article.

For the sake of those who say that if sweet clover is cut for fodder, it must be while young, and that spoils the chance of the bee-keeper, I want to call attention to the advice of Mr. Stolley, to cut while young for the sake of making it sprout vigorously. In this part of the country I think I'd much rather have it cut while young, for then it blooms a little later, and where white clover yields well, the early blooming of sweet clover is not so desirable as that which comes after white clover is gone.

AMALGAMATION.—The discussion seems to be on. With some of the views expressed by Geo. W. Brodbeck, on page 807, I'm in accord, but as to others I'm decidedly "forenrest" him. He says the North American Bee-Keepers' Association is an "admitted failure." As I think of the many delightful meetings held by it, I, for one, am not willing to admit that it was a failure, and I see no indication that it is not now as good as ever.

But say, Geo. W., what ever put it into your head to oppose consolidation because "you cannot combine business with pleasure?" Look at the grand successes of the German societies with their thousands of members, where they combine business with pleasure with a vengeance.

As to some other points, I'll turn you over to the tender mercies of the other brethren, merely saying that I'm with you in thinking there's no need of any assessment clause.

T SUPERS.—Referring to page 808, let me suggest a change that I think Mr. Schartz would like: Instead of nailing a T tin on the bottom of each end of the super, merely nail on a plain strip of tin ½ inch or so wide, letting it project about a quarter of an inch for the sections to rest on. The sections will go in easier, and I think he'll like it better. Then instead of using T tins on top, just use little pieces of wood 11 inches long, ¼ inch wide, and nearly ½ thick. Just push these down between the sections, and it will do the business nicely.

A FREE SHOW.—It may be all very well to attend a convention without paying anything to get in, but suppose every one does that thing, how are the bills to be paid?

BURR-COMBS.—The answers on page 819 show a change of opinion. Only five think the Heddon slat honey-board the best thing to prevent burr-combs, and in strictness hardly that, for one of them has never tried anything else, and the others do not say they have tried the same means that have succeeded elsewhere. I don't think the break-joint feature

of any value, but I've always felt we owed a debt of gratitude to Heddon for telling us a way to manage when we didn't know of anything better.

THAT HORRIBLE AFFAIR.—The relation of that Horrible affair on page 807 is breaking away a little from established usage, but I believe the established usage of hushing up every wrong is itself a great wrong. If one finds out a man is a rogue, let him warn others.

WINTERING.—You may be right, Mr. Sage, in thinking as you do on page 818, that a colony in a good hive kept dry with plenty of stores will come out all right with you, but please remember that all places are not like Linton. But I'm with you in thinking that, as a rule, bees will winter better in a box-hive.

AN AX TO GRIND.—Easy, easy, Bro. Kelly, in making charges of ax-grinding against hive-makers—page 817. Suppose they do try as much as they can to have all goods of standard kinds, and to have as few kinds as possible, as they can manufacture at less cost; isn't that also for the benefit of the consumer? If each one of us had hives and sections of such patterns as were used by no others, it would cost us a round sum for our "fixins."

THE NEW CONSTITUTION.—The candid remarks of Mr. Newman, on page 822, throw an entirely different light upon the whole matter. Of the major part of the work, as detailed in his second paragraph, I knew nothing, and can hardly be blamed for supposing there was nothing of the kind, as I was a member of the Union. Nothing of the first sending out reached me, nor of the second, and I feel sure the omission was not intentional, but all the same it left me so that I never dreamed anything of the kind had been done.

I cannot agree, however, with Mr. Newman, that "the suggestions about Canada, given on page 793, are quite in order." Unless I have some misunderstanding of the case, they are utterly out of order. If there is a single thing that shows any more recognition of the United States than of Canada, I have failed to discover it. The charge is, "the entire absence of all recognition of Canada, except so far as it is part of North America." The complainant could hardly have read carefully Art. I, or he would not have said "entire absence." In that article occur the words "United States and Canada." There's no other mention of either Canada or the United States throughout, and I don't see any need of further mention. Half the committee were Canadians, and Canada had exactly the same recognition the United States had. Won't it be "quite in order," Mr. Newman, for you to reconsider your opinion as to the suggestions about Canada?

A word as to the manner of voting: Mr. Newman does not agree with my views. Now, Mr. Newman, admitting all you say to be correct for the present, it isn't a sure thing that you'll live always. Then a new Manager will come into office, and after he has been tried a year he may be found wanting, or at least it may be thought some other would do better. Each member sends him an open ballot, and the probability is that many who do not feel very strongly in the matter will send a vote in his favor that they would not send if the vote were sent elsewhere. If this were not so, why is it that it is so common a thing in deliberative bodies to take the more tedious way of voting by ballot instead of the much shorter way of counting noses? And I'd rather have the change made now when you're in office, than to wait till the necessity arises.

Marengo, Ill.



How to winter bees successfully has been to bee-keepers their most vexatious problem, and it may be safely asserted that failure in bee-keeping is chiefly attributable to defective wintering.—QUINBY.



Large Hives; Size and Shape of Hives; and Conditions Necessary to Safe Wintering of Bees.

BY CHAS. DADANT.

(Continued from page 822.)

In my last article, I have granted that the small hives, in a bad season, will give a little more surplus honey than the large hives, because there is more room in the large hive-body and the quantity stored in the upper story of the small hive will be easily stored in the brood apartment of the large hive.

Let us now turn a leaf and see what the result will be in the spring.

In the first place, the small-hive apiary will be reduced in numbers, more than the large, owing to the fact that the colonies, having less honey, will have bred less in the fall; therefore being weaker—or, if you prefer to say, less populous—they will be less able to withstand the extremes of temperature. The large-hive colonies are better fitted for winter; having more bees they keep up a good heat. Their honey, which the bee-keeper would have sold, had they been in a small hive, is more likely to be well sealed than that of the others, and if of the early crop, it will be of better quality for wintering, being whiter than that which is harvested the latest, and the bees can stay a long while without having to take a cleansing flight.

In the early spring, those colonies which are well supplied, breed without stint; they know that their stores will last, and are not afraid of a few backward days. Those of the small hives soon see the end of their stores, and if they are not constantly watched and fed back by the apiarist, they suffer. The result is a better crop from the large hives, and if the season happens to be an early one, the result may be more than a double crop from the hives that are best supplied.

We discovered the great difference in results between colonies in a hive that has to be fed in the spring, and one that has plenty, in the following manner:

In 1877, we had three or four apiaries away from home, one of which was located on the farm of an old countryman of ours, five miles north of our home. A part of the hives in this apiary had been placed by him in the front wall of a hot-house. These colonies were exceedingly strong, and as they had a large amount of honey which could not be extracted, owing to their situation, they swarmed over and over, and we found ourselves rather crowded for hives. We were not then, as yet, using comb foundation for the frames, and a few of the hives were not even supplied with the triangular top-bar frames. The result was that a number of our swarms—probably 15 or 20—built their combs in the 10-frame Quinby hives crosswise instead of lengthwise of the frames. Any one who has had to transfer bees knows that it is much more difficult to transfer them from a movable-frame hive when the combs are built in this way, than from a plain box-hive.

As we were very busy all that season, we left the hives in this condition. It was then our custom to take two or three of the outside combs, in those large hives, every fall, and extract the honey out of them, taking it for granted that 20 or 25 pounds were sufficient to winter any colony. These hives, having no combs that could be taken out without transferring the entire lot, were left with all the extra honey. We fully intended to transfer them the following spring early, but it was such an ugly job that we delayed it until it was too late.

These colonies had plenty and to spare. They needed no feeding, and gave nearly twice as much as the others. But we did not think about this extra supply as being the cause of their greater yield, and it was not until we had transferred a few of them that we noticed that evidently the cause of their greater crop was due to their more prosperous condition. What had been procrastination on our part, turned to be a very good test. After that we ceased extracting honey from the lower story of those large hives, except when the bees are altogether too much crowded with honey.

And please take note: It is only with large experiments that one can make sure of the advantage of one method over another. For example: When we heard of the chaff hives, made with a wall three inches thick, some 20 or 25 years ago, we were struck with the advantage claimed for them. We tried about a half dozen, and succeeded so well that we had a lot of 80 of these hives made for our apiaries. We have since ascertained that the chaff hives were not suitable here, for whatever they save during the cold of winter, they lose in early spring, as the same wall that keeps the cold out also keeps the rays of the sun from warming the hive at a time when the bees need to be induced to take flight.

Last, but not least, among the advantages of large hives is the decrease of swarming. With our present methods, we have no swarms worth mentioning; but when the bees do swarm, these swarms are of very large size. We find that it does not require a constant watch during the swarming season, for the few swarms that issue make enough noise to attract attention.

How often this question is repeated in the Bee Journal? "How can I prevent swarming?" It is impossible to prevent it altogether, but large hives will very materially reduce it, for the reasons already mentioned. There is one cause of natural swarming which cannot be very well prevented. It is the superseding of the queen during the honey crop. If the queen seems to weaken, the bees will at once rear a

number of young queens, and swarming will result. This will happen in hives of any size, and we do not see that it may be prevented. But the excessive swarming—so annoying in apiaries with small hives—is done away with when sufficiently large hives are used.

Many bee-keepers will say that the production of swarms is profitable. This is so; but I much prefer "making the swarms" myself, artificially, because I rear queens from the best bees, and can take the "swarms" from those colonies which would not produce any surplus honey.

There are many points to consider in the selection of breeding-queens for reproduction. These are prolificness, gentleness, activity, endurance in winter, etc.

Hamilton, Ill.



☞ No bee-keeper worthy the name, will allow his bees to go into winter quarters short of stores.—HUTCHINSON.



The Ventilation of Bee-Cellars.

BY G. M. DOOLITTLE.

A correspondent writes that he has his bees in the cellar, all in nice shape, but he has fears about his having ventilation enough for his cellar, in the two six-inch pipes he is using, and wishes me to give an article in the American Bee Journal on the subject of ventilating bee-cellars.

When I first built my bee-cellar (which is a hole dug into a hillside, 24 feet back by 7 feet wide and 6½ feet deep, with mason-work walls, and covered with flag stone, with three to four feet of earth over all, and a board roof covering the earth), no one could have made me believe but that any place in which bees were to be kept, should have means provided for a direct draft of air through it, at any or all times when the weather was mild enough to admit of it, without running the temperature of the cellar down too low. For this reason I prepared for what I considered the best possible ventilation

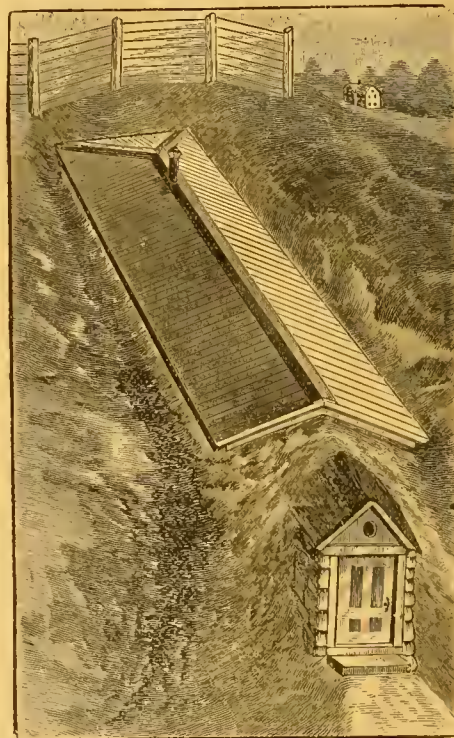

Fig. 1—Outside View of Doolittle's Bee-Cellar.

of this bee-cellar when I built it, the ventilation being done by putting in a sub-earth ventilator, something over 100 feet long, this to carry in pure warmed air from the outside. At the top, in the opposite end, was the ventilator to carry off the impure air, a regulator or damper being provided, so that the amount of air could be adjusted to any amount required, from the whole amount, which was 50 square inches, to none at all.

As the sub-earth ventilator was placed deep in the ground, I thought that it need not make the cellar too cold by leaving the upper one wholly or partially open all the time; but when I came to put it in actual practice, I found that, in all cool weather, when there was a wind, I could not keep the temperature where I wanted it, so I began closing the upper ventilator entirely, except on all days when there was no wind, or the mercury stood above the freezing-point. As this made an

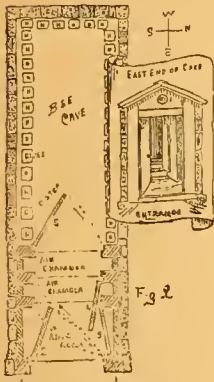

Fig. 2—Ground-Plan.

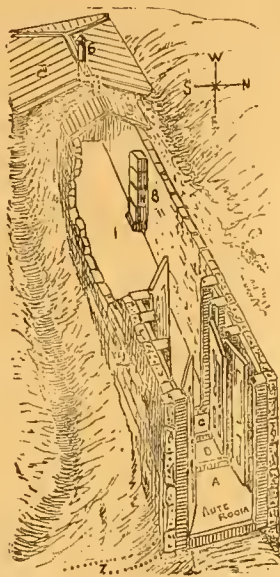

Fig. 3—Roof Torn Away.

endless lot of work, I resolved to leave it closed entirely for two weeks, and see what would become of the matter. It was with some misgivings that I went into the cellar at the end of the time, but I found the bees in splendid condition; in fact, they appeared the nicest and most quiet that I had ever seen them. I then gave the cellar a good draft for two or three hours, when the ventilator was shut again, and as the weather was extremely cold for a month, all direct ventilation was shut off during this time. As the bees seemed to be in the best of condition still, I then went to work shutting up both ventilators till I became fully satisfied that enough air came into this underground cellar, through the mason-work and dirt covering, for all the wants and requirements of the bees.

Now, I not only found that the bees wintered just as well as formerly, but a little better; and what was of more value to me still, I now had no trouble in controlling the temperature.

EVENNESS OF TEMPERATURE IN BEE-CELLARS.

This brings me to another point which I wish to speak of, and that is evenness of temperature. Some seem to think that a cellar will be too cold in a cold winter, and too warm in a mild winter, or that the temperature will vary in it, just in proportion as it does outside. Any cellar which will thus change temperature to any considerable extent cannot be the best possible place to winter bees. This cellar of mine does not average one degree warmer in the "warmest winter ever known," from where it stands in the coldest winter ever known, and all the changes in the outside temperature from day to day does not affect it at all; no matter if the temperature stands at 60° above zero for a week, and 10° below zero for the next week, it changes not inside, for the warmth of Mother Earth remains unchanged, when you get a little way under the crust.

When the bees are put into this cellar, the temperature stands at about 50°, till they get quieted down so as not to throw off animal heat in excess of that required when in their semi-dormant condition, after which it gradually goes down to about 45°, where it stays all winter, rarely varying more than one or two degrees from this afterward, till spring; or when I take them from the cellar.

This evenness of temperature, and keeping it at about the desired point, is one of the great secrets of successful wintering in cellars, and one of the reasons why I prefer a cellar entirely under ground, and away from any building, or that which may give it an unevenness of temperature.

With a temperature as above, no bees come out of the

hive to die, except those which die a natural death from old age.

SHUTTING BEES IN THE HIVE IN THE CELLAR.

This causes me to speak of another point, which is, the shutting of bees in their hives by means of wire-cloth or otherwise, to keep them from leaving their hives, as some seem to think necessary. Such ideas are fallacious, and only suggest themselves to the inexperienced.

The reasons for not shutting the bees in their hives are, first, when an old bee gets ready to die, it always leaves the hive, if the temperature in which the hive is kept will admit of its doing so. Now, in a cellar of the proper temperature, these old bees can always do as nature prompts, and so strive to carry out this part, that they start some time before they expire to get away from the hive; and if confined to it, they keep returning to the cluster, running over the bees, buzzing away on the wire-cloth, etc., so that when large numbers expire at the same time, as they often do toward spring, the whole colony is aroused, when a struggle for freedom ensues, which is often very damaging to the whole colony, if it does not result in their death.

Again, where the cluster spreads out to take in new supplies of honey from the surrounding combs—as most colonies do several times during the winter—they will come out on the outside of the hive, walk about a little and return. If on such occasions they find themselves prisoners, the same kind of stampede occurs as before, and much harm is the result.

After experimenting for years in regard to how the hives should be placed in the cellar, I now raise them from the bottom-board from two to three inches all around, leaving this space entirely open, so the bees can pass out or in as they please. Borodino, N. Y.

[The engravings of Mr. Doolittle's bee-cellar, as well as the following description of them, are taken from that excellent book—Root's "A B C of Bee-Culture"—having been written by Mr. D., himself, in January, 1888.—EDITORS.]

Fig. 1 represents the outside appearance of the cellar as viewed from the southeast. The ground should rise gradually from the foreground up to the fence, the back end of the roof at the peak being lower, or as low, as the ground opposite to it on each side. The outer roof is hemlock boards battened. In Fig. 2, 1 represents the window in the gable-end of the ante-room, so I can have a little light after I go in and shut the first door. In this ante-room (see Figs. 2 and 3) I light my candle, have the sawdust to carry in to spread on the floor, etc. In Fig. 3, 4 is the upper drain, or water-course, to carry off all surplus water coming from the roof and elsewhere, it being made in a large scoop form by taking dirt out to go between the two roofs, as illustrated in Fig. 1. The fence is shown in the rear. This causes the snow to drift on the roof. In Fig. 3, 6 shows the ventilator at the back end of the cellar.

Fig. 2 represents the front view, also the ground-plan of the ante-room and doors. 1 is the casing that the outer door hangs on, and against which it shuts; 2 is the outer door which swings in and around against the south side of the ante-room; 3 is the first door toward entering the cellar; and in opening, it swings out and around the north side of the ante-room, finding the position when open as represented; 4 is the next door, two feet further in, which in opening also swings around against No. 3, as shown; 5 is the door entering the cellar; and in opening, it swings into the cellar against the south wall, unless the cellar is full of bees, in which case a stop is so placed that it will not hit the hives.

In entering the cellar I first go into the ante-room and shut the door, as I have explained; then I open Nos. 3 and 4, and step into the last dead-air space, closing No. 4 after me, but allowing No. 3 to remain open. I now open No. 5, and quickly step into the cellar, closing after me. Thus it will be seen that very little change of air can take place by my entering, especially when I say that all is covered overhead and on all sides with dirt, except the ante-room.

Fig. 3 represents the inside of the cellar. 1 represents the floor, or cellar-bottom. This is always quite dry, and there is a drain under the wall, and below the bottom all around, being 8 inches deep at the southwest corner, and 20 inches deep at the northeast corner, or outlet. 2 represents the south wall. The hives are put up along both walls and west end, putting one on top of the other ones four deep, as seen at 8; also by H. H., etc., in Fig. 2.

In Fig. 3, 3 is the luner roof, which is made by using 2x6 stuff for rafters (which are a foot apart), with 1-inch boards nailed on them at the top. [In the summer of 1890 these boards had become rotted so much that the roof caved in. To

prevent a recurrence of this, Mr. Doolittle uses stone flagging instead of the boards. If the latter were covered with tarred paper above and below, it might answer equally well, and, at the same time, be cheaper.—Ed.] 4 is the 3 feet of dry earth between the two roofs, 5 representing the outside roof. 6 is the ventilator, showing the two elbows, which effectually exclude all light. The hole in it is 6x8 inches square. 7 is the sub-earth ventilator, which is 4 feet deep, as far as may be, and 100 feet long; but, as I have said before, this and the upper one are closed of late, winters, while the bees are in the cellar. As I have often expressed, I believe this is the best underground arrangement possible for wintering bees, and I have tried to make it all plain, so any person can build one who desires. The cost to me was not far from \$80; but, of course, prices of lumber, stone and labor, vary in different localities.



Bees of Right Age for Wintering.

We are convinced if A winters his bees just as B, and in one locality the bees cease to breed sufficiently early to mature and have a cleansing flight, and in the other this is not the case, the results will vary, and the first will secure more satisfactory results with less thorough methods, and such a case may be used as an argument against the more thorough and better methods.—Editorial in Canadian Bee Journal.

Just so; and equally if the bees cease to breed so early that the bees are all too old, the result will not be satisfactory.

Wants Him "Sot Down" On.

Rev. W. F. Clarke says that when the membership fee to the North American Bee-Keepers' Association gets down to 25 cents, he wants no more to do with it. Has the reverend gentleman made so much money from bee-keeping lately that he had rather pay \$1.00 than 25 cents? Or is it because he does not wish to associate with the rank and file? If so, he had better use his powerful influence to get the fee raised to \$10, if, according to his views, the higher the fee the better the organization. I think we poor "25-cent fellers" ought to "sit down" on the reverend gentleman. We want no aristocracy in ours.—Observer, in Progressive Bee-Keeper.

Prospects for Nebraska.

In looking over the year's correspondence we gather these figures for the State of Nebraska: Loss of colonies of bees from September, 1893, to May, 1895, 95 per cent. Surplus honey placed on the market, 10,000 pounds. Gains in colonies, May 18, 1894, to September 18, 1895, about 4 to 1, so that we go into the winter with about 20 per cent. of the number we had to begin the winter of 1893, and nearly one-half as many as in 1894, and our surplus honey crop this year is more than ten times that of 1894. One year ago we predicted very heavy losses on account of there being so few young bees to begin the winter with. This season the reverse is true. Colonies are well stocked with sealed honey and plenty of young bees, and we think bees will winter better than for some years past. Not since the fall of 1889 has there been as good a show for the coming year being productive of honey as now. In 1890 and 1891 we produced more honey than any other two years in the history of our State. Get your dishes ready. There will be honey next year. The fall rains this year have started the honey-plants in good shape, and unless they are destroyed after this, there will be a larger honey-production to the square mile than there has been for a long time.—Editorial, in December Nebraska Bee-Keeper.

Alfalfa in Illinois.

W. W. Pusey, residing near Odell, Livingston County, Ill., has been growing alfalfa on his farm the past two years and has made quite a study in regard to its culture and of caring for the plant. In conversation with a reporter of the Bloomington Pantagraph he said:

"Alfalfa should be sown the latter part of April, and it would do to sow it in a very wet fall, like this one, in August or September. As a rule, in ordinary years it is good pasture by April 20, five inches high. There is no other pasture that will do to pasture so early in the season grown here. It can stand several hard freezes, and, if protected by rubbish, it will grow all winter."

It has yielded on his farm two tons per acre each cutting, and he has good fall pasturage afterwards.

The first cutting should be done the last of May, second cutting middle of July, third cutting the middle of September, and his experience has been that the straw is no more difficult to care for than timothy, and not so hard to care for as clover. It does not "dust" as does clover, by lying too long on the ground. The main root resembles the ordinary garden parsnip with fine lateral branches like the small roots of a parsnip.

Alfalfa enriches the ground by the long roots bringing the mineral substances to the surface, which other grasses do not do, as their roots do not penetrate the earth to the mineral depth. Alfalfa becomes of age or full growth in four years from the planting when the outside bark or shell of the root sheds off and a new bark grows. This is done annually after four years, which further acts as a fertilizer to the soil and loosens the earth, thus acting as a self-cultivator.

Mr. Pusey thinks alfalfa is the coming feeding hay for this section, as it will grow better in a dry year than timothy or clover, and the yield is far in excess of any other grasses in any season, and reduces the acreage required for feed, which could be used for grain by a farmer. He has given up growing any other plant for feed, and his experience has been that all kinds of stock thrive better than feeding or pasturage on the other grass feeds.

Some "Stray Straws" from Gleanings.

Cellared my bees Nov. 13. Oh, but they're heavy!

Lots of fun dreaming over what big things the bees will do next year.

Never forget that bees can stand more cold with good air than with bad. So can you, or any other animal.

The linden, according to an article in Gravenhorst's Bienenzeitung, yields well only about four times in 26 years. Better get some American linden.

Foundation with wood-base $\frac{1}{8}$ -inch thick is favorably mentioned in Gravenhorst's Bienenzeitung. For extracting it has the advantage that no wire-cloth is needed in the extractor.

Why is it that bees get lazy in a little while when working on feeders, and keep up a life-long interest in flowers? Would they keep the same interest in the feeders if they traveled the same distance to them?

Although bees are in the cellar, I expect to keep doors and windows open day and night for some time—as long, anyhow, as keeping them open doesn't bring the temperature of the cellar below 40°. When it goes below that, I'll shut up and keep it at 45° or more.

Heather honey is so thick that as yet it has never been emptied by the extractor. One of the live questions at the present time in Germany is as to some machine or management by which it may be extracted, and the sturdy bee-keepers of that land are hopeful.

Dzierzon, the German Langstroth, who invented movable combs in Germany, never allowed the advisability of end-bars and bottom-bars until the advent of the extractor. He used merely a top-bar; and when he wanted to remove a comb he cut it away from its side attachments with a knife.

The bee-keeper's year, says Lebrecht Wolff, in Gravenhorst's Bienenzeitung, does not begin in spring, nor Jan. 1, but Oct. 1. That's when I start a new record-book each year, and about the first entry is hauling home the bees from the out-apary. Each volume of Deutsche Illustrierte Bienenzeitung begins, not Jan. 1, but Oct. 1.

Temperature alone will not decide when bees will fly. If badly in need of a flight they may fly at 40°, whereas they might stay quietly in their hives at 60° if there were no pasturage and they had not been long confined. They'll fly at a lower temperature in bright than in cloudy weather; and when honey is yielding than when nothing is to be had.

I wonder why it is that in Germany heather honey brings lower price than clover, and in Scotland higher. [It's all in the taste, Doctor. Some people think Limburger cheese very delicious, and others can't bear to have it in sight. But, say: in York State there are not a few who think buckwheat honey far superior to any white honey ever produced.—Ed.]

Questions AND Answers

CONDUCTED BY

DR. C. C. MILLER, MARENGO, ILL.

[Questions may be mailed to the Bee Journal, or to Dr. Miller direct.]

What Probably Caused the Queen's Death?— Winter Stores—Packing Bees.

1. Sometime ago I united two weak colonies, the one having a tested Italian queen, the other a hybrid. By way of caution, I caged the tested queen on a comb for a day or so, having killed the hybrid. I released the queen about dark, giving the bees a good smoking, and thought all would be well; but on examination about a week later, no queen was present. I am quite sure of this, for I made two thorough examinations. Meanwhile, they were fed about 10 pounds of syrup from a Miller feeder. What was the probable cause of the queen being killed?

2. Why must stores, either fed or gathered, be sealed for winter?

3. My single-wall hives are arranged in a row in a shed facing the south, open two or three feet from the ground in nice weather, but closed during cold, stormy weather. I have packed several inches at the back, also between the hives with straw and chaff. Each hive has a T super filled with a sack containing chaff, closely packed. In lieu of a Hill device, the burlap covers are placed over the T tins instead of directly on the brood-frames. Is this the correct way, or should the burlaps be under the tin? Should the packing in the supers be scant enough to allow of an air space under the cover? My covers fit rather closely over the packing, but are provided with about an inch hole at each end for ventilation. I see bran mentioned for packing over the brood-chamber. What is your opinion of its merits, compared with wheat straw or chaff?

H. M. S.

Vine, O., Dec. 7.

ANSWERS.—1. Now look here. How do you know that queen was killed? You say you made two thorough examinations. That won't pass as conclusive testimony in this court. You were not convinced yourself by the first examination or else you wouldn't have made the second. And if you missed finding her on the first examination, how can you be sure the second was any better. Sometimes a queen has kept out of my sight for more than two examinations, and I'm no "slouch," either, at finding a queen. Wait till next spring before you feel sure about it.

Now if you're ready to admit that you don't know whether that queen's dead or alive, I'll admit that the chances are that you're not far out of the way in supposing her to be dead. As to the reason, it's reason enough that she was in a hive with a number of strange bees, in which there's always some chance of trouble, and in this case the chances went against her. Perhaps next time you try the same thing, all will be lovely.

If I understand the case rightly, you killed the one queen and caged the other at the time of uniting. Then a day or so later you released the caged queen. I don't know just what occurred, but I'll give a guess at what might have been. When the bees were united, some of the hybrid queen's subjects went nosing around and found a strange queen in a cage. An unfriendly feeling made them hang around the cage, and the loyal bees not being able to get to her paid not much attention to her. If they discussed the matter at all, they may have said that a queen that would fool away her time in a cage like that wasn't exactly what she ought to be. So when the cage was opened, the disaffected bees had their own way and dispatched her royal highness. If you had killed the hybrid queen a day or a week beforehand, and then united without caging, your chances might have been better, for the strange bees would by that time have discovered their queenlessness and been ready to tolerate anything in the shape of a queen.

2. If there were no other reason. I should prefer to have sealed stores for winter, because their being sealed is something of a guarantee that they are ripe enough to be proper stores. I admit that there may be such a thing as sealed honey, that isn't as ripe as the majority of unsealed honey,

and that there may be unsealed honey very thick and ripe, but as a rule sealed honey will be the better of the two.

But suppose we have two lots of honey exactly alike in every respect, only one is sealed and the other unsealed—I'd rather have the sealed. The vapor in the hive arising from the bees settles on the unsealed honey, thinning it so that by spring it will run out of the cells. The sealing keeps it closed against the entrance of the vapor, and it will remain thick until the bees uncap it.

3. I think you're all right with the burlap over the T tins, for if the burlap were next the frames there might be no chance for a passage over the frames. I suppose you saw that the burlap was close down upon the frames everywhere except where the T tins were. I don't believe an air space under the cover is of any special use. I don't know about bran, but I think I'd as soon risk chaff. Planer shavings, however, seem to be growing in favor. One good point about them is that they don't suit mice as well as either of the others.

Sweet and Alsike Clover Seed.

1. Where can I obtain sweet and Alsike clover seed for the least money near to me? What should it cost per bushel? Anyone having the above seed for sale, I would be glad to receive prices from.

J. N. S.

Cuba Landing, Tenn.

ANSWER.—I know nothing about the matter only from the advertisements. Watch for them toward spring. I think it is usually about \$6 a bushel.—[Those who have for sale the seed mentioned, should advertise it with prices in the advertising columns of this paper.—EDITORS.]

Housing Bees—Balling of the Queen.

1. Would it be best to house bees in this warm, damp climate, or put under a good shed out-doors? All buildings get very damp inside, unless they have fire in them. The temperature seldom gets down to zero.

2. What is meant by "balling a queen?" H. B. B.
Riverside, Wash.

ANSWERS.—1. I'm inclined to think the best thing is to have them out-doors, perhaps properly packed in such a shed as you speak of. But I'd try to find out just what has been the practice of others, and their respective success.

2. The first time you have a queen that you want to destroy, throw her among a lot of bees that have a good queen, and you'll find out what "balling a queen" means. First one bee will grab hold of the strange queen, then another, and another until there's no room for any more to get hold of her, and then other bees will take hold of the bees that are holding on to the queen, and this will be continued until they make a ball the size of a hickory nut or a walnut. The balling bees will make a sort of hissing sound, and as a rule will hold on to the queen until she is dead. This will take several hours.

Sometimes bees will ball their own queen and kill her, either because there's something wrong with her or because she has been handled and has thus acquired a strange scent. When bees ball their own queen, however, I think they do not generally mean any evil to her, but ball her for the sake of protecting her. Often when I've opened a hive and found them balling their queen, I've closed the hive at once and left them, and the next day I'd find the queen all right.

A New Binder for holding a year's numbers of the American Bee Journal, we propose to mail, postpaid, to every subscriber who sends us 15 cents in addition to paying for his or her subscription for 1896. It is called "The Wood Binder," is patented, and is an entirely new and very simple arrangement. Full printed directions accompany each Binder. Every reader should get it, and preserve the copies of the Bee Journal as fast as they are received. Why not begin with Jan. 1 to save them? They are invaluable for reference, and at the low price of the Binder you can afford to get it yearly.

If your subscription is already paid for 1896, send 15 cents for the Binder. If any one desires two of the Binders—one for 1895 and one for 1896—send 25 cents, and they will be mailed to you.

I am not sure but I should want a fire in a bee-cellar for the sake of ventilation, even if not needed for heat.—DR. MILLER.

THE OLDEST BEE PAPER
- IN AMERICA -

THE AMERICAN BEE JOURNAL

ESTABLISHED IN 1861

PUBLISHED WEEKLY BY

GEORGE W. YORK & COMPANY,

Editors and Proprietors,

56 Fifth Avenue, CHICAGO, ILL.

\$1.00 a Year—Sample Copy Sent Free.

[Entered at the Post-Office at Chicago as Second-Class Mail-Matter.]

Vol. XXXVI. CHICAGO, ILL., JAN. 2, 1896. No. 1.



A Happy New Year to you all!

The New Headings in this number of the Bee Journal we trust will please every reader. What could be more appropriate than to begin this brand new year with spick-and-span new "head-lights" on the "Old Reliable?"

The Bee-Keepers' Congress' proceedings we had hoped to begin in this number of the Bee Journal, but they did not reach us in time. We expect next week to have the pleasure of beginning the account of what we understand was a very profitable convention held at Atlanta, Ga., last month.

While the Past Year has not been one of great prosperity for bee-keepers, yet no sadness should thereby be permitted to take possession of our hearts on this the threshold of a New Year. At this season all should be happy, with courageous and better-matured plans for the future. Even if the past year has not brought to us the full fruition of our sincerest hopes, we must look forward with a stronger determination to overcome all obstacles, if possible, and press on as becomes men and women who toil not for Time only, but for an Eternity that shall be the more blessed because of the previously perfected characters we shall take there. Let us—

"On the future cast no longing,
Wait not for a brighter day;
We, the builders of the Present,
Make our Future what we may."

Bee Journal and the Supply Business.

There are a few people who seem to be worried somewhat about the American Bee Journal being connected with the bee-supply business, since the Root branch is now located so near its editorial sanctum. The following, which appeared in *Gleanings* for Dec. 15, puts the case fairly well:

Various comment has been offered in some of the bee-journals as to whether the American Bee Journal is harnessed to the supply business, or under the wing of *Gleanings*, now that its editor, Mr. York, has been engaged to manage the Chicago office of The A. I. Root Co. So far as the American Bee Journal is concerned, it is just as independent as before. It has no connection, pecuniarily or otherwise, with *Gleanings* or its publishers. As Mr. York was an old wheel-

horse in the supply business under Thomas G. Newman & Son, and as the successor of that firm had sold out its business to us, Mr. York, by virtue of his experience and general acquaintance with the territory, was engaged to manage the Chicago branch office; and wareroom rent, insurance, cartage, freight, and stationery, etc., are paid by us. But suppose the publisher of the American Bee Journal did open up a supply office, the same owned and controlled by himself—would that necessarily weaken the influence of his paper? If he were selfish, and inclined to "boom his supplies" irrespective of their merits, through his journal, he would hurt it; but he is not disposed to do anything of that kind.

No, sir; the American Bee Journal is just as independent as it was before the Root branch was opened up here, and we defy any one to point to a single instance wherein the Bee Journal is the worse for having another firm's supply business in the same building! But why didn't those same folks object when the former publishers of this journal were actually buying and selling supplies? Then they might have had a reasonable excuse, but now it is a waste of space to discuss the matter so far as the present American Bee Journal is concerned.

Again, we wish to say, that there isn't the slightest connection between Root's bee-supply branch here in Chicago and the American Bee Journal. They pay for their advertising space in this journal just as do others, and their goods will not be pushed in its columns any more than are others—except as more advertising space is paid for. And that is open to all honorable dealers.

You are Hard to Please, we shall think, if this number of the old American Bee Journal doesn't come pretty nearly to suiting you. But we hope it will serve only as an indication of what it will be this year. If everything goes well, the 36th volume will be the brightest and most valuable of all. We will do our "level best" to keep it up to the "pace" set by this particular number. You can all help us a good deal in succeeding, if you will do your part. A sympathetic audience always contributes greatly to the success of the orator who may be delivering the address. There are many who speak through the American Bee Journal. Let us all help each other.

Mr. Tucker's Apiary, as shown on the first page of this number, is thus described very briefly by himself:

WALLINGFORD, Conn., Dec. 2, 1895.

MR. EDITOR:—"I don't know" that I can say much about my apiary, as the picture shows well for itself. However, I will say that it all faces the south, and in the winter I board up the north side and the ends, and line the outside with single-ply tar felt. The two long boards seen in front are double, hung by hinges so I can let the outside one down in case of a driving storm, rain or snow. In the winter I wrap the hives in old carpets, old sacking, or anything that will do to keep them warm. I raise the rear end of each hive three inches. At this time I have 28 colonies, mostly in dovetailed hives.

The shop (a portion of which shows) is 12x20 feet, with shed roof.

I take lots of comfort around this little spot. I work in a factory where silver-plated ware is made, and keep bees for pleasure, as it is not much of a honey-district right around here.

J. B. TUCKER.

A Number of Complaints have been received at this office recently, against C. R. Horrie & Co., a commission firm at 224 South Water St., Chicago. Also, we are getting enquiries as to their reliability, honesty, etc. In view of the foregoing, we deem it but just to all concerned, that we make a few plain statements.

As nearly all the Bee Journal subscribers know, several months ago there appeared in this paper a small advertisement of the above firm, soliciting shipments of honey. Before accepting that advertisement we investigated them as thoroughly as we then thought was necessary, and apparently all

was well. At the end of the first order of three months' advertising, there still appearing no good reason for doing otherwise, the contract was renewed. But before the second three months expired, we discovered that the firm was not giving the satisfaction to bee-keepers when handling their honey we thought they should, so we dropped the advertisement, and informed them that we could carry it no longer. They paid their advertising bills very promptly, and seemingly were pleased with the amount of business the advertisement had brought them.

But since discontinuing the advertisement numerous complaints against them have come in, one of which was published on page 817 of the Bee Journal for Dec. 19, 1895. Now as that is but a fair sample of the others, we felt that it would be better for us to make an editorial statement, rather than to take up valuable space in publishing them all.

We can only say further, from what we now know, we regret that we permitted the advertisement of Horrie & Co. to appear in the Bee Journal. We have learned a lesson which we hope never to repeat. Of course, we feel the worst when thinking of those hard-working bee-keepers who, after having been fortunate enough in a poor season to get any surplus crop at all, must be compelled to accept much less for their honey than they could have received at home, or at the hands of some other dealers through whom they had made satisfactory sales in previous seasons.

In conclusion, permit us to say that if you feel that you have been dealt with unfairly by any commission firm that has handled your honey, place your complaint before the National Bee-Keepers' Union—if you are a member of it (and you ought to be, if you are not). Mr. Thomas G. Newman, 147 South Western Ave., Chicago, Ill., is its General Manager, and he will look after your interests very carefully, if it is anything that comes within the province of the Union. And we do not know of any more valuable work it can do for bee-keepers, than to protect its members against those who attempt to take advantage of them. For what shall it profit a bee-keeper who, by careful toil, has gained a surplus honey crop, and then is defrauded out of a goodly portion of its value?

The Langstroth Memorial, in Gleanings for Dec. 15, 1895, helped to make a specially interesting number of that beautifully-illustrated apicultural semi-monthly. It spoke eloquently of Father Langstroth as a man, minister of the gospel, college professor, editor, bee-keeper, and inventor. The memorial contributions were written by such noted men as Thos. Wm. Cowan, editor of the British Bee Journal; C. J. H. Gravenhorst, editor of the Deutsche Illustrierte Bienenzeitung; Edward Bertrand, editor of the Revue Internationale; W. F. Clarke and Thomas G. Newman, former editors of the American Bee Journal; Rev. W. F. McCauley, a former pastor of Mr. Langstroth; Prof. A. J. Cook, Thaddeus Smith, and S. T. Pettit.

Next week we expect to republish some entertaining extracts from the memorial articles, which we are sure will be read with much interest by all. Bee-keepers are yet too near the lamented Langstroth's time to rightly estimate him and his work. Those who will have the privilege of looking backward from the next century will be better able to put the true value upon the great Langstroth and his efforts in behalf of bee-keeping and the world in general. His life will shine on with a more resplendent glory as the years come and go; for he "being dead yet speaketh," and unnumbered are they that shall yet "rise up and call him blessed."

Langstroth on the Honey-Bee.—This fine book is now reduced in price from \$1.40 to \$1.25, postpaid. It is the latest revision by the well-known Dadants. We can supply it at the price named, or we will mail it with the Bee Journal for one year—both together, for only \$2.00. Every bee-keeper should have Langstroth's peerless work. It is his own enduring monument, as well as the pride of American apiculture.

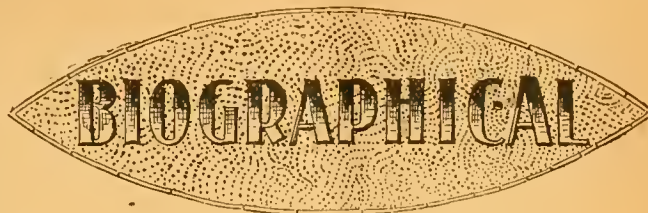

MR. F. L. THOMPSON.

It is always interesting to read about our friends—to see their faces, even if only on paper—and to know something about the particular incidents connected with the life of each. For that reason, Mr. Thompson was requested to permit his photograph to be used, though he would not send it until the second urgent invitation, when he replied that he would comply, but "under protest." (Of course the "protest" made no difference, so long as the picture was forthcoming.)

Mr. Thompson was born near Cincinnati, Ohio, on April 3, 1865. Lung trouble induced his father—a teacher by pro-



F. L. Thompson.

fession—to remove to Colorado in 1872, where he regained his health, but was told by the doctor not to enter the school-room again. Hence he settled in the country, near Denver, making and selling butter for a living. There were no fences in those days. The cattle had to come home to water, but this was not enough to prevent them from roaming for miles around in all directions. They had to be "round up" and counted every day, and the cows brought home for milking, morning and evening. Most of the riding fell to F. L.'s share. In this and in milking, drawing water, hunting stray cattle (sometimes for days at a time in all weather), and, in the summer, haying of the scanty wild grass three miles distant, from which he often secured no more than a load a day, the time passed in unbroken routine, sometimes varied by attending country schools, but chiefly, for him, in reading over and over their small collection of books.

After some years of such a life, his father, at considerable sacrifice to himself, managed to send the children to school in Denver. Then began a new world. At first, of course, a college education seemed like fairyland, too nice to be thought of as ever really happening. But after entering the Denver High School, taking the "general" course, it began to seem really too bad not to have some idea of what was going on in the cultured world, and so young Thompson began to study

by himself—first, Latin, then Greek, and finally “flopping” clear over to the classical course, after catching up with the others, though still without hope of doing more than finishing the high school. He has vivid recollections of carrying around his Greek books one vacation, no matter what he was doing, and snatching a moment here and there for study. From that time to this, the so-called “dead” languages (with others) have been a perpetual joy, inspiration, and comfort to him. Imagine his rapture, when, after graduation, wealthy friends offered the loan of funds for a college education.

At college (Yale) his forte continued to be languages. In his junior year, he won the first Winthrop prize of \$200, given to that member of the class who displayed the best acquaintance with the Greek and Latin poets in a competitive examination.

Mr. Thompson graduated in 1888. His habit of mind is such as to regard every year as lost in which one does not make sensible progress in mental *altitude* (not mere knowledge) as a result of one's own efforts, as distinguished from the chance influence which circumstances may or may not have, which, if they do, is quite as apt to be stupefying as otherwise; in other words, to keep up life-work as well as livelihood-work, giving the preference to the former when possible.

Hence, after over a year of teaching in a private school in Philadelphia, finding that occupation, as at present pursued, too mechanical and exclusive for his bent, he cast about for something in which one could grow. In spite of his early experiences, it seemed to him that a country occupation, if kept within due bounds, was most favorable to mental freedom. He got an armful of books on rural specialties, at one of those second-hand book-stores in Philadelphia—among them the works of Quinby and Langstroth—and was not long in deciding that bee-keeping was the most rational of them all.

He did not get into it immediately, however, as he should have done, but wasted some time in general farming, losing, of course, by the operation. His first purchase of 20 colonies, in 1892, developed foul brood in nearly all, the first thing, and he gained experience rapidly. Since then he has been enabled to devote his whole time to bee-keeping by running bees on shares, and believes it to be an ideal occupation, and a foretaste, in the nineteenth century, of what the coming man will enjoy in any occupation in the twenty-fifth or thirtieth—the golden mean of occupation and leisure, exercise and study, fruition and anticipation, and especially because it provides regular breathing-places (winters) in which to promote culture; for, as a recent critic has said, “Civilization means precisely the possibility of individual rights and individual culture. The history of culture is the vastly significant thing at the heart of all history.”

In conclusion, I may say that Mr. Thompson is no stranger to the readers of bee-literature. He has written quite a good many interesting articles for the American Bee Journal, and is at present the translator of foreign apicultural periodicals for the Bee-Keepers' Review. On page 1 of this number of the Bee Journal is published a recent production of his pen. No doubt in the future we shall all hear more frequently from him, as his apiarian experience shall increase, and the bee-business grows upon him.

THE EDITOR.

Earn Your Own Subscription.—Any present subscriber can earn his or her own subscription to the American Bee Journal for one year by sending *three new subscribers*, with \$3.00. A copy of “Bees and Honey” will also be mailed to each new subscriber, and the Bee Journal will be sent to the new readers from the time the order is received up to the end of 1896. This is an easy way to earn your own subscription and at the same time help to circulate the Bee Journal. Remember, getting 3 new subscribers pays for your own subscription for 1 year! Of course, no other premium will be sent in addition. This is a straight offer by itself.

The Alsike Clover Leaflet consists of 2 pages, with illustrations, showing the value of Alsike clover, and telling how to grow it. This Leaflet is just the thing to hand to every farmer in your neighborhood. Send to the Bee Journal office for a quantity of them, and see that they are distributed where they will do the most good. Prices, postpaid, are as follows: 50 for 25 cents; 100 for 40 cents; or 200 for 70 cents.

☞ It is true that hives gather no honey, but in so far as they effect the objects which have engaged our attention, they are the cause of much being gathered.—PROF. CHESHIRE.

CONVENTION PROCEEDINGS

The Report of the Illinois State Convention.

The annual convention was held at the State House in Springfield, Nov. 19 and 20, 1895.

The President being absent in the morning, the meeting was called to order by Vice-President S. N. Black, after which Rev. A. P. Cobb, of the Christian church, offered the following prayer:

Almighty God, our Heavenly Father: We give Thee thanks that Thy providence has been over our beloved land, and upon this Association, during the year that is now closing. We thank Thee that while there have been floods, and storms, and drouths, which have brought suffering and loss, there has been no calamity so general or extreme, as to make us lose our faith in Thy goodness, or cause us to feel that Thou hast forgotten us. Our blessings still infinitely outnumber our calamities; and Thou dost still love us and care for us.

We thank Thee that Thou hast so created and endowed us that we can take delight in studying the works of Thy hand. Thou has not only made all things beautiful in their season, clothing the flower of the field with grace and fragrance, but Thou hast given to each object of Thy creative power, an adaptation to the purpose for which Thou didst intend it. We thank Thee that in Thy sight there are no gradations into greater and less, but that with Thee greatness lies in each of Thy creatures faithfully fulfilling its mission in creation. We are glad that in this world which Thou hast fashioned, there is a place for the wren, the violet, and the bee, as certainly as for the eagle and the rose, and we believe that the bee, winging its humble flight from flower to flower, as certainly fulfils its divine mission as does the eagle soaring aloft in mid-sky.

We rejoice that Thou hast filled human hearts with a desire to study Thy handiwork as exhibited in the bee rifting the flower of its sweets, and, by Thine own alchemy, transmuting its hidden treasures into nectar and ambrosia. We recall with gratitude that the blind Huber, and many of the purest and best men and women, have found delight in the study of this marvelous insect—the type of industry, of sagacity, and of patient adaptation of means to ends in overcoming obstacles. As the wise man of old pointed to the ant as a warning against sloth, so these have seen, in the bee, instructions for the wisest. We are glad that their labors have made existence more pleasurable to the bee; while its benefactors have reaped a rich reward for the labor of brain and hand, not only in material compensation, but in the inspiring thought that this humble creature is the friend of man, and co-worker with him in the laboratory of Nature, wherein earth and sea and sky are made to minister to many-sided life.

May each member of this Association be imbued with a sense of the dignity and utility of his work, as he patiently studies this portion of Thy providence, and thinks Thy thoughts after Thee; for Thy thoughts are as surely revealed in and by this tiny insect, as in and by the countless stars that roll in their splendid beauty, through the silent cycles of the Universe.

Let thy blessing rest upon all the deliberations of this Association, and upon all their coming year's work. Guide us all through life with Thine infinite wisdom. Give us an increasing understanding of the works of Thy hand, as well as of Thy grace. And when our mission on earth is ended, take us to Thyself in Heaven, where we may still learn of Thee, until we come to know as we are known; we humbly ask, though Jesus Christ our Lord. Amen.

A welcome address was then given by Col. Chas. F. Mills, of Springfield, as follows:

Mr. President, and Members of the Illinois State Bee-Keepers' Association:

It is a great pleasure to meet the bee-keepers of the State again, and I trust that your annual meeting may result in great good to the important interests you so ably represent. It has been my good fortune to meet with you in several of

your annual gatherings, and the interest manifested in the essays read, and the discussions following, have confirmed my belief in the great benefits to the apiarists of the State from hearing and reading the proceedings of your meetings.

Your committee has assigned me the very pleasant duty of welcoming you to the beautiful capital of your State. You are not only welcome to the hospitality of the city, but to our homes and hearts. The good work your Association has done, and is doing, entitles you to a very cordial and hearty reception, which you will receive at the hands of all who are made acquainted with the object of your visit to Springfield.

The good work you have assumed to perform for the bee-keepers of Illinois, has been performed to the entire satisfaction of all who are familiar with the very creditable reports published by your organization.

Having had exceptional advantages for a thorough examination of the work of the Illinois State Bee-Keepers' Association, I do not hesitate to most heartily commend the efforts of your Secretary, Mr. Stone, and other officers who have so ably and heartily co-operated with the leading spirits in the advancement of the best interests of this industry.

With assurances of the high personal esteem with which you are held by our citizens, I again assure you of a most cordial welcome to the State capital.

CHAS. F. MILLS.

After the address, a vote of thanks was extended to Col. Mills, and both he and Rev. Cobb were made honorary members of the Association for the year 1896.

The minutes of the last meeting were read and approved, when a recess was taken for the reception of members.

The Secretary's report was read and approved, as follows:

The summary of matters pertaining to our Association for the year past, can be given in a very brief space of time. Matters in this line are about like the honey crop for this year.

When we first sent out our cards for reports from the members, in May, some answered that the prospect for a honey-flow was promising; but as the season advanced the reports became more and more discouraging. When they were sent out in September so few answered (and they very discouragingly) that we did not think best to send again in October.

As to the membership in the Association: We think it is on account of the poor season that we have had fewer fees sent in than in other years. Why would it not be well to reduce the annual membership fee to 50 cents, instead of \$1.00? or why not make arrangements with the bee-papers on some basis (to be arranged with them) by which a certain sum will entitle a member to both membership and a bee-paper for one year? I would suggest that something be done along this line, if possible.

The expense of running the Association is not heavy, and if it were, we think more money could be raised on a small fee than on a large one. The principal thing is members, not money.

In the report last year I stated that we had a good many of our Annual Reports, both 1st and 2nd, on hand, with no postage to send them out. And as our last Legislature failed to make an appropriation for us, we still have no postage to send them. Some of the legislators asked for them for their constituents, but many are still on hand. What shall be done with them? I am of the opinion that our 2nd Annual Report, containing the proceedings of the North American Bee-Keepers' Convention for 1893, at Chicago, and many things relating to the honey exhibit at the World's Fair, will be a desirable thing to have among bee-keepers, in years to come.

As all were aware, we were troubled to get a date for our Chicago meeting—after the collapse of the Coliseum—no Fat Stock Show to secure us railroad rates. But, finally, as you know, we fixed upon the time of the National Cycle Exhibition, Jan. 9 and 10, 1896.

The time of this (Springfield) meeting was fixed by the Executive Committee, soon after our meeting last year. And when at a later date the different associations of stock breeders organized, and fixed their date, we were present and used our influence to get them to meet at this date. But they set their time of meeting for January. (They have now secured an open rate of 1½ fare for the round trip.) We feel disposed to present this matter to the Executive Committee, and advise that this Association enter—and become one—with the other farmers' organizations in forming what will be known as the Illinois Stock Breeders' Association. We will thus, without doubt, secure good railroad rates, and perhaps one fare for the round trip, and be identified with them in whatever good we may strive to obtain; a part of which will be reports of our meetings, programs, etc., printed along with the same of the

other associations, comprising the Illinois Stock Breeders' Association, at a very small cost.

I might name the work that has been done by the committee on State Experimental Station, State Fair, etc., but will leave that for the committee to report upon.

The amount of fees received during the year, by the Secretary, is just 75 cents more than that paid out per Secretary's account.

JAS. A. STONE.

Dr. Miller moved that the recommendations in the Secretary's report be taken up seriatim, and acted upon. Carried.

The first was the sending out of the return postal cards, for members to report condition of honey crop, bees, etc. On this question there was considerable discussion, when it was finally voted that they be sent out on June 1, July 15, and Sept. 15.

Treasurer Dr. Miller reported the amount received from the former Treasurer as \$3.52, which still remained on hand. The report was accepted.

The convention then adjourned to 1:30 p.m., when the meeting was called to order by Pres. J. Q. Smith. A piano was rolled into the room, and all listened to several songs by Dr. Miller, some of them being joined in by Mr. York. The Odd Fellows, who were in session in the State House, crowded into the doors after filling all the chairs in the room, and then as Dr. Miller sang, "Lead Me to the Rock that is Higher than I," we saw the tear-drops starting from eyes that were looking in through one of the doors—showing how much the singer was moving his hearers, and thus proving the merits of the feast we had.

The next recommendation in the Secretary's report was taken up, on the reduction of the membership fees.

Dr. Miller offered figures showing what was possible to be done by adding the probable membership at 50 cents each to an appropriation from the State, and then expend it in the purchase of subscriptions to bee-papers.

The afternoon session was consumed in each one present suggesting what might be done, and finally the Secretary was instructed to draw up a resolution to embody the sense of the members, to be reported the next morning.

A letter from the President of the Board of Directors of the Illinois University to the Committee on Experimental Station was read as follows:

URBANA, Ill., Jun. 18, 1895.

Jas. A. Stone, Geo. F. Robbins, W. J. Finch, Jr., Committee Illinois State Bee-Keepers' Association, Bradfordton, Ill.

Gentlemen:—Your communication of March 15, 1895, on the part of your Association, was duly considered at the recent meeting of the Board of Directors of the Agricultural Experiment Station here. It was, however, decided that it was not feasible at the present time to take up the matters referred to in your communication for investigation or experiment. This does by no means indicate any want of appreciation of the importance of such work, but it is absolutely impossible for the Station to do all that would be desirable to have done, or to fill at the same time all the requirements of practical matters in the various lines of affairs coming under the general title of Agriculture. One factor in the decision is that the locality here is deemed a poor one for this work; while under the present circumstances it is not deemed feasible to establish such experiments elsewhere.

The adverse decision concerning taking up in a prominent way special questions in agriculture, does not include giving such attention to the matter as will be possible in connection with the other work that is being carried on here. We shall be glad to be of any service, whenever it is possible, and sometimes more attention may be given to your practical lines of investigation.

I am, however, glad to inform you that instruction in Apiculture is offered in the University, to be taught by Mr. W. G. Johnson, who is a scientific entomologist, as well as a practical bee-keeper.

Very truly yours,
T. J. BURRILL,
President Board of Directors.

The convention then adjourned to meet at 9:30 a.m., the next day.

[Concluded next week.]

The McEvoy Foul Brood Treatment is given in Dr. Howard's pamphlet on "Foul Brood; Its Natural History and Rational Treatment." It is the latest publication on the subject, and should be in the hands of every bee-keeper. Price, 25 cents; or clubbed with the Bee Journal for one year—both for \$1.10.

ATTENTION, BEE-KEEPERS!

We are Now Ready to Receive

Shipments of HONEY, both Comb & Extracted and BEESWAX

For the Season of 1895-96. We have made preparations to store Comb Honey in Any Quantity. This is our Fifth Year as a

HONEY COMMISSION HOUSE.

We received 812 Shipments last year. We kindly solicit the business of our friends of former years, and a Trial Shipment of all Bee-Keepers in the Country.

J. A. LAMON, 43 South Water Street, CHICAGO, ILL.

44A10t *Mention the American Bee Journal.*

YOUR BEESWAX!

UNTIL FURTHER NOTICE, we will allow 30 cents per pound for Good Yellow Beeswax, delivered at our office—in exchange for Subscription to the BEE JOURNAL, for Books, or anything that we offer for sale in the BEE JOURNAL. Or, 26 cts. cash.

GEORGE W. YORK & CO.,
CHICAGO, ILLS.



Promptness Is What Counts!

Honey-Jars, Shipping-Cases, and everything that bee-keepers use. Root's Goods at Root's Prices, and the best shipping point in the country. Dealer in Honey and Beeswax. Catalogue Free.

162 Mass. Ave. Walter S. Ponder
INDIANAPOLIS, IND.

Mention the American Bee Journal.

WANTED!

10,000 pounds of BEESWAX, for Cash. Address, LEAHY MFG. CO., Higginsville, Mo.
Mention the American Bee Journal.



ONE MAN WITH THE UNION COMBINATION SAW

Can do the work of four men using hand tools, in Ripping, Cutting-off, Mitring, Rabbling, Grooving, Gaining, Dadoing, Edging-up, Jointing Stuff, etc. Full Line of Foot and Hand Power Machinery. Sold on Trial. Catalogue Free.

SENECA FALLS MFG. CO.,
46 Water St., SENECA FALLS, N. Y.
1Aly *Mention the American Bee Journal.*

33 cts. a Pound

We allow

For Beeswax

In Exchange for

—SUPPLIES.—

1896 Circular Now Ready.

I. J. STRINGHAM,

105 Park Place. NEW YORK, N. Y.

A Binder for holding a year's numbers of the BEE JOURNAL we mail for only 75 cents; or clubbed with the JOURNAL for \$1.60.

General Items.

Bees Wintering Nicely.

I am a young man and have 80 colonies of bees, some Italians and some blacks. They are wintering nicely. I have Simplicity and Quinby hives. L. E. RHOADES.
Weedspport, N. Y., Dec. 3, 1895.

Averaged Over 50 Pounds.

I do not see how I could keep bees and get along without the American Bee Journal. My bees did well this year, averaging over 50 pounds per colony.

M. M. RICKARD.
Buffalo, N. Y., Dec. 7, 1895.

No Honey and No Swarms.

From 51 colonies in the spring of 1895 I have only 23 now; not a pound of honey nor a single swarm, owing to the drouth.

Miss M. J. STALKER.
Randolph, Wis., Dec. 12, 1895.

Will Try One More Year.

My bees have run me in debt again this year, but not quite as badly as last year. I want to try one year more.

I put 50 colonies into winter quarters. I am trying to take care of them. I like to work with them. The drouth is not broken yet. When I get a crop of honey I will report again. A. F. CROSBY.
Sheffield, Iowa, Dec. 9, 1895.

Bees in Good Condition.

I had about 3,000 pounds of extracted honey this year, which sold in the home market for 8 cents a pound. I had 120 colonies, spring count, and now have 101 in chaff hives and 39 in the cellar, all in good condition for winter.

I could not do without the American Bee Journal if it cost four times as much as it does now. F. B. FARRINGTON.
Strawberry Point, Iowa, Dec. 5, 1895.

Didn't Get Much Honey.

The bees are all packed and in their winter hives in good condition. I had to feed about half of mine, 65 colonies in all. I did not get much honey this year, but still I am hoping for a better season in the future. The honey is very dark, but thick and good. The bees were carrying in pollen last week. We have had no cold weather so far. Mrs. A. A. SIMPSON.
Swarts, Pa., Nov. 27, 1895.

Good Report from Minnesota.

I started in the spring of 1895 with 39 colonies of bees, and this fall I had 150 colonies of bees, 3,000 pounds of comb honey, and 3,000 pounds of extracted. My location is in the timber, mostly hardwood. I am just starting in the business, and know but little about it. I let my bees swarm as they please. I use the Langstroth 8-frame hive. J. Z. RHODES.
Verndale, Minn., Dec. 10, 1895.

The "Dry Weather Vine."

The honey crop for southern Indiana is conceded to be only one-half. I averaged only 75 pounds (mostly extracted honey) per colony, spring count, from 40 colonies, making my crop about a ton and a half. Had it not been for the "dry weather vine" our season would have been an entire failure. When the flow set in from it, about the latter part of July, Mr. Cosby and my-

THIRTY THOUSAND POUNDS BEESWAX

Is our present stock for this year's sales of Foundation. But still **We Want More Beeswax** and pay a good price.

Don't Delay Ordering Your FOUNDATION. You will pay more by and by than you would now. Remember that we make the BEST, and everybody acknowledges this.

Now is the time to read the work of the **Late Father Langstroth—**

Langstroth on the Honey-Bee, Revised.

The Price of this Work is now Reduced from \$1.40 to \$1.25, by mail.

Send us your address for Catalogue of Bee-Supplies, etc.

CHAS. DADANT & SON,

Mention the American Bee Journal. HAMILTON, Hancock Co., ILL.

MAKE A NOTE OF THIS!

ALL READY FOR 1896.



Appreciating the advantages for procuring Basswood Lumber, and the splendid Shipping facilities of Marshfield, we have established a Factory for the manufacture of

—THE ONE-PIECE SECTION.—

We have all new and up-to-date Machinery for the manufacture of the "One-Piece Section." Have a Saw-Mill in connection with our Factory, enabling us to get the finest material to be had, for "One-Piece Sections."

Write for Price-List, and also for prices on Sections in any quantity you may want.

THE MARSHFIELD MFG. CO.,

Dec. 18 1895.

MARSHFIELD, Wood Co., WIS.

49Dtf

Mention the American Bee Journal.

California

If you care to know of its Fruits, Flowers Climate or Resources, send for a Sample Copy of California's Favorite Paper—

The Pacific Rural Press

The leading Horticultural and Agricultural paper of the Pacific Coast. Published weekly, handsomely illustrated, \$2.40 per annum. Sample Copy Free.

PACIFIC RURAL PRESS,
220 Market St., - SAN FRANCISCO, CAL.



SUCCESSFUL INCUBATOR
Our magnificent new catalogue giving full information regarding artificial hatching & Brooding and treatise on poultry raising sent for 4c stamps. Circular free.

Write now.
Des Moines Incubator Co.
Box 73 Des Moines, Ia

49A13t Attention the American Bee Journal.

REDUCED RATES !

Bingham Bee-Smokers & Honey-Knife. Best on Earth. 16 years with but one complaining letter. 5 Sizes—60c, 70c, \$1.00, \$1.10, \$1.50, postpaid. Send for Illustrations.

1 Dtf **T. F. Bingham, Farwell, Mich.**
Mention the American Bee Journal

Golden's Feeder !

BEE-KEEPERS:—We can furnish the **Golden Combined Feeder and Hive-Cover**, without Feed Dish [as the Simplicity or any dish answers], direct from factory at the following prices: 1 made up, 30 cents; 1 in the flat, 25 cents; 10 in the flat, \$2.00. All orders sent to The A. I. Root Co., Medina, Ohio.

For large orders, write the undersigned for special prices.
J. A. GOLDEN,
45A13t REINERSVILLE, OHIO.

Mention the American Bee Journal.

TRY us, we sell your Country, ready Fruits and all produce at high est prices. DAILY RETURNS. For stencils, prices and references, write **F. L. SAGE & SONS, 183 Reads St., N. Y.**

WHEN ANSWERING THIS ADVERTISEMENT, MENTION THIS JOURNAL.

PATENT WIRED COMB FOUNDATION

Has No Sag in Brood-Frames

Thin Flat-Bottom Foundation

Has No Fishbone in the Surplis Honey.

Being the cleanest is usually worked the quickest of any Foundation made

J. VAN DEUSEN & SONS,
Sole Manufacturers,
Sprout Brook Montgomery Co., N. Y.

Mention the American Bee Journal.

COMB FOUNDATION.

Wholesale and Retail.

Quality always the best. Price always lowest. **Working Wax into Foundation** by the lb. a Specialty. I can make it an object for you in any quantity, but offer special inducements on straight 25 or 50 lb. lots. Or for making large lot of Wax into Foundation. I am furnishing large Dealers, and can also please you. **Beeswax taken at all times.** Write for Samples and Prices, to

GUS DITMER, AUGUSTA, WIS.
Reference—Augusta Bank. 16A1f

NEW MAMMOTH

Poultry Guide for 1896 Finest book ever published, contains nearly 160 pages, all printed in colors, plans for best poultry houses, sure remedies and recipes for all diseases, and how to make poultry and gardening pay. Sent post paid for 15c.

John Bauscher, Jr., box 94P reeport, Ill

49A13t Mention the American Bee Journal.

self had all our hives running over with young workers to gather the prospective erop. But one rain after another set in, seemingly washing the precious nectar out of the many blossoms, and the result was only about six days' good, steady flow. If we had had a severe drouth, we would have been strictly "in it," so to speak. It does seem strange that when all other plants perish for want of rain, the "dry weather vine" flourishes at its best, and yields a fine flow of nectar in wonderful abundance.

Bees are in fine condition for winter, with abundant stores. **J. C. WALLENMEYER.**
Evansville, Ind., Dec. 4, 1895.

Gathering Honey and Pollen.

Bees are now bringing in both honey and pollen here. **J. P. LEEBRICK.**
Mesa, Ariz., Dec. 12, 1895.

Bees Did Fairly Well.

We have now 30 colonies, that did fairly well last summer. We took all the way from 20 to 100 pounds per colony, gathered from basswood and fall flowers. White clover yielded but very little honey in this locality. We hope it will yield more next season. **MRS. J. KNUPPEL.**
South Brooklyn, N. Y., Dec. 15, 1895.

Bees in Fair Condition.

My 21 colonies are now in fair condition, except two or three that are short of stores. 1 have them fitted up with outside boxes 4 inches larger than the hive on the sides and rear end. The front end has but one 10-inch board at the top part, leaving the entrance and most of the front end of hive-body uncovered. **Geo. McCULLOUGH.**
Braddyville, Iowa, Dec. 10, 1895.

A Very Poor Season.

We have had a very poor honey season in this part of Canada this year. To begin the season, the bees were in a bad condition. The bee-keepers in this section lost heavily last spring, some losing all. I lost half of mine. I have 62 colonies in winter quarters now, in pretty good condition. I got no honey the past season, and had to feed quite a good deal of sugar for winter. **WM. COLEMAN.**

Birr, Ont., Dec. 18, 1895.

Best Two Seasons—1894 and 1895.

We have had two of the best seasons—1894 and 1895—for bees I ever saw. Dr. Miller says he has had two complete failures. Get some black bees, Doctor. My best colony, in 1895, stored 85 pounds of comb honey, and three others filled 72 sections each. I had 23 colonies last spring, and averaged 50 pounds of comb honey per colony. I put 44 colonies into the cellar this fall. **S. M. ROBERTSON.**
Grey Eagle, Minn., Dec. 18.

Had a Good Year.

The year 1895 has been a good one for me. I started in the spring with 9 colonies, increased to 10, and got 500 pounds of comb honey in one-pound sections. It was mostly buckwheat honey, very dark, and sells here for 10 cents a pound. I use the Simplicity hive and winter my bees out-doors. They were in very good condition for winter. The S-frame hive is the best for my location. **WILLARD G. JEFFERS.**
Rose, N. Y., Dec. 13, 1895.

Likes to Work with Bees.

My honey crop was small this year on account of the dry season. I got 40 pounds of comb honey from two colonies. My bees have plenty for winter stores. I have kept

DO YOU WASH DISHES ?

No need of it. The Faultless Quaker will do it for you and save time, hands, dishes, money, and patience in scalded hands, broken or chipped dishes, no muss. Washes, rinses, dries and polishes quickly. Made of best material, lasts a lifetime. Sell at sight. Agents, women or men of honor desiring employment may have paying business by writing now terms to agents.



for descriptive circulars and terms to agents,
The QUAKER NOVELTY CO., Salem, O.

Mention the American Bee Journal. 39A26t

WANTED.

10,000 pounds of BEESWAX, for Cash. Address,
LEAHY MFG. CO., Higginsville, Mo.

Barnes' Foot-Power Machinery.

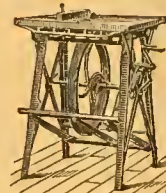

Read what **J. I. PARENT**, of CHARLTON, N. Y., says:—"We cut with one of your Combined Machines, last winter 50 chaff hives with 7-in. cap, 100 honey-racks, 500 broad frames, 2,000 honey-boxes and a great deal of other work. This winter we have double the amount of beehives, etc., to make and we expect to do it with this Saw. It will do all you say it will. Catalogue and Price-List

Free. Address, **W. F. & JOHN BARNES,**
45C1f No. 995 Rnby St., Rockford, Ill.

DO NOT ORDER UNTIL YOU HAVE WRITTEN US FOR PRICES ON

The "Boss" One-Piece Section



Also D. T. Hives, Shipping-Crates and Other Supplies.

We have completed a large addition to our Factory, which doubles our floor room; we are therefore in better shape than ever to fill orders on short notice. Send for Price-List

J. FORNCROOK,

WATERTOWN, Jeff. Co., Wis., Jan. 1st, 1894.

IT'S RELIABLE

The Best and Cheapest Mill on Earth. Fully warranted. Will not choke. Write at once for prices and Agency. Prices lowest. Quality best.

It grinds more grain to any degree of fineness than any other mill. Corn, earrshelled, Oats, Wheat, &c., fine enough for any purpose. Made only by **JOLIET STROWBRIDGE CO. JOLIET, ILL.,** Jobbers and Manufacturers of Farm Machinery, Carriages, Wagon, Wind-mills, Bicycles, Harness, &c.



Mention the American Bee Journal. 34A26

The RURAL CALIFORNIAN

Tells all about Bees in California. The Yields and Price of Honey; the Pasture and Nectar-Producing Plants; the Bee-Ranches and how they are conducted. In fact the entire field is fully covered by and expert bee-man. Besides this, the paper also tells you all about California Agriculture and Horticulture. \$1.50 per Year; Six Months, 75 cents. Sample Free.

THE RURAL CALIFORNIAN,
218 N. Main St., LOS ANGELES, CALIF.

bees for four years, and like to work with them. It seems strange to read of such big yields from the South when if we bee-keepers here get 50 pounds per colony, we think we are doing well. Will Alsike and crimson clover grow successfully as far north as Wood county, Ohio? Will some one please answer through the Bee Journal?

WILLIAM DANIELS.

Perrysburg, Ohio, Nov. 29, 1895.

[Yes, we believe Alsike clover will grow all right in any place where red clover will prosper. Will someone please reply as to crimson clover?—EDITOR.]

CARLOADS



Of Bee-Hives, Sections, Shipping-Cases, Comb Foundation, and **Everything** used in the Bee-Industry.

I want the name and address of every Bee-Keeper in America. No reason why you cannot do business with me. I have

Cheap Lumber and Experienced Workmen; a good Water-Power Factory and know how to run it. I am supplying Dealers as well as consumers. Why not you? Send for Catalogues, Quotations, etc. **W. H. PUTNAM,** 1D RIVER FALLS, Pierce Co., Wis.

Mention the American Bee Journal.

Potatoes

—10 New Varieties, \$1. Packet BEET, CABBAGE, CUCUMBER LETTUCE, TOMATO SEEDS, 10c Catalogue Free. Address,

J. F. MICHAEL,

GREENVILLE, OHIO.

Mention the American Bee Journal.

IF YOU WANT THE

BEE-BOOK

That covers the whole Apicultural Field more completely than any other published, send \$1.25 to Prof. A. J. Cook, Claremont, Calif., for his

Bee-Keeper's Guide.

Liberal Discounts to the Trade.

SELLING OUT.

To close out, I offer my Improved Queen-and-Drone Traps per 1/2 doz. in the flat, at \$1.75; per doz., \$2.75; per 25, \$5.00.

Individual Right to manufacture and use, 50 cents; Township Rights, \$1.00; County Rights, \$5.00.

HENRY ALLEY,

WENHAM, MASS.

1A1f

The Rural Kansan

Is an Agricultural Journal for the busy farmer. It embraces Bee-Keeping and every department of industry connected with the farm. 30 cts. a year, monthly. Sample Free. A Full Line of **Higginsville Bee-Supplies** on hand.

CATALOGUE FREE.

HENRY L. MILLER,

355 Shawnee Ave.,

TOPEKA, KAN.

1A13t

Mention the American Bee Journal.

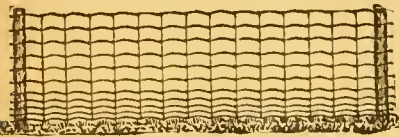

"Just as Good as Page" Won't Go!

"Sell you a ticket over the J. A. G. A. P. for less money," said the Scalper. "Not if I know myself," said the traveller. "The Road that uses **Page Fence** will also use best rails and best equipment. Can't put me on the bargain counter yet."

PAGE WOVEN WIRE FENCE CO., Adrian, Mich.

Dr. P. C. Gress, of Atchinson, Kans., would like to communicate, confidentially, with all persons who have consigned honey to C. R. Horrie & Co., of Chicago, Ill., with unsatisfactory results.

Honey & Beeswax Market Quotations.

CHICAGO, ILL., Dec. 10.—White clover and linden, in 1-pound sections, sells at 14@15c., but other kinds of white honey sell at 12@13c.; dark and amber grades, 9@10c., of which there is a very liberal supply. Extracted, white, 5 1/2@7c.; amber, 4 1/2@5c.; dark, 4@5c.. difference in price of each grade being in accord with its quality, fine flavor always being at a premium. Beeswax, 28@30c., and selling upon arrival. R. A. B. & Co.

CINCINNATI, OHIO, Dec. 20.—Demand for comb and extracted honey is fair only. We quote: Comb honey, 12@14c. for best white, in the jobbing way. Extracted, 4@7c. Beeswax is in good demand at 22@27c. for good to choice yellow. C. F. M. & S.

NEW YORK, N. Y., Dec. 18.—The market on comb and extracted honey is a little dull at the present time, and we do not expect to have a very great demand until after the holidays. Then we may look for a little better sale, but the bulk of trade is done for the season. That is for comb honey; extracted we expect quite a sale of after Feb. 1, 1896. We quote: Fancy clover, 1-lbs., 15@16c.; white clover, 13@14c.; fair white, 11@12c.; buckwheat, 9@9 1/2c. Extracted clover, 6@6 1/2c.; basswood, 6 1/2@7c.; buckwheat, 5c. Beeswax firm and in good demand at 29@32c. C. I. & B.

KANSAS CITY, Mo., Dec. 21.—The demand for comb and extracted honey is fair. We quote: No. 1 white, 1-lbs., 13@14c.; No. 2, 12@13c.; No. 1 amber, 12@13c.; No. 2, 8@10c. Extracted, white, 6@6 1/2c.; amber, 5@5 1/2c.; Southern, 4@4 1/2c. Beeswax, 22@25c. C. C. C. & Co.

PHILADELPHIA, Pa., Dec. 9.—Honey has steadily advanced in this market. Comb honey sells quickly and pure white clover extracted sells on sight. We quote: Fancy comb, 16c.; choice, 14@15c.; dark, 10@11c. Extracted, 5@6c.; Western white clover, 10c. Beeswax finds immediate sale on arrival at 30c. W. A. S.

NEW YORK, N. Y., Dec. 9.—We have a fairly good demand for white comb honey at 12@15c., according to quality and style of package. While the market is well cleaned up of glassed sections and paste-board cartons, unglazed is plentiful, having just received two more big cars from California. Buckwheat comb is very dull, with a plentiful supply. We quote 9@10c., but to effect sales on quantity lots, we find it necessary to shade quotations. Considering the limited outlet and large stocks on the market, we would not encourage shipping of buckwheat honey for the near future, as we could not render returns in reasonable time. The market on extracted is quiet at unchanged prices. No demand for buckwheat as yet. Beeswax is scarce and selling at 29@31c., according to quality. H. B. & S.

ALBANY, N. Y., Nov. 9.—Our honey market is in good shape, although prices, like on most all products, are not high; but receipts are lighter than last year, and there is a good, steady demand, with a real scarcity of white honey. We quote: White clover, 15@16c.; mixed clover, 12@14c.; dark clover, 9@11c. Extracted, white, 6 1/2@7c.; mixed, 5 1/2@6c.; dark, 5@5 1/2c. H. R. W.

List of Honey and Beeswax Dealers.

Most of whom Quote in this Journal.

Chicago, Ills.

J. A. LAMON, 43 South Water St.
R. A. BURNETT & Co., 163 South Water Street.

New York, N. Y.

F. I. SAGE & SON, 183 Reade Street.
HILDRETH BROS. & SEIGELKEN,
120 & 122 West Broadway.
CHAS. ISRAEL & BROS., 486 Canal St.

Kansas City, Mo.

C. C. CLEMOMS & Co., 423 Walnut St.

Buffalo, N. Y.

BATTERSON & Co., 167 & 169 Scott St.

Hamilton, Ills.

CHAS. DADANT & SON.

Philadelphia, Pa.

WM. A. SELSER, 10 Vine St.

Cincinnati, Ohio.

C. F. MUTH & SON, cor. Freeman & Central avs.

Fine Basswood, White Sage or Alfalfa EXTRACTED HONEY

—For Sale.—

We have made arrangements whereby we furnish **Basswood, White Sage or Alfalfa** Extracted Honey, in 60-pound tin cans, on board cars in Chicago, at these prices: 1 can,

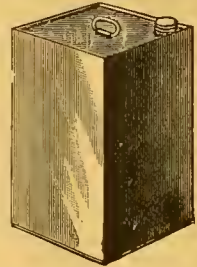

in a case, 8 1/2 cents per pound; 2 cans in one case, 8 cents; 4 cans (2 cases) or more, 7 1/2 cents. Cash must accompany each order.

A sample of either kind of honey will be mailed to an intending purchaser, for 10 cents, to cover postage, packing, etc. We guarantee purity, and that what we ship will be equal to sample.

Now it seems to us that here is a splendid chance for a bee-keeper to supply his home demand after his own crop is all sold. Or, why not begin now to create a local honey-trade? Order one 60-pound can first, and start out among your neighbors and friends, and see what you can do. You ought to get at least 15 cents per pound in 5-pound lots, or 50 cents for 3 pounds. Some may be able to do even better than that, though we think that enough ought to be sold at these prices to make a fairly paying business out of it. Give it a good trial. Push it. It may grow into a nice winter's work for you.

GEORGE W. YORK & CO.,

CHICAGO, ILLS.

1895 SAVE MONEY 1895

If you want first-class **ITALIAN QUEENS** FOR BUSINESS, **FOUNDATION** at Wholesale Prices, **HIVES**, suited for the South, or **SUPPLIES**, send for Price-List—to

J. P. H. BROWN, AUGUSTA, GA.

Mention the American Bee Journal.

Convention Notices.

WISCONSIN.—The annual meeting of the Wisconsin State Bee-Keepers' Association will be held Thursday and Friday, Feb. 6 and 7, 1895, in the capitol building at Madison. The program will appear in due time.

Platteville, Wis. N. E. FRANCE, Sec.

EAST TENNESSEE.—The Southern East Tennessee Bee-Keepers' Association will hold a social meeting at Cookson's Creek, on Saturday, Jan. 11, 1896, beginning at 9 a.m. An interesting time is expected. All are invited to attend, and especially those interested in apiculture. W. J. COPELAND, Sec. Petzerton, Tenn.

The Special Meeting of the Illinois State Bee-Keepers' Association will be held in Chicago, at the New Briggs House, northeast corner of Randolph St. and Fifth Ave., on Thursday and Friday, Jan. 9 and 10, 1896—the week of the National Cycle Show—when excursion rates will be given on the certificate plan—for 1 1/2 fare for the round trip. Certificate must be secured at the starting point, or no reduction will be granted on return. Before return ticket is secured, certificate must be signed by the Secretary of the Cycle Exhibition Company, and vised by the Joint agent of the railway lines, whose offices will be in the Exhibition Building. Tickets to Chicago may be purchased (and certificate taken), on any day between Jan. 1 and 11, and the return trip commenced on any day between Jan. 4 and 15. Chicago hotel rates are 75 cents each, per night, two in a room; \$1.00 if one in a room. Meals extra—pay for what you order, or go elsewhere for meals, if preferred. Bradfordton, Ill. JAS. A. STONE, Sec.

Question-Box.

In the multitude of counsellors there is safety.—Prov. 11-14.

How Often Should Frames be Manipulated?

Query 1.—Please tell about how often you "go into" or take frames out of each hive in the course of the year.—Ky.

G. M. Doolittle—About three to four times.

W. R. Graham—About six times; oftener in queen-rearing.

Prof. A. J. Cook—It depends. No short answer can be given.

E. France—It depends upon the season, and what you want to do with the bees.

P. H. Elwood—About once in ten days, during warm weather, until the close of the swarming season.

Dr. C. C. Miller—My, goodness! Not many times the past year. Sometimes twice, sometimes a dozen or twenty times.

W. G. Larrabee—All the way from two or three to fifty—just as many times as they need it, but not unless they do need it.

B. Taylor—I cannot answer. Some hives are not opened during the season; others are opened, and frames handled many times.

R. L. Taylor—Except in search of foul brood, I probably take frames out of about one in twenty of the hives during the season.

C. H. Dibbern—I never open a hive unless I have some purpose in view. Why "go into" a hive when there is no object in doing so?

Mrs. L. Harrison—When I was a novice I went into them quite often. Now I let 'em be. If I notice anything wrong, I "go in;" otherwise I stay out.

Rev. E. T. Abbott—Only when I think the welfare of the colony demands it, and that is not very often. The less they are "gone into," the better it will be.

Jas. A. Stone—It all depends upon how much work they are doing, or whether they are pure or not. If they need Italianizing, then a good many times.

J. E. Pond—I cannot tell how often. I don't open hives unless I see some need therefor. Such occasions may occur more or less often, depending upon circumstances.

J. A. Green—Not at all, unless there is some special reason for it. Some of my hives have not had the frames in the brood-chamber removed or handled in two years or more.

J. M. Hambaugh—This is hard to answer. Some colonies are not disturbed during the season, while others are handled quite frequently. I never disturb the combs without a cause.

Mrs. J. N. Heater—That depends upon the strength of the colony to be drawn from, and the number of frames I need. I have taken ten or more frames of brood from single colonies, in a season, taking from two to four at a time at intervals of two or three weeks, while other colonies could not spare any.

H. D. Cutting—When I began keeping bees I "went through them" almost every day. But of late years I seldom take out frames if the colony is all right, and you can tell by outside indications.

Dr. J. P. H. Brown—I might go into a hive several times a day—then not for a week. Some hives might not get opened over once or twice a year. Never take a frame from a hive unless they can spare it.

Eugene Secor—Never, unless there is some reason for so doing. If a colony has a laying queen, and is otherwise all right, I do not touch a frame. Its condition is easily ascertained without manipulating frames.

Allen Pringle—This "going into" the hives and handling the frames of brood-chambers has been growing smaller with me and "beautifully less" for many years. Of late, some of my brood-chambers are not opened at all from spring till fall; others are, as the circumstances may require.

Rev. M. Mahiu—I cannot answer that question. In some of my colonies I have not moved a brood-comb for years; in others I have had them all out several times during the past summer. I do not take combs out of hives unless there is some reason for doing so. I have learned to not open hives for fun.

G. W. Demaree—Well, let me see. I usually examine my colonies the first warm spring days to see how they are off for stores. Then in apple-bloom I lift out the frames till I find the queen and clip her wing, if not already clipped. I then let them alone till locust bloom (May 10 or 15). I now give them the section-cases, or extracting-supers, ready for all the honey that may be stored from white clover. When I need brood for any purpose, I take it from any strong colony that can spare it. Really, now-a-days I manipulate my bees as little as I can get along with. But not because I fear it will hurt them.

Queens and Queen-Rearing.—If you want to know how to have queens fertilized in upper stories while the old queen is still laying below; how you may safely introduce any queen, at any time of the year when bees can fly; all about the different races of bees; all about shipping queens, queen-cages, candy for queen-cages, etc.; all about forming nuclei, multiplying or uniting bees, or weak colonies, etc.; or, in fact, everything about the queen-business which you may want to know—send for Doolittle's "Scientific Queen-Rearing"—a book of over 170 pages, which is as interesting as a story. Here are some good offers of this book:

Bound in cloth, postpaid, \$1.00; or clubbed with the BEE JOURNAL for one year—both for only \$1.75; or given free as a premium for sending us three new subscribers to the BEE JOURNAL for a year at \$1.00 each.

A THOUGHT THAT KILLED A MAN!

He thought that he could trifle with disease. He was run down in health, felt tired and worn out, complained of dizziness, biliousness, backaches and headaches. His liver and kidneys were out of order. He thought to get well by dosing himself with cheap pills. And then came the ending. He fell a victim to Bright's disease! The money he ought to have invested in a safe, reliable remedy went for a tombstone. The thought that killed this man

HAS KILLED OTHERS.

Statistics show that 90 per cent. of the deaths from pneumonia, Bright's disease and similar complaints are caused from derangements of the liver and kidneys. These great organs keep the blood pure and in healthful motion. When they get out of order the blood becomes poisoned, the circulation impeded and the whole system speedily breaks down. It is

A DANGEROUS IDEA

to imagine that pills can strike at the root of these diseases. It has been thoroughly proved that such remedies are worse than useless. There is only one remedy which can always be depended upon. This remedy alone can act on the liver and kidneys when they are out of order, clear out the system and build up the health. The name of this remedy is Warner's Safe Cure. It is the only standard remedy in the world for kidney and liver complaints. It is the only remedy which physicians universally prescribe. It is the only remedy that is backed by the testimony of thousands whom it has relieved and cured.

There is nothing else that can take its place.

SECTIONS, BEE-HIVES, SHIPPING-CASES

We make a Specialty of these Goods, and defy Competition In

QUALITY, WORKMANSHIP AND PRICES.

Write for Free Illustrated Catalogue and Price-List.

G. B. LEWIS COMPANY, Watertown, Wis.

Be sure to mention the American Bee Journal when you write.

Getting Ready For 1896!

We are now prepared to furnish in any quantity, at the very lowest prices—EXTRACTORS, SMOKERS, and EVERYTHING used by the wide-awake bee-keeper. We shall continue to make our FALCON POLISHED SECTIONS, which are yet unequalled. If you've never used any of our Goods it is time for you to do so. They are acknowledged to be unsurpassed by any other make. Our large new Catalogue will be our early in the year. Anything you want now? Write to us. Goods and Prices guaranteed to be satisfactory.

Address,
THE W. T. FALCONER MFG. CO.,
JAMESTOWN, N. Y.

Honey for Sale 2500 lbs. A No. 1 Amber Fall Honey in 60-lb. Cans (2 cans in a case). Price, 1 can, 8c.; 2 or more, 7c., f. o. b. If sample is wanted send 2c. stamp. **E. T. FLANAGAN,** 50A1t Box 783, Belleville, Ills.

Mention the American Bee Journal.

Handy Cobbler \$2.00
Family Shoe Repair Kit. 28 Articles

With Soldering Materials.
Bought singly would cost \$4.70.
\$3 Outfit Includes
Harness Repair Tools
38 articles, worth singly \$6.70.
Sent by Express or Freight, Ills.
Catalogue free. Agents wanted.
KUHN & CO. Box 66 Moline, Ill.



41A26 Mention the American Bee Journal.

Will Exchange—Concord Grapevines for Fruit, Grain or offers.
50A **F. C. Morrow,** Wallaceburg, Ark.

TAKE NOTICE!

BEFORE placing your orders for SUPPLIES, write for prices on 1-Piece Basswood Sections, Bee-Hives, Shipping-Crates, Frames, Foundation, Smokers, etc.

PAGE & LYON MFG. CO.

NEW LONDON, WIS.

Mention the American Bee Journal.

OUR POULTRY ANNUAL
and Book of Valuable Recipes, 64 large pages, contains 8 beautiful colored plates of fowls, gives description and prices of 45 varieties, with important hints on care of poultry, and pages of recipes of great value to everyone. Finest Poultry Book published for 1896. Postpaid only 10 cts.
C. N. Sowers, Box 24, Dakota, Ill

52A1 Mention the American Bee Journal.

MUTH'S HONEY EXTRACTOR
PERFECTION
Cold-Blast Smokers,

Square Glass Honey Jars, Etc.

For Circulars, apply to **CHAS. F. MUTH & SON,**
Cor. Freeman & Central Aves., Cincinnati, O.
Send 10c for Practical Hints to Bee-Keepers

Success

Is one of the most pleasant experiences with which a man can meet. If this is what you would like to meet, but are a little doubtful as to which road to follow, take the advice of those who have met success and can tell you all about it. The correspondents of the BEE-KEEPERS' REVIEW are the most successful bee-keepers of this country—men who have produced honey by the ton—and in that journal they carefully map out the paths they have trod. If you would follow them to success, send \$1.00 for the REVIEW. If you wish to see the REVIEW before subscribing, send for a sample, or send a few stamps and a bundle of back numbers will be sent. [The more stamps the bigger the bundle.]

W. Z. HUTCHINSON,
FLINT, MICH.

Mention the American Bee Journal.

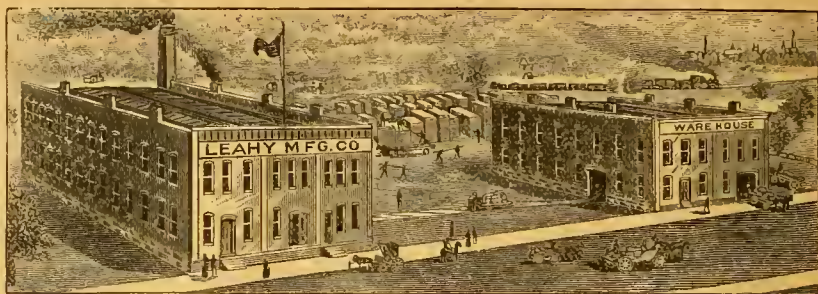

Largest Factory in the West **COMPLETE STOCK.** Good Supplies and Low Prices. Our Motto.

READ THIS—Mr. Keyes says: The 100 pounds of Extra-Thin Foundation you sent us is superior to anything he ever saw; and I think the same. **R. L. TUCKER,** Wewahitchka, Fla.

Dear Sirs:—The Sections came duly to hand. Indeed, they are very nice. Yes, sir; they are as good as the best. **CHARLES H. THIES,** Steeleville, Illinois.

Leamy Mfg. Co.:—I have received the bill of goods. I must say they are the choicest lot of Hive-Stuff I have ever received from any place. I admire the smoothness of your work, and your close selection of lumber. **Yours very truly,** **O. K. OLMSTEAD,** Orleans, Nebr.

Dear Sirs:—The Sections arrived in due time, and are all O. K. so far as examined. They are simply perfection. I can't see how you can furnish such goods at such low prices. I hope you may live long and do well. **Yours respectfully,** **Z. S. WEAVER,** Courtney, Tex.

Gents:—I received the "Higginsville Smoker" all O. K. It's a dandy; please find enclosed stamps for another. **Yours truly,** **OTTO ENDERS,** Oswegathe, N. Y.

Gentlemen:—I have bought Supplies from nearly all the large manufacturers by the carload, and I must say yours are as good as the best. Indeed, in many lines they are the best. It is a pleasure to handle them. **E. T. FLANAGAN,** Belleville, Illinois.

The above unsolicited testimonials are a fair sample of hundreds we receive. Our prices are reasonable and the "Higginsville Goods" are the best.

We are now manufacturing for each of the following parties a Carload of Supplies: **E. T. Flanagan,** Belleville, Illinois; **Charles H. Thies,** Steeleville, Illinois; **J. W. Rouse & Co.,** Mexico, Mo.; **Henry Miller,** Topeka, Kans.; **Fulton & Gregg,** Garden City, Kans.

If you need a Carload of Supplies, or only a Bee-Smoker, write to us. Remember, we are here to serve you, and will, if you give us a chance. **A Beautiful Catalogue Free.**

Address, **LEAHY MANUFACTURING CO.,** HIGGINSVILLE, MO.
49A Mention the American Bee Journal.

BIG OFFER

I Will Pay \$1.00 for the address of every person who has any **PURE WHITE CLOVER EXTRACTED HONEY** for sale—either for your own address, and any others you know of.

I Will Pay 31 cents for **Pure Yellow, Clean BEESWAX.** Cash on arrival.

WM. A. SELSER,

Please mention this Journal.

10 Vine St., PHILADELPHIA, PA.

THE NEW CORNEIL SMOKER!

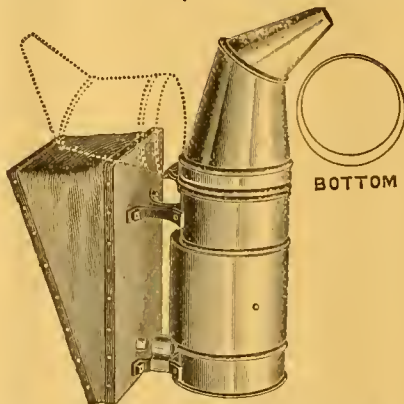

—JUST THE THING—

For those who want a First-Class Smoker at a medium price. Size of cup, 3½ inches; curved nozzle, hinged so as to swing back; legs of malleable iron, secured by bolts. The blast is the well-known Corneil principle. Weight of Smoker, only 20 ounces. Here is what one of our customers says of it:

The Corneil Smoker is a Dandy with a big D. I have been using it to-day on the crosscut colony of bees I ever saw. I think I could drive a bulldog with it.
Amityville, N. Y., Oct. 15.

S. R. AUSTIN,

Price—\$1.10, postpaid, or 85 cents if sent by express or freight with other goods.

THE A. I. ROOT CO., MEDINA, OHIO.

AMERICAN BEE JOURNAL

DEVOTED EXCLUSIVELY TO THE INTERESTS OF HONEY-PRODUCERS

ESTABLISHED 1861
THE OLDEST BEE-PAPER IN AMERICA

Published Weekly, at \$1.00 per annum.

Sample Copy sent on Application.

36th Year.

CHICAGO, ILL., JAN. 9, 1896.

No. 2.

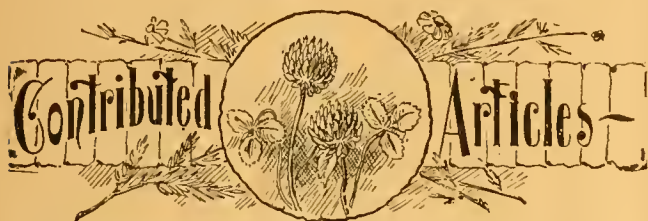

The Blooming of Sweet Clover.

BY M. M. BALDRIDGE.

On page 807 (1895) is a brief article on sweet clover, in which the writer says:

"Sweet clover comes into bloom at or near Lemont, Ill.,

the same latitude. Lemont being near Chicago, is practically in the same latitude as St. Charles. Now, sweet clover never blooms here until the latter part of June, and often not until the forepart of July. Nor does the plant, as a rule, remain continuously in bloom here until killed by frost. The state of the weather has much to do with its duration of blooming. In seasons of drouth it may not remain in bloom longer than six to eight weeks before it matures a crop of seed. This year (1895) the crop of seed was harvested here in August, at which time there was no bloom in sight. Now if before or about this stage of its growth we have a good supply of rain, the plant will send out a new growth of leaves and branches, and a second crop of blossoms, and the blooming may then continue till winter sets in. In fact, I have seen such things happen quite often. But, after all, the main crop of honey will be secured from the first crop of blossoms.

Again this writer says: "To secure a fall crop of honey from sweet clover, cut half of it down about the middle of



A Small Plat of White Melilot Clover in Full Bloom.—See page 24.

the forepart of June, and then remains in bloom until killed by frost."

I think the writer has made a mistake, or else he has a different and an earlier-blooming variety of sweet clover than grows here where I live, or that I have ever seen elsewhere in

August, and, one week later, cut the rest of it down, and this will insure good pasturage for bees until frost."

Now as the plants sometimes ripen a crop of seed about the middle of August, it is my belief that most of the roots would die if the plants be cut at this stage. I should, there-

fore, very much prefer to cut part of the crop in June and before it blossoms. By so doing the period of blooming will be lengthened from two to four weeks. Sometimes it may do to cut the plants while in bloom—say between the middle of July and the first of August—but much depends upon the condition of the weather and the roots of the plants. If both weather and roots are just right, the latter will be able to send forth a new growth of plants.

My experience is that the roots of sweet clover are not so difficult to destroy, by cutting off the top growth when old enough to bloom, as many seem to suppose.

St. Charles, Kane Co., Ills.



Unqueening and Requeening—How Practiced.

BY R. C. AIKIN.

On page 358 of the Bee Journal for 1895, is an article by C. H. Chapman, on dequeening. Both the editor and Mr. Chapman asked that I give an article on the subject. As it was then right in the swarming season, and when I was very busy, it was too late to get an article before the readers in time to be of benefit last year (1895). Mr. Chapman seems to understand the method pretty well, yet he is open to two or three criticisms. I will give my method, and offer criticisms in the proper connection. I will also try to point out the kind of a location in which this method would not be suitable.

Our honey-flow begins about June 15. Since I have been in Colorado, the earliest opening was the 12th, and the latest the 25th. These dates apply only to this part of the State. When the colonies were not strong enough I have sometimes delayed unqueening until the flow was on for a week or more; but experience has shown me that it is best to remove the queen right at the beginning of the flow, and more especially if the flow be abrupt and short. If the flow lasts for a number of weeks, unqueening later would mean more workers for the latter end of the flow. After 21 days from removing the queen the colony will rapidly decrease until the new queen gets brood to hatching. I try to have the hive full of brood and field-bees when the flow comes. As soon as I know that the flow has begun, I remove the queens, and at the same time look over every comb, and cut out every cell. (On page 406, Mr. Getaz says I cut out all but one cell at this time; but he either misquoted, or else I have blundered, for I never meant to give such advice.) If a cell be left at this time, there is no certainty about it, for there is no way to tell certainly the state of advancement—how soon it will hatch. Make thorough work, and cut out all cells at the removal of the queen, then there will be no swarming before the 10th or 12th day.

A queen hatches the 16th day from the laying of the egg. There is no difficulty about rearing a queen from larvæ two and three days old, or five to six days from laying the egg. If the colony begins cells the day the queen is removed, and uses a three-day larva, such queen will hatch the 10th day. Some colonies will do this very thing, while those that have not had the swarming instinct yet aroused, will be more slow, and use less advanced larvæ. Some will even start from the egg, and so will not hatch a queen till the 16th day.

Since the colonies will be all grades, from the weak to the very strong, there will necessarily be those ready to swarm, and those with no thought of swarming. The work must be arranged to make all safe between certain dates, and we arrange those dates to cover the whole apiary. I find it does not pay to have colonies of all grades of strength, but rather to unite till all that are run for surplus are made very strong in both bees and brood, and the remnants made into colonies of sufficient strength to fill their brood-chambers, and yet not trouble us about swarming. The uniting is done just as the flow is opening, and the unqueening being done, so there is no trouble about quarrelling or robbing.

As each colony is made queenless—whether an original or a united colony—I cut out all cells. As explained in the third paragraph, we may expect some to have queens ready to hatch the 10th day, and from that clear up to the 16th day. I have reason to believe that some colonies whose swarming instinct has been fully aroused, will use a seven-day larva in their eagerness to rear a queen, and such would hatch the 9th day. The great majority will start queens three to five days from the egg, which will bring hatching queens from the 11th to the 13th days. We must then be in the apiary not later than the 10th day from unqueening. Mr. Chapman says "in seven or eight days" cut out cells. Seven days is too soon. The brood will not be all sealed the 7th day, and a colony hopelessly queenless will make a desperate effort to rear a queen and use the yet unsealed larva, but the result will be a worth-

less queen, and yet go with the swarm the same. This is Mr. Elwood's experience, as well as my own. I cut out cells the 8th, 9th or 10th days, as pressure of work or weather will permit. I plan to work them the 9th day, and cut out all cells, or all but one if I want to requeen from their own cells. Cells that are built when a colony is making preparation for swarming, are nearly—if not *always*—built from the egg; and if I have such from choice stock, I prefer to insert one of these when I cut out the others. It will do no harm to cut out all and leave the colony hopelessly queenless awhile, as Mr. Chapman recommends, but I cannot advise this method. Three or four days will do no harm, but if left six or seven days there is danger of laying workers beginning, and a colony *hopelessly queenless will very soon lose energy.*

I do frequently requeen by leaving one of the colony's own cells. Mr. Chapman asks if this will not give very poor queens. The quality of the queen depends very largely upon the selection of the cell. Of course, when the queen is removed there are always eggs in the hive. A colony, as before explained, will use some of the more advanced brood in the construction of cells, yet they almost invariably build some cells from the egg, too. When I cut out cells I look for the less mature cells—those that will hatch the 14th, 15th or 16th day—and so get as good queens as are furnished by the thousand by breeders, and as good as a large per cent. of those reared in natural swarming.

Mr. Chapman also says: "Allow the swarm to issue the same as in natural swarming," and cut out cells while the swarm is out. It is so easy to do the work while the hive is thus depopulated that one is tempted to do this (Mr. Chapman clips his queens, and so do I), but it requires watching for swarms that we don't want to do, and that we cannot do in two or more apiaries at one time. It also allows the colony to become excited with the swarming-fever—another thing we do not want. Aim to cut out cells the 9th day, and keep absolute control of the bees. Very few queens will begin the movements within the cell before the 9th day, and the work of the colony goes on the same; but the maturing queen soon begins to move about in the various cells, and then begins the excitement that comes with swarming. Sometimes this excitement runs so high that they will swarm before the queen hatches. Such a condition is very detrimental to the work of the colony. If there is prospect of bad weather, cut out cells the eighth day. If you plan for the 9th day, you will have the 10th and 11th to come and go on. A very few queens will hatch the 10th day, and more the 11th day. These queens usually do not leave the hive till the first—and sometimes the second—day after hatching; so waiting till the 11th day will not risk much in the loss of swarms, but is not recommended because of the excitement caused by the presence of the queen.

If you work the whole apiary in one day, and treat all alike, you may get along without numbering hives; but if the unqueening of an apiary is done at different dates, a system of numbering and recording is a necessity. As outlined in the foregoing, there is no need of failure; but the work *must not be slighted—FIND EVERY CELL.*

This article is now too lengthy to permit of details about the care of queens and making nuclei or increase; location, convenience and wishes of the apiarist enter into this. In locations having but one flow during the season, there is no question in my mind about the desirability of this method. Where there are two or more flows it may be applied by other methods.

Loveland, Colo.



Tests for the Purity of Beeswax, Etc.

BY C. P. DADANT.

Referring to the article on beeswax, by Mr. Gregg, in a recent number of the Bee Journal, we will say that the test given—to try the purity of beeswax by chewing it—is a good one if the adulteration is quite flagrant, for most of the adulterants do not chew like beeswax, but it is a very poor grade of goods that will not crumble in the mouth. If in chewing, you can make it hold together and stretch, like chewing gum, you may be sure that there is less beeswax in the sample than anything else.

We do not know that there is any very good popular test except the above and the alcohol test. To make the alcohol test, put water in a wide-mouth bottle, and put into it a piece of pure beeswax. Then add alcohol till the wax readily falls to the bottom. You are then ready for the test. Pieces that will float are of a different specific weight. Although there are some grades of beeswax that have a lighter specific weight than others, this test is fairly safe, but one must be sure, in

testing, that there are not some air-bubbles sticking to the piece tested, as this would cause it to float even when pure.

The taste, the smell and the touch, are all good tests. Even pure beeswax, if it does not smell of bees, will not be so readily accepted as that which smells "sui generis." That is why we much prefer sun-melted wax to all other kinds; and that is why we object to the now too popular method of cleansing wax with acids. This destroys entirely the bee-smell, and makes the wax really inferior.

The Europeans, perhaps, have a better chance to adulterate beeswax without suffering for it, because their climate is much milder than ours. In this country whoever has tried to adulterate beeswax with other substances, has killed, or will kill, his trade in a very short time; for the combs will not stand in our hot climate. Even good, pure beeswax will occasionally break down, even when all built naturally by the bees, and the least adulteration will show itself in a hot season, by a general breaking down of all the combs so made.

PREVENTION OF HONEY-THIEVES.

Our Canadian friend, on page 779 of the Bee Journal for 1895, criticizes the "questionable propriety" of the answers given to the query on catching honey-thieves in a previous number, and gives us a method which he calls best—a house-apary, properly locked. I, for one, cannot be convinced. The American farmer believes in his neighbor's honesty, he locks neither his door, nor his barn, and he surely will not think it will pay to lock his bee-hives. We have had from 300 to 500 hives of bees scattered through the country for years, and we do not think our total losses from thieves amount to \$5.00.

Hamilton, Ill.



Two Laying Queens in One Hive.

BY GEO. W. WILLIAMS.

On page 776 (1895), Mr. Abbott gives an extract of a letter I wrote him some time since, and in that letter I referred to the fact of having two laying queens in one hive. He requests that I give further particulars of these two queens.

About the last of May, 1895, I found that the bees in No. 5 was not doing as well as they should, and, in looking through I found the old queen (a black one) in an enfeebled condition, and decided at once to supersede her with an Italian. At the same time I found hive No. 6 very strong, and as I wanted increase, I divided them, taking out five frames and put them into hive No. 9, filling up both hives with frames filled with comb foundation. (I use the 10-frame Langstroth hive). I was very particular to see that the queen was left in No. 6, and no queen was put into No. 9.

I then ordered two untested Italian queens, when I hunted through hive No 5 and found the old enfeebled queen, pinched her head, and introduced the yellow one. I went to hive No. 9, and found a number of *queen-cells* with young larvae, and, cut them all out, as I thought, introduced the queen, and on the third day I looked into both hives and found the bees had released and accepted the queens all right.

I paid but little attention to them until the 23rd day, when I again looked and found hundreds of young, bright golden Italian bees. I thought, "Now is a splendid opportunity to note the life of the worker;" and I anxiously watched both hives to see when the blacks would disappear. In hive No. 5 they had nearly all disappeared Aug. 22, and by Aug. 31 were all gone.

But in hive No. 9, up to that time, I could see no diminution of blacks, although the beautifully-marked Italians were working in great numbers. About this time I noticed the young bees of this hive having a nice play, and, upon getting up close, I noted that they were about half young blacks. My suspicions were at once aroused that there were two queens doing service in that colony. I at once determined to see, and upon looking I soon found the yellow queen, but made quite a search before I found the black one, though finally succeeded in finding her. She looked as if she felt out of place, but I assured her, as best I could, that she was welcome to stay there for the season, at least, as I found her cell away down in the corner of a frame where I had overlooked it when I introduced the Italian on June 6.

There has been—as near as I could guess—all summer about as many of one kind of bees in the hive as the other; and to-day (Dec. 8) it is nice and warm, and the bees are having a good flight, and that colony seems to be about equally divided between the blacks and yellows.

No, Mr. Abbott, there is "no mistake;" there are two queens in that hive, and *both are young, laying queens*. I have them tucked up nice and snug for winter, and if the

readers of the Bee Journal wish to hear any more from these "twin sisters"—yet no kin, as one is black and the other yellow—I will, in the spring, tell how they wintered.

Humansville, Mo.

[By all means, Mr. Williams, let us hear further about your interesting case, next spring. It is not every bee-keeper who can boast of an Italian and an "African" family of bees living and working peaceably together.—EDITORS.]



The Drug Treatment of Foul Brood.

BY WM. M'EVROY.

In the American Bee Journal for Dec. 11, 1895, Dr. Miller asked Dr. Howard and myself to answer the following question:

"A bee-keeper raises the question, whether there may not be danger of attempting the cure of foul brood as given on page 591, in view of the fact that the instruction is to feed the diseased colony at a time when the bees have no other sources; and that this is one of the conditions absolutely essential to success."

If the reader will turn to page 591, he will see the old drug-method trotted to the front again. When foul brood matter in diseased colonies dries down, it settles on the lower side and bottom of the cells, and sticks there like glue. And when the bees gather honey they store it in the cells where the foul-brood matter dried down, just the same as they do in sound cells. When the disease increases, and the colony becomes weaker, the bees store more honey right in the brood-nest. Then just as soon as the sound larvae is fed any honey that has been stored in the diseased cells, it will die of foul brood. And when larvae is fed in cells where foul matter dried down, it will also die of foul brood.

Medicated syrup, to be of any use for curing foul brood, would have to be strong enough with drugs to kill every germ in both the diseased cells and honey. And any medicated syrup made strong enough with drugs to do that, would kill all the sound larvae, and every bee in the colony.

Cheshire's drug treatment for curing foul brood was found to be a complete failure when thoroughly tried with foul-broody colonies in Mr. D. A. Jones' apiaries at Beeton, Ont. Mr. Henry Couse—who was, for years, foreman in Jones' bee-yards—told me that they had sprayed the diseased combs with acids so strong that the combs fairly smoked; and then it failed to cure them of foul brood.

Dr. Duncan, of Embro, Ont., is a good bee-keeper as well as a medical man, and he told me that when his colonies had foul brood, he found the drug treatment of no use; and he also said that his experience was that the foul-broody combs and diseased honey had both to be gotten away from the bees before a cure could be made.

Mr. Vankleek, of Listowel, Ont., did his best with the drug treatment, and failed to cure his colonies by it.

Mr. James Frith, of Princeton, Ont., stuck right to the Cheshire drug treatment in the hope of saving his bees, and lost the whole of his 120 colonies with foul brood. We all felt very sorry for Mr. Frith, as he was depending a good deal upon his bees. I asked Mr. Frith why he didn't try my method of curing foul brood, and he said that he had not heard of my plan at that time.

Mr. A. I. Root, of Medina, Ohio, tried the Cheshire drug treatment with his colonies when they had foul brood, and failed to cure them of the disease with it, and, when following that treatment, had the disease spread worse.

Would any bee-keeper, with a large apiary in good condition, be willing to see a neighbor keep colonies with combs in them rotten with foul brood, and then feed them at a time when bees would rob, without first destroying all the foul-broody combs? To advise the feeding of medicated syrup to colonies that have combs rotten with foul brood, and at a time when the weather is warm, and no honey for the bees to gather, is, without exception, the greatest humbug and most dangerous advice ever given.

No cure can be made by feeding medicated syrup, and to feed in warm days, when there is no honey for the bees to gather, would set the bees to robbing the foul-broody colonies, and then the disease would be spread with a vengeance.

Would it be right for a man to live in a city, and when any of his children died of small-pox, to leave them lie in bed, and keep them there; then throw a lot of medicated syrup over them, and at the same time put a lot of phenolated syrup in all the food for the rest of the family to use—then call it a

"cheap and easy cure," and with a solemn air lecture all the people on what science teaches?

Every bee-keeper should get Dr. Howard's booklet on foul brood, and read it, as it is the only book on the subject that will be of any value to any bee-keeper. Wm. McEvoy, Woodburn, Ont., Canada. *Foul Brood Inspector.*

[Dr. Howard's booklet can be had at this office for 25 cents; or both it and the Bee Journal for one year for only \$1.10.—EDITORS.]



"One Bee-Keeper Selling Another's Honey."

BY E. TAYLOR.

In the November Bee-Keepers' Review I notice that our quaint friend, Mr. Hasty, has been badly hurt by several of the replies to Query 992, in the Bee Journal of Oct. 17, 1895. I remember Mr. Hasty as the inventor of the celebrated sugar-honey, and I would not hurt his tender sensibilities for anything. Our sugar-honey friend says:

A little close inspection will convince a body that not nearly all of these seven persons know what they are saying. For instance, J. M. Hambaugh says, "Yes! If your neighbor does not object." As all men object to false pretences, when the other fellow makes them, he gives himself away—happily gives himself away—to the effect that he is not a rascal, but only a little beedless. Unfortunately we cannot get all of the seven off in that way. It gives me sincere pain to quote; and I am going to leave the names off as I do so.

I congratulate Mr. Hambaugh on his accidental escape from the company of the "rascals." Mr. Hasty says he will generously leave the names of the rascals off. Dear Friend H., I fear you are unjustly kind, and I will help you to amend. The seven rascals who say that there is nothing wrong in buying honey that is in every way as good as our own product, and selling it to our customers, are: Chas. Dadant & Son, W. G. Larrabee, J. A. Green, H. D. Cutting, J. M. Jenkins, Rev. E. T. Abbott, and B. Taylor. The Dadants' reply, and my own, read as follows:

Chas. Dadant & Son—It is all right if you know the honey is good. There is no deception about it, at least none that need worry your conscience.

B. Taylor—Nothing is wrong that harms no person. If the honey is as good as your own, no one would be harmed, and it would not be wrong.

Now these two answers are held up by Mr. Hasty as the especial evidence of the genus "rascal," but I stand by my answer; it contains the substance of law and gospel honesty—not an ounce of sugar-honey in it.

Another reply reads thus:

Emerson T. Abbott—You do not need to lie to your customers. If they know you to be an honest man, they will not ask any further questions, if you tell them you are ready to stand behind all the goods you sell.

Now let me illustrate Mr. Abbott's answer: In the fall of 1894 I canvassed my former customers for orders, and booked enough to consume my small crop of basswood honey, but when I came to fill the orders I was some 50 pounds short. I went to a friend and bought 60 pounds of as nice basswood honey as any man can produce. I put it into my cans and delivered it without ever thinking of making any explanation of any kind. The labels on the cans read: "BASSWOOD HONEY. FORESTVILLE APIARY. B. TAYLOR, PROPRIETOR, Forestville, Minn." Now, will any sensible man say that there was any need of tearing the labels off, or making any kind of explanation in order to be dubbed "honest" by our sugar-honey friend?

I sell all my honey to be returned if not satisfactory, and I never had a pound returned in my 46 years of selling. I have lived and sold honey for 36 years where I now live, and none of my customers would think of asking where I got my honey, any more than they would think of each customer who paid them gold needing to prove the particular mine it came from.

Let me say here that the 60 pounds noted above is all the honey I ever bought to fill my orders with, but in the future I will buy if I need to, and will sell without changing my labels, or asking the buyers' consent. I will cure and prepare the bought honey just as I do my own; will then say to each purchaser, "This honey is first-class, and you may return it after trial if it does not give entire satisfaction."

Now, Mr. Hasty, I don't believe that when you invented the famous sugar-honey you intended any fraud or wrong. You just did not consider that it opened wide the door to fraud

and deception, and came nearer to harmful results than any proposition ever suggested to bee-keepers. Some Minnesota bee-keepers said "Rascal!" when I attempted to excuse you, but I was moved by that charity that "thinketh no evil," and reasoned most—but not all—of them out of it.

Now, Mr. Dadant never allows any but perfect foundation to go to his customers, and I never allow shoddy work of any kind to leave my shop. I never try to sell cheaper than any competitor, but the work must be first-class of its kind. And I don't believe you could get the Dadants to make fraudulent foundation at any price, for they, as well as myself, believe that honesty is more in what we do than in what we say. Yet we do not believe in talking fraud; that it is not necessary for honest people to deceive; and that none but fools tell lies.

Now, Friend H., come to think of it, does it not seem a little "Hasty" in you to hold up to the public gaze seven of your brother bee-keepers to the charge of "Rascal," without a jury trial?

Forestville, Minn.

Questions AND Answers

CONDUCTED BY

DR. C. C. MILLER, MARENGO, ILL.

[Questions may be mailed to the Bee Journal, or to Dr. Miller direct.]

Preparing the Bees and Hauling Them.

In what way would you prepare bees to move overland 7 or 8 miles? Can they be moved in a common farm-wagon, coupled out and prepared to haul 30 colonies at a time?

My bees are mostly in Simplicity hives, many of them in a dilapidated condition, so that the bees can escape all around the bottom, and no cover over the top except loose boards. I have 93 colonies in this condition to be moved.

Astoria, Ills.

W. C. H.

ANSWER.—Whew! That's a job for certain—to move 93 colonies of bees in leaky hives with only loose boards on top! In the first place, the farm-wagon is all right if your roads are ordinary Illinois roads, and you practice some care in driving.

For fear I forget it, I want to tell you before I go any farther, not to think of hauling them in cold weather, at a time when there will be no likelihood of a cleansing flight for some time. The shaking up that they'd get in that 7-mile ride would do them no great harm if they could have a flight right after it, but if they should be confined several weeks it would be likely to ruin them. Better leave them till spring, and then it would be no harm to take them on a day so cold that no bee would think of flying. Two reasons for taking on a cold day: One is, that if any bees get out they'll not be so likely to stampede the horses; and another is, that there will be less danger of smothering them.

As to preparing them for hauling, I feel a little shaky about giving advice, as I never hauled just that kind of hives, and if they were my own bees I think I'd try to hunt up some one that knew more about it than I do. However, there are always good friends on the watch, and if my advice isn't the best, perhaps some of them will help us out.

Perhaps the first thing to look after is the inside—to see that the frames will not shake about in the hive and mash bees and combs. If the frames were of the fixed kind, this would not need looking after, or even common, loose-hanging frames with wooden ends of top-bars resting on flat wooden rabbets, for I constantly haul this latter kind without any preparation whatever, merely depending on the accumulation of propolis to keep the frames in place. But I wouldn't want to handle the frames before hauling, for that would break up the attachments. But your Simplicity hives probably have metal rabbets with metal-cornered frames, and they'll be dancing a jig all the way if you don't fasten them in some way.

You can fasten the frames in this way: Make some sticks about as long as the end-bars of your frames, or a little shorter. Let them be about $\frac{3}{4}$ inch wide, and thick enough so that there will be room enough to crowd one down at each end between each two frames. Perhaps $\frac{3}{8}$ of an inch or a little more will be thick enough. At least thick enough so

they make rather a snug fit. At one end of each of these sticks drive through, about $\frac{1}{4}$ inch from the end, a small wire nail an inch to an inch and a half long. Drive it far enough through so it will project through the wood as much at the point as it does at the head. This will keep the sticks from falling down between the frames, and it will make it easier to take the sticks out after hauling. It will do no particular harm if the sticks are left in a good many days after hauling.

As to the rest, the two things are to see that plenty of air can readily pass, and that no bee can get out. One could perhaps tell a little better how to accomplish this if he were right on the spot and could see the hives. I asked another bee-keeper who happened to be present how I should answer the question as to preparing and hauling those hives. The reply was: "Tell him he can't do it at all with that sort of traps. The thing can't be done." I admit it will be some trouble, still if I had those hives and wanted to haul them, I think I'd haul them.

You can give air below by means of wire-cloth arranged in some way, but as there is no good covering on top, perhaps the best thing will be to cover the entire top with a piece of wire-cloth, and then there will be no possible danger of smothering the bees. After you have everything fastened tight, then go over every spot—top, bottom, sides and ends—and look carefully for any spot a bee could get through, and stop it with a piece of rag crowded in with a jack-knife. If you see a crack that you think about half big enough for a bee to get through, don't say, "Oh, I guess it doesn't matter about such a little crack as that, no bee can get through it!" but stop it up anyhow, and be on the safe side. Unless you've been "through the mill," and have had trouble from bees getting out on the road, you'll be almost sure to leave some leak; but when you do get into trouble by it, please don't blame me for not warning you.

Have everything arranged so far as you can, so that you can quickly unhitch your team if anything happens, for I'd rather not have horses too near escaping bees. I know it is said that bees are hauled without being fastened in, and that after being smoked and jolted a little they stay right where they are; still, I think I'd rather be sure to have them fastened in the hive. And it's a pretty good thing to have a lighted smoker ready in case of emergency.

Possibly you could replace some of the worst hives with new ones before hauling.

Transferring from Bee-Trees—Feeding in Winter

1. What is the best time to cut a bee-tree and transfer the bees to the hive?

2. Is it best to transfer the comb made in the hollow tree, or only the best of the worker-comb, and brood (if any)?

3. Is it too late to feed a colony that has not sufficient stores? I have two or three that I did not suspect of being short. (I have the Miller feeder, and can use it inside, you know.)

G. M.

Braddyville, Iowa, Dec. 10.

ANSWERS.—1. I think I should prefer to take it at the time usually preferred for transferring, that is, about the time of fruit-bloom.

2. I'd save the worker-brood and any nice, straight worker-comb.

3. Yes, it's too late to feed to the best advantage, but still I would rather try to feed now than to let a colony starve. But I'd use sugar candy for feeding, such as you've probably seen described many times. It's much better than to feed liquid feed in winter.

Hive-Entrance in Winter—Did the Bees Freeze or Starve to Death?

To winter my bees I chaff-pack them from two to eight inches deep on the sides of the hives, and four to 12 inches deep on top. To form an entrance I cut a piece out of the box that holds the packing 5x12 inches and put a board inside between the hive and the box, letting it slant from the upper edge of the hole in the box down to one inch of the entrance of the hive. This is done to keep the packing in place, and as my hives all face the south, this allows the sun to shine in at the entrance the same as in summer.

I leave the top-boards, or covers, sealed down over the brood-chamber, and some times I put a two-inch rim under some of the hives.

Now what I wish to know is this: 1. With hives packed in chaff six inches on the sides and eight inches on top, with

sealed covers, could I close, or partially close, the entrance during cold or zero weather, and have no frost to adhere to the inside walls of the hive? I always leave the entrances wide open, which are 12 to 14 inches long, and this seems to me much like making a big fire in the stove and leaving the house-door open. Now, which way is the best? and why?

2. In Nov., 1893, a neighbor of mine put three colonies of bees into a smoke-house to winter, and as it was a poor affair the bees found no trouble in getting out of it, and thus marking the location of their home. Along in March, 1894, he removed them to an orchard, a distance of about 10 rods, and the next day the bees flew back to their location in the smoke-house, and in the evening clustered in a heap on the floor, to the extent of about a gallon. As the temperature went down somewhere between 10° and 20° below freezing, they were all dead the next morning, so my neighbor told me. He said they froze. Now Mr. Abbott would say that they starved. Please let me know what your opinion is.

Armour, Iowa.

W. S. D.

ANSWERS.—1. If your bees have wintered well, as heretofore arranged, that's a pretty good reason for continuing the same practice, or at least trying any change on a small scale at first. One reason why I should give the bees a good-sized entrance is that those who have had experience in the matter favor it. They probably favor it because upon trial they find the best success with it. To come more directly to the spirit of your question, if you close the entrance entirely, you will still find frost on the walls of the hive whenever it is so cold that the walls go below the freezing-point; for vapor is constantly being thrown off by the bees, and closing the entrance holds all the vapor in the hive, so you can see there will be more frost form on the walls than if the vapor should partly escape at the entrance.

Another thing to be remembered is, that bees keep up warmth in the hive by means of food and air. Food alone will not keep them warm—they must have air as well. You may cram all the coal you please into a stove, if you carefully shut off all air from the fire it will go out. Did you ever notice that in a crowded room you become chilly when the air becomes foul, even though the thermometer stands pretty high? So the point to strive for with your bees is to close up enough to keep the bees warm, and at the same time leave the entrance large enough, so that the foul air and vapor can escape, and enough fresh air enter to supply what oxygen the bees need. If you think your hive-entrances are more open than necessary, try a few of them closer and see how they come out in spring. If they do better than the others, then you can practice the same thing on a larger scale next winter.

2. I hardly know what to say about those bees being dead "next morning." At least I think this is true, that if your neighbor had taken the bees into a warm room they would most, or all, of them have come to life that morning. But whether they were dead, dead, the next morning or later, I should say they froze to death.

CONVENTION PROCEEDINGS

The Report of the Illinois State Convention.

(Continued from page 11.)

SECOND DAY—MORNING SESSION.

The meeting was called to order at 9:30 by Pres. Smith.

It was decided to leave the time of the next annual meeting to the Executive Committee. A discussion on the Chicago meeting then followed.

Dr. Miller thought a meeting of the Illinois State Bee-Keepers' Association, if called in Chicago, would not be as well attended as would a called meeting of the Northwestern. He also thought membership not so governed by attendance.

Mr. Dadant said that the Northwestern, representing the entire Northwest, would bring a much larger attendance than the State meeting would.

Mr. Becker thought the poor honey year had more to do with the attendance than anything else.

Mr. York cited a case in Chicago of a man having six colonies of bees, who had a yield of 900 pounds of honey this year. Not a very poor year there.

The resolution which the Secretary had been instructed to prepare the day before, came up, was duly considered, and finally adopted as follows:

WHEREAS, It is the opinion of this Association, that measures should be taken to increase both membership in our Association and attendance upon the same, and thereby form an association that will be large enough to make its influence felt—as well in our legislative halls as elsewhere; therefore, be it

Resolved, That the Secretary be instructed to give notice to bee-keepers throughout Illinois, that upon receipt of \$1.00 by him, the sender will be entitled to receive the American Bee Journal, of Chicago, (as the official organ of the State Association) for one year, as well as a membership in the State Bee-Keepers' Association for one year, with whatever benefits may result therefrom; including a copy of the Second Annual Report, and anything further which may follow during the time of membership.

Mr. Becker offered a resolution that the President appoint a committee of three, to ask of the Superintendent at the State Fair, that a permanent place be assigned for bees, honey, etc., all together, in one part of the building, and that they be asked to place a freight elevator in the Dome Building for the use of exhibitors. This was laid on the table.

The report of the Committee on the State Fair was read and accepted as follows:

The committee appointed to represent our interests before the State Board of Agriculture and the State Experimental Station, beg leave to report as follows:

We revised last year's premium list, offered by the State Fair Association, on bees and honey, making a list aggregating \$312, and presented the same to the State Board of Agriculture, who, in considering our petition, raised objections to allowing any premiums whatever on implements and devices of any sort, and ruled out all premiums offered upon them. The petition was then referred to the Superintendent of the Farm Products' Department—Hon. D. W. Vittum, of Canton, Ill.—who told us he could allow us about \$250 out of the amount allowed him for premiums. The committee then revised the list according to the ruling of the State Board, which revision was accepted, as was also the Code of Rules for making awards, as recommended by this Association.

Your committee were also asked to recommend a judge, capable of judging fairly, and recommended Mr. J. A. Green, whose efficient services were obtained. Our List and Rules brought at least seven exhibitors from our State, one from Indiana, and one from New York, who placed about 5,000 pounds of honey on exhibition, and made a creditable display of other articles, there being as high as 13 entries for one premium.

Supt. Vittum did all he could to increase our premium list, and assisted us in every way possible, and expressed himself as well pleased with our exhibit, hoping to be able to allow us a larger list the coming year. And in view of the importance of the pursuit in our State, and the standing of our State among the other States, we think an increase ought surely to be made.

The committee also memorialized the President of the State University—Dr. Draper—praying the establishment of an Experimental Station for bee-keepers, who referred the same to the Board of Directors, who replied by letter as previously read.

All of which is respectfully submitted.

JAS. A. STONE,
 GEO. F. ROBBINS, } Committee.
 W. J. FINCH, JR., }

On motion the following committee was appointed on State Fair work: Geo. F. Robbins, Chas. Becker, and W. J. Finch, Jr.

The convention then adjourned to 1:30 p.m.

AFTERNOON SESSION.

The meeting was called to order by Pres. Smith.

The following resolutions by Geo. F. Robbins were read and adopted:

Resolved, That the thanks of the bee-keepers of Illinois are due, and are hereby tendered, to the State Board of Agriculture for their liberal premium list, and for their general good treatment of bee-keepers and the apian industry.

Resolved, That a copy of this resolution be sent to the Board at their next meeting.

The election of officers for the ensuing year was held at this time, with the following result:

President, Dr. C. C. Miller, of Marengo; Vice-Presidents—1st, J. Q. Smith, of Lincoln; 2nd, C. P. Dadant, of Hamilton; 3rd, S. N. Black, of Clayton; 4th, Mrs. L. Harrison, of Peoria; 5th, Geo. F. Robbins, of Mechanicsburg; Secretary, Jas. A. Stone, of Bradfordton; and Treasurer, A. N. Draper, of Upper Alton.

It was voted that all the money in the treasury (which is \$1.27) be paid to the Secretary for his services up to date.

The prospects for the coming year were then considered. Mr. Robbins said that when clover is well-rooted it does not winter-kill.

Mr. York said that B. Taylor, of Minnesota, predicts a good season next year.

Mr. Dadant—I think there is no one that can tell.

Mr. Black—We cannot tell anything from the prospects a year ahead. In our part of the State we have a good prospect for the year ahead. Three or four dry years cuts out heart's-ease, etc. No man can tell a year ahead.

Dr. Miller—I think next year will be a good one. It is remarkable to have a long series of failures. The longer the failures the more likely the next will succeed.

Mr. Becker—If there is a supply of white clover in the fall, the next year is probable; but there is none in my vicinity.

Mr. Black—I know of only one honey-plant that is to be depended upon, and that is sweet clover.

Dr. Miller—I saw a large field of alfalfa, and but few bees on it.

Mr. Dadant—Alfalfa is a good honey-plant in Europe, and I don't see why it should not be here.

The Secretary—I have a small patch of alfalfa in the garden—this is the second year. I could have cut it four times, but for waiting for seed to mature. I have never seen many bees working on it at any time.

Dr. Miller—I think that alfalfa will make a good forage plant, but that is not what we are after, if it is not good for honey as well. I think the day will come when sweet clover will be used as a forage plant. I know of the stock liking it in localities where it is widely grown; and I know of a place where stock are driven by it, along the road, where they keep it eaten down. Alsike is the best clover I have ever used. It does not produce as much hay as red clover, but a finer and better quality.

Mr. Dadant—When we have abundance of white clover it does not matter about the other clovers. I think it is a help to sweet clover to cut it, as it then blooms more profusely.

Mr. Robbins—We can't depend on white clover, and we should encourage the raising of Alsike.

The Pres.—The trouble with Alsike—they pasture it too closely, and then claim it doesn't pay.

Mr. Robbins asked: "Will artificial rearing of queens breed out the swarming fever?"

The President—When the queen quits laying the swarming will end.

On the adulteration of honey, Mr. Dadant said that if honey colors tea, it is not pure. Pure honey will not tarnish tin.

Mr. York—We ought to have a law against the adulteration of honey, then something could be done to prevent it.

Mr. Becker—If we have pure honey we can always sell it.

Mr. Black—But adulterated honey destroys the taste for pure honey.

Mr. York—Bee-keepers ought to supply their customers by buying, when they cannot fill their orders from their own crop.

Mr. Dadant—Spanish-needle and smart-weed honey sell the best, because it has such a strong taste that people are sure it is honey.

The convention adjourned *sine die*.

JAS. A. STONE, Secretary.

A New Binder for holding a year's numbers of the American Bee Journal, we propose to mail, postpaid, to every subscriber who sends us 20 cents in addition to paying for his or her subscription for 1896. It is called "The Wood Binder," is patented, and is an entirely new and very simple arrangement. Full printed directions accompany each Binder. Every reader should get it, and preserve the copies of the Bee Journal as fast as they are received. Why not begin with Jan. 1 to save them? They are invaluable for reference, and at the low price of the Binder you can afford to get it yearly.

If your subscription is already paid for 1896, send 20 cents for the Binder. If any one desires two of the Binders—one for 1895 and one for 1896—send 30 cents, and they will be mailed to you.

Southern Department

CONDUCTED BY

DR. J. P. H. BROWN, AUGUSTA, GA.

[Please send all questions relating to bee-keeping in the South direct to Dr. Brown, and he will answer in this department.—Eds.]

Report of the International Bee-Keepers' Congress at Atlanta, Ga., Dec. 4 and 5, 1895.

This Congress was called to order on Wednesday morning by Rev. Jas. G. Teter, of Tennessee, and opened by prayer by A. I. Root, of Ohio. Upon nomination, Dr. J. P. H. Brown, of Georgia, was elected President, J. T. Calvert, of Ohio, Secretary, and A. I. Root, Vice-President.

W. S. Hart, of Florida, moved that a committee of three

or more bee-keepers prominent in each State of the United States, as Vice-President of this association, or representative of the bee-keepers of his State, to work up an organization in the interest of bee-keeping in said State.

As there was some opposition to Mr. Lowrance's motion, he withdrew it, and Mr. Frank Benton offered the following as a substitute:

Resolved, That this Congress proceed to effect a permanent organization under the name of "The National Bee-Keepers' Association of the United States of America," with the purpose of embracing all the States and securing representation from the several States.

He spoke of the need of a National organization of bee-keepers for the United States, which should be representative of the whole country, and which should meet once in two or three years and discuss, not questions for beginners, but advanced apiculture.

The resolution was laid on the table, to be taken up the first thing at the morning session.

THURSDAY MORNING SESSION, DEC. 5.

The meeting was called to order by the President, after which Rev. J. G. Teter offered prayer. The minutes of the previous session were read and approved. The resolution offered by Frank Benton was taken up and discussed.

A. I. Root and J. T. Calvert both spoke in opposition to

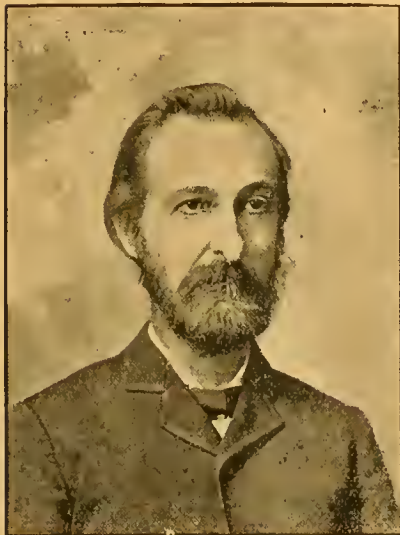

President Dr. J. P. H. Brown.



Vice-President A. I. Root.

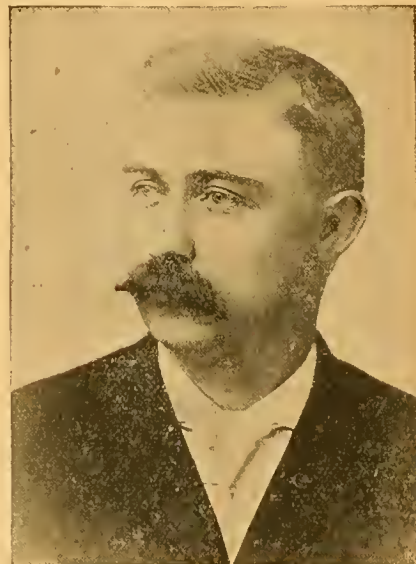

Secretary J. T. Calvert.

be appointed to prepare a program. The chairman appointed Messrs. W. S. Hart, Rev. J. G. Teter, and J. T. Calvert.

Messrs. A. I. Root, O. O. Poppleton, of Florida, and J. D. Foose, of South Carolina, were appointed a committee on resolutions.

SWARMING OF BEES—SOUTHERN BEE-KEEPERS.

Next in order was the reading of an essay by Chas. Dadant, of Illinois, entitled, "About Natural Swarming." [This essay has not yet been received at the Bee Journal office, but will appear later if it comes.—Eds.]

Mr. Dadant's essay gave rise to some discussion. W. S. Hart agreed in the main with the author of the essay, and said excessive heat will induce bees to swarm, as well as the conditions mentioned by Mr. Dadant. Mr. Dauzenbaker, of the District of Columbia, said it was as natural for bees to swarm as for hens to sit, and other things to reproduce. J. L. Hubbard, of North Carolina, agreed with Mr. Dadant.

Questions suggested by the committee on program were read, and the following selected for discussion: "Are there no means by which the apiarists of the South may be brought more in touch with one another, so as to more fully develop the apiarian resources of the Southern States?"

Mr. Poppleton suggested that a vigorous Southern department in all the bee-papers would help this end.

W. B. Lowrance, of South Carolina, offered the following resolution:

Resolved, That the chairman of this Congress appoint one

the resolution. The call for this meeting stated that it was to be an informal congress of bee-keepers; no permanent organization was contemplated; that it would not be fair to the bee-keepers not represented to go ahead hastily and form a permanent organization; and that there was no need of it, at any rate. The International could accomplish all that a national organization could, and thus save the machinery and fees of another organization.

The question was settled by the adoption of a substitute resolution offered by Mr. Poppleton, viz.: "That Dr. J. P. H. Brown, J. T. Calvert, A. I. Root and Frank Benton be requested to correspond with representative bee-keepers over the country at large in reference to the advisability of forming a national society. If the responses are favorable to such an organization, said committee are directed to call a meeting of bee-keepers at such time and place as their judgment may direct."

Mr. Calvert requested his name to be omitted from the committee, and the request was granted.

Next in order was the following essay by Mr. G. W. Demaree, of Kentucky, on

Bee-Culture.

I have been requested by a much-esteemed friend and prominent writer and bee-culturist of the State of Georgia, and of the South, to prepare an essay to be read on this occasion, and am granted the privilege to select my own theme.

(Continued on page 25.)

OLDEST BEE PAPER IN AMERICA ESTABLISHED IN 1861

THE AMERICAN BEE JOURNAL

PUBLISHED WEEKLY BY
GEORGE W. YORK & COMPANY,
Editors and Proprietors,

56 Fifth Avenue, CHICAGO, ILL.

\$1.00 a Year—Sample Copy Sent Free.

[Entered at the Post-Office at Chicago as Second-Class Mail-Matter.]

Vol. XXXVI. CHICAGO, ILL., JAN. 9, 1896. No. 2.



California Industries is to be the subject of a symposium soon to appear in the San Francisco Call. Prof. Cook is to furnish the article on Bee-Keeping. It will be an interesting and reliable contribution, surely.

The Chicago Meeting of the Illinois State Bee-Keepers' Association will be in session when the majority of readers of the Bee Journal receive this number. We are expecting a good time, and a large attendance on account of the 1½ fare granted by the railroad companies by reason of the National Cycle Exhibition held here this week.

Langstroth Memorial Extracts, mentioned last week, are found in this number of the Bee Journal. They are exceedingly interesting—so much so that our compositor who put them in type said: "Why, I'd be willing to die, if I could have such good things said of me afterward." We can add nothing more to what the various writers have said about our lamented Langstroth. We believe he deserved all, and more. Some day we trust there may be an appropriate volume published, in which shall be recorded in permanent form a just and complete account of the noble deeds and the words of wisdom of the honored Father of American apiculture—the Rev. L. L. Langstroth.

Melilot, or Sweet Clover.—The engraving on the first page of this number of the Bee Journal was made from a photograph showing a small plat of *Melilotus alba* in full bloom, as the plants appeared July 27, 1895, and after they had been in blossom nearly one month! This shows the immense value of melilot—the white variety—as a blooming plant, and why it is such a wonderful honey-plant. When the photograph was taken the plants were about 6 feet high, but this is simply an average growth in Northern Illinois, when they are old enough to be in full bloom. On very rich soil the plants often grow from 8 to 9 feet high.

It is through the kindness of Mr. Baldrige, that we have the pleasure of showing our readers this beautiful plat of melilot, or sweet clover. He is a great admirer of this honey-plant, so much so that he has gone to the expense of getting out several "Special Bulletins" on *Melilotus*. He will send three of them for 5 cents in stamps; and for 5 cents more he

will mail a small package of melilot seed—enough to sow a small plat of ground.

Undoubtedly, sweet clover is destined to become one of the leading honey-yielding plants in the near future. Its honey is of the finest, both in flavor and appearance, and drouths do not materially affect its growth. It seems to prosper in any part of our great country, and when farmers in general learn of its value as a hay and forage plant, they will unconsciously aid bee-keepers in placing it where the bees can revel upon it for weeks during the season of its bounteous blooming.

Selling Another's Honey.—On page 20 of this issue is a criticism by Mr. B. Taylor, in which he shows very clearly the correctness of our advice to buy and sell another bee-keeper's honey when your own crop is all disposed of and you have opportunity to sell more. So long as you know your bought honey is absolutely pure, and equal to your own production, there certainly can be no necessity for any explanation when offering it for sale to your customers. On this matter we think Mr. Hasty is now "straining at a gnat," while a few years ago he was "swallowing a camel" loaded high with sugar-honey.

Putting ourselves in a customer's place, and if we were buying honey of Mr. Hasty, would we care who produced the honey he sold us, so long as we had enough confidence in his honesty to feel that he would not sell anything but pure and good honey? We think that Mr. Taylor is entirely justified in his criticism, and we would urge every bee-keeper to try to keep his neighbors and customers constantly "sweetened up," even if you must buy all the honey you sell. But always, of course, be fully assured that the honey you purchase is the best and purest that can be had.

We have retailed quite a little honey the past two or three years (some of our own production, but most of it we bought), and our customers never think of questioning us about it. If they did, we should of course tell them the truth about it. Always tell the truth when you tell anything; but it isn't always necessary to say anything.

Bees Near a Railroad.—In response to the request made by Dr. Miller, on page 794, Hon. Geo. E. Hilton, of Fremont, Mich., says:

My home apiary is located near the railroad, and, with the observation of 16 years, I cannot see that the jarring affects the bees, although the ground shakes terribly at times.
GEO. E. HILTON.

Planning for Next Season.—One of our best agricultural exchanges—the Farm and Fireside—has some very good suggestions to offer to its readers, about preparing in advance for the coming season. The writer wisely says that winter is the time to make plans and be ready to begin next spring with a set purpose in view. No one can plan a year's operations and feel certain that it is going according to his plans, but he can map out a general course to pursue, and have his thinking done in time to be ready for acting when the time for action arrives.

He who works without well-considered plans works to no purpose, and wastes precious time repairing mistakes. If the work of a season is considered beforehand, it can be accomplished easily and without friction, and much of worry and bother will be dispensed with. An old farmer once said that he did a great deal of his work while sitting in his arm-chair. He meant that he planned his work carefully, and was ready to do everything in time, and promptly. That man's tools are always ready for use when they are needed; everything is in good repair all the time, because he does every bit of work at the proper time, and does not allow it to get ahead of him. Every one knows how hard it is to catch up when one gets a

little behind his work; and how much easier it seems when we are able to do to-day what must be done not later than tomorrow.

Delays in any kind of work on the farm or in the apiary are not only dangerous, but very often they are the cause of great loss. One day late may mean a great loss at planting-time, or its damage or ruin at harvest-time.

If the farmer or bee-keeper makes it a rule to do everything on time, or a little before it is absolutely necessary that it be done, and losses come to him from wind or weather, he has no reason to blame himself, as he has done all that he could.

The influence of farm and bee papers cannot be over-estimated. It is a rule that will apply to any community, that the man who reads the papers and acts according to the advice given in them, is the more intelligent and prosperous than the man who does not read. It is because of their reading, that farmers and bee-keepers of certain States and Provinces have a wide reputation for intelligence and progressive-ness.

It will be a good idea to begin the new year with a determination to so manage your business as to always have the upper hand, no matter what may happen. Think the whole matter over this winter, while you have time, and lay your plans for next season's campaign. Have enough provisos in reserve so that in case the unexpected or unfavorable should occur, you will not be at a loss how to proceed. No good general ever goes into a battle without a well-defined plan, and neither should the bee-keeper or farmer. Circumstances may change some of the details, but the main plan can generally be carried out.

Why not try this year to do a little better than we have heretofore; to give the bees better attention; to put up the honey (if we have any) in a more attractive condition; to make our homes and surroundings more inviting and comfortable; to treat our friends and neighbors a little better; to be more cheerful and good-natured; and to make those who live with us think we are the very best people in the world.

The Wisconsin Convention.—The twelfth annual meeting of the State Bee-Keepers' Association will take place at Madison, in the capitol, Feb. 6 and 7, 1896. The following is the splendid feast as arranged:

President's Address—F. Wilcox.
 Advantages in Location—H. Lathrop.
 Sweet Clover as a Honey-Plant—J. J. Ochsner.
 Size of Brood-Chamber—C. A. Hatch.
 Production and Sale of Comb Honey—F. Murray.
 Production and Sale of Extracted Honey—J. Hoffman.
 House-Apiaries—B. Taylor, of Forestville, Minn. (Mr. Taylor will be there to read his essay.)
 Benefits of a Foul Brood Law—N. E. Franco.
 Commission Men—L. M. Willis and S. T. Fish & Co.
 The free for all question-box is always interesting.

As other State societies are in session the same week, all are enabled to get excursion-rates on all railroads, if you get full-fare certificate wherever tickets are purchased. It will pay you to attend, if at all possible.

Mr. N. E. France, of Platteville, Wis., is the Secretary.

About New Bee-Papers—Well Put.—In the December Rural Californian we find this wise paragraph from Prof. Cook:

There are now seven or eight bee-journals published in the United States, and rumor has it that another is to be born at an early day in Southern California. Malthus' law applies to bee-journals with a vengeance. Would it not be better to make the journals now in the field better, rather than to start others to be poorly nourished, to languish and die prematurely? This has been the history of scores of journals, though occasionally one comes to stay, which proves that it has a place in our bee-literature.

International Bee-Keepers' Congress.

[Continued from page 23.]

That theme is "BEE-CULTURE." I want to speak of several questions under this head.

We live in a *time* of a most dangerous state of "unrest" among the people, the foundation of which is undoubtedly a "falling away" from *self-reliance* and Christian honesty, and *this* has precipitated the "war between labor and capital." The cause is mistaken for the effect. Is there no remedy for this menacing state of things? Perhaps yes, and may be no, for the prophets tell us of a "day" (a time) that will admit of no remedy—no patching up, and that time is pointed out as the concluding years of this age or dispensation. Nevertheless, whatever may be the *time* now, written with invisible fingers on the chronological dial of the age, it is our duty to meet and deal with things "as they are," and as we find them in the world, and one of these conditions is, *increasing competition*, that makes it harder for the laboring man or woman to live now than ever before. Hence, if the coming together of this apicultural congress can help to introduce a new and fairly remunerative occupation among our rural people, they will have done a good and lasting work.

The South is the home of the honey-bee. The apiary can be operated in the South with less labor and with more certainty in general results than anywhere else in North America. And yet our people are slow to reap these advantages. We have blindly "despised small things," though they may aggregate millions.

It is a fact that might be practically demonstrated, that millions worth of precious nectar—that costs nothing in human labor, and relieves Nature of her surplus without impoverishing—goes to waste every year, because there are so few bees, under the management of skilled apiarists, to gather and store it. Let the most observing among men walk in the fields in "blooming season," and notice the tiny flowers at his feet, and in the trees and shrubbery about him, and if not an apiarist, he sees no wealth in them all, only as his *sentiment* comes to his relief, and enables him to say, "It is a wealth of beauty!" But let a practical apiarist occupy these same fields with his bees, and he will see more than the other—he will see wealth in beauty, and wealth in realization.

I am not carried away by mere sentiment, when I say that no rural pursuit is more pleasing to the *senses*, more soothing to the natural fatigue of labor, and more profitable in proportion to the amount of capital employed, than is the usually called "little business" of honey-producing. I might illustrate this with practical facts. With 50 colonies of bees, and two months' labor on my part—no inconsiderable part of which was light work—I have cleared as much as \$450. Of course, in bee-culture, this means a whole season's occupancy. Other seasons I have cleared much less.

Bee-culture, as pertains to the production of honey, depends as much for successful output upon *weather conditions*, and perhaps more, than other agricultural pursuits. This fact has done much to make bee-culture a drag. The beginner in bee-culture cannot endure bad seasons at the start. The fact is, no man or woman can succeed in the business of producing honey for the markets by the application of *mere drudgery and toil*. There is something else essentially necessary, and that is some sort of enthusiasm or fascination for the business of keeping bees. This may be a natural love for the study of entomology, or some sort of fascination for the peculiar manipulations that are necessary to the modern management of bees. This fact makes it improbable that the production of honey will ever be overdone. But there are no inconsiderable number of men and women who possess the necessary qualifications for apiary work (if the facts were discovered to them), and this should be one of the aims of associated efforts.

There is no better way to meet sharp "competition" for "bread" than by enlarged occupation—"verified labor." The apiary will help in this direction.

It has occurred to me that there is but the *one* product of the earth that is truly a warming, nourishing food for man, pre-eminently delicious to the palate, that springs into perfection, in its season, by the touch of an unseen hand, and disappears as quickly if not utilized by bees. That product is *honey!*—the synonym of all that is sweet and good in the earth.

May the same unseen hand touch our lives into sweetness down to the *end*, which shall be but the beginning—everlasting!

G. W. DEMAREE.

The questions of evaporating unripe honey, and "how to best educate the Southern dealers and consumers as to the

properties and virtues of honey," were taken up and discussed.

W. S. Hart thought that his honey, that was evaporated by the sun, was fully equal to that of other bee-keepers, and, judging from the samples of his honey that were exhibited, the evidence was very conclusive. It was the general opinion of those present that all honey-packages should be nicely labeled, and leaflets attached, giving the properties and virtues of pure honey.

The next question was: "Is it practicable to introduce instruction in bee-culture into our common schools?"

Frank Benton stated that entomology was taught in Washington schools. Mrs. Harrison said that Natural History in the Peoria, Ill., schools included a study of bees.

BEE-DISEASES AND THEIR TREATMENT.

"What experience have you had in bee-diseases, and how have you treated them?" was asked.

Mr. Poppleton said that he thought he had lost 10,000 pounds of honey from damage to his colonies by bee-paralysis. Others present considered it of minor consequence. The general opinion was that no remedy yet proposed hit all cases.

A. F. Brown said that foul brood had made its appearance in Florida, and that he had lost 288 colonies. He treated ten, but failed, and finally burned the lot.

J. J. Keith, of Georgia, said he had cured foul brood by fumigating the colony with pitch-pine.

(Continued next week.)



The Rev. L. L. Langstroth Memorial.

Gleanings for Dec. 15, is a Langstroth number, a dozen pages being filled by leading men from both sides of the Atlantic, with tributes of well-deserved praise to the man we all delight to honor. Some extracts follow:

LANGSTROTH'S INVENTION—THE MOVABLE FRAME.

Langstroth's name is closely connected with his invention, and this has certainly placed bee-keeping upon an entirely different footing to what it occupied before the advent of the frame hive. There has been a great deal of controversy as to who was the original inventor of the frame principle. It was not till 1851 that Langstroth invented his hive, and frames had already been in use some years previously. They were, however, not of any practical utility, for the hives containing them were complicated, or so exceedingly expensive that they could be looked upon only as luxuries for rich amateurs rather than hives to be used by bee-keepers for business purposes.

It was not till 1851 that Langstroth invented his frame hive, which, from its simplicity, cheapness, and practical adaptability to the purposes required, has conferred a lasting boon on bee-keeping. There are no doubt some who think other methods are quite as good; but a very large and daily increasing number of bee-keepers on this continent of Europe recognize that the principle introduced by Langstroth—and first published by him in 1852, in his book on the honey-bee—is the correct one. The opening of the hive at the top, the perfect interchangeability of the movable combs, and the lateral movement of the frames, have given the bee-keeper the most perfect control over his bees, and have more than justified Langstroth's expectations when he wrote the note in his diary in 1851, that, "The use of these frames will, I am persuaded, give a new impetus to the easy and profitable management of bees."

There are not many bee-keepers of the present day who can look back 40 years or who know how Mr. Langstroth was treated, even by those who were quick to perceive the advantages to be derived from his invention; or how they pilfered his best ideas, and even patented them, and how he was defrauded of his just dues. Nor do they know that these infringements of his rights led to costly litigation which swallowed up all his well-merited gains. As one of your own writers (Prof. Cook) has written in Gleanings: "This whole mat-

ter is the dark page in American bee-keeping history, and we gladly pass it by without further comment."—THOS. WM. COWAN, editor of the British Bee Journal.

LANGSTROTH REVERED THE WORLD OVER.

The name of Langstroth is known and revered, not alone in North America, but in France, Switzerland, Belgium, Italy,



Rev. L. L. Langstroth in His 82nd Year.

and even in Russia, where the French edition of "Langstroth Revised" has been translated into Russian, in which language it has reached its second edition. Many apiculturists having described the qualities of our lamented friend, it suffices me to say that my son and I are happy to have been deemed capable by him to put his book—which was so far in advance of the

times at the date of its first publication—abreast with all that has been achieved since; and above all, to have succeeded in spreading its renown in all countries where the English language is known, and where he is considered, as well as in the United States, as a superior man, distinguished for his intelligence, his knowledge, his disinterested and unceasing work directed toward apicultural progress, to which he had devoted his life.—CHARLES DADANT.

A GERMAN ESTIMATE.

And now let me say right here, Langstroth was one of those bee-keepers to whom is due a place in the front ranks of bee-keepers the world over. He is, of course, the Dzierzon and Huber of America. His invention of a most practical bee-hive has, especially in America, raised bee-keeping to a very high degree. If I am not wrong, Mr. Langstroth gave his hive to the public in 1852, seven years later than Dr. Dzierzon did his movable-comb hive; but there is no doubt that Mr. Langstroth made his invention without knowing anything concerning what Mr. Dzierzon was doing; otherwise such a Christian man as Mr. Langstroth has always shown himself to be, both in his public and private life, and in his masterpiece, "The Hive and the Honey-bee," would have given honor to whom honor was due. The difference between his hive and that of Dzierzon proved that plainly.

The Dzierzon hive has fixed top and bottom-boards, and two doors (sometimes one) on one or two sides. This hive is longer or higher than wide, according to the standard frames, which are nearly as large as the standard Langstroth frames. If side-storing of the honey is preferred, the Dzierzon hive contains 16 frames side by side in a so-called "lagerstock." On the other hand, the hive has two or more stories in a "staenderstock." All frames in this German hive hang with the shorter sides above and below. Most of the German bee-keepers are of the opinion that bees winter better, especially outdoors, by the use of frames in which the bees may have their winter stores above the cluster.—C. J. H. GRAVENHORST, editor of the Deutsche Illustrierte Bienenzeitung.

A FRENCH TRIBUTE.

Francis Huber, my fellow-countryman, prepared the way by discovering the secrets of the habits of bees; and, fifty years later, Langstroth, in the United States, and Dzierzon and Berlepsch in Germany, crowned those efforts by giving to apiculturists systems of hives which have revolutionized the keeping of bees. But the manner in which the American inventor solved the problem of movable frames and the inspection of colonies, caused it to surpass the German method; and it is his hives and methods which have been adopted in the greatest number of countries, and which give the most brilliant results. I have, for my part, experimented with both systems; and, without contesting certain merits in the Berlepsch model, I give the preference to the American hive, with loose bottom, and stores above.

But it is not alone for his useful invention that the memory of our great Langstroth deserves to be handed down to posterity. He has written an admirable book in which the elevation of the thoughts equal the extent of the writer's erudition as well as the richness of his observations, and which will remain the masterpiece of apicultural literature. Thanks to Mr. Dadant's translation, of which I am preparing a second edition, this work is now known to French-speaking apiculturists; and it has been produced in Russian through the labors of Mr. Kandratieff.—EDWARD BERTRAND, editor of Revue Internationale.

A CANADIAN HONOR.

As a Canadian I am proud and glad that the last public tribute of respect and honor was paid to him, not only on our soil, but amid the classic surroundings of our educational department, where so many busts of departed greatness in literary and philanthropic walks of life are gathered; and I shall take pleasure in moving, at the next meeting of the Ontario Bee-keepers' Association, that permission be sought from the government to add a bust of Langstroth to the collection. I feel sure that permission will be readily granted.—W. F. CLARKE, formerly editor of the American Bee Journal.

A SUBSTANTIAL ENGLISH CONTRIBUTION.

At a banquet in London, given in honor of the American representative to the bee-conventions of Europe, a toast was proposed to the Rev. L. L. Langstroth for his apicultural inventions and genius. Being called upon to respond to the toast, I referred to the misfortune of his poverty, and immediately, in true, large-hearted English style, the whole assembly rose to its feet, cheered his name, and a good contribution was then and there made and sent to Mr. L., to cheer his heart

and clothe and feed him during the approaching winter. There were present, not only representative English and Scotch apiculturists, but many from Continental Europe, and among these there were four or five editors of bee-periodicals. All were of one mind, doing honor to our loved American bee-master, who has just passed through the gates of Paradise.—THOMAS G. NEWMAN, former editor of the American Bee Journal.

FRIEND AND PASTOR SPEAKS.

He had a breadth of culture and of intellect that marked him a man among men. He deserves the respect of all, not alone for his achievements along the line of bee-culture, but for his general ability and high character. This is the estimate of a friend who knew him in his various moods, and never found him other but true and lovable.—REV. W. F. MCCAULEY, Mr. Langstroth's pastor.

HIS WORK WELL DONE.

To-day we know positively that Mr. Langstroth was the inventor of the first practical movable-frame bee-hive. The German top-bar hive, with combs fastened to the side, was a previous invention, as was the close-fitting frame of Major Munn; but neither of these was known to him previous to his own invention, and each was as inferior to his as is the sickle to the self-binder. Mr. Langstroth had the vision to see a great need, and the genius to supply it; and in so doing he shared the honor and glory of very few men—that of revolutionizing a great industry, and changing entirely its methods. He did more than this; he did his work so well, that, though nearly fifty years have rolled by, yet no one has been able in all that time to improve upon his invention in any essential particular. What a compliment to him, that his hive, essentially as it was given to the world half a century ago, is to-day the hive of nearly all our brightest and most successful bee-keepers! No one can gainsay the fact, no one can deny the glory of such an accomplishment. I cannot find a parallel case in all the history of inventions.—PROF. A. J. COOK.

"ONLY THE WAY HE SPOKE."

Talking about being able to hear some voices much easier than others that might be of a higher pitch, he told me of an incident of a deaf woman he was once in his ministry called upon to pray with. He said he had a very strong voice, and that he knelt down close by the side of the woman, and spoke slowly and distinctly; and when he was through, the woman declared that it was the first prayer she had heard in many years; that it was almost miraculous, and she thought her hearing was returning. But he told her no; it was only the way he spoke.—THADDEUS SMITH.

HIS MESSAGE TO THE SUNDAY SCHOOL.

And when he found that it was my official duty to visit all the Sunday-schools in the township in which I live, he, with warm animation, said: "I have a message I want you to take to the boys and girls as you visit your schools: First of all, impress upon their tender hearts, that the Bible is the *very* word of God—the infallible, immutable word of God; that it is the *very* voice of the Holy Spirit speaking to our hearts. Then you can show them the necessity of committing largely of that word to memory. Tell them that they can easily do this when young, and that what they learn when young will stay by them: but what is learned when old is soon forgotten and lost."—S. T. PETTIT.

Proper Spacing of Frames.

In spacing between frames the way the top-bars are now cut by manufacturers of bee-supplies, if spaced $1\frac{3}{8}$ inches from center of top-bar, it leaves a plump $\frac{1}{4}$ -inch between the top-bars, which I think is right. The space between the lower chamber or brood-nest and the upper or surplus chamber should be a little more than $\frac{1}{4}$ -inch. If we could always maintain a plump $\frac{1}{4}$ -inch here, I would like that the best, but as the bodies will shrink a little, in a very dry time, the space has to be made to allow for shrinkage. If after shrinking it would stay that way, it would be all right, but it will swell again in a wet time, so that it is impossible to maintain the space between the lower and the upper chamber just right, but perhaps near enough for practical purposes.—J. W. ROUSE, in Progressive Bee-Keeper.

 Bee-keeping is a science, having for its object the attainment of a correct knowledge of all that pertains to the habits and instincts of these wonderful insects; and a practical art which regards all the attainments thus made as the only reliable basis of successful bee-culture.—NEWMAN.

THIRTY THOUSAND POUNDS BEESWAX

Is our present stock for this year's sales of Foundation. But still **We Want More Beeswax** and pay a good price.

Don't Delay Ordering Your FOUNDATION. You will pay more by and by than you would now. Remember that we make the **BEST**, and everybody acknowledges this.

Now is the time to read the work of the **Late Father Langstroth—**

Langstroth on the Honey-Bee, Revised.

The Price of this Work is now Reduced from \$1.40 to \$1.25, by mail.

Send us your address for Catalogue of Bee-Supplies, etc.

CHAS. DADANT & SON,

HAMILTON, Hancock Co., ILL.

Mention the American Bee Journal.

YOUR BEESWAX!

UNTIL FURTHER NOTICE, we will allow 30 cents per pound for Good Yellow Beeswax, delivered at our office—in exchange for Subscription to the BEE JOURNAL, for Books, or anything that we offer for sale in the BEE JOURNAL. Or, 26 cts. cash.

GEORGE W. YORK & CO.,
CHICAGO, ILLS.



Promptness Is What Counts!

Honey-Jars, Shipping-Cases, and everything that bee-keepers use, **Root's Goods at Root's Prices**, and the best shipping point in the country. Dealer in Honey and Beeswax. Catalogue Free.

Walter S. Ponder
162 Mass. Ave.
INDIANAPOLIS, IND.

Mention the American Bee Journal.

WANTED!

10,000 pounds of **BEESWAX**, for Cash. Address,
LEAHY MFG. CO., Higglsville, Mo.

Mention the American Bee Journal.

WOVEN WIRE FENCE

Over 50 Styles. The best on Earth. Horse high. Bull strong. Pig and Chicken tight. You can make from 40 to 60 rods per day for from 14 to 22c. a Rod. Illustrated Catalogue Free. **KITSELMAN BROS.,** Ridgeville, - Indiana.

48E1t Mention the American Bee Journal.

THE KEYSTONE DEHORNER

Cuts clean on all sides—does not crush. The most humane, rapid and durable knife made. Fully warranted. Highest World's Fair Award. Descriptive Circulars Free.
A. C. BROSIUS, Cochranville, Pa.

36E13 Mention the American Bee Journal.

INCUBATORS

Our 160 page, finely illustrated Combined Poultry Guide and Catalogue will tell you what you wish to know about

PROFITS IN POULTRY
We manufacture a complete line of Incubators, Brooders and Poultry Appliances. Guide and Catalogue 10c. (stamps or silver) **Worth one Dollar.**
Reliable Incubator & Brooder Co., Quincy, Ills.

38E15t Please mention this Journal.



ONE MAN WITH THE UNION COMBINATION SAW

Can do the work of four men using hand tools, in Ripping, Cutting-off, M-tring, Rabbeting, Grooving, Gaining, Dadolng, Edging-up, Jointing Stuff, etc. Full Line of Foot and Hand Power Machinery. Sold on Trial. Catalogue Free.

SENECA FALLS MFG. CO.,
46 Water St., SENECA FALLS, N. Y.
1A1y Mention the American Bee Journal.

33 cts. a Pound

We allow

For Beeswax

In Exchange for **—SUPPLIES.—**

1896 Circular Now Ready.
I. J. STRINGHAM,
105 Park Place, NEW YORK, N. Y.

READERS

Of this Journal who write to any of our advertisers, either in ordering, or asking about the Goods offered, will please state that they saw the Advertisement in this paper.

\$1.00

Sent to me gets \$1.75.

- 1—The American Bee Journal for one year to a new subscriber.
- 2—A 50c. copy of "Business," or How the Seller Reaches and Talks to the Buyer.
- 3—A 25c. copy of the Daily News Almanac for 1896.

I wish a representative in every school and college in the United States. If you wish further particulars inclose in your letter to me a self-addressed and stamped envelope.

E. M. PRATT,
232 South East Ave., OAK PARK, ILL.
Self-Help Supplies.

HATCH Chickens BY STEAM—

With the MODEL

EXCELSIOR Incubator

Simple, Perfect, Self-Regulating. Thousands in successful operation. Lowest priced first-class Hatcher made.
GEO. H. STALL,
114 to 122 S. 6th St. Quincy, Ill.

Mention the American Bee Journal. 40E15

SELLING OUT.

To close out, I offer my Improved Queen-and-Drone Traps per 1/2 doz. in the flat, at \$1.75; per doz., \$2.75; per 25, \$5.00.

Individual Right to manufacture and use, 50 cents; Township Rights, \$1.00; County Rights, \$5.00.

HENRY ALLEY,
1A1tf WENHAM, MASS.

PERSONAL MENTION.

MR. HARRY LATHROP, of Browntown, Wis., reports, in a recent issue of Gleanings, a pleasant visit among bee-keepers in the basswood region of southern Wisconsin. He refers to visiting a web-footed community in a place called Goose Creek, where a preacher by the name of Gander used to preach to the families of Drakes and Goslins. Quack! Quack!

MR. H. M. ORR, of California, has been in Chicago recently, having brought a carload of honey with him. Mr. Orr is one of the few bee-supply dealers and manufacturers on the Pacific Coast. He is also interested in the fruit packing and shipping business. If he is a fair sample of the California bee-keepers, they are a pushing, wide-awake kind of people, with whom it is a pleasure to meet.

MR. S. J. BALDWIN, of England, who has been spending the past few months in the United States, expected to sail for home Jan. 4. He reports that his health has greatly improved by his visit in this country, and that he feels better and happier than when he left his home, last September. He was able to "take in" the Atlanta Exposition, though not so fortunate as to be present at the recent International Bee-Keepers' Congress that was held there.

MISS MATHILDA CANDLER, of Cassville, Wis., made us a very pleasant call lately. She is a successful bee-keeper of about six years' experience, having had some 80 colonies the past year, but reduced them in the fall to 54. Her average per colony, in 1894, was about 120 pounds of comb honey, and in 1895 about 60. Miss Candler is spending a few months in Chicago studying, this winter, and in the spring will return to her bees and again take up the work with them for another season.

MRS. W. E. CLARK, of Bloomington, Calif., is, what Ramber says in Gleanings, "one of these quiet, effective workers" they have out near the Golden Gate. She manages the apiary until the honey is ready to case, when Mr. Clark is called on to "exercise his lifting talent." "From 80 colonies, spring count, which have been increased to 120, Mrs. Clark extracted a carload, or nearly 12 tons of honey" the past season. Surely, Mr. Clark should appreciate such a "sweet" wife!

"A POOR EXCUSE is better than none," 'tis often said. But the latest is given in Gleanings, where Editor Root says he is requested "to say, that, owing to a bronchial trouble, caused largely by the breathing in of the odor of the bees, and their poison," the publisher of a periodical that was to improve our degenerated bee-literature, "has been obliged to suspend the publication of his paper." One of our correspondents, in referring to this in a private letter, wrote thus:

"Alas for the elevation of bee-literature! He must have been wintering his bees under his office, and the fumes of poison came up so strongly that it strangled the poor little paper!"

Concerning the departed so-called bee-paper, Father Langstroth has been reported to have said this, when attending the Toronto convention last September: "It contains more vigor, force and truth than all the other journals." If he uttered those words, all we can say is, that it is the only thing so far reported since that convention that leads us to think he was again suffering from a very severe attack of his old "head-trouble" at that time. We don't believe Father L. had been physically or mentally able to read the bee-papers sufficiently close the past two years, to be a competent judge in the matter. Surely his quoted sentence proves this.

READERS Of this Journal who write to any of our advertisers, either in ordering, or asking about the Goods offered, will please state that they saw the Advertisement in this paper.

California

If you care to know of its Fruits, Flowers Climate or Resources, send for a Sample Copy of California's Favorite Paper—

The Pacific Rural Press

The leading Horticultural and Agricultural paper of the Pacific Coast. Published weekly, handsomely illustrated, \$2.40 per annum. Sample Copy Free.

PACIFIC RURAL PRESS,
220 Market St., - SAN FRANCISCO, CAL.



SUCCESSFUL INCUBATOR
Our magnificent new catalogue giving full information regarding artificial Hatching & Brooding and treatise on poultry raising sent for 4c stamps. Circular free.

Write now, Des Moines Incubator Co., Box 78 Des Moines, Ia.

49A13t Mention the American Bee Journal.

Golden's Feeder!

BEE-KEEPERS—We can furnish the **Golden Combined Feeder and Hive-Cover**, without Feed Dish [as the Simplicity or any dish answers], direct from factory at the following prices: 1 made up, 30 cents; 1 in the flat, 25 cents; 10 in the flat, \$2.00. All orders sent to The A. I. Root Co., Medina, Ohio.

For large orders, write the undersigned for special prices. **J. A. GOLDEN,**
45A13t REINERSVILLE, OHIO.

Mention the American Bee Journal.



OUR POULTRY ANNUAL
and Book of Valuable Recipes, 64 large pages, contains 8 beautiful colored plates of fowls, gives description and prices of 45 varieties, with important hints on care of poultry, and pages of recipes of great value to everyone. Finest Poultry Book published for 1896. Postpaid only 10c. **C. N. BOWERS,** Box 24, Dakota, Ill.

52A1 Mention the American Bee Journal.

TRY US. We sell your Poultry, veal, Fruits and all produce at high est prices. DAILY RETURNS. For stenoids, prices and references, write to T. SAGE & SONS, 153 Reade St., N. Y.

WHEN ANSWERING THIS ADVERTISEMENT, MENTION THIS JOURNAL.

PATENT WIRED COMB FOUNDATION



Has No Sag in Brood-Frames
Thin Flat-Bottom Foundation
Has No Fishbone in the Surplus Honey.

Being the cleanest is usually worked the quickest of any Foundation made

J. VAN DEUSEN & SONS,
Sole Manufacturers,
Sprout Brook Montgomery Co., N. Y.

Mention the American Bee Journal.

COMB FOUNDATION.

Wholesale and Retail.

Quality always the best. Price always lowest.

Working Wax into Foundation by the lb. a Specialty. I can make it an object for you in any quantity, but offer special inducements on straight 25 or 50 lb. lots. Or for making large lot of Wax into Foundation. I am furnishing large Dealers, and can also please you, **Bee-wax taken at all times.** Write for Samples and Prices, to

GUS DITNER, AUGUSTA, WIS.
Reference—Augusta Bank. 16A1f



NEW MAMMOTH
Poultry Guide for 1896 Finest book ever published, contains nearly 100 pages, all printed in colors, plans for best poultry houses, sure remedies and recipes for all diseases, and how to make poultry and gardening pay. Sent post paid for 15c. **John Bauscher, Jr.,** box 94 Freeport, Ill.

49A13t Mention the American Bee Journal.

General Items.

Apiary Near a Railroad.

On page 794 the question is asked whether it would be good policy to locate an apiary near a railroad. I located my apiary here in Chippewa Falls, in 1888, and have had from 50 to 100 colonies ever since (7 years) within 125 feet of the Wisconsin Central, Northern Pacific, and Milwaukee and St. Paul railroads, whose heaviest freights, limited passenger coaches, and fast cattle trains are passing all the time, night and day; and although I have watched very closely, in winter especially, when the ground trembles, still I have never been able to see any disturbance or notice taken of it. I am satisfied that no harm has ever been done my bees by passing trains.

E. A. MORGAN.
Chippewa Falls, Wis., Dec. 15, 1895.

Non-Swarming Bees—Fair Season.

There has been a good deal said lately both for and against the breeding of a strain of non-swarming bees. Well, I won't say whether it would be better to have such or not; but this I do know, that I have not had a swarm for the last six years; but the reason for that (at least I think so) is, I use a fairly large hive, 12x12x18 inches, inside measure, and by putting on the super at the proper time I have been successful in keeping down swarming. If I want increase, I divide.

My bees did fairly well the first part of the past season, but dry weather cut the crop short. My average was 50 pounds per colony. But on account of later rains they gathered enough for winter.

JNO. MCKIMMIE.
Niagara, Ont., Dec. 16, 1895.

Poor Season—Likes Hybrid Bees.

My bees are in the cellar in apparently good condition. The past was a very poor season for bees here. In the fall of 1894 I placed 57 colonies in the cellar, and took 56 out alive last April. They dwindled down to 52 at the commencement of the honey harvest. I had one prime swarm issue, but still they decreased to 51 colonies for winter. My report for 1895 is as follows: From 52 colonies at the commencement of the harvest, I took about 600 pounds of honey, mostly extracted, and had 51 colonies for winter. Friday, Nov. 29, the bees had a good flight, and Saturday, Nov. 30, they were put into the cellar, and appeared to be in good condition. I like the hybrid bees. My best hybrid colony stored 105 pounds of surplus extracted honey this year.

CHAS. B. ALLEN.
Central Square, N. Y., Dec. 3, 1895.

Breeding Out the Swarming Habit.

I have read a good deal about "breeding out the swarming habit." I hardly think it would be any more desirable than swarming out the breeding habit in the human or animal races. Doubtless it would be an advantage to the world could we do this in degenerates of the races, but there is always "the survival of the fittest" to counterbalance a too great increase of scrubs.

I think controlling swarming the only remedy, and that with every precaution sometimes fails. By having queens clipped, tends to discourage swarming. Worker foundation (full sheets) in brood-frames reduces drone-production to a minimum, and careful examination of frames, removing queen-cells and dividing the colonies at the commencement of active breeding, will to a great extent prevent swarming. I believe if the queen is given to a nucleus, and a new tested, clipped queen purchased from a reliable queen-rearer given to the old

colony, not once in a hundred times will either of them cast a swarm.

I omitted to say, put the nucleus on the old stand, with the original number of the hive. I would advise numbering with movable tags, by keeping the old number with the queen; and by keeping a regular hive diary you always know the age of the queen, and you can easily tell when it will be best to supersede her.

Those who keep bees for honey will find it profitable to buy from regular queen-rearers instead of losing about four weeks in securing a fertile queen, and then possibly, however good the original stock, the chances are she may have mated with a mongrel, and the honey season will be past, and so surplus, and a necessity of feeding the colony for winter stores.

As to clipping queens—how can it destroy their, or their offspring's, physical power? I know of a number of families at least one parent of each having lost an arm or leg by amputation; the children are as vigorous as those of other parents completely limbed. In one family of my acquaintance, both parents are deaf and dumb; they have two bright little girls who can laugh and talk as well as other children of their age. The parents lost their faculties in their youth—not after becoming mature, as in the case of queens.

B. F. ONDERDONK.
Mountain View, N. J., Nov. 20.

An Experience in Selling Honey.

The editor's remarks on "Selling Honey on Commission," on page 764, sounds like a "fish story." Several years ago I sent a Chicago firm some honey from Waverly, N. Y. In a few days they wrote me that the honey was in bad condition—broken, and running all over the room. I sent a dollar or two to the then editor of the American Bee Journal, and asked him to look the matter up. He kindly sent a man there, and his report was much the same as theirs. I wrote them to close it out at once.

After two or three months they made returns for it, and, very strange to say, I was well satisfied; the weight was about what it was when I left Waverly. How could that be, if the honey run so badly? If they had only reported about 3/4 of the weight, I should have believed all. As it was, I think they keep broken honey on hand all the time to work a game on shippers. Well, they returned me about half-price. I lost about \$20. I started to collect of the express company, but it sold out just about that time, and after I got the "returns," I was satisfied my honey was not broken.

Lockwood, N. Y. J. H. ANDRE.

Preparing for Apiary Thieves.

On page 739, this question is asked: "What method would you take to catch a thief that felt free to visit your apiary and slip out a comb here and there when you were absent from home?"—PARSONAGE APIARY.

Thieves are, as a rule, a very hard set of critters to catch, but if they are like the ones we have in this section, perhaps I can assist the "Rev." gentleman. I have lost very heavily this season by thieves, but I have found a remedy. In the first place, I set my bees in a square of about 1/4 acre, one side facing my home; and on the four corners I set up posts about four feet from the line, and eight feet high; then run a heavy wire on the top of the posts around three sides of the enclosure. On the three sides I put rings on the wire, and fastened a vicious dog, so the dog was tied and still could guard one side of the apiary. On the other two sides ditto. Then I keep a good dog at the house, so I am practically safe.

Some people may object to so many dogs of that character, and a thief, but between two evils always choose the lesser.

Now, for the benefit of the thief, I will give my experience with weak colonies. Last fall I had a late swarm; I had no honey to spare, and was taken sick, so I did not see them until Nov. 1, and at that time

WINTRY WEATHER WEAKENS

the system, lowers the vitality, and decreases the power of resistance against colds and chills. Many people are feeling weak and shivery just now. They complain of cold hands and feet. Their blood doesn't circulate properly; the raw, bleak air seems to go right through them. Others feel worn out, and lack vigor. They are bilious, nervous, have backaches, headaches, and a pale, sallow complexion. All these symptoms indicate that the liver and kidneys are out of order. Feeble circulation of the blood shows that the system is in a very low condition. People who feel like this are facing some dangers they little suspect.

LOOK OUT

for pneumonia, influenza, or some other dangerous complaint when you are in this state!

If you have any of these symptoms, and are not feeling as well as you ought to feel, do not wait until you are laid up with a serious illness. Act at once. Take something that will build up the system, put the blood in healthful motion, and act on the liver and kidneys. Prevention is better than cure.

There is only one way to get well. There is only one remedy that can make you well. The remedy you need is Warner's Safe Cure which is recommended and prescribed by physicians throughout the world. This great remedy contains the vital principle essential to the maintenance of health and strength. It increases the muscular energy, fortifies the system and builds up every part of the body. It has never been equaled as a cure for liver and kidney complaint, bladder trouble or Bright's disease. It is the great standard remedy, the best remedy, the most reliable remedy known to medical science. Every one who has ever tried it, believes in it.

If your health needs attention, do not experiment with inferior remedies. It is cheaper and wiser to take a remedy that has earned a world-wide reputation, which has stood the test of years, and has proved, in millions of cases, that it can always be depended upon to relieve and cure.

IF YOU WANT THE

BEE-BOOK

That covers the whole Apicultural Field more completely than any other published. send \$1.25 to Prof. A. J. Cook, Claremont, Calif., for his

Bee-Keeper's Guide.

Liberal Discounts to the Trade.

The Rural Kansan

Is an Agricultural Journal for the busy farmer. It embraces Bee-Keeping and every department of industry connected with the farm. 30 cts. a year, monthly. Sample Free.

A Full Line of **Higginsville Bee-Supplies** on hand.

CATALOGUE FREE.

HENRY L. MILLER,

355 Shawnee Ave., TOPEKA, KAN.
1A13t Mention the American Bee Journal.

there was no stores for them, so I put a feeder on top—a common box-feeder—and packed them down in leaves. I put about 12 inches of leaves on top of the feeder, and packed the sides the same as I did for winter. Then I fed sugar syrup till the first of the year, then on each warm day I fed warm syrup, and, as a result, in the spring that was my strongest colony, and the first to swarm. So, my dear brother, never be tempted to steal what a little care can give you.

I hope that our unfortunate brother may read this letter and profit thereby.

Tarentum, Pa. E. C. CULBERT.

A Young Bee-Keeper's Report.

I have been keeping bees for three years in frame hives. This has been a hard year here for bees, and also for their keepers. I had to feed for winter stores. I have 14 colonies in fair condition. I got a warranted queen from a Missouri breeder, and she is a beauty, but what robbers, stingers, and swarmers they are!

The old American Bee Journal is a friend indeed. I am glad that the editor gives the boys a chance. I am one of them.

J. W. HOLDER.

Hebbertsburgh, Tenn., Nov. 26, 1895.

The Season in New Hampshire.

Bees in this locality did fairly well the first part of the season. They built up well in the spring, and gave a good increase. The latter part of the season they barely held their own, so we had to feed for winter.

In preparing my bees for winter, I reduced 43 colonies to 25, by uniting. I fed sugar syrup till each colony had 30 pounds of stores. Those that were not in chaff hives I put into outer cases packed with planer shavings. I put a thick porous cushion over the frames. I leave the entrance open, shading it with a board leaning against the hive, removing it whenever it is warm enough for the bees to fly. My bees, prepared in this way, have wintered without loss the last three or four winters.

J. P. SMITH.

Sunapee, N. H., Dec. 5, 1895.

Only the Second Poor Crop Year.

I cannot well do without the American Bee Journal. I have kept bees here since 1878, and this is my second year to fail of getting a good crop. I lost 15 colonies last winter, by freezing and starving, although they had plenty of stores. My 30 colonies remaining, increased to 60, but gave only 400 pounds of surplus honey. The asters failed to bloom in September as usual; they always give us a large amount of honey. There are about 400 colonies of bees in our immediate vicinity, 250 of which have sprung from my stock, as I am always trying to get my friends "into trouble" by getting them to keep bees, and I have had fair success in that direction, for this year we are all in the same fix—very little honey. But I console myself by knowing that I have done some good and have gotten persons to keep bees and eat honey who always claimed they had no use for either. Success to the Bee Journal for the year 1896!

C. A. HAINES.

East St. Louis, Ill., Dec. 16, 1895.

Please Send Us the Names of your neighbors who keep bees, and we will send them sample copies of the BEE JOURNAL. Then please call upon them and get them to subscribe with you, and secure some of the premiums we offer.

Dr. P. C. Gress, of Atchinson, Kans., would like to communicate, confidentially, with all persons who have consigned honey to C. R. Horrie & Co., of Chicago, Ill., with unsatisfactory results.

\$3.00 Worth for \$2.00!

Until further notice, we propose to give you a chance to get some good reading-matter for the long winter evenings, at half price.

Send us \$2.00, and we will mail you your choice of \$2.00 worth of the following book-lets, and also credit your subscription to the American Bee Journal for one year:

Poultry for Market and Profit.....	25c
Our Poultry Doctor.....	30c
Turkeys for Market and Profit.....	25c
Capons and Caponizing.....	30c
Rural Life.....	25c
Preparation of Honey for the Market.....	10c
Bee-Pasturage a Necessity.....	10c
Hive 1 Use, by Doolittle.....	5c
Foul Brood, by Dr. Howard.....	25c
Foul Brood, by Kohnke.....	25c
Foul Brood, by Cheshire.....	10c
Bee-Keeping for Profit, by Dr. Tinker.....	25c
Kendall's Horse-Book—Eng. or German.....	25c
Silo and Silage, by Prof. Cook.....	25c
Hand-Book of Health, by Dr. Foote.....	25c
Maple Sugar and the Sugar Bush.....	35c
Potato Culture, by Terry.....	40c
Carp Culture, by Root & Finney.....	40c
Strawberry Culture, by Terry & Root.....	40c
Bienen Kultur, by Newman [German].....	40c
Winter Problem in Bee-Keeping [Pierce].....	50c
Bee-Keepers' Directory, by Henry Alley.....	50c
Advanced Bee-Culture, by Hutchinsonson.....	50c
5 Honey as Food and Medicine.....	25c

GEORGE W. YORK & CO.,

CHICAGO, ILLS.

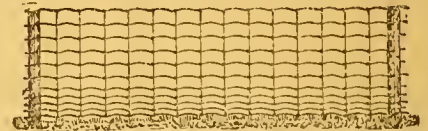

None So Blind as Those Who Will Not See!

Said a fence maker to a wire maker, "Of course that 'spring steel' in the 'Page' is all bosh." "Don't fool yourself," said the W. M. "We make train loads of Page wire and we couldn't give them the wire we sell you."

PAGE WOVEN WIRE FENCE CO., Adrian, Mich.

Mention the American Bee Journal.

Convention Notices.

WISCONSIN.—The annual meeting of the Wisconsin State Bee-Keepers' Association will be held Thursday and Friday, Feb. 6 and 7, 1895, in the capitol building at Madison. The program will appear in due time.
Platteville, Wis. N. E. FRANCE, Sec.

EAST TENNESSEE.—The Southern East Tennessee Bee-Keepers' Association will hold a special meeting at Cookson's Creek, on Saturday, Jan. 11, 1896, beginning at 9 a.m. An interesting time is expected. All are invited to attend, and especially those interested in apiculture.
W. J. COPELAND, Sec.
Fetzeron, Tenn.

The Special Meeting of the Illinois State Bee-Keepers' Association will be held in Chicago, at the New Briggs House, northeast corner of Randolph St. and Fifth Ave., on Thursday and Friday, Jan. 9 and 10, 1896—the week of the National Cycle Show—when excursion rates will be given on the certificate plan—for 1½ fare for the round trip. Certificate must be secured at the starting point, or no reduction will be granted on return. Before return ticket is secured, certificate must be signed by the Secretary of the Cycle Exhibition Company, and filed by the joint agent of the railway lines, whose offices will be in the Exhibition Building. Tickets to Chicago may be purchased (and certificate taken), on any day between Jan. 1 and 11, and the return trip commenced on any day between Jan. 4 and 15. Chicago hotel rates are 75 cents each, per night, two in a room; \$1.00 if one in a room. Meals extra—pay for what you order, or go elsewhere for meals, if preferred.
Bradfordton, Ill. JAS. A. STONE, Sec.

The Wooden Hen is the title of a small pamphlet issued by Geo. H. Stahl, of Quincy, Ill., which describes what he calls "something new and novel for the boys." Of course, it is in the line of incubators, which he manufactures. Send your name and address to him for a copy of the pamphlet. His advertisement you will find in this number of the Bee Journal.

Honey & Beeswax Market Quotations.

CHICAGO, ILL., Dec. 10.—White clover and Linden, in 1-pound sections, sells at 14@15c., but other kinds of white honey sell at 12@13c.; dark and amber grades, 9@10c., of which there is a very liberal supply. Extracted, white, 5½@7c.; amber, 4½@5c.; dark, 4@5c. difference in price of each grade being in accord with its quality. fine flavor always being at a premium. Beeswax, 28@30c., and selling upon arrival. R. A. B. & Co.

CINCINNATI, OHIO, Dec. 20.—Demand for comb and extracted honey is fair only. We quote: Comb honey, 12@14c. for best white, in the jobbing way. Extracted, 4@7c. Beeswax is in good demand at 22@27c. for good to choice yellow. C. F. M. & S.

NEW YORK, N. Y., Dec. 18.—The market on comb and extracted honey is a little dull at the present time, and we do not expect to have a very great demand until after the holidays. Then we may look for a little better sale, but the bulk of trade is done for the season. That is for comb honey; extracted we expect quite a sale of after Feb. 1, 1896. We quote: Fancy clover, 1-lbs., 15@16c.; white clover, 13@14c.; fair white, 11@12c.; buckwheat, 9@9½c. Extracted clover, 6@6½c.; basswood, 6½@7c.; buckwheat, 5c. Beeswax firm and in good demand at 29@32c. C. J. & B.

KANSAS CITY, Mo., Dec. 21.—The demand for comb and extracted honey is fair. We quote: No. 1 white, 1-lbs., 13@14c.; No. 2, 12@13c.; No. 1 amber, 12@13c.; No. 2, 8@10c. Extracted, white, 6@6½c.; amber, 5@5½c.; Southern, 4@4½c. Beeswax, 22@25c. C. C. C. & Co.

PHILADELPHIA, PA., Dec. 9.—Honey has steadily advanced in this market. Comb honey sells quickly and pure white clover extracted sells on sight. We quote: Fancy comb, 16c.; choice, 14@15c.; dark, 10@11c. Extracted, 5@6c.; Western white clover, 10c. Beeswax finds immediate sale on arrival at 30c. W. A. S.

NEW YORK, N. Y., Dec. 9.—We have a fairly good demand for white comb honey at 12@15c., according to quality and style of package. While the market is well cleaned up of glassed sections and paste-board cartons, unglazed is plentiful, having just received two more big cars from California. Buckwheat comb is very dull, with a plentiful supply. We quote 9@10c. but to effect sales on quantity lots, we find it necessary to shade quotations. Considering the limited outlet and large stocks on the market, we would not encourage shipping of buckwheat honey for the near future, as we could not render returns in reasonable time. The market on extracted is quiet at unchanged prices. No demand for buckwheat as yet. Beeswax is scarce and selling at 29@31c., according to quality. H. B. & S.

ALBANY, N. Y., Nov. 9.—Our honey market is in good shape, although prices, like on most all products, are not high; but receipts are lighter than last year, and there is a good, steady demand, with a real scarcity of white honey. We quote: White clover, 15@16c.; mixed clover, 12@14c.; dark clover, 9@11c. Extracted, white, 6½@7c.; mixed, 5½@6c.; dark, 5@5½c. H. R. W.

Question-Box.

In the multitude of counsellors there is safety.—Prov. 11-14.

Percolated vs. Boiled Syrup for Feeding Bees.

Query 2.—Of late a good deal has been said about feeding bees sugar and water, equal quantities (for winter stores or to keep them from starving), by means of the crock-and-plate method or some kind of percolating feeder. Do you think this is better or worse than the plan of boiling syrup to feed?—MINN.

P. H. Elwood—Worse, much worse.

Dr. C. C. Miller—Ever so much better.

W. R. Graham—I think this all-sufficient.

Mrs. L. Harrison—I never tried "percolating."

Jas. A. Stone—I cannot tell, for I have never tried it.

R. L. Taylor—Worse. There is too much fussing and remains of sugar.

I have not done any feeding for five years, so I have not tried the percolating process.

Dr. J. P. H. Brown—I don't know that it is any "better or worse"—it is as good—with less bother.

E. France—When we feed sugar we make syrup by boiling. I have never tried any other way.

J. M. Hambaugh—I have never fed boiled syrup to bees, hence I am not authority as to the best.

W. G. Larrabee—I have never tried the percolating feeder, but my opinion is that it is just as good.

Rev. E. T. Abbott—I do not know. I do not feed that way. If I did, I should prefer to heat the syrup.

Engene Secor—I have not tried it. Fortunately my bees have always been able to "board themselves."

H. D. Cutting—When I have occasion to feed, I pour boiling water on sugar, and feed with a good feeder.

B. Taylor—I do not know. I know cooking the feed works well. I don't know out the cold-water method is equally good.

C. H. Dibbern—When it becomes necessary to feed for winter stores, it is less trouble to prepare the food in the manner described, and all danger of scorching, etc., is obviated.

Mrs. J. N. Heater—I have never tried the cold sugar and water plan, but I think the tendency for such feed to harden in the cells would be much greater than if cooked.

Rev. M. Mabin—I have had no experience in feeding bees in the way indicated in the question, and am not prepared to answer; but I think I would prefer "the good old way."

Prof. A. J. Cook—I think it the best plan I have ever tried in case I wish to feed sugar. If we wish to feed honey, I prefer the White feeder, as described in my "Bee-Keepers' Guide," only I now use it the full size of the top of the hive.

Allen Pringle—I have had no experience with the "crock-and-plate" method, and but very little with any other method of sugar-syrup feeding. Don't

believe in it. I prefer to winter my bees on honey, for various reasons; and to give them so much in the fall that they will, as a rule, have plenty in the spring, and with good queens, and no "stimulative feeding."

J. E. Pond—Having never tried this plan of feeding, I am not competent to speak as to its value. It is a new matter, comparatively, and I question whether it has been tested sufficiently as yet, for any one to give a valuable opinion.

J. A. Green—When the season and weather will permit, I prefer to feed a syrup made by stirring sugar into cold water. When it is necessary to feed a thicker syrup—as when feeding for winter stores late in the fall—I make it by boiling.

G. W. Demaree—Don't waste time with sour "percolating" traps. Make your syrup with sugar and hot water (sugar is already cooked); make it rather thin, and let it set in a warm room for a day or so before feeding. Or, what is the easiest way of feeding bees, make soft candy, by mixing soft coffee A sugar with melted honey; pack in a shallow box, and when the candy has stood long enough to "set," turn it over a hole in the quilt and cover up warm.

DO YOU WASH DISHES?

No need of it. The Faultless Quaker will do it for you and save time, hands, dishes, money, and patience; no scalded hands, broken or chipped dishes, no mums. Washes, rinses, dries and polishes "quickly. Made of best material, lasts a lifetime. Sell at sight. Agents, women or men of honor desiring employment may have paying business by writing now for descriptive circulars and terms to agents.

The QUAKER NOVELTY CO., Salem, O.

Mention the American Bee Journal 39A26T

WANTED.

10,000 pounds of BEESWAX, for Cash. Address, LEAHY MFG. CO., Higginville, Mo.

THE OLD RELIABLE PEERLESS FEED GRINDERS



Grinds more grain to any degree of fineness than any other mill. Grinds ear-corn, oats, etc., fine enough for any purpose. Warranted not to choke. We warrant the Peerless to be THE BEST AND CHEAPEST MILL ON EARTH. Write us at once for prices and agency. There is money in this mill. Made only by the JOLIET STROWBRIDGE CO., JOLIET, ILL. Jobbers and Manufacturers of Farm Machinery, Carriages, Wagons, Windmills, Bicycles, Harness, etc. Prices lowest. Quality best.

Mention the American Bee Journal 34A26

MUTH'S HONEY EXTRACTOR PERFECTION Cold-Blast Smokers, Square Glass Honey Jars, Etc.

For Circulars, apply to CHAS. F. MUTH & SON, Cor. Freeman & Central Aves., Cincinnati, O. Send 10c for Practical Hints to Bee-Keepers.

List of Honey and Beeswax Dealers.

Most of whom Quote in this Journal.

Chicago, Ills.

J. A. LAMON, 43 South Water St.
R. A. BURNETT & Co., 163 South Water Street.

New York, N. Y.

F. I. SAOE & SON, 183 Reade Street.
HILDRETH BROS. & SEGLKEN,
120 & 122 West Broadway.
CHAS. ISRAEL & BROS., 486 Canal St.

Kansas City, Mo.

C. C. CLEMOMS & Co., 423 Walnut St.

Buffalo, N. Y.

BATTERSON & Co., 167 & 169 Scott St.

Hamilton, Ills.

CHAS. DADANT & SON.

Philadelphia, Pa.

WM. A. SELSER, 10 Vine St.

Cincinnati, Ohio.

C. F. MUTH & Son, cor. Freeman & Central avs.

Getting Ready For 1896!

We are now prepared to furnish in any quantity, at the very lowest prices—EXTRACTORS, SMOKERS, and EVERYTHING used by the wide-awake bee-keeper. We shall continue to make our FALCON POLISHED SECTIONS, which are yet unequalled. If you've never used any of our Goods it is time for you to do so. They are acknowledged to be unsurpassed by any other make. Our large new Catalogue will be out early in the year. Anything you want now? Write to us. Goods and Prices guaranteed to be satisfactory.

Address,
THE W. T. FALCONER MFG. CO.,
JAMESTOWN, N. Y.

Handy Cobbler \$2.00

Family Shoe Repair Kit. 28 Articles

With Soldering Materials.

Bought singly would cost \$4.70.

\$3 Outfit Includes

Harness Repair Tools

38 articles, worth singly \$6.70.

Sent by Express or Freight, Ills.

Catalogue free. Agents wanted.

KUHN & CO. Box 66 Moline, Ill.

41A26 Mention the American Bee Journal.



TAKE NOTICE!

BEFORE placing your orders for SUPPLIES, write for prices on 1-Piece Basswood Sections, Bee-Hives, Shipping-Crates, Frames, Foundation, Smokers, etc.

PAGE & LYON MFG. CO.
NEW LONDON, WIS.

Fine Basswood, White Sage or Alfalfa

EXTRACTED HONEY

—For Sale.—

We have made arrangements whereby we furnish California White Sage or Alfalfa Extracted Honey, in 60-pound tin cans, on board cars in Chicago, at these prices: 1 can,

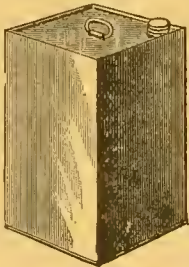

in a case, 8½ cents per pound; 2 cans in one case, 8 cents; 4 cans (2 cases) or more, 7½ cents.

The Basswood Honey is all in kegs holding 170 pounds, net. It is a very superior quality, and the prices are: 1 keg, 8½ cents per pound; 2 kegs or more, 8 cents. Cash MUST accompany each order.

A sample of either kind of honey will be mailed to an intending purchaser, for 10 cents, to cover postage, packing, etc. We guarantee purity, and that what we ship will be equal to sample.

Now it seems to us that here is a splendid chance for any bee-keeper to supply his home demand after his own crop is all sold. Or, why not begin now to create a local honey-trade? Order one 60-pound can first, and start out among your neighbors and friends, and see what you can do. You ought to get at least 15 cents per pound in 5-pound lots, or 50 cents for 3 pounds. Some may be able to do even better than that, though we think that enough ought to be sold at these prices to make a fairly paying business out of it. Give it a good trial. Push it. It may grow into a nice winter's work for you.

GEORGE W. YORK & CO.,
CHICAGO, ILLS.

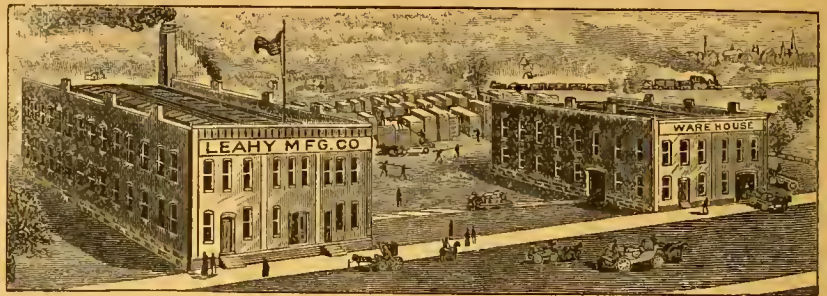

Largest Factory in the West COMPLETE STOCK. Good Supplies and Low Prices. Our Motto.

READ THIS—Mr. Keyes says: The 100 pounds of Extra-Thin Foundation you sent us is superior to anything he ever saw; and I think the same. R. L. TUCKER, Wewahitchka, Fla.

Dear Sirs:—The Sections came duly to hand. Indeed, they are very nice. Yes, sir; they are as good as the best. CHARLES H. THIES, Steeleville, Illinois.

Leahy Mfg. Co.:—I have received the bill of goods. I must say they are the choicest lot of Hive-Stuff I have ever received from any place. I admire the smoothness of your work, and your close selection of lumber. Yours very truly, O. K. OLMSTEAD, Orleans, Nebr.

Dear Sirs:—The Sections arrived in due time, and are all O. K. so far as examined. They are simply perfection. I can't see how you can furnish such goods at such low prices. I hope you may live long and do well. Yours respectfully, Z. S. WEAVER, Courtney, Tex.

Gents:—I received the "Higginsville Smoker" all O. K. It's a dandy; please find enclosed stamps for another. Yours truly, OTTO ENDERS, Oswegathe, N. Y.

Gentlemen:—I have bought Supplies from nearly all the large manufacturers by the carload, and I must say yours are as good as the best. Indeed, in many lines they are the best. It is a pleasure to handle them. E. T. FLANAGAN, Belleville, Illinois.

The above unsolicited testimonials are a fair sample of hundreds we receive. Our prices are reasonable and the "Higginsville Goods" are the best.

We are now manufacturing for each of the following parties a Carload of Supplies: E. T. Flanagan, Belleville, Illinois; Charles H. Thies, Steeleville, Illinois; J. W. Rouse & Co., Mexico, Mo.; Henry Miller, Topeka, Kans.; Fulton & Gregg, Garden City, Kans.

If you need a Carload of Supplies, or only a Bee-Smoker, write to us. Remember, we are here to serve you, and will, if you give us a chance. A Beautiful Catalogue Free.

Address, **LEAHY MANUFACTURING CO., HIGGINSVILLE, MO.**

49A Mention the American Bee Journal.

SECTIONS, BEE-HIVES, SHIPPING-CASES

We make a Specialty of these Goods, and defy Competition in

QUALITY, WORKMANSHIP AND PRICES.

Write for Free Illustrated Catalogue and Price-List.

G. B. LEWIS COMPANY, Watertown, Wis.

Be sure to mention the American Bee Journal when you write.

1895 SAVE MONEY 1895

If you want first-class **ITALIAN QUEENS FOR BUSINESS, Foundation at Wholesale Prices, Hives,** suited for the South, or **SUPPLIES,** send for Price-List—to

J. P. H. BROWN, AUGUSTA, GA.

Mention the American Bee Journal.

Will Exchange—Concord Grapevines for Fruit, Grain or offers.

50A **F. C. Morrow, Wallaceburg, Ark.**

Mention the American Bee Journal.

Poultry.—Any one wishing to become proficient in the handling of poultry, should send 10 cents, in stamps, to Des Moines Incubator Co., Box 78, Des Moines, Iowa, for their book of Practical Poultry-Keeping.

The Patent Wood Veneer FOUNDATION

has no sag in full sheets. EXTRA THIN Foundation 13 square feet to the pound. Working Wax into Foundation—if sent to me—a specialty. Send for prices, samples & Catalogue. Wax wanted. **AUG. WEISS,**

2A5t HORTONVILLE, WIS

Mention the American Bee Journal.

* ROOT'S COMB FOUNDATION! *

New Product.

New Process.

A Big Success

We are pleased to announce that, having secured control of the new Weed process of manufacturing foundation for the U. S., we are prepared to furnish **Foundation by the New Process,** for 1896. Samples will be mailed free on application, and will speak for themselves.

OUR SANDED and POLISHED SECTIONS, well, they will speak for themselves, also.

Our 1896 Catalog

will be ready for distribution now in a few days. Send in your name at once for catalog, samples of the new foundation, and those superb sections, and while you are about it ask for late copy of **Gleanings in Bee-Culture.**

THE A. I. ROOT CO., MEDINA, OHIO.

56 5th Ave., Chicago, Ill.

Syracuse, N. Y.

1024 Mississippi St., St. Paul, Minn.

AMERICAN BEE JOURNAL

DEVOTED EXCLUSIVELY TO THE INTERESTS OF HONEY-PRODUCERS

ESTABLISHED IN 1861
THE OLDEST BEE-PAPER IN AMERICA

Published Weekly, at \$1.00 per annum.

Sample Copy sent on Application.

36th Year.

CHICAGO, ILL., JAN. 16, 1896.

No. 3.



Bees Eating in Winter Quarters.

BY D. W. HEISE.

What a whole-hearted bee-keeper Mr. Cotton is. On page 783 (1895), he already asks me to forward that pig-tail; and not the tail only, but the whole carcass clear up to the ears! Verily, Mr. Cotton knows a good thing when he sees it! But he wants me to send the premium before he has complied with the conditions upon which it was offered. He wants me to make the experiment, and determine for myself whether his contention is founded on facts, or merely theory. I am not at all anxious to make the experiment, which he outlines for me, just at present, because I never like to disturb my bees after they have "gone to bed" for their long winter's repose, except in cases of extreme necessity. In the meantime "let us reason together" a little in a friendly way, for I am sure neither of us want to quarrel, much less fight, over this matter. And if we did, it would not be possible for us to injure each other very seriously, knowing that we are about 1,000 miles apart; and more than that, we are bee-keepers, and supposed to be good-natured.

I presume, from the certainty with which Mr. Cotton affirms that his statements are correct, that he has an experiment similar to the one he outlined for me. If so, please let us have all the facts and figures in connection therewith, and perhaps that will satisfy me, and victory may yet perch on his banner.

Now here are a few thoughts which will perhaps enable us to get at the facts in the case without much laborious experimenting: Is it not accepted as an established fact, by all experienced bee-keepers, that bees will consume more food when wintered on the summer stands, than when wintered in the cellar? but yet they do consume honey when in the cellar. But, according to Mr. C's theory, they would not, because they do not, and cannot, fly out from the time they are put into it in the fall, until they are taken out in the spring.

Again, what is it, I ask, that causes the difference in honey consumption, with wintering in the cellar or out-doors—is it only from the fact that the temperature is more uniform, and therefore they keep more quiet? or is it not also reasonable to suppose that they have to consume more food when in a low temperature in order to keep up animal heat? Now if the latter supposition figures in the difference—and I truly believe it does—how would they keep up animal heat without any nourishment for three or four months of confinement in a low temperature?

It is too generally supposed by bee-keepers in this country—I do not know whether upon good authority or not—that bees must have access to food every four or five days in cold weather in order to sustain life; and I have had several instances to come under my notice during my short bee-keeping experience, which, if it does not thoroughly prove the matter,

it certainly goes a long way towards showing that my supposition is well founded. For instance, during the month of February, 1895, on a fine day when some bees were flying from all the hives except one, wanting to know what was wrong, I listened at the entrance after tapping upon the hive. No response; all was still as death; and upon lifting the cap, such was really the case. Now, I would ask Mr. Cotton, what was the cause of this colony's death? He may say disease; but I say no, for there were no perceivable signs of disease—the combs were clean and dry; no spotting of hive, etc.; but they were dead. He may say they froze. I cannot swallow that, either, for I am not the only one who will tell you that a healthy colony of bees will withstand almost any degree of



Mr. Adrian Getaz, Knoxville, Tenn.—See page 41.

cold, providing they keep dry and have free access to good honey. Then why did they die? Why, bless your heart, they starved to death!

You say, bad management. I say, not so, for they had plenty of good sealed honey right in the hive, and yet they starved, for the very reason that the honey was on the one side of the hive and the cluster on the other. The honey had all been consumed around and about the cluster, and I have no doubt, had the weather been warm enough for the bees to break cluster, and move toward the honey, that colony would have survived along with the others. But according to Mr. Cotton's theory they filled themselves after returning from a

flight, and never ate another drop, but just "done gone and died."

Now, is it reasonable to suppose that when they returned they filled themselves, and then clustered in that part of the hive where there was no honey, and there died? Perhaps bees in Missouri are so stupid, but I think mine at Bethesda are not quite so foolish—at least I hope not.

Another point: I have known bees to carry down pound after pound of section honey in the dead of winter, when they were short of stores; and if my memory is not at fault, I say they did not fly out while thus engaged. I would ask Mr. Cotton, candidly, did they carry that honey down and consume it? or did they merely store it, awaiting an opportunity for a flight to make a meal of it? I hold to the former idea.

If it were not for drawing out this article, which is already too long, I could point to several other circumstances along this line, in support of my contention, but I will save my ammunition for future friendly battle. I said in my former article, that I was satisfied Mr. Cotton's idea would not hold good at Bethesda; his last article has not led me to change my mind in any way; but I might modify it a little by saying I do not think it well.

Mr. C. asks me what the bees do with so much food as I speak of. I don't know. I never was inside the hive to watch, but I suppose they eat and consume it, and certainly absorb a large portion of it, because it was in the hive in the fall, and was not there in the spring. What else could they do with it, unless they carry it out of the hive to be wasted, which is not their nature?

Now if I am wrong in any of my statements, I wish to be set aright, for you know Rochefaucald said that no person is more frequently wrong than he who will not admit he is wrong.

Bethesda, Ont.



Some Subjects Reviewed and Commented Upon

BY DR. C. C. MILLER.

BEE-KEEPERS' ASSOCIATIONS.—Referring to page 809 (1895) Hon. Geo. E. Hilton writes: "If a bee-keepers' organization could be effected in every township within 200 miles of me, it would pay me to employ two assistants to assist in the organization." Which leaves me quivering with curiosity for further explanation. How would it pay him? Lecturing, selling supplies, or what?

DADANT WITH HIS BIG HIVES.—Chas. Dadant certainly makes a strong showing in favor of plenty of room in the brood-chamber, and I'm looking with interest for some reply from the advocates of small hives. I'd like to see the two D's lock horns—he of Borodino and the Frenchman. What about a big lot of bees reared too late to work on the harvest? Even if it be admitted that the 8-frame hive is too small, why, Mr. Dadant, can't we use two of them for each colony?

THE NEW ADORNMENTS.—No. 1 of the "Old Reliable" for 1896 looks quite dainty with its new head-dress, neck-ribbon and bracelets. If I should desire any change, it would be to have the name in very plain type on the first page with no ornamentation whatever. But that might be too severely plain for the general taste, and the general taste should be consulted. There's a wee bit of conflict between the title page and the headings of the other pages, there being no "The" in the title on the first page. I think I like the new name better, though come to look it up there's nothing new about it. At any rate, the shorter name is better.

THE FUN OF BEE-KEEPING.—I want to thank F. L. Thompson for some of the things he has said, and said well, in his article, "Specialty vs. Mixed Bee-Keeping," on page 1. I'm not entirely certain that I know exactly what "specialty" means when applied to bee-keeping, but I am certain that a man may be happier in a pursuit that accords with his tastes, and that keeps him constantly on the alert with inviting problems, than if he had no other thought than making money. And I'm not in sympathy with the sentiment that the love or enjoyment of a pursuit goes out of it as money comes in.

Bee-Master will never live to see a class of bee-keepers who keep bees for the love of it, if no such class now exists. If it were not for the love of it I should have been out of it long ago, for I could, and did, make more money in other ways.

I'm not so sure about that paragraph that begins, "Specialty means broad-mindedness." No doubt, as the writer had it in mind, it's all right, but I have known those who stuck so exclusively to a specialty that they were narrowed by it. But

the next paragraph, beginning "Specialty means happiness," I'll swallow whole without blinking.

DO FIELD-BEES PLAY?—On page 824 (1895) Wm. S. Barclay endorses, as well he may, the idea that long life in a strain of bees is a thing to be desired, but when he broaches such a revolutionary idea as that there may be such a thing as field-bees fooling away part of their time in play, one is led to say, "Why, bees are models of industry, and never play after they commence work in the fields." Did ever any one during harvest time detect in the act of playing in front of the hive a worker with ragged wings? There ought to be something more than circumstantial evidence to make one accept such a revolutionary idea. And yet it has always been admitted that there was a difference in the industry of different colonies? Now if one colony may be more industrious than another, it follows that one colony may be less industrious than another, which is only another way of saying that one colony may be more idle than another; from which it is not such a very long step to saying that a colony may be so idle in character that some of its field-bees will play instead of work. It will do no harm, at least, to inquire whether such a thing may be, or not.

CALIFORNIA THROUGH PROF. COOK'S GLASSES.—For years I've read the glowing accounts of matters and things in California—its climate, flowers, fruits and bees—and have remained proof against all its blandishments, but after reading Prof. Cook's article on page 2, with the thermometer within nine degrees of zero here, oranges 40 cents a dozen, and no strawberries for months, to say nothing of 150 pounds per colony, and the good society and all, I could hardly help thinking maybe it might be a good thing for a young fellow like me to take a fresh start in a new spot, especially after my wife saying, "Let's sell out and go." Say, Professor, hold on. "No more o' that, an' thou lovest me." It won't do for every one to pack up for California; some one must stay to help gather the nectar in latitude 42° north.

BLACK BEES.—"Get some black bees," says S. M. Robertson, on page 13, in view, I suppose, of the fact that I've had two years of failure and he's had two of the best seasons he ever saw. I'd like to accommodate you, Mr. Robertson, but please give me some reason for getting the black imps. With the bees I have, I've done twice as well in a good season as you have in your best season. And I live in a poor honey district. I've had blacks a plenty, and they don't do as well as Italians.

OPENING HIVES.—Queer that so many replies on page 15 seemed to resent the question there given as an implied charge that they opened hives too much. No less than eight of them refuse to answer the question, and poutingly say they don't do it at all unless they ought. Why, who said you did?

Marengo, Ill.



Advantages of Divisible Brood-Chamber Hives

BY REV. WM. ANDERSON.

Apropos to the discussion in the American Bee Journal on the question of the best hive for general use, I may be permitted to give my experience, covering a period of 12 years, during which I have experimented with nearly all the hives which have gained a reasonable degree of popularity.

I began bee-keeping when a mere boy, in my native country—Scotland—by transferring bumble-bees' nests into old kettles, pans and boxes, and had them as neatly arranged in our flower-garden as the best-kept modern apiary. Later, I became the happy owner of a straw skep, and still later, together with my brother, purchased several American Langstroth hives.

On coming to this country, 13 years ago, I began keeping bees in several different kinds of hives, all modifications of the Langstroth, including the Simplicity, the Baker, and the old Heddon, etc.

When the New Heddon hive was placed on the market, I purchased a sample and tested its merits for two years by the side of the others. One after another my loose frame hives were broken into kindling-wood, and replaced by the New Heddon. I now have all my bees in the latter hive, numbering 30 colonies, and I will give my reasons for preferring the New Heddon to all others I have tested.

I need scarcely say that I have no ax to grind in the matter, and that I owe Mr. Heddon no other debt than that grati-

tude and public acknowledgment to which every inventor of a labor-saving device is entitled.

The merits of the "New Heddon" are of a kind that do not show up on the surface, and hence for the novice in bee-keeping, who owns but a colony or two, and expects to treat these as a boy does his first watch, I would suggest the loose, pendant frame and Langstroth hive.

When one has advanced so far in the knowledge of bees as to diagnose the contents of a hive from the alighting-board without lifting a cover, he will then be in a position to appreciate fully the merits of the Heddon.

1st. This hive solves the vexing problem of a large or small brood-nest, by permitting the apiarist at will, and with the very smallest modicum of effort, to increase or diminish it, *ad libitum*.

2nd. The reversibility of its frames, and the interchangeability of its divisions are of untold value in securing compact, solid combs, which will never break with ordinary usage, and in making the task of manipulating, whether in swarming or extracting time, a pleasure rather than a toil.

3rd. The shake-out principle I have found feasible with black or German strains of bees, and when the brood-nest was not filled with honey—which it should not be permitted to be until the close of the honey season.

4th. For securing both comb and extracted honey, the surplus arrangements of the Heddon I have found most serviceable in affording a No. 1 filled section; and with the help

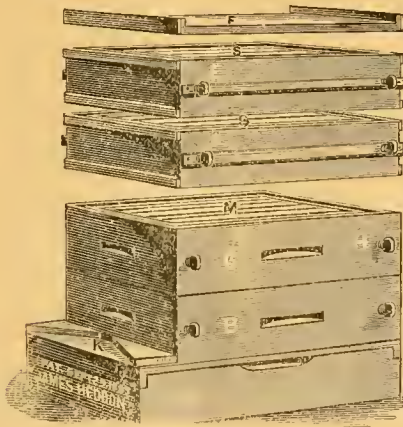

The New Heddon Divisible-Brood-Chamber Hive.

of the Porter bee-escape, in making the removal and transference from apiary to extracting-room easy and safe. The handling of combs does not take place until all bees have removed from the super, and the latter in the extracting-room.

5th. As a hive for the migratory bee-keeper, or for the large owner with out-apiaries, the Heddon is *par excellence*. As a minister, I have had occasion to change my place of residence, on an average, once in five or six years. I put 28 colonies into a freight car with my household goods in the month of August, 1894, and transferred them a distance of 400 miles with but the loss of a single colony, and without any accident to either my father or our family horse, both having had their quarters in the car by the side of the bees. With the light, and tight-fitting, appliances of the Heddon hive, the work was simple, which otherwise would have been impossible.

6th. As a hive for wintering, the advantage of the Heddon is in permitting the apiarist to adept the size of the repository to the strength of the colony with the least labor, by using the single or double case. I have found that bees winter in the cellar equally well in the double and single cases.

7th. This hive affords the speediest and safest means of natural and artificial swarming, and when once the system of manipulation is mastered, the apiarist has his bees very largely under his control.

An objection to the hive has been placed in the difficulty experienced by some in finding the queen-bee. I think Mr. R. L. Taylor, of Lapeer, Mich., was the first to publish an easy method of securing her majesty in the hive, viz.: By placing an empty case on top of the brood-nest over a queen-excluding honey-board, administering a few puffs of smoke at the entrance, meanwhile rapping on the sides and back of the hive for one minute; then suddenly removing the honey-board, the queen will almost invariably be found on the under side of the honey-board, attempting to force her passage, and

demoralized with the rest of the colony, may always be readily captured.

Another objection has been the difficulty of keeping the thumb-screws from expanding, and even the frames, in a damp cellar or in wet weather, so as to become unmanageable without the aid of a wrench and a pry-chisel. Propolis, too, will cause trouble in the brood-chamber in the fall, so as to prevent easy manipulation. At first this seemed to me a somewhat serious objection, but latterly, as I became expert in the use of the above aids, the objection ceased.

Again, it has been objected that the queen will not pass readily from one section of the brood-chamber to the other, and hence the work of brood-rearing is retarded. With me the facts do not sustain this objection to any appreciable extent. I think it must be relegated to the domain of mere theory. I have noticed that when a queen wishes to lay eggs she will find empty cells anywhere above or below, as soon as the bees have formed passageways, which they invariably do the first thing after manipulating the hive during breeding-time. A queen will traverse the entire depth of the brood-chamber and deposit eggs in empty cells several times in 24 hours, if there is occasion, and if she is a queen worth her salt.

Bureau Co., Ill.



That Building for Wintering Bees.

BY L. M. WILLIS.

On page 823 are some questions from Dr. Miller, asked about my article on wintering bees in a building not frost-proof. In reply thereto I may say that I believe that the stuffed wall insures dryness, which, to me, is one of the most essential parts of wintering.

The building I use is 10 by 24 feet, outside measure, but I have used only one end of it for my bees, making the room where the bees are, 10 by 12 feet, less the packing of 12 inches all around, or 8 by 10 feet inside. I have 44 colonies in this room now. I have kept from 3 to 28 in it. I have used this room three winters, this making the fourth.

The only loss I have had was one colony that for some reason left the hive before it was time to take them out, and they were lost in the room among the other hives. This colony had about 30 pounds of honey in the hive they left, and the hive and combs were perfectly clean and dry. I think that they became uneasy toward spring.

I put my bees into this room on Dec. 2, 1895; in 1894 I put them into winter quarters on Nov. 27. I leave them out until it becomes cold enough to show a little frost on the underside of the honey-board. I think this is a better guide than Nov. 15, because my bees had a nice flight after that date the past fall.

I have tried to winter bees in the cellar under the house, and had dead bees in the spring because the combs became moldy.

I have not had any spring dwindling since using the room described for wintering. I always put some rye flour out when I put the bees on the summer stands. For the flour I use a piece of board 12 inches square, with one-inch strips nailed on the upper side, around three sides. On these strips I place a small pane of glass, after putting a teaspoonful of rye flour on the board. The bees will take this flour into their hives pretty quick after they get a taste of it; and it helps to start breeding early.

Loyal, Wis.



Bee-Hives for the General Farmer.

BY E. H. GABUS.

On page 747 (1895) there appeared an article entitled, "Bee-Hives for Farmers—Needs Verification," wherein the writer cannot call to mind any article of Father Langstroth advising the mass of farmers not to use the movable-frame hive he had invented. In the article referred to, published in the Farmers' Friend, in 1888, Father Langstroth says:

"I believe farmers would have better success with their bees if they used only the old straw or box hives. A simple tool in the hands of one who knows how to use it, will turn out much better work than an improved implement whose proper use has never been learned."

He says also in the same article: "I believe that if the mass of our farmers could be *persuaded* to resume bee-keeping with the old-fashioned straw-hive, there would not only be a large increase in the number of bees, but also in a short time a larger increase in the number of movable-frame hives than can be brought about in any other way. How many farmers would be asked by their smart boys and girls who naturally

take to bees, 'Father, why can't we get some movable-frame hives, and do as well with them as neighbor A. does?'"

He says also: "To the class of bee-keepers I had reference to, the very first attempt to improve the old box or gum hive, by giving bees access to the supers, was a step backward, for in taking away the surplus honey, so-called, stored in these supers, often the honey absolutely needed to carry the bees through until the next harvest was taken away from them, and the colony unless fed perished."

In Gleanings for June 15, 1892, page 476, Langstroth is reported as saying: "That he questioned whether many farmers were advanced enough to have movable-frame hives, because with such hives they would not handle the frames if they could."

In Gleanings for July 1, 1893, Doolittle advises farmers to use the box-hive, and finishes his article in this manner: "Any farmer can do as much as I have here outlined, and I have sometimes seriously questioned whether this will not give any of us as good results as the more frequent manipulation of each hive, which has been insisted upon in the past."

In Gleanings for July 15, 1891, Mr. C. J. H. Gravenhorst, of Germany, says: "In the course of several years I also got more honey and wax in the old-fashioned way, with my old Luuebergien straw skeps than with my accurately constructed and skillfully handled Dzierzon and Berlepsch hives; and last, but not least, with undoubtedly less cost, labor and time." He says again: "Of course, my experience would have prompted me to abandon the frame hive totally had I been blind enough to misunderstand the great advantages of the latter." Again, he says: "Experience soon convinced me that the principal point was that I could handle my old skeps instead of individual frames, and get a thousand pounds of honey with less labor."

In Gleanings for April 15, 1891, P. H. Elwood says: "Quinby observed that bees did not winter well in the frame hive; and Dzierzon also observed that the open frame infringed upon the welfare of the bees."

Mr. Abbott, late editor of the British Bee Journal, says that it is unnatural to have the open spaces at the end of the frames. The Langstroth hive has revolutionized bee-keeping, and we have made discoveries into the wonders of bee-life that could not have been made with the old-fashioned hive. Bee-keeping has been specialized, for only a few individuals are fit to become expert bee-keepers; at the same time, farmers, as a class, have discontinued to keep bees, because it did not pay them as well with the improved hives as it did when the gum or box hive only was in use. This is not as it should be. Bees ought to be on nearly every farm, and not aggregated in large quantities as is the case now, where it is not uncommon to find individuals owning hundreds of colonies in one or two apiaries.

We are now ready for another advance in bee-keeping, and one that will again place bees on every farm, and permit nearly any one to handle bees with success, and give the farmer a bee-hive that can be handled as the old straw-hive used to be. It will be a compromise between the old and the new; it will be handled as easily as the straw-hive, and at the same time retain all the advantages of the movable-frame hive, and permit interior examinations; a hive that will be cheap, as we cannot get the old prices for honey, and honey ought to be cheaper than it is, so as to be within the reach of all, poor as well as the rich.

If you care to know more about the hive of the future, I shall tell you what it is in my next. Brock, Nebr.

[Mr. Gabus, if you know of a better bee-hive for the future than we now have, of course we want you to tell us about it in your next. There are a few individuals who are afraid there will be an over-production of honey, but we are not among them. It will always be under-consumption, and if the almost doubling of the crop of extracted honey by the miserable glucose and syrup adulteration could be effectually stopped, there wouldn't begin to be enough genuine honey produced now to supply the demand. Certainly, farmers ought to produce honey—just as they do apples, potatoes, and other produce—for the city people as well as for their own use. The trouble is not in over-production, it's under-consumption and the abominable adulteration.—EDITORS.]



☞ "Stop my paper; times are too hard," says a reader. Certainly—and if you are going to burn the bridge on which you cross, you will find times much harder. Saving less than 10 cents a month is rather extravagant economy, if you believe a paper is worth anything at all.

Interesting Experiments in Heating Honey.

BY HON. R. L. TAYLOR,

Superintendent of the Michigan State Experiment Apiary.

Perhaps no fact is better known to the skilled bee-keepers than that honey is readily injured both in flavor and color by over-heating it, and yet for want of exact knowledge of the point at which heat begins to be detrimental, there is no question that qualities of honey are greatly reduced in value even by those who are well acquainted with the general truth of the fact referred to; of course, with those who keep but few bees, and are content to neglect the latest and best sources of information, and to accept the word of the bee-hunter and the voice of tradition as all-sufficient to direct in the management of the bees and their product, the danger is greatly augmented.

What is the highest degree of temperature to which honey may be subjected without receiving damage? It is not necessary to explain to bee-keepers how important this question is. Before the invention of the extractor, heat was an effective assistant in the operation of separating the honey from the wax, and in case of honey candied in the comb it was an indispensable assistant; and to those whose limited apiary and slender resources do not warrant the purchase of all the convenient appliances, the age of the extractor has not yet come. But the coming of the extractor has, in fact, rendered the question still more important, for it has to a degree revolutionized the business of bee-keeping by the ability it gives the apiarist to readily remove the honey from combs without at all injuring them for the use of the bees, so that they may be used over and over again for years; and the means thus secured of supplying the bees with ready-made receptacles for their honey, has rendered the extractor vastly popular; but with it has come the magnified inconvenience of handling large quantities of candied or granulated honey, which often can be done to advantage after securing its liquefaction by the use of heat.

I know of no thoroughly satisfactory way of accomplishing the process of liquefaction. Either the process is a long and nice one on account of the skill and care required to keep the temperature below the danger point, as when the honey is to be liquified in crocks, jars or other vessels in which it has already been stored; or else it must be placed in the melting-vessel after cutting it out of the one in which it has been stored—a slow and trying labor, if it has been allowed to become thoroughly solidified, in which case the use of a spade, or even of an ax, is necessary, in order to make any satisfactory impression upon it, and even then the same skill and care are required unless the melting-vessel is so constructed that the honey may run off as fast as it becomes liquified. I have invented a vessel to accomplish this, which is made as follows:

The outer vessel (for it is double) is an upright cylinder, as large as desired, and as the stove to be used will accommodate; made of tin, galvanized iron or copper; the inner one would better be of tin, two or three inches less in height, and four to six inches less in diameter, than the outer one. The inner one is to be fastened on metal supports about an inch above the bottom of the other, and so that the space between the two is equal on all sides. Both vessels are to be perforated for a spout to run from the bottom of the inner one out through the outer one, at a convenient distance to allow the passage of the honey, as it melts, to a receptacle to be provided for it at one side of the stove. The spout is, of course, to be soldered in place. It should be at least an inch in diameter, and provided with a guard over and at some little distance from the inner end, of very strong and somewhat open wire-cloth, or other equivalent, to prevent the passage of too much unliquified honey. The honey, as it emerges, must pass into a strainer of cheese-cloth or other material, to intercept grains of unmelted honey, which are to be returned to the melting-can. The outer and the inner can should each have a cover of its own. In operation, the space between the two is filled with water, through which the heat is conveyed to the granulated honey in the inner one. The spout should also be provided with a faucet or other convenient cut-off at the outer end.

The most obvious way of effecting the liquefaction of honey is to put it into an earthen or other fire-proof vessel directly upon the stove. This course would make the honey liquid as quickly as any, but the effect upon the honey would be disastrous. As candied honey is a poor conductor of heat, that lying at the bottom of the vessel would become boiling-hot, or even scorched, before that two inches higher up in the vessel had become warm, if the fire were brisk, and the whole in a short time would be entirely ruined.

The next method that would be likely to occur to one, would be to raise the vessel some little distance from the stove by means of brick. This would render the process much

slower, and in a corresponding degree safer, but would still be almost sure to do the honey more or less injury, and would prove to be, on the whole, quite unsatisfactory.

The next plan, and in the absence of any utensil made specially for the purpose, the best of all is placing the vessel, containing the honey, in a bath of water, which is to serve as a medium for conveying the heat of the fire to the honey. In this place the heat is equalized and mollified, so to speak, and is under much better control, and yet, as will be seen later, all danger is not thereby eliminated. An improvement on this method could be made by so constructing the vessel which is to contain the honey, that it may be from time to time conveniently lifted out, and such portion of the honey as is sufficiently melted poured or drawn off.

The results of an experiment which I recently made is the best answer I can give to the question of what degree of temperature honey will endure without injury. For the making of the experiment I used a tin can about 20 inches in diameter. This, containing a few inches of water, was put on the stove, and an ordinary crock to contain the honey was set into the water, but raised about an inch from the bottom of the can by placing a few pieces of coal under it. The only honey at hand that would answer the purpose was some partially-filled sections of the crop of 1894. It was white and clean, gathered from basswood and clover, say two-thirds from the former to one-third from the latter, and was about half granulated. The combs were broken out of the sections and put into the crock till it was nearly filled. Fire was then put under, and the temperature of the honey gradually raised till it was at 145° Fahr., when a considerable portion of the honey had dissolved and separated from the comb, and the wax had begun to melt slightly. At this stage the liquified honey was drained off, and a sample of it secured. The heating process then continued to be applied gradually to the remainder till its temperature reached 165° Fahr., when both honey and wax were melted, and a sample of the honey was again taken after the removal of the wax. The temperature continued to be raised and the samples of the honey were taken at the temperatures of 185° Fahr., and 200° Fahr. I then essayed to raise the temperature still higher, but after a pretty strenuous effort I failed to get it more than two degrees higher. The honey was then removed and another sample taken. Thus five samples of the honey were secured at intervals of time amounting to one hour, or a little more, each.

The color and flavor of these samples are the means we have of determining the various effects of the different temperatures. In the first sample I could detect nothing either in color or flavor indicating the application of heat. Between this sample and the next one taken at 165°, the difference is slight. I could distinguish between them correctly by the taste, blindfolded, and by sight by holding them up side by side to the light. One person, used to the taste of honey, could distinguish them neither by sight nor taste. Another one thought the second one the better flavored. Practically, it would be safe to say, I think, that they would be classed as of the same quality.

After going above 165°, the honey rapidly deteriorates both in color and flavor. The difference between the second and third is twice as great as between the first and second; that between the third and fourth twice as great as that between the second and third; and that between the fourth and fifth shows even a more rapid rate of deterioration, though the temperature was raised but a trifle, showing that simply the continuance of an unwonted temperature causes injury. It is quite likely that the continuance of a temperature so low as 145° would prove injurious. The rate of deterioration in color corresponds well with that in flavor. The third sample would still be classed as white honey, while the fourth is quite light amber, and the last just a good amber.

In the absence of evidence that honeys from different sources can safely endure different degrees of temperature, we may assume that honey should not be subjected to a temperature above 165°, and at a temperature so high as that for only the shortest possible time.—Review.

Lapeer, Mich., Dec. 19, 1895.



Back Numbers.—We have on hand a few back numbers of the Bee Journal for 1895, which we will mail to any one wishing them at 15 copies for 20 cents. They will all be different dates, but we have no complete sets for the year. Just send us 20 cents in stamps or silver, and we'll send you 15 copies. No doubt there are many new subscribers who will be glad to take advantage of this offer. All new subscriptions now begin with Jan. 1, 1896.

Questions AND Answers

CONDUCTED BY

DR. C. C. MILLER, MARENGO, ILL.

[Questions may be mailed to the Bee Journal, or to Dr. Miller direct.]

Amount of Honey Certain Plants Yield—Kegs for Honey.

1. Please give some estimate of the amount of honey each of the following plants will secrete per acre in a fair season; also how much per colony would be a fair yield under favorable conditions: Red raspberry, black raspberry, white clover, Alsike clover, basswood, and buckwheat.

2. Are whisky, wine and brandy kegs suitable to use for honey?

E. M. H.

Kilbourn, Wis.

ANSWERS.—1. I don't know. Neither do I know where the woman lives that can direct you to the man that does know. The only thing I've ever had bordering on anything like a well-defined opinion in the case is with regard to buckwheat. I've always held that an acre of buckwheat would yield 25 pounds of honey in a day, just because M. Quinby said so, but I have serious doubts whether it was anything more than a guess with him. The fact is, that there's an unexplored field right here, and a chance for some one to distinguish himself by giving answers to your questions with proofs attached thereto. If a man should say an acre of raspberries yielded less than 50 pounds in a season, and another should say it yielded more than 5,000 pounds, it might be a hard matter to convict either one of perjury.

I suppose something might be learned in some cases where a given acreage of a certain plant was in reach, and nothing else in bloom at the time; and if any of the readers of the "Old Reliable" have any definite data to form an opinion upon, whether about the plants here mentioned, or any other, let them not be backward about coming forward to inform us.

2. I don't remember seeing them recommended, and I think I have seen them condemned.

Building Comb When Fed on Sugar Syrup—Swarm Settling on an Evergreen Tree.

These questions have been asked in the American Bee Journal:

Can, or will, bees build comb when fed on syrup?

Will a swarm settle on an evergreen tree?

I had a swarm to issue July 29, 1895, which has answered the above questions conclusively. The swarm settled first on an apple tree; I put them into a hive, where they remained half an hour, when they came out, and after circling about the yard, settled the second time on an arbor vine. I noticed that the bees were excited and confused. After some investigation I discovered that there were a number of young queens in the cluster, which I concluded were the homeless ones flying about the apiary at the time. I caged one of the queens, and then tried to hive them, but in a short time they were again on the wing. They finally settled the third time on a balsam fir; the limb on which they had clustered bent almost to the ground, which enabled me to cage three more queens, after which the bees went quietly into the hive.

The following two days were too cool and stormy for the bees to fly out, from which they suffered no loss, as everything in the line of bee-pasturage was dried up by the long-continued drought.

Not wishing to lose the bees by starvation, I put on a super, into which I placed a large steak-dish with some little floats in it. I poured, every morning, about a quart or more of syrup into this dish, which had been made of an inferior grade of brown sugar and water, about equal parts.

On the fourth or fifth day I looked into the hive to see what the bees were doing with all the syrup. I found five frames drawn out and partly filled, and capped very white; but, to my surprise, I found no queen or eggs. About six days later I again examined the hive and found all the

frames drawn out, but no signs of a queen. About this time I had received some queens, and put one of them into this hive. Some time in September I again examined them, and found a thriving colony of yellow bees, the whole weighing 67½ pounds—about 35 pounds of brood, bees, and honey. To-day—Nov. 16, 1895—it appears to be a strong, healthy colony, in excellent condition. If the same can be said of this colony next spring, the fact may be worth reporting. B. J. C.
Notre Dame, Ind.

ANSWER.—Bees clustering on an evergreen is nothing unusual, but it isn't so certain that bees can make wax from sugar syrup alone. The fact that comb was built in an empty hive by a swarm at a time when bees were apparently gathering nothing is hardly conclusive, for bees are not likely to swarm unless there is at least a little something to be had from the fields in the way of pollen and honey. Experiments have been made that show that sugar syrup can take the place of honey, more wax really coming from a pound of sugar than from a pound of honey, brown sugar excelling white, but pollen is also needed—at least Cheshire says that it is terribly exhausting for bees to be obliged to secrete wax without pollen.

Dried Cattle-Dung as Smoker Fuel.

I have tried linen rags, shavings, rotten wood, rotten sacking, and all sorts of things, but I find nothing nearly comes up to dried cattle-dung. It smoulders slowly and surely, one charge lasting three or four times as long as any of the first-named, while the odor is most powerful and effective. Try it; you'll like it. S. D.

ANSWER.—Although very old, this sort of smoker-fuel may be new to many, and has the advantage that it may be more easily obtainable in some places than other material.

A "Crooked Commission-Man" Experience.

What do you think of a commission man that will send out his flaming circulars to bee-keepers, stating that he is in a position to get the very top figure for honey, will sell for 5 per cent. commission, has a call for more than he can get, quotes you prices of 16 and 17 cents for white honey, and after three months reports to you sold at 8 cents, then charges drayage at the rate of \$2.70 per load for delivering the same, and 10 per cent. commission on top of that, and tells you that your snow-white basswood and clover honey was dark? If I had the power, I would prevent such men from ever receiving another pound of honey. E. A. M.
Chippewa Falls, Wis.

ANSWER.—I don't know for certain just what I'd think, for I never was in exactly that position, but I'll tell you what I think I'd think, and that is, that a man who would do the things you mention would not be a safe man to sit up with a corpse if the eyes of the departed were held shut with copper cents. And I am not in sympathy with the idea that we must keep so terribly silent about any one who is crooked in his business transactions.

I wish some one would tell us whether any commission house in Chicago regularly charges 10 per cent. commission. I have an impression that it's something entirely new, if it is done.

But please don't come down so hard on the whole fraternity of commission men. While there may be scoundrels among them, there are also those for whom I have high respect as honest men. If you should hear of me abusing my wife, that wouldn't justify you in saying all bee-keepers were brutes.

Comb Honey or Extracted—Which?

Would you advise a beginner in bee-keeping to produce comb honey, or extracted? H. F. M.
McFall, Mo.

ANSWER.—That question can't be answered by a single word without knowing about circumstances and surroundings. If the question means which will be easier for a beginner to manage, an apiary run for comb or extracted honey, I should say extracted. And on the face of it I should take your question to mean that. If one with little or no experience works for comb honey, there are a good many things about the business in which he could make mistakes that could not well be made with extracted honey. For example, we could so man-

age as to have at the close of the season a lot of unfinished and unmarketable sections, with none in good shape for market. Simply as a result of tiering up too much. If the same thing were done with extracted honey the same loss would not occur, for even if the honey were scattered through a lot of combs instead of having a smaller number of combs well packed, the honey could still be extracted all right. If the sections were not taken off early enough they would become darkened, and on that account less valuable; but the same thing would only make extracted honey better.

But the question may have a wider scope. Suppose it comes in this shape: I am about to commence producing honey to make all I can out of it in the next five or ten years; do you advise comb or extracted? The proper answer would be, That depends. If extracted honey will bring in your market just as much per pound as comb, then by all means work for extracted. In some places the honey is so dark that it will bring only a low price as comb honey, and you may make more money by running for extracted. It may be that your home market is so poor that you want to ship, and shipping facilities may be such that you cannot safely ship comb. These and other considerations must be taken into account. On the other hand, your honey may be all light, and it may be that you can get two or three times as much for comb as extracted, throwing the balance in favor of comb. Your own skill and experience in the matter may have something to do with it. A may exceed B in working on the same ground for extracted honey, while B may be ahead on comb.

Possibly it may be so difficult to properly determine the matter that the best way will be to commence working for both.

Increase by Dividing or by Natural Swarming.

I wish to increase my colonies in the spring. Would you advise natural swarming, or would I better divide? If you advise dividing please tell me just how to do it. My bees are hybrids, and good enough for me. I use the 8-frame hive. South Avon, N. Y. M. D.

ANSWER.—It's hard to tell what would be best without knowing how far you have gone in your education as a bee-keeper. Some of those who are thoroughly versed in matters apicultural prefer natural swarming, while others prefer to take the matter in their own hands. Something depends upon circumstances, as whether a man expects to be on hand to see swarms when they issue.

But, from part of your question, I suppose you are something of a novice, and very likely your safer plan will be to let the bees swarm naturally. But as you intend to increase, the probability is that you intend to go into the business more fully, and it would be a fine thing for you to inform yourself during the winter by getting a good text-book and reading up. Then you will better judge for yourself as to what is best for you; and after becoming familiar with what is given in the books about dividing, it will be a safe thing for you to undertake it if you think that the best way in your case. But for one with little knowledge of the general principles of bee-keeping, to make artificial colonies would not be the safest thing, as it is an easy matter to do some little thing wrong and thus spoil the whole job.

A New Binder for holding a year's numbers of the American Bee Journal, we propose to mail, postpaid, to every subscriber who sends us 20 cents. It is called "The Wood Binder," is patented, and is an entirely new and very simple arrangement. Full printed directions accompany each Binder. Every reader should get it, and preserve the copies of the Bee Journal as fast as they are received. Why not begin with Jan. 1 to save them? They are invaluable for reference, and at the low price of the Binder you can afford to get it yearly.

If any one desires two of the Binders—one for 1895 and one for 1896—send 30 cents, and they will be mailed to you.

Honey as Food and Medicine.—A new and revised edition of this 32-page pamphlet is now issued. It has 5 blank pages on which to write or paste recipes taken from other sources. It is just what its name indicates, and should be liberally distributed among the people everywhere to create a demand for honey. It contains a number of recipes on the use of honey as food and as medicine, besides much other interesting and valuable information. Prices, postpaid, are: Single copy, 5 cts.; 10 copies 35 cts.; 50 for \$1.25; 100 for \$2.00. Better give them a trial. Send all orders to the Bee Journal office.



Bridal Trips of Virgin Queens.

Virgin queens will not take their bridal excursion so long as unsealed brood is present, says Gravenhorst—he has known of only a single exception. I have known of *thousands* of exceptions. My queen-rearing nuclei are *never* without unsealed brood, yet the queens mate all right. Of course, in natural swarming there is no unsealed brood in the hive at the time the young queen mates, but I doubt if its presence would have any effect in deterring her.—Review Editorial.

Control of Swarming.

To control swarming we must remove one of the *prime* factors. Brood is the only factor we can remove and not defeat our object—honey. The removal of brood instead of decreasing the honey-yield rather increases it. We may remove the brood by direct confiscation, or we can do it more gradually by the removal of the queen. The first method would be better where the flow is very short and profuse, the second better where the flow lasts 40 to 60 or more days. The *cause* of swarming is instinct; its *control*, broodlessness. Other methods at times seem effective, but the only method of controlling swarming that is at all times a success, is broodlessness.—R. C. AIKIN, in Review.

Superseding Queens.

A queen should be allowed to remain as mother of a colony as long as she retains her fecundity; for prolificness, not age, should be the test in this matter. I never supersede a nice queen, no matter how old, until she shows signs of failing powers. We want queens for the eggs they lay; and for that reason, power of production, and not age, is the rule to follow. I would not keep even a *young* queen, if she did not lay up to a fair average, for there are a few queens that are not prolific enough to keep four frames supplied with brood as they ought to be; and where I find such, I always give their colonies something better to take their place. However, such queens as this last are the exception and not the rule; for the bees do not often allow such queens to remain in the hive long, especially if they are of the Italian variety.

After experimenting in the direction of superseding queens for years, I now decidedly prefer to leave it to the bees to decide when their queens are worn out, unless, by outside observations, I believe they are holding on to some unprolific young queen. As a general thing, the bees will make fewer mistakes in directing this delicate matter than the wisest apiarist is likely to make. I have had queens that were five years old do good duty till the commencement of their sixth year, when the bees would supersede them that autumn, the same as they often do in the autumn with queens commencing on their second, third, or fourth year.—G. M. Doolittle, in Gleanings.

Non-Swarmers Not Wanted.

We do not think we want any non-swarming bees, and it is our opinion that when the swarming propensities are bred out, the keeper of such bees had as well have no pocketbook, if he depends on his non-swarming bees.—Southland Queen.

Fire in Bee-Cellars.

Two in the symposium keep fire in the cellar. I suspect that's a larger proportion than will be found generally among those who cellar their bees. Of those who have tried it and abandoned it, it might not be out of place to inquire whether there may not have been a wrong use of a right thing. Mr. Boardman says it grows in favor with him. I'm not sure whether it does with me, but I'm sure the conviction grows that it is all right. If a cellar stands too near the freezing-point, you can bring the temperature up by making the cellar closer; but you'll have better ventilation and air by bringing up the temperature with a fire. We make fire for folks in winter, and no harm comes of it. Why not for the bees? The fire is put in an adjoining room, not in the same room with the bees. Just why, I don't know. Perhaps the fire is made with wood, in which case there might be too sudden a change

of temperature, and the light from the burning wood might be mischievous. For my own use I would no more think of putting the fire in an adjoining room than I would a stove for heating a sitting-room. But I use anthracite coal altogether. A small cylinder stove keeps a steady, low fire, and the door of the stove is left wide open all the time. That helps ventilation. I think some fear that bees would fly into the open door, but I never knew a single bee to do so. The fire is kept going day and night all winter long, unless a spell of weather comes that makes the cellar too warm. I may mention that those colonies that stand nearest the stove winter as well as any.—DR. MILLER, in Gleanings.

The Laying of a Queen.

A queen can lay 3,000 eggs a day, but not every day. Here are observations on a colony of bees I followed in Palestine, January to December, 1891. As nearly as I could make out, the colony numbered some 10,000 bees, Jan. 1.

	Daily average.	Total.
Average laying from Jan. 1 to 20, '91.....	100	2,000
Spring waking-up, Jan. 20 to Feb. 7.....	666	11,988
Almond flowers, Feb. 7 to March 3.....	700	16,800
Beginning of orange blossoms, Mar. 3 to 18.....	2,333	34,995
Full orange blossoms, Mar. 18 to Apr. 10.....	2,600	57,200
Beg'n'g of no flowers, then cactus, Apr. 10 to May 21.....	1,000	40,000
Chaste-tree blossoms, May 21 to June 17.....	2,111	56,997
Chaste-tree, then thyme, June 17 to July 10.....	2,277	50,094
Thyme and end of it, July 10 to Aug. 3.....	1,250	30,000
Thistles, Aug. 3 to 29.....	460	10,960
Honey in the hive, Aug. 29 to Sept. 13.....	200	4,000
Peppermint and others, Sept. 13 to Oct. 14.....	115	3,000
Nothing outside, Oct. 14 to Nov. 11.....	35	1,000
Nothing outside, Nov. 11 to Dec. 10.....	28	1,000
Nothing outside, Dec. 10 to 31.....	0	
Grand total.....		320,034

About the same at the end of the season as regards the number—20,000 bees. At all events, this gives us an average of 76 eggs a day for 365 days, or 1,760 eggs a day if we take the honey-flow season from March 3 to August 3. The colony did not swarm, and at the end of the season it was reduced to very nearly what it was in the beginning; 300,000 bees were hatched, and passed away; the colony had produced nearly 180 pounds of honey. This honey was taken by the extractor, April 10; April 18, orange-blossom honey; June 13 to 19, chaste-tree honey; July 10 to Aug. 3, thyme honey.—PH. J. BALDENSPERGER, in Gleanings.

Place of Next North American.

The North American Bee-Keepers' Association agreed to come to Lincoln next year, and now some are kicking for fear they cannot get railroad rates to suit. There are no Nebraska men on the board of managers this year, and so we will have no say as to the time of meeting; but if they will listen to echoes from this end of the line, they can fix a time when low rates are given. This year (1895) those attending the meeting at Toronto paid full fare both ways, while at the same time anyone between the Missouri river and Chicago could have reached here for one fare plus \$2.00, for the round trip, and from Chicago to the Atlantic ocean it would have cost one fare plus \$4.00 for the round trip. Whenever you go east again, better buy return-trip ticket first.

Gentlemen, don't talk about holding the meeting in connection with the G. A. R. encampment until after next year, but come and see how well we can use you. Excursions to Nebraska have been run by the railroads each year for several years past, during the fall months from Eastern points, and we have reason to hope that they will not be discontinued next year. We still have elbow room for several good farmers, and the railroads want to have them come and see this land of ours.—Nebraska Bee-Keeper.

Market for California Honey.

It was figured out during the convention, that extracted honey, on an average, for a series of years, costs 4½ cents to produce, and that the average crop is 65 pounds. As the present price of honey is from 3 to 4 cents, it is evident the bee-keeper is getting next to nothing for his labor.

The present slipshod method of marketing honey is largely to blame for the low prices.

The citrus fruit men are so well organized that they can estimate several months in advance the probable number of carloads of fruit there will be to ship. The honey-producer has never yet been able to tell how much honey has been produced, even months after its disposal.—J. H. MARTIN, of Calif., in Gleanings.

OLDEST BEE PAPER IN AMERICA ESTABLISHED IN 1861

THE AMERICAN BEE JOURNAL

PUBLISHED WEEKLY BY
GEORGE W. YORK & COMPANY,
 Editors and Proprietors,

56 Fifth Avenue, CHICAGO, ILL.

REGULAR CONTRIBUTORS:

G. M. Doolittle, of New York. Prof. A. J. Cook, of California.
 Dr. C. C. Miller, of Illinois. Dr. J. P. H. Brown, of Georgia.
 J. H. Martin, of California. Rev. E. T. Abbott, of Missouri.
 Chas. Dadant & Son, of Illinois.

\$1.00 a Year—Sample Copy Sent Free.

[Entered at the Post-Office at Chicago as Second-Class Mail-Matter.]

Vol. XXXVI. CHICAGO, ILL., JAN. 16, 1896. No. 3.



Hon. R. L. Taylor, of the Michigan Experiment Apiary (whose interesting article appears in this issue), will talk on bees at eight Farmers' Institutes in Michigan, at the following places:

Bad Axe, Jan. 22; Sanilac Centre, Jan. 23; Port Huron, Jan. 24; Lapeer (his home), Jan. 25; Grand Blanc, Jan. 27; Corunna, Jan. 28; Alma, Jan. 29; and at Mt. Pleasant, Jan. 30.

Every bee-keeper living in the localities mentioned should, if at all possible, arrange to attend those meetings, for Mr. Taylor is a practical bee-keeper, and undoubtedly will give the best he has in his bee-talks.

Large Yields of Honey, as given in the Question-Box department this week will be very entertaining reading. It shows what bee-culture has been in the past, and although it may never again come up to "ye olden time," still it no doubt will again rise to the dignity of a fairly remunerative industry. Very often crops on the farm do not pay, yet who would stop farming because a few unfavorable seasons come in succession? If publishers of bee-papers were to stop when their papers failed to prove profitable investments, where would be any of our bee-papers in a short time? There is not a publisher of a bee-paper to-day who is making any money on his paper alone! And yet, would you have them quit publishing them? Oh, no! we must all hold on, and labor on, trusting that the great Future may have some sort of reward for those who are faithful to their posts of duty.

The Chicago Meeting of the Illinois State Bee-Keepers' Association was held last Thursday and Friday, there being present between 30 and 50 apiarists.

Just as we predicted, it was a very interesting and helpful meeting. There was no previously-arranged program, and none was needed. Beginning with the very first session, the time was well occupied. There wasn't a single lag. Essays of any kind would have been almost useless. It was one continuous box of apiarian interrogation points, in the discussion of which nearly every one present took some part. If conventions were always certain of having good presiding officers, we

would say that essays are always unnecessary at such gatherings. But nearly all depends upon the president. If we were sure Dr. Miller wouldn't see this, we'd say right out that he is a model presiding officer. He certainly was, at this Chicago convention.

Editor E. R. Root, of Gleanings, was chosen Secretary, *pro tem*, in the absence of the regular Secretary, Jas. A. Stone, who unfortunately was compelled to be in bed on account of sickness. We expect to begin Mr. Root's report of the meeting very soon. We think it will be an unusually good one, as we noticed he worked like a "nailer" all the time—which included meal-time as well. (We might say, as some know, Mr. Root is on a wholly meat diet, and at one meal we positively saw the waiter bring him a whole porter-house steak—about 4 pounds. Only the harder bones remained when he left the table. But he didn't eat quite all of it alone. The next day it was noticed in the Chicago newspapers that the price of the best beef had advanced considerably in price! Of course, our fellow-editor received the credit—or blame—for this. He took them—the credit or blame, and the meat—in his usual quiet and modest manner.)

Several ladies favored the meeting with their presence, among them being Mrs. N. L. Stow, of Evanston, Ill., who has 55 colonies, and had, in 1895, about 1,200 pounds of mostly comb honey from 37 colonies, spring count; Mrs. Poindexter, who, a few years ago, had 200 colonies in DeWitt county, Ill., and one year produced 12,000 pounds of honey; and Miss Mathilda Candler, of Wisconsin, who, from some 80 colonies produced between 4,000 and 5,000 pounds of honey in 1895.

The convention was held in the comfortable parlor-like club-room of the New Briggs House, which was probably the nicest place in which a Chicago bee-convention ever was held. This hotel is a first-class one, and did all they could to make the stay of the bee-keepers pleasant.

Many of those who have been familiar figures in previous Chicago bee-keepers' conventions were this time very conspicuous on account of their absence; among them might be named, W. Z. Hutchinson, H. D. Cutting, Hon. Geo. E. Hilton, C. P. Dadant, Dr. A. B. Mason, and Hon. Eugene Secor.

We will not attempt to speak further of the meeting at this time, only to say that we believe, after reading the report of the proceedings, all those within 200 or 300 miles of Chicago will wish they had been present.

C. R. Horrie & Co., of Chicago, have been getting quite a good deal of free advertising lately—but of such a nature that we think it will hardly tend to increase their business very much. Gleanings for Jan. 1 refers to our recent explanation concerning them, and adds: "Complaints have also come in to us, and, for the present at least, we must caution bee-keepers against sending them honey."

Several of our readers have insinuated lately, in private letters, that we had "opened our books" to Horrie & Co., furnished them our list of bee-keepers' names, etc. Such suggestions are utterly false. We have never given or sold to any commission firm, or any one else, any of the names of bee-keepers in our office.

Editor Hutchinson, in the Bee-Keepers' Review for October, when giving the firm in question a very complimentary notice, said: "They bought my entire list of names of bee-keepers in the United States, and sent out circulars soliciting consignments." But that is nothing against Mr. Hutchinson, for Horrie & Co. could easily have gotten those names through a third person. But we question the advisability of offering special lists of names publicly. Still, that is a matter for each list-holder to determine.

But what has surprised us most is this: That any intelligent bee-keeper should permit himself to be induced

to ship his honey to a *new* firm that claim to be able to get so *much* higher prices than those quoted by old honey firms almost the next door to them. Surely, any one could easily have compared the prices quoted in the mailed circulars with those published in the bee-papers, when it would have been seen at once that something was wrong.

It pays to watch the market quotations of old and reliable firms, and not accept the "say so" of some who have not learned the A B C of the business.

Buying Bee-Supplies.—The time will soon be at hand when bee-keepers will think of preparing for another season. What supplies to get, and where to buy them, will have to be decided. Now we believe that all who offer bee-supplies in the advertising columns of the American Bee Journal are entirely reliable—that they will in each and every instance give "value received." So, when you get ready, just send for their catalogues, and when doing so, *be sure* to say you saw their advertisements in the Bee Journal.

The American Bee Journal, its editors nor its publishers have any bee-supplies to sell, and we advise all to patronize those who are the nearest to you, as you will thus save freight or express charges—provided, of course, you get just as good satisfaction. We believe in square and honorable dealing—going where you can get the most of the best for your money.

Bee-Farms in Servia.—It is reported that a new industrial departure of great interest has been taken in Servia, where a society for bee and fruit culture has been established. This society seeks to introduce a system of bee-keeping on scientific principles, and of developing the industry on a profitable basis throughout that country, where until lately the peasants have been in the habit of keeping their bees in conical straw-skeps daubed with mud or plaster, and destroying the bees to obtain the honey. It is probable that the society will provide the peasants with cheap straw-skeps with supers, as well as bar-framed hives and other desirable agricultural appliances. The farm of the society contains about 200 hives, placed in regular rows over the ground, six feet six inches from each other, facing north. These hives are all on the bar-frame principle, and of the pattern generally known as Dzierzon hives, and they contain about 80 pounds of honey in the comb when full. They are made of wood, with straw sides, and cost about \$2.25 each. The bees appear to be a species of the common bee (*Apis mellifica*), but are rather small in size and unusually tractable. The Italian bee (*Apis ligustica*) does not succeed well in Servia, becoming quickly merged into the indigenous stock.

The bee-farm is provided with two centrifugal honey-extractors of very simple design, but perfectly practical. After extraction the honey is put into glass bottles, with neat screw tops, imported from Austria, containing respectively half-pound, one pound, and two pounds. The price of the honey is about 17 cents a pound, exclusive of the bottle, for which an extra charge is made. The wax is sold to the wax dealers for making into church candles, and realizes about 30 cents a pound.

The importance of encouraging bee-culture is evidently realized by the members of this society and others interested, and the introduction of a law is in contemplation obliging all priests, schoolmasters, and certain others holding employment under the government to turn their attention to the keeping of bees.

With a favorable location and a natural ability and inclination for the business, there is no question but bee-keeping is one of the most profitable pursuits in this great State of ours, so noted for its many and profitable industries.—HON. GEO. E. HILTON, of Michigan.

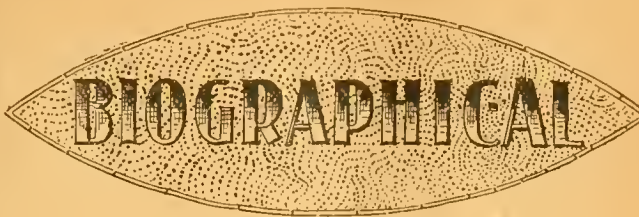

MR. ADRIAN GETAZ.

The subject of this sketch was born in Aigle, Canton de Vand, Switzerland, on April 28, 1844. His father went to France when Adrian was only 3 years old; he was a preacher, in the employ of the Evangelical church of Geneva and Lyons. He preached in several parts of France to congregations of protestants, scattered among the Catholic population. His work was more of a missionary than a regular pastor.

In 1853, soon after Napoleon III ascended the throne, an order founded on a constitutional technicality was issued, ordering all the small protestant churches not under the state supervision to be closed. This was done in order to please the Catholic priests' party that was very strong at that time. Mr. Getaz and three other pastors refused to discontinue preaching, and were tried and condemned to heavy fines and imprisonment. After six weeks passed in jail, they were pardoned and released.

In 1859 the senior Getaz took charge of the estates of a large landowner, beside continuing preaching to a small congregation of protestants. He became a prominent agriculturist, and won many medals at the fairs. He instructed and taught his children himself, not only in classical things, but also along practical lines, such as bookkeeping, surveying, civil-engineering, etc. Adrian was the oldest child. His father and mother are now dead, but the eight children are living—three boys and one girl this side of the Atlantic, and three girls and one boy still living in Europe.

Mr. Getaz followed the same business as his father, that is, agricultural manager for some landowner, and finally entered, in that capacity, in an industrial school. Soon after, the directors found out that he could do other work than that, and immediately assigned him a place as professor, and insisted that he should take a diploma at once, and push in that direction. He also had charge of the bakery department during a part of the time. But a change of directors brought out an entire change in the personnel of the institution, and Mr. Getaz then went to Knoxville, Tenn., in 1870. He worked successfully at a sawmill, as a farm hand, in a broom-factory, in a shoe-factory, and finally bought a farm on which he lived several years. Farming did not prove very satisfactory; the land was poor, and what was worse, the panicky times of 1873, and the following years, caused farming products to sell there at prices ridiculously low. Being of a mechanical turn, he was his own blacksmith and wood-worker, and did a good deal of work of that kind for the neighbors. He also did work as carpenter, mason and well-digger—in fact, almost anything that came along, including teaching music and school, and firing a threshing-machine engine.

Mr. Getaz finally went back to Knoxville, and worked with Stephenson, Getaz & Co., as bookkeeper, paymaster, lumber inspector and draughtsman; later as bookkeeper and cashier of the Knoxville Mantel and Cabinet Co., of which he was a stockholder; now as bookkeeper for his brother, D. Getaz, who is a builder and contractor.

Mr. Getaz says: "Very few bee-keepers have done as many different kinds of work as I have, excepting, perhaps, Mr. Heddon, who, I understand, among other things, has been a dancing-master and Sunday-school superintendent. I have always wondered if the two were at the same time."

Mr. Getaz does not remember what year he began bee-keeping, but it was about eight years ago when he began with four colonies. A few nuclei bought later were a failure, on account of robbing. He keeps now between 50 and 60 colonies, in two apiaries—one about 3 miles from the city, and the other 9 miles away. The results, or profits, of his bee-keeping are not very brilliant, though his average yield per colony has never been as low as Dr. Miller's was last year. Bees have been only a side-issue with him, and sometimes woefully neglected, when other work was pressing. Another reason is, that he has been experimenting and learning, rather than working for profit. A third reason is the presence of bee-paralysis. He does not think that bee-keeping will ever be

profitable where he is until they get entirely rid of that disease.

Mr. Getaz was converted in 1876, while living on the farm, after a very earnest revival meeting. He joined the Southern Presbyterian church, and since that time he has taken an active part in Sunday-school work, sometimes as teacher, twice as superintendent, and is now assistant superintendent. He has had charge of the singing for several years, and has been organist and chorister the balance of the time. He is also a member and officer of a Christian Endeavor society.

THE EDITORS.

Southern Department

CONDUCTED BY

DR. J. P. H. BROWN, AUGUSTA, GA.

[Please send all questions relating to bee-keeping in the South direct to Dr. Brown, and he will answer in this department.—EDS.]

Report of the International Bee-Keepers' Congress at Atlanta, Ga., Dec. 4 and 5, 1895.

(Continued from page 26.)

AFTERNOON SESSION, DEC. 5.

First was the following essay by J. D. Fooshe, of South Carolina, on

Bee-Keeping a Profitable Industry.

The question is often asked, "Will it pay to keep bees?" I answer, "Conditionally."

To the wide-awake, energetic, practical bee-keeper, it will pay as an industry alone, but I prefer to treat the subject as connected with other industries, and especially with farming.

It will not pay those who build air-castles with great piles of honey, and give no attention to their bees. Like all other industries the money comes according to interest manifested.

There are those in all departments of business who do not succeed for want of attention.

Farming will pay, but it will pay better if a poultry yard or an apiary is connected with it, or even both may be connected with it, and both made to yield a handsome profit.

I am one that believes in diversifying our interests so that if we fail in one, another will succeed. I would not advise keeping bees as a livelihood, because, like all other enterprises, it sometimes fails even with the most practical and experienced bee-keeper; but on the other hand, if we have something to fall back on, we would not feel so entirely "broken up" if our bees gave no profit. A little attention at the right time will invariably insure success. Honey alone is not the only source of profit to be derived from the apiary.

We now have queen-rearing reduced to scientific principles, and perhaps an apiary run for queens alone will pay better than one run for honey alone. If you will pardon a personal allusion, I have derived more profit from the sale of bees and queens than I ever did from honey. Queens are now permitted to go by mail, not only through the United States and Canada, but to foreign countries also. Bees are also shipped successfully in any quantities long distances by express; but all are not expert at queen-rearing and shipping bees. Some, therefore, will have to derive profit from honey and wax.

I would advise all who keep bees, even for honey alone, to procure modern hives and fixtures.

Section honey is so much more attractive and nice to eat than the honey that is taken from the old-fashioned box-hives, filled with pollen, that there is no comparison; and so with extracted honey in comparison with what is termed "strained honey" flavored with pollen.

The practical, wide-awake bee-keeper should know his locality, and should be acquainted with every source of honey. I will mention some of the flowers that yield honey. The first with us here in the South is tag-alder and maple—these are only pollen-plants, and answer a good purpose for building up a colony by stimulating the queen. Next is fruit-bloom, and,

if honey is gathered from it, it usually excites swarming. The apple-bloom produces in favorable seasons more nectar than other kinds of fruit-bloom. Willow blooms a little before apple, and is also a fine honey-plant. In some localities white clover thrives and gives good forage for bees, but it does not thrive in the South as in the North.

Poplar and blackberry come next, and where poplar abounds bees are sure to do well while it is in bloom. Persimmon is also a fine honey-plant, but honey sometimes granulates that is gathered from it. During the bloom of willow, apple and poplar, bees usually swarm, but should be prevented from sending out more than one swarm to the colony.

After swarming-time we usually have a dearth of honey begins, say the latter part of June, and continues until cotton blooms profusely, from which source bees gather a nice grade of honey. After cotton, field-peas, and last, but not least, in October the golden-rod and asters are in full bloom, and our bees gather more honey and a better quality than from any other source. From these they gather their winter stores, and usually crowd the queen out from laying by filling all the cells with honey.

I have been astonished time and again that in view of the many sources we have for honey, that we, of the South, let it go to waste.

Our Northern friends are confronted with more difficulties than we are; for while they are puzzled over the winter problem, we rest serenely, and leave all our bees to care for themselves on the summer stands. Their season is much shorter than ours, and their winters more severe, yet it seems to me that they are more successful with bees than we are. There are more people in the North who keep bees than in the South, and why they succeed so much better than we of the South I cannot tell, unless on account of the attention they have to give their bees, and the outlay necessary to carry their bees through the winter, causes them to appreciate them more; for that which costs no trouble, time or outlay, seldom yields much profit.

Until recently there was hardly a bee-journal published in the South, but there are many published in the North. I often ask, Why this difference? I know that these facts exist, but cannot tell why, for certainly we have largely the advantage, both in climate and season.

There is no profit from bees to those in the North or in the South who do not take an interest in and give proper attention at the right time. I believe that a barrel of honey can be secured at less cost than one can grow a barrel of syrup. A good colony of bees will often gather 50 pounds, or more, of honey in favorable seasons.

Bee-keeping does not require strength or much capital. Ladies are as capable of making bee-keeping profitable as men; and in many instances more so, and they are more apt to succeed on account of their carefulness in handling the bees. Nearly all the work required in an apiary can be done by a lady.

There is an idea that bees will not sting some people, but it is because some are not afraid of them, and are less nervous. Hybrids are usually crosser than pure Italians, but all that I ever had anything to do with would sting if angered, or misused, or treated roughly. Bees are not vindictive without a cause, but they are no respecters of persons. Sometimes they are more docile, and easier to handle, than at others, and especially when filled with sweets.

There are but few kinds of business that give any profit without toil and labor. We people of the South, and especially farmers, have grown cotton until we take little interest in anything else. Last year our great hobby failed us, especially in profit, so that we became very much discouraged, and began to cast about for a diversity in order that we would not be so dependent upon one thing. I would recommend bee-keeping as a source of profit, but not in the old-fashioned way of box-hives, etc. It costs but little to get a beginner's outfit, and it very rarely, if ever, interferes with farm work.

Many people have kept bees, but did not succeed on account of the moth-worm; but worms very rarely, if ever, destroy a colony of bees in a normal condition. A colony of bees with a defective queen, or no queen at all, will sooner or later succumb to the awful enemy unless helped by the apiarist. A colony of bees will no more thrive without a queen than plants will thrive without sunshine and moisture.

I would advise every person who keeps bees to subscribe for a good bee-journal, which will give light on the subject, and will pay many times the cost. No one now-a-days can succeed without being posted in his or her profession; and I do not know of anything that has made greater improvement than bee-keeping since the movable-frame hives were introduced by Mr. Langstroth.

I would not give the bright side of bee-keeping alone, and

only hold out the idea that there was profit all along, but, like all other industries, it has its discouragements. Sometimes bees fail to gather honey because, when the plant is in bloom, it is too cold or too wet, and in various ways discouragements and failures may come. But, upon the whole (and I judge from actual experience), there are no more failures in bee-keeping than in growing crops.

Some years, on account of drouth or wet, we fail to have corn, or cotton, or grain. So with bees; they are just as liable to fail to give profit, from a combination of causes, as our crops are.

I would advise beginners to start with one or two colonies, and increase as they learn to handle and profit by them. To be successful with bees one must love to work with and care for them, and by them they will find that a kind Providence has taught us many useful lessons. J. D. FOOSHE.

H. C. Simpson, of South Carolina, said he took 700 pounds of cotton-bloom honey from 30 colonies. This was followed by a very interesting lecture by Frank

Benton, on "Forage crops which are adapted to the South, and which are honey-producers." Mr. Benton divided the crops into five divisions in the order of their value as follows:

- 1st. Alfalfa (*Medicago sativa*).
- 2nd. Melilot or sweet clover (*Melilotus alba*).
- 3rd. Sainfoin (*Onobrychis sativa*).
- Alsike clover (*Trifolium hybridum*).
- White clover (*Trifolium repens*).
- Sulla clover (*Hedysarum coronarium*).
- Crimson, scarlet, or Italian clover (*Trifolium incarnatum*).
- 4th. Serradella or bird's-foot clover (*Ornithopus sativa*).
- Cowpea (*Vigna sinensis*).
- Japan or bush clover (*Lespedeza striata*).
- Russian or hairy vitch (*Vicia Villosa*).
- 5th. Rabbit's foot clover (*Trifolium arvense*).
- Saccaline or giant knotweed (*Polygonum sachalinense*).
- Goose or furze (*Ulex Europaeus*).

[Continued next week.]

SECTIONS, BEE-HIVES, SHIPPING-CASES

We make a Specialty of these Goods, and defy Competition in

QUALITY, WORKMANSHIP AND PRICES.

Write for Free Illustrated Catalogue and Price-List.

G. B. LEWIS COMPANY, Watertown, Wis.

Be sure to mention the American Bee Journal when you write.

MAKE A NOTE OF THIS!

ALL READY FOR 1896.

Appreciating the advantages for procuring Basswood Lumber, and the splendid Shipping facilities of Marshfield, we have established a Factory for the manufacture of

THE ONE-PIECE SECTION.

We have all new and up-to-date Machinery for the manufacture of the "One-Piece Section." Have a Saw-Mill in connection with our Factory, enabling us to get the finest material to be had, for "One-Piece Sections."

Write for Price-List, and also for prices on Sections in any quantity you may want.

THE MARSHFIELD MFG. CO.,

MARSHFIELD, Wood Co., WIS.

Dec. 18 1895.

49Dtf

Mention the American Bee Journal.

CARLOADS

Of Bee-Hives, Sections, Shipping-Cases, Comb Foundation, and Everything used in the Bee-Industry.

I want the name and address of every Bee-Keeper in America. No reason why you cannot do business with me. I have

Cheap Lumber and Experienced Workmen; a good Water Power Factory and know how to run it. I am supplying Dealers as well as consumers. Why not you? Send for Catalogues, Quotations, etc. W. H. PUTNAM, 1D RIVER FALLS, Pierce Co., Wis.

Mention the American Bee Journal.

Potatoes

—10 New Varieties, \$1. Package BEET, CABBAGE, CUCUMBER LETTUCE, TOMATO SEEDS, 10c Catalogue Free. Address,

J. F. MICHAEL,

GREENVILLE, OHIO.

1D6t

REDUCED RATES!

Bingham Bee-Smokers & Honey-Knife. Best on Earth. 16 years with but one complaining letter. 5 Sizes—60c, 70c, \$1 00, \$1 10, \$1 50, postpaid. Send for Illustrations.

1Dtf T. F. Bingham, Farwell, Mich.

Mention the American Bee Journal.

MUTH'S

HONEY EXTRACTOR PERFECTION Cold-Blast Smokers,

Square Glass Honey Jars, Etc.

For Circulars, apply to CHAS. F. MUTH & SON, Cor. Freeman & Central Aves., Cincinnati, O. Send 10c for Practical Hints to Bee-Keepers.

PATENT WIRED COMB FOUNDATION

Has No Sag in Brood-Frames

Thin Flat-Bottom Foundation

Has No Fishbone in the Surplus Honey.

Being the cleanest is usually worked the quickest of any Foundation made

J. VAN DEUSEN & SONS, Sole Manufacturers, Sprout Brook Montgomery Co., N. Y.

Mention the American Bee Journal.



NEW MAMMOTH

Poultry Guide for 1896. Finest book ever published, contains nearly 100 pages, all printed in colors, plans for best poultry houses, sure remedies and recipes for all diseases, and how to make poultry and gardening pay. Sent post paid for 15c. John Bauscher, Jr., box 94 Freeport, Ill.

49A 13t Mention the American Bee Journal.



TRY US. We sell your Poultry, veal, fruits and all products at highest prices. DAILY RETURNS. For samples, prices and references, write F. L. SAGE & SONS, 183 Reade St., N. Y. WHEN ANSWERING THIS ADVERTISEMENT, MENTION THIS JOURNAL.



OUR POULTRY ANNUAL

and Book of Valuable Recipes, 64 large pages, contains 8 beautiful colored plates of fowls, gives description and prices of 45 varieties, with important hints on care of poultry, and pages of recipes of great value to everyone. Finest Poultry Book published for 1896. Postpaid only 10 cts. C. N. Bowers, Box 24, Dakota, Ill.

52A1 Mention the American Bee Journal.

Question-Box.

In the multitude of counsellors there is safety.—Prov. 11-14.

The Largest Yields of Honey.

Mr. E. T. Flanagan has been whistling up his courage by gathering from a number of bee-keepers reports of their best yields, which he gives in the Progressive Bee-Keeper for January. These reports make very comforting reading.

He sent the following questions to a number of bee-keepers, who responded, as will be noticed:

1st. How large a yield of honey (comb or extracted) have you ever secured from one colony in one season?

2nd. What was the largest amount of honey you ever secured in one season, and the number of colonies and race of bees that gathered it?

The replies are as follows, beginning with Mr. Flanagan's answer:

E. T. Flanagan, Belleville, Ill.—At my home apiary, while I always get enough to keep the bees breeding well, I seldom have any surplus, and often have little enough to winter on. That is what has forced me to keep from three to five out-apiaries, the nearest not less than eight miles from home. At my out-apiaries I always have some surplus and plenty to winter on, and generally enough to help out the home apiary. Still, meagre as is the flow here at home, as a rule, I have on several occasions secured a fine lot of surplus, and the strangest part of it to me was the fact that the flowers did not appear to be more abundant than usual, but they were overflowing with nectar, and it is this fact that makes me so sanguine that good yields of honey may be looked for in the near future. There must be a change for the better, as it could hardly be worse. The largest yield of honey I ever had from one single apiary was from 35 colonies, spring count, increased to 70, and secured 5,500 pounds of comb honey, and 1,000 pounds of extracted. This is not an extraordinary yield by any means, but was very good for my locality, and could I do as well in proportion to the number of colonies, every year, I would be well satisfied.

Mr. Hammond, Malone, Iowa.—The largest amount of comb honey I ever

secured from one colony was 188 pounds in well-filled sections, and a lot of unfinished ones that were not counted. The bees were leather-colored Italians. The largest yield of extracted honey from one colony, that were given more starters of foundation in the super, and had to build their own comb, was 267 pounds. This honey was gathered from white clover. The average yield throughout the apiary was 120 pounds.

Mrs. L. C. Axtell, Roseville, Ill.—The season of 1882 we received 39,000 pounds of honey, mostly comb, in first-class sections, from 180 colonies, and increased to 295 colonies, being a little over 216½ pounds per colony. Our greatest yield from one colony (a good hybrid) was about 300 pounds. Of the 39,000 pounds only 500 was extracted. The honey netted us in Chicago 12½ cents per pound.

H. W. Funk, Bloomington, Ill.—I got in the year 1882, from 75 colonies, 15,593 pounds of honey. One-half or more was comb of the finest quality, and averaged 207 pounds per colony. It rained so much that there was not much honey from white clover gathered, but heart's-ease covered every field, as it was so wet that many fields were not planted to any crop. Since then nearly all the farms have been tilled, and heart's-ease and clover are both scarce, and the outlook not encouraging.

J. W. Bittenbender, Knoxville, Iowa.—The largest yield from one colony, spring count, was 208 pounds of comb honey. Extracted honey, 3,400 pounds from 45 colonies. Hybrid bees.

Frank Coverdale, Delmar, Iowa.—I really do not know what my best colony gathered, but my best yield was in 1886, 208 pounds to the colony, half extracted. Bees were blacks, hybrids, and Italians. The Eastern Iowa Beekeepers' Association showed an average, in 1889, of 212 pounds per colony, nearly all comb.

Chas. Dadant & Son, Hamilton, Ill.—The largest crop of honey we have ever harvested was harvested in 1889, if we remember right, from about 400 colonies of bees, mostly Italians, with some hybrids and a few blacks—45,000 pounds. We cannot give the largest amount harvested by one colony, for the reason that during our best seasons we were too busy to waste time weighing the crop of a part of the hives, and every time that we have started weighing the crop harvested by one single colony, some other colony managed to get far ahead of this. If the honey was all harvested at once, it would be but little trouble to weigh the best, but we have extracted as many as five times from one apiary in one season, and we believe that during that season some colonies yielded as much as 400 pounds, and perhaps more.

L. W. Baldwin, Independence, Mo.—I will say that the best report from one colony that I remember was 150 pounds of comb honey. The bees were pure Italians. The best crop I ever had was in 1886, when I took 12,000 pounds in one-pound sections from 150 colonies. It was nearly all from white clover, and was very fine. The bees were nearly all pure Italians. Myself and sons have now about 600 colonies in winter quarters.

James Heddon, Cass Co., Mich.—I am unable to answer further than to say

that I once took 410 pounds of surplus from one colony not fussed with in any way. The hive had no movable frames at all; 362 pounds of the surplus was comb, and 48 was extracted honey. This was about 25 years ago, when we had fresh moisture at the roots of the basswood trees. From 48 colonies, that season, the yield was very large (see back number of the American Bee Journal). One year I began an out-apiary with 102 colonies; increased to 225. I kept no account of the number of pounds, but I did of the cash I received from it, and it was \$1,070.00. It cost me less than \$70 for labor. I once hived a full prime swarm, on 10 Langstroth frames, during a copious basswood flow. After three days I opened the brood-chamber (all there was to the hive) to see how the queen was laying. I found about 50 square inches of comb in the center of one frame, empty and shining, but not an egg in any cell. All the rest was solid with basswood honey, and partly sealed over. I threw all out clean, and got about 70 pounds of honey. Next day at precisely the same hour (10:30 a.m.) I opened the hive to see if my queen was then laying, and I found so much honey (all unsealed and ¾ ripe) that I threw it all out and weighed it. It tipped the scale-beam at 29 pounds and 13 ounces. This is my best record. One year I got \$800 from 16 colonies, and increased to 33. I sold the honey (it was extracted) in glass jars, and it netted me 32 cents a pound. These were the days when Nature favored us. Bees paid then.

B. Taylor, Forestville, Minn.—The largest yield from a single colony in comb honey was 265 pounds of marketable honey. There were some unfinished sections that were not counted. The bees did not swarm, and were first-cross Italian hybrids. The best yield I ever had from a whole yard was 143 pounds per colony from 45 colonies, spring count. This was finished comb honey, and there was a quantity of unfinished that was not weighed. The bees were blacks, with a slight mixture of Italian, but mostly pure blacks. They were increased to 70 colonies.

G. M. Doolittle, Borodino, N. Y.—Largest yield of comb honey from one colony, 309 pounds. Largest yield of extracted honey from one colony in one season, 566 pounds. Largest crop in one season, 11,492 pounds, from 69 colonies; mostly comb; from choice Italian bees.

Dr. C. C. Miller, Marengo, Ill.—My largest yield was in 1882—16,549 pounds from 172 colonies, comb honey. I don't know the largest yield per colony, but never had anything extraordinary. I'm not in a good region, having nothing but clover for surplus.

Mrs. L. Harrison, Peoria, Ill.—The best yield from one colony was 200 pounds, Italian bees. Largest yield in one year, 5,000 pounds, mostly comb, from 80 colonies, spring count; increased to 120 colonies. Italian bees.

We should be glad to add to the foregoing replies, if any others will report their large yields in a very condensed form. We would like to have replies particularly from States not represented to the list given.

Mr. Flanagan, in closing his article, has these encouraging words to offer :

We can hardly conceive of circumstances under which extracted honey would bring 32 to 40 cents, and comb honey 50 cents per pound. Those days are gone forever, and the possibilities of realizing \$800 from the product of 16 colonies in one season, as given by Mr. Heddon, is not for us; but that there will be good old-fashioned seasons again, for us of the Middle Western States, I have no more doubt than I have of my existence; and, as in other lines of business, when, owing to low prices, bad seasons, and gloomy outlook, so many are turning their attention to other things, now is the time to hold on. Give more attention than ever to every detail; see that all things are in the best possible order, and be ready to take advantage of the opportunities for success, as they present themselves.

DO YOU WASH DISHES ?

No need of it. The Faultless Quaker will do it for you and save time, hands, dishes, money, and patience; no scalded hands, broken or chipped dishes, no muss. Washes, rinses, dries and polishes quickly. Made of best material, lasts a lifetime. Sell at sight. Agents, women or men of honor desiring employment may have paying business by writing now for descriptive circulars and terms to agents.

The QUAKER NOVELTY CO., Salem, O.

Mention the American Bee Journal. 39A261

WANTED.

10,000 pounds of BEESWAX, for Cash. Address, **LEAHY MFG. CO., Higginsville, Mo.**

PEERLESS FEED GRINDERS.

Old Reliable Absolutely Guaranteed

Will grind to any desired degree of fineness. Ear Corn, Oats, Etc., and do more of it than any mill on earth. Write at once for prices and agency. There is MONEY IN THEM. Quality Best and Prices Right.

JOLIET STROWBRIDGE CO., Joliet Ills.,
Farm Machinery, Carriages, Windmills, &c.

Mention the American Bee Journal. 34A26

The Elephant Never Checks His Trunk

He must have it handy. For the same reason the coil of the serpent is not stowed away in the end of its tail. Like-wise (ly) the Page Fence is coiled its whole length, and is always ready for business.

PAGE WOVEN WIRE FENCE CO., Adrian, Mich.

Mention the American Bee Journal.

Will Exchange —Concord Grapevines for Fruit, Grain or offers.

50A **F. C. Morrow, Wallaceburg, Ark.**

Mention the American Bee Journal

THIRTY THOUSAND POUNDS BEESWAX

Is our present stock for this year's sales of Foundation. But still **We Want More Beeswax** and pay a good price.

Don't Delay Ordering Your **FOUNDATION**. You will pay more by and by than you would now. Remember that we make the **BEST**, and everybody acknowledges this.

Now is the time to read the work of the **Late Father Langstroth**—

Langstroth on the Honey-Bee, Revised.

The Price of this Work is now Reduced from \$1.40 to \$1.25, by mail.

Send us your address for Catalogue of Bee-Supplies, etc.

CHAS. DADANT & SON,

HAMILTON, Hancock Co., ILL.

Mention the American Bee Journal.



There Is No Doubt About the **MERIT** of **THE KEYSTONE DEHORNING KNIFE** and the horns are off close. Write for circular. **A. C. BROSIUS, Cochranville, Pa.**

YOUR BEESWAX!

UNTIL FURTHER NOTICE, we will allow 30 cents per pound for Good Yellow Beeswax, delivered at our office—in exchange for Subscription to the **BEE JOURNAL**, for Books, or anything that we offer for sale in the **BEE JOURNAL**. Or, 26 cts. cash.

GEORGE W. YORK & CO.,

CHICAGO, ILLS.



Promptness Is What Counts!

Honey-Jars, Shipping-Cases, and everything that bee-keepers use. **Root's Goods at Root's Prices**, and the best shipping point in the country. Dealer in Honey and Beeswax. Catalogue Free.

Walter S. Powder
162 Mass. Ave. INDIANAPOLIS, IND.

Mention the American Bee Journal.

\$1.00

Sent to me gets \$1.75.

- 1—The American Bee Journal for one year to a new subscriber.
- 2—A 50c. copy of "Business," or How the Seller Reaches and Talks to the Buyer.
- 3—A 25c. copy of the Daily News Almanac for 1896.

I wish a representative in every school and college in the United States. If you wish further particulars inclose in your letter to me a self-addressed and stamped envelope.

E. M. PRATT,
232 South East Ave., OAK PARK, ILL.
Self-Help Supplies.



SUCCESSFUL INCUBATOR
Our magnificent new catalogue giving full information regarding artificial Hatching & Brooding and treatise on poultry raising sent for 4c stamps. Circular free.

49A13t Mention the American Bee Journal.

The Patent Wood Veneer FOUNDATION

has no sag in full sheets. EXTRA THIN Foundation 13 square feet to the pound. Working Wax into Foundation—if sent to me—a specialty. Send for prices, samples & Catalogue. Wax wanted. **AUG. WEISS,**

2A5t HORTONVILLE, WIS
Mention the American Bee Journal.



ONE MAN WITH THE UNION COMBINATION SAW

Can do the work of four men using hand tools, in Rippling, Cutting-off, Mitering, Rabbeting, Grooving, Gaining, Dadoing, Edging-up, Jointing Stuff, etc. Full Line of Foot and Hand Power Machinery. Sold on Trial. Catalogue Free.

SENECA FALLS MFG. CO.,
46 Water St., SENECA FALLS, N. Y.
1A1y Mention the American Bee Journal.

33 cts. a Pound

We allow **For Beeswax**
In Exchange for **—SUPPLIES.—**
1896 Circular Now Ready.
I. J. STRINGHAM,
105 Park Place. NEW YORK, N. Y.

IF YOU WANT THE BEE-BOOK

That covers the whole Apicultural Field more completely than any other published, send \$1.25 to Prof. A. J. Cook, Claremont, Calif., for his

Bee-Keeper's Guide.

Liberal Discounts to the Trade.

WANTED!
10,000 pounds of **BEESWAX**, for Cash. Address, **LEAHY MFG. CO., Higginsville, Mo.**
Mention the American Bee Journal.

The Rural Kansan

Is an Agricultural Journal for the busy farmer. It embraces Bee-Keeping and every department of industry connected with the farm. 30 cts. a year, monthly. Sample Free. A Full Line of **Higginsville Bee-Supplies** on hand. CATALOGUE FREE.
HENRY L. MILLER,
355 Shawnee Ave., TOPEKA, KAN.
1A13t Mention the American Bee Journal.

SELLING OUT.

To close out, I offer my Improved Queen-and-Drone Traps per 1/2 doz. in the flat, at \$1.75; per doz., \$2.75; per 25, \$5.00.
Individual Right to manufacture and use, 50 cents; Township Rights, \$1.00; County Rights, \$5.00.
HENRY ALLEY,
1A1f WENHAM, MASS.

General Items.

The Swarming Bees Ahead.

I noticed in the Bee Journal during the last year that a great many bee-keepers prefer non-swarming bees; that is, I suppose, bees that don't swarm. Now, my experience is just the opposite. In June, 1893, I purchased two colonies of Italian bees in the dovetail hives, from an Ohio bee-keeper. The colonies were the same throughout. One I kept, and a neighbor got the other. They were wintered on the summer stands, and when fruit-trees bloomed I gave my colony a set of 48 sections, so they should not swarm. My neighbor let his bees have their own way, and they swarmed May 26, and again June 3. Later on he gave each colony—now 3—a set of 24 sections, and by taking out a few boxes when full, and giving empty ones, he managed to get 80 pounds of honey and two swarms besides. I, by giving empty sections as fast as the first were filled, got 74 pounds of honey and no swarms. How is that for non-swarming bees? I can't see the point. If there is a point, I think it is in favor of swarming bees.
PAUL WHITEBREAD,
Hobbie, Pa., Dec. 13, 1895.

Short Season and Short Crop.

The past season was a short one for the bees. The lack of snow last winter caused nearly all the white clover to kill out. Late frosts killed nearly all the fruit-bloom, and an off year with the basswood bloom, cut short the spring crop. There is lots of golden-rod here, but I have never seen my bees at work on it; the same in regard to strawberries. This is a timbered country, and bees get a large portion of their honey from that source. Buckwheat helped them out some, but there is but little sown in these parts. My bees beat all former records in the line of swarming, but not much surplus honey. I put the bees into the cellar Nov. 30, in good condition.

I was much interested in reading Query No. 996, giving a remedy for preventing bee-robbing, as a few nights before I had miscreants make a raid on my bee-yard, and opened 13 hives and carried off 16 frames of honey. They were not green hands, for the job was neatly done.

G. W. Demaree speaks of the freaks of bees. Here is one that has not come to his notice: In October I heard the bees buzzing and flying around a lilac bush. There was no bloom at the time. On close examination I found they had flown into the center of the bush, and cut off pieces of the leaves as large as their bodies, and some had more than they could get away with, and fell down in the grass. Now, what did they do with it? Can Dr. Miller give us any light on the subject?

I take pleasure in reading the Bee Journal all through. I am nearly 75 years old, and have plenty of leisure. **R. HOWELL,**
Gillett, Wis., Dec. 6, 1895.

Commission Men, Marketing, Etc.

In the Bee Journal of Nov. 28, I see the editor scores a Chicago commission house. It is precisely such men who have given commission men such a bad repute, that the whole Pacific Coast is afraid of them. It doesn't make much difference what we ship—if we let the property get into their hands, we are at their mercy, and get swindled three times out of four.

I long ago discovered that bees alone, in this part of the country, would not keep the "pot boiling," so I have added farming, fruit-raising, etc. I once shipped seven carloads—75 tons—of fresh grapes, as fine as ever left this Coast, having two cars sold in Minneapolis, and five in Chicago, in the regular fruit auction houses. Those grapes simply paid freight, and entailed a net loss to me of a little over \$2,500.
Again, I have shipped many carloads of

YOUR PAST, PRESENT, AND FUTURE.

You have suffered much in the past. Many of your days have undoubtedly been darkened by the shadow of sickness and ill health. You have oftentimes felt gloomy and despondent. At the present moment you may not be feeling just as well as you ought to feel. Perhaps you are experiencing the first symptoms of some serious ailment which is lurking in your system. Unless it is promptly checked there may be a long siege of illness in store for you. Now is the time to

STOP AND THINK

about the actual state of your health.

If you are suffering from tired feelings, headaches, backaches, biliousness, debility and other symptoms, remember that your present and future are in your own hands. You can get that most precious blessing of sound health, as others have done, by the aid of Warner's Safe Cure. Volumes could be filled in telling of what it has done for men and women who were completely run down in health. Its splendid tonic effects give new life and energy to those who are weary and worn out.

If you are in need of help, you should make your present and future happier by putting your system in sound condition. Get a new stock of health and strength by using the great safe cure which builds up the body, purifies the blood and makes the eye brighten with the sparkle of fresh life.

California

If you care to know of its Fruits, Flowers Climate or Resources, send for a Sample Copy of California's Favorite Paper—

The Pacific Rural Press

The leading Horticultural and Agricultural paper of the Pacific Coast. Published weekly, handsomely illustrated, \$2.40 per annum. Sample Copy Free.

PACIFIC RURAL PRESS,

220 Market St., - SAN FRANCISCO, CAL.



REED'S YELLOW DENT

GRAND SWEEPSTAKES
CORN AT
ILL. STATE FAIR
1895.

Best Corn in the whole big Corn State of Illinois, Best Yellow Dent from NORTHERN Division, Best Yellow Dent from ALL Divisions. Best corn shown.

MANDSCHEURI BARLEY, Manshuri!
Sent out last year by the Wis. Ex. Station, Catalogue of Seed Potatoes, Field Seeds and Garden Seeds.

L. L. OLDS - Clinton - Rock Co. - Wis.

Mention the American Bee Journal.

1895 SAVE MONEY 1895

If you want first-class **ITALIAN QUEENS** FOR BUSINESS, Foundation at Wholesale Prices, Hives, suited for the South, or SUPPLIES, send for Price-List—to

J. P. H. BROWN, AUGUSTA, GA.

raisins East, and I find invariably that if the market drops a little, the consignee will try to get out of fulfilling his agreement. So it is with our wine, oranges, lemons, etc., until, in desperation, we are obliged to form combines or unions, and sell only for cash at our stations. The wine producers and orange-growers have the strongest unions, and the result is our crops of that class are now selling for enough to pay cost of raising them. Previous to this, the more a man had to sell the worse he was off, and plenty of men were bankrupted.

Our California honey men are on the right track, and if the proper effort be made, we will have a union that will prevent a few commission men from gobbling the whole crop at their own price.

At this writing bees come in loaded with pollen and honey, and colonies are all very strong, and in fine condition, but we have not yet had rain enough to amount to anything, and unless we get a good one this month, we will have little honey next year.

Mr. J. M. Hambaugh, formerly of Illinois, has bought about 50 acres of land in this valley—1½ miles south of me—has built a barn, and will soon build a house, and be "one of us."

The editor seems to be on the right track to get at the market prices of honey. We look to the bee-papers to keep us informed as to the quantity produced generally over the country, and the prices in the different cities. These prices ought not to vary much, and if they do, we think there is something wrong. Out here we do not expect any more for our honey than Eastern men get for theirs of equal quality, but we think we ought to get as much, gross. Of course, we have more freight to pay, but we expect that. SOUTHERN CALIFORNIA.

Dec. 5, 1895.

First Year's Experience—Sweet Clover

Last spring I purchased six colonies of bees in box-hives. Later I got some 10-frame Improved Langstroth Simplicity hives. I now have 13 colonies in these hives, all in good condition for winter.

The last was a poor season for bees in this locality, as the bees did not work on white clover here. I harvested about 300 pounds of nice comb honey. I think I shall try sweet clover for my bees. Last spring I received a small package of sweet clover seed, which I sowed on April 16; it came up nicely, and reached a growth of about 3 feet. I think I shall grow it more extensively next spring. But here are questions for any one who feels disposed to answer:

If sweet clover is mown about July 10 or 15, will it produce a second crop of blossoms which will yield nectar? For bee-pasturage alone, how much seed should be sown per acre? C. WYNN.

Rolla, Mo., Dec. 7, 1895.

8-Frames—Fastening Foundation.

I commenced in the spring of 1895 with 12 colonies, 6 of which were in the 8-frame hives, 2 in the 10-frame, and 4 in box-hives. I now have 18 colonies, with all but 3 in the movable-frame hives. I prefer the 8-frame Langstroth hive, tiered up three stories high for extracted honey, for this reason: If you don't use the perforated zinc between the frames of the bottom and top stories, you are certain to have some patches of brood in the center frames of the second story, whether you use the 8 or 10 frame hive, it makes no difference. At least this is true with me. So the point I wish to make is this: If you want the surplus honey free from patches of brood, you must give the bees some directly above them instead of on each side as you must do with the 10-frame hive of two stories.

And as to tiering up the 10-frame hive three stories high, you must have an extra early swarm, and a rousing big one, and give them full sheets of foundation if you want the hives filled at all in this locality in one season. So the 8-frame hive is quicker and surer in results. □

Now, don't misconstrue my words, and think I want all my hives of the 8-frame pattern, for if a colony gets too populous for an 8-frame hive, why, I just transfer them into a 10-frame hive during a good honey-flow, and add the extra 4 frames with full sheets of foundation in the center of the top story, and by-and-by a third story is added. Also, as the transferring process is going on, I cut out all the queen-cells so as to have no swarming during that honey-flow, which means twice as much honey as if they had swarmed.

As I do not produce comb honey, my estimates are for extracted entirely, as follows:

Poplar 36 pounds, linden 324 pounds, and buckwheat 108 pounds; total, 468 pounds, from 12 colonies, averaging 39 pounds per colony. I am not in love with buckwheat honey at all; I consider it second quality.

I see a writer from Tracy City, Tenn., asks Dr. Miller how to fasten foundation to frames, so I send a good, cheap way:

If the frames have a comb-guide, lay the foundation with the edge on the comb-guide, as you wish it to hang in the frame. Now take a common porcelain bed-caster, wet it well and roll first a little spot at each end of the comb-guide, then in the middle, then between these three spots, to get it stuck all along. Now roll back and forth with the caster till you see the foundation shine, and the work is done. I have tried this plan with satisfactory results.

J. A. BEARDEN.

Cyruston, Tenn., Dec. 7, 1895.

Quilts on Hives—Placing Hives.

My 14 colonies were put on five Langstroth frames each, standing on end and packed around with granulated cork, with cork cushion on top, about Oct. 10, 1895, in first-class condition.

I see so much in the Bee Journal about "the quilt," "turn up one corner of the quilt," "remove the quilt and take out the combs, etc.," "after returning the quilts, etc." What do people use quilts on top of the frames for? What do they do with the quilts when they get covered with propolis on both sides and stick to the cover, and stick to the frames so that if you want to look at your bees it comes off rip, rip! crack!! ker-r-r!!! rack!!!! There, it's off, and the bees are crazy mad, and "Git for shed" is in order, and leave the bees uncovered until they cool down. I got gloriously over that "quilt" business years ago.

The poem against low-down hives, on page 779, suits me exactly. I've been there and left for good. What any one wants to work all day with his back bent double for, is more than I can tell. I have had boards from the alighting-board to the ground for heavy-laden bees that couldn't make the entrance, to crawl upon, but I have never seen a bee alight six inches from the entrance that did not fly again to get in. About 12 or 15 inches is the right height from the ground for comfort.

My bees got their usual quota of light honey last summer—about 40 pounds per colony—and fall honey enough for winter; and I have enough combs full put away for spring. THOS. THURLOW.

Lancaster, Pa., Dec. 12, 1895.

Season of 1895—Honey-Plants.

I took out of the cellar last spring 20 colonies, one afterwards swarmed out or was robbed, leaving 19 colonies, mostly in good condition, with a good supply of honey and well stocked with bees. In May there were hard frosts which seemed to destroy all the nectar in the willow and wild fruit blossoms, and the bees, after using up the honey they carried over winter, were almost in a starving condition, but with what they gathered, and what sugar syrup they were fed, they came through alive. The scarcity of supplies did not stop them from breeding.

They commenced swarming the last of May, and kept it up till late in August. Five or six swarms left for parts unknown,

and I put about a dozen back in the hives they left; I had 2 colonies robbed and killed, took up 5 and put the bees in with other colonies, and put 33 into the cellar. There are now 52 in the cellar, young and old. Most of them have plenty of stores, but a few of them are very weak.

We got only about 200 pounds of comb honey fit for market, and about 150 pounds in partly-filled sections and in one hive "taken up." Such swarming I never dreamed of before.

There was no flow of honey last fall, although the weather seemed favorable. The previous fall the bees gathered a great deal of honey from golden-rod and asters, but last fall scarcely any.

I might tell of a good many kinks that occurred in the bee-yard, but I guess I will not ask space for that. But I want to say something about honey-plants. It seems to be a well-established fact that plants that offer an abundance of nectar in one locality may be almost worthless in another locality. There are certain plants here that the bees work on constantly and busily from morning till night. The principal of which are mignonette, phacelia, borage and clarkia; on poppies in the morning, and on chickory in the forenoon. And of those they work on more or less are balsams, marigolds, datura, nicotiana, hyssop, radish, cabbage and turnip flowers. These are all garden plants. Judging from the way bees work on them, I believe that one acre of phacelia or mignonette would produce more honey than ten acres of buckwheat.

H. P. WILLSON.

Bathgate, N. D., Dec. 16, 1895.

Results of the Past Season.

The season of 1895 opened here very good. Fruit-bloom was plentiful, and the bees got to breeding up nicely, then the cold weather set in. After that white clover came into bloom, but the bees did not gather much honey from clover. The linden flow lasted here about one week. It got too dry all at once, and we did not have any rain until November. I extracted from 25 colonies, during the linden flow, 1,600 pounds of honey; 8 colonies gave me 200 pounds of comb honey in sections, not very well filled.

After the basswood bloom dried up the bees did not get a drop of honey in the fall. The latter part of August I examined my bees, and found my best colonies had only from 5 to 10 pounds of honey. That started me to feeding right off. My feeder holds 25 pounds, and sets over the brood-chamber, like the Miller feeder. In two weeks I had my 35 colonies ready for winter, and up to date they have wintered well on the nice basswood honey.

HENRY BOHLMANN.

Defiance, Ohio, Dec. 16, 1895.

List of Honey and Beeswax Dealers.

Most of whom Quote in this Journal.

Chicago, Ills.

R. A. BURNETT & Co., 163 South Water Street.

New York, N. Y.

F. I. SAGE & SON, 183 Reade Street.

HILDRETH BROS. & SEDELKEN.

120 & 122 West Broadway.

CHAS. ISRAEL & BROS., 486 Canal St.

Kansas City, Mo.

C. C. CLEMOMS & Co., 423 Walnut St.

Buffalo, N. Y.

BATTERSON & Co., 167 & 169 Scott St.

Hamilton, Ills.

CHAS. DADANT & SON.

Philadelphia, Pa.

WM. A. SELSER, 10 Vine St.

Cincinnati, Ohio.

C. F. MUTH & SON, cor. Freeman & Central avs.

Dr. P. C. Gress, of Atchinson, Kans., would like to communicate, confidentially, with all persons who have consigned honey to C. R. Horrie & Co., of Chicago, Ill., with unsatisfactory results.

Honey & Beeswax Market Quotations.

CHICAGO, ILL., Dec. 10.—White clover and linden, in 1-pound sections, sells at 14@15c., but other kinds of white honey sell at 12@13c.; dark and amber grades, 9@10c., of which there is a very liberal supply. Extracted, white, 5½@7c.; amber, 4½@5c.; dark, 4@5c., difference in price of each grade being in accord with its quality, fine flavor always being at a premium. Beeswax, 28@30c., and selling upon arrival. R. A. B. & Co.

PHILADELPHIA, PA., Jan. 3.—Honey has declined in this market during the holidays. Large lots of California honey arriving, and selling at 5c. in 60-lb. cans. We quote: Comb honey, fancy, 16c.; fair to good, 8@14c. Extracted, 4@5½c.; white clover, 10c. Beeswax, 30c. W. A. S.

KANSAS CITY, Mo., Jan. 8.—The demand for comb and extracted honey is fair. We quote: No. 1 white comb, 1-lbs., 13@14c.; No. 2, 12@13c.; No. 1 amber, 11@12c.; No. 2, 10c. Extracted, white, 6@6½c.; amber, 5@5½c.; dark, 4@4½c. Beeswax, 22@25c. C. C. C. & Co.

Demand is slow for all kinds of honey. Best white comb honey sells at 12@14c. in the jobbing way. Extracted, 4@7c. on arrival. Beeswax is in good demand at 22@27c. for good to choice yellow. C. F. M. & S.

NEW YORK, N. Y., Dec. 18.—The market on comb and extracted honey is a little dull at the present time, and we do not expect to have a very great demand until after the holidays. Then we may look for a little better sale, but the bulk of trade is done for the season. That is for comb honey; extracted we expect quite a sale of after Feb. 1, 1896. We quote: Fancy clover, 1-lbs., 15@16c.; white clover, 13@14c.; fair white, 11@12c.; buckwheat, 9@9½c. Extracted clover, 6@6½c.; basswood, 6½@7c.; buckwheat, 5c. Beeswax firm and in good demand at 29@32c. C. I. & B.

Convention Notices.

WISCONSIN.—The annual meeting of the Wisconsin State Bee-Keepers' Association will be held Thursday and Friday, Feb. 6 and 7, 1895, in the capitol building at Madison. The program will appear in due time. Platteville, Wis. N. E. FRANCE, Sec.

COLORADO.—The 16th annual convention of the Colorado State Bee-Keepers' Association will be held Jan. 20, 21 and 22, 1896, in the Horticultural Rooms of the Capitol Building, in Denver. Every bee-keeper is invited to be present and join the society. Duft, Colo. FRANK RAUCHFUSS, Sec.

PATENT GARDEN HOE [No. 522,872] to let on royalty, or will sell for \$3,000; or will give agent fifty per cent. commission to sell. One person will perform more work with one of the hoes than three with other tools. Very easy to work. Extra blades to replace worn ones. Mention this paper. J. H. ANDRE, Lockwood, N. Y.

COMB FOUNDATION WHOLESALE and RETAIL.

Are you going to buy Foundation for Cash, or have you Wax to sell or trade for Foundation and other Supplies? Have you 25 lbs. or more of Wax that you want made into Foundation? If so, do not fail to write me for samples and prices. I make a specialty of working up Wax by the lb., and do it very cheap during the winter. Beeswax wanted at all times. GUS DITTMER, AUGUSTA, WIS. Reference—Augusta Bank. 16Atf

HATCH Chickens BY STEAM—
With the **MODEL EXCELSIOR Incubator**



Simple, Perfect, Self-Regulating. Thousands in successful operation. Lowest priced first-class hatcher made. GEO. H. STAHL, 114 to 123 S. 6th St. Quincy, Ill.

Circulars free. Send 2c. for Illus. Catalogue.

Mention the American Bee Journal. 40E15

READERS Of this Journal who write to any of our advertisers, either in ordering, or asking about the Goods offered, will please state that they saw the Advertisement in this paper.

PERSONAL MENTION.

MR. JACOB ALPAUGH and family landed at North Ontario, Calif., Nov. 18, 1895, where they will make their home. Canada's loss is somebody else's gain.

PROF. COOK writes: "You are making the American Bee Journal very excellent." Thank you, Professor. We're trying to make it worth all any one pays for it.

MR. GEORGE D. LITTOOY, a prominent bee-keeper of Tacoma, Wash., was married Nov. 26, 1895. He says he has "the best 'queen' in Washington" for his wife. "By George," that's the way to look at her. Best wishes to our far-away friends.

MR. H. W. SCOTT, of Barre, Vt., the young and popular President of the Vermont Bee-Keepers' Association, is shown by picture and biographical sketch in Gleanings for Dec. 15. Mr. A. E. Manum prepared the surprise for Mr. Scott.

WILL WARD MITCHELL—the Progressive Bee-Keepers' own poet—is as fine looking as his poems are fine reading. His portrait appears in the January number of the paper mentioned. We won't object if he some day is called "The Second Long-fellow."

MRS. L. C. AXTELL, of Roseville, Ill., has taken to writing on bees again. An article appears in Gleanings from her pen. She has lost none of her old-time enthusiasm for bee-keeping, though the seasons have been very poor in recent years in her locality.

REV. W. E. BOGARDUS, of Brookdale, N. J., said this in a letter dated Dec. 24, 1895:

"The American Bee Journal was never so alive and ably conducted, so instructive and interesting, so progressive and stimulating, as now, since 1884, when I began to take and read it."

MR. L. EASTWOOD, of Waterville, Ohio, when renewing his subscription for 1896, wrote thus: "My 87th anniversary occurs Jan. 26. I still claim to be the oldest practical bee-keeper in the country. I was interested from boyhood in the bees, and have owned them for 61 years."

MRS. LUCY C. SLEASE, of Rosewell, New Mex., when sending her dollar for 1896, said: "The American Bee Journal does not keep its 'wraps' on long when it gets here. As a little boy said the other day, 'I have been here so much that I feel like I was at home.' So we feel like the Bee Journal has just got home each week."

MR. J. C. WALLENMEYER, of Evansville, Ind., last Christmas Eve, helped to organize a local "bee-keepers' union" which promises to be a great success. There were two "charter members"—Miss Jeanette Lois Millard and Mr. W. The wedding invitation sent to us is a beauty. Miss Millard was the "Queenie Jeannette" our good bee-keeping friend has been singing about the past few years. Long may they live, and happy may they be (e).

MR. J. C. BALCH, of Bronson, Kans., we are sorry to learn, has been burned out of house and home. On Dec. 26, 1895, he wrote thus:

"My house was burned with everything that was in it, on Dec. 8. Also about 250 pounds of nice mint honey. I was away from home; wife and two little girls were at home alone. The cause was a defective flue, which they did not see till the roof was dropping through on the upper floor. We saved nothing but one feather-bed, a stand-table and a few books. We are homeless in the dead of winter, with ten inches of snow."

Getting Ready For 1896!

We are now prepared to furnish in any quantity, at the very lowest prices—EXTRACTORS, SMOKERS, and EVERYTHING used by the wide-awake bee-keeper. We shall continue to make our FALCON POLISHED SECTIONS, which are yet unequalled. If you've never used any of our Goods it is time for you to do so. They are acknowledged to be unsurpassed by any other make. Our large new Catalogue will be out early in the year. Anything you want now? Write to us. Goods and Prices guaranteed to be satisfactory.

Address:
THE W. T. FALCONER MFG. CO.,
JAMESTOWN, N. Y.

Handy Cobbler \$2.00

Family Shoe Repair Kit. 28 Articles

Bought singly would cost \$4.70.

\$3 Outfit Includes

Harness Repair Tools

38 articles, worth singly \$6.70.

Sent by Express or Freight, Ills. Catalogue free. Agents wanted.

KUHN & CO. Box 66, Moline, Ill.

41A26 Mention the American Bee Journal.

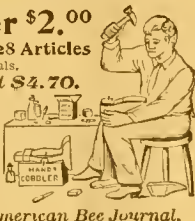

TAKE NOTICE!

BEFORE placing your orders for SUPPLIES, write for prices on 1-Piece Basswood Sections, Bee-Hives, Shipping-Crates, Frames, Foundation, Smokers, etc.

PAGE & LYON MFG. CO.
NEW LONDON, WIS.

Fine Basswood, White Sage or Alfalfa EXTRACTED HONEY

—For Sale.—

We have made arrangements whereby we furnish California White Sage or Alfalfa Extracted Honey, in 60-pound tin cans, on board cars in Chicago, at these prices: 1 can,

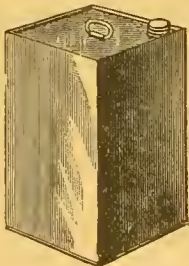

in a case, 8½ cents per pound; 2 cans in one case, 8 cents; 4 cans (2 cases) or more, 7½ cents.

The Basswood Honey is all in kegs holding 170 pounds, net. It is a very superior quality, and the prices are: 1 keg, 8½ cents per pound; 2 kegs or more, 8 cents.

Cash MUST accompany each order. A sample of either kind of honey will be mailed to an intending purchaser, for 10 cents, to cover postage, packing, etc. We guarantee purity, and that what we ship will be equal to sample.

Now it seems to us that here is a splendid chance for any bee-keeper to supply his home demand after his own crop is all sold. Or, why not begin now to create a local honey-trade? Order one 60-pound can first, and start out among your neighbors and friends, and see what you can do. You ought to get at least 15 cents per pound in 5-pound lots, or 50 cents for 3 pounds. Some may be able to do even better than that, though we think that enough ought to be sold at these prices to make a fairly paying business out of it. Give it a good trial. Push it. It may grow into a nice winter's work for you.

GEORGE W. YORK & CO.,
CHICAGO, ILLS.

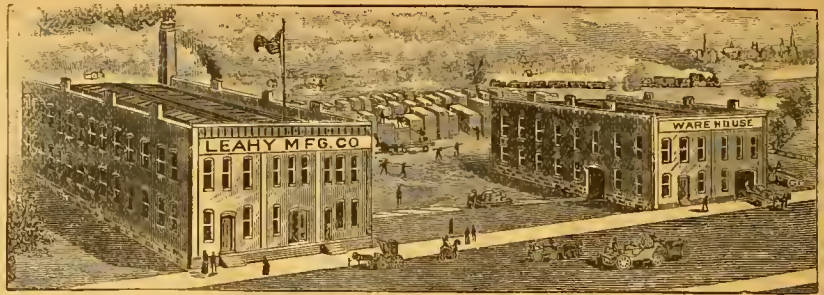

Largest Factory in the West COMPLETE STOCK. Good Supplies and Low Prices — Our Motto.

READ THIS—Mr. Keyes says: The 100 pounds of Extra-Tinic Foundation you sent us' is superior to anything he ever saw; and I think the same. R. L. TUCKER, Wewahitchka, Fla.

Dear Sirs:—The Sections came duly to hand. Indeed, they are very nice. Yes, sir; they are as good as the best. CHARLES H. THIES, Steeleville, Illinois.

Leahy Mfg. Co.:—I have received the bill of goods. I must say they are the choicest lot of Hive-Stuff I have ever received from any place. I admire the smoothness of your work, and your close selection of lumber. Yours very truly. O. K. OLMSTEAD, Orleans, Nebr.

Dear Sirs:—The Sections arrived in due time, and are all O. K. so far as examined. They are simply perfection. I can't see how you can furnish such goods at such low prices. I hope you may live long and do well. Yours respectfully. Z. S. WEAVER, Courtney, Tex.

Gents:—I received the "Higginsville Smoker" all O. K. It's a dandy; please find enclosed stamps for another. Yours truly. OTTO ENDERS, Oswegathe, N. Y.

Gentlemen:—I have bought Supplies from nearly all the large manufacturers by the carload, and I must say yours are as good as the best. Indeed, in many lines they are the best. It is a pleasure to handle them. E. T. FLANAGAN, Belleville, Illinois.

The above unsolicited testimonials are a fair sample of hundreds we receive. Our prices are reasonable and the "Higginsville Goods" are the best.

We are now manufacturing for each of the following parties a Carload of Supplies: E. T. Flanagan, Belleville, Illinois; Charles H. Thies, Steeleville, Illinois; J. W. Rouse & Co., Mexico, Mo.; Henry Miller, Topeka, Kans.; Fulton & Gregg, Garden City, Kans.

If you need a Carload of Supplies, or only a Bee-Smoker, write to us. Remember, we are here to serve you, and will, if you give us a chance. A Beautiful Catalogue Free.

Address, **LEAHY MANUFACTURING CO., HIGGINSVILLE, MO.**
49A Mention the American Bee Journal.

BIG OFFER

I Will Pay \$1.00 for the address of every person who has any PURE WHITE CLOVER EXTRACTED HONEY for sale—either for your own address, and any others you know of.

WM. A. SELSER,

Please mention this Journal. 10 Vine St., PHILADELPHIA, PA.

The Solid Meat

is what you want in a bee journal, just the same as in other things. You don't care for the extra pages and issues if they are to be filled with side-issues and a lot of "stuff" that must be looked over to see if there is any "solid meat."

If you want a journal that is "solid meat," that is practical from beginning to end, that devotes itself unceasingly to the one thing of making bee-keeping a more safe, pleasant, and profitable pursuit, then subscribe for the BEE-KEEPERS' REVIEW at \$1.00 a year. Mr. H. D. Cutting, ex-President of the North American Bee-keepers' Association, says: "I take most of the bee journals, and glance through them to see what there is in them, and occasionally find an article that I read, but when it comes to the REVIEW I read that right through from beginning to end. It's solid meat." Mr. Cutting is not the only reader of the REVIEW who talks in this way, and if you will subscribe for it now, you will be talking in the same fashion by the end of the year. The REVIEW and Advanced Bee-Culture for only \$1.25.

W. Z. HUTCHINSON, Flint, Mich.

* ROOT'S COMB FOUNDATION! *

New Product.

New Process.

A Big Success

We are pleased to announce that, having secured control of the new Weed process of manufacturing foundation for the U. S., we are prepared to furnish **Foundation by the New Process**, for 1896. Samples will be mailed free on application, and will speak for themselves.

OUR SANDED and POLISHED SECTIONS, well, they will speak for themselves, also.

Our 1896 Catalog

will be ready for distribution now in a few days. Send in your name at once for catalog, samples of the new foundation, and those superb sections, and while you are about it ask for late copy of **Gleanings in Bee-Culture**.

THE A. I. ROOT CO., MEDINA, OHIO.

56 5th Ave., Chicago, Ill.

Syracuse, N. Y.

1024 Mississippi St., St. Paul, Minn.

AMERICAN BEE JOURNAL

DEVOTED EXCLUSIVELY TO THE INTERESTS OF HONEY-PRODUCERS

ESTABLISHED IN 1861
THE OLDEST BEE-PAPER IN AMERICA

Published Weekly, at \$1.00 per annum.

Sample Copy sent on Application.

36th Year.

CHICAGO, ILL., JAN. 23, 1896.

No. 4.



Can Bees that are Non-Swarming be Secured ?

BY G. M. DOOLITTLE.

A correspondent writes me protesting against some of the teachings of the past regarding new swarms being the best for honey, and queens from swarming-cells being the best queens for the average bee-keeper; he wishes me to give my views regarding these matters in the American Bee Journal, and to offer any suggestions I may think proper. He states that "hundreds of bee-keepers do not want swarms," which I have

should be written, or what should not be written, we must take in the great multitude of bee-keepers as a whole, and not narrow ourselves down to just what we want, but go out in our thoughts, asking the question, "What will be the greatest good to the greatest number?" Failing to do this, we are not complying with the golden rule, nor using that broad charity for others which it is our privilege to use at all times, if we would make the world better for our having lived in it.

I think that, as a whole, in the past, I have given more matter on "How to prevent increase," and save to others the providing to themselves of hundreds of dollars worth of hives, which often become empty and useless property, than I have on the different methods of increase, for on the whole, I am in favor of running an apiary on the plan of as little increase as possible; yet while I now so feel, I have not forgotten the time when I was so anxious for natural increase that I lay awake nights planning how it might be obtained.

In regard to queens from swarming-cells carrying the swarming mania throughout the country, I doubt very much there being any ground for such an idea, only a mistaken one, yet this brings me to the main point I wish to make in this article, which is, Is it possible to breed out of bees the dispo-



Apiary and Home of Mr. Henry Sutherland, Bainbridge, Mich.—See page 56.

not the least doubt is the case, yet it is equally certain that hundreds of bee-keepers do want swarms, and it has been for these latter I have written at times in the past, when I have spoken favorably to new swarms, and not for those who do not wish swarms, like the correspondent. What the object of others has been, who have written favorable to natural swarming, I do not know; they can answer for themselves. The point I wish to make right here is, in thinking of what

sition to swarm? I have always said that it is not, nor do I now believe it entirely possible, yet some things have come under my observation of late that have modified my opinions to a considerable extent. I have said little of the matter, but it may be better to speak of it now, so that others may try their hand, and thus perhaps perfection may be reached sooner, for, "In the multitude of counselors there is safety."

All who have read my book on queen-rearing will remem-

ber that I have adopted a different plan of queen-rearing from what I have formerly used. All who have had experience in the matter also know that the best queens are reared in case of two queens in a hive, or, in other words, when a young queen is reared and fertilized from the same hive which has an old and laying queen in it at the time when the young one is reared. This is a fact which none will dispute; but the point to be arrived at is, Are queens thus reared less likely to swarm than are those reared under the swarming-impulse? The method I have adopted and given in my book, is nearly the same as that used by the bees where two laying queens are tolerated in a hive at the same time, as the queens are reared above a queen-excluding honey-board when the old queen is doing full duty below, the colony not having the least disposition to swarm while the queens are being reared.

About seven years ago I began to notice that I was not having nearly as many swarms as formerly, and the number of swarms coming from my apiary has continued to be less, so that during the last two years I have not had one swarm to where I used to have ten. All the older readers of the American Bee Journal will remember that, during the '70's, I had excessive swarming, one season having above 350 swarms from less than 70 colonies in the spring. Swarm they would in spite of all that I could do, so that it was nothing unusual for me to have from five to ten swarms in the air at once, while in one case I had as high as 14 swarms all clustered together. As I go back to those days in memory, it certainly does seem that I have made progress along the non-swarming line, for I have not had as many swarms during the past two years as I often had in one day then, and it almost begins to look as if the method of queen-rearing may have had something to do with it. To be sure, some of the seasons of late have not been very good for honey, which may have had something to do with the matter; yet the seasons when the greatest number of swarms issued during the '70's, were those when only about a half of a crop was obtained.

I am greatly interested in this matter, and am keeping close watch of it, and I wish all who rear queens *entirely* above a queen-excluding honey-board would test the thing also, and so be helping to solve the problem, so that we may reach something definite in the matter. Why I say "entirely" is, that some advise having the cells started by colonies having the swarming-impulse, and, after they are started, place them above queen-excluders for completion. Of course, this would not be entirely along the line given in my book, and consequently would not be likely to be as perfect as to results. If we could only breed the swarming-impulse out of our bees, it would seem as if it would be better for the majority of those who keep bees as a specialty; for it is a very easy matter to obtain all the increase desired by the nucleus system, or a division of colonies after the harvest of white honey is over. Or, perhaps, we might breed a certain type of bees as non-swarmers, allowing other types to swarm, the same as we have types of hens which sit, and others which do not incline to sit.

Borodino, N. Y.



Evolution and Queen-Clipping Again.

BY ALLEN PRINGLE.

I am a little late in noting what is said on this subject on page 793 (1895) in rejoinder to some strictures of mine in a previous issue. I note what the editor says in a foot-note, and while I could very easily and effectually dispose of the writer's contentions, I shall not ask the editor to continue a discussion which might, as he remarks, "evolute into one on religious beliefs," though it certainly would not on my side, for I think I could discuss the great scientific and philosophical questions in issue on their merits, without getting down to creeds or beliefs.

In these times, when evolution has become the "working hypothesis" in all secular science and philosophy, it is quite impossible to thoroughly discuss the range of subjects properly embraced even in bee-culture, without getting onto just such ground as Bee-Master, Dr. Miller, and myself now occupy in this queen-clipping discussion. And it is certainly not very creditable to the intelligence and liberality of the confraternity of apiarian readers, that they cannot stand the friendly discussion of a great question like this, which grew directly out of a legitimate subject for a bee-journal, and hence comes fairly within its province. I know "Bee-Master," my opponent; he is a gentleman of education and ability; and as I know myself equally well, I know that in discussing this matter there would be no unfriendly feeling or word—no personality whatever—nothing that a reasonable man, not afraid of open discussion, need fear. Nevertheless, the editor

feels that readers would object to it, and deems it his duty to shut down. Under such circumstances I do not blame him, but I do not, I must confess, think much of the reader who would blame him for continuing the discussion.

However, as already remarked, I shall not attempt to go contra to the editor's wishes by continuing the discussion; but "I rise to a point of order," or a "question of privilege," and must make a correction and explanation, as my opponent has misunderstood me on the vital point of all. He says: "Mr. Pringle dogmatically asserts that I cannot hold the two opposing philosophies of Evolution and Creation," and goes on at some length to show how he can hold them both consistently. But I did not say that, or mean that. This is what I asserted: "He is astride two opposing philosophies—which are utterly irreconcilable. These two philosophies are *evolution* and *special creation*. He may take either one, and I shall not complain, but in trying to ride both horses, he must have a fall."

My opponent is confounding *creation* with *special creation*. They are quite different, and I supposed my opponent was sufficiently well read in modern science and modern thought to know the difference. *Special creation* means that every species of animal and plant was separately and specially created, and that man, of course, was so specially created, according to the Mosaic cosmogony. Evolution, on the contrary, teaches and proves that species are evolved from each other—that they have all come from one or more original, primeval protoplasmic forms, and that man is no exception to the rule, but is himself a product of evolution instead of being a special creation. The general or original creation which Bee-Master probably means, is the creation of the primeval *protoplasm*, or, at most, of a few original forms of life, evolution doing all the rest. Such original creation I neither affirm nor deny, and I freely admit that between it and evolution there is no necessary conflict, while between *special creation* and evolution the conflict is utterly irreconcilable.

The reader will thus see that my opponent's whole argument was built upon what I did not assert—"dogmatically" or otherwise. Having thus merely made a correction and explanation without argument, I reluctantly stop, having that editorial foot-note before my eye.

Selby, Ont.

[We regret that Mr. Pringle "stops reluctantly," for it seemed to us that there was nothing to be gained by a continuation of the discussion of clipping queens' wings. The principal objection to clipping, offered by Bee-Master, was so utterly imaginative and theoretical that to use much space in considering it would be a clear waste. And surely Mr. Pringle would not desire the readers of the Bee Journal to wade through a lot of evolution theory, which, at best, is mighty dry reading to most people, and quite unprofitable, especially to so practical and busy people as bee-keepers are supposed to be. Space in the Bee Journal is altogether too limited to discuss subjects so deep and far-reaching as those found in the domains of spiritual, political or evolutionary thought. We propose to leave those subjects to periodicals devoted specially to them. Please all bear in mind that this is a *bee*-paper.—EDITORS.]



Self-Hiving Arrangements and Queen-Traps.

BY ADRIAN GETAZ.

All the self-hivers invented so far are comprised under two different types. The first one (Fig. 1) has the self-hiver separated from the main hive by a piece of queen-excluding zinc and a queen-escape. Another zinc at the entrance of the hiver retains the queen in the self-hiver when swarming occurs. The hive may be a regular hive, or a box containing a few empty combs to hold the swarm temporarily. It has been placed in front, under, and, I think, sometimes at the side of the main hive.

I constructed them about as shown in Fig. 1. The entrance of the main hive was larger than usual; there was ample space between the main hive and the zinc conducting into the hiver. Both zincs were of large size, not less than 35 to 40 square inches. All that was so the ventilation of the hive should not be hindered.

Such hives will hive full swarms every time, and take up nearly all the field bees, as whenever the bees come in they will stay in the hiver rather than go beyond; that is, after the hiver is occupied by the queen and the swarm.

The trouble with that style of hivers occurs between the

time the hiver is attached to the main hive, and the swarming. As it is readily understood, the working bees have to go through the hiver every time they go out and come back. The drones can, and will, come out through the queen-escape and be confined in the hiver. There they will stay quite awhile, being fed by the bees. The mischief is, that they are in the habit of clustering on the inside zinc (between the hiver and the main hive). The bees do so, also, to some extent. The result is, not only the ventilation of the main hive is interfered with, but the coming in and going out of the field-bees is considerably hindered. Frequently the bees take possession of the combs or foundation placed in the hiver without swarming. This gave me the idea of putting sections in the hiver, and from that I readily got the idea of turning the field-bees

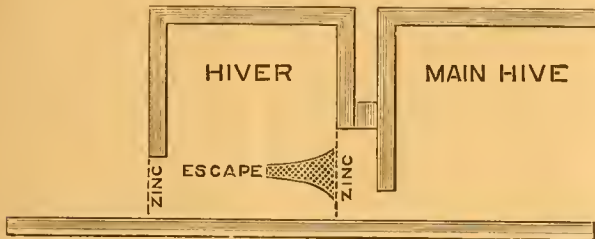

Fig. 1.

into the supers, as described in some of my previous writings in the American Bee Journal.

In calling the attention of the readers to this, it is to point out in what direction improvements should be attempted, but not to advise using the hiver as above described, as I was compelled to abandon it altogether.

The second type of self-hiver used so far is as shown in Fig. 2, that is, a queen-trap large enough to admit the placing of combs in the apartment where the queen is caught and confined when swarming occurs. This having but one zinc between the main hive and the outside world, will not interfere appreciably with the working of bees or the ventilation, provided, however, that the zinc at the entrance of the hiver and all the openings are of a sufficient size. But it will not retain a full swarm; the majority of the bees will go back to the main hive rather than climb into the hiver through the inside zinc. I think, though, that with some ingenuity a disposition of the zincs could be found that might prevent it, but whatever may be attempted in that direction ought to be with having the bees to pass through only one zinc in their work to and from the field. The disposition of the escape and zincs shown in Fig. 2 is adopted in view of leading the queen into the hiver. Nevertheless, she will sometimes go back into the brood-nest instead of through the escape.

QUEEN-TRAPS VS. HIVERS.

If I could be in my apiaries every day, or every other day, I would simply use queen-traps, or perhaps entrance-guards, rather than any kind of hivers. But if the apiarist may be absent a whole week or more, then the second type of hiver just described is better than a queen-trap. When the queen finds herself a prisoner in the trap, she institutes a thorough investigation as to the means of escaping, and in the course of two or three days succeeds in going back to the main hive through the cones. No sooner back there, she swarms again, and, knowing how to go back, does it at once, then daily swarming, or rather attempts at swarming, take place, and last as long as queens and queen-cells are present—that is, until the last queen has emerged. In fact, the queen-trap is not much better in such cases than a mere entrance queen-excluder.

When a swarm issues and the queen is retained in the hiver, enough bees stay with her, and combs are there, so the queen does not even attempt to go back; some work is done there, and is that much gained. Until a virgin queen emerges, no swarming will take place, and the usual work is resumed in the main hive, as well as it was before swarming. With the appearance of a virgin queen, swarming is resumed, and the young queen gets into the hiver. There a fight between the queens takes place, and one of the two is killed, almost invariably the old one.

In all my experiments with queen-traps, hivers and excluders, only one laying queen has held her own against the virgin queens. The next day the same will be repeated, and so on until eventually no more cells are left in the brood-nest; one virgin queen is in the hiver, and another in the brood-nest. In the course of a few days the latter comes out to mate, and meets the other in the hiver. A last fight takes place, and only one virgin queen is left in the hiver. When

the apiarist comes, all he has to do is to remove the hiver and allow the queen to mate—that is, if it has not interfered before.

When the old queen gets into the hiver, no more eggs are laid in the brood-nest, and, more than that, hardly ever are any more queen-cells started after she has left, from the fact that the number of bees in the main hive is considerably reduced. The queen-cells already started will be all matured, generally in from 12 to 15 days. By that time the last virgin queen has emerged, and swarming is at an end.

With a queen-trap as an excluder, the case is different. The old queen will remain in the hive and lay eggs until she is killed by one of the virgin queens—generally the first one emerged; and since the hive remains crowded, new queen-cells will be started as long as there is any brood old enough to make a queen.

As I have stated above, no queen will stay in a queen-trap more than two or three days. The majority of them will get out during the night after they have been caught. Perhaps my queen-traps were not very well made.

Of course, all the above supposes that the apiarist has not been able to attend to his bees sooner. I have only a limited number of hivers and traps, all the other hives having queen-excluders. A swarm issuing the first time may come out late in the day, but the following days they are sure to be out early; they may come back at once, or perhaps later during the day, generally before 12 o'clock. A returned swarm will hang on the outside of the excluder quite awhile, so by going into the apiary between 10 and 12 o'clock, a. m., the apiarist will early discover which hives have been swarming and need attention. The sooner they are attended to the better.

If increase is desired, move the old hive to a new stand, except a comb or two with a queen-cell on the old stand unless the queen is there. Better destroy all the queen-cells but one in the queenless hive, but leave the excluder on in case a queen-cell was overlooked. If no increase is needed, remove the old queen and allow requeening by leaving one queen-cell. (This in order to prevent further swarming.) Have an excluder on (a queen-trap or hiver will do as well); wait until the young queen has emerged and destroyed the old one, then destroy the queen-cells. Do not spend more time than necessary to find the cells, but leave the excluder. If any cell has been overlooked, swarming will take place sometime during the next two days, if the weather is not too bad. No queen-cell will be started in the presence of a virgin queen, at least that has been my experience so far.

FINDING QUEENS AND QUEEN-CELLS.

To find the queens and queen-cells, have an excluder before the hive; put in front of this a board or platform about 2 feet square, one side resting on the alighting-board, and the other propped up from the ground. Take the combs out one by one, shake the bees on the platform, and set the combs anywhere, but not in the hive. It is not necessary to shake them clean, the queen falls easily, and all that you need is that enough bees are off to permit you to see the queen-cells.

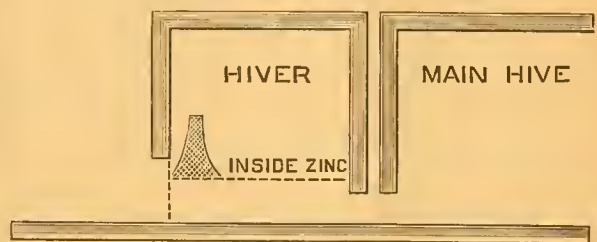

Fig. 2.

Do not take too much time. The queen will be found probably before the excluder, trying to get in, perhaps in the hive, perhaps on one of the combs. If you leave a virgin queen in the hive, leave the excluder on for two or three days. If any queen-cell has been left, you will know it by the bees swarming.

Bees shaken on a platform as above described, will stay there, or, at most, will partly hang at the edges; while if shaken on the ground, they would crawl everywhere, especially inside the operator's trousers.

QUEENLESS SWARMS.

The behavior of queenless swarms under circumstances as above described is interesting. The first day a queenless swarm comes out, it hardly ever clusters, and returns in a

short time. The following day it comes out early and stays out longer, probably clusters. The third day the bees will certainly cluster, and perhaps go away half a mile or so and cluster again. Every day they will stay out longer and cut up all sorts of capers worse and worse before returning. Occasionally they stay out until the next morning. They hardly ever swarm twice a day. Sometimes in coming back they scatter into two or several different hives.

As to uniting together, it depends upon the circumstances, and a trifling cause may determine two queenless swarms to unite and all go back to the same hive. If while a swarm is returning and "calling," another in the air would be almost sure to unite; but one clustered would not pay any attention to it.

Once I was working with a hive. When through, and the hive was closed, the bees began to "call" at the entrance as they usually do in such cases. A swarm in the air hearing the call, came and entered the hive; that is, would have done so if I had not prevented.

A queenless swarm never swarms as compactly as a normal one. The cluster is irregular, and has a more or less ragged shape, changing constantly. The bees are much more restless, and move continually. A queenless swarm will also fly slower, and closer to the ground, than a normal one. Neither will the bees fly as close together.

MATING OF QUEENS.

All that is very well—excluders and queen-traps will certainly prevent the swarms from decamping, except, perhaps, when a strange swarm, passing by, might unite with one of your queenless swarms. But, by and by, some virgin queens will have to mate, and if some queenless swarm happened to be out at the same time, the whole outfit would go to the woods and never return—at least this would be nearly always the outcome of the meeting. I once had an exception. The queen brought the swarm to her own hive. I suppose they met after she was fecundated, and already on her way home.

Very rarely a swarm issues after 3 o'clock p.m. The best is to remove the excluders only from that time until night, and only when the apiarist is present; then should a swarm issue, it could be taken care of. Sometimes a queen has not yet returned when the apiarist closes the excluders and goes home. That does not matter; she will stay on the excluder, outside, and be taken care of by the bees, even for several days, and be just as good.

QUEENS PASSING THROUGH THE ZINC,

or rather not passing through the perforated queen-excluding zinc—we must be careful in our conclusions on this point. As I stated above, a queen caught in a trap, will eventually go back through the cones, and we might think that she has passed through the zinc. Sometimes there is a hole somewhere—a cover warped, leaving a crack at one corner; a zinc bent somewhere. My hive-bottoms are made of two pieces or more. The ends, exposed to the weather, do not shrink much, but the part under the hive being kept dry, shrinks sometimes enough to leave a crack between the two pieces big enough for any queen to go through. Knoxville, Tenn.



An Eventful Visit to an Out-Apiary.

BY C. P. DADANT.

Let me warn the reader, at the outset, that I have no information of any value to give him in this article. Perhaps some of you will say that this is no news, and that you took it for granted at the start. But, if I succeed in making you laugh at my expense, my object will be attained; and let me say that I vouch for the truth of all that I am about to relate.

Some six or eight years ago I took a trip to the South, and went to visit a brother bee-keeper living less than a thousand miles from St. Louis. He is a nice, warm-hearted fellow, very enthusiastic over all that he does, and he welcomed me heartily. I arrived there on Saturday evening, and after examining his bees, his Heddon hives and his large hives, which he was then testing side by side, he took me into his home, where I made the acquaintance of his old mother, a nice, gray-haired lady with the genteel manners of well-bred New England folks. I was royally treated, and the next morning my friend, whom I will call X, so as not to hurt his modesty, proposed to me to take a trip to his out-apiary, four miles away. This apiary had been established but a short time, and I concluded that he was taking a pride in showing me that others could have out-apiaries as well as ourselves. But it was not out of bee-keeping pride that he wanted to go there, as I found later. X was a single man, and there was a young lady, living in the

neighborhood of that apiary, whom he evidently felt required to visit every Sunday.

It was a raw March day; the roads, well—there was no bottom to them. X had a nice, new top-buggy and a neat, fiery little bay mare which had but one fault—she was balky. She could go "like the wind;" in fact, it was of no use to hold her, for go she must, and if you tried to slacken her pace she would stop and stay there, quite a little while longer than you liked. So we started at full speed, in the mud, but the buggy was good, and we had a storm-apron that kept the flying sloop out of our faces. In due time—no, I mean before due time, for the horse galloped all the way—we reached the apiary, some 60 or 80 colonies nicely arranged in rows on a hillside. And, of course, your humble servant got acquainted with a very nice young lady, who he felt sure would be a bee-keeper's wife some day not very far distant.

When the hour came for retracing our steps towards the city, Mr. X inquired of the host in regard to another route, which had been less in use, and which they seemed to think would be less muddy than the much-traveled road through which we had come. This route was a sort of a private road, and consequently less traveled. There was one stream to ford—"Wood river"—which might be swelled by the recent thaw, but our host assured us it was "all right." So we started down the valley, and soon got to the edge of Wood river—a slow and quiet stream, probably 30 feet in width, running its smooth and muddy course noiselessly among the willows. "What do you think of it?" said X. "Bah, it is surely safe enough," said I; accustomed as I was to the noisy torrents of our county, this little stream did not seem to have a foot of water in it.

In went our horse with a rush, and we instantly found ourselves in four feet of water, and there the horse—balked. That buggy was not very high, and we had water on the seat, so we stood up, or rather stooped up under the top, waiting for the horse to start. Did you ever have to wait for a balky horse to change his mind, yourself knee-deep in the water, with an unknown quantity of the same muddy beverage on either side, wishing for dry weather? If so, you have a faint idea of our feelings.

After a few minutes X tried to coax the horse forward, but only succeeded in getting her to plunge in such a fashion that she entirely disappeared under the water for a few seconds, and took us about ten feet down the stream and out of the main track. It was then next to impossible to turn back into the main road without backing, even with a steady horse, for the stream was narrow and the banks very steep. Backing with this horse was out of the question. We began to seriously consider the necessity of wading to shore. X is a gentleman all over, and when he saw me look at my traveling suit, knowing I did not have my entire wardrobe along with me, he concluded that I should not soil my clothes—he bravely took off his coat and vest, fastened them in the only dry place in reach—the brace of the buggy-top—and jumped into the water.

"Now," said he, "there is no use of two of us getting wet; I am strong enough to carry you to shore." And so he did, though I felt a little ashamed of accepting such a generous offer.

Then he returned to the horse and unhitched her. When she found herself free, the little mare quietly walked to shore. Then X hitched himself at the shafts and tried to pull the buggy out, but the bank was steep, and the bottom was sandy, so he had to tie one of the lines to the shaft and hand the other end to me, and by the efforts of both, the rig was at last on shore, but full of water.

That buggy was new, as I said before, and held water like a tub. We had nothing to bail it out with, and houses were too far away. So we upset the buggy to take out the water; but, unfortunately, we forgot to remove the coat and vest that were fastened to it, and spilled the contents on the two garments. Still we were not out of our trouble, for, after having hitched up and started off, we found that the by-road that we had taken had been lately fenced in, in two different places. Luckily these were of the old-style of worm fences, and with a few minutes' delay we managed to get through.

We soon reached the city, where a good fire and a hearty supper awaited us. A temporary change of garments, especially of foot-wear, soon set matters right. The kind hospitality of X, and of his aged mother, I will not forget, neither will he, nor I, readily forget our experience in Wood river.

Hamilton, Ill.

P. S.—Let me add that X has since married the young lady who was the indirect cause of this eventful trip.

C. P. D.

A Visit Among Some Utah Bee-Keepers.

BY E. S. LOVESY.

At this writing I am located up near the clouds, near the top of the Wasatch Mountains. I came out here thinking to take a rest and to visit an uncle that I had not seen for over 26 years, but as soon as I stepped off the cars at Echo, in Summit county, I walked into Mr. Hopkins' store, to inquire about Uncle Blackwell, when I was greeted with a hearty hand-grasp, and an "Oh, yes, you are one of our prominent bee-keepers, I believe!" I admitted that I owned some bees. So I was taken in tow by the bee-keepers of Summit and Morgan counties, and while I came out here without even thinking about bees or bee-keepers, and although I was taken by surprise, I have had a pleasant time visiting the bee-keepers in the different townships, and a more kind, generous lot of people I never met.

We held two bee-meetings—one in Croydon county and one in Morgan—and the result was the organization of the Morgan County Bee-Keepers' Association, Dec. 5, 1895. The officers of the association are: President, T. R. G. Welch; Vice-President-at-large, Robert Hogg; Secretary, David Coolheds; and P. A. Jackman Vice-President of north Morgan county. Very interesting sessions were held, and many subjects discussed. I was called on, and talked about how to make our bees profitable. I tried to show that with proper management bee-keeping is one of the best paying industries in Utah.

Dear old Uncle Blackwell, now nearly 81 years of age, is about the only one left that links us with our bee-keeping days in old Gloucestershire, nearly half a century ago. He reminded me of the days when I was a little bee-keeper. I used to watch the bees, and when they swarmed I often fancy even now that I hear the racket I used to make with a cobble-stone and a tin pan in trying to settle them. Uncle B. asked my opinion about trying to settle bees by this method. Like myself, he cannot see how it can affect the bees, unless it is possible to make enough noise to drive them off! There are many people who believe in it now. Last year a bee-keeper followed a swarm of bees into our garden with a tin pan, but I believe it was the hives more than the pan that attracted them. I have generally been successful in settling swarms by throwing water or sand among them; it confuses, and thus causes them to settle.

We have had a very interesting time talking about those bee-keeping days of the long ago. My father made his money off of pork and bees, and that brought us to this land of the free. The bees were destroyed with sulphur before the honey was taken out of the hive. The hives were made of straw twisted like a rope, and sewed together with fine willows. In shape they were round, and oval on top. In winter each hive was thatched with straw from four to six inches thick, gathered tightly together at the top and trimmed even around the bottom. Bees never died in winter put up in this way, as long as there was any honey in the hive, because it gave the requirements necessary for the successful wintering of bees, viz.: It kept them warm and dry, and absorbed all moisture.

The past three weeks I have visited a number of bee-keepers in this and other counties, and I have found many hives with those everlasting tight covers. The frames are moldy, and the bees are like a man would be if he were dipped into a mill-pond in the month of January; then when the temperature gets down towards zero the bees cannot leave the cluster to seek food, and thus they smother with foul air and die of starvation. I have put up my bees something after this method, using lucern instead of straw, and they appear to be all right.

I have had a grand time visiting my uncle, and also among the bee-keepers here. There is just enough snow to make sleighing agreeable. The people do most of their traveling up here about three months of the year, with the merry sleigh-bells jingling, while in Salt Lake City we seldom get more than a week of sleighing weather, and sometimes not that much.

All the settlements in Morgan county are nestled in three not very large valleys, and surrounded entirely by the grand old Wasatch Mountains. As we enter from the east by way of Echo, we pass through what is called "The Narrows," where the mountains on each side come down into the river bed and the Union Pacific railway track—it is the same as we come in from the lower end of the valley, from Ogden or the west. But between those points the valleys widen out, and here we find one fine city and nine other settlements—a prettier spot in summer, or a more healthy place it would be hard to find on the globe.

There is said to be over 500 colonies of bees in and around Morgan city, and if there is finer honey in the world

than is gathered in those mountains I have not seen it. The people live mostly by farming, wool and stock raising.

I now return to the great and only city called "Salt Lake."

Questions AND Answers

CONDUCTED BY

DR. C. C. MILLER, MARENGO, ILL.

[Questions may be mailed to the Bee Journal, or to Dr. Miller direct.]

Quality of Catnip Honey.

What quality of honey is produced from catnip? The bees work on it more than anything else in this locality, but it is scarce. It remains a long time in bloom. W. J. M.

Cedarville, Mo.

ANSWER.—Catnip has always had the reputation of a fine honey-plant, but I don't know whether any one has ever had a sample of pure catnip honey. I have an impression it is of good quality, but I have no positive knowledge. [I have seen honey that had quite a catnippy taste, and I rather liked it. It ought to be good for a colicky stomach!—G. W. Y.]

When to Move the Bees.

I have a chance to buy 25 colonies of bees. When would you move them—when it is good sleighing, or wait until spring? F. A. S.

Shavertown, Pa.

ANSWER.—It would be very nice if you could move them on a very cold day with good sleighing, and then have the next day a fine warm day with plenty of flowers for the bees to work upon. But as that can't be had, and as it's a bad thing to disturb bees without allowing them a chance for a flight soon after, I think you will do better to wait till spring.

Starting in Bee-Keeping and Making it Pay.

1. Suppose I wish to have an income from the bees of \$500, about how many colonies would you think I should have? I mean this to apply to a man of reasonable intelligence, close application, and the second or third year of the work.

2. Would the care of this number be more than I could stand? This is like asking the size of a piece of chalk. Perhaps the question would be more intelligible if I said I could do as much physical work as an average woman.

My present intention is to get two or three colonies in the spring, and try them the coming summer. If we suit each other, the apiary can be started after that. I cannot afford to venture much. INQUIRER.

ANSWER.—I've done more than the usual amount of thinking as to how best to answer your questions so as not to mislead, for such questions are very hard to answer. But I'll do the best I can. Answering your second question first, I think you would have no trouble on the score of strength, providing you were sure of good crops every year. And I may as well say in the first place that the greatest trouble comes from the element of uncertainty as to crops. Worse than all, crops are more uncertain of late years than they were formerly. If you had asked me the same questions 20 years ago, I could have answered with less hesitation, and could, or at least would, have given you a more definite answer than I dare to do now. But I'm afraid some disappointment might have followed on depending upon my answers. Twenty years ago I said no one ought to embark in bee-keeping as his sole business unless he had enough ahead to stand an entire failure of the crop for one year. At present I should change the one year to two or three, and I should hardly advise any one to drop everything else for bee-keeping unless he had enough ahead to need but a small income from

the bees. Of course there may come another change, and the next ten years may be better than the past ten.

Your private letter explains to me that you are near a large city where there is much vacant land and plenty of sweet clover. I feel more uncertain how to reply than if you said you lived miles from any town or city, and yet the uncertainty leads rather to the hopeful side, for without knowing anything very definitely about it, I suspect that in such a place as you occupy there may be more uniformity of crops than the average. I have a good deal of faith in a big lot of sweet clover, and should count on rather greater uniformity in its performance than in the average of honey-plants.

As to how many colonies you should have to secure an income of \$500, the easiest way is to answer that I don't know. But I'll give you some points upon which an answer would be based. It is possible to have a crop of 100 pounds or more from each colony in a good season. Supposing it was comb honey and you got 15 cents a pound for it, that would be \$15 per colony. It is also possible to have not only no surplus, but to have to spend \$1.00 or more per colony to get the bees through winter and spring. Now averaging the minus dollar with the \$15 gives \$7 per colony, and at that rate it would require a fraction more than 71 colonies to allow an expectation of \$50 annually. There are the figures for you, and I've confidence enough in your abilities as an accountant to see that they're all straight. The old saying is that figures won't lie, but between you and me this is one of the cases in which they will lie egregiously. The fact is, that it isn't an even chance between 100 pounds and a dead failure, but the failure comes oftener than the hundred pounds, and when it isn't a failure it's more likely to be a low figure than somewhere near the hundred mark.

To make something of a guess guided by what has been for a few years past, I should say that instead of 71 you would need from 150 to 200. I'm afraid that would be rather more work than you ought to undertake. I said there would be no trouble on the score of strength, providing you were sure of good crops every year. For in that case you'd need to keep less than 100 colonies. I think you might take care of that many, but more than a hundred might swamp you.

Now I haven't given you a very satisfactory answer, but you see it's a good deal like saying how many fish you can catch daily in the Chicago river. Your plan of starting with two or three colonies to make the trial is the eminently wise one.

Wants Crimson Clover Seed.

I wish a sample package of your crimson clover seed, and a price-list telling how you sell it. I am thinking about going into the bee-business, and if so I will sow a large field of it.
Longtown, Minn. R. R. P.

ANSWER.—Bless your heart, I haven't any seed to sell, or anything else of the various things I write about that bee-keepers use. But you'll find crimson clover seed at the seed-stores almost anywhere. I think it has also been advertised in the bee-papers. [No doubt very soon there will appear in the advertising columns of the Bee Journal, notices from various seed-firms, to whom all should apply if you desire anything in the seed line.—EDITORS.]

Two Questions and Two Guesses.

I use the dovetail hive with Hoffman self-spacing frames. I packed my bees in dry leaves about the middle of November, by making a rough box large enough to hold three hives, putting a strong colony on each outside and a nucleus in the center, setting them close together. The box was large enough to pack three or four inches of leaves between it and the hives. There is a tunnel at the entrances of the hives.

1. A week or ten days after I packed my bees, I found one of the queens dead on the alighting-board in front of the hive. What caused her death?

2. One of my neighbors had a large colony of bees, and he found them all dead a few days ago. They were on the summer stands, and had lots of honey. What caused their death?
E. B. T.

Wallaceton, Pa., Dec. 31.

ANSWERS.—1. This is another of those questions which can only be answered by a guess without more particulars. It's very much like giving a doctor a question like this: "A man was found dead on Jan. 5, in Chicago. What caused his death?" The manner of packing may and may not have had something to do with the queen's death. For if the entrances

were very close together, and especially if the position of the hives at the time of packing was so changed as to throw bees into the wrong hives, then the strange bees may have had something to do with the death of the queen.

2. Another conundrum to be answered only by a guess. One of the most probable guesses is that the colony was queenless, and without the owner's having noticed it, it had gradually become reduced in numbers until almost all gone, and then the first cold-snap finished the few very old bees that were left.

Bees Throwing Out their Young.

In September I had a colony of bees that would carry out the young ones of their hive, some of them being dead and some alive. What was the cause?
G. E. L.

Morocco, Ind.

ANSWER.—It might be the work of worms. The worms burrow their way along the base of the cells, and in digging after them the bees throw out the brood and young bees. Probably the brood is injured by the worms, and that of itself would make the bees throw it out.

A Queen that Left the Hive in Winter Out-Doors.

I was puzzled yesterday, while passing through my apiary, when I noticed the hive-cover had been left on the ground, and on it was my best golden Italian queen (a clipped one). She was cold and unable to crawl. She had been out all night in a heavy rain and wind. I recognized her as the queen of hive No. 6, by the manner in which I had clipped her wing. I had not handled her hive for several days, and cannot account for her leaving the hive. Her colony is a good one, with plenty of stores. I put the queen back into her hive, and the bees balled her immediately. This was at 9 a.m., Dec. 24. At sundown I looked after her, and saw she was yet in a ball of bees. At 9 a.m. to-day (Dec. 25) I found her all right. Have you any idea why she left the hive?
SUBSCRIBER.

ANSWER.—I don't know. If any of the brethren or sisters know, such an one will please take the floor.

Several Eggs in a Cell—Queens Carrying Foul Brood—Hive and Frame Dimensions.

1. I wish to know what is the matter, or what caused the queens in two of my colonies to lay five or six eggs in one cell when there was plenty of room in the brood-nest. Was she too old? She was not a drone-layer, for what eggs hatched and matured produced workers, and the queens were nice, large ones. I have several good bee-books, and can't find a case like it described.

2. Will I have to requeen them in the spring?

3. Do you think queens from foul-broody colonies would carry the disease?

4. What are the dimensions of the inside of the standard Langstroth hive, and the length of the top-bar of the Hoffman brood-frame?
D. E. D.

Whittington, Ind.

ANSWERS.—1. With just the light you give on the case I should suspect that there were too few bees to cover enough brood to suit the queen. She will not lay outside of the space covered by the bees, and if the bees are too few there is nothing but for her to lay a second time in the same cell.

2. If the plurality of eggs in a cell came from the small number of bees, it's rather an indication of a good queen, and no indication that she should be replaced.

3. I think no one has yet reported a case in which the disease was carried by the queen, and a number of cases have been reported in which a queen from a foul-broody colony was given to a healthy colony with no bad results. That's pretty strong evidence, if not entirely conclusive, that the disease will not be carried by a queen.

4. I suppose the dovetail is as nearly a standard Langstroth as anything, and the inside measure of that is $18\frac{3}{4} \times 12\frac{1}{4}$, and $9\frac{1}{2}$ inches deep. The top-bar of Hoffman frame is $19\frac{1}{4}$ inches.

☞ I firmly believe that better results can be obtained where bees swarm, than would be the case if we could breed out the swarming trait.—DOOLITTLE.



Liquefying Honey in Packages.

R. C. Aikin says in *Progressive*: "My experiments have proven that honey can very easily and successfully be liquefied by dry heat, and without any very complicated fixtures. Jelly-glasses, jars, bottles, pails, or any kind of vessel, labels and all, may be put into an oven or hot chamber and liquefied without damage. I see no reason why we may not have a cheap sealing retail package, the honey put into it from the extractor, and never again opened till it is wanted for the table. The hot chamber can be used by large producers and by commission-houses to melt for those who so desire it; but I see no reason why the near future may not see the consumer doing his own liquefying, having printed instructions with each can. With such a plan, the honey could be put into shape for the retail trade at once upon extracting, the packages put into a hot-air chamber if desired to be kept liquid, or there restored again to liquid state when marketed."

New Weed Process of Sheeting Wax for Foundation.

This is proving to be a great success. Yes, the new machine feeds a continuous sheet of wax, any thickness, from between a set of dies or parallel bars to any desired length—a mile long—without stopping, if need be. In practice, however, the wax is rolled up upon bobbins holding about 25 pounds. These bobbins are then set in a set of bearings (in a vat of warm water), just back of the foundation-machine. The free end of the sheet is fed into the rolls, and, presto! the whole bobbin of sheeted wax can be reeled off without stopping the mill. In practice, however, again, the foundation-mill reels off a length, and stops where the sheet is cut off. A pressure of the foot applies the power, starts the mill, and more is reeled off, and cut to the desired length. We have our plans laid, however, to run the wax through the mill, the whole 25 pounds, without stopping. An automatic cutting-off device will then in the meantime cut the sheets up into the required lengths.

This is not all. A new and better product is secured. The wax, besides being of an absolutely even thickness, is much more beautiful and transparent. Indeed, some of it, even before it is milled, looks almost as transparent and beautiful as rock candy. Nor is this all—it is tougher and yet more pliable.—*Gleanings*.

Bee-Keeping in England.

My opinion is that bee-keeping will, in a few years' time, resolve itself into a specialty here as in America, rather than in a wide-spread application of modern methods. The trend of things commercial lies in that direction, and honey-producing will follow suit. Trade demands are also engendering the output of a uniform article. In the past, producers of a few pounds of honey had a difficulty in selling, whereas larger quantities have been salable when a regular supply of uniform quality can be depended on by the trader. This has been my experience.—*WM. WOODLEY*, in *British Bee Journal*.

Fixing Prices in the Home Market.

G. M. Doolittle gives some excellent advice about marketing honey, among other things advising to sell in the home market if you can get within a cent a pound of what it will bring you when shipped, on commission. For the benefit of some, it may be well to mention the exceptional cases that sometimes occur when there is a failure of the crop in your own locality. Suppose your home market requires 5,000 pounds, and you have secured only 2,000 pounds, and no other is to be had nearer than the city market. Looking at the market reports you find it quoted at 14 cents. Deducting freight and commission you find you will have less than 13 cents left; considering all risks as to breakage, etc., you will do well to count that a cent less; or 12 cents in your home market will be as well as, or better, than to ship to the city. So you sell your 2,000 pounds at home for \$240. The

merchants of your town must send to the city for an additional 3,000 pounds, and freight and risk is such that it costs them, besides the 14 cents paid in the city, an additional cent or more. Indeed, they would rather pay 15 cents cash, delivered at the store, than to send to the city. Is there any justice in paying 15 cents for the 3,000 pounds, and giving you only 12 for the 2,000? I don't see any reason why you should not have the 15 cents, and thus put \$60 more in your pocket. So when the crop is such that your home market must be partly supplied from the city market, you should get in your home market at least the full amount of the price quoted in the city market.—*DR. C. C. MILLER*, in *Gleanings*.

It Pays to Use Plenty of Foundation.

In the honey season, and in the same day, if you take the three first swarms, each weighing about six pounds, and put one in an empty hive, another in a hive filled with foundation, and the third in a hive filled with nice, bright combs, to which a half story of choice combs is to be added, about how much extracted honey would you get from each colony in the first 12 days, if the season was a good one? This question can be answered better after some fair testing has been done. In the meantime I will make a guess and say, nothing from the colony that had all its own combs to make; 20 pounds from the one that had its hive filled with foundation, and 45 pounds from the colony furnished with plenty of combs. The colony with its combs made out of foundation would be worth \$1.25 more for real business every year than one that made its own sort of combs.—*WM. McEVVOY*, in *Canadian Bee Journal*.

Upward Ventilation Not Needed.

F. A. Gemmill, in *Canadian Bee Journal*, after speaking of the usual wintering plans says: "The above arrangement was for some years practiced by myself, until by degrees the clean or new quilt was abandoned and the old propolized one allowed to remain; it being composed of thick cotton-duck, and as a general thing completely coated with propolis to the extent that it might be considered water-proof.

"Gradually, however, even those quilts were becoming less and less used, especially on colonies worked for comb honey, and the flat wood cover with the bee-space underneath used in their stead. The packing being spread over and above this cover in the same manner as above the quilts.

"Fearing that a solid sealed cover (as near as the bees could make it so) would be a detriment, I in some instances loosened them, and also left a $\frac{1}{2}$ -inch space at the back end, so that the moisture could find exit through the leaves above.

"Experimenting in the direction indicated, I soon found that a clean quilt was not a necessity, nor was anything at all required but the wood cover, and that did not have to be disturbed, as if upward ventilation was actually necessary, that such a cover with 10 inches of forest leaves on top permitted all that appeared requisite.

Artificial Bee-Pasture.

When the drought seasons began, farmers tried to supply their bees with pasture by sowing Alsike clover and buckwheat. While Alsike and red clover have helped the bee-business along to a large extent, until the severe drought of 1893-94 had finished up this business, buckwheat has not secreted nectar in Iowa for the last four years, as I have made examination; in fact, I have made this a study in Pennsylvania, where the writer was born and kept bees. Buckwheat was the main fall crop for bees, while Iowa soil and buckwheat are no good. My first experience was made in good faith by furnishing a lot of seed to a farmer not far from my apiary; he was to have the crop of buckwheat, and I was to take or have the honey the bees might gather from it. Of course I was very anxious for the farmer to sow every foot of ground he could prepare and felt very enthusiastic of my prospects, as I had full confidence of a large honey crop, but my hopes were blasted—not a pound was gathered. Other tests have I made with much the same result. I do not know of anything, nor would I recommend anything, that could be profitably planted for bees, unless alfalfa or lucerne. This might in some localities, but I doubt whether it would prove profitable in Iowa. Sweet clover is a good honey-secreting plant, and will stand the drought and cold weather in Iowa, and were it of much use for anything but honey, perhaps it might be profitably cultivated in almost any State. What may spring up we do not know, but the bee-business is not now on the booming side of a livelihood.—*J. W. BITTENBENDER*, in *Agricultural Epitomist*.

OLDEST BEE PAPER IN AMERICA ESTABLISHED IN 1861

THE AMERICAN BEE JOURNAL

PUBLISHED WEEKLY BY
GEORGE W. YORK & COMPANY,
 Editors and Proprietors,

56 Fifth Avenue, CHICAGO, ILL.

REGULAR CONTRIBUTORS:

G. M. Doolittle, of New York. Prof. A. J. Cook, of California.
 Dr. C. C. Miller, of Illinois. Dr. J. P. H. Brown, of Georgia.
 J. H. Martin, of California. Rev. E. T. Abbott, of Missouri.
 Chas. Dadant & Son, of Illinois.

\$1.00 a Year—Sample Copy Sent Free.

[Entered at the Post-Office at Chicago as Second-Class Mail-Matter.]

Vol. XXXVI. CHICAGO, ILL., JAN. 23, 1896. No. 4.



A Free Bee-Book.—Gleanings for Jan. 1, makes favorable mention of Government Bulletin No. 1, entitled, "The Honey-Bee: a Manual of Instruction in Apiculture. By Frank Benton." It was to be ready for distribution by the Department of Agriculture in a few days at 15 cents per copy; stamps not taken. Editor Root speaks very highly of it. So far we have seen nothing of it.

The Bee-Keepers' Union Report will be found on page 59 of this number of the Bee Journal. Mr. Newman always gets out a very interesting "annual message," showing the results of the conflicts of the year preceding, and the financial condition of the Union. This latter is in good shape, as will be seen—so that those who paid their dues for 1895 will not need to pay any for 1896, unless it is found necessary later on, which, in all probability, will not be the case.

Read that 11th Annual Report, and then if you are not now a member of the Union, send your \$1.00 to the General Manager—Thomas G. Newman, 147 South Western Ave., Chicago, Ill.

Selling Honey on Commission.—We have just been talking with the head of what we consider the largest firm of Chicago honey-dealers, about selling honey on commission. We asked particularly about the amount or per cent. charged for handling honey, and his reply was, that on a shipment which sells for less than \$100 gross, their rule was to charge 10 per cent. On any shipment selling for over \$100, they deduct 5 per cent. for their commission. We believe this is about right.

The gentleman referred to above, agreed with us in thinking Chicago the principal honey-distributing point in this country. As nearly as we are able to learn (and we believe it is not far out of the way), since the season for shipping honey opened for 1895, there have been shipped to the Chicago market up to this time, about 60 carloads. That means about 600 tons, or 1,200,000 pounds of honey. And that would be only about one pound for each person living in Chicago! Surely that one pound wouldn't last very long—

say probably a week. Then something like 50 times this amount might be consumed here every year, if it were properly distributed among the people.

Bee-keepers have a great work ahead of them, if the public is ever to be educated to use honey as it deserves to be used. Let every one do his share to popularize the consumption of the best sweet known—honey.

"Satisfaction Guaranteed."—While many are preparing advertisements for the new year, we wish to give them a *hint*. It should be the *aim* of all supply dealers and queen-breeders to give entire satisfaction to all of their customers, by giving "value received" for every dollar sent to them for goods—but no one can guarantee that every customer will be satisfied. Will those interested "take the hint," and endeavor to avoid complaints by "doing unto others" just as you would have them do to you? That "rule" is "worth its weight in gold." No wonder, for 'tis but the "Golden Rule." Resolve that it shall be the "rule" of your life this year. You will be happier, and so will all with whom you meet or do business.

Honey-Production in Germany.—An exchange says that it should be noted that in Germany little comb honey is produced, there being for the greater part no market for it. From the hives with fixed combs the best honey that is obtained is what is called "run honey," and it approaches extracted honey very nearly in quality. The crushed combs are placed in a sieve or a trough, and the honey permitted to run off. What remains is gently heated and strained. Extracted honey and "run honey" are sold on the average for 25 cents per pound, the "strained honey" 12 to 13 cents per pound. Come honey and extracted are the same in price. The honey is gathered chiefly from fruit-bloom, rape, esparcette, acacia or honey-locust, linden, corn-flower, etc.

Mr. Sutherland's Apiary, so nicely shown on the first page of this number, was photographed in August, 1895. Mr. S. writes this about it:

In the foreground you will see my wife, daughter and myself, while farther back is my son sitting in the buggy. On the left a portion of the house is shown; next is the wood-house, then the top of the barn is seen over the peach-trees, while at the right is the poultry-house.

I was born in Bainbridge, Mich., Oct. 10, 1851, and with the exception of a few months at a time I have always lived within the township. I first began bee-keeping in 1873, in company with my brother-in-law, with a few colonies, and increased to 30, then lost all with dysentery in the winter of 1875. In the fall of 1883 I found two bee-trees, transferred the bees into hives, and those, with two others, died in the winter of 1884. Then I was without bees until July 7, 1889, when a run-away swarm settled on a tree in the front yard. I lived them, and bought one colony in the spring. I have 20 colonies now, after selling 10.

In 1885 a man moved here with an apiary; he was taking another bee-paper, in which I found the advertisement of the American Bee Journal, for which I then subscribed. I should not know what to do without the Bee Journal now.

HENRY SUTHERLAND.

Selling Another's Honey.—In regard to what has appeared in the Bee Journal for Oct. 17, 1895, page 675, and in a recent number, Dr. Miller has this to say:

In the Question-Box was asked a question, some of the answers to which might be understood as intimating, if not plainly stating, that it was all right to buy other people's honey and sell it as honey produced in your own apiary. It was a mistake to answer without noting more clearly the bearing of the question, for when carefully examined the question asks: "Would it be right" "to make my customers believe" a thing that is not true? Put just in that shape perhaps not one in the lot would have answered in the affirm-

ative, and evidently the majority so understood it, as they answered in the negative.

Then the racy reviewer of the Review preached a sermon upon it, and made a mistake in making just the deductions and applications he did upon his text, or at least in making his statements so that a man usually so clear-headed as B. Taylor could make the mistake of saying to Hasty, on page 20, "You hold up to the public gaze seven of your brother bee-keepers to the charge of Rascal." For it is a mistake to understand that Hasty calls those seven men rascals. Then it was a mistake for Mr. Taylor to go to calling names just because he thought some one else was doing it. For that has no bearing on the case. Finally, the editor, on page 24, makes the same mistake as some of the repliers in misapprehending the question. He speaks of the correctness of the "advice to buy and sell another bee-keeper's honey when your own crop is all disposed of." Of course, that's all right, Mr. Editor, but that isn't at all the point upon which the questioner asks light, unless I am making a mistake bigger than that made by any one else. If I at all understand the question, it is this: "Would it be right for me to buy honey from others and sell it, provided I should put my name on it and make my customers believe it is from my apiary?"

Mr. Hasty having finished his sermon, let me add a short exhortation: Brethren, bee-keepers are, in the main, a pretty good set of men, and mean to do about the straight thing. Like others, they sometimes make mistakes, and it's all right to speak out and speak the truth, but please don't forget the injunction about "speaking the truth in love."

C. C. MILLER.

Replying to the question in your second paragraph, we should say: *No, sir; it is not right to deceive under any circumstances.* No bee-keeper need try to make customers believe the bought honey came from his own apiary, for any reasonable customer wouldn't care a fig where the honey came from, so long as he was satisfied of its purity. We are willing to say again, and over and over, that it is the proper thing for bee-keepers to buy honey to supply their customers, when their crop is all disposed of. If customers ask about the honey, tell them the truth, of course; if they don't care enough to ask about it, we say: Go ahead, and sell them all the good, pure honey you can get them to eat.

Good Word for the Bee-Papers.—Somnambulist, who writes so charmingly for the Progressive Bee-Keeper, had this to say lately:

Friends, have you noted the efforts that the different editors of the several bee-journals are and have been making to give us acceptable and attractive matter? Regardless of the generable hard times financially, and the especial hard times apiculturally—in the face of business failure, north, east, south and west, undaunted they stand at their posts and issue to us just as much in quantity, and of just as good quality, as when times were at their best. These thoughts were forced upon me while noting the rounding-up numbers of 1895.

Thank you, Sommy. We believe if all the bee-keepers, regardless of all discouragements, would help the bee-papers as enthusiastically as their publishers are trying to do their duty, every bee-paper would have twice as large a list of subscribers as they now have. But we don't complain, for our friends have been very good to us and the American Bee Journal, and we sincerely appreciate it. And we have such confidence in them that we believe they will yet do more for the "Old Reliable" and its publishers.

The Vermont State Convention will be held Jan. 29 and 30, 1896, at the Van Ness House, in Burlington. It will be the 21st annual convention. A splendid program has been arranged. Reduced hotel and railroad rates. Better go, if you can. Address C. W. Fisher, Secretary, 97 Cherry St., Burlington, Vt., for further information.

Every Present Subscriber of the Bee Journal should be an agent for it, and get all others possible to subscribe for it.

Southern Department

CONDUCTED BY

DR. J. P. H. BROWN, AUGUSTA, GA.

[Please send all questions relating to bee-keeping in the South direct to Dr. Brown, and he will answer in this department.—EDS.]

Report of the International Bee-Keepers' Congress at Atlanta, Ga., Dec. 4 and 5, 1895.

(Continued from page 43.)

Mrs. L. Harrison, Peoria, Ill., read the following essay on

Bee-Keeping for Women.

How many women say to themselves, "O if I could only earn some money, and spend it just as I want to, without having to give an account of it! If I could earn the money myself I would take a little recreation—go to the sea-shore or the mountains, and get something new to think about."

A lady who had traveled the world over, and had everything she desired that money would buy, was asked what had given her the greatest pleasure; she replied: "A few dollars that I once earned." Representative women from different sections of this great land of ours would have been present with us to-day could they have earned the necessary funds.

There are many avenues of emolument open to young women; they are teachers, bookkeepers, typewriters, and many find employment in manufacturing-plants. The number of occupations open to women have increased from 70 to more than 500 in less than 40 years. The want is something that home-keepers can do to earn money. There was a wide field open to the ingenuity of our grandmothers. They spun wool, cotton and flax, dyed and wove, cut and made garments, but now the inventive genius of man has superseded this with nimble-fingered machinery. Butter and cheese are made at factories. The ever busy mind of woman must now seek other avenues for the exercise of her faculties.

There is much more in a colony of bees than the honey and wax they represent. They offer to any intelligent and inquisitive mind a rich field of thought. Nature is rich in resources, and the honey-bees are in close relation with it. Sex in plants is now attracting more attention than formerly, and bees act as marriage-priests; while gathering the pollen to make the bee-bread for their brood, they disseminate the father dust from flower to flower. The cultivation of the honey-bee opens up a new world to a woman of inquiring mind, for every plant that grows possesses new interest to her, for it may mean dollars and cents to her purse. The little, modest white clover, wherever it rears its head, is petted and caressed, as it holds within its petals nectar, fit food for the gods. There is a lesson to be learned from the inmates of the hive.

"So work the honey-bee—
Creatures, that by a rule in Nature teach
The art of order to a peopled kingdom."

The government of a colony of bees is all in the hands of the females, and a woman may gain inspiration by its study as to how best to manage her household. When the young bee issues from its cell, weak and downy, it has not strength to roam the fields, and carry heavy loads of honey and pollen—it is then given the care of the young, to feed and nourish; digest the food and feed the queen and drones; secrete wax and build the comb; and is daily given a play-spell in the open air to locate its hive, and gain strength for the heavy labors of the field.

The office of the queen is no sinecure, as she lays at her best 3,000 eggs a day, and, let her reproductive powers fail, her throne is given to another, for their law is like that of the Medes and Persians, which change not—the greatest good to the greatest number.

Bee-culture opens an avenue for woman which has long been a want, as it gives to her the means of acquiring money in the retirement of her home, and at the same time look after the comfort of her household. Bee-culture requires no great outlay of strength at any one time; but to be a success there must be a faithful performance of many little items. Any

woman who can make a perfect loaf of bread can, having a good location, make bee-culture a success, as she realizes the importance of performing all the manipulations of the colony at the exact time.

Bee-culture requires no outlay for land upon which to raise crops, for as yet there has been no plant discovered that pays to plant for honey alone. The honey-bee is a benefactor to our race, roaming the fields at will gathering honey and pollen, which it pays for in the fertilization of the flowers. She takes nothing from the fertility of the soil, but gives to it one of the greatest fertilizers known—the clovers—which would become extinct if it were not for her agency in fertilizing the bloom. No land is required except a spot on which to place the hives. I knew a poor woman who occupied the second story of a tenement in a large city, and had no place to set her hives except upon a slanting roof. Her few hives, kept under such disadvantages, added materially to her slender income. I know of another lady who invested \$600 in bees, hives, and patented fixtures, who realized nothing for her expenditure. She had read a sensational story of a fortune being made in bee-keeping, and invested her means without knowledge, and entrusted the care of her apiary to a person who knew nothing of bees, but that "they stung and gathered honey." Bee-culture is a science requiring study and thought.

Women have made a success in bee-culture, and what woman has done woman can do. Two young women attending a boarding school suddenly found themselves thrown upon their own resources. Their father's fortune had flown, and with it his mind. In a log house, upon a little clearing in Michigan woods they engaged in bee-culture, and from its source supported their invalid parents, and obtained means of erecting a good home, surrounded not only with the comforts, but the elegancies of life.

Mrs. Sherman, a grand, noble woman of Texas, left a widow with an only son, reared and educated him, at the same time caring for an aged father by the culture of bees and poultry.

Women of the South, of education and means, would do much good by engaging in bee-culture, and interesting less favored women in its pursuit. It is a panacea for those in feeble health, taking them out into the open air, where, basking in the glorious sunshine amid flowers and the happy hum of industry, they will forget their aches and pains. When they uncover a colony of bees, and breathe in the aroma arising from thousands of flowers, they will take on new life, forget to worry and fret, singing instead, "Praise God from Whom all blessings flow."

In conclusion, to the agriculturist and horticulturist, I would say, Remember that the busy little bee is your friend and co-worker. She is trebly a benefactor—she causeth many blades of grass (I use the word in its broadest sense) to grow where none grew before; she multiplieth our fruits; she gathereth the richest of nectar to tickle our palates, and sooth our lungs; she toileth early and late, and at the close of her brief but useful life, she asketh neither grave nor monument. Let a grateful people write her obituary.

MRS. L. HARRISON.

BEESWAX PRODUCTION—TALL VS. SQUARE SECTIONS.

At the present price of honey and beeswax, would it not be profitable to produce beeswax as a primary product of the apiary? A. F. Brown said with honey at 5 cents and wax at 25 cents, it will pay to produce wax.

What advantage, if any, has a tall section over a square one? This question was discussed at length in the affirmative by Mr. Danzenbaker. He contended you could get more honey from tall sections than square ones, because they embraced more space; the bees enter them more readily; the combs built are more secure; and they command a better price in the market.

FREIGHT RATE ON EXTRACTED HONEY.

At the evening session the first question taken up was: "Should the freight rate on extracted honey be higher than on syrup? If not, what may we do to have them put on a par in this line?"

It was moved and carried that a committee of three be appointed to wait upon the railroad companies in reference to rates on honey. W. S. Hart, A. F. Brown and N. G. Osteen were put on the committee.

SHIPPING AND PRODUCTION OF EXTRACTED HONEY.

The discussion of the above question drifted to the best receptacle for shipping extracted honey. Mr. O. O. Poppleton stated that the barrels should be made out of cypress and waxed or paraffined. The amount of honey that soaks into unwaxed barrels would pay the cost of waxing. Only about a

pound of paraffine is required. The barrel must be thoroughly seasoned, and made hot in the sun or by artificial heat; the hoops driven up tight. The waxing material must be poured in hot and the hole closed. The hot wax expands the air which forces the wax into all the little holes. The barrel must be rolled over and turned around so all the inside gets covered. If the barrel is dry and hot, the wax will not peel off.

The next question was: "In working for extracted honey what is the best way to keep brood from the combs in the second story?" Some one answered that the brood did not interfere, and was not thrown out when large extractors were used and care taken.

The following resolution was offered by N. G. Osteen, and seconded by W. S. Hart:

To the Honorable Secretary of Agriculture:—

The International Congress of bee-keepers, composed of representatives from ten different States of the Union, in session at Atlanta, Ga., Dec. 4 and 5, 1895, after discussion of the needs of apiculture in the line of investigation and explanation, and having come to the conclusion that the United States Department of Agriculture can very materially aid us, respectfully petition and recommend the establishment of a Division of Apiculture in the Department of Agriculture, charged with such investigations as might be expected to aid and develop this industry in the United States.

The resolution was unanimously carried. It was the consensus of the Congress that bee-keepers should write their representatives at Washington, urging them to act in concert with the resolution.

The report of the committee on resolutions was as follows:

Resolved, That the thanks of this Congress are due the Mayor and Board of Trade of this city for the use of their very comfortable and convenient Council Chamber for our meetings; to the papers of Atlanta for publishing notices of our meetings, and a synopsis of the proceedings of the several sessions. Be it further

Resolved, That the thanks of this body are due our officers for the able conduct of our meetings, and particularly are they due our worthy president, Dr. J. P. H. Brown, who first conceived the idea of holding this Congress, and who has been the chief worker in perfecting plans and arrangements for its successful carrying out.

A. I. ROOT,
O. O. POPPLETON, } *Committee.*
J. D. FOOSHE,

A New Binder for holding a year's numbers of the American Bee Journal, we propose to mail, postpaid, to every subscriber who sends us 20 cents. It is called "The Wood Binder," is patented, and is an entirely new and very simple arrangement. Full printed directions accompany each Binder. Every reader should get it, and preserve the copies of the Bee Journal as fast as they are received. Why not begin with Jan. 1 to save them? They are invaluable for reference, and at the low price of the Binder you can afford to get it yearly.

If any one desires two of the Binders—one for 1895 and one for 1896—send 30 cents, and they will be mailed to you.

Honey as Food and Medicine.—A new and revised edition of this 32-page pamphlet is now issued. It has 5 blank pages on which to write or paste recipes taken from other sources. It is just what its name indicates, and should be liberally distributed among the people everywhere to create a demand for honey. It contains a number of recipes on the use of honey as food and as medicine, besides much other interesting and valuable information. Prices, postpaid, are: Single copy, 5 cts.; 10 copies 35 cts.; 50 for \$1.25; 100 for \$2.00. Better give them a trial. Send all orders to the Bee Journal office.

Back Numbers.—We have on hand a few back numbers of the Bee Journal for 1895, which we will mail to any one wishing them at 15 copies for 20 cents. They will all be different dates, but we have no complete sets for the year. Just send us 20 cents in stamps or silver, and we'll send you 15 copies. No doubt there are many new subscribers who will be glad to take advantage of this offer. All new subscriptions now begin with Jan. 1, 1896.

The Names and Addresses of all your bee-friends, who are not now taking the Bee Journal, are wanted at this office. Send them in, please, when sample copies will be mailed to them. Then you can secure their subscriptions, and earn some of the premiums we have offered. The next few months will be just the time to easily get new subscribers. Try it earnestly, at least.

THIRTY THOUSAND POUNDS BEESWAX

Is our present stock for this year's sales of Foundation. But still **We Want More Beeswax** and pay a good price.

Don't Delay Ordering Your FOUNDATION. You will pay more by and by than you would now. Remember that we make the BEST, and everybody acknowledges this.

Now is the time to read the work of the **Late Father Langstroth**—

Langstroth on the Honey-Bee, Revised.

The Price of this Work is now Reduced from \$1.40 to \$1.25, by mail.

Send us your address for Catalogue of Bee-Supplies, etc.

CHAS. DADANT & SON,
HAMILTON, Hancock Co., ILL.

Mention the American Bee Journal.

33 cts. a Pound

We allow

For Beeswax

In Exchange for

—SUPPLIES.—

1896 Circular Now Ready.

I. J. STRINGHAM,

105 Park Place. NEW YORK, N. Y.

Mention the American Bee Journal.

IF YOU WANT THE

BEE-BOOK

That covers the whole Apicultural Field more completely than any other published. send \$1.25 to Prof. A. J. Cook, Claremont, Calif., for his

Bee-Keeper's Guide.

Liberal Discounts to the Trade.

WANTED!

10,000 pounds of BEESWAX, for Cash. Address,
LEAHY MFG. CO., Higginsville, Mo.

Mention the American Bee Journal.



SUCCESSFUL INCUBATOR
Our magnificent new catalogue giving full information regarding artificial Hatching & Brooding and treatise on poultry raising sent for 4c stamps. Circular free.

Write now, Des Moines Incubator Co., Box 78 Des Moines, Ia

49A13t Mention the American Bee Journal.

The Rural Kansan

Is an Agricultural Journal for the busy farmer. It embraces Bee-Keeping and every department of industry connected with the farm. 30 cts. a year, monthly. Sample Free.

A Full Line of **Higginsville Bee-Supplies** on hand.

CATALOGUE FREE.
HENRY L. MILLER,
355 Shawnee Ave. TOPEKA, KAN.

1A13t Mention the American Bee Journal.

SELLING OUT.

To close out, I offer my Improved Queen-and-Drone Traps per 1/2 doz., in the flat, at \$1.75; per doz., \$2.75; per 25, \$5.00.

Individual Right to manufacture and use, 50 cents; Township Rights, \$1.00; County Rights, \$5.00.

HENRY ALLEY,
1Atf WENHAM, MASS.

TRY US. We sell your Poultry, veal, Fruits and all produce at highest prices. DAILY RETURNS. For stencils, prices and references, write **F. I. SAGE & SONS,** 183 Reade St., N. Y.

WHEN ANSWERING THIS ADVERTISEMENT, MENTION THIS JOURNAL.

11th Annual Report for the Year 1895

OF THE
National Bee-Keepers' Union.

For eleven years "The National Bee-Keepers' Union" has existed for the honorable purpose of defending beekeepers in their rights, and maintaining the privileges guaranteed to them by constitutional enactments—and I may add thankfully, without boasting, that every case has been tried upon its merits, settled by compromise, or otherwise disposed of, so that it begins the year 1896 with a clear field and a glorious record of achievements, unparalleled in the history of any similar organization in modern times!

Since my last Report was published, the Union has lost one of its first and most honored members, who was also known and revered by the Apiarists of the whole World—the Rev. L. L. Langstroth. He passed to the "life beyond" last October, fully prepared for the change, and entered "the home over there" with a heart full of love to all, and being also beloved by many thousands in both spheres of existence.

ELECTION OF OFFICERS.

up to the time of closing the polls, on February 1, 1895, showed that 151 ballots were recorded, as follows:

FOR PRESIDENT—

The canvass of all the votes received
Hon. R. L. Taylor, 126; Dr. C. C. Miller, 5; G. M. Doolittle, 4; Hon. Eugene Secor, 3; A. I. Root, 2; Scattering and blanks, 11. Total, 151.

FOR VICE-PRESIDENTS.

Dr. C. C. Miller, 114; G. M. Doolittle, 113; Prof. A. J. Cook, 102; A. I. Root, 101; G. W. Demaree, 77; Hon. Eugene Secor, 38; C. P. Dadant, 31; C. F. Muth, 22; P. H. Elwood, 16; G. W. Brodbeck, 14; G. W. York, 11; E. R. Root, 7; Hon. R. L. Taylor, 7; Mrs. Jennie Atchley, 6; Hon. James Heddon, 6; W. Z. Hutchinson, 4; S. I. Freeborn, 3; R. F. Holtermann, 3; Frank Beuton, 2; C. W. Dayton, 2; H. G. Acklin, 2; Scattering, 17.

FOR GENERAL MANAGER, SEC. AND TREAS.

Thomas G. Newman, 149. Blank, 2. Total, 151.

These ballots were arranged alphabetically, tied up and preserved for a year for inspection, as all former ones have been.

Although several had expressed their desire for a change in the officers, the members decided to keep the management in the same hands for another year.

As Mr. G. W. Demaree, Vice-President for 10 years—*positively declined to act*—desiring a change in the "official board," this elected Hon. Eugene Secor, who received the next highest number of votes.

WORK OF THE YEAR.

COLUMBUS, MISSOURI.

Last May, J. W. Bradley wrote as follows: "I am sued for maintaining a nuisance, against the dignity of the State. I have 20 colonies of bees, and a man living near me says that they stung him, so he made the charge. Please tell me what to do."

I sent him instructions what to do, and forwarded a dozen copies of the Arkansas Decision of the Supreme



SEE THOSE EYES!
LARGE PROMINENT EYES are not desirable in a potato. Our World's Fair Potato has very small eyes. Order of us and get pure, genuine Stock. Price way down. We have about every valuable variety. Seed corn, oats, barley, garden seeds. L. L. OLDS, Clinton, Rock Co., Wis.

Mention the American Bee Journal.



Promptness Is What Counts!

Honey-Jars, Shipping-Cases, and everything that bee-keepers use. **Root's Goods at Root's Prices,** and the best shipping point in the country. Dealer in Honey and Beeswax. Catalogue Free.

Walter S. Ponder
162 Mass. Ave. INDIANAPOLIS, IND.

Mention the American Bee Journal.

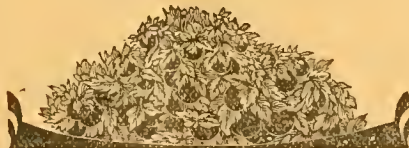

MONEY IN TOMATOES

But You Must Plant the Right Seed.

My new Seed Book tells all about the best kinds of Tomatoes and much else of interest in the Seed Line. Most attractive and instructive buyers catalogue ever published, illustrating these Tomatoes, free to intending purchasers. Address at once, P.O. Box 537

H. W. BUCKBEE,
Rockford Seed Farms, ROCKFORD, ILL.



Mention the American Bee Journal.

The Patent Wood Veneer FOUNDATION

has no sag in full sheets. EXTRA THIN Foundation 15 square feet to the pound. Working Wax into Foundation—if sent to me—a speciality. Send for prices, samples & Catalogue. Wax wanted.

AUG. WEBER,
2A5t HORTONVILLE, WIS

Mention the American Bee Journal.



ONE MAN WITH THE UNION COMBINATION SAW

Can do the work of four men using hand tools, in Rippling, Cutting-off, Mitring, Rabbeting, Grooving, Gaining, Dadoing, Edging-up, Jointing Stuff, etc. Full Line of Foot and Hand Power Machinery. Sold on Trial. Catalogue Free.

SENECA FALLS MFG. CO.,
46 Water St., SENECA FALLS, N. Y.

1A1y Mention the American Bee Journal.

Court. But some one interested (in the local postoffice, probably) stole the pamphlets and substituted an old newspaper in the wrapper, before delivery. Then I sent more in a sealed letter in a plain envelope. These were duly received, for it was too serious a matter to intercept letters, and thus call down the penalties of the United States law for so doing.

When the case was called for trial, the prosecuting attorney asked for more time, because he stated that he was not ready to go to trial. The defendant was ready and demanded a jury trial. The other side weakened, offered to settle, and finally induced Mr. Bradley to consent, which he reluctantly did. This was a mistake which he regretted ever since, because they would have been badly beaten.

WINSTON, NORTH CAROLINA.

Last June, Mr. Efrid wrote to the General Manager as follows: "My neighbors are making complaint, to my detriment, about my bees, and as a member of the Union, I desire to have your advice as to how to proceed in the matter. It seems that I have done about everything in my power to satisfy them, but they are not yet satisfied, and seem about to take action against me, unless I will dispose of them entirely, and I do not think it at all necessary, as my bees are very much closer to me than to any of my neighbors. My children and people are not annoyed with them. If the Union can sustain me in keeping them, it is my desire to have its assistance; but, at the same time, I stand more than ready to do anything in reason for the comfort and satisfaction of my neighbors."

The Manager of the Union armed Mr. Efrid with its documents, to fire at those in authority in Winston, and directed him to select the "best attorney" in that locality to attend to the case for the Union. That cannon was promptly fired, and the Winstonians now rest in peace, as well as the bees.

FAIRFAX, MISSOURI.

Joseph W. Blevins had about 45 colonies of bees, in Fairfax, Mo. Some of his neighbors, being envious of his success, had two ordinances presented at the City Council, declaring the keeping of bees a public nuisance. The first imposed a fine of from \$1.00 to \$100.00 for keeping bees within the corporate limits. This was passed but was not thought to be strong enough, and another was passed, making it a separate offense with a penalty of \$100.00 for every week that colonies of bees were found in that city, and authorizing the Street Commissioners to remove them, etc.

This was in direct violation of the Constitution of the United States, and the General Manager of the Union directed Mr. Blevins to distribute copies of the Decision of the Supreme Court of Arkansas to the Mayor and Councilmen, and employ an attorney to defend his rights. This was done and the ordinance was promptly repealed. The masterly argument of Judge Williams was too strong and overwhelming to give them a foothold. They saw it at once and surrendered gracefully.

WEST BRANCH, MICHIGAN.

The Village Council attempted to pass an ordinance, declaring the keeping of bees, a nuisance, subjecting the owner to a fine. Mr. Sirigley had 107 colonies, and two envious neighbors intended to "complain" under the ordinance if passed, and compel the removal of the bees.

The Manager counselled Mr. S. what to do, and instructed him to employ a lawyer to prevent the passage of the ordinance, supplying him with copies of the Arkansas Decision, and that action ended the trouble.

NELSONVILLE, OHIO.

Here, Dr. Cabel introduced a bill in the City Council to prohibit the keeping of bees within the corporate limits, and in a vehement speech denounced bee-keeping, declaring it a nuisance.

Mr. Rosser's apiary is at the edge of the city-limits, about one-half mile from the business center, and he said that they were in no sense a nuisance to any one. Other bees to the number of 50 colonies were similarly situated there, and if the ordinance should pass, trouble generally would ensue. Prompt steps were taken and that trouble was averted. Upon receiving the Decision of the Supreme Court of Arkansas, which I sent to Mr. Rosser to distribute to the Mayor and Aldermen, the case was killed. They said that if the Bee-Keepers' Union intended to take it in hand, they would not pass the ordinance. So much for the beneficent influence of the Bee-Keepers' Union.

But to further particularize will, perhaps, be unnecessary. I will, however, briefly say that other principal cases of complaint were located at the following places:

Strawberry, Gentry Co., Missouri.
Utica, La Salle Co., Illinois.
Toronto Junction, Ontario.
Stephens City, Virginia.
Grand Rapids, Michigan.
Connersville, Indiana.
Benton, Franklin Co., Illinois.
Bridgeport, Connecticut.
Elmira, Chemung Co., N. Y.

The General Manager instructed the bee-keepers in each case what to do, and supplied them liberally with the Decision of the Supreme Court of Arkansas, showing that bee-keeping was not a nuisance, *per se*, and could not be legislated against by any corporation, either Village, City, County or State. Where it was deemed essential, a good lawyer was selected and instructed to attend the meetings of the legislative bodies and watch the proposed ordinances, so as to prevent trouble and annoyance to the bee-keepers. These efforts in each case frustrated the designs of the enemies of the pursuit, and settled the disturbance.

The National Bee-Keepers' Union knows no dividing lines of States, Provinces and Territories—

"No pent-up Utica contracts our powers,
The whole unbounded Continent is ours."

The Union defends its members from the assaults of the enemies of the pursuit—no matter where they may happen to reside—if, upon investigation, their lawful rights and



PEERLESS
FEED GRINDERS.
GRIND CORN
Ear or Shell
Oats, Wheat, Rye
and Barley Fine
Enough for any
Purpose.
Made only by
JOLIET
STROWBRIDGE
CO. Joliet, Ill.

Mention the American Bee Journal. 34A26

WANTED.

10,000 pounds of BEESWAX, for
Cash. Address,
LEAHY MFG. CO., Higginsville, Mo.

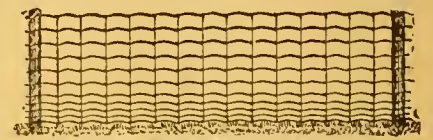

A FAIR PROPOSITION.

Six months free! Monthly Paper: Postpaid to anyone interested in the fence question. Under no obligations to buy of us, but use your best judgment.

PAGE WOVEN WIRE FENCE CO., Adrian, Mich.

Mention the American Bee Journal.

1896 SAVE MONEY 1896

If you want first-class **ITALIAN QUEENS** FOR BUSINESS, Foundation at Wholesale Prices, Hives, suited for the South, or SUPPLIES, send for Price-List—to

J. P. H. BROWN, AUGUSTA, GA.



POULTRY
40 Standard Breeds Illustrated & fully described in my new Poultry Book. Reliable information for poultrymen & intending buyers. Good stock flocks & Geese, also Saddle Pansies. Send 6c in stamps
E. H. COOK, Box 27, Huntley, Ill.

Mention the American Bee Journal. 4A13t

PATENT WIRED COMB FOUNDATION

Has No Sag in Brood-Frames

Thin Flat-Bottom Foundation

Has No Fishbone in the Surplus Honey.

Being the cleanest is usually worked the quickest of any Foundation made

J. VAN DEUSEN & SONS,

Sole Manufacturers,
Sprout Brook Montgomery Co., N. Y.

Mention the American Bee Journal.



NEW MAMMOTH
Poultry Guide for 1896 Finest book ever published, contains nearly 100 pages, all printed in colors, plans for best poultry houses, sure remedies and recipes for all diseases, and how to make poultry and gardening pay. Sent post paid for 15c.
John Bauscher, Jr., box 94 Freeport, Ill.

49A15t Mention the American Bee Journal.

Will Exchange —Concord Grapevines for Fruit. Grain or offers.

50A F. C. Morrow, Wallaceburg, Ark.
Mention the American Bee Journal.

California

If you care to know of its Fruits, Flowers Climate or Resources, send for a Sample Copy of California's Favorite Paper—

The Pacific Rural Press

The leading Horticultural and Agricultural paper of the Pacific Coast. Published weekly, handsomely illustrated, \$2.40 per annum. Sample Copy Free.

PACIFIC RURAL PRESS,

220 Market St., - SAN FRANCISCO, CAL.



OUR POULTRY ANNUAL

and Book of Valuable Recipes, 64 large pages, contains 8 beautiful colored plates of fowls, gives description and prices of 45 varieties, with important hints on care of poultry, and pages of recipes of great value to everyone. Finest Poultry Book published for 1896. Postpaid only 10 cts. **C. N. Bowers, Box 24, Dakota, Ill.**

52A1 Mention the American Bee Journal.

COMB FOUNDATION WHOLESALE and RETAIL.

Are you going to buy Foundation for Cash, or have you Wax to sell or trade for Foundation and other Supplies? Have you 25 lbs. or more of Wax that you want made into Foundation? If so, do not fail to write me for samples and prices. I make a specialty of working up Wax by the lb., and do it very cheap during the winter. Beeswax wanted at all times.

GUS DITTMER, AUGUSTA, WIS.

Reference—Augusta Bank. 16Atf

Mention the American Bee Journal.

YOUR BEESWAX!

UNTIL FURTHER NOTICE, we will allow 30 cents per pound for Good Yellow Beeswax, delivered at our office—in exchange for Subscription to the BEE JOURNAL, for Books, or anything that we offer for sale in the BEE JOURNAL. Or, 26 cts. cash.

GEORGE W. YORK & CO.,
CHICAGO, ILLS.

WOVEN WIRE FENCE

Over 50 Styles. The best on Earth. Horse high, Bull strong, Pig and Chicken tight. You can make from 40 to 60 rods per day for from 14 to 22c. a Rod. Illustrated Catalogue Free. **KITSELMAN BROS.,** Ridgeville, - Indiana.

48Et1f Mention the American Bee Journal.

MUTH'S HONEY EXTRACTOR PERFECTION Cold-Blast Smokers,

Square Glass Honey Jars, Etc.

For Circulars, apply to CHAS. F. MUTH & SON, Cor. Freeman & Central Aves., Cincinnati, O. Send 10c for Practical Hints to Bee-Keepers. Mention the American Bee Journal.

HATCH Chickens BY STEAM—With the MODEL. EXCELSIOR Incubator

Simple, Perfect, Self-Regulating. Thousands in successful operation. Lowest priced first-class Hatcher made. **Geo. H. STARR,** 114 to 122 S. 6th St. Quincy, Ill.

Mention the American Bee Journal. 3A8T

PATENT GARDEN HOE [No. 522,872] to let on royalty, or will sell for \$3,000; or will give agent fifty per cent. commission to sell. One person will perform more work with one of the hoes than three with other tools. Very easy to work. Extra blades to replace worn ones. Mention this paper.

J. H. ANDRE, Lockwood, N. Y.

privileges are found to be unjustly assailed.

Besides having collected several bills of long-standing and uncertain value, for honey shipped to commission merchants—furnishing information concerning the time for spraying trees so as to prevent the poisoning of bees—advising what safe use to make of honey which had been exposed to disease in an infected tenement, etc.—I have had to deal with a case where a neighbor threatened to poison the bees in an adjoining lot, by sowing buckwheat and spraying it with paris-green, so as to kill the bees by wholesale!

By taking prompt action in each case, the Union has prevented much mischief, and rendered valuable service to the pursuit of apiculture.

AMALGAMATION.

As many of the members are aware, it has been proposed to unite the "North American Bee-Keepers' Association" and the "National Bee-Keepers' Union" into one organization. It was expected that the vote on this amalgamation would accompany the vote for officers for 1896, but it is claimed by many members of the Union that the details have not yet been sufficiently discussed. It will be better not to "marry in haste and repent at leisure." The Committee in Charge, after careful consideration, have decided to defer the voting until a later period.

HONEY EXCHANGE WAREHOUSE.

California members propose that the Union should create a Honey Exchange Warehouse in some large city where they "could deal direct with the retailer through the General Manager, and secure to the honey-producer that which he now loses, and also prevent the influx in many places to a degree that would depress prices."

California has a right to be heard on such a matter, for during the past 5 years she has had 110 members in the Union, and to-day nearly one-quarter of the members hail from that State. In fact, California is the principal State in the Bee-Keepers' Union.

But I will offer a few suggestions: Such a Honey Exchange should be located in the very heart of the city selected for it, and be conducted on pure business principles. There must be a financial backing adequate to the business to be done. Shippers will want advances on consignments. Heavy freight bills will have to be provided for, and help and rent will not be small items of expense. It would need several thousands of dollars to start with.

In my opinion, this should be a separate business matter and not be tacked on to the Union. Financial reverses or some unexpected losses, by failure or otherwise, might bankrupt the Union in a short time. Besides, it should be managed by an expert honey-dealer, who should devote his whole time to the business.

DUES FOR THE COMING YEAR.

It now becomes my duty, under the Constitution, to call for the Dues for 1896. But in view of the fact that

"hard times" are upon us in "dread reality," the Advisory Board, at my suggestion, has decided that as the Union has sufficient funds on hand for present needs, that all members who paid \$1.00 for Dues for 1895 shall have the Dues for 1896 remitted, and they be declared members in good standing for 1896 without further payment, unless such shall be found to be necessary before the end of the year, (which is not at all likely, from present indications). All new members, as well as those who have not paid for 1895 will be required to pay \$1.00 as Dues for 1896. Article IV of the Constitution clearly leaves this matter of raising sufficient funds to the Advisory Board.

FINANCIAL STATEMENT.

Balance, as per last Report...	\$783.51
Fees from 242 members	242.00
	<hr/>
	\$1,025.51
Expenses for the year.....	\$254.90
	<hr/>
Balance, Dec. 31, 1895....	\$770.61
Donation, C. Klock.....	1.00
	<hr/>
Total balance on hand.....	\$771.61

The "Treasury" being in a satisfactory condition, the Union is fortunately in a position to demand justice, and protect the rights of its members in the courts of law. This is a place where "money counts." If the Union was a bankrupt concern, quite powerless to "help in time of need," its influence would be infinitesimal, and itself a laughing-stock for all. The "sinews of war" makes all the difference in the world.

Several more decisions from Supreme Courts are needed as precedents, for the guidance of Judges in lower courts, and these, I hope, will be obtained, covering several important points.

For the first seven years I successfully managed the affairs of the Union without recompense, save in the consciousness of having done my full duty, and of knowing that my services have received the unanimous endorsement of the members at each succeeding election. For the past four years I have received, as a nominal salary, twenty per cent. of the gross receipts, and during the past year that has amounted to a fraction less than 94 cents per week!

Of course such a munificent salary is in no sense a compensation for the time and labor necessary to successfully manage the affairs of the Union, and if it had been simply a business transaction, I should have refused to continue it long ago. The unanimity of my election year after year has alone induced me to continue to act, for I viewed it as a duty—instead of business.

If it shall please the members of the Union now to elect my successor, I shall retire with pleasure and a proud record! Fraternaly yours,

THOS. G. NEWMAN,
General Manager.

Dr. P. C. Gress, of Atchinson, Kans., would like to communicate, confidentially, with all persons who have consigned honey to C. R. Horrie & Co., of Chicago, Ill., with unsatisfactory results.



Disease is an effect, not a cause. Its origin is within; its manifestations without. Hence, to cure the disease the cause must be removed, and in no other way can a cure ever be effected. Warner's SAFE Cure is established on just this principle. It realizes that

95 PER CENT.

of all diseases arise from deranged Kidneys and Liver, and it strikes at once at the root of the difficulty. The elements of which it is composed act directly upon these great organs, both as a food and restorer, and, by placing them in a healthy condition, drive disease and pain from the system.

For the innumerable troubles caused by unhealthy Kidneys, Liver and Urinary Organs; for the distressing Disorders of Women; for all Nervous Affections, and physical derangements generally, this great remedy has no equal. Its past record is a guarantee of continued performance.

WARNER'S SAFE CURE CO.,

London, Rochester, Melbourne, Frankfort, Toronto, Paris.

Mention the American Bee Journal.

Honey & Beeswax Market Quotations.

CHICAGO, ILL., Jan. 18.—White clover and Linden comb honey is scarce and commands a premium over other grades of white of 1 to 3 cents per pound. There is a fair supply of other grades, which bring 12@13c. for white, and amber to dark ranges at 9@11c. Extracted is without special change; the Western ambers at 4½@5c.; white, 5@6c.; clover and basswood in cans and barrels, 6@7c. Beeswax, 28@30c. R. A. B. & Co.

CHICAGO, ILL., Jan. 20.—We are having good inquiry for fancy comb, but all other grades are selling slow. Dark comb will not sell on this market, and we would advise the producer not to ship it here. We are offering it as low as 9@10c., with no buyers. We quote: Fancy, 15c.; No. 1, 14c.; light amber, 12@13c. Extracted, light, 5@6½c.; dark, 4@5c. Beeswax, 28@30c. J. A. L.

PHILADELPHIA, PA., Jan. 3.—Honey has declined in this market during the holidays. Large lots of California honey arriving, and selling at 5c. in 60-lb. cases. We quote: Comb honey, fancy, 16c.; fair to good, 8@14c. Extracted, 4@5½c.; white clover, 10c. Beeswax, 30c. W. A. S.

KANSAS CITY, Mo., Jan. 8.—The demand for comb and extracted honey is fair. We quote: No. 1 white comb, 1-lbs., 13@14c.; No. 2, 12@13c.; No. 1 amber, 11@12c.; No. 2, 10c. Extracted, white, 6@6½c.; amber, 5@5½c.; dark, 4@4½c. Beeswax, 22@25c. C. C. C. & Co.

Demand is slow for all kinds of honey. Best white comb honey sells at 12@14c. in the jobbing way. Extracted, 4@7c. on arrival. Beeswax is in good demand at 22@27c. for good to choice yellow. O. F. M. & S.

WISCONSIN.—The annual meeting of the Wisconsin State Bee-Keepers' Association will be held Thursday and Friday, Feb. 6 and 7, 1895, in the capitol building at Madison. The program will appear in due time. Platteville, Wis. N. E. FRANCE, Sec.

General Items.

Comb Foundation Without Sidewalls.

I see that B. Taylor advocates foundation without any sidewalls. Now, there seems to be quite a difference in our experiments. The past season I tried about 40 brood-frames with foundation that had no sidewalls, and it did not "pan out" as well with me. Last spring I bought 15 or 16 pounds of foundation, thinking that would be all I would need, but I run short and had to buy some more. One of my neighbors was going over to see a person who had some foundation to sell, and I sent with him for 5 or 6 pounds, and when he showed it to me I told him that I thought the bees would be just as liable to build drone-comb out of it as worker-comb; and so they did. Some of it they worked out all right, into worker-comb, and some they worked into drone-comb. There were a few combs that the bees would work out all right on one side, and not even touch on the other side. Now, I do not know what makes so much difference in our experiments, unless it was that I did not use wire in my frames. Let that be as it may, I shall never try the experiment again. WM. CRAIG.

Luce, Mich.

Wintering Bees.

I am making a new hive which I think will be better for Northern bee-keepers, as the winters are so long. I make the frame 15 inches long, and 12 inches deep, inside measure. I am making a few to try, and will report next year.

In 1894 I had 10 good, strong colonies which I wintered on the summer stands, and two colonies left when spring came. With a frame 19 inches long and 9 inches deep, at both ends of the frame it was chock-full of honey, and the bees starved to death in the middle of the frame. They ate to the top and then starved. It was a hard winter on bees, we all know, so I think a deeper frame would winter them better as far north as this.

I have two colonies yet on the summer stands, facing the south, with cornfodder around them, and wheat chaff in the top-box. I got about 40 pounds of comb honey from them this year. It was terribly dry here last summer, but we are getting lots of rain now, and about three inches of snow.

WILLIAM DANIELS.

Perrysburg, Ohio, Dec. 8, 1895.

Sweet Clover Honey—Hives.

I had 18 colonies, spring count; had 3 prime swarms, and one that I found which had taken possession of an empty hive. I produced 2,000 pounds of choice comb honey, and 80 pounds of extracted, all, or nearly all, being from sweet clover, which grows on the public roads for several miles in all directions from my bee-yard. Without this honey-plant I think our crop would have been nearly a total failure.

I have sold my entire product at 13 cents, and have had a market for it all. Ten miles south of me there was no sweet clover, and there was not much honey, either. If sweet clover is cut at different dates it puts out new shoots and blooms again in a short time. Some of my neighbors mowed the roads opposite their land three times during the season, and in this way we had a continual honey-flow until frost. I did not have one section of dark honey.

I observe that some bee-keepers extract unfinished sections, and use the combs the next season. I used to practice that method, but do not do so any more, as the honey stored in the combs once used, with me, was never first-class the next season. Now I cut out the combs, melt them for wax, and use the sections for kindling wood.

I use mostly a large hive, 10-frame Lang-

List of Honey and Beeswax Dealers.

Most of whom Quote in this Journal.

Chicago, Ills.

R. A. BURNETT & Co., 163 South Water Street.

New York, N. Y.

F. I. SAGE & SON, 183 Reade Street.

HILDRETH BROS. & SECKLEN.

120 & 122 West Broadway.

CHAS. ISRAEL & BROS., 486 Canal St.

Kansas City, Mo.

C. C. CLEMOMS & Co., 423 Walnut St.

Buffalo, N. Y.

BATTERSON & Co., 167 & 169 Scott St.

Hamilton, Ills.

CHAS. DADANT & SON.

Philadelphia, Pa.

WM. A. SELSER, 10 Vine St.

Cincinnati, Ohio.

C. F. MUTH & SON, cor. Freeman & Central avs.

For Sale, Bees and Honey

I will sell 285 Colonies of Italian and Hybrid Bees in 8-L frame hives, all in cellars in good condition Jan. 15; and certainly to the best basswood region in North America. Would also sell a like number of Extracting-Hives and Combs, 3 Extractors, etc. My outfit is mostly new, hives well made and painted, all uniform and interchangeable. The greater number of Combs are made with full sheets of foundation, wired in. Frames have thick top-bars. My average of honey and increase for the past three seasons: 1893, honey, 110 lbs., increase, 90%; 1894, honey, 114 lbs., increase, 90%; 1895, honey, 58 lbs., increase, 3%.

This locality was visited by a quite hard frost in May, which destroyed all tree bloom and buds in the valleys, so the bees had to go on the ridges miles away for supplies, so I got ½ crop of honey and no increase.

Also, I have 30 Kegs of best water-white Basswood Honey, 260 pounds in a Keg, which I will deliver, f.o.b. cars here. One Keg or more, at 6½ cents. I have a few 50-pound Kets worth 6½ cents. Sample will be sent on application. My honey is now granulated.

Address, A. G. WILSON,
KICKAPOO, Vernon Co., WIS.

Mention the American Bee Journal.

WANTED—To exchange a 12-inch Vandervort Foundation Mill, but little used, for a Breech-Loading Shot-Gun.

4A2t J. P. H. BROWN, Augusta, Ga.

FOR SALE.

ALSIKE, CRIMSON, ITALIAN, ALFALFA, or WHITE CLOVER SEED.

4A8t WM. CRAIG, Luce, Mich.

WANTED—200 Colonies of Bees and 4-FRAME NUCLEI, on Simplicity or Hoffman frames, in exchange for Supplies, to be shipped either from here or Medina, Ohio. Send for Catalog to—GEO. E. HILTON,
4E4t FREMONT, MICH.

Mention the American Bee Journal.

BASSWOOD TREES!

Orders booked now for Spring delivery for

Nursery-Grown Basswood Seedlings

5 to 9 inches high, at \$2.00 per 100; 300 for \$5 or \$15.00 for 1000. Parties living east of the Mississippi river will be supplied direct from our Nurseries in Ohio. Satisfaction guaranteed.

A. H. FITCH,
702 Youngerman Bldg., DES MOINES, IOWA.

4A1f Mention the American Bee Journal.

TAKE NOTICE!

BEFORE placing your orders for SUPPLIES, write for prices on 1-Piece Basswood Sections, Bee-Hives, Shipping-Crates, Frames, Foundation, Smokers, etc.

PAGE & LYON MFG. CO.

NEW LONDON, N.Y.

Mention the American Bee Journal.

stroth. I have three or four 8-frame hives. My experience has been that the bees go into the supers just as soon in an 11-frame hive as if it had but 8 frames, and I get 32 sections of honey in a large hive just as quick as I do 24 sections in an 8-frame hive, and I do not think the bees are as apt to swarm so often. I give them supers at the proper time.

My best colony produced 160 perfect sections of honey the past season.

M. M. MILLER.

Chatsworth, Ill., Dec. 9, 1895.

Bees Near a Railroad Track.

In reply to a question asked recently about locating an apiary near a railroad, I would say that my bees are in winter quarters just 15 feet from a railroad side-track, and 30 feet from the main track, where the trains are passing as often as one every half hour. I have opened the front of my bee-house when the trains were passing, paid strict attention to them, and I could not perceive any difference in them. The bees do not seem to pay any attention to the jarring and confusion of the trains passing. I have a neighbor that has been in the bee-business several years, and his bees are kept in winter and summer, less than two rods from the same railroad, and he is successful with his bees. In my opinion it does not make any difference, except when the bees are coming home loaded, and a train is passing, it might make it a little inconvenient for them, as they might have to rise higher than they would had the train not been there. I shall locate my bees within less than four rods of the track.

Homer, Minn.

E. B. HUFFMAN.

Colo. Foul Brood Inspector's Report.

By request of some bee-keepers of this locality, I herewith send the last report of our County Bee Inspectors, for publication. The first column of figures shows the number of colonies inspected, and the second column the number found diseased with foul brood:

Arapahoe county	4,359	587
Boulder "	327	8
Bent "	19	13
Huerfano "	512	
Jefferson "	2,330	89
Larimer "	15	4
Weid "	470	29
Mesa "	1,892	203
Total	9,924	933

Of those colonies found diseased, 207 were ordered to be destroyed. There were quite a number of colonies affected with paralysis, which were not included in this report.

For the benefit of those bee-keepers who intend to remove with their bees to this State, I would say that it is to their interest to have their bees inspected before doing so. Section 7 of our State law on bee-diseases reads as follows:

"Should the owner or possessor of diseased colonies of bees, or any portion of said colonies, be they queens or workers, or of any affected appliances for bee-keeping, knowingly sell or barter, or give away, or move or allow to be moved, such diseased colonies, or portion of colonies, or infested appliances, he shall, on conviction before any justice of the peace, be liable to a fine of not less than \$50 or more than \$100, or to imprisonment in the county jail for any term not exceeding two months."

FRANK RAUCHFUSS,

Sec'y. Colo. State B.-K. Association.

Duff, Colo., Dec. 7, 1895.

Best Hives and Bees—Report.

In speaking of our failures, I often think of a friend who once said that to be successful in any pursuit we must first pass through an age of darkness. This statement can surely be applied to bee-keepers, for where is there a bee-keeper of any note who has not made glowing and expensive

CHEAP SECTIONS! CHEAP SECTIONS!

We have at this Branch among the Stock purchased of Thos. G Newman the following stock of Sections—not of our manufacture—which we desire to close out to make room for our

Superior Extra Polished Sections.

In order to close them out quickly we offer them for the next 60 days, or while they last, at these special prices:

White Sections, 4 1/4 x 4 1/4.		Cream Sections, 4 1/4 x 4 1/4.	
40,000 1 15-16 1,000 for \$1.75	10,000 1 15-16 1,000 for \$1.25
50,000 1 7/8 2,000 for 3.00	20,000 1 7/8 2,000 for 2.00
80,000 7-to-ft. 5,000 for 7.00	1,000 7-to-ft. 5,000 for 4.50

With all orders for less than 5,000, add 25 cts. for cartage.

These Sections are of Wisconsin manufacture, and when made were doubtless considered as good as the best; but as compared with our Extra Polished Sections they are not up to the standard of to-day, but a decided bargain and should be closed out quickly at these very low prices. If you prefer a sample before ordering we will mail one for 5 cts. to cover postage.

The A. I. Root Co., 56 5th Ave., Chicago, Ill.

INCUBATORS **WE WARRANT**
THE RELIABLE



To hatch 80 per cent of the fresh and fertile eggs. Hundreds of recent testimonials! Have this year (1896) issued our Eleventh Annual Poultry Guide and Combined Catalogue in one valuable book.

PROFITS IN POULTRY!

This 148-page, fully illustrated Poultry Guide tells you about profits in poultry; about hatching eggs with machines; about brooding chicks without hens. We have for sale sixteen popular kinds of thoroughbred fowls; also full line of Poultry Supplies—anything you want. Price of Guide, 10 cents in stamps—worth one dollar.

Address, **RELIABLE INCUBATOR AND BROODER CO., Quincy, Ill.**

OVER ONE HUNDRED POULTRY PICTURES

Of Poultry Houses, Incubators, Brooders and Poultry Appliances in Poultry Keeper Illustrator No. 1. Price 25 cents postpaid, or 75 cents for four numbers of 1896. That leading poultry magazine, THE POULTRY KEEPER one year fifty cents, or both the Poultry Keeper and Illustrator one year to new subscribers only eighty cents. Sample Poultry Keeper FREE. POULTRY KEEPER CO., Box T, Parkersburg, Chester Co., Penna.

mistakes? I will name a few of my blunders pertaining to our pleasant pursuit.

The first is a lot of 8-frame hives I made, which are a nuisance in this locality, for the reason that they are too small, as the bees are often found in a starving condition before clover blooms, owing to breeding and increase of bees; being so small the bees are liable to swarm too much. The hive will not accommodate bees enough to work to the best advantage. I know this is true, as I have had 12-frame hives in the apiary for several years, and it is a common thing to find 10 frames of brood in these large hives during the summer. Another thing, I want my bees to gather their stores for winter and spring use, for I despise being compelled to feed my bees through the spring, for the reason they do better on natural stores gathered the previous season.

I will sum the matter up as follows: I want a handy hive so I can manage my bees with the least amount of labor, and at the same time get a good crop of honey, if the flowers furnish the nectar, as I have a small farm to look after and do the work on it as well as to tend the bees.

What strain or race of bees will we keep? This is settled in my mind. I would not give one imported Italian queen for one dozen of the choicest 5-banded Italian queens in existence. I have imported queens direct from Italy, also had the golden queens from many breeders, so I think I know what I say. I like gentle bees, also bees that will winter on the summer stands and not dwindle down to a handful per hive.

My report for 1895 is as follows: I commenced the season with 75 colonies that wintered without loss, and increased to 80 colonies; secured a crop of honey amounting to 1,278 pounds, an average of 17 pounds per colony. I had an average of 41 pounds per colony in 1894.

C. A. BUNCH.
Nye, Ind.

Three Seasons' Reports, Etc.

I suppose we ought to report our honey crops, good or bad. This is my third year of bee-keeping. In 1893 my bees averaged 110 pounds per colony, spring count; in

1894, a fraction over 80 pounds; and this year they only averaged 27 3/4 pounds. But I must not complain, for I know several bee-keepers around here that have from 5 to 40 colonies that have not any surplus at all. I have come to the conclusion that if we keep many bees on these ridges we shall have to sow forage for them. They appear to do better along the Mississippi bluffs. I think the reason is because the bluffs are so steep that they can scarcely be pastured with sheep, consequently there is more forage for the bees.

I had one colony this year that every time I went into the yard I would see one, two or three bees crawling around the front of the hive apparently blind. Their heads were very small, and sometimes I saw a very small eye on one side of the head. I would like to know if any one else ever had such a case. I have never seen anything of the kind in any bee books or papers. I think I know what I ought to have done with that queen—I ought to have pulled her head off and given them a better one.

DANIEL SMETHURST.
Seneca, Wis., Dec. 16, 1895.

Queens and Queen-Rearing.

—If you want to know how to have queens fertilized in upper stories while the old queen is still laying below; how you may safely introduce any queen, at any time of the year when bees can fly; all about the different races of bees; all about shipping queens, queen-cages, candy for queen-cages, etc.; all about forming nuclei, multiplying or uniting bees, or weak colonies, etc.; or, in fact, everything about the queen-business which you may want to know—send for Doolittle's "Scientific Queen-Rearing"—a book of over 170 pages, which is as interesting as a story. Here are some good offers of this book:

Bound in cloth, postpaid, \$1.00; or clubbed with the BEE JOURNAL for one year—both for only \$1.75; or given free as a premium for sending us three new subscribers to the BEE JOURNAL for a year at \$1.00 each.

Bottom Prices

**BRING US BIG TRADE.
GOODS KEEP IT.**

If you want the best supplies that can be made at a little less cost than you can buy the same goods for elsewhere, write to us for low prices. 1896 Catalogue now ready—ask for it and a free copy of **The American Bee-Keeper** (36 pages).

Address,

**THE W. T. FALCONER MFG. CO.,
JAMESTOWN, N. Y.**

Mention the American Bee Journal.



Wonderful Record.
17 Years with but one complaining letter.

I think Bingham Smokers and Bingham & Hetherington Honey-Knives are PERFECT. Write what you think of them, on a card, and mail to—

T. F. BINGHAM, Farwell, Mich.

4A4t *Mention the American Bee Journal*

HEADQUARTERS for ROOTS' GOODS

Can supply you with all the Fixtures used in an Apiary. Best Goods at Lowest Prices. Catalogue free. 5% discount until March 1st.

JNO. NEBEL & SON, High Hill, Mo.

Mention the American Bee Journal. 4Atf

The Bee-Keepers' Guide:

Or Manual of the Apiary,

BY PROF. A. J. COOK.

This 15th and latest edition of Prof. Cook's magnificent book of 460 pages, in neat and substantial cloth binding, we propose to give away to our present subscribers, for the work of getting new subscribers for the American Bee Journal.

A description of the book here is quite unnecessary—it is simply the most complete scientific and practical bee-book published to-day. Fully illustrated, and all written in the most fascinating style. The author is also too well-known to the whole bee-world to require any introduction. No bee-keeper is fully equipped, or his library complete, without "THE BEE-KEEPER'S GUIDE."

For Two New Subscribers and Your Own Renewal.

Send us **Two New Subscribers** to the Bee Journal and your own renewal (with \$3.00), and we will mail you a copy of Prof. Cook's book FREE as a premium, and also a copy of the 160-page "Bees and Honey" to each New Subscriber. Prof. Cook's book alone is \$1.25, or we club it with the Bee Journal for a year—both together for only \$1.75. But surely anybody can get only 2 new subscribers to the Bee Journal for a year, and thus get the book as a premium. Let everybody try for it. Will you have one?

**GEORGE W. YORK & CO.,
CHICAGO, ILLS**

Bee-Keepers' Photograph.—We have now on hand a limited number of excellent photographs of prominent bee-keepers—a number of pictures on one card. The likeness of 49 of them are shown on one of the photographs, and 121 on the other. We will send them, postpaid, for 50 cents each, mailing from the 121 kind first; then after they are all gone, we will send the 49 kind. So those who order first will get the most "faces" for their honey.

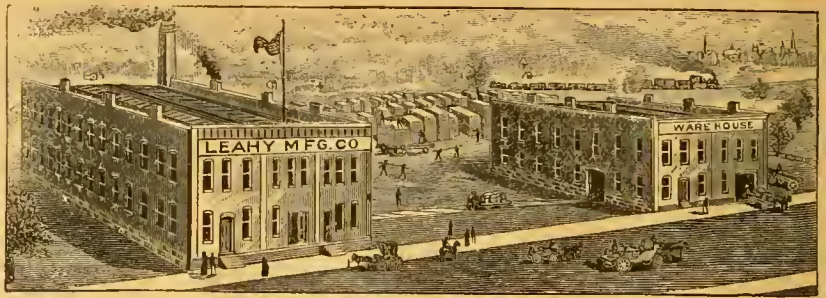

Largest Factory in the West COMPLETE STOCK. Good Supplies and Low Prices Our Motto.

READ THIS—Mr. Keyes says: The 100 pounds of Extra-Thin Foundation you sent us is superior to anything he ever saw; and I think the same. R. L. TUCKER, Wewahitchka, Fla.
Dear Sirs:—The Sections came duly to hand. Indeed, they are very nice. Yes, sir; they are as good as the best. CHARLES H. THIES, Steelville, Illinois.

Leamy Mfg. Co.—I have received the bill of goods. I must say they are the choicest lot of Hive-Stuff I have ever received from any place. I admire the smoothness of your work, and your close selection of lumber. Yours very truly, O. K. OLMSTEAD, Orleans, Nehr.

Dear Sirs:—The Sections arrived in due time, and are all O. K. so far as examined. They are simply perfection. I can't see how you can furnish such goods at such low prices. I hope you may live long and do well. Yours respectfully, Z. S. WEAVER, Courtney, Tex.

Gents:—I received the "Higginsville Smoker" all O. K. It's a dandy; please find enclosed stamps for another. Yours truly, OTTO ENDERS, Oswegatche, N. Y.

Gentlemen:—I have bought Supplies from nearly all the large manufacturers by the carload, and I must say yours are as good as the best. Indeed, in many lines they are the best. It is a pleasure to handle them. E. T. FLANAGAN, Belleville, Illinois.

The above unsolicited testimonials are a fair sample of hundreds we receive.

Our prices are reasonable and the "Higginsville Goods" are the best.

We are now manufacturing for each of the following parties a Carload of Supplies: E. T. Flanagan, Belleville, Illinois; Charles H. Thies, Steelville, Illinois; J. W. Rouse & Co., Mexico, Mo.; Henry Miller, Topeka, Kans.; Fulton & Gregg, Garden City, Kans.

If you need a Carload of Supplies, or only a Bee-Smoker, write to us. Remember, we are here to serve you, and will, if you give us a chance. **A Beautiful Catalogue Free.**

Address,

LEAHY MANUFACTURING CO., HIGGINSVILLE, MO.

49A

Mention the American Bee Journal.

CASH PAID FOR BEESWAX

For all the **good, pure yellow BEESWAX** delivered to our office on or before Feb. 20, 1896, we will pay 26 cents per pound, cash; or 30 cents for whatever part is exchanged for Bee Journal subscription or books that we offer. If you want **cash promptly** for wax, send it on at once. Dark or impure wax not taken at any price. Address plainly,

George W. York & Co., 56 Fifth Ave., Chicago, Ill.

SECTIONS, BEE-HIVES, SHIPPING-CASES

We make a Specialty of these Goods, and defy Competition in

QUALITY, WORKMANSHIP AND PRICES.

✉ Write for Free Illustrated Catalogue and Price-List.

G. B. LEWIS COMPANY, Watertown, Wis.

✉ Be sure to mention the American Bee Journal when you write. ✉

* ROOT'S COMB FOUNDATION! *

New Product.

We are pleased to announce that, having secured control of the new Weed process of manufacturing foundation for the U. S., we are prepared to furnish **Foundation by the New Process**, for 1896. Samples will be mailed free on application, and will speak for themselves.

New Process.

OUR SANDED and POLISHED SECTIONS, well, they will speak for themselves, also.

A Big Success

Our 1896 Catalog

will be ready for distribution now in a few days. Send in your name at once for catalog, samples of the new foundation, and those superb sections, and while you are about it ask for late copy of **Gleanings in Bee-Culture**.

THE A. I. ROOT CO., MEDINA, OHIO.

56 5th Ave., Chicago, Ill.

Syracuse, N. Y.

1024 Mississippi St., St. Paul, Minn.

AMERICAN BEE JOURNAL

DEVOTED EXCLUSIVELY TO THE INTERESTS OF HONEY-PRODUCERS

ESTABLISHED 1861
THE OLDEST BEE-PAPER IN AMERICA

Published Weekly, at \$1.00 per annum.

Sample Copy sent on Application.

36th Year.

CHICAGO, ILL., JAN. 30, 1896.

No. 5.



Alsike Clover for Honey and Forage.

BY FRANK COVERDALE.

I have, as usual, raised a fine field of this very valuable crop. No crop pays me so well in dollars as does Alsike clover. It has never yet failed. I have secured a fair stand at sowing during the past two dry seasons. From 35 acres, 115 bushels of fine, re-cleaned seed has been bulled, and the hay, after being stacked, is equivalent to at least one ton of extra hay for cattle (one ton per acre). Let us figure the proceeds:

115 bushels at \$5 per bushel, clear.....	\$575 00
One ton choice hay per acre, at \$6 per ton..	210 00
Total	\$785 00

This is at very low figures. It is a little over \$22 per acre, saying nothing about fall feed, or how much better the



Alsike Clover.



Crimson Clover.

a contrast! Are these not facts? Yes, they are facts at home. I ask you to read carefully every word of this, then put on your thinking cap, as Alsike is an excellent honey-yielder.

ALFALFA FOR HONEY AND FORAGE.

Three acres of fine alfalfa grows about three miles south of here. It has been there for three years, or cut two seasons.



Mr. J. K. Darling, Almonte, Ont.—See page 68.

It is on top of hills and in a valley, and does well in both cases, yielding more good hay than any other clover grown here—three good cuttings in a single season, or one cutting for hay and one for seed. Bees work on it some, but do not take to it as well as to Alsike. I have some fine alfalfa, sown last spring, which has made a good growth during the past very dry summer. Drouth doesn't kill it at all, even when all other clovers will die (except sweet clover).

SWEET CLOVER FOR HONEY.

Sweet clover is spreading rapidly here. It seems to thrive anywhere wherever it drops its seed on the hardest of ground, and on wet, low land, in school-yards, fence-corners, or anywhere. I know of two places where it extends two miles almost a solid mat on either side of the road, and one school-house yard near me has for years been an ocean of bloom. Sometimes it is cut down, but it seems to sprout and

land is after it is taken off. Fifty bushels of corn per acre at 25 cents per bushel will net when sold \$12.50, and after much more labor has been required to attend and harvest it—a little over half the profit, and the land made poorer! What

bloom again. Sweet clover never fails to yield honey, and is the best of all honey-plants here, *by far*.

Three miles west of me is three miles of it, and three colonies of bees in the midst of it. Those colonies were working continually on it, and the hives were chock-full of honey when my bees were doing nothing. Mine at that time were away at basswood, 12 miles away, and had no sweet clover. I am sure that if all the roadsides were growing it, honey would be plenty every year.

CRIMSON CLOVER.

I sowed 5 acres of crimson clover Sept. 20. The ground has been frozen six inches deep, with some snow, and at this writing the snow has melted and thawed the ground, with fine rains, and the crimson clover looks just as green as before. It is actually growing now; *perhaps it may winter!*

Delmar, Iowa.



The Place of Theory in Apiculture, Etc.

BY F. L. THOMPSON.

I notice that my statements—"Even facts may be misleading," and "To keep adding more experience, first on one side, then on the other, leads to no conclusions"—have been taken for exaggerations, and replied to with exaggerations—"facts, not theories," and "theory vs. practice." It is as plain as anything well can be that those statements of mine mean "facts and theories," not "theories vs. facts."

But, while stating the mere truth in regard to the limitations of facts, I did not express my opinion of the relative value of practice and theory. This seems to have worried some. Well, I will do so now. Practice is far, far preferable to theory *when you can get it*; and fact, in one sense, can snap its fingers at theory, while theory has to have a basis of fact. There.

But why is it adverse to common-sense to omit common-places? And why should it be so exceedingly sensible to take commonplaces, and exaggerate them? That is just what is done by the maxim, "Facts, not theories." It is not true. Facts exist without theories; but they cannot be applied without them.

Now, just to show my fiercely practical critics how reasonable I can be, I will add that all theorizing has an innate *tendency* to become fine-spun and impracticable. There's an admission for you, though you don't deserve it. But remember, that is not saying that that tendency cannot be resisted, and that there are not such things as suggestive, important, and practical theories.

Further, I believe that in American apiculture, at least, the proportion of pure theory to fact should be kept small. For, as I understand it, most of us keep bees primarily for money, and only secondarily because it is agreeable to keep them. But (to refer momentarily to another question) it is mere affectation to take no account of the latter; while the most matter-of-fact and practical among us, it is very evident, cannot keep out theory as they say they do.

Let us see how it would work to apply that remarkably acute rule of "facts, not theories." Turn over the pages of the American Bee Journal for 1895, and strike out the following: Page 18, Mr. Abbott's theory that it is the swarming bees that gather honey; page 98, Mr. Davenport's theory that locality has nothing to do with the right size of a hive; page 149, Dr. Brown's theory that breeding for honey-gathering requires breeding for muscular development; page 326, Mr. Doolittle's theory on the prevention of swarming; page 376, Mr. Davenport's theory that eight frames are enough for the best queens; page 618, Mr. VandeVord's theory that longevity and prolificness can be easily combined; pages 618 and 824, Messrs. VandeVord's and Barclay's theory that longevity tends to prevent swarming more than anything else; excise elsewhere Mr. McKnight's theory that cellar-wintering may imitate the good effects of out-door wintering by occasionally raising the temperature; Mr. Heddon's theories on pollen in winter-food; value of the storage and transmission of winter sunshine; breeding out the swarming impulse; great superiority of shallow to deep frames in breeding; cause of poor seasons, etc.

The foregoing, however, are the most obnoxious cases. If we should insist on applying the rule literally, strictly, and unsparingly, the information left would be the merest shell.

See also Mr. Abbott's words on this subject on page 283; and even supposing all those theories were false, ponder the following from Darwin: "False facts are highly injurious to the progress of science, for they often endure long; but false views, if supported by some evidence, do little harm, for every one takes a salutary pleasure in proving their falseness; and

when this is done, one path toward error is closed, and the road to truth is often at the same time opened."

It seems to me that the motto, "Facts, not theories," is a rather factastic one to indicate a truthful ideal; while the idea that there is such a question as "Theory vs. practice" is, to say the least, picturesque.

EXPLANATION ON OVERSTOCKING.

In reply to Dr. Miller's note on page 823 (1895), I am pretty certain my copy contained a comma in the place referred to.

I don't mean to say there is no such thing as overstocking, nor that if in a good season 200 colonies do well, they might all starve if the number was increased enough. Perhaps, Dr. Miller, you and I are thinking of different things. I remember reading that bees sometimes pay no attention to white clover, showing that there is then no nectar in it. In such a case those blossoms might as well not be there, as far as the bees are concerned, and the few other flowers that remain are not sufficient to prevent the locality from being overstocked by a few colonies. But that is not the kind of poor seasons we have here. The alfalfa never fails to yield nectar, though sometimes in scanty dribbles. Now, as long as nectar flows in each blossom, I don't see that the bees have very much less work to do to keep them all licked out often enough to prevent re-absorption into the tissues of the plant, when it is coming in a scanty stream then when it is coming in a full one—the quantity in each flower is exceedingly small, even in the latter case.

To illustrate: When I was a boy we used to depend for firewood on the driftwood along the creek bottom. Sometimes there would be here and there a stick, and sometimes they would lie in beds. Generally the former condition would prevail. Two persons would then gather perhaps three loads a day. Now, do you mean to tell me that when two can gather three loads, one person can gather six? Isn't there something shaky about that idea?

If my reasoning is correct, then when 200 colonies do not do well in a poor season in a locality such as mine, to say that 100 colonies would have done better is also "one of those half-truths that sometimes make mischief," and in the light of the experience I have before given, there appears to be no grounds for fixing on 200 as the limit. Arvada, Colo.



Some Subjects Reviewed and Commented Upon

BY DR. C. C. MILLER.

NON-SWARMING BEES.—The interesting report of Jno. McKimmie, on page 29, suggests that he would be doing a favor if he would tell how many colonies he has had that have not swarmed during the past six years; also the size and number of frames used, and whether he runs for comb or extracted honey.

BOX-HIVES.—E. H. Gabus (page 36) brings good support to show that under some circumstances box-hives may be excused for not going out of existence. The whole thing in a nut-shell is this: Movable combs are not for the benefit of bees, but of bee-keepers; box-hives are as comfortable as the others, and perhaps more so; and there's no use in having *movable* combs if they're never to be *moved*. So important are box-hives considered in Germany that the very able Centralblatt alternates by giving special instructions for box-hives in one number and for movable-comb hives in the next.

NORTH AND SOUTH.—J. D. Fooshe is puzzled (page 42) to know why, in spite of the many advantages, Southern bee-keepers do not succeed better than those in the North. Possibly he can find a partial explanation in his own words, when he says: "In October the golden-rod and asters are in full bloom, and our bees gather more honey and a better quality than from any other source." If a Northern bee-keeper got no better honey than golden-rod and asters yield, he would hardly make a very big success.

SWARMING BEES.—On page 45 Paul Whitebread cites the case of two colonies to show that swarming bees do best. It should be remembered that very little can be proven by an isolated case. I'm not now discussing whether swarming or non-swarming is best, but many a time two colonies side by side, alike in every respect so far as can be seen, will give very different results. Of course, there is a difference, even if it can't be seen, and Mr. Whitebread's queen may not have been as good as the other. If he'll have 50 colonies of non-swarmers side by side with 50 swarmers, and then note the results,

not for a single year, but for a series of years, he will have some data that will be of value. But if he can always stop swarming by giving 48 sections he'll do better than others.

BEES CUTTING LEAVES.—On page 45, R. Howell asks about bees cutting out pieces of lilac leaves and carrying them off. I think if he had followed up those bees he would have found that they didn't go to hives, but were a sort of wild bee that make very ingenious nests by means of pieces of leaves. They make very rapid work in cutting the leaves with their powerful jaws. I never saw them on lilacs, but I've watched them many a time cutting rose-leaves.

MOWING SWEET CLOVER.—In reply to C. Winn's question, on page 46, if sweet clover be cut down as late as July 10, it would in some cases be so far advanced that cutting it close might kill it outright, although in some cases it would sprout up again. But if it were cut down before coming into bloom, and then cut down again July 10, I think he would find it would bloom till frost. Indeed, it often sends out fresh shoots on the apparently dead stalks that blossom late.

Marengo, Ill.



No. 1.—Experiences, Impressions and Reflections After Five Years of Bee-Keeping in California.

BY RAMBLER.

There is evidently no area of land on our continent that excites more wonder and curiosity than the State of California. The story of its early settlement by the Spanish Padres, the establishment of the missions and the civilization of the degraded natives, was full of romance, adventure and Christian fortitude; and now that age is passed, and we have here the ruins of those missions that long ago meant so much for California. Their broken and vine-covered arches re-echo now only to the tread of the tourist, and the bells that once sent their sweet chimes echoing over mountains and plains, hang in silence above the crumbling walls.

California—then the land of romance, isolated from the East by lofty ranges of mountains, and long stretches of alkaline deserts—it required in the early days heroic efforts to reach it. We all read with intense interest, even at this late date, the adventures of Fremont and his fellow explorers, as they opened up the pathway to this Coast.

The discovery of gold, with all of its attendant excitement, adventures, successes and disappointments, and the tide of immigration from every quarter of the globe, added another chapter to the romance of the land. With the influx of more people the unknown canyons were explored, and the great natural wonders continued to enlist a lively interest; and when all other themes had been exploited, the wonderful climate became a subject of never-ending admiration.

In every sense of the word it is the "Land of Sunshine." While blizzards are tearing the Eastern States, and intense cold sends people shivering to their firesides, this strip of country—200 miles wide and 800 in length—is redolent with the odor of roses, and the seasons are so gradual in their changes, and so mild, that it seems like one unending summer; the resident often forgetting that the balmy weather of January is indeed winter.

In the early days of mining, fortunes of gold were not bestowed upon all, and the agriculturist not finding the yellow metal turned his attention to the cultivation of the soil. As a natural sequence the honey-bee soon followed the orchardist, and soil and tree and hive, all upheld the reputation of the country for wonderful results, and the romance of the land has never been diminished.

My theme, however, in these sketches, is not California and its wonders, but they are to give experiences, impressions, and conclusions drawn from five years' actual service in California apiaries. In this service I have endured stings, rattlesnakes, skunks, and coyotes, and, like a battle-scarred veteran, I am spared to tell the tale.

In a portion of these sketches I will necessarily go over some ground that I have already written up in Gleanings in Bee-Culture, and while the main facts have been given in part before, I here touch upon actual work and impressions that could be gathered only after living here a term of years.

I was not attracted toward California by any sentiment of romance, or in the pursuit of the ever-fleeting phantom—gold; but having followed wife and child, and parents, to their last resting-place, I felt that the light and warmth of loving hearts had gone from my old home forever; an undefined unrest took possession of me, and it seemed that no distance

was too great to separate me from the scenes of my affliction; and that unrest has sent me far, far indeed from the scenes and acquaintances of all of my previous life.

I arrived in Sacramento July 17, 1891, and stopped a few weeks with a kinsman, who is in business in that beautiful capital city. I soon learned that bee-keeping was a pursuit of not much consequence here—a few small apiaries were located in the suburbs of the city, the owners living in peace and harmony with their fruit-growing neighbors; down the river were other and larger apiaries, but the honey they produced was not in large quantities, and not of a high grade.

In the early days of California bee-keeping the Sacramento valley had been a noted field for honey-production, and it was here that Mr. Harbison commenced the career that afterward gave him world-wide fame as a honey-producer. But the Sacramento valley was the first to be put to agricultural uses, and the sages and a multitude of wild flowers were destroyed, wide areas of wheat usurping their place. Mr. Harbison finding his occupation crippled in this valley, moved to the extreme southern end of the State, and in sight of the Mexican line had, for many years, an unmolested field.

After a few weeks in Sacramento, I followed the example of Harbison, and also traveled to the south. Here, indeed, I found bee-keeping conducted upon those extensive plans about which I had so often read—the out-apiary in some remote canyon; the wild country; the honey-flora so different from the flowers I had observed so much in the East; and the wintering problem no factor whatever. All of these features were new and novel, and though the same principles are applied here for the production of honey, they are applied under more favorable circumstances than when applied under Eastern skies.

Merry Christmas found me in the city of Riverside—a stranger among strangers. Not a person in the city, and in fact amongst the active thousands of all Southern California, that I had ever met before; and if there is any time that will try one's remembrance of the old friends that annually gathered around the hearth of the old homestead with good cheer at Christmas time, it is this utter separation and isolation, thousands of miles away. New homes have been planted here, and we see the families gathering for their happy festivities. Would you call it a weakness if a tear comes to the eye in remembrance of the faces I shall see never more? And a moment of sadness steals into the heart as I take my seat and eat my Christmas dinner at the table of a restaurant with a jostling crowd of individuals like myself—homeless.

But such are the changes of life.

The fame of Riverside as an orange-growing city had long been known to me, and now the noble fruit was ripening; the train sped through miles of orchards, orange trees upon every side; up the long rows at the right and the left, perfect balls of golden fruit resting against a back-ground of dark-green foliage; then there are breaks in the rows, and a green lawn appears, as a symmetrical evergreen hedge, a quaint residence, often hid beneath trailing vines, upon which are fragrant blossoms on this Christmas day. Another break, and we look up a long avenue of pepper-trees, their branches trailing to the ground like those of weeping-willow. Another avenue, and the palm and the century-plant greet us. Still another, and the magnolia, the cork-elm and the gum-tree serve as ornaments and shade.

It is said that first impressions are often lasting, and so this first impression of Riverside was that of beauty, and though I have since seen many cities in California perhaps equally beautiful, this first impression of most beauty in Riverside clings to me still. It was no less an interesting experience when a few weeks later the orange-tree was in bloom and the air laden with its perfume, the busy hum of the honey-bee could be heard upon every hand, in that loud, busy hum that denotes the gathering of honey, giving one the idea that the orange-orchards alone would sustain many apiaries within the bounds of Riverside.

(To be continued.)



Working Two Queens in One Hive.

BY J. A. GOLDEN.

From the South comes a letter requesting me to give my plan of working two queens in one hive, for the production of section honey. In order to do so I will give the method that proved the most satisfactory of any experiments tested, and what I learned about the width of brood-frames and the spacing of the same, which produced two very desirable features to the producing of section honey, namely, a capacious

brood-nest, and bees quickly to enter the surplus department.

As my hive-body measures 14 inches in width inside, I divide that space by fitting in a $\frac{3}{8}$ -inch division-board, having previously cut out a circular hole 6 inches in diameter, covered with wire-cloth, which permits the air to pass from one colony to the other, causing the same scent, and no fight will ever occur with each other. The bee-entrances should be at opposite ends. Place six $\frac{3}{8}$ -inch top-bar frames $1\frac{1}{2}$ inches from center to center, previously filled with full sheets of comb foundation; after which two swarms of bees are allowed to enter upon nearly 1,750 square inches of comb foundation, or 875 square inches to each colony, which cannot be drawn but a trifle beyond the brood capacity, consequently the surplus sections must be promptly put on in two or three days after the bees commence work; for every bee-keeper has observed how quickly a swarm of bees will draw out a set of combs, even when allowed to the standard width.

I learned from my experiment that if the bees were not promptly supplied with sections filled with comb foundation, they would crowd the queen to the smallest laying capacity, take the swarming fever and sulk; and then the two-queen project will prove a failure so far as surplus honey is concerned, for when bees once get it into their little heads to swarm, they will either *swarm*, or *sulk and die*.

I also discovered that narrow frames and narrow spacing caused the entire full capacity of the brood-comb cells to be so near the proper length of brood-cells that the queens seemed to double their egg-laying capacity, until the 12 frames contained full sheets of brood, and so long as plenty of room was provided above, the bees gave no fears about swarming; but a large per cent. was gained in honey, over the one-queen colonies.

I have thus given, in as few words as possible, my two-queen system.

On examining my two-queen colonies to-day (Jan. 7), when the mercury registers 2° below zero, I find them clustered together as one cluster, except the wire-cloth that keeps them separated; and as my combined hive-cover admits sufficient ventilation, the combs are dry, and the bees in the best possible condition. If all goes well, I expect great things the coming season of 1896, from my two-queen colonies.

Reinersville, Ohio.



Hive-Contraction and Management.

After reading Mr. Doolittle's article on contraction of hives, in the Bee Journal of Dec. 25, 1895, Mr. I. N. Hoagland, of Brooklyn, N. Y., wanted to ask him a few questions, which follow with Mr. Doolittle's answers to them:

QUES.—1. When you contract the brood-nest to 4 or 5 frames, and those frames are pretty well filled with eggs, brood and honey, will not the colony go to work and prepare, and soon swarm?

ANS.—The contraction spoken of, is used only with newly-hived swarms, or colonies having a poor queen, as all good queens will keep from seven to nine frames filled with brood previous to and during the forepart of the honey harvest. In case of a new swarm the queen will keep the comb filled with eggs as fast as built by the bees, so there will be little or no honey in the combs in the brood-nest, providing ample room is given for work in the sections; in which case the bees will have no desire to swarm till after the young brood begins to hatch, or 24 days from time of hiving. The honey harvest is then nearly or quite past, and at that time the hive is to be filled out with drawn combs or full sheets of comb foundation. With a poor queen, swarms are not very likely to issue, in any event.

QUES.—2. If you give them those 4 or 5 frames filled with empty comb or merely starters, will they not fill them with brood and honey, instead of filling the section-case with honey? And would not the colony be the better and stronger if they could retain the brood that you remove in contracting?

ANS.—If you put bait sections in the surplus apartment, and contract the hive at the time of hiving new swarms, no trouble will be experienced along the line of honey in the brood-combs, whether empty combs are given, or starters. However, I prefer to use only starters in the brood-frames when working on the contracting plan, as I secure beautiful, all-worker combs in this way, with scarcely a cent of cost to me of honey or otherwise, as far as I can see.

QUES.—3. At the time of contraction do you place a queen-excluder between the brood-nest and section-case?

ANS.—When any hive is contracted to less than the full egg-laying capacity of the queen, it is well to use a queen-excluder between the brood-nest and the sections, otherwise the queen may enter the sections, and brood in the sections will be the result. Such result is neither profitable nor pleasant.

QUES.—4. If at the commencement or during the honey-flow a colony should swarm, and you removed the old hive, and gave a new one to the new swarm on the old stand, would you then contract to 4 or 5 frames? And would you give the frames of empty comb, or merely the frames with starters? Or would you give them frames partly well-filled with brood, eggs, and honey?

ANS.—I would give the swarm in the new hive only 4 or 5 frames, and those having starters only. I consider it a fallacy to give any prime swarm brood in any stage of advancement. Nature never provides any to the newly-hived swarm, and it is well to follow Nature in this case, instead of theory. So says an experience of 27 years in bee-keeping as a specialist; although I have practiced the giving of brood to swarms very largely during that time.

QUES.—5. Would you proceed the same way with a very strong colony which you expect soon to swarm, and most of which you have removed with the queen to a new hive on the old stand?

ANS.—Artificially-made swarms are treated the same as natural, but the advantages of the contraction system are not as apparent with such as with the natural swarms.

QUES.—6. If you have frames that are mostly filled with capped honey, would they not be as good as dummies to use in contracting?

ANS.—Combs of capped honey may be used in hiving swarms, but they will not answer the purpose of dummies, for as soon as the queen reaches them the bees will be likely to uncap the honey, and remove it to the sections, and thus as much of the combs be filled with brood as her prolificness requires. If the honey in these capped combs is not of the same consistency and color as is that coming in from the fields, you will be likely to get a mixed product in your sections which will injure the sale of it and cause dissatisfied customers.
G. M. DOOLITTLE.

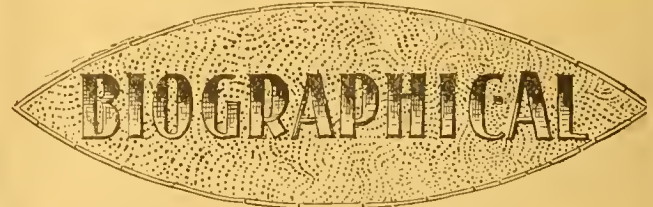

MR. J. K. DARLING.

The subject of this sketch was born within 15 miles of the city of Kingston, Ont., in 1843. The country was then new, and he can well remember hearing the wolves howl around the house during the night. He did not have the advantages of securing an education that the boys of the present day are surrounded with; however, by making a good use of the means within his reach, he acquired what might be termed a good, common school education. He was brought up on a farm, and a bush-farm at that. Being the oldest of a family of nine, it fell to his lot to do a large share of the "chores," and as part of his father's stock consisted of a few colonies of bees in box-hives, he had some acquaintance with them when quite young. He was frequently told to "watch the bees," and one of the first things he remembers was placing some pieces of boards over a swarm that had settled on a hill of corn. His father and mother were away from home, and a shower coming on, he was afraid the wet would drive them away.

Mr. Darling always liked the bees, and as he grew older he thought he could manage them as well as the most of the people whom he knew. He never read any bee-literature, because he did not have it, and did not know it was obtainable. When he was 20 years of age he could break and cut the old black combs from a box-hive, or perchance a salt-barrel, in April—"to give room for the summer's work, you know," just

as deftly as almost any other person, and he was just as clever in placing over the "brimstone pit" in the fall any colonies that were thought to be too light to winter. Those were the days of "strained honey."

After leaving home Mr. D. did not have much to do with bees for 12 or 15 years, but he had not lost his old love—it was just lying dormant. He went to Almonte, Ont., in 1870, and built the house he now lives in. He often thought of bees, but living in a village he thought put an end to his aspirations in that direction, especially as he was engaged in one of the woolen mills, which took his time from 6:30 a.m. to 6 p.m. However, somewhere about the year 1880, the old love blazed up more fiercely than ever before, and he "got the fever," and had it bad. He thinks Wm. F. Clarke was mostly too blame for this, for he was then writing for the Montreal Weekly Witness.

In the spring of 1882 Mr. Darling paid \$5.00 for a strong colony in a box-hive. It swarmed twice, and the old colony became queenless. He sent for a few hives, an extractor, smoker, etc., and an Italian queen for the queenless colony. The man he purchased the colony from had some that were too light to winter, and said if Mr. D. would leave him the honey and hives, he could have the bees and combs. He extracted the honey, and putting three light colonies together, gave him a fairly good colony, but not an ounce of honey, and none to gather, as the frost had killed everything. He fed granulated sugar syrup, and had it sealed over most beautifully, and put the four colonies into the cellar for the winter. In the spring the second swarm "played out," as well as the old colony with the Italian queen. The prime swarm and the fed colony came out all right, and he never saw drier, cleaner combs in the spring than those in the colony that was wintered on pure sugar syrup.

That spring he bought 12 more box-hive colonies from the same man, and although it was the 21st of May, three of them dwindled out before the honey season, leaving him with 11 colonies at the commencement of the honey-flow. He increased them to 26, and sold \$100 worth of honey, which settled his determination as to keeping bees. He bought seven more box-hive colonies, and wintered the 33 without losing one.

The next season (1884) he increased to 51, and bought 8 more, making 59 which he wintered without loss. In 1885 he put away 110, which he brought through the winter, but one or two "kicked the bucket" shortly after being put out in the spring. Since that time he has lost more or less every winter, sometimes so many as to make him feel very sad.

Mr. Darling is not in the best locality for honey, and his average has been from 72 pounds per colony, spring count, in a good season, to one or two pounds per colony in a very poor season. His success in wintering has been better when there had been a better crop of honey, and poor when the honey crop was light; especially if what little he did get was gathered early in the season.

He sent a little more than half a ton of honey to the Indian and Colonial Exhibition held at Kensington, England, in 1886, which would compare favorably with the honey from the other parts of the Province. He was appointed one of the Directors of the Ontario Bee-Keepers' Association in 1888, which position he has held ever since, and last year he was elected Vice-President of that association.

As a politician Mr. Darling is not known. Of very strong and decided convictions personally, he prizes highly, and exercises with determination, his right of franchise, but his voice has never been heard at a political gathering, unless it might be in the cause of temperance. He was converted at the age of 12 years, and joined the Methodist Episcopal church, of which his parents were members. He has been an official member of the Methodist church for nearly 30 years, and has been an active worker in the Sunday school for nearly 25 years.

Mr. D. is now carrying on a garden of vegetables and small fruits, and doing the best he can with his bees, having left the woolen mill 10 years ago. He put away 140 colonies of bees last fall in fine condition, and hopes for good things another year. So do we all.

THE EDITORS.

Honey as Food and Medicine.—A new and revised edition of this 32-page pamphlet is now issued. It has 5 blank pages on which to write or paste recipes taken from other sources. It is just what its name indicates, and should be liberally distributed among the people everywhere to create a demand for honey. It contains a number of recipes on the use of honey as food and as medicine, besides much other interesting and valuable information. Prices, postpaid, are: Single copy, 5 cts.; 10 copies 35 cts.; 50 for \$1.25; 100 for \$2.00. Better give them a trial. Send all orders to the Bee Journal office.

CONVENTION PROCEEDINGS

Report of the Illinois State Bee-Keepers' Convention Held at Chicago, Jan. 9 and 10, 1896.

REPORTED BY ERNEST R. ROOT.

The convention was called to order at 10 a.m., Jan. 9, by the President, Dr. C. C. Miller, and E. R. Root opened the meeting with prayer. The Secretary, Jas. A. Stone, being absent, Mr. Root was chosen Secretary *pro tem*. The President explained that there was no pre-arranged program, and that he would have to call upon the members to hand in questions. The first question for discussion was:

PLANTING FOR HONEY AND FORAGE.

"What, in your opinion, will prove the most profitable to plant for honey and forage? or what should we encourage as a honey-plant?"

Pres. Miller—I would not encourage planting for honey alone. As there are only a few here this morning, comparatively, I think we can get at the matter by calling for votes. First, let us have a list of the plants.

The various plants named were alfalfa, sweet clover, Alsike, crimson clover and buckwheat.

President—What is your first choice?

The responses showed that Alsike had the preference. When the second choice was called for, sweet clover was awarded the palm. On the third choice there was a division between crimson clover and buckwheat.

President—Alfalfa is a new plant, comparatively, and it is only lately that it has come into prominence.

Mr. Finch—I voted for alfalfa because Mr. Stone praised it very highly at our last convention.

Mr. Baldrige—I did not vote for it, because I never see any bees on it at St. Charles. It is not much of a honey-plant with us.

President—There was only one patch of it in my vicinity, but I found no bees on it.

Mr. Schrier—I sowed three acres of it four years ago. I was very anxious to see the bees work on it, but saw none.

Question—What do you know about Alsike?

Mr. Schrier—I sowed about 20 acres with Alsike. Some of my colonies stored as high as 100 pounds of comb honey, and the average from the whole yard was from 80 to 90 pounds per colony. It is a successful forage crop with me every season; and while the clover is not as large as the red, it makes No. 1 hay, and sells for more than the red. I should rather have it with timothy than alone. Without the timothy it sprawls on the ground, and does not grow as well.

Mr. Baldrige—Peck Brothers, of Geneva, are large sheep-growers. They sow all their land (about 200 acres) with Alsike and timothy, and have no bees.

President—That is the point. We want to emphasize, as bee-keepers, the forage side of our valuable honey-plants, because this appeals to the farmers.

Mr. Holmes—My experience is the same as Mr. Schrier's.

At this point a recess was taken. The following paid their dues then and at various times during the meeting:

A. H. Kennan, LaGrange.	C. A. Stewart, St. Charles.
M. H. Mandelbaum, Chicago.	C. Schrier, Peotone.
Geo. Thompson, Geneva.	Wm. Blume, Norwood Park.
J. C. Wheeler, Plano.	E. R. Root, Medina, Ohio.
M. M. Baldrige, St. Charles.	J. Roorda, Thayer, Ind.
A. N. Draper, Upper Alton.	W. C. Lyman, Downer's Grove.
H. O. Miller, Manteno.	W. A. Norris, Anrora.
J. A. Green, Ottawa.	Geo. S. Affolter, Maywood.
Ephraim West, Channahon.	N. L. Stow, Evanston.
E. F. Schafer, Chesterton, Ind.	

There were a number of other bee-keepers present whose names were not recorded, some of whom had paid their dues at the Springfield meeting in November, 1895. After the recess, the subject of honey-plants was continued.

President—We will next turn our attention to sweet

clover. Now is your time to speak of it as a honey-plant, after which I desire to emphasize its value as a forage-plant.

Mr. Finch—The honey from it does not seem to be of first quality. People do not like it. I had some at the State convention at Springfield, and no one seemed really to like its flavor.

Mr. Baldrige—Was the honey light in color?

Mr. Finch—It was a light amber.

Mr. Baldrige—That could not have been from sweet clover.

President—Likes differ. We must go by the general taste. I have generally considered it to be very good in flavor.

Mr. York—I have samples that were produced a few miles from this room, that were very fine. The honey is light in color, but it has a sort of greenish tinge.

E. R. Root—Samples have been sent us at various times; and while we do not consider it quite equal to white clover, we call it a fine honey. It is light in color, though perhaps not quite so light as first quality of white clover. The honey that has been sent to us has come from a good many different localities, but all the samples seem to be very much alike.

Mr. Schrier—The honey is a little strong, and slightly yellowish, but good.

Mr. Baldrige—It is barely possible that your bees may have been working on other plants. That would account for the strong flavor and the dark color that you speak of. In my locality, nothing else is in bloom at the same time as sweet clover. The honey is both white and of fine flavor.

President—Let us now turn our attention to sweet clover as a forage-plant.

Mr. Baldrige—I have something on that subject, and I should like to read it. Sweet clover is grown for hay, for pasturage, and for enriching the soil. One farmer has 100 acres old enough to bloom the present year. In November, 1895, one of my sweet-clover correspondents in the State of Mississippi, a wide-awake and progressive farmer, wrote me substantially as follows:

SWEET CLOVER IN MISSISSIPPI.

"My farm contains 1,300 acres of land, and is all under fence; 300 acres are in pasture, 150 acres being seeded to common red clover, and 100 acres to sweet clover, the latter being of this season's growth. I think my sweet clover is almost a perfect stand. It will be old enough to bloom in 1896. I have at this time 150 tons of sweet clover hay, all under cover, and of this season's growth. My stock, both horses and cattle, seem to be very fond of the sweet clover hay, for they eat it as readily as that from the red variety. I do not grow the Alsike clover. I have never seen Alsike tried but once in my locality, and that was a complete failure, but I think I must give it another trial.

"I have kept, this season, 55 head of stock on 50 acres of sweet clover as pasturage, and besides I have cut and saved from it 50 tons of hay. My stock had all the pasture from the sweet clover they could eat, and they are now very sleek and fat. The plant makes such a rapid growth that the stock and mowing-machine could not keep it back. Of course, if I were to go into the field and cut the sweet clover all down at once, I might then use it up, but I simply cut small plats at a time, so as to let the stock graze all the time.

"I always cut sweet clover for hay, the second year, before it blooms, and when it is from 20 to 2½ inches high. I do not think it would make as good hay after it blooms, as I fear it would then be too hard and woody. After it blooms I make no special use of the crop except to save it for seed.

"Sweet clover starts to grow very early in the spring—much earlier than red clover—and makes a very rapid growth. In fact, it is one of the earliest and most rapid-growing plants that I am acquainted with.

"I keep about 100 head of pure-bred Poland-China hogs, and I find that sweet clover is a good plant in early spring for hogs to graze upon; and that it is ready for them to use before anything else as pasture.

"I have also a large herd of thoroughbred Jersey cattle of both sexes; I graze them also on sweet clover. When given access to it in early spring, they soon become fond of the plant, and will then keep fat upon it.

"My horses do not seem to like sweet clover the second year until after it begins to bloom; they then eat the plant with great relish. But the first year's growth of sweet clover is the finest grazing-plant to fatten stock of any kind, that I ever saw, and especially late in the fall, when all other plants are gone. The plant is so hardy that it takes several severe freezes to kill it down.

"I sow from 8 to 10 pounds of seed, with the hulls on, to the acre. I prefer to sow the seed alone, or without a nurse-crop, and to sow it early in the spring or the latter part of

winter. If the land is free from grass and weeds, it makes no difference with me about its being plowed or the seed harrowed in; still, in many cases, it may be better or safer to harrow and cover the seed lightly. It may be sown on oat or wheat stubble, if so desired, and with good results. If I first plow the land I then harrow so as to make it as smooth as possible before I sow the seed. Early seeding is very desirable so as to catch the spring rains. This insures the early germination of the seed, and, of course, a rapid early growth of the plants. After the roots once secure a foothold, sweet clover will then withstand almost any summer's drouth.

"There is perhaps no plant grown that will enrich badly worn soils more rapidly than sweet clover. The roots are large, and they go down to a great depth. The roots die and rot, as a rule, as soon as a crop of seed matures, and then the soil becomes filled with a large amount of decayed vegetable matter. If the land be then plowed, and seeded to grain, or planted to corn, an increased yield will surely be the result. The cultivation of corn will destroy any plants that may spring up from the seed of the sweet clover left on the ground. When young, the sweet clover plants are thus very easily destroyed. But by sowing oats, barley, wheat or rye, the sweet clover plants will not, of course, be disturbed, and after the crop is removed the land will usually be found nicely re-seeded, which, with me, is very desirable. But if the sweet clover be no longer desired, the land may be plowed up and seeded again to a grain crop.

"The growing of a crop of sweet clover until a crop of seed matures seems to have about the same effect upon the soil as tile-drainage. The roots, being long, and of large size, when they die and rot, leave a multitude of holes in the soil, and these act as drains for the surplus water."

Mr. Baldrige—We have a farmer near the Peck Brothers, who makes a business of cutting sweet clover and feeding it to his hogs. The road commissioner of that vicinity wanted him to destroy it; but instead of doing this he made a contract to pasture the highways. He hired a boy, and put on 35 cows, and cleaned up four miles of road. The cows ate the sweet clover, and the milk was of finest quality. The venture was a paying one all around. The milk paid well, and he was also paid under contract to pasture down the "noxious! weed." But he has not been able to renew his contract since.

Mr. Wheeler—I sowed sweet clover along where wild grass grew. About half of it came up. A neighbor wanted me to cut it down, as he thought it was a noxious weed. The horses refused to touch the wild hay or grass, but would eat the sweet clover. The clover I used for feed, and the grass, cut at the same time, was used for bedding. The horses formerly ate the wild grass.

Some discussion here followed, showing that sweet clover sometimes fails to grow in nice, mellow fields; but it seems to thrive well on waste lands, roadsides, and railway embankments. The question was asked why it did not grow in the fields, and yet would seem to thrive along the roadsides. The suggestion was made that the tramping-in of the horses and wagons along the roadsides caused the seed to be thoroughly covered.

Mr. Thompson—In my greenhouse I sowed some sweet clover in a box. It did not grow at all. The next spring I threw it out; and later on I saw a great bunch of sweet clover growing where I had thrown out the box of earth containing the sweet-clover seed. I came to the conclusion that the seed and the soil would have to be frozen before it will take root and grow.

Mr. Schrier—Sweet clover will not stand low ground.

[Continued next week.]

Back Numbers.—We have on hand a few back numbers of the Bee Journal for 1895, which we will mail to any one wishing them at 15 copies for 20 cents. They will all be different dates, but we have no complete sets for the year. Just send us 20 cents in stamps or silver, and we'll send you 15 copies. No doubt there are many new subscribers who will be glad to take advantage of this offer. All new subscriptions now begin with Jan. 1, 1896.

The Alsike Clover Leaflet consists of 2 pages, with illustrations, showing the value of Alsike clover, and telling how to grow it. This Leaflet is just the thing to hand to every farmer in your neighborhood. Send to the Bee Journal office for a quantity of them, and see that they are distributed where they will do the most good. Prices, postpaid, are as follows: 50 for 25 cents; 100 for 40 cents; or 200 for 70 cents.



Uniting to Spot a Good Queen.

It has long been a "notion" in my mind that fall uniting furnishes about the only way we have to discover which of several queens is *really* the best—best queen sure to be the first one to get infuriated; and her antagonists are stung and dead before they get their fighting trousers on. I like to unite a half dozen or more colonies into one great one with just this object in view, to discover an extra nice queen.—E. E. HASTY, in Review.

Clipping Queens' Wings.

Some folks are still harping on the foolish theory that clipping the wings of queens will finally cause them to become permanently impaired, or even cause the disappearance of those members entirely. If every keeper in the land practiced clipping on all queens, there might be some logic in this kind of "argufyen" (as the negro said), and about the year 2599 our posterity might notice some of the bad effects, but even this is doubtful. I presume people have practiced cutting the finger-nails for many centuries past, but the most of us have finger-nails yet, unless we have been unfortunate enough to have dropped some heavy weight on one or more of them, and thus been temporarily deprived of them. So long as all queens sent out by breeders have wings, it is hardly necessary to send up a cry against clipping. I suppose these fellows get this idea from what scientists and naturalists tell us about the penguins and other fowls, and insects, losing the use of their wings because they get too fat and lazy to use them. Never mind! Whenever our queens commence coming out of the cells with cropped wings, we will quit cropping, for a year or two at least.—S. E. MILLER, in Progressive.

Wintering Bees—Weak Colonies.

Since we gave large entrances at the sides of the combs by raising one side of the hive, and putting under a half-inch block (our hives are not nailed, but clamped at the corners), we have lost no colonies if they were in proper condition when put into the cellar with queens and sufficient honey. From three or four, when being piled up in the cellar, the block came out, letting the sides down, which gave them only their front entrances at the ends of the combs. They all came through in bad condition, and most of them kept dwindling down, and died before white clover came, showing that close confinement makes bees unhealthy. We generally leave the honey-board on top of the frames, and lay on the second honey-board; the slats between make a dead-air space. They were put in the cellar about the middle of November. We like that time better than to wait longer, unless warm weather continues. In that case we watch the weather, and put in with the coming of cold wave.

We don't try to winter weak colonies, but unite; but on the weakest ones, in point of numbers, of the good colonies, so far as we can judge, we tie a red string, and set them in the center of the cellar, and leave them in the latest in the spring, not leaving any later than the 1st to 10th of April. Several springs, our cellar being so full, we would take some out the middle of March, and once the first of March, so we could keep the rest cool enough until about the 1st of April. Then we took out the greater part, but left some few in until the last of April. The last ones taken out gave but very little surplus honey, not having built up into strong colonies soon enough. Those taken out the first and middle of March were better than those left in until the last of April.—MRS. L. C. AXTELL, of Illinois, in Gleanings.

Doolittle's Beginning.

When I first commenced bee-keeping I was greatly benefited by the writings of E. Gallup, M. Quinby, L. L. Langstroth, Adam Grimm, and many others, for by their writings I learned my A B C in bee-culture. My first year of bee-keeping resulted in 12 pounds of surplus box or comb honey and one swarm, from the two I bought to commence with in the spring. The next season I obtained about 25 pounds surplus

from each hive I had in the spring, on an average. The next season I conceived the idea that more honey might be obtained by making my hives smaller, as regards the brood-chamber, than were those then in use, so that year I placed dummies in a part of my hives, to take the place of three frames, or one-fourth of the room, as the hive I had been using held 11 Gallup frames. The hives thus contracted gave me a much larger yield of surplus honey than did the others left as I had formerly used them, so in the spring of the fourth season the larger part of my hives had dummies in them, and when the end of the season came I chronicled an average of 80 pounds of box honey, as the average surplus for each colony I had in the spring. During these four years I had studied, read and practiced all my wakeful hours, about the bees, for I never spent an hour in my life in work pertaining to bee-culture without its being a real pleasure to me. Many a night have I laid awake from one to three hours, planning how to accomplish some result I desired to achieve in regard to the practical part of apiculture. Although I had scarcely the advantage of a common school education, and was not versed in either grammar or writing for publication, I felt that I ought to write for the bee-papers, thereby adding the little I might discover from time to time, to the general fund of knowledge, thus helping others what I could, to pay in a small measure the debt of gratitude I owed for the instruction I had gained from the writing of others. So I began to write, and as the editor kindly fixed up my articles so that they were presentable I was encouraged to keep on, and to-day finds me still scribbling away, trying to tell what I know concerning practical bee-keeping.—G. M. DOOLITTLE, in Progressive Bee-Keeper.

Young Queens Breed Late.

We know that a great many bee-keepers practice requeening late in the summer after the honey-flow ceases. The question may well be asked: Is this a good practice in all localities? It is known that queens answering the above description continue to lay for a greater length of time after the honey-flow ceases and are generally more readily stimulated to brood-rearing. In some localities there is a scant fall pasture for bees sufficient to keep them breeding, and this is liable to be so late that young bees do not get a cleansing flight before they go into winter quarters. When you add to this a young queen the danger is very much intensified. A large number of our best bee-keepers are ready to admit that if the honey-flow stops after the linden flow, and there is no more brood-rearing, the bees retain in that quiescent condition their vitality. There is, as it were, in nature an evening up. No honey-gathering, no breeding, no, or little, loss of vitality; honey-gathering, loss of vitality and breeding. Again a still larger number admit that young bees must have a cleansing flight before going into winter quarters. If they do not get this flight they are restless, become diseased and die and probably disturb the older and well-matured bees in the hive, setting up disease and death. We should very much like to have the opinions and experiences of our readers on the above subject.—Canadian Bee Journal.

Weight of Bees, and Bee-Loads.

The editor of the Review, while admitting that it may be interesting in a scientific way to know the exact weight of a bee and the amount of nectar it can carry at a load, fails to see any practical benefit to the honey-producer. If our printed matter were to be confined simply to the methods for converting the labor of our minds and hands into bread and butter, and honey to put on it, some of the best literature of our bee-journals would have to be eliminated. Man does not live by bread alone, neither should he try to. The practical bearing on some questions is not always at once apparent.

In the case of the bee's weight, or the the weight of honey it can carry, there is a practical side. The knowledge of the average bee-load of nectar gives us the key to the solution of the problem of the number of bees necessary to carry a pound of nectar, and the number of trips that have to be made to the fields. Indirectly we learn how many workers a colony should have in order to get the best results from a certain honey-flow. But perhaps Mr. Hutchinson would ask, "How about the weight of a bee?" In order to know the weight of a bee-load we must know the weight of the bee itself.

Then, too, there have in times past been all sorts of rude guesses as to how many bees there were in a 10-frame colony. Our knowledge is now much more exact; and hence, in discussing practical questions—those that involve bread-and-butter-getting—our comparisons and our statements of bee-forces will be more in keeping with facts, and hence lead to more exact results.—Gleanings.

OLDEST BEE PAPER IN AMERICA ESTABLISHED IN 1861

THE AMERICAN BEE JOURNAL

PUBLISHED WEEKLY BY
GEORGE W. YORK & COMPANY,

Editors and Proprietors,

56 Fifth Avenue, CHICAGO, ILL.

REGULAR CONTRIBUTORS:

G. M. Doolittle, of New York. Prof. A. J. Cook, of California.
Dr. C. C. Miller, of Illinois. Dr. J. P. H. Brown, of Georgia.
J. H. Martin, of California. Rev. E. T. Abbott, of Missouri.
Chas. Dadant & Son, of Illinois.

\$1.00 a Year—Sample Copy Sent Free.

[Entered at the Post-Office at Chicago as Second-Class Mail-Matter.]

Vol. XXXVI. CHICAGO, ILL., JAN. 30, 1896. No. 5.



An Open Winter is what we have had in this locality so far (Jan. 25). We prefer a steady, cold winter, as we believe such is more conducive to good health. We have noticed that oftener "la grippe" attacks the people in mild, open winters. Ever since Jan. 1, we have been suffering from an insidious invasion of his "grippy lordship," and about concluded that either we had the gripe, or else the gripe had us—perhaps it is both combined. At any rate, we are quite willing to "part company" with our common enemy—Mr. Hold-on Grippe.

The California "Rambler" (known also as John H. Martin) begins a series of articles in this issue of the Bee Journal. He's better known to the readers of Gleanings, but we think very soon our readers will feel pretty well acquainted with him. His Bee Journal articles will have less of the rambling feature, and more of the practical in them.

With Prof. Cook and Rambler to represent them, the Pacific Coast bee-keepers and their interests should be well taken care of in the American Bee Journal. Both of them understand well the apiarian requirements in that region of our great country, and will no doubt see to it that bee-keeping matters there are placed in a proper light before the world. Our California and other Pacific Coast readers, we are sure, will hail with delight the articles from the pens of these two helpful apiarian workers and writers.

The Chicago Convention Report is begun this week, on page 69. It was hard work to report it, as it was, with one exception, *all discussion*, the only semblance of an essay being the letter on sweet clover, by Mr. Baldrige. As will be noticed, Mr. E. R. Root served as secretary, and we are sure all will agree that he has done his work exceedingly well, especially as he is not a shorthand reporter. Surely, a vote of thanks is due Mr. Root for his faithful services.

We regretted to see that so few of those present became members; also, that more of the local bee-keepers did not "turn out." Most of those located near Chicago had a fairly good crop of honey last season, and we fully expected to see them at the meeting. When a bee-convention comes so near to our homes, it seems to us we should attend if at all possible. You know "the more the merrier" applies particularly to conventions of any kind. We hope that hereafter whenever there is a bee-meeting held near the home of any bee-keeper, he will be present, and not only get as many more to attend as he can, but also pay the annual dues and become a member.

South Water Street Information.—In a recent Chicago daily newspaper we found the following about the condition of honey and the market on South Water street, where are located about all the dealers in farm produce:

HONEY IN DEMAND.—"Good white clover honey is always in demand," said a South Water street commission-dealer yesterday. "The supply this year is well up to the average yield, which is never heavy. Prices are from 12½ to 13 cents a pound. Don't always think that honey is adulterated because of its color. Clover yields the only white honey. Buckwheat colors the honey until it is as dark as any adulteration dare be. One of the prettiest honeys is the amber, which is the result of the bees feeding on the basswood flowers."

Of course the great (?) honey-man was speaking about comb honey. It will be news to most bee-keepers that "Clover yields the only white honey!" And that amber honey "is the result of the bees feeding on the basswood flowers!" Wonderful is the beginner in the honey-commission business! The above is almost equal to the idea discovered in the cranium of one new honey-dealer the past fall, who thought that because a few cans of honey had become granulated, it must be adulterated! Oh, what a vacuum in that fellow's head! And yet, he wanted to be considered a big honey-dealer!

Beeswax Exhibit and Metheglin.—A Connecticut subscriber asks the following questions:

1. Will some one please tell, through the Bee Journal, how to put up beeswax in fancy shapes for exhibiting at fairs?
2. Can metheglin be made of honey-dew?

Any one who can answer the above is requested to do so. As Mrs E. Whitcomb, of Friend, Nebr., has been very successful in making beautiful beeswax things for exhibition purposes, perhaps she will kindly tell how she does it. And if we remember rightly, Mr. Whitcomb knows something about metheglin—maybe not about the *taste* of it!—but whether honey-dew would be suitable for that purpose. But why not make honey-vinegar instead of metheglin? There are too many intoxicating drinks already, we think.

The Apiarian Industry in the United States is a development of the last 40 years, although isolated individuals were engaged in this work long prior to that time. The importance of the industry at the present day is not generally realized, and the following figures will probably be surprising to many well-informed individuals:

Apiarian societies in the United States.....	110
Apiarian journals.....	9
Steam factories for the manufacture of bee-hives and apiarian implements.....	15
Honey produced in the United States in 1869 (according to United States Census Report).....	14,702,815 pounds..
Honey produced in the United States in 1889 (according to United States Census Report).....	63,894,186 pounds..
Persons engaged in the culture of bees (estimated).....	300,000
Honey and wax produced, at wholesale rates (Eleventh Census).....	\$7,000,000
Estimate of the present annual value of apiarian products.....	\$20,000,000

The above is taken from a circular recently sent out by the Department of Agriculture, at Washington, D. C. While some of the foregoing figures may be correct, it is pretty safe to say that others are hardly reliable. In fact, it is very difficult to get at the actual figures when it comes to a subject of this kind. For instance, look at these two paragraphs, which are based on Government Reports of the honey crop:

In 1869 five States produced over 1,000,000 pounds each, and seven States produced none. Illinois led with 1,547,178 pounds, and North Carolina followed with 1,404,040 pounds. South Dakota producing the least—110—of those that produced any at all; Nevada followed with the next least amount credited to one State, 363 pounds.

In 1879 two States, New York and Tennessee, produced each over 2,000,000, and ten other States produced each, over 1,000,000 pounds. Illinois produced 1,310,138, and North Carolina 1,591,590 pounds; South Dakota produced 6,180, and Nevada 24,296 pounds. New Mexico produced the least, 450 pounds, and only four states produced none.

Now, just compare the honey produced in Illinois with that of North Carolina, as given in the Reports. Who believes that the latter State in any year produces one-tenth as much honey as the former? And yet, in 1879 the figures show that North Carolina produced *more* honey than Illinois! and in 1869 almost as much. It

will also be seen that California isn't found at all among those worthy of special mention.

But here is another paragraph touching on the honey-yields for 1889:

In 1889 one State—Iowa—produced over 6,000,000 pounds. Three States—New York, Illinois and Missouri—produced each over 4,000,000 pounds. Three States—Texas, Wisconsin and California—produced each 3,000,000. Seven produced each, over 2,000,000, and six over 1,000,000 pounds each. Every state produced honey, the least being Montana, the next Wyoming, which produced 305 pounds. Idaho, which produced none in 1869 or 1879, records 37,146 pounds for 1889.

In the above, it shows that Iowa produced just twice as much honey as California in 1889! We're afraid the apiarian statistics of the past need revising. We hope the Government will take hold of the matter in real earnest, and see to it that proper apiarian reports are gathered in the same manner as those relating to other productions of the farms of our country. We think a few questions relating to bee-culture should be printed on all blanks used by assessors who annually make their visits among those who produce honey and many other crops.

Questions AND Answers

CONDUCTED BY

DR. C. C. MILLER, MARENGO, ILL.

[Questions may be mailed to the Bee Journal, or to Dr. Miller direct.]

Does Feeding Bees Sugar Affect their Gathering from Flowers?

There is an old German proverb which says: "Bienen die mit Zucker gefuettert werden hoeren bald auf Honig in den Blumen zu suchen." Translated it reads: Bees that are fed with sugar soon stop gathering honey from flowers. I would like to know how much truth there is in it? J. S.

ANSWER.—I don't believe there's anything in it. For some reason bees prefer the nectar of flowers to any solution of sugar, and if you feed them the latter when no flowers are to be found, they may take it greedily, but as soon as they find a chance to gather the genuine nectar, they will quickly neglect the sugar. I could never observe that bees worked with any less vigor on flowers after having been fed upon any substitute. In the same way I have seen bees working very industriously on some substitute for pollen, as ground corn and oats, but as soon as natural pollen was to be had the meal was deserted, and the bees worked with a will bringing in great loads of pollen.

Two-Story Eight-Frame Hives—Objects to Bee-Zinc.

On page 810 mention is made of ten colonies of bees in two-story 8-frame hives, and the following questions were asked about them:

1. When were the second stories given, or were they on all the season?
2. How strong were the colonies in the spring?
3. How were they in the fall?
4. What was the crop?
5. Can you tell us how they compared with one-story colonies?
6. Were they run for comb or extracted honey?

To these questions H. E. L. replies as follows:

ANSWERS.—1. The second stories were put on in spring to increase the laying-room of the queen, and they are there yet as a two-story hive for winter. This is the first season's trial with the two-story hive (I mean two-stories for the queen and her brood).

2. On an average, weak and short of stores.
3. Very strong and very heavy.
4. 50 pounds per colony, not forgetting that the season was very poor. A near neighbor did not average 25 pounds in

his apiary, beside leaving all colonies with less than half as much as my colonies have left to winter on.

5. The above explains this question, as he confined all his colonies (the queen rather) in the one lower story by means of a queen-excluder above it, and a second-story for extracted honey. The queen-excluder, to my notion, is to the queen what the chain is to the dog, besides being a stumbling-block for the poor loaded bees to stumble over, that is, squeeze through the close-fitting opening. Who can tell how much honey is lost by the use of those expensive excluders?

6. All were run for extracted honey, three and four stories, the strongest one having at one time five stories.

East St. Louis, Ill.

H. E. L.

ANSWER:—Like many another thing that is good, I suppose bee-zinc may be abused as well as used. Comparing your results with those of your neighbor, it looks very much as if it has been a damage to him, that is, supposing there was no material difference between your management and his except the matter of queen-excluders. Used with judgment, however, bee-zinc is certainly a grand invention. Just how much harm is done by forcing worker-bees to pass through the perforations I suppose it would be difficult to determine.

One can judge perhaps something about it by having bee-zinc at the entrance of a hive and watching the bees as they pass through it. At first it seems something new to them, and they don't pass in and out of the hive as readily as without it, but after a day or so it seems to make very little difference. Only by a good deal of observation and comparison could one tell very much about its use in the case of extracted honey. If you had used excluders over your second story it is possible there might have been some good in it in the way of keeping the queen out of the combs used in the extractor and also keeping pollen out of them. Still, it is possible that there may be some advantages in allowing the queen free range. Will you kindly tell us, if you can, about how many combs of brood were in the hive at the height of the season, and whether the brood was spread throughout the several stories or in which stories it was? Also tell us how many of them swarmed. Thanks for the information already given.

Does Artificial Pollen Ferment in the Cell?—Is it Paralysis?

1. Does common wheat flour or meal, used as a substitute for pollen in early spring, undergo fermentation when the bees fill up the cell, in which it has been stored, with new honey?

2. When bees are busily working on the second crop of red clover I notice that many of them are affected by what seems to be "paralysis." Is the trouble due to the nectar-secretions of the clover, or is the weather accountable, being at that time extremely warm and dry? W. W. M.

Wheelerburg, Ohio.

ANSWERS.—1. Probably no more than the natural pollen. Pollen or any of its substitutes may undergo fermentation under favorable circumstances, but not when properly taken care of by the bees. I've seen what was supposed to be good extracted honey froth and run over the jar that contained it, on account of the floating pollen in the honey.

2. I don't suppose the clover has anything to do with it. If bee-paralysis is what you mean, that's a disease that opinions are unsettled about at present, further than it is due to a bacillus, and there's no certainty that the weather is in any way accountable for it.

Swarming Out—A Stray Queen.

1. I have a colony of bees which are cross and bad to handle. They will pitch at you if you are not any where near the hive yourself. They were the first from a swarm of very quiet bees, and they have been very cross ever since they lived in this hive.

2. Last spring I had a colony in a 10-frame Langstroth hive with plenty of honey and nice, clean combs, but they swarmed out. I tried to stop them and make them cluster, but it was impossible—they would not cluster at all. I threw water into them, but no use. They flew for about one hour, and then went northwest to a neighbor's apiary and settled on a wash-tub half filled with water for watering bees. I of course followed them and got them back home again, and then into the same hive again. Then the queen began to lay all right, but in about a week they swarmed out again, leaving hive, honey and brood. They went right over to the same neighbor

again, and lit on an apple-tree; so I got permission from him to cut the limb from the tree and take my bees again. I got them down and hived them in a new hive with full sheets of foundation but the next day out they came and were gone entirely. I saw nothing of their leaving the hive at all. But what was strange to me was, when we were eating dinner we found a queen on the window trying to get out. Now, where did that queen ever come from in the house? Was it the queen of the colony that left? If it was, where were the bees gone? This happened on May 7, 1895. H. W. S. Baraboo, Wis.

ANSWERS.—1. From the date given, it might be impossible for any one to say just why the colony was cross. You say it was a first swarm from a gentle colony. In that case it had the same queen the old colony had, and for at least three weeks there would be no bees in it except those that came from the old colony. So the difference can hardly be accounted for by the change of bees themselves, as might be more or less the case with a second swarm.

If honey ceased to yield immediately after the swarm was hived, that might account for an immediate change of temper in the bees.

If the bees lost their queen by any accident, or even by design, that would change their gentle character also.

The place where the new swarm was put may possibly have had something to do with it, for some have reported that bees out in the hot sun were more vicious than those more comfortably located.

2. It is simply impossible for any one to say with certainty from whence came that queen. It is possible that it might have come from a colony at almost any distance within two or three miles, and from any point of the compass. The fact that one of your colonies came out of its hive makes it of course more probable that it was from such a colony than from a colony that remained quietly in its hive as a well-behaved colony ought to do; but after all, any answer given would only be a guess.

Improved Nomenclature—Bee-Zinc.

Some honey-boards are queen-excluding, others not; then suppose that those which are queen-excluders be called "bee-boards," and leave the old name to those which are honey-boards and not queen-excluding.

Zinc being the material which is in general use—I might say almost universal use—for excluding or including queens and drones, at other places than where honey-boards are used, and most honey-boards are made of zinc if they are queen-excluding, how would "bee-zinc" do for the "perforated zinc," as it is now called?

A FRIEND.

ANSWER.—It is something of a question whether "bee-board" could displace the well-established name "queen-excluder," but decidedly "bee-zinc" has strong claims as a supplanter of "perforated zinc." The name is shorter, more descriptive, and could not be misunderstood. "Perforated zinc" might equally as well apply, and very likely if applied, to many forms of zinc with perforations that would not be perforated zinc at all in bee-keeping parlance. But "bee-zinc" would easily recommend itself as meaning just the one thing. Let's call it bee-zinc. [We are willing to adopt this change, and for the reason given.—EDITOR.]



CONDUCTED BY

DR. J. P. H. BROWN, AUGUSTA, GA.

[Please send all questions relating to bee-keeping in the South direct to Dr. Brown, and he will answer in this department.—EDS.]

Balling Queens.

DR. BROWN:—On Oct. 1, as I was passing through my apiary, I discovered one hive with a pile of dead bees in front

of the hive, also a lump of live ones, so I searched the hive, and the bees were just wild. Then I took a stick and wanted to find out about the bees in front of the hive, and found a queen in the middle of a tight lump of bees, and as soon as I took the queen some of the bees were fighting and trying to sting the queen, so I caged her, and yet the bees were not satisfied. I found another lump just like the first, which I examined, and, to my surprise, I found another queen. Well, I caged her, and not long after that the bees went straight to work again. What was the matter with that colony? Could I not have kept those two queens until spring, if I had fed them honey mixed with sugar? They seemed to eat by themselves. I had no bees with them, as the bees would fight her if I put any with her. I had them in separate cages. If I had shut the cages and put them into some hive, would the bees have fed them through the wire-cloth and taken care of them?

U. T.

Leon Springs, Tex.

ANSWER.—Judging from your description of the bees I infer that a swarm from some hive, or hives, tried to enter the other, and were killed, and the queen balled. Very often, with small, weak colonies, in the spring and fall, they swarm out and desert their hives, and frequently try to enter other hives. The fact of there being two balled queens would indicate two such swarms.

I have also had cases where the queen of the colony entered would be balled by the stronger bees, but in this case the bees would be demoralized for quite awhile. As the bees in your hive soon quieted down and went to work, this supposition would be very unlikely.

If you wanted to save the queens, you could have given them to some queenless colonies. The chances were all against you saving them in cages until spring.

Uniting Colonies—Feeding—The Danger of Extracting Too Closely.

1. Is there likely to be a gain by uniting several weak colonies in the fall? That is, will it make them swarm early, and put them beyond what they likely would have been?

2. I understand there is no use of packing bees for winter in the South; but as soon as they commence brood-rearing regularly in the spring, would it not be of some advantage to pack them so as to prevent the cool nights from chilling the brood, allowing them to remain so until the nights got fairly warm?

3. I have had my bees, from all appearance, within a week of swarming, when a cold, wet rain would set things back until they would not swarm at all. Now, what I wish to know is, would it be advisable to feed a little regularly just to keep up brood-rearing until the weather was right again?

4. The fall aster is our main honey-plant here. In extracting as fast as it is gathered, is there not danger of working the bees to death? This accords with what decides the life of a worker-bee. It seems that it would be at a critical time of the year; if so, what say you?

Newell, N. C.

ANSWERS.—1. There would be a gain by uniting them in this way; if you did not do it they would most likely be lost before the first of April. Small, weak colonies in the fall and spring frequently get, as it were, discouraged, and swarm out—desert their hive and what brood they have started. Feeding will not always hold them—it more often kindles their "git and quit" propensity. By uniting you save the bees, and may have a good, strong colony for spring work.

2. I don't think you would gain much by the packing. What you might gain in the night you would lose in the day. The bees in the packed hives would be several hours later in getting out in the day for forage than those in the unpacked ones. You would find that by the time the honey harvest was well under way, the unpacked bees would be most likely ahead. I speak from experience.

3. It would be advisable.

4. Yes, there is danger. The extracting should be done with judgment—always be on the safe side—don't extract too closely—leave enough for the bees to winter on, and to carry them until the first of April. From the first of February until the first of April is a trying time with bees in our climate—stores are rapidly consumed. Look out for starving colonies.

Every Present Subscriber of the Bee Journal should be an agent for it, and get all others possible to subscribe for it.

THIRTY THOUSAND POUNDS BEESWAX

Is our present stock for this year's sales of Foundation. But still **We Want More Beeswax** and pay a good price.

Don't Delay Ordering Your **FOUNDATION**. You will pay more by and by than you would now. Remember that we make the **BEST**, and everybody acknowledges this.

Now is the time to read the work of the **Late Father Langstroth**—

Langstroth on the Honey-Bee, Revised.

The Price of this Work is now Reduced from \$1.40 to \$1.25, by mail.

Send us your address for Catalogue of Bee-Supplies, etc.

CHAS. DADANT & SON,

HAMILTON, Hancock Co., ILL.

Mention the American Bee Journal.



There Is No Doubt About the **MERIT OF** **THE KEYSTONE DEHORNING KNIFE**. It cuts both ways, does not crush. One clip and the horns are off close. Write for circular. **A. C. BROSIUS, Cochranville, Pa.**

36E13t

Please mention the American Bee Journal.

CHEAP SECTIONS! CHEAP SECTIONS!

We have at this Branch among the Stock purchased of Thos. G Newman the following stock of Sections—not of our manufacture—which we desire to close out to make room for our

Superior Extra Polished Sections.

In order to close them out quickly we offer them for the next 60 days, or while they last, at these special prices:

White Sections, 4 1/4 x 4 1/4.

Cream Sections, 4 1/4 x 4 1/4.

40,000 1 15-161,000 for \$1.75
50,000 1 1/22,000 for 3.00
80,000 7-to-ft.5,000 for 7.00

10,000 1 15-161,000 for \$1.25
20,000 1 1/22,000 for 2.00
1,000 7-to-ft.5,000 for 4.50

With all orders for less than 5,000, add 25 cts. for cartage.

These Sections are of Wisconsin manufacture, and when made were doubtless considered as good as the best; but as compared with our Extra Polished Sections they are not up to the standard of to-day, but a decided bargain and should be closed out quickly at these very low prices. If you prefer a sample before ordering we will mail one for 5 cts. to cover postage.

The A. I. Root Co., 56 5th Ave., Chicago, Ill.

Honey-Clovers & Buckwheat SEED FOR SALE.

We have made arrangements so that we can furnish seed of several of the Clovers and Japanese Buckwheat, by freight or express, at the following prices, cash with order:

	10lb	50lb	100lb
Alsike Clover Seed.....	\$1.35	\$ 6.25	\$12.00
White Clover Seed.....	2.40	11.35	22 00
Alfalfa Clover Seed.....	1.20	5.25	10.00
Crimson Clover Seed.....	1.00	4.00	7.00
Jap. Buckwheat Seed.....	.45	1.50	2.20

* Prices subject to market changes.

The above prices include a good, new two-bushel bag with each order. We expect to be able to offer Sweet Clover Seed by next week. We guarantee all Seed first-class in every respect—in fact, THE BEST that can be gotten. Your orders are solicited.

GEORGE W. YORK & CO.,
CHICAGO, ILLS.

STOP!!

My Friend, just one moment, will you? Do you need anything in my line? Any

BEEES ?
QUEENS ?
COMB FOUNDATION ?
SECTIONS ?
SMOKERS ?
HIVES ?

Well, I've got anything you want. Send for my Catalogue for 1896, and see if it is not a **Daisy**—and learn how to save Freight on your Goods—more than enough to pay for your favorite bee-paper, for years to come. Send now, or paste this in your hat, for it will not appear again.

E. T. FLANAGAN,
Box 783 BELLEVILLE, ILLS.
Mention the American Bee Journal.

MAKE & NOTE OF THIS! ALL READY FOR 1896. U



Appreciating the advantages for procuring Basswood Lumber, and the splendid Shipping facilities of Marshfield, we have established a Factory for the manufacture of

THE ONE-PIECE SECTION.

We have all new and up-to-date Machinery for the manufacture of the "One-Piece Section." Have a Saw-Mill in connection with our Factory, enabling us to get the finest material to hand, for "One-Piece Sections."

Write for Price-List, and also for prices on Sections in any quantity you may want.

THE MARSHFIELD MFG. CO.,
MARSHFIELD, Wood Co., WIS.

Dec. 18 1895.

49Dtf

Mention the American Bee Journal.

Question-Box.

In the multitude of counsellors there is safety.—Prov. 11-14.

Unqueening During the Harvest

Query 3.—Do you practice unqueening a colony during the honey harvest? If so, why?—TENN.

R. L. Taylor—No.

Jas. A. Stone—No.

H. D. Cutting—No.

G. M. Doolittle—No.

W. G. Larrabee—No.

Prof. A. J. Cook—No.

Mrs. L. Harrison—No.

Rev. E. T. Abbott—No.

W. R. Graham—I do not.

J. M. Hambaugh—No, no.

Mrs. J. N. Heater—I do not.

Eugene Secor—I never have.

Dr. J. P. H. Brown—No, sir.

Rev. M. Mahin—No, and I do not believe in it.

Dr. C. C. Miller—I gave it up some years ago.

B. Taylor—I have never made it pay to dequeen.

P. H. Elwood—Yes, when we do not wish to increase, we do it to prevent swarming.

C. H. Dibbern—No; I allow the bees to manage the requeening business, as I believe they know more about it than I do.

J. A. Green—Sometimes. In order to prevent or control swarming, and to keep colonies supplied with young queens.

Chas. Dadant & Son—No. It is too much trouble, and we do not consider it practical. There is lots more of this done on paper than in the apiary.

E. France—Some seasons we have caged queens during the honey harvest. I have not room here to explain the reasons why and when it should be done.

Allen Pringle—I practice no foolishness of that sort. It might possibly be wise for some bee-keepers in some localities to "unqueen," but it is otherwise with me and in my locality.

J. E. Pond—I unqueen a colony at any time, when I desire to make a change, without regard to the "honey harvest." I do not unqueen colonies, though, in the "honey harvest," with the intent to get more honey by so doing, as I think it doesn't pay to do so.

G. W. Demaree—No. I can bear the expense of rearing young bees during the honey-flow better than I can after the honey harvest is over, for there must be a succession of young bees if the colonies are to be in readiness to get their winter stores from fall bloom.

BASSWOOD TREES!

Orders booked now for Spring delivery for

Nursery-Grown Basswood Seedlings

5 to 9 inches high, at \$2 00 per 100; 300 for \$5 or \$15.00 for 1000. Parties living east of the Mississippi river will be supplied direct from our Nurseries in Ohio. Satisfaction guaranteed.

A. H. FITCH,
702 Youngerman Bldg., DES MOINES, IOWA.
4Atf Mention the American Bee Journal.

California

If you care to know of its Fruits, Flowers Climate or Resources, send for a Sample Copy of California's Favorite Paper—

The Pacific Rural Press

The leading Horticultural and Agricultural paper of the Pacific Coast. Published weekly, handsomely illustrated, \$2.00 per annum. Sample Copy Free.

PACIFIC RURAL PRESS,

220 Market St., - SAN FRANCISCO, CAL.
Mention the American Bee Journal.



OUR POULTRY ANNUAL
and Book of Valuable Recipes, 64 large pages, contains 8 beautiful colored plates of fowls, gives description and prices of 45 varieties, with important hints on care of poultry, and pages of recipes of great value to everyone. Finest Poultry Book published for 1896. Postpaid only 10 cts.
C. N. Bowers, Box 24, Dakota, Ill.

52A1 Mention the American Bee Journal.

COMB FOUNDATION WHOLESALE and RETAIL.

Are you going to buy Foundation for Cash, or have you Wax to sell or trade for Foundation and other Supplies? Have you 25 lbs. or more of Wax that you want made into Foundation? If so, do not fail to write me for samples and prices. I make a specialty of working up Wax by the lb., and do it very cheap during the winter. Beeswax wanted at all times.

GUS DITTMER, AUGUSTA, WIS.

Reference—Augusta Bank. 16Atf

Mention the American Bee Journal.

PERFECT FRUIT

IS PRODUCED BY SPRAYING.

Our 32-page Illustrated Spray-mailed Free. THE DEWING CO. Gen'l Western Ag'ts. Salem, Ohio. Henion & Hubbell, Chicago.

Mention the American Bee Journal.

—LEADS THEM ALL S to 24½¢—

See reports of experiments with Comb Foundation at the government station, Lapeer, Mich. FREE—large Illustrated Catalog of everything needed in the apary. Full of information. M. H. Hunt, Bell Branch, Mich.

5Dtff Please mention this Journal.

MUTH'S HONEY EXTRACTOR

PERFECTION
Cold-Blast Smokers,

Square Glass Honey Jars, Etc.

For Circulars, apply to CHAS. F. MUTH & SON, Cor. Freeman & Central Aves., Cincinnati, O. Send 10c for Practical Hints to Bee-Keepers.

HATCH Chickens BY STEAM— With the MODEL
EXCELSIOR Incubator

Simple, Perfect, Self-Regulating. Thousands in successful operation. Lowest priced first-class Hatcher made.
GEO. H. STAHL,
114 to 122 S. 6th St. Quincy, Ill.

Send 6c. for illus. Catalogue.

Mention the American Bee Journal. 3A8t

Potatoes

—10 New Varieties, \$1. Pack-
et BEET, CABBAGE, CUCUMBER
LETTUCE, TOMATO SEEDS, 10c
Catalogue Free. Address,

J. F. MICHAEL,
GREENVILLE, OHIO.

1D6t Mention the American Bee Journal.

READERS of this Journal who write to any of our advertisers, either in ordering, or asking about the Goods offered, will please state that they saw the Advertisement in this paper.

General Items.

Results of the Past Season.

I had, spring count, 45 colonies, took off about 700 pounds of honey, mostly extracted, and sold 120 queens. I sold 35 colonies of bees, and now have 85 in fair condition. Bees are flying briskly to-day, and have been bringing in pollen up to within ten days.

I find it difficult to get queen-cells to hatch during the hottest weather. I have no use for queens reared here in winter. Spring is the best time, and early fall will do.

We are having more rain now than we had at this season a year ago, and I am hoping we will have a better honey season than the last was; and I would not object if the quality was a little better, and a little better market for what we do get.

O. H. STEVENS.

Be Co., Texas, Dec. 20, 1895.

Two Fertile Queens in a Hive.

My report for the last four years is almost nothing. My bees run down from 72 colonies to 41, and averaged 200 pounds per year. No wonder I get discouraged and want to sell out and hunt a new location. I have kept bees since 1866.

I found two fertilized queens the past season. I went to the hive to put up a swarm for another person, and the second frame I took out had a young fertile queen on it. I set the frame in another hive, and went on with my work. When I got to the other side I found another fertile queen. I had found old queen-cells, and the old queen was gone, which was clipped. It is the only instance of the kind I ever heard of.

R. R. STOKESBERRY.

Clinton, Ind., Dec. 27, 1895.

The Bee-Pasturage in Montana.

My bees had a good flight Dec. 10, and are now in good condition for winter. There are lots of willow and wild berries growing near here for the bees to work on in the spring, and then come the aster and other wild flowers. I think most of the honey that I will produce next year will be from that source. I will improve my bee-pasture by sowing sweet clover.

FRANK X. ADELBERT.

Kalispell, Mont., Dec. 26, 1895.

Poor Season in 1895.

There is no honey to sell among the bee-keepers around here, and no young swarms in the summer of 1895, either. Half of the bees' winter food is from sugar. My bees used 10 pounds of honey per colony from May 15 to Aug. 1, then they got their feed in 10 days; then in two weeks gained a little. They had September brood, and I hope they will be all right for 1896. We had a young winter from May 10 to the 13th—too much for basswood. It was so hot and dry in the autumn of 1894 and summer of 1895 for clover.

O. E. CLARK.

Brillion, Wis., Dec. 26, 1895.

The Closed-End Frame in Winter.

On page 798, Mr. E. T. Abbott says he is unable to see where the closed-frame has any advantages in retaining the heat of the cluster in the spaces occupied. He says the cluster warms the spaces occupied and no more, let the frame be what it may. I use closed-end frames, and put foundation in them, and I find that the combs are built from end-bar to end-bar of the frame. I cover the top of the frames with a piece of strong cotton-cloth, which the bees seal air-tight. As the warm air of the cluster can neither escape at the top nor at the end of the combs, and being lighter than the air at the bottom of the frames, it is com-

pelled to remain in the upper part of the comb-spaces occupied by the bees. I have also some open-end frames in dovetail hives; in those I use foundation also, and the comb reaches also from end-bar to end-bar; they are Hoffman frames, and are closed-end about three inches; below they are open, and right there is where the warm air escapes and moves on into the parts of the hive not occupied by the cluster. I believe the Hoffman frame would be a great deal better if it was made closed-end at least half of the length of the end-bar, and kept wedged close so as to retain the heat of the cluster.

E. H. GABUS.

Brock, Nebr.

Retailing Honey in California.

I was in Los Angeles this week, and a lady told me that a man had been at her house peddling honey, and he asked 20 cents a pound for extracted honey in pound jelly-glasses. Besides, the glasses must be returned. Somebody must be making something on honey, if the bee-keepers are not.

ELLEN C. BLAND.

Fernando, Calif., Dec. 20, 1895.

A Healthy Old Bee-Man.

I had 9 colonies, spring count; I saved 14 good, strong swarms, and 3 after-swarms went away. They stored 275 pounds of surplus honey, and filled their hives so full that I could hardly lift them.

I am very much pleased with the American Bee Journal. I take great pleasure in working among my bees. I will soon be 73 years old. If all my pains and aches were put together, four weeks would cover them all.

S. C. COULSON.

Storm Lake, Iowa, Dec. 30, 1895.

May Revive the Clover.

I have my bees all in the cellar. The winter remains open and warm for this climate. On Dec. 24 and 25 we had two inches of rainfall, ending with a light fall of snow. It is the first rain to start the water in two years. This rain may revive the clover, but I fear that it is almost destroyed with the last year's drouth. So the outlook for next year is very slim indeed. All that the bees can build up on is the fruit-bloom, and this is not much of a country for apples or cherries, but a considerable quantity of small fruit.

D. C. WILSON.

Viola, Iowa, Dec. 27, 1895.

Very Dry Season.

Last year was a very hard one on bees in this part of the country. The winter killed almost all of my bees, and what I had left did not get enough to keep them. It was so dry, and at the present time almost all of the springs and wells are dry. Our well is almost gone. We can hardly get more than about one-third of a bucket of water at a time; but we had a fine rain last night, though I don't think it will make much difference in the springs.

WM. Y. STACKHOUSE.

Zermatt, Pa., Dec. 23, 1895.

An Arkansas Report.

Bees did very well this year in this part of the country—about an average crop. There are two crops to work for here, one in the spring, and one in the latter part of the summer and fall. We always get some honey ever year. I never knew both crops to fail entirely. This year the bees swarmed a good deal in the spring, as they always do. The spring crop of honey was good, but it was a little dark. The persimmon tree, from which we get our best and whitest honey, failed this year. It begins blooming about the first of May, and lasts about three weeks.

The bees did not swarm much the latter part of the summer, as they generally do. Bees swarm a good deal in August here,

The Bee-Keepers' Guide:

Or Manual of the Apiary,

By Prof. A. J. Cook.

This 15th and latest edition of Prof. Cook's magnificent book of 460 pages, in neat and substantial cloth binding, we propose to give away to our present subscribers, for the work of getting new subscribers for the American Bee Journal.

A description of the book here is quite unnecessary—it is simply the most complete scientific and practical bee-book published today. Fully illustrated, and all written in the most fascinating style, The author is also too well-known to the whole bee-world to require any introduction. No bee-keeper is fully equipped, or his library complete, without "THE BEE-KEEPER'S GUIDE."

For Two New Subscribers and Your Own Renewal.

Send us Two New Subscribers to the Bee Journal and your own renewal (with \$3.00), and we will mail you a copy of Prof. Cook's book FREE as a premium, and also a copy of the 160-page "Bees and Honey" to each New Subscriber. Prof. Cook's book alone is \$1.25, or we club it with the Bee Journal for a year—both together for only \$1.75. But surely anybody can get only 2 new subscribers to the Bee Journal for a year, and thus get the book as a premium. Let everybody try for it. Will you have one?

GEORGE W. YORK & CO.,
CHICAGO, ILLS

IF YOU WANT THE BEE-BOOK

That covers the whole Apicultural Field more completely than any other published, send \$1.25 to Prof. A. J. Cook, Claremont, Calif., for his

Bee-Keeper's Guide.

Liberal Discounts to the Trade.

WANTED!

10,000 pounds of BEESWAX, for Cash. Address, LEAHY MFG. CO., Higginsville, Mo. Mention the American Bee Journal.



SUCCESSFUL INCUBATOR
Our magnificent new catalogue giving full information regarding artificial Hatching & Bronding and treatise on poultry raising sent for 4c stamps. Circular free.

Write now. Des Moines Incubator Co. Box 78 Des Moines, Ia.

49A13t Mention the American Bee Journal.

WANTED—To exchange a 12-inch Vandervort Foundation Mill, but little used, for a Breech-Loading Shot-Gun.
4A2t J. P. H. BROWN, Augusta, Ga.

FOR SALE.

ALSIKE, CRIMSON, ITALIAN, ALFALFA, or WHITE CLOVER SEED.
4A8t W.M. CRAIG, Luce, Mich.

WANTED—200 Colonies of Bees and 4-FRAME NUCLEI, on Simplicity or Hoffman frames, in exchange for Supplies, to be shipped either from here or Medina, Ohio. Send for Catalog to—GEO. E. HILTON, 4E4t FREMONT, MICH.
Mention the American Bee Journal.

TAKE NOTICE!

BEFORE placing your orders for SUPPLIES, write for prices on 1-Piece Basswood Sections, Bee-Hives, Shipping-Crates, Frames, Foundation, Smokers, etc.

PAGE & LYON MFG. CO.
NEW LONDON, WIS.
Mention the American Bee Journal.

and if the season is good they are worth a good deal to gather the late crop of honey.

The bees are in good condition for winter. We do not need to feed, as they always store plenty to winter on. They winter well out-doors in single-walled hives. We use the dovetail hive, and think that eight frames are enough for the brood-nest for the ordinary colony of bees in this locality. We have 25 colonies, and run them for comb honey. About half are Italians, and half Italian-hybrids. It is hard to keep them pure on account of so many wild bees, which are mostly blacks. We are located about half a mile from the White river bottom.
A. J. BONHAM.

Augusta, Ark., Dec. 25, 1895.

Poorest Season in 10 Years.

Our bees gave us only about 1,100 pounds of comb honey the past season; in 1894 about 3,400 pounds of comb honey. The last was the poorest season for honey we have had in 10 years. The hard spring frost spoiled the best prospects we ever had for early honey. We get lots of honey from the black walnut trees here. The asters never yield any honey to speak of. Our bees always get plenty of fall honey to winter on, without being fed.
Bellevue, Iowa. BROWN BROS.

A Report for the Past Season.

I purchased a dollar queen in August, 1894, and kept her a week before introducing her to a swarm made the last week in August. They went into winter quarters with five Langstroth frames covered. Last spring they covered the same. They have filled their hive (a 10-frame Simplicity) and stored 84 pounds of surplus honey. I had 13 colonies in all, spring count, which gave me 250 pounds of comb honey and 60 pounds of extracted. I got 12 new swarms, and sold one for \$1.50, which leaves me 24 colonies for winter. M. A. BRADFORD.
Latourell Falls, Oreg., Dec. 21, 1895.

Too Dry for Much Honey.

The year of 1895 was very dry here, and we did not get much honey. I had 8 colonies in the spring, increased them to 17, and sold about \$40 worth of comb honey. I use the Langstroth hive, and like it the best of any I have seen yet.

We have a nice lot of hasswood here, and clover and golden-rod. DAMON CHESLEY.
Jackson, N. H., Jan. 1.

Report for 1895.

I have 180 colonies of bees, and secured 2,000 pounds of comb honey from them the past year, for which I received 10 cents per pound.
St. Mary's, Colo., Jan. 2. S. D. CURTIS.

Too Wet and Then Too Dry.

Bees did no good in this locality this year, on account of heavy rains in the spring, and excessive drouth in the summer. They gathered only about enough honey to carry them through the winter.
T. R. GREENER.

Grapevine, Tex., Dec. 18, 1895.

Some "Knows" and "Don't Knows."

I know that eight frames for a brood-chamber is too small for the best results in comb honey. I may tell why at some future time.

I know that a black hat on one's head in the bee-yard is not the best thing if the bees are at all cross. Try a light-colored hat, and then a black one, and see if I am not right.

Don't try to pack your bees to keep them warm. Leave them open to the south, and and they will get the warmth from the sun, which will do them more good than pack-

IT'S RELIABLE

The Best and Cheapest Mill on Earth. Fully warranted. Will not choke. Write at once for prices and Agency. Prices lowest. Quality best.

PEERLESS FEED GRINDERS

It grinds more grain to any degree of fineness than any other mill. Corn, ear or shelled, Oats, Wheat, &c., fine enough for any purpose.

Made only by
JOLIET STROWBRIDGE CO.
JOLIET, ILL.,
Jobbers and Manufacturers of Farm Machinery, Carriages, Wagons, Wind-mills, Bicycles, Harness, &c.



Mention the American Bee Journal. 34A26

WANTED.

10,000 pounds of BEESWAX, for Cash. Address, LEAHY MFG. CO., Higginsville, Mo.

1896 SAVE MONEY 1896

If you want first-class **ITALIAN QUEENS FOR BUSINESS**, Foundation at Wholesale Prices. Hives, suited for the South, or **SUPPLIES**, send for Price-List—to

J. P. H. BROWN, AUGUSTA, GA.

POULTRY

WHITE FACED BLACK SPANISH



40 Standard Breeds Illustrated & fully described in my new Poultry Book. Reliable information for poultrymen & intending buyers. Good stock Ducks & Geese; also Shetland Ponies. Send 6c in stamps
E. H. COOE, Box 27, Bentley, Ill.

Mention the American Bee Journal. 4A13t

PATENT WIRED COMB FOUNDATION

Has No Sag in Brood-Frames

Thin Flat-Bottom Foundation

Has No Fishbone in the Surplus Honey.

Being the cleanest is usually worked the quickest of any Foundation made

J. VAN DEUSEN & SONS,
Sole Manufacturers,
Sprout Brook Montgomery Co., N. Y.

NEW MAMMOTH

Poultry Guide for 1896 Finest book ever published, contains nearly 100 pages, all printed in colors, plans for best poultry houses, cure remedies and recipes for all diseases, and how to make poultry and gardening pay. Sent post paid for 15c. John Banschler, Jr., box 94 Freeport, Ill.

49A13t Mention the American Bee Journal.

\$1.00

Sent to me gets \$1.75.

- 1—The American Bee Journal for one year to a new subscriber.
- 2—A 50 cent copy of "Business; or How to Reach and Talk to the People." Postpaid. "An Ideal little manual."
- 3—A 25c. copy of the Chicago Daily News Almanac for 1896. Postpaid. "The best of its kind."

I can guide young people to a business and a business education combined. If you wish further particulars inclose in your letter to me a self-addressed and stamped envelope.

E. M. PRATT,
232 South East Ave., OAK PARK, ILL.
Self-Help Supplies.

ing, and they will come out stronger in the spring than if packed all around. At least mine do.

I know that a cross between the Italians and blacks are the best honey-gatherers for me that I have tried.

I don't know how bee-keepers that have a three-months' honey-flow keep their bees from crowding the queen out of room for laying eggs enough to keep the colony strong, with only eight frames for a brood-chamber.

I don't know why bees do not swarm in August, when there is a good honey-flow, the same as in the spring, if they don't reason. I know some say their bees swarm late in the fall, but mine do not.

For a cough try this: Take half a tumbler of extracted honey and the yolk of an egg; stir well before taking, and see how quick it will stop your cough.

G. E. NELSON.

Bishop Hill, Ill., Dec. 30, 1895.

Bee-Keeping "Away Up."

We are nearly 8,000 ft. above sea-level, and the past season the bees did finely. One objection is, they are "Mormon bees," and the way they believe in increasing is a sight! I believe they keep a good many "frows" in the same house, all the same.

Aspen, Colo.

S. M. BROYLES.

Sweet Clover and Alfalfa Honey.

Dr. Miller asks on page 3 what the quality of sweet clover honey is as compared with alfalfa honey. Here in Colorado we despise it, because it spoils the sale of our alfalfa honey, if mixed. After you eat alfalfa honey for awhile, and then get sweet clover honey, your liking for honey will be gone. It is so with me. Where bee-pasturage is scarce, as with me, of course a lot of sweet clover honey comes handy, if for no other use than for the bees; it would help out in the way of feeding.

Montclair, Colo.

S. M. CARLZEN.

A Poor Season in 1895.

The past season was a poor one in Otsego county. The frost and drouth were the cause, my average being but 20 pounds per colony, half comb and half extracted. But the bees are in fine condition for winter, with nearly all natural stores.

What have I learned? Well, I have learned that the flowers may bloom in abundance but yield no nectar. Our lindens were loaded with blossoms, supers were all ready, the sections filled with foundation, the bees had made a nice start on what clover and sumac there was, and we gave more supers, but, alas! we soon found that we must take them off again and feed some extracted honey to get the sections finished that were started before.

I never saw so much trouble in getting queens mated, and some were balled after they were laying. I had 4 colonies queenless in the fall, and a neighbor about one mile from me had 11.

The farmers around here have not made any more money than the bee-keepers, so I take fresh courage for 1896.

IRVIN GROVER.

Cooperstown, N. Y., Jan. 2.

Bees Did Fairly Well.

I put into the bee-cellar on Nov. 9, 1894, 34 colonies in good condition, and took out, the latter part of March, 1895, 30 colonies alive; I afterward lost two, and two others dwindled away, so they did not amount to anything only to build themselves up. They nearly all had dysentery when put out, and had spotted their hives more or less (some quite badly), but built up very rapidly on willow, maple and wild plum blossoms by May 9, when some of them were getting ready to swarm, but heavy frosts on May 11 and 12 killed the blossoms. By the latter part of June they had (or most of them) little or no honey in the hives, and were on

the point of starvation. Then the buckwheat commenced to bloom, and from that time on they stored pretty well until Sept. 1.

I increased to 57 colonies, had 4 skip for the woods, lost 4 from queenlessness, and took a little over 1,500 pounds of honey (not sections, but actual weight)—350 pounds extracted, and the balance comb honey. I have sold nearly 1,100 pounds of the comb at 12½ cents; extracted at 10 cents per pound.

I put 57 colonies of bees into the cellar Nov. 25, 1895, mostly in good condition, five or six, however, rather light in stores.

We had no white clover here to speak of last season, owing to the dry weather last year; and no basswood bloom on the low lands, and but very little on the higher land, on account of the heavy frosts in May; but the outlook now is good for another season—plenty of young clover; and basswood not blooming this season, it ought to bloom well next, if we have no frosts to kill it again.

I sowed 4 acres of crimson clover in October, but being late and dry it did not come up, so I look for nothing from that. I will try it again next season.

Long live the American Bee Journal. I want to see no department cut down, but would like to see them all enlarged; but how can a man ask it, when he is already getting more than his money's worth?

S. LAMONT.

Jarrett, Minn., Dec. 31, 1895.

Bees in Good Condition.

Bees are in good condition so far here. We had very fine weather the past fall—not as much rain as usual, but cold and dry. We have only had one inch of snow, and it was gone the next day, and only a little freeze in the mornings up to date. We look for our worst weather this month and next, but it looks now as if we may not have much snow this year.

G. D. LITTOOY.

Tacoma, Wash., Jan. 2.

A Beginner's Good Work.

I started last spring with one colony of bees in an old round hive; I now have 9 colonies, all in dovetail hives. I introduced 16 queens the past season, and lost only two. How is that for the first year with bees?

JAS. W. WOODS.

Sallisaw, Ind. Ter.

A Beginner's Report.

I started with three colonies last spring, and increased to 10. Some of my swarms I found on trees near the roadside; I put them into a box and carried them home, and put them in an 8-frame hive of my own make. I am a beginner in the bee-business, and I intend to give it a trial, as I am a cripple, and not much good for anything else. I have five or six neighbor bee-keepers, all of whom keep their bees in box-hives; they all claim they are the best. One neighbor has his bees on a stand fastened to his hogpen; another claimed the queen was the male bee, and that the workers lay the eggs. So much for a man that never reads a bee-book.

Our honey season was very good here until the middle of July, when a drouth set in, and the bees could find nothing to work on.

C. H. MAY.

Grove Hill, Va., Jan. 6.

Dr. Miller "On the Fence."

Say, Bro. York, I wish you would pull Dr. Miller off, for I imagined all the time that we were on the same side of the fence, and lo, and behold (on page 3), I find him astride of it, throwing stones, and I am hit, so here goes one back at him:

We Californians live some distance from the place where the last meeting of the North American Bee-keepers' Association was held, so if we have drawn wrong conclusions or inferences as to its "admitted

failure," Dr. M. should hunt down its members.

"The North American has never been what its founders hoped that it would be; it is not representative, and if it cannot be made such, I think it might as well be given a decent funeral."—W. F. CLARKE.

"I doubt if the North American can ever be made a representative body."—DR. A. B. MASON.

"It is useless to attempt to make the North American representative unless it is helped by Congress, and this will never be."—FRANK BENTON.

The above quotations are taken from the report of the Toronto convention, on page 648 (1895).

As to the Germans, Doctor, they as a class have the reputation of doing much and talking little; and if you (and others) who "look at the grand success of the German societies," had emulated them years ago, there would be no need of the North American attempting to work in the garb of the National Bee-keepers' Union.

GEO. W. BRODBECK.

Los Angeles, Calif.

GIVING AWAY HIVES.

On all orders received before Feb. 15th for \$20.00 or over, we will send a "Half-Joint Hive," complete, ready for a swarm.

Send for '96 Circular.

I. J. STRINGHAM,

105 Park Place. NEW YORK, N. Y.

For Sale—A Bargain.

119 Colonies of Italian Bees in Chaff Hives. Good House, and 2 acres of Land, with excellent well of water. E. L. CARRINGTON.

5Atf PETTUS, Bee Co., TEX.

Honey & Beeswax Market Quotations.

CHICAGO, ILL., Jan. 18.—White clover and linden comb honey is scarce and commands a premium over other grades of white of 1 to 3 cents per pound. There is a fair supply of other grades, which bring 12@13c for white, and amber to dark ranges at 9@11c. Extracted is without special change; the Western ambers at 4½@5c; white, 5@6c; clover and basswood in cans and barrels, 6@7c. Beeswax, 28@30c. R. A. B. & Co.

CHICAGO, ILL., Jan. 20.—We are having good inquiry for fancy comb, but all other grades are selling slow. Dark comb will not sell on this market, and we would advise the producer not to ship it here. We are offering it as low as 9@10c, with no buyers. We quote: Fancy, 15c.; No. 1, 14c.; light amber, 12@13c. Extracted, light, 5@6½c; dark, 4@5c. Beeswax, 28@30c. J. A. L.

PHILADELPHIA, PA., Jan. 3.—Honey has declined in this market during the holidays. Large lots of California honey arriving, and selling at 5c. in 60-lb. cans. We quote: Comb honey, fancy, 16c.; fair to good, 8@14c. Extracted, 4@5½c.; white clover, 10c. Beeswax, 30c. W. A. S.

BUFFALO, N. Y., Jan. 22.—Sales very light and market dull. We quote: Fancy white, 14@15c.; choice, 11@13c.; buckwheat, 7@9c. Extracted, 4@6c. Beeswax, 25@28c. B. & Co.

CINCINNATI, O., Jan. 22.—Demand is slow for comb honey, which brings 12@14c. for best white. The demand is fair for extracted honey at 4@7c., with a scant supply. Beeswax is in good demand at 25@28c. for good to choice yellow. C. F. M. & S.

KANSAS CITY, Mo., Jan. 20.—The demand for comb and extracted honey is fair. We quote: No. 1 white comb, 1-lbs., 13@14c.; No. 2, 12@13c.; No. 1 amber, 11@12c.; No. 2, 8@10c. Extracted, white, 6@6½c.; amber, 5@5½c.; dark, 4c. Beeswax, 22@25c. C. C. C. & Co.

WISCONSIN.—The annual meeting of the Wisconsin State Bee-keepers' Association will be held Thursday and Friday, Feb. 6 and 7, 1895, in the capitol building at Madison. The program will appear in due time. Platteville, Wis. N. E. FRANCE, Sec.

\$3.00 Worth for \$2.00 !

Until further notice, we propose to give you a chance to get some good reading-matter for the long winter evenings, at **half price**.

Send us \$2.00, and we will mail you your choice of \$3.00 worth of the following booklets, and also credit your subscription to the American Bee Journal for one year:

Poultry for Market and Profit.....	25c
Our Poultry Doctor.....	30c
Turkeys for Market and Profit.....	25c
Capons and Capouizing.....	30c
Rural Life.....	25c
Preparation of Honey for the Market.....	10c
Bee-Pasturage a Necessity.....	10c
Hive I Use, by Doolittle.....	5c
Foul Brood, by Dr. Howard.....	25c
Foul Brood, by Kohnke.....	25c
Foul Brood, by Cheshire.....	10c
Bee-Keeping for Profit, by Dr. Tinker.....	25c
Kendall's Horse-Book—Eng. or German.....	25c
Silo and Silage, by Prof. Cook.....	25c
Hand-Book of Health, by Dr. Foote.....	25c
Maple Sugar and the Sugar Bush.....	35c
Potato Culture, by Terry.....	40c
Carp Culture, by Root & Finney.....	40c
Strawberry Culture, by Terry & Root.....	40c
Blenn Kultur, by Newman [German].....	40c
Winter Problem in Bee-Keeping [Pierce].....	50c
Bee-Keepers' Directory, by Heury Alley.....	50c
Advanced Bee-Culture, by Hutchison.....	50c
5 Honey as Food and Medicine.....	25c

GEORGE W. YORK & CO.,
CHICAGO, ILLS.



Promptness Is What Counts !

Honey-Jars, Shipping-Cases, and everything that bee-keepers use. **Root's Goods at Root's Prices**, and the best shipping point in the country. Dealer in Honey and Beeswax. Catalogue Free.

Walter S. Ponder
162 Mass. Ave.
INDIANAPOLIS, IND.

SELLING OUT.

To close out, I offer my Improved Queen-and-Drone Traps per 1/2 doz., in the flat, at \$1.75; per doz., \$2.75; per 25, \$5.00.

Individual Right to manufacture and use, 50 cents; Township Rights, \$1.00; County Rights, \$5.00.

HENRY ALLEY,
1 Atf WENHAM, MASS.

TRY to sell your **POULTRY, VEGETABLES, FRUITS** and all produce at **HIGHEST PRICES, DAILY RETURNS.** For stencils, prices and references, write to **F. I. SAGE & SONS, 183 Reade St., N. Y.**
WHEN ANSWERING THIS ADVERTISEMENT, MENTION THIS JOURNAL.

The Patent Wood Veneer FOUNDATION

has no sag in full sheets. EXTRA THIN Foundation 13 square feet to the pound. Working Wax into Foundation—if sent to me—a specialty. Send for prices, samples & Catalogue. Wax wanted.

AUG. WEISS
2A5t HORTONVILLE, WIS

Mention the American Bee Journal.



ONE MAN WITH THE UNION COMBINATION SAW

Can do the work of four men using hand tools, in Rippling, Cutting-off, Mitring, Rabbeting, Grooving, Gaining, Dadoing, Edging-up, Jointing Stuff, etc. Full Line of Foot and Hand Power Machinery. Sold on Trial. Catalogue Free.

SENECA FALLS MFG. CO.,
46 Water St., SENECA FALLS, N. Y.
1A1y Mention the American Bee Journal.

Bee-Keepers' Photograph.—We have now on hand a limited number of excellent photographs of prominent bee-keepers—a number of pictures on one card. The likeness of 49 of them are shown on one of the photographs, and 121 on the other. We will send them, postpaid, for 50 cents each, mailing from the 121 kind first; then after they are all gone, we will send the 49 kind. So those who order first will get the most "faces" for their money.

PERSONAL MENTION.

GEO. W. BRODBECK AND W. W. BLISS, of California, secured medals on honey at the Atlanta Exposition. So Rambler reported in Gleanings.

PROF. COOK, as well as many other California bee-keepers, are expecting a good deal from their new Honey Exchange. May their fondest hopes be realized

HON. GEO. E. HILTON—the leading bee-keeping legislator—of Fremont, Mich., has been visiting the "Home of the Honey-Bees." It's about time he came to Chicago again.

MESSRS. R. AND E. C. PORTER, of this State, have made a bee-escape "for freeing honey and extracting rooms, house-aparies, etc., from bees." We expect to illustrate and describe it next week.

MR. H. R. BOARDMAN, of East Townsend, Ohio, has been talking at Farmers' Institutes lately. One of his interesting addresses was given in Gleanings. He begins just right—at the ground.

SKYLARK is a new contributor to Gleanings. He's a high-flier, as his name indicates. Oh, but don't he "let fly" "right from the shoulder!" If Somnambulist, of the Progressive, catches him out some fine night, he'll wish he was skylarking around somewhere else.

MRS. J. N. HEATER, of Columbus, Nebr., wrote thus kindly on Jan. 17: "We feel quite proud of our 'Old Reliable' in her new dress and still newer trimmings. The season, so far, has been very mild in this section, our bees having a good flight every week or ten days."

MR. ERNEST R. ROOT, the able editor of Gleanings in Bee-Culture, made the Bee Journal, and Chicago in general, a short visit during the recent Chicago bee-convention. He also spent a day or two with Dr. Miller, at Marengo. We are always very glad to meet our fellow bee-editors, and none more so than Mr. Root.

JAMES MILLS, M.A., L.L.D., is the popular president of the Ontario Agricultural College, at Guelph, Ont. A splendid likeness of him appeared in the Canadian Bee Journal for December. We had the pleasure of meeting him at Toronto last September. He's the leading Methodist layman of Canada, we hear. Good man in a good place. Good for him!

MRS. L. HARRISON, of Peoria, Ill., has gone for the winter, as usual, to St. Andrews Bay, Fla. How nice it is to be able to "go South," like the birds, to escape the rigorous cold of the North. We trust our sister may have a pleasant time amid the perfume-laden flowers, merry-warbling songsters, and busy-humming bees of the Sunny Southland.

EDITOR HUTCHINSON, in a letter received Jan. 22, says that his "own health is now pretty good." It will be remembered that last summer he suffered a good deal from rheumatism, so much so that he feared he would not be able to go to the Toronto convention in September. Mr. H.'s daughter, Ivy, who also has been sick the past two or three months, is slowly improving, we are glad to learn.

MR. J. B. HALL'S PICTURE graces the first page of the January Canadian Bee Journal. He is the honored President of the Ontario Association, and the comb-honey chieftain of Canadian beeedom. Too bad he's such a modest man everywhere except in a bee-convention. Wonder if we couldn't smug-

gle him over here occasionally, and "set him going" at some of our conventions. I think he's the man that could very seldom truthfully say "I don't know," when asked a bee-question.

REV. ADAM BLAND—the husband of Mrs. Ellen C. Bland, a bee-keeper and Bee Journal subscriber in California—died in October, 1895. He was one of the pioneer Methodist preachers in that State, and did most efficient work in the southern part. We are acquainted with one of the sons (R. W. Bland), who is now preaching in Joliet, Ill., but who filled very acceptably prominent Methodist pulpits for several years in and about Chicago.

List of Honey and Beeswax Dealers.

Most of whom Quote in this Journal.

- Chicago, Ill.**
R. A. BURNETT & Co., 163 South Water Street.
- New York, N. Y.**
F. I. SAGE & SON, 183 Reade Street.
HILDRETH BROS. & SEGELKEN,
120 & 122 West Broadway.
- CHAS. ISRAEL & BROS.**, 486 Canal St.
- Kansas City, Mo.**
C. C. CLEMOMS & Co., 423 Walnut St.
- Buffalo, N. Y.**
BATTERSON & Co., 167 & 169 Scott St.
- Hamilton, Ills.**
CHAS. DADANT & SON.
- Philadelphia, Pa.**
WM. A. SELSER, 10 Vine St.
- Cincinnati, Ohio.**
C. F. MUTH & SON, cor. Freeman & Central avs.

Catalogs for 1896.—We have received the following Catalogs, Price-Lists, etc., a copy of which may be obtained upon application, always being careful to say you saw their advertisement in the American Bee Journal:

- H. W. Buckbee, Rockford, Ill.—Seed and Plant Guide.
- John Bauscher, Jr., Freeport, Ill.—Poultry Guide and Catalog. Price, 15 cents.
- The A. I. Root Co., Medina, Ohio.—Bee-Keepers' Supplies.
- C. N. Bowers, Dakota, Ill.—Poultry Annual and Book of Valuable Recipes. Price, 10 cents.
- Reliable Incubator and Brooder Co., Quincy, Ill.—Eleventh Annual Catalog.

The Successful "Successful."—The Successful Incubator, manufactured by the Des Moines Incubator Co., of Des Moines, Iowa, in competition with some of the leading incubators of the country at a Kansas City Show, recently won first honors. This is indeed a great victory for the Successful Incubator, and it looks very much as if some pretty close competition for honors will be the result of the exhibits at the shows that are to be held at other places. The Des Moines Incubator Co. have recently issued their annual book—a complete treatise on poultry—and will be sent to any one for 10 cents in stamps.



What Venezuela Should Do.

"Lay low" until the boundary line is established, then put up a "Page," the only reliable "Bull" proof fence.

PAGE WOVEN WIRE FENCE CO., Adrian, Mich.
Mention the American Bee Journal.

Bottom Prices

**BRING US BIG TRADE.
GOOD GOODS KEEP IT.**

If you want the best supplies that can be made at a little less cost than you can buy the same goods for elsewhere, write to us for low prices. 1896 Catalogue now ready—ask for it and a free copy of *The American Bee-Keeper* (36 pages).

Address,
**THE W. T. FALCONER MFG. CO.,
JAMESTOWN, N. Y.**
Mention the American Bee Journal.



Wonderful Record.
17 Years with but one complaining letter.
I think Bingham Smokers and Bingham & Hetherington Honey-Knives are PERFECT. Write what you think of them, on a card, and mail to—
T. F. BINGHAM, Farwell, Mich.
4A4t *Mention the American Bee Journal*

HEADQUARTERS for ROOTS' GOODS
Can supply you with all the Fixtures used in an Apiary. Best Goods at Lowest Prices. Catalogue free. 5% discount until March 1st.
JNO. NEBEL & SON, High Hill, Mo.
Mention the American Bee Journal. 4A4t

The Rural Kansan
Is an Agricultural Journal for the busy farmer. It embraces Bee-Keeping and every department of industry connected with the farm. 30 cts. a year, monthly. Sample Free.
A Full Line of **Higginsville Bee-Supplies** on hand.
CATALOGUE FREE.
HENRY L. MILLER,
355 Shawnee Ave. TOPEKA, KAN.
1A13t *Mention the American Bee Journal.*

TWO YEARS FOR THE PRICE OF ONE.

To any one not now a subscriber to the **BEE-KEEPERS' REVIEW**, who sends \$1.00 for it for 1896, and says that he wants them, I will send 12 back numbers, free. This is done to induce those who are strangers to the **REVIEW** to become acquainted with its merits. To hold old subscribers is not difficult; and, to get the **REVIEW** into the hands of new men, that they too, may, in time, become old subscribers, is worth an extra effort, hence this offer. The back numbers of the **REVIEW**, most of them, have a value peculiarly their own; they are "special topic" numbers. That is, each number is really a little book in which may be found the views of the best bee-keepers upon some important apian subject. They are as valuable now as when published. Of some of these issues there are several hundred, of others not more than a dozen, and in filling these orders I must be allowed to make the selection, but no two copies will be alike. For 25c, extra, the 50c. book, **ADVANCED BEE-CULTURE** will be included. The **REVIEW** for 1896, 12 back numbers, and the book, all for only \$1.25
W. Z. HUTCHINSON, Flint, Mich.
WHEN ANSWERING THIS ADVERTISEMENT, MENTION THIS JOURNAL.

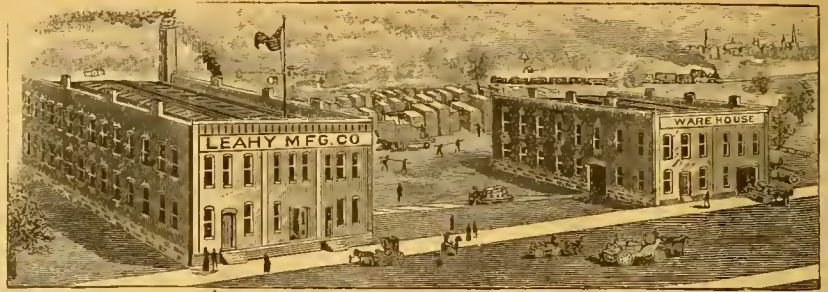

Largest Factory in the West COMPLETE STOCK. Good Supplies and Low Prices Our Motto.

READ THIS—Mr. Keyes says: The 100 pounds of Extra-Thin Foundation you sent us' is superior to anything he ever saw; and I think the same. R. L. TUCKER, Wewahatchka, Fla.
Dear Sirs:—The Sections came duly to hand. Indeed, they are very nice. Yes, sir; they are as good as the best. CHARLES H. THIES, Steeleville, Illinois.
Leahy Mfg. Co.:—I have received the bill of goods. I must say they are the choicest lot of Hive-Stuff I have ever received from any place. I admire the smoothness of your work, and your close selection of lumber. Yours very truly, O. K. OLMSTEAD, Orleans, Nehr.
Dear Sirs:—The Sections arrived in due time, and are all O. K. so far as examined. They are simply perfection. I can't see how you can furnish such goods at such low prices. I hope you may live long and do well. Yours respectfully, Z. S. WEAVER, Courtney, Tex.
Gents:—I received the "Higginsville Smoker" all O. K. It's a dandy; please find enclosed stamps for another. Yours truly, OTTO ENDERS, Oswegatke, N. Y.
Gentlemen:—I have bought Supplies from nearly all the large manufacturers by the carload, and I must say yours are as good as the best. Indeed, in many lines they are the best. It is a pleasure to handle them. E. T. FLANAGAN, Belleville, Illinois.
The above unsolicited testimonials are a fair sample of hundreds we receive. Our prices are reasonable and the "Higginsville Goods" are the best.
We are now manufacturing for each of the following parties a Carload of Supplies: E. T. Flanagan, Belleville, Illinois; Charles H. Thies, Steeleville, Illinois; J. W. Rouse & Co., Mexico, Mo.; Henry Miller, Topeka, Kans.; Fulton & Gregg, Garden City, Kans.
If you need a Carload of Supplies, or only a Bee-Smoker, write to us. Remember, we are here to serve you, and will, if you give us a chance. **A Beautiful Catalogue Free.**
Address, **LEAHY MANUFACTURING CO., HIGGINSVILLE, MO.**
49A *Mention the American Bee Journal.*

CASH PAID FOR BEESWAX

For all the good, pure yellow **BEESWAX** delivered to our office on or before Feb. 20, 1896, we will pay 26 cents per pound, cash; or 30 cents for whatever part is exchanged for Bee Journal subscription or books that we offer. If you want **cash promptly** for wax, send it on at once. Dark or impure wax not taken at any price. Address plainly,

George W. York & Co., 56 Fifth Ave., Chicago, Ill.

SECTIONS, BEE-HIVES, SHIPPING-CASES

We make a Specialty of these Goods, and defy Competition in **QUALITY, WORKMANSHIP AND PRICES.**
Write for Free Illustrated Catalogue and Price-List.
G. B. LEWIS COMPANY, Watertown, Wis.
Be sure to mention the American Bee Journal when you write.

* ROOT'S COMB FOUNDATION! *

New Product.
New Process.
A Big Success

We are pleased to announce that, having secured control of the new Weed process of manufacturing foundation for the U. S., we are prepared to furnish **Foundation by the New Process**, for 1896. Samples will be mailed free on application, and will speak for themselves.
OUR SANDED and POLISHED SECTIONS, well, they will speak for themselves, also.
Our 1896 Catalog will be ready for distribution now in a few days. Send in your name at once for catalog, samples of the new foundation, and those superb sections, and while you are about it ask for late copy of **Gleanings in Bee-Culture**.

THE A. I. ROOT CO., MEDINA, OHIO.
56 5th Ave., Chicago, Ill. Syracuse, N. Y.
1024 Mississippi St., St. Paul, Minn.

AMERICAN BEE JOURNAL

DEVOTED EXCLUSIVELY TO THE INTERESTS OF HONEY-PRODUCERS

ESTABLISHED IN 1861
THE OLDEST BEE-PAPER IN AMERICA

Published Weekly, at \$1.00 per annum.

Sample Copy sent on Application.

36th Year.

CHICAGO, ILL., FEB. 6, 1896.

No. 6.



The New "California Honey-Exchange."

BY PROF. A. J. COOK.

In response to the request of subscribers to the American Bee Journal, I append the following regarding the proposed California Honey Exchange.

The honey-producers of California feel that they have a serious grievance. They can produce honey of excellent quality

The retail prices remain practically the same, whether the season is very poor, fair, or excellent.

There are but two explanations to this anomalous condition. Either a large supply irrespective of the actual amount produced, or else the dealers and commission men manipulate prices to suit their greed for gain, paying no heed to whether the producer has any margin of profit or not. This state of affairs has become simply unbearable; and the California bee-men are aroused to the necessity of a complete revolution. Like the producers of nearly all our farm products, they have no voice as to what they shall pay or receive as they visit the markets to buy or sell. They see no reason why they should not have a voice in determining prices on their own products. Could they but work in concert, act as one man, something after the manner of the Standard Oil Company, then they could adjust prices of their honey according to the amount, and the cost of production. This is just what they are hoping. They believe that they have confidence enough in each other to thus act, and intelligence enough to adopt and make operative the best scheme of co-operation.



Apiary of Mr. J. W. Young, Kingman, Kans.—See page 88.

and in satisfactory quantities, but they have to pay exorbitant freight-rates, and are forced to accept ruinously low prices. Up to the present time they have been utterly unable to regulate either transportation rates or the markets on a living basis. What makes the wrong all the more aggravating and exasperating is the fact that, though they receive prices which leave them no margin of profit, and often brings them in debt at the close of the season, yet the actual consumer pays as much as of old, when prices to the producer were more than double the prices of to-day. Again, any poor seasons make no perceptible difference with the prices in the retail markets.

In formulating a plan, the bee-men are not wholly in the dark, or walking an unbeaten path. They have before them an example where genuine success, and almost universal satisfaction, has been secured. The orange-growers were threatened with bankruptcy in the face of just such evils as confront the bee-men. They organized the Southern California Fruit Exchange, and already, though but two years a-field, this new organization, on the plan of carefully managed co-operation, has brought new hope and courage to the Citrus Fruit Growers of this whole southern country. The Fruit Exchange is a corporate body. There is a central board that oversees the whole

work of the organization. Under this there are local organizations for each district. Each orchardist may purchase stock up to the limit of five shares per acre of his actual acreage of orchard, though all purchases of stock and all transfers must be approved by the Executive Committee that manage the local exchange. This committee is elected by the votes of the stockholders, each space of stock giving a vote. The directors of all the local exchanges elect the central managing Board. This Board districts the markets of the country, and prepares to supply each market according to its needs, as determined by a careful estimate by experts previous to the opening of the year's trade. This central body also receives from the manager of each local exchange, before the season opens, a careful estimate of the probable output of its orchards. Thus when the season opens, each local exchange is ordered by the central body to furnish its proportion of the fruit needed to keep all the markets supplied; care being taken that no market shall be glutted and no market destitute of fruit.

Each Exchange secures by vote of its Executive Board, a bright, active, wide-awake, rustling, capable manager, who receives orders from the central Board and apportions these orders to the several growers of his precinct. He also is an expert, and looks to grading, packing and shipping. Thus the grading is well done, and the packing and shipping very cheaply done. A saving last year of ten cents a box in the Claremont Exchange would amount to a total saving of over \$20,000. A rebate on freight, which previously went to the commission-men, now goes direct to the producers, and aggregates many thousands of dollars.

The Exchange is a powerful organization, and is interested in low freight-rates, as the commission-men never could be, and is able to secure not what the traffic will bear, but what is just. Add to this the better markets, the better distribution, and the intelligent effort to develop the markets before the season, and we do not wonder that the Exchange has already won for itself the respect of the orange-growers, and also the praise of bankers and business-men generally.

The bee-keepers hope—and not without reason—to do all that the citrus fruit men have accomplished. They expect to deal with the manufacturer of supplies and save one or two fees in this purchasing. They expect to gain as much in regulating of freights and advance in the markets as the citrus fruit-producers have secured through the fruit exchange. A very able committee held a prolonged session last week in Los Angeles, and will soon publish a scheme that will no doubt meet the approval of the apiarists of the State. No doubt but they will copy largely after the Fruit Exchange. It may even be thought best to work with the latter body in working up the Eastern markets, though at present it seems more probable that some able, capable, experienced manager will be selected, who will, under an executive board, negotiate for supplies, develop markets and conduct the business of the entire exchange.

Every bee-keeper in California should at once write to Secretary J. H. Martin, of Bloomington, giving present year's crop, amount and kind of honey on hand; and like statistics and name and address of bee-keeping neighbors.

Claremont, Calif.



Locating Apiaries in Sheltered Places.

BY C. DAVENPORT.

I believe it is claimed and accepted as a fact by all, that it is best to have an apiary located in a well-protected or sheltered spot. I have some strong doubts whether this is true, and will give my reasons for so thinking.

Some years ago I had an apiary for two years located in a very sheltered spot. Right back of this yard, on the north, and partly on the northwest side also were high hills. It was protected on the east side by a dense grove, and on the south by high ground. But while the grove on the east, and the high ground at the south protected the yard from most of the wind from those directions, they were at such a distance that they did not prevent the yard from receiving the full benefit of the sun.

I had had this place in mind for sometime, as a very favorable place to locate a yard. For sometime I had a yard located near this place—but it was in a high and exposed position. Still, it had always done well, for this was a good range. The first spring that I put bees in this sheltered place, nearly half of them died from spring dwindling. I thought it was lucky that I had placed them in this well-protected spot, for as so many died there, I thought if I had placed them in their old and exposed location near by, probably nearly all of them

would have died, for that was a cold, late spring. Still, I was puzzled about the matter somewhat, for the loss in the home yard, which, at that time, was in a location where it received the full sweep of the wind from all directions, was not one-third as heavy as it was in this out-yard. But I accounted for it at the time by thinking that those that were removed to the out-yard had, on account of being moved, filled themselves too full of honey, and thus weakened their vitality, or something of the kind.

The next year we had a warm and early spring, and in the home yard there was practically no loss from spring dwindling. But the loss from this cause in this out-yard was very heavy again, though not as bad as it was the first year. This second year I decided that the spring dwindling in the out-yard was caused by its being in such a sheltered spot. The way I account for it is, that in this locality, no matter whether the spring is early or late, there are a good many days when the sun shines brightly, but on account of cold winds the bees perish if they fly and remain out long. Now, this yard being practically protected from these winds, especially on the north and northwest, it was often so warm and pleasant there that the bees would come out and fly, and perish in the cold winds which blew outside of the warm ravine where the hives were.

Now, I am fully aware that those two seasons were not enough to prove this matter conclusively, and that some other cause foreign to this might have been the real cause of so many bees dying in that yard those two springs.

I think it is much better to have a yard protected on the north, and partly on the northwest side also, but I do not believe this protection should consist of very high hills, or, in other words, I believe if a yard is too well protected from the wind, it is worse than no protection at all in this locality.

I should like to have others, who have had experience in this matter, give their opinions about it, whether it coincides with mine or not.

Southern Minnesota.



Some Subjects Reviewed and Commented Upon

BY DR. C. C. MILLER.

NON-SWARMING.—Was it the irony of fate, or was it pure cussedness on the part of the editor, that gave in the same number on page 54 that sentence quoted from Doolittle in which he takes the ground that "better results can be obtained where bees swarm than would be the case if we could breed out the swarming trait," only five pages after the place where he commits himself as very much interested in breeding out the swarming habit? But it ought to be remembered that, like every sensible man, Doolittle grows, and he expressly says in his article that his opinions have been modified to a considerable extent. [No; that sentence quoted from Mr. D. was simply taken from his book.—Ed.]

While we may not reach a strain of bees that can never be induced to swarm, it would seem well worth while to have bees such as he speaks of having obtained that give only one swarm to where he used to have ten. For whatever plan may be used to prevent swarming—and thousands are doing what they can to prevent it—prevention will probably be easier with those least given to swarming. Certainly, Doolittle's philosophy seems reasonable, that where queens are reared consecutively for generations from colonies that have never thought of swarming, the habit of swarming will grow weaker.

SWARMING WITHOUT A QUEEN.—Very interesting is A. Getaz' account, on page 51, of the department of colonies swarming when the queen is not allowed to accompany them. Each failure makes them more desperate, and I once had a swarm at an out-apiary that hung on a bush two days and nights without a queen, which, I suppose, had been baffled several times. In another case they swarmed out with not a cell of eggs or brood in the hive except one queen-cell with an egg, but with honey in the super.

THAT BEE-KEEPERS' UNION REPORT (see page 59) makes good reading. Until I read it I hardly realized that the Union was still doing so much good. Whatever the General Manager may think about his successor, I hardly think the successor will be elected just yet.

BUYING HONEY TO SELL AGAIN.—On page 57 you say, Mr. Editor, "any reasonable customer wouldn't care a fig where the honey came from, so long as he was satisfied of its purity." It may be that the average customer is not a "reasonable customer," and it may be that elsewhere customers are different, but I am very sure that in my balliwick customers do care several figs whether honey comes from my apiary

or not. One day an intelligent druggist wanted some honey from me, so he could be sure it was pure; I told him there was some comb honey right across the way at the grocery that I would warrant all right, but it didn't satisfy him. I'm not saying a word against buying to sell again—that's all right; but I think the fact remains that people would a little rather have honey produced by the one from whom they buy, providing he is one in whom they have confidence.—[All right; we've had our "say."—Ed.]

A CORRECTION.—On page 54, in reply to a question I say, "at that rate it would require a fraction more than 71 colonies to allow an expectation of \$50 annually. There are the figures for you, and I've confidence enough in your abilities as an accountant to see that they're all straight." But they weren't "straight," by any means, for that \$50 ought to have been \$500. Some one in a certain printing-office ought to have a whack over the head for dropping out that cipher. Or is the whack due some 66 miles further west?—[Tis our fault, Doctor; and we are ready for that "whack."—Ed.]

SWEET CLOVER.—Will M. M. Miller please tell us about that sweet clover he mentions on page 62? Where it grows along the wayside is it of any value as a forage-plant? Did those neighbors who mowed it three times make any use of the hay? At what stage of growth was the first mowing?

UNFINISHED SECTIONS.—Mr. Miller also says, "honey stored in the combs once used, with me, was never first-class the next season." If the honey is extracted from such sections, and without having anything more done with them they are again used the next season, you may count on the honey being affected by the granulations from the little honey that the extractor doesn't get out. But if, immediately after being extracted, the sections are placed out where the bees have free access to them for a number of days, honey put in them the next season will be all right. Marengo, Ill.



Hives from Foul-Broody Colonies.

BY O. M. DOOLITTLE.

In a letter lying before me I find these words: "Foul brood visited my apiary last season and I had a struggle with it, and I think I have it in subjection, having used the Jones' plan to eradicate it from my apiary. All colonies are now in new hives, but I have the old ones on hand. Is there any way I can cleanse these old hives so I can use them again? If so, will you tell us about it in the American Bee Journal, as I feel too poor to buy all new hives for another season."

I had foul brood in my apiary in the early 70's, and succeeded in eradicating it by the Quinby plan, which is the same as the Jones' plan. This left me in a similar condition to what our correspondent is in, and as I thought I could not afford to throw the hives away I proceeded as follows, and have never seen any trace of the disease since:

The hives were scalded by plunging them into boiling water, the water being in a large caldron-kettle which was used on the farm for cooking food for the hogs, heating water for butchering, etc. The hives were put in first and scalded, and afterward the frames and combs, thus scalding the frames and making the combs into wax at the same time. As I made all of my frames with saw and plane then, I thought I must save them, but in these days of machinery I do not think it would pay to bother with the frames, for this scalding process makes them untrue and in poor shape for use again, so that new frames are much cheaper in the long run.

Later on, a bee-keeper several miles away called me to his apiary to see his bees who had foul brood. I found it in several of his hives, and told him how to treat it. After he had cured his colonies he scalded the hives by pouring water from a tea-kettle onto the inside of the infected hives, and no foul brood was the result, afterward. If you are sure that the hot water hits every nook and corner of the hive, I do not know why this plan would not answer where nothing holding boiling water is at hand, large enough to put the whole hive in. The first would be the safest, however.

Some claim that the hives do not need scalding, or doing anything else with them, if they are allowed to stand outside exposed to the weather one winter, in a locality where the mercury sinks to zero or below during the winter. They claim that the freezing and thawing of one winter is amply sufficient to destroy all the spores or germs of foul brood about any hive. I should be inclined to go slow on this, trying only one or two till I had proved for myself that there was no danger from such hives.

DON'T MAIL SAMPLES OF FOUL-BROOD.

While on this subject of foul brood, I wish to call attention to what I consider as something having the elements of danger in it, and that is the promiscuous sending of samples of what is supposed as foul brood through the mails, to different persons for their opinion in the matter. One day last summer I received a package of what was once a thread-box. All broken and mashed, with the paper which was around it torn and soiled, the whole being saturated in places with thin honey and mashed brood, while much of the mail in the same bag with it was more or less sticky and besmeared, the package giving off a sickening scent, which told me at once what it was. As good luck would have it, the day was a cool one, and I was there to get the mail when it came, which is not often the case, as I generally go for my mail at night, else this careless sending of that package might have done much harm, as there are two apiaries within 75 rods of the post-office, and in warm weather the doors and windows are all left open. Had it been warm, and one single bee taken a load of that honey (the package came in a time of scarcity of honey when bees were ready to rob), the colony to which the load was taken would have contracted the disease, and had many bees been attracted to it a whole apiary or two might have been ruined, or the owner put to much trouble and worry to have eradicated what a careless hand had strewn. I put the package immediately into the fire and helped wash and clean the mail as best we could, so none of the disease need be carried farther, if possible.

HOW TO DETECT FOUL BROOD.

Now I wish to say to all who read this, Don't do such a thing as to send foul brood in the mails as samples, for by so doing you are liable to expose others to the same ills which you are so anxious to be rid of yourself. The books of the present day are sufficiently explicit in describing this disease, so you should be able to tell yourselves, without a reasonable doubt, with this additional test: Whenever you find something which you think is wrong about the brood in any hive in your yard, the first thing you are to do is to close that hive as quickly as possible, so that there will be no chance for other bees to get at the honey, and then wash your hands and all else which you have used about the hive. This examination will tell you whether the bees are strong enough to repel robbers; and if so, the entrance should be contracted so you are sure no robbing can occur.

Now leave the hive entirely alone till near night some day, about two weeks from that time, and after the other bees are done flying, open it and examine it closely, washing your hands, etc., as before. If you still think there is a chance of its being foul brood, leave the hive closed again for two or three weeks (providing it has plenty of bees to resist robbers), when you are to examine it again. Now bear in mind that genuine foul brood is aggressive, and never retrograding, so that if you find more of it than at first, and still later more yet, together with the symptoms which the books describe, that colony should be burned up at once, and gotten out of the way, before any of the rest have a chance to carry off any of the honey. If, on the contrary, it does not perceptibly progress, or there is not as much as before, keep watch of it till you are assured there is no harm in it. In no case change combs with any other hive, or expose any of this honey till you are sure it is not foul brood.

Unless at least four or five colonies in the apiary have foul brood, I should not attempt to cure it save by burning, for I do not think it would pay any one to run the risk he would have to, in trying to cure the disease for less than that number. Borodino, N. Y.



A Half-Dozen Apiarian Comments.

BY BEE-MASTER.

WEARING VEILS.—Mr. Doolittle's remarks some time ago, about the wearing of bee-veils, are very sensible, but I doubt the wisdom of wearing them all the time when at work in the bee-yard. There are many operations in performing which there is little or no danger of getting stung, and as the veil is rather a hindrance to the fresh circulation of air, I do not think it is good for the lungs to wear it for any lengthened period of time. I keep mine rolled up on the rim of my hat, where it can be pulled down in a moment when I am menaced with a sting. The chip-hat suggestion is a good one. It gets twisted into all manner of shapes, but it is light, porous, and cheap. We are not all of us as particular as Mr. Hutchinson, to be dressed up in Sunday-go-to-meeting style when we are working in the bee-yard. When his picture with a bee-veil

attached to his best straw-hat appeared, I must needs get one just like it, but I found it a most uncomfortable affair—too stiff and unbending, too close and hard, leaving an inflamed sweat-mark all across the forehead, and hurting the back of the head. I did not know before that there was any difference in bobinet meshes. After this, I shall look out for the hexagonal form as a help to seeing as plainly as possible, which is a matter of the greatest importance in connection with the use of bee-veils.

WINTERING BEES.—The condensed symposium on this subject on page 777 (1895), will repay not only perusal but study. I agree with Editor Root that the essentials in which all the writers agree are—good bees of right age; good food; and suitable protection. But is there not another? Ventilation, *somewhere*, either at top or bottom? It does not seem to be of much consequence where, if there is only enough. If much on top, little at bottom, and *vice versa*. What Editor R. says as to granulated sugar fed early so as to be well ripened holding first place, I somewhat doubt. If I thought that was the best food for bees, and that even "good light honey" holds only second place, I might be tempted to think it was the best honey for human consumption, which would be rank heresy if not unpardonable sin. But what does Dr. Miller mean by saying in Gleanings (page 887): "Part of my bees will be wintered in the cellar this winter, the rest out-doors? Number in cellar, 157. Number out-doors, 1?" Is that to be taken as his estimate of the comparative merits of cellar and out-door wintering? Or is it merely one of the Doctor's little sallies of wit? In justice to the advocates of out-door wintering, he should explain.

VIRTUES OF HONEY.—Let me call special attention to what Rev. Emerson T. Abbott says on page 777 (1895), about honey being a germicide and an antiseptic. No doubt these qualities make it valuable as a preventive as well as a remedy for microbe diseases of all kinds. As for its wholesomeness in the case of diabetic patients, there is a big field for discussion, and a big opening for the usefulness of the honey-bee when the day comes that the sugar-honey question can be sifted to the bottom. But switching off from that as dangerous ground, are bee-keepers generally aware that while the foul-brood *bacillus* can live in a state of suspended animation in honey, it cannot multiply itself there? This is an interesting and encouraging fact. Honey has an acid reaction, and the *bacillus alvei* cannot grow in any fluid of that nature. It must come into contact with an alkaline substance to be quickened into active life. Has the sale of unripe honey and honey adulterated with glucose and other substances had anything to do with the spread of foul brood, owing to lack of a sufficient percentage of formic acid? This is a question which it will pay to look into.

MAKING BEES DRUNK.—That scheme of J. H. Andre's on page 752 (1895), to make bees honest by smoking them till they are drunk, is not to be commended. There is a stage of inebriety in the case of human beings in which they are very good and pious, tender, penitent, and resolved to lead better lives, but it all wears off when they get sober. I feel sure that bees made drunk will return to their bad ways when they sober off. The only sure cure for robbing I have ever found to work in all cases is to contract the entrance so that only one bee at a time can pass and repass. If the weather is hot, so that the hive needs more ventilation than it can get through so small a fly-hole, a piece of perforated zinc or tin having plenty of holes in it, but only one large enough to permit a bee to go through, will fill the bill. Colonies that are weak in numbers are the ones that are most liable to be robbed, and these can be fixed in the way described so that they will have air enough, and yet be able to defend themselves from all intruders.

EVOLUTION OF ASSOCIATIONS.—Mr. Hilton's account of the way the "Newaygo County Progressive Bee-Keepers' Association" expanded into a Farmers' and Bee-Keepers' Association, and now seems likely to undergo another process of evolution into a Farmers' Institute, that shall comprise every department of rural industry, suggests the question whether special or general organizations best promote the public welfare. We have now agricultural, horticultural, fruit-cultural, apicultural, and any number of live-stock-cultural societies. I doubt if the present system is calculated to make good, all-round farmers. It is doubtless fitted to make specialists, but the various forms of rural industry run into one another and have such intimate relations that to be specially qualified along one line, implies and necessitates knowing something about several more. The amalgamation of the two great beekeepers' associations is an example of the tendency of things;

by-and-by, we shall probably get horticulture, or at any rate the small fruit branch of it, added to bee-keeping, and ultimately, perhaps, a comprehensive body like the Farmers' Institute will be made broad enough and big enough to take in the entire circle of rural pursuits.

HIVE-CONTRACTION.—There is a great deal written on this subject which I do not more than half believe. I have no faith in any system of bee-keeping which goes on the principle of everlastingly disturbing a colony of bees. I have no doubt many colonies are disturbed to death. The Heddon plan of contraction by splitting a hive that has a divisible brood-chamber, has an air of common-sense about it, but monkeying with individual frames, changing them for dummies when the honey harvest is on, and changing back again when the honey harvest is over, involves more meddling with the bees than I think is good for them. My ideal of bee-keeping is to have a brood-nest which shall be a kind of family home, undisturbed from year to year, all the surplus operations, whether by extracting or section-boxes, being carried on in the top-story. Will any advocate of contraction tell me what advantage there is in cleaning out all the stock and store of honey each year, and not permitting any quantity of old honey to remain in the hive from one season to another? Bees are provident creatures, and I believe it is a comfort and satisfaction to them, and an encouragement to increase and multiply, to be assured at all times that they are in possession of an abundance of stores.

Questions AND Answers

CONDUCTED BY

DR. C. C. MILLER, MARENGO, ILL.

[Questions may be mailed to the Bee Journal, or to Dr. Miller direct.]

Using Separators—After-Swarm Prevention—Extracted vs. Comb Honey.

1. Is it necessary to use separators with sections with full sheets of foundation, to secure straight combs?
2. Will giving the old colony a young, fertile queen prevent after-swarms? and is it necessary to cut out queen-cells before introducing?
3. How much more extracted honey per colony can be secured by furnishing them with empty combs, than comb honey in sections with full sheets of foundation?
4. Where can sweet clover seed be obtained?
Tacoma, Wash. W. S.

ANSWERS.—1. That depends. If you are producing only a few combs for home use, or for a home market, then you can do very well without separators. If you are shipping to a distant market, then it will pay you well to have separators. Whole sheets of foundation will not prevent the sections bulging in such a way as to make trouble about packing for shipment.

2. If you don't cut out queen-cells there will be much danger of swarming after you give the new queen. If you cut out all queen-cells you'll make a pretty sure thing of it. But please remember that it's a difficult thing for even an old hand to make sure that he has missed no queen-cells.

3. I don't know. Nearly every one will agree that more honey will be stored in the combs, but as to *how much* more, there is by no means close agreement. Some say twice as much, and some say half as much more. Perhaps both are right. You'll only know just how it is with you after you've tried a considerable number of both kinds side by side for more than a single year.

4. Watch advertisements.

Sweet Clover for Forage and Honey.

I, like yourself, am very much interested in the growing of sweet clover, whether or not we can profitably use it for stock feed. About the only thing that I fear is, that on ac-

count of its early and rapid growth it would have to be cut early in June—a time that hay of any kind is hard to get dry enough to put into the mow. It takes dry weather and hot sunshine to dry clover of any kind, and sweet clover at this early date will be very sappy, and it will take probably some time to get it sufficiently dried. To cut it later (say June 20), I fear would be too late. Would it not be too coarse at the later date, and too woody?

Now, I want to say, Doctor, that I have not the least bit of doubt about my cattle and horses eating the hay if gotten up in good shape, though its flavor is altogether different from that of Alsike, white, red, alfalfa or crimson clover. I am inclined to think that there might be some difficulty in obtaining a stand when sown with oats, barley, or wheat. Do you think a good stand might be had if sown in the corn, at the last plowing, or would the corn shade sweet clover too much? I sowed some Alsike in the corn last summer, and obtained a fine stand, and it is just as strong as that sown early in the spring, with oats. I harvested a fair crop of honey from Alsike in 1894, while others away from Alsike pasture secured almost nothing at all. Something certainly should be done to improve our source of nectar. Sweet clover is just the plant that will fill the bill—that is, for later honey—if farmers can grow it profitably.

Do you know where the seed can be had cheap? How about the people that grow it in the South? Let us get the seed as cheap as possible, and let us as bee-keepers and farmers grow a few acres. Would not that be the proper thing to do? I have kept an eye on sweet clover for 12 years, and it has never failed to secrete nectar, and to interest the bees from early morn till late at night. From what I am able to learn of it, dry seasons make no difference. F. C.

Delmar, Iowa.

ANSWER.—There's no doubt about the difficulty of curing sweet clover early, and that's one objection my brother-in-law makes to it, that it can't be cured. But considering its value as both a forage and honey-plant, it might perhaps pay to cut it quite early—say the middle of May—letting it rot on the ground if nothing better could be done with it, then at the usual haying-time it would be in good shape to cut and make. But mixed with timothy and clover I've had it cure quite well, and make fair hay at the usual haying-time. Of course there is the objection that at that time it has quite woody stems.

I can't answer about sweet clover in corn at last plowing, but I doubt if it would work. It needs, I think, the whole of the first season to grow to be ready for the second year's blooming. If it could be sown at the last plowing, and the seed not come up till the spring following, then it would be all right, but in that case it wouldn't bloom till the second year after sowing.

I used to think that about the only way to get a good stand was to sow on pretty hard ground, and let the seed be tramped in by stock as it is on the roadside. I'm now inclined to think a better way is to sow thickly, or, perhaps better still, have a stand self-sown, then early in the spring plow about six inches deep. It will then give a crop of hay first year of fine quality with no coarse stems whatever.

I'm with you in thinking the time is past for discussing sweet clover as a honey-plant. Especially in a dry season when everything else dries up it shows its great value. The thing to discuss is sweet clover as a forage-plant, its value and best management.

I don't know anything about where to buy, but I think there never has been so much call for it as at the present time, and this ought to call out advertisements from many who have it to sell. Last season the seed became so scarce that there was none on the market, and it had to be imported.

Management for Best Results—Changing Size of Frame.

1. I have 20 colonies of Italian bees in the 8-frame dove-tail hive, which I wish to run for comb honey next season. How can I get the best results—by putting on the sections as soon as the bees are getting crowded, or by letting each colony cast one swarm? Or by dividing each colony once, and giving each queenless half a laying queen?

2. I wish to change frames in my hives, from the Langstroth to a frame 11½ inches deep, outside measure, and top and bottom bar the same as I now have on my Hoffman frames, Langstroth size, and placing a rim 2¼ inches high under my hives. Now, can I nail a stick ¾-inch square lengthwise through the frame, so as to keep the comb from breaking out? Or would it be better to wire my frames and use full sheets of foundation. The Langstroth frame is not

deep enough to winter bees on the summer stands. To winter my bees on the summer stands is worth more to me than the standard frame.

3. Is such a hive and frame as good for comb honey as the Langstroth frame, by taking out two outside frames, or by leaving in the 8 frames, which are equal to 10 Langstroth frames? P. W.

Hobbie, Pa.

ANSWERS.—1. In any case you will probably do well to put on supers as soon as the bees begin to store from the main harvest, or a little sooner. There might be no great difference between a colony divided by yourself and one swarming naturally, but there is this difference in favor of the natural swarming, that if you don't divide, some colonies might refrain entirely from swarming, and give better results than if divided either naturally or artificially.

2. You can do either way, and except for the expense it is probable that you will be better pleased to use the full sheets of foundation.

3. You can only decide that for certainty by carefully trying the two side by side. It may be you would find very little difference. One objection, however, to a hive with one or two frames left out, is that over the part that has no combs you will find the bees not working so well in supers.

Drones in Winter—Moving Bees.

I have 15 colonies of bees that I started with last spring. I got no surplus honey from them, and most of them have sufficient winter stores. I winter my bees out-doors.

1. There is one colony that shows considerable drones when taking a flight. What may be the cause?

2. I wish to move my bees about 100 feet, when is the best time to do this? F. P. P.

Geneseo, Ill., Jan. 10.

ANSWERS.—1. When drones are found present in winter there is ground for suspicion that the bees are queenless, but bees never do anything invariably, and it may happen that now and then a colony may have drones when everything is all right with them. The only thing to do is to let them alone until spring, and then if you find no brood present, or only drone-brood when all others have plenty of worker-brood, you may decide that they have no queen worth having, and break up the colony, uniting it with others.

2. Late in the winter, and yet before their first flight in spring. At the recent convention in Chicago, M. M. Baldrige gave a new suggestion as to moving bees a short distance. Move them in the middle of the day when most bees are flying—move the whole business at once, and set up a board before each hive. If obliged to move bees after they have commenced flying in the spring, his plan may be good, but in your case there probably will be no difficulty as to moving before spring flight.

Section Starters—Wiring Sections—Fastening Starters in Sections—Queen-Cells and a Colony with Laying Workers.

DR. MILLER.—1. I am very much pleased with your idea of a *bottom* starter in sections.

But will you kindly say just what size and shape the starters should be, both as regards top and bottom, or that you prefer? And do you use "thin" or "extra thin" foundation?

I have been thinking, how would it be to wire sections, using No. 34 wire, and having two parallel wires, at right angles with the starters? No tacks needed, but the ends just twisted together on the top-bar, and a little printed slip pasted on each section directing the consumer to withdraw the wires by untwisting the ends, or else severing the wire at one side, and drawing it through on the other; this would not necessitate 1/20 of the labor required to get at the contents of a sardine tin, or many other canned edibles. I venture to think that such a section—filled, of course—might travel the world around, and stand the roughest imaginable usage by boat, rail or road without breaking down. What do you think?

Some may raise the objection that if the wires were to run from top to bottom—*i. e.*, at right angles with the starters—they would be in the way of pressing the latter on by the use of the Parker' foundation fastener. Then run them parallel with the starters, or else adopt some other method of fixing the starters.

And this brings us to the question—and which I take the liberty of suggesting might very well be made a leading one,

for the greater lights to reply to—viz: Which is really the best—i. e., the easiest, safest or most efficient, cleanest and most expeditious—method of attaching starters, to either frames or sections?

Speaking from experience, this is a source of much worry and vexation of spirit to the novice. When I first started in the bee-business I invested in a so-called "wax-melter"—a sort of a miniature copper tea-kettle with an inside or double lining, and a thin, tapering double spout; it was always getting clogged up, the wax congealing at the point just when I was about to begin operations. One day the wretched contrivance boiled dry, the solder, as well as the wax, melted, and it collapsed, disintegrating into about 20 distinct pieces. Inwardly I was glad of it; for only its prettiness had made me bear with it so long.

The plan I next adopted—one I had read of in the American Bee Journal—was pressing the foundation on with a warm chisel; but neither did I find this very satisfactory; but what I often did find, as a result of it, was starters lying at the bottom of the hive. If too many bees got on them at once, the starters had a nasty way of letting go. This drove me to trying the camel's-hair brush way; I used it for a long time, but in the end I found it too messy, and so I cast about for something better.

I then adopted the plan of raising the melted wax from the pot by means of a goose-quill, pressing my finger on the upper end when full, and conveying it to the frame—held sloping—raise my finger, when a nice little trickle runs all down the starter—and all is lovely. Finding this a success, no time was lost in substituting little taper pipes made of very thin sheet copper (tin will do) for the quills. These beat the camel's-hair brush all to fits! If there is a better plan, pray let us know of it. I greatly doubt whether there is. In adopting this metal pipe arrangement, the wires (in the sections) are a decided advantage, as they hold the starter nicely in position until fixed. Of course, the wires must be placed true in the center, or the starters won't be true. But with a simple gauge and a lead-pencil, one can mark 1,000 in an hour, and then little children can do the wiring; and if wired sections will travel safe every time, where a considerable proportion of unwired ones break down, then the extra work of wiring is not worth talking about.

2. The bee-books and papers teach us that bees will not accept queen-cells when there are laying workers in the hive. Does this agree with your experience?

Lately I made a colony queenless, with a view to rear queens; upon examination a few days after, I found they had two queen-cells sealed, though there was ample evidence of the presence of laying-workers—one unfinished queen-cell having no less than eight eggs in it. How is this to be reconciled with the above statement? S. A. D.
South Africa.

ANSWERS.—1. For sections, I've always cut starters square, both top and bottom, as wide as can be conveniently worked in the section, and that's about $3\frac{3}{4}$ inches; bottom starter about $\frac{1}{4}$ -inch deep. At one time I thought I'd like to have them deeper, but after trying it I found they tumbled over with their own weight. The top starters I've made deep enough to almost touch the bottom starters. So you see I fill the section about as full as I can. Some experiments I made last summer with brood-frames inclines me to believe that possibly I might better cut the upper starter shallower, so as to leave a space of perhaps half an inch between the two starters. But it may not work well.

I hardly like "extra thin" foundation in sections, and if I used it for the upper starters I certainly would want something heavier for the bottom starters.

I'm a little afraid there would be prejudice on the part of customers against wire in sections, as it would suggest that the bees had had just that much less to do with the business. Besides, when a section is firmly fixed at the bottom and top—as it must be with bottom starters—I'm not sure that the wire is needed. My sections go hundreds of miles with never a break.

Compared with the camel's-hair brush your plan of fastening sections is a grand improvement, but I cannot help wondering that you have never tried the "Daisy fastener," the Clark or the Gray. I think the Daisy is the best of the lot, and away ahead of any plan of fastening with melted wax.

2. I think the books and papers do not put it down as a rule without exception, that where laying workers are present no queen-cell will be accepted. Certainly they are not justified in so doing, for sometimes cells will be accepted all right, especially if the case has not progressed any great length of time. Laying workers are very vagarious little torments, and do all sorts of things. Sometimes they are even found in a hive after a young queen begins to lay—at least I have read

so, although I think I never had such an experience myself. I think the safest thing to give to a colony with laying workers is a young queen that has just hatched, or one just ready to hatch that you pull out of a cell. Simply putting such a young queen on a comb among the bees has so far succeeded with me in every case.

Building Up Colonies in Spring.

How can we build up colonies best in the spring?
Syracuse, N. Y.

F.

ANSWER.—That isn't a very easy question to answer. Perhaps, too, the same answer wouldn't fit all cases alike. If every thing is all right with the previous treatment—plenty of stores the previous fall, and plenty of bees—very likely nothing better can be done than just to let the bees alone.

If there is any scarcity of stores, see to it that the deficiency is supplied in season so that the bees will never have a feeling that there is any necessity to economize. After they begin to fly in the spring—if you are in a region where there comes a time when there is an utter dearth of pasturage and yet good weather for bees to fly every day—breeding may be kept up by feeding. Not only feed honey or sugar syrup, but also some substitute for pollen, as ground oats and corn, or some other grain.

Some advocate packing the hives in spring, and some think it isn't a good thing. Perhaps you can decide for yourself by trying both ways side by side, trying only a few in the new way. If there is much empty room in the hive, you can close up with division-boards, giving the bees only what room they need, although some experiments made in France seem to indicate that a comb full of honey is about as good as a division-board.

Whatever you do, don't try to build up weak colonies by giving them brood and bees from stronger colonies. For although the weaker colony will gain by it, that gain will be more than counterbalanced by the loss of the stronger colony. Rather take from the very weak and give to those that are of medium strength. Indeed, it isn't a bad plan to break up entirely the very weak ones, and unite them with the stronger, then later in the season you can more than make up your number with what the strongest can spare.

Beeswax Questions—Extracting Honey—How to Put on a Super.

1. How can I keep beeswax from sticking to wooden molds when molding in small cakes for market?

2. How can I make wax of a nice, clear, light color?

3. How is snow-white wax made?

4. How long is honey left in the cells by the bees before it is sealed over?

5. What is the best extractor for me to get for extracting about 100 pounds late in the fall?

6. Is extracted honey drawn from the extractor and put into small bottles for market, or is it strained through cloth to make it clear?

7. This is a very important question with me: How to put on extra supers in the summer without getting stung unmercifully. The way I do is to blow a little smoke in at the entrance, then lift the old super a little and blow smoke in, then lift quickly off, set it on top of the new one, and then put both on top of the hive.

G. C. B.

Bridgewater, Mass.

ANSWERS.—1. Having the molds thoroughly soaked with water before putting wax in them will probably accomplish the object.

2. There is, of course, a difference in wax in the first place. That made from cappings of new comb will be lighter than that made from melting up old black combs. But even from the latter can be made a nice article of yellow wax. Be careful that it isn't heated too much in separating the wax from the slumgum or refuse, and to make sure of this there is probably no better way than to melt it in a sun extractor. The secret of making it clear is in letting it cool very slowly so that all impurities have plenty of time to settle slowly to the bottom. A very large quantity is likely to be clearer than a small quantity, because the large body is a long time in cooling. If you have only a small quantity, you can make it cool more slowly by having a large quantity of water with it. One good way to have it cool slowly is to put it in the oven of a cookstove just before letting the fire die out for the night. Of course, it should be put in long enough so that it will all be thoroughly melted before the fire begins to die out, and care

must be taken not to overheat it. Just as soon as you think it safe to do so—which will be about the time the fire begins to die down—close the door of the oven and leave the wax till the next morning, when you go to make the fire. Of course, you must take out the wax before you make the fire, and to help you remember be sure to put the stove-handle at night in the oven. Then you'll open the oven door to get out the stove-handle in the morning, and can't forget to take out the wax.

3. Very new comb will make white wax, or you can bleach yellow wax by means of light, the same as you bleach anything that is bleachable.

4. I don't know. I don't think there is any set time. Generally it will be sealed about as soon as evaporated enough to be ready to seal, but sometimes quite thin honey is found sealed.

5. If you mean just for the one extracting, it will hardly pay to buy an extractor at all, but you probably mean to extract some each fall, and in that case a 2-frame extractor is all you need. I'm not familiar with all the styles of extractors, but almost any of them are probably good.

6. Both. It can be taken right from the extractor, but a cloth can be attached to the extractor so it is strained as it leaves the extractor.

7. Your plan is excellent. I never found any trouble, however, in first putting on the empty one and then setting the full one on it.



CONDUCTED BY

DR. J. P. H. BROWN, AUGUSTA, GA.

[Please send all questions relating to bee-keeping in the South direct to Dr. Brown, and he will answer in this department.—Eds.]

Increasing the Depth of Simplicity Hives to Correspond With a Greater Depth of Frame.

I have some bees in the S-frame dovetail hive, and I wish to make the frames two or three inches deeper. How can I do it?
T. G. B.

ANSWER.—My friend, take my advice and let the frames alone—don't change the depth. If you *must* change, nail on strips to the top edge of the hive, of the necessary width; but rather than have a botched job, you had better get new hives to suit the depth of your frame.

Getting Bees to Work in Sections—Doubling Up—Hiving Swarms and Feeding.

DR. BROWN:—I have received several letters of inquiry from beginners, asking how to produce comb honey in the Simplicity hives. I use this hive, but have not been successful, and have been told the hive was the cause. My bees do not go into or work much, however, in the sections. Will it be asking too much for you to give your plan of management? How do you hive the swarms, with all the frames in below? When do you put on the sections above, and when do you take them off? Do you manipulate the frames during the honey-flow? Do you practice "doubling," and when? Do you "contract," and how? Do you buy queens? and have you been successful in introducing them? When do you feed, and how? Is there any use in feeding when bees seem to be bringing in stores of some kind?
W. F.

ANSWERS.—I do not think the style of hive you mention is the cause of your bees not working in the sections. You must look for other causes—most likely, either the colonies were not strong enough in worker-force during the honey-flow, or the flow was too limited in amount for any surplus. Now and then we meet colonies apparently in good condition, and in strength compare with others that are working in supers, that refuse to go into the surplus department. In such cases I endeavor to entice above by inserting sections filled with comb and partly-filled with honey, if I have such. If they

still refuse, I may contract the brood-chamber by removing a frame or two, so as to force them up. But this plan encourages swarming, which is not desirable when working for comb honey.

If the hive is a 10-frame one, I place the swarm in with all the frames in position. When full sheets of foundation are used I alternate them with empty frames, or preferably with frames with comb already worked out. But never use a frame without a triangular comb guide, or a starter of foundation. The super should not be put on till the bees got well established in their work below, which may take three or four days.

If you have sections partly-filled with honey to place on the hive, then it may be best to hive the colony with only starters of foundation in the brood-frames.

There is no need of disturbing the frames in the brood-chamber during the honey-flow.

It is frequently necessary to double up and contract small colonies in the fall.

While I rear queens, I frequently buy, and have no trouble to successfully introduce them.

In early spring bees frequently bring in loads of pollen, but can gather very little honey, breeding goes on rapidly, and the supply of honey may soon be exhausted. Such colonies must be watched, and, if necessary, fed until they can gather enough honey from natural sources.

My advice to W. F. is to purchase a standard work on bees, and not only read it, but study it, and apply its teachings practically to the hive.

T Supers and Pattern Slats.

On page 807 (1895) Peter Schartz gives an article on T supers and pattern slats, setting forth his reasons for using the former and discarding the latter. From his statements it appears to me that the reason, in a nut-shell, is simply this: He knew how to use the one, and did not know how to use the other. This is very often the case—we condemn a thing because we do not know how to use it.

I use both the T super and the pattern slats, and I think I like the slatted case the best. May be if I knew better how to use them I would like them better.

In order that the readers may know why I think I like the slats best, it will be necessary to tell how they are made:

My hives are 14 inches wide, inside measure, top-bars 19 inches long, with no bee-space above. The T tins I use are 13 inches long, so I made my cases 17x13¼ inches, inside measure. I nail a strip of wood 5/16x¼ inch across the ends of the case for the sections to rest upon, and pieces of the same material one inch long at the sides for the T tins to rest on. When 28 sections, with separators, are in this case, it is full, with no room for a "follower." They are very nice to handle, but they are too short to cover the frames, and the sections are hard to get out. I use a strip of waxed cloth to cover the ends of the frames at the rear end of the hive.

I make the slatted cases the same length and width as the hives, and cut a groove in the ends of the case to receive the slats, leaving a bee-space below. The slats are put in before the last side-piece is put on, so that they cannot come out, but can be moved so as to properly adjust them when the sections are in. The sections are keyed up with followers at one end and one side.

If it be desired to remove all the sections at once, take out the wedge, cover them with a board made to fit the top of the case, place your fingers on the ends of the board, your thumbs underneath the case, and turn it top side down.

One objection I find to the slats is, they remove the sections one step further from the brood. C. C. PARSONS.

Bessemer, Ala.

Back Numbers.—We have on hand a few back numbers of the Bee Journal for 1895, which we will mail to any one wishing them at 15 copies for 20 cents. They will all be different dates, but we have no complete sets for the year. Just send us 20 cents in stamps or silver, and we'll send you 15 copies. No doubt there are many new subscribers who will be glad to take advantage of this offer. All new subscriptions now begin with Jan. 1, 1896.

The McEvoy Foul Brood Treatment is given in Dr. Howard's pamphlet on "Foul Brood; Its Natural History and Rational Treatment." It is the latest publication on the subject, and should be in the hands of every bee-keeper. Price, 25 cents; or clubbed with the Bee Journal for one year—both for \$1.10.

OLDEST BEE PAPER IN AMERICA

THE AMERICAN BEE JOURNAL

ESTABLISHED IN 1861

PUBLISHED WEEKLY BY
GEORGE W. YORK & COMPANY,
 Editors and Proprietors,
 56 Fifth Avenue, CHICAGO, ILL.

REGULAR CONTRIBUTORS:
 G. M. Doolittle, of New York. Prof. A. J. Cook, of California.
 Dr. C. C. Miller, of Illinois. Dr. J. P. H. Brown, of Georgia.
 J. H. Martin, of California. Rev. E. T. Abbott, of Missouri.
 Chas. Dadant & Son, of Illinois.

\$1.00 a Year—Sample Copy Sent Free.

[Entered at the Post-Office at Chicago as Second-Class Mail-Matter.]

Vol. XXXVI. CHICAGO, ILL., FEB. 6, 1896. No. 6.



The **Illinois Convention Report** is omitted this week on account of more of it not getting here from the reporter in time. We hope, after this week, to complete it as rapidly as possible without any further break.

Don't Get Uneasy if you do not see your contribution in the next number of the Bee Journal received after you send it in. At this time of the year we are always crowded with certain kinds of matter, but intend to accommodate as many as possible and as fast as we can. So if you don't see your letter or article in the Bee Journal as promptly as you would like, just remember there is a good reason for it, and that in all probability it will appear in due time.

Mr. J. W. Young's Apiary, on the first page this week is certainly a very neat one. He tells about himself and his bee-keeping experience in the following few paragraphs:

FRIEND YORK:—My first interest in bees began in 1840, when I found a swarm on our farm. I hived them, and from that time to this I have been a crank on the honey-bee. I have studied its habits, and secured all other information obtainable, and will cheerfully admit that I lack being posted on all points.

My method of bee-culture does not agree with the general reports. I have paid out \$600, besides time, and I am still in the field. In 1870 I got the idea of frame hives, and that year I had 1,800 pounds of comb honey, and increased from 18 colonies, spring count, to 37. Then we had no foundation or starters. My frames 18x12 inches, entirely too deep.

I have two lots 25x125 feet for my apiary, planted to peach and boxelder, 12 feet apart, which gives a solid shade. The hives front to the east. I keep about 40 colonies of bees on hand, not for profit, but for pastime. I am 63 years of age, and will devote the balance of my time to reading the American Bee Journal and studying the "little, busy bee."
 J. W. YOUNG.

Reliable Commission Dealers.—Gleanings is trying to do some very commendable work in the line of getting honey commission houses or firms to agree not to adulterate honey themselves, or handle any that is adulterated. We extract these two paragraphs from an editorial by Editor Root referring to the subject:

We are getting all the commission houses to send us an affidavit to the effect that they will neither adulterate honey with glucose or any other inferior sweet, nor will they handle any adulterated honey of any sort if they know it. So far, nearly all have subscribed to the statement. Three or four have not yet responded, but we suppose they will when they get around to it. At all events, the list will be simmered down strictly to those who will agree under affidavit to handle only pure goods.

This was done, not because we doubted the integrity of the

honey-men who furnish the quotations so much as because we desired to weed out any who might hesitate to give us the required affidavit. And then, too, it gives them *all* notice what we expect of them. If any of them should be discovered dabbling in honey-adulterations after they had given us their sworn statement, don't you see we should then be in a position to learn what their oath meant in court?

We should be glad to know that such "affidavits" would do any good in the way of the prevention of honey-adulteration, but we haven't much confidence in them. Any firm that would so criminally demean itself as to adulterate honey with glucose would undoubtedly be quite willing to sign the affidavit. Such people don't know what a conscience is, neither do they care to do right so long as it is more money in their pockets to do the other thing.

But we do not believe that the great adulterators of honey in Chicago, or any other city, are the commission firms, by any means. While a few of them may stoop to such nefarious work, we think the bulk of it is done by the wholesale grocers, and those who mix up and fix up the vile table syrups of questionable composition which they palm off on a public that have almost ceased to be suspecting—except when it comes to honey. Many city people have so long abused their helpless palates and stomachs that they are now without the ability to discriminate between the good and the bad in the line of sweets. Then, again, many seem to think if they can get a heap very cheap it will "fill up" just as fast as if they paid more for a better quality.

While we don't want to discourage anything in the line undertaken by Gleanings, yet we can't help feeling that the commission men might as well be asked to sign an agreement that they will be honest, and not take such miserable advantage of the honey-producers as some of them do. And this leads us to say that just recently one Chicago honey-dealer bought of another, a lot of fine white comb honey for only 10 cents a pound! Some good extracted was sold at 4 cents, and some other fair comb honey for 8 cents. Now, we'd like to know how much the shipper or producer is going to get out of those prices, after deducting freight, cartage, and 10 per cent. commission!

We have been told more than once, the past two or three months, that honey-dealers can buy honey of some other dealers right on the same street, for *less* money than they would have to pay to the bee keepers who ship it in! Do you say, "How can that be?" 'Tis easy enough. When a bee-keeper sends his honey to an unreliable commission firm, he is at the mercy of that firm; they can sell the honey for just what they please, and then turn over to the bee-keeper the amount less high freight, higher cartage, and highest commissions. There you are.

We think, what bee-keepers need is a honey depot in every large city, in charge of a reliable man, who will do his best to create a demand and uphold the honey market, instead of putting in his time mainly in criminally "holding up" bee-keepers "for revenue only."

The Ontario Convention, held at Brantford the middle of January, we understand was well attended, and great interest evinced in the proceedings.

Death of Mrs. Lyman C. Root.—The sad intelligence reaches us of the death of Mrs. Libbie Quinby Root, only daughter of Moses Quinby, and wife of Lyman C. Root, which occurred at her home in Stamford, Conn., Jan. 16, 1896. Mrs. Root was stricken with paralysis on the morning of the 15th, and died the following morning. Mr. P. H. Elwood, of Starkville, N. Y., wrote us as follows about her:

Mrs. Root was a woman of rare intelligence, and had she given her attention to literary pursuits, would have gained celebrity. She was an easy writer of choice English. Bee-keepers knew her as literary editor of the book, "Quinby's Bee-Keeping," and later of the same as revised by her husband. The sketches from which the engravings were made for these books were also from her pen. She was a natural artist, and in drawing or painting from Nature displayed genuine artistic talent.

Her highest ambitions centered in her home, and in the education of her daughters. No matter how busy with household duties, or in the entertainment of visiting bee-keepers, time was found for the daily lessons of the girls, and also for reading and discussing with the family the best books and literature. In thus giving her life so unselfishly to the improvement of others, her own character developed by the maturing of those qualities of mind and heart that must endure forever. It is gratifying to be able to state that her husband and family fully appreciated her many excellent

qualities. Her presence, her sympathy, and her counsel will be sadly missed in the home circle.

Bee-keepers everywhere in the English-speaking world, will unite with me in extending heartfelt sympathy to the husband, the daughters, and to the aged Mother Quinby. P. H. ELWOOD.

We are glad to publish the foregoing tribute to the memory of Mrs. Root. We feel sure that those who knew her exceptional personal qualities and character must miss her greatly. While building for Eternity, she also built for others. What better monument than that of a lustrous, loving life? Only such is worth imitating.

"Dry Weather Vine" Honey.—A sample of this honey has been received from Mr. J. C. Wallenmeyer, of southern Indiana—also some of the seed, which somewhat resembles thistle seed, as it has a sort of balloon attachment, making it easily carried by the wind. Mr. W. says that "dry weather vine" grows from seed sown in spring, and after once planted always reseeds itself, increasing with wonderful rapidity. He thinks one vine has thousands of little blue flowers, and the hotter and drier the air, the greener the plant becomes. It starts blooming in July, and continues till frost.

The sample of honey kindly sent us was gathered in August, 1894, during a very heavy flow in a severe drouth. Mr. W. says he got \$22.50 worth of honey from one colony in three months, mainly from this source. He extracted only from thoroughly capped combs. We have sampled the honey, and find it of excellent body and flavor, reminding us greatly of heart's-ease honey. We do not think it compares, however, with pure alfalfa honey in any way, though we have no doubt many people would like it well. So far, of all the different kinds of honey we have tasted, we much prefer the thick, rich, white alfalfa. The best we have seen came from Colorado, though we presume in other localities where the alfalfa abounds, they have just as good honey as in Colorado.

We suppose the peculiar name—Dry Weather Vine—is simply a local one. Will Mr. Wallenmeyer please tell us the botanical name?

Bee-Escape for Honey-Room Windows.

—The Porter bee-escape is so well and favorably known, that whenever it is mentioned all bee-keepers know at once all about it. But those enterprising people have gotten up some new use for it, or a new escape for a new purpose, and in a recent issue of *Gleanings*, they described it as follows:

Having quite a quantity of honey to extract during the excessively hot weather of last September, when no nectar was to be had, and robbing was at its worst, and knowing too well how ineffective cone escapes used on extracting-room windows or escapes, made by extending the screen wire to a considerable extent above them with a bee-space between it and the sides of the building were for excluding robbers at such a time, to enable us to get through with the work without annoyance we made, for this purpose, the escape shown in the accompanying illustration. This escape is a modification of the well-known form of the Porter spring escape, now so extensively used for freeing the surplus honey from bees automatically before removal from the hives, the principle used being the same. It differs from that only in the details of construction necessary to adapt it to this particular use.

The top, or oval part, is perforated along the edges, so that the escape may be readily tacked to the casing or window-frame. The body is made of perforated tin, to admit light; and its open end is extended into a cone to prevent robbers crawling in at the sides of the springs and interfering with the bees passing out, which would occur if it were left open full width. As compared with the other form, the interior part is reversed in position; the springs used are somewhat broader, and set slightly more open.

The method of applying these escapes to the window is almost too apparent to require explanation. Merely make $\frac{1}{2}$ or $\frac{3}{4}$ inch holes through the screen wire at its upper corners; or, in case it is desirable to make holes without injury to the wire cloth, thus leaving it so that it can be replaced when the escapes are removed, if desired, remove the tacks from the corners and turn them down till triangular holes of corresponding size are formed, and then tack the escapes in a vertical position over these openings, so that the bees can pass

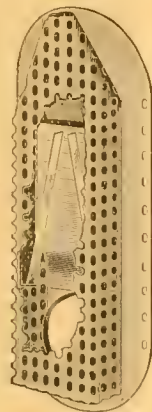

through them into the escapes. In case the window is provided with an escape made by extending the wire cloth above it, close the bee-space with a strip flush with the top of the window, and proceed as before. If escapes are not to be used on all the windows of the honey-room, preference should be given to those opening to the south or west, so that, on cold days, the bees may have the benefit of the afternoon sun.

After putting these escapes to the severest possible test under the most trying conditions, we have found them to meet all the requirements of a perfect device for this purpose. Since using them we realize as never before how many of the disagreeable features of bee-keeping are removed, and how much pleasure and satisfaction are added to the pursuit by having all windows of honey and extracting rooms supplied with escapes through which all bees that get in when doors are being opened or closed, or in any of the other ways these persistent little insects have of effecting this end, can pass out easily and rapidly, and not a single robber can enter.

R. & E. C. PORTER.

It is almost needless to say that these new escapes will be sold by all the principal supply dealers, though The A. I. Root Co. control the sale of all Porter bee-escapes in this country.

That "Free" Bee-Book.—On page 56 we mentioned that "Gleanings for Jan. 1 made favorable mention of Government Bulletin No. 1, entitled, 'The Honey-Bee; a Manual of Instruction in Apiculture, by Frank Benton;' and that the "price" is "15 cents per copy." Shortly after the notice was published, Dr Miller wrote us thus:

MR. EDITOR:—On page 56 you speak of "A Free Bee-Book," and then say it would be ready for distribution "at 15 cents per copy." Is that straight, or is it a mistake? Gleanings, from which you quote, says nothing about "15 cents." I made application for the book, and if you're right, I want to hustle that 15 cents on to Washington. C. C. MILLER.

We can best answer the Doctor's question by quoting the following paragraph from the circular notice about the book referred to which we received *after* we had seen what Gleanings had said in regard to it:

"'The Honey-Bee: A Manual of Instruction in Apiculture,' by Frank Benton, M. S., of the Division of Entomology of the department of Agriculture, is just issued. . . This Bulletin, which is No. 1, new series, of the Division of Entomology, has 119 pages, 12 plates, and 76 text figures. The edition is limited by the law of Jan. 12, 1895, to 1,000 copies. This is barely sufficient to supply the libraries on the Department's list, the agricultural colleges, and those to whom the Department is indebted; a limited number, however, will be disposed of by the Superintendent of Documents, Union Building, Washington, D. C., at 15 cents per copy."

It was our mistake in calling it a "free" book. That part of the item was put in type *before* we learned of the charge for it, and we overlooked it when changing the reading further on from "free" to "15 cents." Remember that the Supt. of Documents will not receive stamps or personal checks. We sent a dime and a nickel.



Honey-Boards or Non-Burr-Comb Top-Bars.

In the American Bee Journal, Query 999, this question is asked: "To prevent burr-combs, is anything as good as the Heddon slatted honey-board? If so, what?" Of the 24 who answer, 4 give it as their opinion that there is nothing as good; 17 think there is something just as good, and better. Of this number some lay stress upon exact bee-space, and generally $\frac{1}{4}$ inch, and not over that, and others on thick and wide top-bars in connection with exact bee-spaces. Only three of the entire number—that is, out of the 24—express themselves as not being competent to speak on the subject.

When this question was propounded a few years ago in the same journal, and in the same department, a great major-

ity expressed themselves as being in favor of the slatted honey-board. The tables now seem to be pretty nearly turned in favor of top-bars and bee-spaces as against the slatted boards; but I notice that none of the respondents strike upon this point—that the honey-board does away with *only one* set of burr-combs between the slatted board and the super. Between it and the brood-frames below, if the old-fashioned spacing is used, and narrow top-bars, there is the usual set of burr-combs. By the use of thicker and wider top-bars, and a bee-space of $\frac{1}{4}$ inch, we do away with practically *all* the burr-combs. It seems there is no comparison between one system and the other. The slatted honey-board only *half* does the work, and the other system does it *all*, or practically so.—Gleanings.

Amalgamation.

A union of the North American Bee-Keepers' Association, and the National Bee-Keepers' Union, seems quite evident and eminently desirable. There is indeed a "broad field of labor" for such an organization, and, I opine, hundreds of dollars waiting only for the announcement that the union has been effected, to pour into the treasury. My dollar is ready.—H. E. HILL, in American Bee-Keeper.

Bees and Grapes.

Mr. Bonart, of this county, has a large vineyard on the same ranch, and the vineyard is not injured by the bees. Mr. B. says that one year, when the grapevines were in bloom, there was a continuation of "northers" that kept the bees from working upon the whole vineyard. Only that portion nearest the apiary was worked thoroughly; and when grapes ripened, this portion of the vineyard had the most grapes. Still, there are people who will complain when a bee looks at a grape.—RAMBLER, in Gleanings.

Winter Food and Packing.

E. France says in Gleanings: "The article, by J. A. Green, is excellent. His ideas of an abundance of feed for winter just suit me, as my motto is that a great deal too much honey is just enough. I don't want to feed bees in the spring if it can be avoided. It doesn't do any harm if the bees have a few pounds left over. I believe all who winter outdoors in the North agree that the hives must have thick walls, or double, filled in with chaff or some other packing. I see that Mr. Green packs four hives together to winter, and puts a large box around the four packs inside of the large box, around the single hives. I think it would be less trouble for him to use a quadruple hive, without side packing. He would then have his four colonies ready at any time for winter by filling the top chamber with straw, or putting on top cushions. That is the way we do it. It is just as good, and saves lots of hard work. I see he also uses sealed covers. So do we."

Feeding Back.

I have had considerable experience in this direction just how much does not matter, but I could give some figures showing the actual results of some experiments that I have made that would look very flattering. Some of my experiments in feeding back have been profitable and some have not. Those which have not I think are in the majority. Of course, I am better prepared now to avoid the mistakes and blunders that have made this work unprofitable; but I am not as enthusiastic over this subject as I once was. If *properly conducted* and the *conditions are favorable*, without doubt it might be made profitable *in the right hands*; but with the average bee-keeper I am sure it would result in disappointment and loss.—H. R. BOARDMAN, in Review.

Amount of Stores for Winter.

Besides having winter stores in place early, emphasis is put upon the matter of having not only enough, but an abundance of stores—not only stores to last through the winter, but to last through the critical time from the first flight in spring till the main harvest begins. Here, however, there is some conflict of opinion. B. Taylor is convinced "that bees winter better with just enough always accessible honey in their hives to feed them safely until warm weather." Whether his belief is correct or not, I feel pretty sure that in practice he gives his bees more than he thinks they will use before warm weather, if by "warm weather" he means the time of taking out of cellar; for there is a difference of several pounds in the amount different colonies use; and as he doesn't know beforehand which will be the heavy consumers, he must in his winter preparations consider all heavy consumers. If he gives all enough so that he feels *sure* they will have enough until first spring flight, some of them will have enough to carry

them through until the harvest. Whether it is best to have such an abundance in the hive that no colony will need any looking after until the main harvest, is one of the things that may well belong to that "further discussion." Whether my own theory agrees with his or not, my practice agrees at least so far that it is with me a very comfortable thing to know that I have some extra combs of honey ready to be given to any colony that may ask for it before the harvest.

As to the manner of ascertaining the amount of stores, not much is said—the little that is said inclining to the opinion that the colonies are weighed "with the eyes," as J. E. Crane expresses it—that is, by looking in the hive at the frames. Considering the uncertainty of this, unless every frame is carefully inspected, and that even then it's a hard matter to come within several pounds of the exact weight, I can not help thinking that most would prefer to weigh their hives if they knew how easy a thing it is. With a spring-balance properly rigged you can weigh the hives with less time and labor than you can take out and inspect the frames. And then there's a comfortable feeling in the thought that you *know*, and that there's no guess about it. True, you'll not know to a certainty just how much honey there is in the hive, but you will know for a certainty the total weight, and from that you can make a safer guess as to the amount of stores than in any other way.—DR. MILLER, in Gleanings.

Feeding for Profit.

Many bee-keepers must change their location, go to the flowers, or change their methods of management. The bee-keeping public says at present, and perhaps always will say, that sugar-honey must not be produced, but there is no objection to bees living on 4-cent sugar instead of 15-cent honey. It has been estimated, and I think fairly, that a colony of bees consumes 60 or 70 pounds of honey during the year. If a good portion of this can be cheap sugar instead of high-priced honey it may make all the difference between a fair profit and a serious loss.

A change to a better location is preferable, if a change can be made, as there is more profit in plenty of honey from natural sources than in exchanging sugar for honey in a poor locality; but there are many in the latter kind of locality who can't well change their place of residence but can still keep bees at a profit, if not so large a one, by pursuing tactics similar to those followed by our practical friend of East Townsend, Ohio.—Review Editorial.

Temperature for Queen-Cells.

The atmosphere ought to be about 80° when we are transferring the larvæ. Our work is so rapidly done that we have successfully manipulated our grafting-plan with the temperature at 65°. Only a few moments, and it is all done. I will say five minutes is as long as we expose the larvæ for grafting 20 cells. Mr. Doolittle's plan is slower than ours, as it is quite tedious to take and replace the larvæ. Any day from April 1st, to Nov. 1st is all right for this work here, unless it is raining.

Ripe queen-cells may be exposed a short while, say an hour or so, in a temperature as low as 65°. There is more danger of the weather being too hot here in summer, than too cool, for such work. A ripe queen-cell (or any other) exposed to the sun's rays a few minutes, will be ruined. In either grafting or removing ripe cells, you will be safe to expose the larvæ or cells a short while in a temperature from 65° to 80°.—Southland Queen.

Dampness and Temperature of Cellars.

I believe dampness in winter repositories is one of the agencies in causing bee-diarrhea, only when the temperature is so low as to condense the vapor on the inside of the hives and combs. It would be well to consider the difference in effect on animal life, between a warm, damp atmosphere and a cool damp one, in all our talk in the matter of cellar-wintering. But, unless that front end of the cellar is well covered with earth I should fear too low a temperature during cold spells in winter. I should be much more concerned to have the temperature entirely in my control, than about dampness. Give me a cellar that will not vary from 45°, and good stores, and I have little fear as to how the bees will come out in the spring. This I say after many years of successful cellar-wintering, and after watching others who have invariably wintered their bees well also.—G. M. DOOLITTLE, in Gleanings.

Every Present Subscriber of the Bee Journal should be an agent for it, and get all others possible to subscribe for it.

THIRTY THOUSAND POUNDS BEESWAX

Is our present stock for this year's sales of Foundation. But still **We Want More Beeswax** and pay a good price.

Don't Delay Ordering Your **FOUNDATION**. You will pay more by and by than you would now. Remember that we make the **BEST**, and everybody acknowledges this.

Now is the time to read the work of the **Late Father Langstroth**—

Langstroth on the Honey-Bee, Revised.

The Price of this Work is now Reduced from \$1.40 to \$1.25, by mail.

Send us your address for Catalogue of Bee-Supplies, etc.

CHAS. DADANT & SON,

Mention the American Bee Journal.

HAMILTON, Hancock Co., ILL.

INCUBATORS

WE WARRANT

THE RELIABLE



To hatch 80 per cent of the fresh and fertile eggs. Hundreds of recent testimonials! Have this year (1896) issued our Eleventh Annual Poultry Guide and Combined Catalogue in one valuable book.

PROFITS IN POULTRY!

This 148-page, fully illustrated Poultry Guide tells you about profits in poultry; about hatching eggs with machines; about brooding chicks without hens. We have for sale sixteen popular kinds of thoroughbred fowls; also full line of Poultry Supplies—anything you want. Price of Guide, 10 cents in stamps—worth one dollar. Address, **RELIABLE INCUBATOR AND BROODER CO., Quincy, Ill.**

CHEAP SECTIONS! CHEAP SECTIONS!

We have at this Branch among the Stock purchased of Thos. G Newman the following stock of Sections—not of our manufacture—which we desire to close out to make room for our

Superior Extra Polished Sections.

In order to close them out quickly we offer them for the next 60 days, or while they last, at these special prices:

White Sections, 4¼x4¼.	Cream Sections, 4¼x4¼.
40,000 1 15-16 } 1,000 for \$1.75	10,000 1 15-16 } 1,000 for \$1.25
50,000 1½ } 2,000 for 3.00	20,000 1½ } 2,000 for 2.00
80,000 7-to-ft. } 5,000 for 7.00	1,000 7-to-ft. } 5,000 for 4.50

With all orders for less than 5,000, add 25 cts. for cartage.

These Sections are of Wisconsin manufacture, and when made were doubtless considered as good as the best; but as compared with our Extra Polished Sections they are not up to the standard of to-day, but a decided bargain and should be closed out quickly at these very low prices. If you prefer a sample before ordering we will mail one for 5 cts. to cover postage.

The A. I. Root Co., 56 5th Ave., Chicago, Ill.

250,000 Peach Trees



- 100,000 Plum, best European and Japan.
- 150,000 Pear, Standard and Dwarf.
- 75,000 Cherry, Morellos, Hearts, etc.
- 150,000 Apple, Quince, Apricot.
- 100,000 Nut Bearing Trees.
- 2,000,000 Small Fruits and Grapes.
- 750,000 Roses, Everblooming and Hardy.

1,000 Car Loads Ornamentals.

Full supply Flower and Vegetable Seeds, Plants, Bulbs, etc. **Elegant 168 page catalogue free.** Send for it before buying. Everything mail size postpaid. Larger by express or freight. Safe arrival and satisfaction guaranteed. We occupy 1½ miles on the bank of Lake Erie. No harder, healthier trees are grown on the continent. Why not procure the best direct from the grower and avoid all commissions. It will save you money.

42nd YEAR. 1000 ACRES. 29 GREENHOUSES.

THE STORRS & HARRISON CO., Painesville, O. Box 223

The Patent Wood Veneer FOUNDATION has no sag in full sheets. **EXTRA THIN** Foundation 13 square feet to the pound. Working Wax into Foundation—if sent to me—a specialty. Send for prices, samples & Catalogue. Wax wanted. **AUG. WEISS** HORTONVILLE, WIS. 2A5t

For Sale—A Bargain.

119 Colonies of Italian Bees in Chaff Hives. Good House, and 2 acres of Land, with excellent well of water. **E. L. CARRINGTON.** 5A4t **PETTUS, Bee Co., TEX.**

Mention the American Bee Journal.

General Items.

Another Way to Number Hives.

In regard to numbering hives—I think I have a better way than any of the experts. I take a large, soft graphite pencil, and put the number on the left hand upper corner of the rear end of the hive; there they will not get rubbed out by handling the hive. In the fall, after all moving of hives is over for the season, I paint the numbers over with white paint, and number them. When an old colony is removed to a new stand, the date is put on it, and the number shows where it came from. Also, the date of the swarm is marked on its hive. There are no loose tags to move or take care of. Waterville, Ohio. **LEWIS EASTWOOD.**

Mr. Stolley's Sweet Clover Article.

FRIEND YORK:—Allow me to thank you and Dr. Miller for bringing Mr. Stolley, of Grand Island, Nebr., to the stand, and giving us such valuable evidence in favor of sweet clover. I was much pleased with the way Mr. Stolley wrote up all about it. I have seen Mr. John McArthur's bees, at North Toronto, storing large quantities of sweet clover honey when the bees in other parts of the Province of Ontario were starving for the want of something to gather honey from. **Wm. McEvoy.** Woodburn, Ont.

Longevity of Queens.

On July 1, 1884, I received three queens from J. T. Wilson, of Kentucky. The first one died in 1888, and the second one in 1890; the third one is still living, and I have reared 43 queens from her this year. I have put her into winter quarters this year, apparently all right. In 1893 I had one of her daughters that was two years old, that became a drone-layer, and I had to dispense with her; a similar case occurred again in 1895.

There can be no mistake about this queen, as she has been in the same hive (No. 54) all the time, and has never swarmed. The right wing is clipped off angling. She could not have been superseded, as it would be a matter of impossibility. These bees are of no use to produce comb honey, but are good for extracted. They are easy to handle during the honey-flow, but as soon as it stops they become very cross, and hard to handle. Should this queen live through the winter, and come out all right in the spring, I will report again. **J. G. A. WALLACE.** Ontario, Canada.

Bees Did Very Well.

My bees did very well last year. I started in the spring with 7 good colonies, and I have 32 now, in good condition. I got about 500 pounds of fine honey. **JAMES JARDINE.** Ashland, Nebr., Jan. 3.

Sweet Clover, Alsike and Crimson.

I have just read with considerable pleasure Mr. Stolley's article on sweet clover, on page 806 (1895), but there are yet a few facts that we should know in regard to it.

1. Will it do to sow with oats in the spring? If so, can a crop of hay be cut the next year?
2. Is the hay good for milch cows? and do they do as well on it as on red clover?
3. Is there any tendency in the clover to slobber horses or cows, as white, or even red, clovers will do in wet years?
4. Will a common threshing machine thresh it? and what is the usual yield of seed per acre? What does it cost per bushel to thresh? Last spring I tried crimson clover, Alsike

also. I sowed with oats. I also tried them alone, without any other crop. With oats the crimson clover did the best, but if we had had some rain, and not so much frost, no doubt they would both have done better.

The crimson bloomed and made seed in the summer; fell down and made young plants in the fall. The old plants look well now, as though they would bloom out in the spring.

Where it was sowed alone they did much the best, but the labor of mowing three times and getting no crop, proved to me it was not the way to do.

White clover looks better than it has for years in this locality. The fall rains gave it a start, and these winter rains will, I think, insure honey from it in the spring.

Those who sowed red clover in this locality last spring have as good a stand and as fine a growth as I ever saw.

Cooksville, Ill. E. B. ELLIS.

Hive-Numbering Plan.

I am not satisfied quite with any explanation so far given as to numbering hives, and will therefore give my way of doing it:

I number the queen by placing the number on a board 4x6 inches, or any size desired. Put the same number on the back of the hive, and hang the board on a nail driven into the back of the hive. When I remove the queen for any cause, I take the board with her. If she comes out with a swarm, I remove the board with the swarm. I keep the record on the board, removing such as I see fit with my jackknife or plane.

When winter comes, and I wish to cellar my bees, I gather all the boards into a box, put them away, and in the spring there is no trouble to tell where they belong, by the corresponding numbers on hive and board.
Glendon, Iowa. O. P. MILLER.

Mountain Laurel Honey.

In the Bee Journal of Dec. 26, 1895, I noticed in an extract from the New York Sun, the report that a family in Trenton, N. J., was poisoned from eating mountain laurel honey. I am much surprised at the statement, inasmuch as I have kept bees for 15 years, and they have had access every season to hundreds of acres of mountain laurel, and I have never known or heard of any one being made sick from eating the honey secured in this locality.

Tracy City, Tenn. I. L. PARKER.

A Fruit-Man that Values Bees.

After having read the Bee Journal more or less for a year, I must say that it fills the bill more to my satisfaction than does that of nearly 16 papers I take on other subjects. I have 30 colonies of hybrid bees, 5 of pure Italian, and two 5-banded, and three that are 3-banded. I will test them all the coming season, when I shall increase them largely. My honey returns have been very satisfactory the past summer. Fruit is my main industry. After next season I will have 40 acres in orchard. I am somewhat amused at seeing some of our horticultural

papers fighting the bee-keepers. I consider bees one of the grandest and best helps we have in this valley. Without them we would not have nearly the amount of fruit that we do. We have about 10,000 colonies of bees in this valley, principally hybrids. Next Saturday we will organize a bee-keepers' association—the first in this valley—for our mutual protection.

JAMES U. HARRIS.
Grand Junction, Colo., Jan. 1.

The Season a Failure.

The past season has been a failure here. I had 40 colonies of bees last spring, and lost all except 23, which I put into winter quarters very light in both bees and honey. I did not get a pound of surplus honey the last season.
JESSE B. LEWIS.
Westons Mill, N. Y., Dec. 19, 1895.

Arranging the Hives.

Query 998 suggests the idea, and though it be of but little or no interest to others, I will give my plan of arranging hives:

Place them in pairs with the backs within two inches of each other, and the entrances 10 inches apart, giving 2½ to 3 feet between the pairs.

Another row with the entrances in the opposite direction, can be placed just to the back of the first, and no two very near each other, fronting exactly the same way.
Creek, N. C. W. H. PRIDGEN.

Report from N. W. Pennsylvania.

The past season was a complete failure as to white clover or basswood honey. Buckwheat was the largest of large redeemers this year, for it gave us a large surplus and plenty for winter. The story will be told this winter, whether buckwheat honey is good to winter bees on.

Never since I have kept bees—11 or 12 years—did the prospect for a large honey crop look so promising as last spring, but, alas! Jack Frost spoiled it all. Bees, last spring, filled the brood-nest with honey; colonies were very strong, but had nothing to do but consume their stores. There were but few early swarms, but in August—hello! but didn't they swarm?—and sting? Never were bees so cross.

Last Friday (Dec. 13) we had zero weather, but to-day it is thawing, and the snow nearly gone.
GEO. SPITLER.
Mosiertown, Pa., Dec. 18, 1895.

A Beginner's Experience.

My three colonies are in chaff hives—two in old-fashioned chaff, and one in a new dovetail chaff hive. I started with one colony last May. I got two. I hived and drove the others back as they swarmed. I got about 10 pounds of surplus comb honey in shallow extracting-frames. They would not work in the sections. I tried all ways to induce them to. Some I put some brood in one section. It hatched out and went below. The three hives were full of bees and 30 or more pounds of honey in the brood-

THE OLD RELIABLE
PEERLESS FEED GRINDERS



Grinds more grain to any degree of fineness than any other mill. Grinds ear-corn, oats, etc., fine enough for any purpose. Warranted not to choke. We warrant the Peerless to be **THE BEST AND CHEAPEST MILL ON EARTH.** Write us at once for prices and agency. There is money in this mill. Made only by the **JOLIET STROWBRIDGE CO., JOLIET, ILL.** Jobbers and Manufacturers of Farm Machinery, Carriages, Wagons, Windmills, Bicycles, Harness, etc. Prices lowest. Quality best.

Mention the American Bee Journal. 34A26

POULTRY



WHITE FACED BLACK SPANISH

40 Standard Breeds Illustrated & fully described in my new Poultry Book. Reliable information for poultrymen & intending buyers. Good stock Ducks & Geese; also Shetland Ponies. Send 6c in stamps
E. H. COCK, Box 27, Huntley, Ill.

Mention the American Bee Journal. 4A13t

WANTED.
10,000 pounds of BEESWAX, for Cash. Address, **LEAHY MFG. CO., Higginsville, Mo.**

PATENT WIRED COMB FOUNDATION
Has No Sag in Wood-Frames
Thin Flat-Bottom Foundation
Has No Fishbone in the Surplus Honey.
Being the cleanest is usually worked the quickest of any Foundation made
J. VAN DEUSEN & SONS,
Sole Manufacturers,
Sprout Brook Montgomery Co., N. Y.

1896 SAVE MONEY 1896

If you want first-class **ITALIAN QUEENS** FOR BUSINESS, Foundation at Wholesale Prices, Hives, suited for the South, or **SUPPLIES**, send for Price-List—to
J. P. H. BROWN, AUGUSTA, GA.

NEW MAMMOTH
Poultry Guide for 1896 - Finest book ever published, contains nearly 100 pages, all printed in colors, plans for best poultry houses, sure remedies and recipes for all diseases, and how to make poultry and gardening pay. Sent post paid for 15c. John Bauscher, Jr., box 94 Freeport, Ill.



49A13t Mention the American Bee Journal.

WOVEN WIRE FENCE

Over 50 Styles

The best on Earth. Horse high, Bull strong, Pig and Chicken tight. You can make from 40 to 60 rods per day for from 14 to 22c. a Rod. Illustrated Catalogue Free. **KITSELMAN BROS.,** Ridgeville, - Indiana.

48Etf Mention the American Bee Journal.

SEE THOSE EYES!
LARGE PROMINENT EYES are not desirable in a potato. Our World's Fair Potato has very small eyes. Order of us and get pure, genuine Stock. Price way down. We have about every valuable variety. Egg corn, oats, barley, garden seeds. L. L. OLDS, Clinton, Rock Co., Wis.



Got Something for Nothing !

Did You ? Thousands of readers answering my ad. in the past received free by mail at a cost of 20 cents to me, a package of my discovery, VITE ORE, and 90 per cent. have written to thank me and send cash order for more, declaring that it had done them more good than all doctors and man-made remedies they ever used. I scorn to take any one's money until convinced at my expense that V.-O. is the best thing in, on, or out of the earth for all who suffer from ills no doctor or drug will cure, such as general debility, feebleness from overwork, worries, cares, protracted sickness, old age, female complaints, all kidney and membranous ailments. It is the only natural, Nature's cure for human ills ever offered to man, and not by a quack doctor or methods peculiar thereto. If you have been bamboozled often, and grievously, by robbers in the medicine business, I am not responsible therefor, but am if V.-O. fails to give greater satisfaction than all else you ever tried. Send the addresses of six sick people and I will do the balance.
THEO. NOEL, Geologist, Tacoma Building, Chicago, Ill.

California

If you care to know of its Fruits, Flowers, Climate or Resources, send for a Sample Copy of California's Favorite Paper—

The Pacific Rural Press

The leading Horticultural and Agricultural paper of the Pacific Coast. Published weekly, handsomely illustrated, \$2.00 per annum. Sample Copy Free.

PACIFIC RURAL PRESS,
220 Market St., - SAN FRANCISCO, CAL.
Mention the American Bee Journal.

WANTED TO EXCHANGE — Phonograph, spring motor, and 40 Records, for 200 lbs. Foundation Sections, or Bee-Hives. Write to me. BERT W. HOPPER, Elmo, Mo.



OUR POULTRY ANNUAL and Book of Valuable Recipes, 64 large pages, contains 8 beautiful colored plates of fowls, gives description and prices of 45 varieties, with important hints on care of poultry, and pages of recipes of great value to everyone. Finest Poultry Book published for 1896. Postpaid only 10 cts. C. N. Bowers, Box 24, Dakota, Ill'

52A1 *Mention the American Bee Journal.*

FOR ADEL BEES AND QUEENS

Address, **HENRY ALLEY,**
6Ctf WENHAM, MASS.

IF YOU WANT THE BEE-BOOK

That covers the whole Apicultural Field more completely than any other published. send \$1.25 to Prof. A. J. Cook, Claremont, Calif., for his

Bee-Keeper's Guide.

Liberal Discounts to the Trade.

WANTED!

10,000 pounds of BEESWAX, for Cash. Address, **LEAHY MFG. CO.,** Higginsville, Mo.
Mention the American Bee Journal.



SUCCESSFUL INCUBATOR

Our magnificent new catalogue giving full information regarding artificial Hatching & Brooding and treatise on poultry raising sent for 4c stamps. Circular free.

49A13t *Mention the American Bee Journal.*

FOR SALE.

ALSIKE, CRIMSON, ITALIAN, ALFALFA, or WHITE CLOVER SEED.
4A8t **WM. CRAIG,** Luce, Mich.

WANTED—200 Colonies of Bees and 4-FRAME NUCLEI, on Simplicity or Hoffman frames, in exchange for Supplies, to be shipped either from here or Medina, Ohio. Send for Catalog to—**GEO. E. HILTON,**
4E4t FREMONT, MICH.
Mention the American Bee Journal.

TAKE NOTICE!

BEFORE placing your orders for SUPPLIES, write for prices on 1-Piece Basswood Sections, Bee-Hives, Shipping-Crates, Frames, Foundation, Smokers, etc.

PAGE & LYON MFG. CO.
NEW LONDON, WIS.
Mention the American Bee Journal.

nest for winter, on 7 to 8 frames. The comb in some old frames is 3 inches thick, and full of honey. I have good, new wheat chaff packed in the sides of the hives, and burlap cushions 6 to 8 inches thick on top, a Hill's device over the frames, and a double thickness of good, clean burlap over that, then cushions on that. The ground is thrown up to make a low ridge so that water will run off. Two scantlings 2x4 are on the ground pinned down with long pegs to keep the wind from turning the hives over. The hives are on them, and tacked fast with nails at each corner. The hives are tipped up about two inches towards the front, all facing the south, and about 30 feet from the southeast corner of my house, to break the northwest wind from them. All are young queens of last summer and fall. The old one was superseded last fall by a little young thing. I sent and got a fine selected tested queen, and took her out; I have her in the house with a few bees in a little hive with glass on two sides, with two frames made of a shallow extracting-frame cut in two. They are all right to-day, 10 degrees below zero, and a north west wind blowing a gale. She sings for us quite often. I am going to try to keep her till spring. Her mother was four years old, very large, and almost black.

My bees are all Italians, but the old queen's family was always cross, and very bad to handle, or, in fact, to go near. The others are nice and gentle. That is why I sent for a new queen to take the place of the "young lady." I thought she would be cranky, too, because her mother was rearing such a miserable, quarrelsome lot of young ones.

All this may not be interesting to others, but I wanted to tell my first experience with bees. I am going to succeed if possible. I like it, and want to learn it. This is no place for bees, but I can learn it here, and then go where it is better for them.

S. M. STAFFORD,
Bloomfield, Nebr., Jan. 2.

More of Numbering Hives.

I have the numbers painted on the hives so that they are seen a distance of 50 to 100 feet. It is no difference to me if the numbers become mixed, for all the use I have of the numbers is to denote any hive. Suppose No. 3 swarms out, and next No. 49, and next No. 30, and so on. The numbers in this case serve to show me which colonies are swarming, so that I may give my attention to the right hives; and also to denote which hives I should give attention to either in the way of queens or other work.

S. M. CARLZEN,
Montclair, Colo.

Report for Last Season.

I will give my report for last season, as I think it is pretty good for Minnesota. I had 25 colonies, spring count, increased to 66 colonies, and took off 1,425 pounds of comb honey; average per colony 56 pounds.

L. A. STICKNEY,
Plainview, Minn., Jan. 4.

The Best Way to Market Honey.

Count me one more in favor of 10-frame hives for extracted honey. Three years ago I bought a lot of colonies in 10 and 8 frame hives. I had 5 or 6 in the 8-frame, but one by one they are discarded, so there is only one left, and that will go next spring.

I have kept bees 16 years, have now 100 colonies in three apiaries, and produced 7,000 pounds or more of extracted honey in 1895. I expect to sell it all in my neighborhood. I sell mostly to grocers, in pint Mason jars. I found that the best selling package yet. I go around once in a week or ten days. I usually leave the honey to be sold; the grocers make 5 cents profit on each pint. Some few prefer to pay cash down when received, then I take 15 cents less on a dozen. When it candies before it

Honey-Clovers & Buckwheat SEED FOR SALE.

We have made arrangements so that we can furnish seed of several of the Clovers and Japanese Buckwheat, by freight or express, at the following prices, cash with order:

	10lb	50lb	100lb
Alsike Clover Seed.....	\$1.35	\$ 6.25	\$12.00
Sweet Clover Seed	1.25	6.00	10.50
White Clover Seed.....	2.40	11.35	22.00
Alfalfa Clover Seed....	1.20	5.25	10.00
Crimson Clover Seed....	1.00	4.00	7.00
Jap. Buckwheat Seed....	.45	1.50	2.20

Prices subject to market changes.

The above prices include a good, new two-bushel bag with each order.

We guarantee all Seed first-class in every respect—in fact, THE BEST that can be gotten. Your orders are solicited.

GEORGE W. YORK & CO.,
CHICAGO, ILLS.

COMB FOUNDATION WHOLESALE and RETAIL.

Are you going to buy Foundation for Cash, or have you Wax to sell or trade for Foundation and other Supplies? Have you 25 lbs. or more of Wax that you want made into Foundation? If so, do not fail to write me for samples and prices. I make a specialty of working up Wax by the lb., and do it very cheap during the winter. Beeswax wanted at all times.

GUS DIETTER, AUGUSTA, WIS.
Reference—Augusta Bank. 16Atf

Mention the American Bee Journal.

SPRAYING

WILL PRODUCE PERFECT FRUIT.

Our illustrated catalogue tells you HOW and WHEN to spray—mailed Free to fruit Growers and Dealers. The largest and best line of Spray Pumps and Nozzles in the world.

THE DEMING CO. Mfrs. Salem, Ohio.
Western Agency: Henion & Hubbell, Chicago.

Mention the American Bee Journal.

MUTH'S HONEY EXTRACTOR PERFECTION Cold-Blast Smokers,

Square Glass Honey Jars, Etc.

For Circulars, apply to CHAS. F. MUTH & SON, Cor. Freeman & Central Aves., Cincinnati, O. Send 10c for Practical Hints to Bee-Keepers.

HATCH Chickens BY STEAM—With the MODEL EXCELSIOR Incubator

Simple, Perfect, Self-Regulating. Thousands in successful operation. Lowest priced first-class Hatcher made. GEO. H. STABLE, Send 6c. for Illus. Catalogue. 113 to 122 S. 6th St. Quincy, Ill.

Mention the American Bee Journal. 3A8t

GIVING AWAY HIVES.

On all orders received before Feb. 15th for \$20.00 or over, we will send a "Half-Joint Hive," complete, ready for a swarm.

Send for '96 Circular.

I. J. STRINGHAM,
105 Park Place. NEW YORK, N. Y.

TRY US. We sell your Poultry, Veals, Fruits and all produce at highest prices. DAILY RETURNS. For details, prices and references, write F. I. SAGE & SONS, 183 Roade St., N. Y.

WHEN ANSWERING THIS ADVERTISEMENT, MENTION THIS JOURNAL.

ONE MAN WITH THE UNION COMBINATION SAW

Can do the work of four men using hand tools, in Rippling, Cutting-off, Mitring, Rabbeting, Grooving, Gaining, Dadoing, Edging-up, Jointing Stuff, etc. Full Line of Foot and Hand Power Machinery. Sold on Trial. Catalogue Free.

SENECA FALLS MFG. CO.,
46 Water St., SENECA FALLS, N. Y.
1Aly *Mention the American Bee Journal.*

MAKE A NOTE OF THIS!

ALL READY FOR 1896.



Appreciating the advantages for procuring Basswood Lumber, and the splendid Shipping facilities of Marshfield, we have established a Factory for the manufacture

THE ONE-PIECE SECTION.

We have all new and up-to-date Machinery for the manufacture of the "One-Piece Section." Have a Saw-Mill in connection with our Factory, enabling us to get the finest material to be had, for "One-Piece Sections."

Write for Price-List, and also for prices on Sections in any quantity you may want.

THE MARSHFIELD MFG. CO.,

MARSHFIELD, Wood Co., WIS.

Dec. 18 1895.

6Ctf

Mention the American Bee Journal.

PLANTS

TREES

All the leading varieties of choice plants and trees. Koonce Pear (frost proof) and other valuable sorts at popular prices. Send for descriptive Catalogue FREE.

PLEASANT VALLEY NURSERIES -- ARTHUR J. COLLINS, Moorestown, N. J.

is sold, I usually exchange it for liquid, whether it was paid for before or not. A uniform price is adhered to with all. I have it now in seven towns, in some 60 stores, or more.

I also sell some honey in bulk, peddling around to consumers. I use an old novice extractor-can, fixed on the back of my spring-wagon box, and carry along a platform spring scale to weigh on. I also sell considerable in pails, using the five sizes, from a pint to 10 pounds, and fill them so as to make the prices even money—15, 25, 50, 75 cents and \$1.00.

The price must be so as to correspond with such as generally obtain in your vicinity. I set my price as low as possible at the beginning of the season, and then stick to it clear through, regardless of what some small uninformed producer may sell his at.

I extract but very little uncapped honey—not more than one-fifth or one-sixth, consequently my honey is uniformly good, and that, with fair dealing, and a constant endeavor to be pleasing and obliging, I find after some years begins to tell, and pays. Utica, Ill. A. MOTTAZ.

Sells Direct to Consumers.

My report for 1895 is, 600 pounds of comb honey from 9 colonies, spring count, increased to 80. I have them in good condition for safe wintering. I sell my honey direct to the consumer, by the pound or the crate. I grade my honey in three grades, and sell at 10 cents, 12½, and 15 for fancy. I have no trouble to sell my honey. I took the premium at the Gentry County Fair.

J. E. ENYART.

McFall, Mo., Dec. 20, 1895.

Ten-Frame Hive Suits Him.

I have found out that 10 Langstroth frames in any kind of a hive that can be packed with very dry forest leaves, is all right for me. If the hives are large enough, you will not be bothered about swarming and its results. I transferred two colonies last spring, and they gave me 72 pounds of honey each, but did not swarm. Put on the sections and give the bees plenty of brood-chamber, and you will get the honey, by having plenty of bees to gather it.

F. A. SNYDER.

Shavertown, Pa., Dec. 23, 1895.

Dry Weather the Cause.

Bees in this locality did not store much surplus honey the past season, the dry weather being the cause. The lands through this section are all highly cultivated, no waste places for sweet clover, golden-rod, etc., to grow. The basswood is also nearly depleted, consequently the outlook for beekeepers is anything but encouraging, although we are all hopeful for another year. I would like to correspond with some bee-

keeper living in either eastern Tennessee, western North Carolina, southwestern Virginia, or western Georgia. If this should be read by any living in the localities named, they will confer a favor by sending me their addresses. E. B. FOSTER.

Oceola, Ohio, Dec. 23, 1895.

Results of the Past Season.

I started last spring with 7 colonies, increased to 21, and got about 300 pounds of comb honey. H. D. PHILPOT.

Humboldt, Nebr., Dec. 20, 1895.

CARLOADS

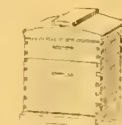

Of Bee-Hives, Sections, Shipping-Cases, Comb Foundation, and Everything used in the Bee-Industry.

I want the name and address of every Bee-Keeper in America. No reason why you cannot do business with me. I have Cheap Lumber and Experienced Workmen; a good Water-Power Factory and know how to run it. I am supplying Dealers as well as consumers. Why not you? Send for Catalogues, Quotations, etc. W. H. PUTNAM, 1D RIVER FALLS, Pierce Co., WIS.

Mention the American Bee Journal.

Barnes' Foot-Power Machinery.

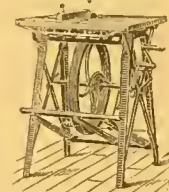

Read what J. I. PARENT, of CHARLTON, N. Y., says—"We cut with one of your Combined Machines, last winter 50 chaff hives with 7-in. cap, 100 honey-racks, 500 broad frames, 2,000 honey-boxes and a great deal of other work. This winter we have double the amount of bee-hives, etc., to make and we expect to do it with this Saw. It will do all you say it will. Catalogue and Price-List

Free, 45Ctf Address, W. F. & JOHN BARNES, No. 995 Ruby St., Rockford, Ill.

The RURAL CALIFORNIAN

Tells all about Bees in California.

The Yields and Price of Honey; the Pasturage and Nectar-Producing Plants; the Bee-Ranches and how they are conducted. In fact the entire field is fully covered by and expert bee-man. Besides this, the paper also tells you all about California Agriculture and Horticulture. \$1.50 per Year; Six Months, 75 cents. Sample Free.

THE RURAL CALIFORNIAN, 218 N. Main St., LOS ANGELES, CALIF.



Promptness Is What Counts!

Honey-Jars, Shipping-Cases, and everything that bee-keepers use. Root's Goods at Root's Prices, and the best shipping point in the country.

Dealer in Honey and Beeswax. Catalogue Free.

162 Mass. Ave. Walter S. Ponder INDIANAPOLIS, IND.

Honey & Beeswax Market Quotations.

CHICAGO, ILL., Jan. 18.—White clover and Linden comb honey is scarce and commands a premium over other grades of white of 1 to 3 cents per pound. There is a fair supply of other grades, which bring 12@13c. for white, and amber to dark ranges at 9@11c. Extracted is without special change; the Western ambers at 4½@5c.; white, 5@6c.; clover and basswood in cans and barrels, 6@7c. Beeswax, 28@30c. R. A. B. & Co.

CHICAGO, ILL., Jan. 20.—We are having good inquiry for fancy comb, but all other grades are selling slow. Dark comb will not sell on this market, and we would advise the producer not to ship it here. We are offering it as low as 9@10c. with no buyers. We quote: Fancy, 15c.; No. 1, 14c.; light amber, 12@13c. Extracted, light, 5@6½c.; dark, 4@5c. Beeswax, 28@30c. J. A. L.

PHILADELPHIA, PA., Jan. 3.—Honey has declined in this market during the holidays. Large lots of California honey arriving, and selling at 5c. in 60-lb. cans. We quote: Comb honey, fancy, 16c.; fair to good, 8@14c. Extracted, 4@5½c.; white clover, 10c. Beeswax, 30c. W. A. S.

BUFFALO, N. Y., Jan. 22.—Sales very light and market dull. We quote: Fancy white, 14@15c.; choice, 11@13c.; buckwheat, 7@9c. Extracted, 4@6c. Beeswax, 25@28c. E. & Co.

CINCINNATI, O., Jan. 22.—Demand is slow for comb honey, which brings 12@14c. for best white. The demand is fair for extracted honey at 4@7c., with a scant supply. Beeswax is in good demand at 25@28c. for good to choice yellow. C. F. M. & S.

KANSAS CITY, MO., Jan. 20.—The demand for comb and extracted honey is fair. We quote: No. 1 white comb, 1-lbs., 13@14c.; No. 2, 12@13c.; No. 1 amber, 11@12c.; No. 2, 8@10c. Extracted, white, 6@6½c.; amber, 5@5½c.; dark, 4c. Beeswax, 22@25c. C. C. C. & Co.

List of Honey and Beeswax Dealers.

Most of whom Quote in this Journal.

Chicago, Ills.

R. A. BURNETT & Co., 163 South Water Street.

New York, N. Y.

F. I. SAGE & SON, 183 Reade Street.
HILDRETH BROS. & SEOLKEN,
120 & 122 West Broadway.
CHAS. ISRAEL & BROS., 486 Canal St.

Kansas City, Mo.

C. C. CLEMOMS & Co., 423 Walnut St.

Buffalo, N. Y.

BATTERSON & Co., 167 & 169 Scott St.

Hamilton, Ills.

CHAS. DADANT & SON.

Philadelphia, Pa.

WM. A. SELSER, 20 Vine St.

Cincinnati, Ohio.

C. F. MUTH & SON, cor. Freeman & Central avs.

BASSWOOD TREES!

Orders booked now for Spring delivery for Nursery-Grown Basswood Seedlings

5 to 9 inches high, at \$2.00 per 100; 300 for \$5 or \$15.00 for 1000. Parties living east of the Mississippi river will be supplied direct from our Nurseries in Ohio. Satisfaction guaranteed.

A. H. FITCH, 702 Youngerman Bldg., DES MOINES, IOWA.
4Atf Mention the American Bee Journal.

Mr. E. L. Carrington, of Pettus, Bee Co., Tex., on another page offers for sale a small home and over 100 colonies of bees. Write him for particulars. He says it is a fine place to rear queens.

Write to Prof. Noel, who advertises "Got Something for Nothing" in this issue. If he fails to do what he promises, let us know.

A THOUGHT THAT KILLED A MAN!

He thought that he could trifle with disease. He was run down in health, felt tired and worn out, complained of dizziness, biliousness, backaches and headaches. His liver and kidneys were out of order. He thought to get well by dosing himself with cheap pills. And then came the ending. He fell a victim to Bright's disease! The money he ought to have invested in a safe, reliable remedy went for a tombstone. The thought that killed this man

HAS KILLED OTHERS.

Statistics show that 90 per cent. of the deaths from pneumonia, Bright's disease and similar complaints are caused from derangements of the liver and kidneys. These great organs keep the blood pure and in healthful motion. When they get out of order the blood becomes poisoned, the circulation impeded and the whole system speedily breaks down. It is

A DANGEROUS IDEA

to imagine that pills can strike at the root of these diseases. It has been thoroughly proved that such remedies are worse than useless. There is only one remedy which can always be depended upon. This remedy alone can act on the liver and kidneys when they are out of order, clear out the system and build up the health. The name of this remedy is Warner's Safe Cure. It is the only standard remedy in the world for kidney and liver complaints. It is the only remedy which physicians universally prescribe. It is the only remedy that is backed by the testimony of thousands whom it has relieved and cured.

There is nothing else that can take its place.

STRAWBERRY PLANTS FOR SALE.

Michigan Grown Plants are the Best.

BUBACH, PARKER EARLE, HAVERLAND, WARFIELD AND JESSIE.

Vigorous Plants of the above well-known varieties, shipped direct from the Nursery—Lake View Fruit Farm, Gibson, Mich. 100, \$1.00; 200, \$1.50, postage paid. Special price on large quantities. Address,

CHAS. N. TRIVESS, Manager,
635 Chicago Stock Exchange, - CHICAGO, ILL.
6E4t *Mention the American Bee Journal.*

Question-Box.

In the multitude of counsellors there is safety.—Prov. 11-14.

Doubling Up Colonies.

Query 4.—Do you make a practice of doubling up colonies at other times than fall? If so, why?—MICH.

Jas. A. Stone—No.

G. M. Doolittle—No.

Prof. A. J. Cook—No.

P. H. Elwood—Yes, in the spring.

Rev. E. T. Abbott—No; not at any time.

W. R. Graham—Sometimes, when I think it best.

Dr. C. C. Miller—I rarely double, spring or fall.

Rev. M. Mahin—I do not. I build up weak colonies in the spring.

J. A. Green—Not often. In fact, I seldom double up colonies at any time.

R. L. Taylor—Not except occasionally just at the opening of the honey season.

H. D. Cutting—At swarming time I sometimes put two or three small swarms together.

Chas. Dadant & Son—No, never; unless they are absolutely worthless and queenless.

B. Taylor—I double colonies all through the working season, as circumstances demand.

Mrs. J. N. Heater—No, sir. I sometimes strengthen weak colonies with brood from stronger ones.

W. G. Larrabee—Yes, I unite weak colonies in the spring that would be worthless as they are, to make one strong colony.

Allen Pringle—I do the doubling up whenever the reasons for doubling up are present, no matter what time of year it is.

E. France—We never practice doubling up colonies in the fall. If two colonies have only honey for one, kill one, and feed their honey to the other.

Dr. J. P. H. Brown—I do when necessary. "Why?" They may be weak nuclei—might swarm out. I don't want them to amuse themselves in this sort of fashion.

J. M. Hambaugh—While in Illinois I sometimes united weak colonies in the spring, in order to have populous colonies at the commencement of the honey harvest.

G. W. Demaree—It is sometimes profitable to put two colonies together in the spring if both can't be gotten ready for the early honey harvest. But I do not practice it much.

C. H. Dibbern—Yes, when I find a colony that is "petering out" when others are doing well, I destroy the queen and chuck in the first swarm that issues, or double up with some other colony.

J. E. Pond—Sometimes. I try, and intend to have all colonies in the fall that have satisfactory queens, strong enough to go through the winter. If there were bees enough to fairly cover three Langstroth frames, I should consider such a colony strong enough to go

through an ordinary winter. Given, a poor queen and two small colonies, I should unite.

Eugene Secor—No, except occasionally at swarming-time. I do that to keep the number of my colonies within control. Isn't the swarming season the best time to double-up colonies, anyway?

Mrs. L. Harrison—No, I do not, but I think a much greater yield of surplus honey could be obtained by taking brood from the weaker and giving to the stronger, in time for them to be on the boom for a honey-flow.



MONEY IN PEAS

IF YOU PLANT THE RIGHT SEEDS

My New Seed Book tells all about the best varieties of Peas and Everything of interest in the Seed Line; how to grow them for profit, etc. **FREE** if you send a postal to-day, mention this paper.

H. W. BUCKBEE
Rockford Seed Farms
ROCKFORD, ILLS.
P. O. Box 637

Mention the American Bee Journal.

Bees, Queens, Nuclei—We will sell, the coming season, 500 Two-Frame Nuclei, with a Choice Warranted Queen, at \$2.50 each. Special prices on large orders furnished. **LEININGER BROS.,** FT. JENNINGS, OHIO. 6E4t

Mention the American Bee Journal

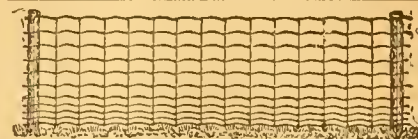

INFORMATION WANTED!

Anyone having knowledge of a general purpose wire fence, "just as good as the Page," will confer a favor by sending us full particulars. No hearsay evidence wanted, only actual tests count.

PAGE WOVEN WIRE FENCE CO., Adrian, Mich.

Mention the American Bee Journal.

WANTED—By a young man (23) a position in a good apinary, or apinary and small fruit or gardening business combined, preferably South and near this State, for the coming season. Has already had good experience with bees, and is willing, serviceable, and active. Would appreciate a good home and a generous employer. Is an experienced clerk, with good references. Address,

6E4t **C. C. DOORLY,** Alphin, Va.

WHEN ANSWERING THIS ADVERTISEMENT, MENTION THIS JOURNAL.

CALIFORNIA, "WAKE UP!"

The Pacific Bee Journal, devoted to the Protection and Advancement of Beekeepers' Interests on the Pacific Slope. 50 cts. per year. Send for sample copy.

THE BENNETT BEE-HIVE COMPANY

now make Foundation at 40 cents per pound. Bee-Hive Bodies (platin covers) 17½c. each. Common Bee-Hive, 2-story, 60 cts. each. Dovetailed Hives, \$1.00 each.

Sections and Supplies low. Send for Price-List, and **Save Money.**

365 E. Second St., **LOS ANGELES.**

Mention the American Bee Journal

Bottom Prices

**BRING US BIG TRADE.
GOOD GOODS KEEP IT.**

If you want the best supplies that can be made at a little less cost than you can buy the same goods for elsewhere, write to us for low prices. 1896 Catalogue now ready—ask for it and a free copy of **The American Bee-Keeper** (36 pages).

Address,
**THE W. T. FALCONER MFG. CO.,
JAMESTOWN, N. Y.**
Mention the American Bee Journal.

Wonderful Record.



17 Years with but one complaining letter.
I think Bingham Smokers and Bingham & Hetherington Honey-Knives are PERFECT. Write what you think of them, on a card, and mail to—
T. F. BINGHAM, Farwell, Mich.
4A4t *Mention the American Bee Journal*

HEADQUARTERS for ROOTS' GOODS

Can supply you with all the Fixtures used in an Apiary. Best Goods at Lowest Prices. Catalogue free. 5% discount until March 1st.
JNO. NEBEL & SON, High Hill, Mo.
Mention the American Bee Journal. 4Atf

The Rural Kansan

Is an Agricultural Journal for the busy farmer. It embraces Bee-keeping and every department of industry connected with the farm. 30 cts. a year, monthly. Sample Free.
A Full Line of **Higginsville Bee-Supplies** on hand.
CATALOGUE FREE.
HENRY L. MILLER,
355 Shawnee Ave., TOPEKA, KAN.
1A13t *Mention the American Bee Journal.*

Queen-Clipping Device.

I want the address of all who clip Queens and have even the least trouble either in catching or holding them while they are being clipped. I have invented a Device by which it is IMPOSSIBLE to injure a Queen either in catching or clipping, unless it is done purposely. With it they are caught and clipped any way desired almost instantly. One does not have to touch the Queen with his hands, whatever. Price, postpaid, 50 cts. Send for Free Circular. **C. MONETTE,**
6Atf CHATFIELD, Fillmore Co., MINN.
Mention the American Bee Journal.

BEES QUEENS
Smokers, Sections, Comb Foundation, And all Apian Supplies cheap. Send for FREE catalogue. **E. T. FLANAGAN, Belleville, Ill.**
6A26t Please mention the Bee Journal.

Golden Queens FROM—TEXAS.

My Bees are bred For Business as well as for Beauty and Gentleness.
Safe arrival and reasonable satisfaction guaranteed. Write for Price-List.
Untested, \$1.00—Tested, \$1.50.
J. D. GIVENS, LISBON, TEX.
Box 3
6A26t Please mention the Bee Journal.

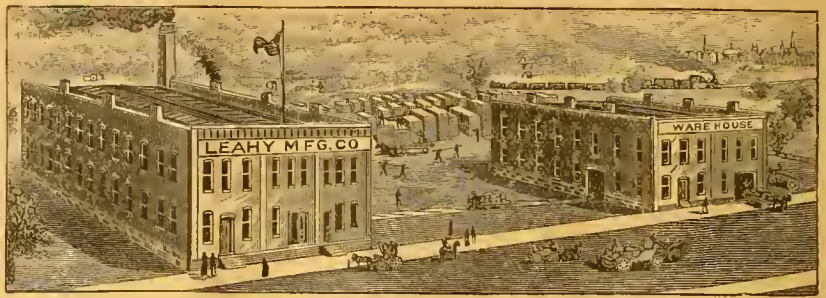

Largest Factory in the West COMPLETE STOCK. Good Supplies and Low Prices. Our Motto.

READ THIS—Mr. Keyes says: The 100 pounds of Extra-Thin Foundation you sent us is superior to anything he ever saw; and I think the same. **R. L. TUCKER, Wewahitchka, Fla.**
Dear Sirs:—The Sections came duly to hand. Indeed, they are very nice. Yes, sir; they are as good as the best. **CHARLES H. THIES, Steeleville, Illinois.**
Leahy Mfg. Co.:—I have received the bill of goods. I must say they are the choicest lot of Hive-Stuff I have ever received from any place. I admire the smoothness of your work, and your close selection of lumber. **Yours very truly, O. K. OLMSTEAD, Orleans, Nebr.**
Dear Sirs:—The Sections arrived in due time, and are all O. K. so far as examined. They are simply perfection. I can't see how you can furnish such goods at such low prices. I hope you may live long and do well. **Yours respectfully, Z. S. WEAVER, Courtney, Tex.**
Gents:—I received the "Higginsville Smoker" all O. K. It's a dandy; please find enclosed stamps for another. **Yours truly, OTTO ENDERS, Oswegatche, N. Y.**
Gentlemen:—I have bought Supplies from nearly all the large manufacturers by the carload, and I must say yours are as good as the best. Indeed, in many lines they are the best. It is a pleasure to handle them. **E. T. FLANAGAN, Belleville, Illinois.**
The above unsolicited testimonials are a fair sample of hundreds we receive. Our prices are reasonable and the "Higginsville Goods" are the best.
We are now manufacturing for each of the following parties a Carload of Supplies: **E. T. Flanagan, Belleville, Illinois; Charles H. Thies, Steeleville, Illinois; J. W. Rouse & Co., Mexico, Mo.; Henry Miller, Topeka, Kans.; Fulton & Gregg, Garden City, Kans.**
If you need a Carload of Supplies, or only a Bee-Smoker, write to us. Remember, we are here to serve you, and will, if you give us a chance. **A Beautiful Catalogue Free.**
Address, **LEAHY MANUFACTURING CO., HIGGINSVILLE, MO.**
49A *Mention the American Bee Journal.*

CASH PAID FOR BEESWAX

For all the good, pure yellow **BEESWAX** delivered to our office on or before Feb. 20, 1896, we will pay 26 cents per pound, cash; or 30 cents for whatever part is exchanged for Bee Journal subscription or books that we offer. If you want **cash promptly** for wax, send it on at once. Dark or impure wax not taken at any price. Address plainly,

George W. York & Co., 56 Fifth Ave., Chicago, Ill.

SECTIONS, BEE-HIVES, SHIPPING-CASES

We make a Specialty of these Goods, and defy Competition in **QUALITY, WORKMANSHIP AND PRICES.**
Write for Free Illustrated Catalogue and Price-List.
G. B. LEWIS COMPANY, Watertown, Wis.
Be sure to mention the American Bee Journal when you write.

* ROOT'S COMB FOUNDATION! *

We are pleased to announce that, having secured control of the new Weed process of manufacturing foundation for the U. S., we are prepared to furnish **Foundation by the New Process**, for 1896. Samples will be mailed free on application, and will speak for themselves.
OUR SANDED and POLISHED SECTIONS, well, they will speak for themselves, also.
Our 1896 Catalog will be ready for distribution now in a few days. Send in your name at once for catalog, samples of the new foundation, and those superb sections, and while you are about it ask for late copy of **Gleanings in Bee-Culture.**

THE A. I. ROOT CO., MEDINA, OHIO.
56 5th Ave., Chicago, Ill. Syracuse, N. Y.
1024 Mississippi St., St. Paul, Minn.

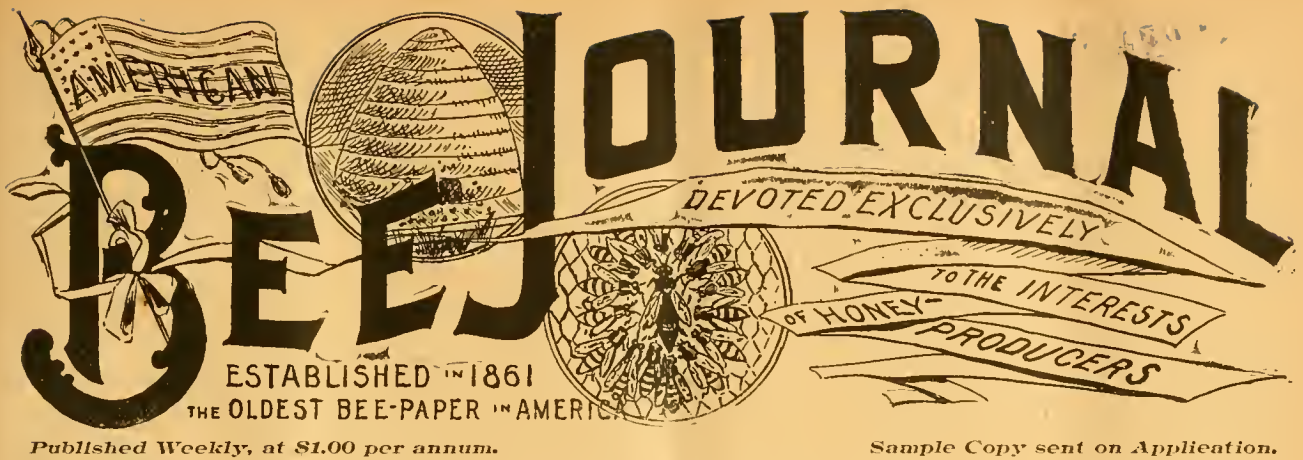

AMERICAN BEE JOURNAL

DEVOTED EXCLUSIVELY TO THE INTERESTS OF HONEY PRODUCERS

ESTABLISHED IN 1861
THE OLDEST BEE-PAPER IN AMERICA

Published Weekly, at \$1.00 per annum. Sample Copy sent on Application.

36th Year.

CHICAGO, ILL., FEB. 13, 1896.

No. 7.



Selling Honey on Commission—Farming.

BY EMERSON T. ABBOTT.

Let me give the bee-keepers who read the American Bee Journal a hint on the subject of selling honey on commission.

The entire commission business is founded on a false basis, and is contrary to sound business principles. *Do not ship honey, or anything else, to any one to be sold on commission,* is my advice. Think of employing a man to act as your agent, whom you have never seen, about whose business push and energy you know very little, and of whose facilities for placing goods you know comparatively nothing! This is surely not very sound business. You would not hire a hand to work on your farm or in your apiary under your direct supervision in this loose way. If merchants have facilities for selling honey, they know it. Then let them buy honey and pay a fixed sum for it, and it will be their own business when they sell it, *how much they get for it,* etc.

Did you ever think of the fact that you are loaning the man to whom you ship your honey that much capital to do business on? He does the business on your capital, takes out his pay, and gives you what is left. How many of you would loan an entire stranger that amount of money without any security? Not one. Why, then, furnish these men capital on which to transact business?

The commission business, like the miscellaneous credit business, is sure to prove very unsatisfactory in the end, and I am not sure but it should prove so to those who are so unbusinesslike as to encourage this method of disposing of goods. Most commission men are honest and honorable, in my opinion, but they are all doing business on a false basis. No man could buy (?)—get anything of me in that way. Sell for cash and get cash, and you will have no trouble about returns.

IS FARMING DRUDGERY?

On page 2, Mr. Thompson talks of the "constant round of work which is drudgery just because it is not specialty," and says it stultifies the minds of forty families out of fifty so that they cannot "regard the care of bees in any other light than that which one regards milking, cleaning stables or baking bread." Well, why should they? It is no more degrading to milk a cow or clean out a stable than it is to care for a colony of bees, or write a poem, for that matter. Any work can be made drudgery, and the most disagreeable work may become a certain source of enjoyment, if one will look at it in the right light. It is no more necessary to rise at unreasonable hours to succeed as a farmer or bee-keeper than it is to succeed as a lawyer or doctor. If farm life is so stultifying to man's intellectual life, why is it that some of our best and ablest men come from the farm? There is an intelligent way to milk a cow, clean a stable, hen-house or horse, as well as to make a loaf of bread. There is an education, too, in all

of this, if one only knows how to get it out. I know just what I am talking about, for I grew up on a farm, and have not gotten beyond cleaning my own hen-house, stable and horse yet, and the only reason I do not milk is, I do not have room for the cows. I find recreation in all of these things, and education, too; and, if it were not for them, I should soon have to cease all intellectual work. No, sir; no necessary work is drudgery unless we make it so. I commend to all who think the contrary the following, said to have been written by Mrs. Garfield to her husband:

"I am glad to tell you that, out of all the toil and disappointments of the summer just ended, I have risen up to a



Mr. Edwin Bevins, Leon, Iowa.—See page 101.

victory. I read something like this the other day: 'There is no healthy thought without labor, and thought makes the labor happy.' Perhaps this is the way I have been able to climb up higher. It came to me one morning when I was making bread. I said to myself: 'Here I am, compelled by an inevitable necessity to make our bread this summer. Why not consider it a pleasant occupation, and make it so by trying to see what perfect bread I can make?' It seemed like an inspiration, and the whole of life grew brighter. The very sunshine seemed flowing down through my spirit into the white loaves; and now I believe my table is furnished with better bread than ever before. And this truth, old as creation, seems just now to have become fully mine—that I need not be the shirking slave of toil, but its regal master, making whatever I do yield its best fruits."

No; I would not make a lot of "small specialists" on the farm, for here, if anywhere, "variety is the spice of life." The specialist is the narrow-minded man; he runs in one groove, he studies one thing, he lives in one atmosphere, he learns one kind of phraseology, and perforce of his being a specialist continuously turns out one grist. He may become an expert in some special line, he may get rich, but a broad-minded man, in sympathy with universal humanity, he never can be.

Then, how far shall the idea of a specialist be carried? Some have devoted their lives to the study of one language, but others have looked upon this as a great mistake. I have seen it stated somewhere that the last regret of a noted German philologist was that he had not confined the labors of his life to the *dativ case*. Such men have their work and place in the world, but the ordinary every-day work of life must be done, and, it is generally done, by those who are not specialists.

Children are crying everywhere because they are not provided with a delicious and healthy sweet like honey. If they are to have it, it must be produced on the thousands of farms all over our broad land. The farmer who devotes all of his energies to other things and owns his honey usually has none, as he generally thinks times too hard to buy honey; and so it comes to pass, that to heed the cry of those who would confine the production of honey to specialists is to rob thousands of the pleasure and health which is to be derived from the use of this delicious sweet three times a day, 365 days in the year. Honey-production belongs to agriculture. No specialty for me in this line.

St. Joseph, Mo.



Some Subjects Reviewed and Commented Upon

BY DR. C. C. MILLER.

CRIMSON CLOVER.—S. LaMont says, on page 78, that his four acres sowed to crimson clover in October, didn't come up, and from what he says I suspect he means to plow it up and sow again. Perhaps it might be worth while to let it alone just as it is. I know the general teaching is that it must be sown in the fall and get a start so as to live over winter. But lately a writer in one of the foreign journals says that with him it does best when sowed in the spring. Last spring I had some sown with oats at the usual time for sowing oats, or rather a little later. It was not a remarkable success, dry weather being against it, still most of it succeeded in blooming, and if the seed lies in the ground over winter it is possible it may succeed a good deal better than mine did. At least, let a small patch of it try its chances without being disturbed, Mr. LaMont, and then report how it comes out.

BREEDING OFF WINGS.—Here's a new suggestion sent me by J. R. Felt, of Rochester, N. Y.:

DR. MILLER:—There have been so many articles in the American Bee Journal upon "breeding out the swarming influence," that I think it is time for some one to write upon "breeding wingless queens," for that certainly would stop the swarming.

J. R. FELT.

Yes, they wouldn't swarm if their wings were bred off, at least a queen couldn't go with a swarm if her wings were bred off, and neither could she if her head was bred off, but there's this difference between that and breeding out the swarming habit, that many desire the latter and no one desires the former. Still, I'd rather have a good plan of management to prevent swarming, habit or no habit.

THAT ADMITTED FAILURE.—Mr. Editor, please stop my paper, or else stop that man Brodbeck abusing me on page 78. Now, look here, my Brod-minded friend, when you say without any qualification or limitation that a thing is an "admitted failure," I think it would always be understood that every one, or at least nearly every one considered it a failure. If you could get ten men to testify very positively that the North American was an utter failure, that alone would hardly justify you in saying it was an admitted failure.

But you don't get the testimony of ten men. You stand three men up in a row, and two of them don't give the least hint that they ever dreamed of such a thing as the North American being a failure. They merely say it is not representative. It isn't necessary to be representative to be a success. I think you had a successful convention of bee-keepers in California, but I think it didn't make the slightest attempt at being representative.

That narrows you down to the testimony of the Rev. W. F. Clarke, who thinks if it cannot be made representative "it might as well be given a decent funeral." He has made some statements about the North American in a late number of

Gleanings that I don't believe he can substantiate, and until he does substantiate them I don't believe his testimony would be considered of any great weight in the matter.

Say, Friend Brodbeck, between you and me, the North American has had some very successful meetings, and you would have said so if you had been present. Ask Prof. Cook, one of your own men. If they were admitted failures, do you think men would pay so much to attend them year after year, men, too, who have advanced beyond the primary class of bee-keepers?

COMMISSIONS—QUEEN-CELLS.—Gustave Gross, of Milford, Wis., writes me as follows:

DR. MILLER:—I noticed in the Bee Journal what you say about commissions in Chicago. I have shipped every year for five years, and have always been charged 10 per cent. by J. A. Lamon and R. A. Burnett & Co. The latter firm, however, charge only 5 per cent. when the shipment amounts to \$100 and over.

There is another matter I'd like to mention—the cutting of queen-cells to prevent after-swarms. I have practiced it in over 1,000 cases, and never missed but three cells. The ones that I found the most dangerous (easy to overlook) are built horizontally at the bottom of the comb, from one side to the other. If I had trusted to "Langstroth Revised," I should never have looked for queen-cells in that place, for it says that queen-cells always hang with their mouths downward.

GUSTAVE GROSS.

It seems that I was wrong in thinking that 5 per cent. was the regular and only commission on sales of honey in Chicago. It shows that for some years I have shipped no honey to Chicago on commission. Years ago I shipped more or less there, and was never charged more than 5 per cent., no matter how small the shipment. I think no house at that time charged more than 5 per cent., but I will be glad to be corrected if wrong. In some other cities at that time the commission was 10 per cent. It would be a good idea to have full information as to rates and rules in the different places.

Missing only three queen-cells in a thousand may be called very successful work. But this was after natural swarming, and if it had been after the removal of the queen without swarming the result probably would have been quite different. In that case the most difficult cells to find are not always the ones between comb and bottom-bar, but those right on the middle of the comb, but projecting so little above its surface as to be scarcely noticed.

Bees build queen-cells mouth downward *where they can*. Where the situation will not allow it, they make an exception to the rule.

SELLING HONEY ON COMMISSION.—The following letter gives some experience in selling honey:

DR. MILLER:—You ask, on page 38, if commission houses in Chicago charge 10 per cent. I enclose a bill and letters from a well-known house, which shows that he not only charges 10 per cent., but charges drayage also. Of the honey sent one lot was extra fine basswood, and the other was mostly basswood, but colored slightly. You will see by one of his letters that the honey was all right except the packages (one gallon cans). He also docked me 45 pounds—something I have never had done before.

W. H. YOUNG.

Ono, Wis.

Accompanying the above letter was an account of sales from J. A. Lamon, of 345 pounds of No. 1 honey, at 6 cents per pound, \$20.70; 690 pounds of No. 2 honey, at 5½ cents per pound, \$37.95; total, \$58.65.

From this was deducted—freight, \$7.56; drayage, 75 cents; commission, \$5.85—total, \$14.16. Net proceeds, \$44.49.

The honey was put up in one-gallon cans, which was more expensive than to use larger cans. If the popular 60-pound cans were used, it would require 18 cans, and I suppose these would have cost, delivered, about \$6.50. Deducting this from the \$44.49 leaves \$37.99 clear money for the 1,080 pounds of honey, or just about an even 3½ cents a pound.

I commend a careful study of those figures to any one who contemplates shipping to a city market. It does seem as if that honey might have been sold at home for 5 cents a pound, in which case there would have been a gain of \$16, and that would have paid for several days' peddling in the surrounding towns.

If Mr. Young is correct, each can held 12 pounds, but Mr. Lamon says: "Those cans were billed out at 11½ pounds each, and that is all we could get for them." It

doesn't seem the right thing to sell for less than the actual weight. Perhaps Mr. Lamon, or some one else, can tell us whether that is the common practice, and if so, what there is to justify the practice. In the present instance it is a practice that cost Mr. Young \$2.30.

Marengo, Ill.



The "Handy" Shipping-Crate Described.

BY B. TAYLOR.

A recent letter from Dr. Miller contained the following self-explaining slip:

DR. MILLER:—I wish you could get Mr. B. Taylor to tell the readers of the American Bee Journal just exactly how he makes that wood and paper crate weighing 2¼ pounds only. (See his essay, read at the Toronto convention, page 615, 1895.) Do try and induce him to give particulars. Seems to me improvement is greatly needed in this item. S. D.

The above note is from S. A. Deacon, South Africa; and for the Doctor's sake, as well as his distant brother's, I hasten to explain.

The B. Taylor Handy shipping-crates are made of very light wood, lined with water-proof building-paper. For an 18-section crate there are two side-pieces 13¾ inches long, 4¾ wide, and ¾ thick; top and bottom are 14¾ by 11 inches, and ¾ thick. The front end is two pieces of wood 11 inches long, and 1½ wide, 5/16 thick, with a strip of glass 1¾ wide between their grooved edges. The end is of solid wood, 11 inches long, 4¾ wide, ¾ thick. These pieces are nailed strongly with very slender wire finishing-brads. The grain of the wood in top, bottom and ends goes across the crate. Good, clear soft pine is used, and is dressed very smooth, making a neat, handsome box 14¾ long, 11 inches wide, and 4¾ deep, outside measure, and holds two courses of handy sections, of nine sections each. (The "handy" section is four-piece, 4x5 inches, and eight to the foot.)

The paper is made into a shallow pan, with sides one inch high, and as large as the inside of the crate. One of these paper pans is placed in the bottom of the crate, the sections put in, and another slipped over their top, and the cover nailed over all, with ¾-inch wire flat-head nails. (The flat heads will not pull through in prying off the cover.)

The cover is in two pieces, so that in using the honey, one-half may be uncovered at a time, the paper cut away as the honey is used, and the remainder kept clean and free from dust until all is used.

These crates are very popular with private families who buy honey by the crate. I put up my finest goods for this kind of customers, and sell most of my honey in my home market in that way. I have not sent a crate of honey to the large city markets for years. This settles the contention with the commission men, good or bad, and saves heavy freight charges. Brethren, go and do likewise.

Forestville, Minn.



To Avoid Being Stung by the Bees.

BY C. P. DADANT.

To avoid the anger of bees, no method has ever been found that compares with the use of smoke. This evidently frightens them better than any other thing ever tried. The principle underlying the present practical system of management in the handling of bees was clearly stated by Mr. Langstroth, years ago: "A honey-bee, when heavily laden with honey, never volunteers an attack, but acts solely on the defensive." We may subdue our bees temporarily without compelling them to fill themselves with honey, but in such cases their peaceableness is only superficial, and a quick or careless motion may suffice to irritate them. Not so, when they have once filled themselves with honey through fright, for it becomes then almost impossible to arouse them.

But other methods than smoke have been used and recommended to keep the bees quiet. Preparations of chemicals, "the Apifuge of Grimshaw," a solution of carbolic acid recommended by some English bee-keepers, and different other ingredients have been used, with more or less success. The lovers of animal magnetism and hypnotism have asserted that bees may be subdued by magnetic influences, and there is undoubtedly something in the manners of an operator who is self-confident, that subdues them in just the same way that the wild animals of the menageries are subdued by their trainer. Evidently, faith in one's powers has a great deal to do with success, and I have just read an article in the Revue Internationale, from the witty pen of the eminent graphologist,

Mr. Crepieux-Jamin, on the superstitions of Normandy and the subduing of bees by prayers. Yes, by prayers! Is this not a task almost equal to the converting of R. G. Ingersoll by the same means? But let me quote Mr. Jamin's article:

"The Norman, formerly great friend of adventure, has become the slave of habit. It is among populations of this kind that one has a chance of finding, in their habits, customs and language, traces of their origin, and to live over, through the past, without ceasing to enjoy the present. Truly, peasants are custom-led everywhere, but not everywhere in the same manner. Thus, in some parts they are rough, in others their habits are improved by a tendency to art, in others again they are more or less progressive, but in Normandy they are unintelligible, *routinier*, and unpolished. I speak, as a matter of course, of the real *paysan*, of the countryman after Nature, for the educated man is the same everywhere, the first result of a mind-culture being the unification of tendencies, through a methodical spirit which renders these tendencies uniform.

"It is well known that the Norman never says squarely, *yes* or *no*. We tested this fully when making inquiries among the bee-owners of the vicinity of Rouen. It is impossible to find out whether their bees are prosperous, whether the honey was good, the crop large, etc.

"'Did you have any swarms?' 'Sometimes.'

"'How many?' 'Some years we have some, and some years we have none.'

"'But how about this year?' 'Perhaps we had some.'

"'Don't you know whether you had swarms or not?' 'We don't bother much about it.'

"'May I go and see your bees?' 'Some people say that it is not good.'

"'What is not good?' 'May be you know it as well as I do.'"

You may converse in this way for an hour. Remember that it is a tradition among the Normans that visiting strangers are prejudicial to the apiary. The bees do not like their inquisitiveness. Is it not charming to grant our little pets peevish feelings that we would not allow in our daughters?

When the master dies, the bees are put in mourning, by fastening crape to each hive. This custom still exists in many parts of Europe. It rests, however, on very correct observation. When the master disappears, if no one cares for the bees, they will soon die out or leave, from lack of care. To put them in mourning is to show an interest in them, to shelter them from sun or rain, and thus the pious custom bears its fruits. In some parts, they never sell bees—they give them away, stingily. The man who sells bees would be condemned by everybody. The reason of this is, evidently, that, the bees being considered as a part of the real estate of a farm, the man who sold them in the olden times must have been negligent, or hard up, and very near ruin. At this time the conditions are changed, but the idea remains with its superstitious bearing.

They also make a great noise, in Normandy, when the swarms issue. I have seen, on a farm, some old kettles kept purposely for this usage. It was impossible for me to convince my host of the uselessness of this. The all-powerful tradition is there, and that which has been done, for centuries, cannot be undone in a short time.

But here is a prayer to avoid bee-stings, recited by a farmer's wife at Pont-de-l'arche (Eure):

"Beautiful bee, remember when our Lord washed his hands in the waters of Jordan, how he shook off the drops." (Repeat five times bareheaded.) Add to this the Lord's prayer, five times, and the prayer to the Virgin, five times. It is rather long, but they say it is sometimes very effectual. In this instance, with me, it was a failure; I had a veil; I was not stung, but the farmer's wife went home with a swollen nose. "Beautiful bee, remember. . . ."

You have no idea, dear reader, of the trouble I had to obtain the text of this prayer. Above all things, it is forbidden to write it. It must be taught only to friends, and bareheaded, and they must learn it bareheaded. Here is another:

"In the dew of the morning, Jesus washed his hands. He dropped from his fingers three drops of water, which gave birth to three bees, to make wax to serve at the holy Mass. Bees of the Lord, do not sting. Bees of the Lord, do not swarm."

These formulas, transmitted from mouth to mouth for centuries, are evidently incomplete, so they have but little sense, but what of it? Let us smile kindly at the peasant who does not care for the meaning, and is contented with an unmeaning text, for in a manner his faith is respectable.

The prayers to keep bees from swarming or from stinging are probably numerous. Michelet informs us, in his "Origins of French Common Law," that an old manuscript of

St. Gall contains a formula to call the queen. Here is the text translated from the Latin:

"I adjure thee, mother of the bees, in the name of the Lord, King of Heaven, and of the Redeemer, Son of God, I adjure thee to fly neither far nor high, but to come back at once to thy tree. There thou wilt alight with all thy lineage or thy friends. I have there a good receptacle in which you will work in the name of the Lord."

This prayer is more interesting, for it is whole. Take notice, that in all these prayers our little friends have a fine role. They are begged and supplicated, and treated as rational people. They are even granted faculties which they do not possess; for instance, the capacity of recognizing their owner. This is a very frequent error which is not worth refuting. There will always be ignorant people who will neither read a journal nor attend a convention. But even a bee-keeper with movable-frame hives has asserted to me that when he goes to the flower-market his bees come and settle on his shoulders.

Let me close with the text of the law concerning bees, taken from the *Etablissements de St. Louis*. We have found this also in the book of Michelet above mentioned:

"If one has swarms and they escape, and he to whom they belong sees them go and follows them at sight without losing, and they settle in any place or manor, and he on whose place they have settled takes them before he comes, and if he says after, 'They are mine,' and the other says, 'I believe you not,' then they will transport before the judge where the first man will swear that the swarms are his, and by this will have them and will pay the other the value of the vessel in which they have been collected." (XIIIth century.)

"CREPIEUX-JAMIN."

Let me add that the writer of the above is the author of a very interesting book, an exhaustive treatise on graphology, or the science of discovering one's character by his handwriting. I must acknowledge that I had always considered this study as absolutely useless, but a hurried glance over the book, kindly presented to my father, by the author, has convinced me that there is a great deal more in this science than any one can imagine, by a hasty survey of its broadest outlines.

Hamilton, Ill.



An Essay on Bee-Culture.

Read before the Farmers' Institute at Lancaster, Calif., Dec. 17, 1895.

BY C. H. CLAYTON.

It has been a matter of considerable difficulty for me to prepare something upon the subject of bee-culture that would be measurably satisfactory to myself and beneficial to others.

A celebrated French author has told us that there are two errors into which one is liable to fall—one may "say too little, or one may say too much." The first certainly is a trivial offense, and easily forgiven, but the second is almost unpardonable. Let me err by saying too little, confident that if I succeed in arousing a spirit of inquiry upon this subject, willing and abler peers will come to my aid.

It would be easier for me to take up the subject of Apiculture at its very beginning, and follow it along step by step to the fruition of all our hopes—a fat bank account—than I find it to select from the mass of material at hand such features of the subject as may be submitted to you at this time.

A BIT OF BEE-HISTORY.

Bees have been subject to man's control from the very dawn of History. We are informed that the land where Abraham dwelt—Canaan—was a "land flowing with milk and honey." We read also, that at one time there was a famine in the land, and the old Patriarch sent his sons down into Egypt to buy corn, that they might not perish. The young men bore with them as a present from their wise old father, to the ruler of Egypt, a portion of their delicious honey. Even at this early date honey was an article of commerce, and was, along with corn and milk, regarded as one of the necessities of life. For centuries the method of handling bees and preparing their product for use was far different from the method of to-day. The habitation provided for the busy little workers was altogether different from the convenient hive we now use. The hollow-tree, the natural cave in the cliff, and later, the straw "skep" of our grandfather's day lack much of the utilities of the nineteenth century movable-frame hive. Then the bees were usually sulphured—*murdered*—when the owner wished to secure their stores. Now the whole crop of honey can be secured, practically, without the loss of a bee. It is difficult to realize the great change from the wasteful, barbarous and destructive ways of early times to the enlightened

and humane methods of the present. The advancement has been truly marvelous, keeping fully abreast with the best spirit of this intellectual age.

VALUE OF BEES TO FRUIT-BLOSSOMS.

Modern bee-keeping has attained to the dignity of a profession, and its usefulness to all branches of agriculture and horticulture is everywhere recognized. The product gathered by the bee, which would otherwise be wasted, although valuable in itself, is probably of far less importance to the farmer and orchardist than is the work of fertilization so thoroughly performed by the bees in passing from flower to flower. Some flowers are self-fertilizing, but there are many that remain absolutely sterile unless pollen is conveyed to them by mechanical means from other blossoms of the same species. For example, I might name the "stone-fruits," such as the peach and cherry, and apricot. The Bartlett pear is another fruit that will not "set" unless pollination is effected by mechanical means. I mention these fruits because they have fallen more directly under my notice. You will readily call others to mind from your own observations. There can be no longer the shadow of a doubt that many crops of fruit, grain and vegetables are greatly improved in both quantity and quality through the agency of the bees in bringing about perfect fertilization of the blossom.

In the early settlement of the country, this fertilization was perhaps fully accomplished by native insects, but the orchards and fields have been so enlarged that it has become a physical impossibility for the few native insects to accomplish proper fertilization, hence we must more and more depend upon the bee.

Some plants never produce seed because the insects that feed upon their blossoms were not imported with the plants. Red clover was imported into Australia and remained barren until "bumble-bees" were also imported, when it bore seed as in this country.

Fruit-growers, as a matter of self-interest, should be interested in bees, and I feel sure that within a very few years it will be an exceedingly rare thing to find a successful fruit-grower who does not also keep the honey-bee, the main object being to secure perfect pollination of his fruit-bloom, and, incidentally, the production of some honey for his own table. If he produces some to sell, so much the better, it will be a welcome addition to that "fat bank account."

I am engaged in the production of honey for the market, and your production may increase the supply, and this may mean lower prices. Cheaper honey means the ultimate extension of the market. The immediate profits may not be so great, but the foundation for a permanent market will be the more easily and securely laid. We must meet this lower price with better and cheaper methods of production.

In some portions of the country bee-keeping is conducted as a specialty, and under favorable conditions has proven very profitable. But localities where this obtains are comparatively few.

THE LOCATION OF AN APIARY.

It may be proper for me, at this point, to say a few words regarding the location and management of an apiary. If you intend to engage in the business to any considerable extent the question of location with reference to feed, water, etc., is a vital one. Perhaps I can best tell you what you need by describing my own location, which I consider a fairly good one as demonstrated by results:

My apiary is in Soledad canyon, a quarter of a mile from a shipping station, on level ground. There is a range of hills on the southeast, south and southwest, at a distance of from a quarter to a half mile; a range of hills also at about the same distance to the north. These hills shelter the bees from the southeast and southwest storms of winter and the hot northerly winds of summer. The hives are placed in double rows, 30 inches from centers, and rows 8 feet from outside to outside. This leaves an alleyway about $4\frac{1}{2}$ feet wide between the rows for workway. A space of 25 feet is left between each set of double rows. There are openings left through the rows at convenient intervals. Each hive is placed so that the *end of the frame* as it hangs in the hive is toward the 2-o'clock sun. This throws one-half of the entrances a little west of south, and the other half in exactly the opposite direction. This position reduces the danger of melting down from the great heat we sometimes experience, by exposing to the hottest sun two thicknesses of wood with bee-space between. If the sun shines upon the side of the hive you have only one thickness of wood for protection. Those of you who have had young fruit-trees blistered by the sun, will know why I say the "2-o'clock sun." That is the side of your tree that suffers the worst from the heat. For additional protection I leave a

shade-board against the westerly side of the hive. I have not lost a colony from the heat for years, notwithstanding the mercury frequently goes to 108° or more in the shade.

SOME OF THE MANY HONEY-PLANTS.

In January, February, and part of March my bees visit manzanita and willow, gathering pollen and honey enough to carry on brood-rearing at a lively rate. March furnishes buckhorn and alder, the alder lasting into April, when the wild plum and the spring flowers take up the burden and bring us to the point where a surplus is to be expected.

In May and June Yerba Santa and ball-sage are the principal sources, and in July and August white sage and wild buckwheat. I have seen some fruit-bloom and alfalfa available during the season. The buckwheat flow ends the surplus season.

September, October and November are filled out by the fall flowers, the principal of which is a species of broom, bearing a profusion of small yellow blossoms, yielding a fair quantity of a rich golden-yellow honey, upon which the bees fill up their hives for winter, which really only lasts a month.

Locations vary, but, in my judgment, unless you have about the equivalent of the foregoing, your honey-yield will suffer. I have a water-ditch by the side of the apiary, and in season, I turn a stream out over a bed of sand and gravel for a "watering-trough" for the bees.

APIARIAN IMPLEMENTS AND CONVENIENCES.

I use what is called the Ventura-Standard hive, 10 frames in the lower and 9 in the upper story. The frames measure 8x16½ inches inside the wood. Sometimes, when I am crowded, I pile them up three, and even four, stories high. This only occurs when I get behind with my extracting. Usually, I extract from each hive every seven or eight days during the season.

The extracting-house is made principally of common wire-cloth, with a good shake roof over it, and is furnished inside with extractors, oil-stove, uncapping-can, honey-tanks, etc.

I ripen my honey in large tanks from four to six days before I case it up for market. I use new cans and cases, taking care to have everything perfectly clean and neat during the whole operation. I close the cans tightly, and keep them so, and have never had any honey "candy."

I handle my bees and hives just as little as I possibly can, never taking two steps where one will answer the purpose. I sell my honey as soon as I get it ready for market, and save insurance, warehouse charges and other expenses.

THE ROAD TO SUCCESS.

I am convinced that the road to success lies along the line of cheapened production. The field of the specialist is being narrowed year by year, and he can no longer hope to secure the phenomenal yields of the past. You, of this valley, may not find it profitable to engage largely in apiculture, but when your vast underground resources are tapped; when the life-giving streams from the encircling hills are conducted upon your fields, and Alfalfa—that *prince* of forage-plants—spreads his mantle of green over the naked breast of Mother Earth; when around each cottage home there thrives the apple, the peach, the almond—all manner of fruits and flowers—they all grow here—then I hope to see beside each garden-wall a few thriving colonies of bees.

Since modern science has done so much to simplify the care and management of bees, there is no reason why every family living as you do, in the country, should not keep a few colonies for its own use. With the movable frames now in use, and the knowledge that bees can be subdued by smoke, they may be handled by the most timid. The women and children can take care of a few colonies at the cost of no more labor and trouble than would be given a flock of hens.

BEEES AND FRUIT AGAIN.

It has been contended that bees destroy fruit. This is certainly a mistake. Wasps and hornets—which secrete no wax, are furnished with strong, saw-like jaws, for cutting the woody fibre with which they build their comb—can, and do, penetrate the skins of the toughest fruits. On the other hand, the jaws of the bee are adapted chiefly to the manipulation of wax—are not serrated as are those of the hornet, but *smooth*; are so feeble that they cannot puncture the skin of the tenderest grape. This has been proven by repeated experiment.

If the skin of the fruit is once broken, however, the bee is not slow to take advantage of the circumstance, and will at once proceed to collect and store the juices, and in the case of grapes, at least, to the detriment of both bees and bee-keeper.

REQUIREMENTS OF SUCCESS.

In apiculture, as in all other lines of endeavor, only the careful and practical may hope to succeed. Experience is an important qualification for the successful running of any business, and apiculture is no exception to the rule, yet men who have not had practice, and cannot get it, are much better equipped for the work, provided they have some knowledge of the bee, its habits and management. This knowledge is not only valuable to the beginner, or those just about entering upon the business, but it is also of great importance to the regular, old-time bee-keeper whose success would have been much greater if he had had a knowledge of apiculture commensurate with his opportunities. *Theory leads practice to greater results.* This knowledge may be obtained from any of the standard books published upon the subject. Of these there are several that can be recommended: The "A B C of Bee-Culture," by A. I. Root; "Langstroth on the Honey-Bee"—universally regarded as the *classic*; and the "Bee-Keepers' Guide," by Prof. A. J. Cook, are the best. You make no mistake in procuring either of these.

You want also, one or more of the journals devoted to bee-culture. There are several—all good—and it is difficult to choose between them, but if you can take but one, I would advise the American Bee Journal. Then, study the book, and the journal, use your eyes, and your reasoning powers. No man can be an earnest student of the bee and its ways without being made better physically, in morals, and in intellect.

Do not attempt to keep too many colonies at the first. Start with a few—they will increase with good management quite as fast as you advance in knowledge. Give them good care. Be alive, wide awake, sober, industrious, and you will surely prosper.

Lang, Calif.

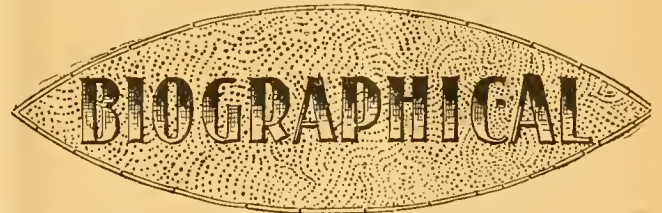

MR. EDWIN BEVINS.

The subject of this week's biography has kindly written it himself, so we give it in his own words:

The events of my life are few and hardly worth the telling. I was born Aug. 30, 1831, in Hague, Warren Co., N. Y., where I spent the first 22 years of my life. Farming and lumbering, and growing men and women to people the Mississippi Valley were almost the only occupations of the inhabitants of this region at that early day. My father was a farmer and lumberman. My memory goes back to the time when bear were killed in our neighbors' cornfields, and deer were chased along the mountain sides by the hounds, and killed by the hunters watching on the shore of the lake. Here, too, I fished and hunted, and drank fire-water and begged tobacco from a lone Indian—Jonathan Paul—"The Last of the Mohegans."

My mother died when I was a little more than four years old, and soon after I went to live with my grandparents, who resided not far from my father's. My father married again, and soon after sold out and moved to another county, and I saw and knew but little of him and his family for many years. In my boyhood I assisted my grandfather what I could on his farm, and attended the district school summers and winters until he died. I learned to read at a very early age, indeed, I have no recollection of the time when I could not read. I read, or rather devoured, every book that I could lay my hands on. As my grandfather was school district librarian most of the time, I had no lack of books to read. But I read indiscriminately, and with no particular end in view, and no one gave me any guidance or direction. Books of history, biography, poetry and fiction gave me the most pleasure, and my dream at this time was of a college education and a literary career—things utterly beyond my means. Once, when in Schenectady, N. Y., I stood outside the walls of Union College, then presided over by Eliphalet Nott, and felt an almost irresistible impulse to go in and beg for something to do to pay my way while studying there; but I did not do it. Again, later, in Williamsport, Pa., I stood at the door of Dickinson

Seminary, only to be told by its principal—now Bishop Bowman, of the Methodist Episcopal church—that I had not money enough to justify me in attempting to study there. Something of bitterness comes into my heart even now when I think of the intense longing I had in my youth for a college education, and the desperate poverty that hindered me from getting it.

I earned my first money the winter after I was 18 years old, teaching school in an old log school-house for the munificent sum of \$11 per month, and board; and had to "board around."

After my grandfather's death I continued to live with my grandmother till her death, when I was 22 years old. Then, packing a sachel with some of my most cherished books, and a few articles of clothing, and with just about money enough in my pocket to pay my traveling expenses, I started for the pine forests of Pennsylvania, then giving employment to thousands of men. There I found employment on a big saw-mill, measuring and marking the lumber as it came from the saws. One winter I measured and marked the logs as they were piled in the forest. One winter I taught a term of school, and one winter I gave instruction to a big family of boys belonging to a man of German origin named Wolf. Some of the boys were a good deal bigger than I was, but they were good-natured and well-behaved "Wolves," and I got along without trouble.

Once when the sawmill ran out of logs, I spent a few weeks in the village of Jersey Shore, on the north bank of the Susquehanna, studying surveying with a man by the name of Parker, who had been instructor of mathematics at West Point. I mastered that branch of mathematics in a short time, but my health never permitted me to enter on the practice of surveying.

Leaving Pennsylvania in the fall of 1856, I took Horace Greeley's advice and went West. I had a sister living in Illinois, whom I had not seen for several years, and thither I directed my steps. Other relatives were living in Iowa, and there I taught a term of school the following winter. Returning to Illinois in the spring of 1857, I went to work with my brother-in-law on a rented farm. Our crops were good, but the financial panic of that year was on hand as soon as the crops were, and all my earnings in Pennsylvania were swept away.

The following winter I returned to the old home in New York, where my father then lived, he having bought it, with other lands, about the time my grandfather died. There I staid and helped him on the farm till the fall of 1865, when he sold out and moved to Carroll county, Ill.

In January, 1866, I was married to Julia M. Prentiss, of Windham, Vt., and we went immediately to keeping house on a farm near the scene of my former failure. After the birth of our first and only child—a daughter now married and living here—her health rapidly declined, and, although she lingered for several years, the demon of Consumption never relaxed his hold till his deadly work was done. She died in July, 1881. Subsequently I was married to one of her sisters, who had been with us for a long time. I continued my farming operations in Illinois until the spring of 1890, when, in the hope that my health would be benefited by the change, I sold out and moved to this place. The farm here has been cultivated and improved mainly by the aid of hired help. Here, on the high divide midway between the Missouri and Mississippi, in caring for hogs and horses and cattle by proxy, and giving a large share of my own time and attention to the care of bees, and in musing somewhat mournfully, perhaps, on what might have been, I shall probably pass the short remainder of my days. My pathway has not been along the sunny side of fate.

I had not been long settled here, when, one afternoon near sundown, I found a swarm of bees clustered on the limb of an apple-tree. It was hived in a box-hive, and it went to work and stored considerable honey. Then somebody stole it. Some bees in log-hives were bought, but I did not know very well what to do with them. I resolved that I would know what to do with bees. I got what I thought were the best books and papers on the subject, and read them with the same avidity that I had read everything else, at the same time working with the bees and making a good many mistakes. I have bought some bees every season since I have been here, but the seasons have been mostly poor ones, and I have not had much natural swarming until the past season, so that my apiary is not now very large. Last season, also, I had a fair crop of honey, put up in such a way that I was able to capture my home market, it being now all, or nearly all, disposed of at a fair price.

In the future management of my bees I shall keep two objects in view, viz.:

1st. To get the maximum amount of honey at the minimum expense of money, time and labor.

2nd. To determine what departure, or departures, if any, can be made from the 8-frame size of the Langstroth hive with advantage to the bee-keepers of this locality who work for the production of comb honey. In making these experiments I shall not change the length of the frame, but the departures will be in the depth of frames and the number of frames used. Notwithstanding all that has been said in favor of the 8-frame hive, I am not friendly to it, though I use it more largely than any other. If I am permitted to make any discoveries either to the advantage or disadvantage of bee-keepers, they will, with the editor's permission, hear of them in the American Bee Journal.

In conclusion I will say that nobody steals bees from me now, and that when another stray swarm of bees alights in one of my apple-trees, I think I shall know how to care for it.
Leon, Iowa.
EDWIN BEVINS.

CONVENTION PROCEEDINGS

Report of the Illinois State Convention Held at Chicago, Jan. 9 and 10, 1896.

REPORTED BY ERNEST R. ROOT.

(Continued from page 70.)

CRIMSON CLOVER AND BUCKWHEAT.

President—We do not know very much about crimson clover; but what we do know we might as well air here. I sowed some in the spring, and it came up fairly well, but I did not see a great many bees on it; but freezing weather came on, and I had a nice patch of it.

Mr. Schrier—I sowed 10 acres along with timothy, and it seemed to do well.

Mr. Baldrige—I sowed a small lot in 1894, and bees worked on it very nicely. The seed dropped off, and it re-seeded itself as nicely as at first. I have great faith in the plant. I would mix it with Alsike or other clover. If it should fail, then we would not lose the other crop.

Mr. Thompson—Mr. Baldrige's experience is the same as mine.

Mr. Draper—I should not think it would do very well with red clover, because the latter is biennial, and crimson clover is an annual.

Mr. Baldrige—The seed is very cheap, and there is not very much to lose, even if it should fail when it is sown with other clover.

Mr. Stewart—How tall does it grow?

Mr. Schrier—It is short.

Mr. Baldrige—It grows about a foot high, and very well with red clover, because it protects it. Crimson clover is not hardy.

President—What have we to say about buckwheat?

Mr. Stewart—I should like to know how Japanese buckwheat compares with others.

President—It yields a larger grain, more of it, and seems to have all the advantages of the other buckwheat.

Mr. Schrier—It ripens earlier.

Mr. Draper—How long does it continue in blossom?

President—About the same as the other.

THE BEE-PAPERS AND BEE-PASTURAGE.

Question—"What can the bee-papers do in the line of increasing artificial bee-pasturage?"

President—Just what we have been doing here to-day—gathering together in convention, and then spreading the knowledge here gained in the agricultural papers. We should emphasize to the farmers the value of the honey-plants only as forage plants. Perhaps it is better to say little or nothing about their being valuable for honey.

Mr. Stewart—What can be sown on waste land that farmers will not object to? Sweet clover won't do, because farmers call it a "noxious weed."

President—Farmers will object to every plant that you try to push, if they think your bees get honey from it.

Mr. Baldrige—Alsike clover will be a good plant to push. I would scatter it along the roadsides.

President—I would try to educate the farmers that sweet clover is not a noxious weed.

Mr. Draper—Mr. Quinby recommended catnip 25 years ago. Some years ago I sowed considerable of it, and have lots of it growing every year, and bees work on it well.

REMOVING BEES FROM THE WINTER REPOSITORY.

Question—"When is the best time in the spring to remove bees from the winter repository?"

Mr. Thompson—Localities differ. Bee-keepers must be guided by the season. We, on the Fox river, put them out as early as possible. A little frost after they are out will not hurt them any after they have had a good flight.

Mr. Baldrige—I put my bees in late, and bring them out early, and give them a good flight. I believe I secure young bees, brood and swarms earlier by so doing.

Mr. Wheeler—I get brood in the cellar, and keep my bees in as long as I can keep them quiet.

President—Some of you feel sure that there is advantage in taking bees out early. Others think bees would be better off as long as they can be kept quiet in the cellar. Those who advocate out early seem to lay great stress on the flight. I am going to try a few next spring, and compare them with those taken out late.

Mr. Finch—Bees kept in the cellar late become uneasy. If they get out, the flight quiets them, and then they keep quiet, even if they go out-doors.

President—I keep bees quiet by opening the cellar-doors at night. If it is cold, I start a fire and thus start the circulation of air. Either way will quiet the bees.

The convention then adjourned to meet at 1:30 p.m.

First Day—Afternoon Session.

HONEY ADULTERATION.

Question—"How can we stop adulterating honey?"

Pres. Miller—Why, just stop.

Mr. Finch—If you stop, it does not stop any one else. In central Illinois we find honey put up in glass jars. These jars hold a pound of some sort of mixture containing a little comb. The storekeeper pays 6½ cents per jar, and retails it for 10 cents. It does not taste like honey. If a suitable law can be drafted, I feel pretty sure it can be passed. The honey that I just spoke of is labeled simply "Honey."

Mr. Wheeler—I can beat that story all to pieces. I know where those jars in boxes of two dozen have been bought for 90 cents, or a little less than 4 cents each, you see.

President—It was wrong to overcharge [laughter]. But, Mr. Finch, can you prove that what you speak of was not honey? You propose a law against selling such stuff; but how are you going to prove it is not pure?

Mr. Finch—By analysis, and by tasting; besides, pure honey cannot be put up at that price.

Mr. York—In a walk of five minutes, I understand there are plenty places where they are adulterating.

Mr. Draper—I will tell you how you can knock 'em out. Raise honey nice enough, and you will run 'em out. The poor won't sell alongside of the good honey.

President—Mr. Finch has tried that, and failed. I don't mean he has adulterated, but has put a nice honey on the market. I should like to know whether there is a law already in this State against selling anything but pure honey. If there is not, might we to have such a law?

Mr. York—There are lots of firms in this town, I understand, who are adulterating. A friend of mine investigated, and there is no doubt they can double the amount of honey (?) in that way.

Mr. Finch—Prof. Wiley's report shows that honey is adulterated.

A Member—But how do we know that this analysis was correct?

E. R. Root—You will remember that, some time ago, Prof. Cook, for the purpose of testing Prof. Wiley's skill, sent him various samples of honey. Some were adulterated 50 per cent., some 25, some 10, and still others were not adulterated at all, but a queer, twangy kind of pure honey. Prof. Wiley successfully identified each sample, and told the amount of adulteration in each kind by analysis; and the pure honeys were pronounced pure by him. As he had no knowledge in the first place of what these samples were, they being submitted to him by number, he had to rely solely on his skill and that of his associates. Well, then, if he had skill enough to name accurately each sample, and its amount of adulteration, we can assume that he is probably correct in his

analysis of the samples found in the open market, to which Mr. Finch refers.

A motion was made by Mr. York, to the effect that the Executive Committee be instructed to draft a suitable law to present at the next session of the Illinois legislature. Carried.

SWARMING IN SMALL AND IN LARGE HIVES.

Question—"Do bees swarm more in small than in large hives, generally?"

The President called for an expression. The general consensus of opinion seemed to be that the small hives would give more swarms. A few thought there would be no difference.

Mr. Draper—If you want to force bees to swarm, keep ventilation away; but if you don't want them to swarm, just give them plenty of ventilation.

Mr. Lyman—Colonies in large hives will swarm later, and those in small ones earlier.

Mr. Stewart—I practiced ventilation as suggested by Mr. Draper. It did not seem to make a particle of difference. They swarmed just the same.

Mr. Finch—I do not believe very much in ventilation to prevent swarming. I had a hive once that was warped so badly that it was open all around. They wintered well, and swarmed when the rest did. I do not know why I left them in that way.

Mr. Draper—Mr. Hutchinson claims that replacing queens every season will stop swarming. Regarding Mr. Finch's hive, open all round, perhaps it was a small one, and the bees just had to swarm. In running for extracted honey we use the large Quinby hives, and, besides that, give them a large amount of empty combs above. I keep no queens over two years old. Taking all these things into consideration, I manage to keep swarming down.

Mr. Stewart—The size of entrance cuts quite a figure in the prevention of swarming.

President—Heat does have something to do with it. I do know when that window is open it is cooler. [It was very warm in the room.]

Mr. Stewart—I tested 75 hives, raising them up on four bricks, and it made no difference with swarming.

Mr. Draper—I think you did not raise the hives soon enough.

Mr. Stewart—That was not the fact. They were raised before honey came in.

PREVENTION OF SWARMING.

Question—"Is there any other means of preventing swarming, other than to raise the hive from the bottom?"

Mr. Thompson—Keep the honey away from them, and they will not swarm.

Mr. Baldrige—Go into a poor region where there is no honey, and they won't swarm.

[Continued next week.]

From the Oxford Bee-Keepers' Meeting.

Having some time to spare, the question-box was opened with: Will brood-combs color honey stored in them? If so, how shall we prevent bees storing temporarily in the brood-nest?

The idea intended by the question was that when a flow suddenly begins, bees fill the spare room in the brood-nest and then remove it to the super. Will this honey be dark? Everyone had noticed that brood-combs soaked in water would color it, and that honey, though coming from clover and basswood, if stored first in the brood-nest and then removed to the super, would be dark. To prevent the bees storing first in the brood-nest, it was necessary to have the super filled with clean combs before a flow from white clover, or any white honey-flow, began.

In extracting, what method do you follow in removing the combs? The best method was to remove half the combs at a time from the super, put the remaining half in the center and fill the outsides with empty combs.

Would you have the same number of combs in the extracting-super as in the brood-nest? S. T. Pettit preferred the same number; others preferred one comb less in the super.

In lifting combs from the super would you commence at once to brush off the bees? The general experience was that combs should remain a half minute or so. The bees are not so apt to resent the brushing as when done at once in lifting from the hive.—Canadian Bee Journal.

Every Present Subscriber of the Bee Journal should be an agent for it, and get all others possible to subscribe for it.

OLDEST BEE PAPER IN AMERICA ESTABLISHED IN 1861

THE AMERICAN BEE JOURNAL

PUBLISHED WEEKLY BY
GEORGE W. YORK & COMPANY,

56 Fifth Avenue, CHICAGO, ILL.

REGULAR CONTRIBUTORS :

G. M. Doolittle, of New York. Prof. A. J. Cook, of California.
Dr. C. C. Miller, of Illinois. Dr. J. P. H. Brown, of Georgia.
J. H. Martin, of California. Rev. E. T. Abbott, of Missouri.
Chas. Dadant & Son, of Illinois.

\$1.00 a Year—Sample Copy Sent Free.

[Entered at the Post-Office at Chicago as Second-Class Mail-Matter.]

Vol. XXXVI. CHICAGO, ILL., FEB. 13, 1896. No. 7.



The Bee-Keepers' Union Election of officers for 1896 resulted as follows:

President—Hon. R. L. Taylor. Vice-Presidents—Prof. A. J. Cook, G. M. Doolittle, Dr. C. C. Miller, Hon. Eugene Secor, and A. I. Root. General Manager, Secretary and Treasurer—Thomas G. Newman.

On page 110 of this number will be found the vote in detail. All the officers were re-elected, which is just as it should be whenever any set of officers give the universal satisfaction that these Bee-Keepers' Union officers have given. The Union has lost none of its old-time vigor and usefulness, and no doubt will continue to wield a beneficent influence upon the bee-keeping industry. But it should have thousands of members instead of hundreds. Why not send \$1.00 to the General Manager now, if you are not already a member? You owe it to yourself and to the pursuit to be a member of the National Bee-Keepers' Union.

Langstroth Monument Fund.—A number of our readers have suggested the beginning of a fund for the purchase and erection of a monument over the place where lies all that was mortal of our beloved Father Langstroth. We are very willing to receive subscriptions for this commendable purpose, and on page 107 of this number we give a list as a starter.

It is thought best by some to have the contributions somewhat small in the individual amounts, as then a larger number of bee-keepers would feel that they could help in the matter. But, of course, none need feel at all limited if they desire to give in excess of others.

We shall be pleased to take care of whatever money is sent to us for this purpose, and will, at the right time, turn it over to the proper committee who will have in charge the erection of the monument. Gleanings has already announced itself as ready to receive contributions, and we presume the other bee-papers will also. Let there be a general feeling of willingness to take advantage of this last opportunity offered to show our esteem for our loved Langstroth, who in his great invention of a bee-hive bestowed upon the bee-keeping world such a substantial and permanent blessing.

The Canadian Pure-Honey Bill.—Mr. Wm. McEvoy, Foul Brood Inspector of the Province of Ontario, wrote us as follows concerning this Bill, on Feb. 8:

Our Pure-Honey Bill has passed its second reading in the House of Commons at Ottawa, Canada, and as the third reading is only a matter of form, our Pure-Honey Bill is just as good as passed. I feel so rejoiced over our great victory in getting our Pure-Honey

Bill passed, that I feel just like "hollerin'." We went in to win, and did our work as if our life depended upon it.

I enclose a copy of the Bill, which had to go before a Committee in Parliament after it passed the second reading, and it went through their hands day before yesterday, and is not changed any worth noticing. This is a good Act, and when all of our honey is sold with plenty of copies of this Act, to all the dealers in Canada and foreign lands, won't it give the public more confidence, and increase pure honey sales more than anything else on earth could do? Hurrah for our laws!

WM. McEVoy.

The Pure-Honey Bill referred to by Mr. McEvoy in the foregoing, reads thus:

BILL NO. 10.

An Act further to amend the Act respecting the Adulteration of Food, Drugs, and Agricultural Fertilizers.

Her Majesty, by and with the advice and consent of the Senate and House of Commons of Canada, enacts as follows:

1. No imitation of honey, or "sugar-honey" so-called, or other substitute for honey manufactured or produced from cane sugar, or from any other substances other than those which bees gather from natural sources, shall be manufactured or produced or offered for sale in Canada, or sold therein; and every person who contravenes the provisions of this Act in any manner shall, on summary conviction, incur a penalty not exceeding four hundred dollars, and not less than one hundred dollars, and in default of payment shall be liable to imprisonment for a term not exceeding twelve months, and not less than three months: Provided that this Act shall not be interpreted or construed to prevent the giving of sugar in any form to the bees, to be consumed by them as food.

2. Section six to thirty, both inclusive, of *The Adulteration Act* shall, so far as they are applicable, be held to apply to this Act in the same way as if the adulteration of honey were especially mentioned therein.

Mr. Benton's Book may yet be issued in sufficient quantity to accommodate all who desire it. The original 1,000 copies, we understand, did not last long, and so a joint resolution has been introduced by Representative Wadsworth, of New York, to authorize the printing of 20,000 more copies. Hon. Geo. E. Hilton thinks there should be 100,000 copies of it printed, if all among the estimated 300,000 bee-keepers who want it are to be supplied. Mr. Hilton suggests that we advise all our readers to write their senators and representatives to not only support the joint resolution, but ask that it be amended so that 100,000 copies may be published.

We hope next week to give a review of Mr. Benton's book, when bee-keepers will be able to see just what it is. From a very hasty glance at it, we should say it is about the finest small work on bee-keeping that has been published in this country. Surely the many illustrations are exceedingly fine.

Sweet Clover Honey.—There are quite a number of bee-keepers, we find, who are not familiar with honey gathered from sweet clover. They no doubt would pay more attention to sowing sweet clover seed if they knew what an excellent honey the plant produces. An opportunity was given us lately to buy some of as nearly pure sweet clover extracted honey as we believe can be produced, and in order that all who wish may have a sample, we will mail it for 12 cents in stamps. We have a few 60-lb. cans of it, and will ship one can for \$5.00, on board cars here. We consider it equal to anything we ever tasted in the line of honey. Send for a sample, and see what you think of it.

Advertisements with the Reading-Matter.—Among those who recently, upon request, made suggestions in the line of improving the Bee Journal, were one or two who said they preferred to have the advertisements separate. But one of those who answer questions in the "Question-Box," has this to say about it:

MR. EDITOR:—If I could have a bee-journal just to suit me, it would not have an advertisement in it. Neither would it have a word in it about anything except bees and bee-keeping, and nothing about them except what applies to latitude 42 degrees north. Nothing about extracted honey, only comb honey. Every page and every line would be filled with matter that would be helpful to me in my work, and every number would be entirely made up of matter I had never before heard of. But not being quite a fool, I would not expect to get such a paper unless I expected to pay something more than a dollar a year for it. And every man who puts an advertisement in my paper is helping me to pay for it. If there are advertisements galore, the money that comes from them will help the publishers to pay for more pictures, more everything that makes a good bee-paper. So when I see plenty of advertisements in a paper, instead of feeling that I am cheated by that, I know that it means the publishers can do better work for it, and if they are wise enough I know they will. Advertisers will pay more money for having their advertisements on the same pages with the reading-matter, and although I don't like the looks of it

quite so well, I prefer, on the whole, to have it so, for it means I can have that much more for my money.

Come to think of it, quality and quantity of contents are more than looks, and if there are advertisements on every page it won't take more than 30 seconds longer to leaf over the pages. So, Messrs. Publishers, try to have half of every page filled with advertisements, and then put in some more pages. I still think I would like to take a paper such as I first described, and if you can get up one at \$50 a year, please put me down as a subscriber. Or how much would it cost?

Well, sir, you have succeeded in putting the case pretty well. If we were to omit all advertisements from the Bee Journal, every subscriber would have to pay at least \$2.00 a year instead of \$1.00, so by having advertisements there is quite a saving to bee-keepers. Besides, the great majority want to know where they can buy queens, bee-supplies, etc., and doubtless wouldn't have a bee-paper without any advertisements in it.

As you say, it is true that advertisers prefer their notices put with the reading-matter, and as it is no inconvenience at all to the reader to have it so, there is no good reason why the advertiser shouldn't be gratified in his wish. Each advertiser pays in any paper just for say an inch space one time, as much, or more, than a subscriber pays for a whole year's subscription; and as there are so few subscribers who are so whimsical as to care anything about the matter anyway, it is better to strive to please the advertiser in this case, particularly as there is no sacrifice of principle.

But if only one or two subscribers insist on having no advertisements in their copies, we couldn't accommodate them short of \$50 a week each. Very few could afford that at present prices of honey, we think!

Questions AND Answers

CONDUCTED BY

DR. C. C. MILLER, MARENGO, ILL.

[Questions may be mailed to the Bee Journal, or to Dr. Miller direct.]

May Be Short of Stores.

My bees are in the cellar, and in a condition generally agreed upon as the best, except a possibility that some may be short of stores, as I was unable, at the right time, to attend to them closely in that particular. Would it be safe and better to leave them alone until they fail to respond as promptly as usual to a tap on the hive? or should they be examined? (They are in frame hives.) The point is, what would you do? Sound Beach, Conn., Jan. 20. E. M.

ANSWER.—If I thought only a very small portion were in danger of being short of stores, I think I'd risk their starving rather than to risk hurting all the rest by opening them up, and I don't think I'd want to be tapping them every day. If, on the other hand, I thought a sufficient number were in danger of starving to make it a serious matter, I'd try to find out for certain by weighing or looking into the hives, and then I'd give enough to all that were at all doubtful, using combs of honey or else candy.

Putting Bees Out of the Cellar.

1. Where one has from 125 to 200 colonies of bees in the cellar to be put out in the spring, what kind of weather should it be when they are put out?
2. About what should the thermometer register?
3. Should it be in the morning, at noon, or evening?
4. Should they be put out all at one time, or at intervals?
5. If at intervals, about how much time should elapse, and how many should be put out in each lot?
6. When put out, should one begin at one side of the yard and fill each row of stands until they are all out, or fill and then skip alternately, and thus repeat until all is full?
7. I have had hives crowded and over-run with bees in a few hours after they had been put out, even so they would cluster on the outside of the hive in large numbers; appar-

ently they came from several hives, as I could not detect the loss from any one, or the direction they came from. What was the cause?

8. How can it be prevented? When it happens, what is the best thing to do? NORTHERN NEW YORK.

ANSWERS.—1. A still day, with bright sunshine.

2. Fifty degrees or more; but if you're sure of your day, and handle the bees quietly, you can commence in the morning early at 40° if you feel sure it will go up to 50° or 60°.

3. I prefer getting them out as early in the day as possible. However, if you could feel sure of a warm, nice day following, it would do to carry out in the evening.

4. Either way will do, but I like full as well to put them all out at once.

5. The intervals I have used have been such as to suit my own convenience. If I commence one morning, and after getting out a few it turns cloudy or cool, I stop and make an interval till the weather suits, whether it be the next day or the next week.

6. I think I have read of the skipping plan, but I never knew any harm to come from filling the rows straight along.

7. I've had something of the same kind, and it seems to be something like swarming out.

8. About all I've done has been to look on and wish they wouldn't act so. If some hives get more than their share of bees, I don't know that it does a great deal of harm. If so many should be in one hive that at night they would not all crowd in, I think I would take the bees that hang out in the evening and give them to some colony that needed more. Just after taking out of the cellar there isn't much trouble about putting bees from one hive into another.

Double vs. Single Walls for Dryness.

Will a double-walled hive, made of 3/4-inch lumber with a 3/4-inch dead-air space between the inner and outer wall, keep bees drier and better than a single-walled hive? We are not troubled with cold here, but rain. I do my own hive-making, and lumber is no object. J. O. W.

Cowlitz, Wash.

ANSWER.—I doubt it. After getting wet, the double wall would be slower in drying out. With lumber cheap, the best thing might be to have a good roof large enough to cover all the hives.

Probably Robbing.

What makes my bees fight at this season of the year, when we have a warm day so that they can fly? They are fighting all the time. Are they robbing? I do not have time to look after them as I ought to. J. W. W.

Sallisaw, Ind. Ter., Jan. 6.

ANSWER.—Without being on the ground, it isn't easy to say why they are fighting, but very likely it is as you suspect, simply that they are trying to rob. If you find the fighting mainly at one hive, throw some loose hay or straw at the entrance. That will allow passage for the bees that belong to the hive, but robbers are a little shy of going into a place where they can't make an easy and prompt retreat.

The Use of the Bee-Escape.

Man—especially the bee-man—never is, but always to be, blessed; and I'm blessed if Simmins, in the new edition of his "Modern Bee-Farm," hasn't been loudly decrying the use of bee-escapes—that perfect invention that was going to save us all so much stinging, anxiety, blasphemy and work, and smooth our way to fortune. Back again to the primitive smoke and brush! Verily, we are progressing backwards! Simmins says: "As soon as bees are frightened they will commence to tear open the beautifully capped cells. This is one of the most forcible arguments that can be used in condemnation of the super-clearers, for the bees, once frightened by the lifting of the super, will not hesitate to break countless pinholes in the beautiful cappings." And on page 129 he alludes to bee-escapes as "an old and discarded fad." Does your experience permit of your endorsing these statements? S. A. D.

ANSWER.—It may be all right to call bee-escapes a fad, but I hardly see how any one can call them "old," and surely they are not "discarded" on this side the water. If a single bee-keeper that has been favorable to them has given up their

use, I don't remember to have seen it. I never before saw it charged against bee-escapes that it caused the bees to tear holes in the sections. Indeed, that is one of the strong points claimed for them, that the bees, being less frightened than by any other way, will *not* tear holes. To give a direct answer to your question, my own experience makes me believe that in no way other than by bee-escapes can I get bees out of sections with less tearing. At the same time I must say that I generally get them out by older methods without any tearing, and as it takes longer time with the escapes, I use them much less than many others. But at times I value some sort of escape highly.

Making Sugar Candy for Feeding.

I wish you would tell how to make sugar candy from granulated sugar and water; how to get it hard, and in what form you make it. If in a pan (to form it) will it not stick to the pan, and be hard to get it out? G. D.

ANSWER.—To tell the truth, I don't make it at all. I prefer to feed the bees plenty of sugar and water—providing they need feeding, or will need feeding—early enough so there will be no danger of scarcity through the winter. But if I had bees that were in danger of starving before spring, and had no combs of honey to give them, I should prepare candy for them after the instructions given in Root's "A B C of Bee-Culture." Take good, thick honey of the very best quality you can get, and warm it till it gets very thin. Then stir in pulverized sugar as long as it will take up the sugar. When it won't take up any more sugar, take it out of the dish and knead it with the hands, adding what more sugar it will take, making it a stiff dough. Then lay cakes an inch thick, over the frames.

If, however, you have no extracted honey, you may be obliged to make the hard candy out of sugar alone. Sprinkle granulated sugar into a dish on the stove containing hot or boiling water. Use a little more than twice as much sugar as water. Let it cook until a little of it dropped into cold water becomes hard. Then pour it into shallow dishes previously greased. If about an inch thick it will be in good shape to lay over the frames. It will be easier to get it out of the pan or dish before it gets entirely cold.

Preparing Bees for Moving.

1. How should bees be fixed for a trip of 300 or 400 miles, by railroad? They are in frame hives.

2. Where can I buy sweet clover seed, and what would probably be the cost per pound. S. W. S.
Dumout, Iowa.

ANSWERS.—1. First of all look out that they have plenty of air. Just how that can best be given depends upon the kind of hive. With almost any hive, however, you can have a frame covered with wire-cloth to take the place of the cover. If the hive has loose-hanging frames, they should be made fast in some way. One way is to drive nails through the ends of the top-bars into the rabbet, not driving them in so deep but that they can easily be drawn out by a claw-hammer. Or you can make sticks about as long as the depth of the frames, pushing them down between the frames at each end. At the top end of each of these sticks drive through an inch or an inch and a half wire-nail so the stick can't fall down between the frames. A sponge with water laid on top of the frames will be a good thing, especially if the weather is hot. Place the hives in the car with the frames running parallel with the railroad track, so they will the better stand the bumping of the cars. Better have the hives in some way fastened in their place so they won't be shot all over the car every time it is bumped.

2. I never knew so much call for sweet clover seed as at the present time. Last year the home supply gave out and there was none to be had except what was imported. That would probably have the effect of stimulating the home production so that there will likely be plenty of it to be had this year. Watch the advertising columns, and you will see who offers it.

The McEvoy Foul Brood Treatment is given in Dr. Howard's pamphlet on "Foul Brood; Its Natural History and Rational Treatment." It is the latest publication on the subject, and should be in the hands of every bee-keeper. Price, 25 cents; or clubbed with the Bee Journal for one year—both for \$1.10.



How Many Queens from a Nucleus?

My average number from a nucleus, during the past ten years, has been about two a month. Some nuclei do better, others not as well, so that it is always well to calculate on having a few more nuclei than you really expect you will need to fill all orders; and even then, if your case proves anything like mine, you will be obliged to return money for some unfilled orders at the end of the season.—G. M. DOOLITTLE, in *Gleanings*.

Big Hives and Swarming.

Dr. Miller says in *Gleanings*: "Nearly every year, for several years, I have had in each apiary one or two colonies as a sort of reservoir, in which were put frames of brood or honey to be taken care of, and to be drawn upon whenever needed. These 'piles,' as we called them, would run up three and four stories high, and it always seemed to me that they stored more honey in proportion to the number of bees than other colonies; and like your 'hummers,' not one of the 'piles' ever offered to swarm. But then, one reason for their not swarming may have been that they were weak colonies at the beginning of the harvest—too weak to take sections—and their growing strong was a work of degrees.

"Against the view that room alone prevented swarming, stands the fact that, in the past season, preparations for swarming were made in colonies having two stories, one of the stories being very little occupied, and no excluder between."

Foul Brood.

I have boiled the honey from diseased colonies and added one-half ounce salicil and about 60 pounds of honey, and fed the bees, with no bad result. That a spore of any bacilli can stand boiling for hours with impunity, as some Americans say, is a thing I cannot accept. A bullock would not only be dead, but tender at the same time, but a spore shall come to life again!—W. ABRAM, in *Australian Bee-Bulletin*.

House-Apiaries.

I have had the pleasure of handling bees in a house-
apiary for the past six years, and I indorse all that has been said in favor of them, and will add that this is certainly the way to care for bees in order to save labor, which, you will agree, is the greatest item of expense in the production of honey.

To be sure, the common out-door hive must be used, resting on shelves; the building painted in colors, large openings not less than 4x8 inches, cut in various forms. These are closed in the fall with a slide or board on the inside, with small auger-hole, or slat, to admit entrance to hives. In settled winter weather a board closes all up tight on the outside. For admitting light, one opening with shutter is sufficient for every two hives. Don't make the building too large, i. e., to contain any more cubic feet of space than is necessary for convenience in handling, on account of being much better for wintering if in close quarters.

A raised earth floor will keep dry, and does not sound, or disturb bees, when walking, or working with them.—E. E. SLINGERLAND, in *Gleanings*.

Burning or Water-Soaking Wax.

While it is true you can burn wax with direct steam, or live steam, you can hardly do so by sending that steam into water and transmitting the heat indirectly from the water to the wax. Wax will never burn when over water, because it can never get hotter than the boiling-point. The trouble with your wax is probably not burning, as you suppose, but water-soaking the wax. While in this condition it is quite spongy, and appears as if it had been ground up into meal. When a handful of it is grabbed up it can be pressed together, and the water can be squeezed out as from a sponge. The only way of restoring such wax is to subject it to a *dry* heat, where the water can pass off. The solar wax-extractors are the best means of rendering such wax back to its cake form. Trays of such wax placed in the stove oven will also dry it out.—*Gleanings*.

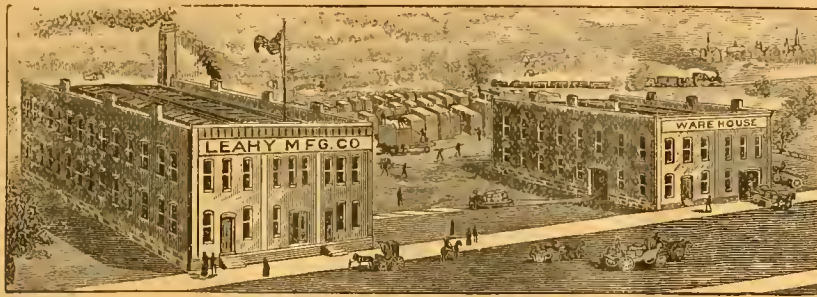

Largest Factory in the West COMPLETE STOCK. Good Supplies and Low Prices Our Motto.

READ THIS—Mr. Keyes says: The 100 pounds of Extra-Thin Foundation you sent us is superior to anything he ever saw; and I think the same. R. L. TUCKER, Wewahitchka, Fla.

Dear Sirs:—The Sections came duly to hand. Indeed, they are very nice. Yes, sir; they are as good as the best. CHARLES H. THIES, Steelville, Illinois.

Leahy Mfg. Co.:—I have received the bill of goods. I must say they are the choicest lot of Hive-Stuff I have ever received from any place. I admire the smoothness of your work, and your close selection of lumber. Yours very truly, O. K. OLMSTEAD, Orleans, Neb.

Dear Sirs:—The Sections arrived in due time, and are all O. K. so far as examined. I hope you are simply perfection. I can't see how you can furnish such goods at such low prices. I hope you may live long and do well. Yours respectfully, Z. S. WEAVER, Courtney, Tex.

Gents:—I received the "Higginsville Smoker" all O. K. It's a dandy; please find enclosed stamps for another. Yours truly, OTTO ENDERS, Oswego, N. Y.

Gentlemen:—I have bought Supplies from nearly all the large manufacturers by the carload, and I must say yours are as good as the best. Indeed, in many lines they are the best. It is a pleasure to handle them. E. T. FLANAGAN, Belleville, Illinois.

The above unsolicited testimonials are a fair sample of hundreds we receive. Our prices are reasonable and the "Higginsville Goods" are the best.

The "Higginsville" Goods are for sale by the following parties:

E. T. Flanagan, Belleville, Ill.
 E. A. Seelye, Bloomer, Arkansas.
 P. J. Thomas, Fredonia, Kans.

Chas. H. Thies, Steelville, Ill.
 Henry L. Miller, Topeka, Kans.
 J. W. Rouse & Co., Mexico, Mo.

And by a number of others.

If you need a Carload of Supplies, or only a Bee-Smoker, write to us. Remember, we are here to serve you, and will, if you give us a chance. **A Beautiful Catalogue Free.**

Address, **LEAHY MANUFACTURING CO., HIGGINSVILLE, MO.**
 49A Mention the American Bee Journal.

The Langstroth Monument Fund.

Contributors.

Geo. W. Brodbeck.....	\$1.00
Dr. C. C. Miller.....	.50
Geo. W. York.....	.50
Mattie C. Godfrey.....	.25
Total.....	\$2.25

General Items.

A Splendid Showing for 1895.

My report is 39 colonies in the spring of 1895, and 150 in the fall; 3,000 pounds of comb honey and 3,000 of extracted. That shows three swarms from each colony, and 150 pounds of honey per colony, spring count. That beats anything that ever struck this section, although Minnesota is a good State, and probably can furnish its share of bread and butter and honey.

Osakis, Minn., Jan. 4. M. S. SNOW.

That Home Market for Honey.

I believe it of much importance for beekeepers to create, supply, and keep supplied, a home market. It can be done, as I know by personal experience. I work, besides, under a great disadvantage, being very deaf. However, year by year, I extend my market, so that now I supply 60 or more stores with extracted honey in pint jars. I continue a steady and much interested reader of the American Bee Journal. It and Gleanings, make a powerful team.

Yours for first-class, ripe honey, sold in one's home market. ALFRED MOTTAZ.
 Utica, Ill.

The Non-Swarming-Bee Question.

I am not deeply interested in the non-swarming-bee question, save as one of prospective importance; I doubt my ability to throw any light upon it; and I feel that I am not really entitled to the last "say." Moreover, I shouldn't wonder if the readers thought the same, and were nearly ready to see this subject follow the queen-clipping matter off the stage. Therefore, I will make a few general statements based upon Mr. Lownes' article, on page 808 (1895), and then "abscond." I answer his remarks briefly, as follows:

Animal will is nothing but an expression through instinct of the needs of animal nature, which is no stronger, grade for grade, higher form compared with higher form, or lower with lower, than plant nature. You change the natural need or bent, and the "will changing" will take care of itself. The will of an insect to sip honey from a plant, and the will of a plant, as the "Venus' fly-trap," to clasp with its leaves and digest the insect alighting thereon, have a common origin.

"Bees do not swarm or hens sit for the love of their posterity," but Nature impels them to do so because the author of Nature has regard for their posterity. We cannot "make a cross between the honey-bee and the bumble-bee;" but it is a fact of zoology, nevertheless, that just as widely different species of birds, mammals, etc., as of plants can be crossed, our control over one equaling that over the other.

No, I did not mean to say, or intimate, that artificial incubation has made hens non-sitters; but only that domestication, as all well know, has made all animals and plants more variable in all characteristics than they were before. For instance, man has bred into pigeons from one common stock anatomical differences that, found in Nature, would make not only different species but different genera. Mr. Lownes could never send me "into the jungle to get Leghorns;" for I would not expect to find any there. The various original species of jungle fowls alone are there by

There Is No Doubt About the MERIT of **THE KEYSTONE** **DEHORNING** KNIFE.

It cuts both ways, does not crush. One clip and the horns are off close. Write for circular. A. C. BROSIUS, Cochranville, Pa.

36E13t Please mention the American Bee Journal.

Honey-Clovers & Buckwheat SEED FOR SALE.

We have made arrangements so that we can furnish seed of several of the Clovers and Japanese Buckwheat, by freight or express, at the following prices, cash with order:

	10lb	50lb	100lb
Alsike Clover Seed.....	\$1.35	\$ 6.25	\$12.00
Sweet Clover Seed.....	1.25	5.50	10.00
White Clover Seed.....	2.40	11.35	22.00
Alfalfa Clover Seed.....	1.20	5.25	10.00
Crimson Clover Seed.....	1.00	4.00	7.00
Jap. Buckwheat Seed.....	.45	1.50	2.20

Prices subject to market changes.

The above prices include a good, new two-bushel bag with each order.

We guarantee all Seed first-class in every respect—in fact, THE BEST that can be gotten. Your orders are solicited.

GEORGE W. YORK & CO.,
 CHICAGO, ILLS.

ONE MAN WITH THE UNION COMBINATION SAW

Can do the work of four men using hand tools, in Rippling, Cutting-off, Mitering, Rabbling, Grooving, Gaining, Dadoing, Edging-up, Jointing Stuff, etc. Full Line of Foot and Hand Power Machinery. Sold on Trial. Catalogue Free.

SENECA FALLS MFG. CO.,
 46 Water St., SENECA FALLS, N. Y.
 1A1y Mention the American Bee Journal.

GIVING AWAY HIVES.

On all orders received before Feb. 15th for \$20.00 or over, we will send a "Half-Joint Hive," complete, ready for a swarm.

Send for '96 Circular.

I. J. STRINGHAM,
 105 Park Place. NEW YORK, N. Y.
 Mention the American Bee Journal.

CHEAP SECTIONS! CHEAP SECTIONS!

We have at this Branch among the Stock purchased of Thos. G Newman the following stock of Sections—not of our manufacture—which we desire to close out to make room for our Superior Extra Polished Sections.

In order to close them out quickly we offer them for the next 60 days, or while they last, at these special prices:

White Sections, 4 1/4 x 4 1/4.	Cream Sections, 4 1/4 x 4 1/4.
40,000 1 15-16 }1,000 for \$1.75	8,500 1 15-16 }1,000 for \$1.25
50,000 1 7/8 }2,000 for 3.00	}2,000 for 2.00
80,000 7-to-ft. }5,000 for 7.00	}5,000 for 4.50

With all orders for less than 5,000, add 25 cts. for cartage.

These Sections are of Wisconsin manufacture, and when made were doubtless considered as good as the best; but as compared with our Extra Polished Sections they are not up to the standard of to-day, but a decided bargain and should be closed out quickly at these very low prices. If you prefer a sample before ordering we will mail one for 5 cts. to cover postage.

The A. I. Root Co., 56 5th Ave., Chicago, Ill.

Nature. I deny that non-sitting fowls are so through any wildness of disposition. I have found the non-sitting Houdans and Crevecoeurs to be tamer than even Brahmas and Cochins. They are the most familiarly tame of fowls; and the non-sitting Leghorns are no wilder than the sitting games. The sitting jungle-fowl is the wildest of all. Any breed of animals and any variety of plants, if left entirely alone, would soon revert, or lapse back, to the original form of its species. The non-sitting or non-swarmling character would not be an exception.

As to the "Plymouth Rock hen, and getting fat on nothing," something can never be made from nothing. You can breed out all tendency to waste, and there it must stop.

As to "breeding our ears off entirely," it probably will never be tried. However, an extra tce was bred on each foot of the Dorkings, etc.

Having thus covered all the points advanced against me by Mr. Lownes, I retire from the arena, after making this statement of my position in brief:

1st. No reliable man will ever claim to have produced a strain of non-swarmling bees without first testing them and finding them so; and,

2nd. If some one does claim to have produced a non-swarmling strain, any one can say, "I don't believe it;" but none can assert that it is not so until he has tried those bees and actually found that they do swarm.

3rd. And let any one keep trying to produce them who wants to do so.

Monterey, Calif. A. NORTON.

Results of the Past Season.

My last year's crop of honey amounted to 1,042 pounds, and it is almost all sold at home. I had only 54 colonies of bees, and they have plenty of winter stores besides.

H. K. GREEN.

Ridgeway, Pa., Jan. 13.

Bees Did Fairly Well.

My bees did fairly well last season, taking 2,000 pounds of mostly extracted honey from 40 colonies, spring count, and increased to 50, with plenty of stores for winter. Some colonies gathered over 100 pounds. Success to the Bee Journal.

GEO. W. WILSON.

Hylton, Tex., Jan. 18.

Another Honey-Buying Fraud.

On pages 817 and 818 is a letter from E. B. Huffman about marketing honey. After reading it I remarked that misery loves company. It is so near what I experienced myself that I concluded to tell the readers of the Bee Journal where my man is located—not in Chicago, but in Toronto, Ont.

In August, 1895, I received an order from C. A. Hirschfelder, of Rosedale, Toronto, for 300 pounds of honey, stating that he wanted it for a college there, and that he would send me a postoffice order for the amount on its receipt. But, as in the case of Mr.

Huffman, that postoffice order never came, and my attorneys report the man to be worthless. This man Hirschfelder has been an American Vice-Council in Toronto, but in the month of June last, he had to quit the office on account of his conduct.

So now, brother bee-keepers, in every land where the American Bee Journal is read, take notice, and be careful to whom you sell your hard-earned product; and when a man of the stamp of Dingsman or Hirschfelder calls on you in any way, just give them an introduction to your shoemaker!

W. J. BROWN.

Chard, Ont., Canada.

The "Marriage" Forbidden.

As a member of the Bee-Keepers' Union I have a right to say a few words about its proposed marriage with the North American Bee-Keepers' Association. I was one of the earliest members of the Union, and have paid as much toward its bank account as any one. I look at it as I would look upon an old man who had spent his whole life in social pleasures, and in his dotage and poverty seeking the hand of a rich young woman, who had been prudent and economical, and was helpful to her family and friends. He says, "Marry me, and give me the disposition of your money, and we will have much pleasure in attending all the social parties in the country; and when your money is all gone, we will call on your friends for more, and if they do not hand it over promptly we will disinherite them."

Now, as one of the family of "the bride," I forbid the bans. I fear that the proposed marriage will impair the usefulness of the Bee-Keepers' Union.

L. EASTWOOD.

Waterville, Ohio.

Two Good Years for Bees.

Seeing I am not a member of any bee-association, I would like to see a convention held somewhere close by, so that some of us northern bee-keepers could attend, and I must say that there are a good many bee-keepers springing up in the northern part of the State at present, and bees have done very well the last two years. Mine wintered without loss, but they did not swarm last summer. I had 4,800 pounds of comb honey from 35 colonies, and put them into winter quarters in good condition. The weather is very mild at present, with no snow. It is almost too warm for our bees.

JOHN HOFFMAN.

Clintonville, Wis., Jan. 20.

Back With the Bees Again.

Possibly some of my old-time friends of the 70's and 80's, not having heard from me for several years, imagine I "crossed the river." I wish to assure them now that I am still in the land of the living.

In 1889, I received an appointment as United States gauger in the Internal Revenue service, at \$5.00 per day. This induced me to leave my home and my bees here, and move to Peoria, Ill., where I



PEERLESS FEED GRINDERS.

Old Reliable Absolutely Guaranteed

Will grind to any desired degree of fineness. Ear Corn, Oats, Etc., and do more of it than any mill on earth. Write at once for prices and agency. There is MONEY IN THEM. Quality Best and Prices Right.

JOLIET STROWBRIDGE CO., Joliet Ills., Farm Machinery, Carriages, Windmills, &c.

Mention the American Bee Journal. 34A26



WHITE FACED BLACK SPANISH POULTRY

40 Standard Breeds Illustrated & fully described in my new Poultry Book. Reliable information for poultrymen & intending buyers. Good stock Ducks & Geese; also Sutherland Fowls, Sand & Co. in stamps.

E. H. COOK, Box 27, Suptley, Ill.

Mention the American Bee Journal. 4A13t

WANTED.

10,000 pounds of BEESWAX, for Cash. Address, **LEAHY MFG. CO., Higginsville, Mo.**

PATENT WIRED COMB FOUNDATION

Has No Sag in Brood-Frames

Thin Flat-Bottom Foundation

Has No Fishbone in the Surplus Honey.

Being the cleanest is usually worked the quickest of any Foundation made

J. VAN DEUSEN & SONS,
Sole Manufacturers,
Sprout Brook Montgomery Co., N. Y.

For Sale—A Dozen Colonies of 1-foot tall and Carniolan Bees in 8-frame Langstroth-Simplicity hives. The Combs all built on full sheets of foundation, wired in, and straight as a board. Seven of the Queens are imported, and all are of last year's rearing. Will be sold at \$5.50 per colony for imported and \$4.50 for native. Bees are in fine condition with plenty of stores to carry them through.

W. J. CULLINAN,
7A1t QUINCY, ILL.



NEW MAMMOTH Poultry Guide for 1896 Finest book ever published, contains nearly 100 pages, all printed in colors, plans for best poultry houses, sure remedies and recipes for all diseases, and how to make poultry and gardening pay. Sent post paid for 15c. **John Bauscher, Jr., box 94 Freeport, Ill.**

49A13t Mention the American Bee Journal.



OLDS' SEED POTATOES

Took First Premium last fall at Ills., Wis. and Mich. State Fairs. A tremendous stock. A good year to obtain Choice Seed of Improved Varieties. Prices Low, for this reason most people will not plant many potatoes. **Now is the time for you to plant.** Illustrated catalogue of field and garden seeds **Free.** **L. L. OLDS, Clinton, Rock Co., Wis.**

Mention the American Bee Journal.



Promptness Is What Counts!

Honey-Jars, Shipping-Cases, and everything that bee-keepers use. **Root's Goods at Root's Prices,** and the best shipping point in the country. Dealer in Honey and Beeswax. Catalogue Free.

Walter S. Poudler
162 Mass. Ave. INDIANAPOLIS, IND.

Got Something for Nothing!

Did You? Thousands of readers answering my ad. in the past received free by mail at a cost of 20 cents to me, a package of my discovery, **VITÆ ORE,** and 90 per cent. have written to thank me and send cash order for more, declaring that it had done them more good than all doctors and man-made remedies they ever used. I scorn to take any one's money until convinced at my expense that **V. O.** is the best thing in, on, or out of the earth for all who suffer from ills no doctor or drug will cure, such as general debility, feebleness from overwork, worries, cares, protracted sickness, old age, female complaints, all kidney and membranous ailments. It is the only natural, Nature's cure for human ills ever offered to man, and not by a quack doctor or methods peculiar thereto. If you have been bamboozled often, and grievously, by robbers in the medicine business, I am not responsible therefor, but am if **V. O.** fails to give greater satisfaction than all else you ever tried. Send the addresses of six sick people and I will do the balance.

THEO. NOEL, Geologist, Tacoma Building, Chicago, Ill.

6A4t

Mention the Bee Journal.

California

If you care to know of its Fruits, Flowers Climate or Resources, send for a Sample Copy of California's Favorite Paper—

The Pacific Rural Press

The leading Horticultural and Agricultural paper of the Pacific Coast. Published weekly, handsomely illustrated, \$2.00 per annum. Sample Copy Free.

PACIFIC RURAL PRESS,

220 Market St., - SAN FRANCISCO, CAL.

Mention the American Bee Journal.



OUR POULTRY ANNUAL

and Book of Valuable Recipes, 64 large pages, contains 8 beautiful colored plates of fowls, gives description and prices of 45 varieties, with important hints on care of poultry, and pages of recipes of great value to everyone. Finest Poultry Book published for 1896. Postpaid only 10 cts. **C. N. Bowers, Box 24, Dakota, Ill.**

52A13 Mention the American Bee Journal.

WANTED!

10,000 pounds of BEESWAX, for Cash. Address,

LEAHY MFG. CO., Higginsville, Mo.

Mention the American Bee Journal.



SUCCESSFUL INCUBATOR

Our magnificent new catalogue giving full information regarding a: 1. Hatching & Brooding and treatise on poultry raising sent for 4c stamps. Circular free.

Write now, **Des Moines Incubator Co., Box 78 Des Moines, Ia.**

49A13t Mention the American Bee Journal.

For Sale—A Bargain.

119 Colonies of Italian Bees in Chaff Hives. Good House, and 2 acres of Land, with excellent well of water. **E. L. CARRINGTON,**

5A4t **PETTUS, Bee Co., TEX.**

Mention the American Bee Journal.

CALIFORNIA, "WAKE UP!"

The Pacific Bee Journal, devoted to the Protection and Advancement of Bee-Keepers' Interests on the Pacific Slope. 50 cts. per year. Send for sample copy.

THE BENNETT BEE-HIVE COMPANY

now make Foundation at 40 cents per pound. Bee-Hive Bodies (plain covers) 17½c. each. Common Bee-Hive, 2-story, 60 cts. each. Dovetailed Hives, \$1.00 each.

Sections and Supplies low. Send for Price-List, and Save Money.

365 E. Second St., **LOS ANGELES.**

Mention the American Bee Journal.

DO NOT ORDER UNTIL YOU HAVE WRITTEN US FOR PRICES ON

The "Boss" One-Piece Section

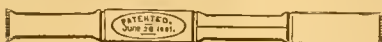

Also **D. T. Hives, Shipping-Crates and Other Supplies.**

We have completed a large addition to our Factory, which doubles our floor room; we are therefore in better shape than ever to fill orders on short notice. Send for Price-List

J. FORNCROOK,

WATERTOWN, Jeff. Co., Wis., Jan. 1st, 1896.

Mention the American Bee Journal.

measured many thousands of barrels of spirits fermenti, and determined the amount of tax due Uncle Sam. But, like all things earthly, my "good job" came to an end, and I am now back with the bees.

When I moved away I left a man in charge of my home and my bees, but he did not prove an eminent success. I find I have only 40 colonies now to begin next season's work with, and a chance, of course, of losing part of these between now and white clover bloom. I have always wintered my bees on the summer stands, in double-walled hives packed with sawdust and chaff, and my winter losses and spring dwindling have never been serious.

Of course, I do not claim to be up-to-date now in the bee-business, but I will fall in again, and endeavor to keep up with the procession.

My earnest wish now is that we may have an abundant crop of white clover next summer, with plenty of rain.

Gilson, Ill., Jan. 6. C. W. McKOWN.

Poor Honey Season.

We had the poorest honey season last summer that we had had in years. I had 12 colonies, spring count, got 618 pounds of honey, and no increase.

I think the American Bee Journal a splendid paper, that every bee-man ought to take.

Eureka, Mich. LEVI KIRBY.

The Season of 1895.

I started last spring with 15 colonies, 13 in good condition. We had nice weather the last days in April, and the first ten in May, with light thunder showers, but May 12 we had a heavy frost, and that night and the next day a heavy snow storm, the snow froze on the fruit-trees, so that some limbs broke off. May 14 it froze very hard, and a week later again. I saw drones about ten days earlier than other years, but in June and July the bees killed them all. The first three weeks in August they were busy on buckwheat, but there was only a few acres in reach of the bees. August 17 I had a swarm; I gave them seven frames with honey, and three with comb foundation.

We did not get any honey here. I bought about 15 pounds of sugar to feed the bees. One of my neighbors, who has 10 colonies, gave them about 20 pounds of honey in June, and bought \$7.00 worth sugar and fed them in the fall.

My cellar is cemented where I keep my bees in winter. **WM. DUESCHER,**

Wrightstown, Wis., Jan. 17.

Bees Wintering All Right.

So far as I know, bees are wintering all right out-doors. They did not do much last summer here. I got 250 pounds of honey, mostly from buckwheat. There were 42 acres about a mile from them; no clover, and but little basswood. I hope for better times to come. My bees are all in long sheds packed all around with chaff. I had to feed four of them with sugar syrup. **D. D. DANHER,**

Madison, Wis., Jan. 25.

Sweet Clover Growing in Florida.

When I came to St. Andrews Bay for the first time, five years ago, I brought some sweet clover seed with me, hoping to introduce this plant for forage and honey. I've continued to sow it from year to year, in the edges of the t-tities, by the sides of the roads, in brush-heaps, and piles of oyster shells, on rotten shell walks, and on my own lots. I think that I've given it a faithful trial, and my only reward has been to see one plant last spring, which had disappeared on my return.

As far as my observation goes, it does not thrive on a loose soil. I've seen it upon country roads in Illinois so thick and high that they were almost impassable. It clings to clayey, gravelly hillsides, where scarcely

Honey & Beeswax Market Quotations.

CHICAGO, ILL., Jan. 18.—White clover and Linden comb honey is scarce and commands a premium over other grades of white of 1 to 3 cents per pound. There is a fair supply of other grades, which bring 12@13c. for white, and amber to dark ranges at 9@11c. Extracted is without special change; the Western ambers at 4½@5c.; white, 5@6c.; clover and basswood in cans and barrels, 6@7c. Beeswax, 28@30c. **R. A. B. & Co.**

CHICAGO, ILL., Jan. 20.—We are having good inquiry for fancy comb, but all other grades are selling slow. Dark comb will not sell on this market, and we would advise the producer not to ship it here. We are offering it as low as 9@10c., with no buyers. We quote: Fancy, 15c.; No. 1, 14c.; light amber, 12@13c. Extracted, light, 5@6½c.; dark, 4@5c. Beeswax, 28@30c. **J. A. L.**

PHILADELPHIA, PA., Jan. 3.—Honey has declined in this market during the holidays. Large lots of California honey arriving, and selling at 5c. in 60-lb. cans. We quote: Comb honey, fancy, 16c.; fair to good, 8@14c. Extracted, 4@5½c.; white clover, 10c. Beeswax, 30c. **W. A. S.**

BUFFALO, N. Y., Jan. 22.—Sales very light and market dull. We quote: Fancy white, 14@15c.; choice, 11@13c.; buckwheat, 7@9c. Extracted, 4@6c. Beeswax, 25@28c. **B. & Co.**

CINCINNATI, O., Jan. 22.—Demand is slow for comb honey, which brings 12@14c. for best white. The demand is fair for extracted honey at 4@7c., with a scant supply.

Beeswax is in good demand at 25@28c. for good to choice yellow. **C. F. M. & S.**

KANSAS CITY, Mo., Feb. 8.—The demand for comb and extracted is light. We quote: No. 1 white, 1-lbs., 13@14c.; No. 2, 12@13c.; No. 1 amber, 11@12c.; No. 2, 8@10c. Extracted, white, 5½@6c.; amber, 5@5½c. Beeswax, 22@25c. **C. C. C. & Co.**

List of Honey and Beeswax Dealers.

Most of whom Quote In this Journal.

Chicago, Ills.

R. A. BURNETT & Co., 163 South Water Street.

New York, N. Y.

F. I. SAGE & SON, 183 Reade Street.
HILDRETH BROS. & SEGELKEN,
120 & 122 West Broadway.
CHAS. ISRAEL & BROS., 486 Canal St.

Kansas City, Mo.

C. C. CLEMOMS & Co., 423 Walnut St.

Buffalo, N. Y.

BATTERSON & Co., 167 & 169 Scott St.

Hamilton, Ills.

CHAS. DADANT & SON.

Philadelphia, Pa.

WM. A. SELSER, 10 Vine St.

Cincinnati, Ohio.

C. F. MUTH & SON, cor. Freeman & Central avs.

BASSWOOD TREES!

Orders booked now for Spring delivery for

Nursery-Grown Basswood Seedlings

5 to 9 inches high, at \$2 00 per 100; 300 for \$5 or \$15.00 for 1000. Parties living east of the Mississippi river will be supplied direct from our Nurseries in Ohio. Satisfaction guaranteed.

A. H. FITCH,
702 Youngerman Bldg., DES MOINES, IOWA.
4A4f Mention the American Bee Journal.

Bee-Keepers' Photograph.

—We have now on hand a limited number of excellent photographs of prominent bee-keepers—a number of pictures on one card. The likeness of 49 of them are shown on one of the photographs, and 121 on the other. We will send them, postpaid, for 50 cents each, mailing from the 121 kind first; then after they are all gone, we will send the 49 kind. So those who order first will get the most "faces" for their money. Send orders to the Bee Journal office.

another plant could hold. It is a valuable acquisition where its good qualities are known. Stock learn to eat it, and fowls revel in it, as it comes up so rank and green before other clovers.

There was but little surplus honey stored in this locality during the past season, as the early part was very wet, followed by a severe drouth. The winter has been quite cool, with a number of frosts, yet there have been but a few days when bees did not fly and bring in pollen from the swamps. Intelligent bee-culture is moving slowly forward. MRS. L. HARRISON.

St. Andrews Bay, Fla., Jan. 18.

Breeding Out the Swarming Fever.

Mr. Doolittle has given a nice solution of the question, but oh, dear! to think of breeding out the swarm fever—*never, no never* can this be accomplished! Seasons may change the state of affairs, in which persons are led to believe certain theories have accomplished. Mr. D. may have a similar year to 1870. Some three or four years ago I had colonies that swarmed five and six times, each being hived. Since that time I have not had a swarm, and do all I could to make them swarm, nary a swarm issued. There is nothing in it. Mr. D. God so created the busy little bee with the instinct to swarm, the same as he created in man the power of will to love God or reject his salvation. J. A. GOLDEN.

Reinersville, Ohio.

Fair Crop—Wintering Well.

My last season's crop of honey was a fair one, mostly all white, from wild mustard and golden-rod. The bees are wintering well so far, in the cellars.

Tracy, Minn., Jan. 28. EVAN J. DAVIS.

Good Report from Florida.

My average yield for 1895, was 184 pounds of extracted honey from 26 colonies of hybrid bees, spring count, and increased to 46. H. F. BAKER.

Bristol, Fla., Jan. 21.

Results of Three Seasons.

The past was a very poor season for white honey in northeastern Ohio. Bass-wood huds were killed by frost, and white clover failed to secrete honey. My report is 2,000 pounds of honey, about 1,700 being extracted (all from fall bloom), from 50 colonies, spring count, many of them being reduced to a mere handful and a queen in the spring. My crop is all sold at 10 cents for extracted, and 12½ for comb honey, besides selling 400 or 500 pounds for my neighbors. I now have 60 colonies. Although two of the past three seasons were counted poor in this section, yet I have secured a total of about 9,000 pounds the past three seasons, from an average of less than 50 colonies, spring count. Bees are wintering well. B. W. PECK.

Richmond Centre, Ohio, Jan. 26.

Black Bees—Doubling Swarms.

Dr. Miller, I was just joking about the black bees. I felt good because I got a surplus when people 500 miles south of me didn't, but it is a fact that my blacks and hybrids have done better than my yellow beauties, and I think if you could have handled my bees they would have done much better. I raised 1,000 bushels of wheat, 1,200 of oats, 500 of corn, 125 of rye, 600 of potatoes, and made 35 tons of hay, and only hired 18 days' work in 1895. So I think my bees did well.

Can we put two or more swarms into one hive? My bees swarmed clear out of reason in 1895, so I tried doubling. I put 15 swarms into 5 hives, put 14 more into 7 hives, and run 4 back into the parent hive. Of the first, all came out queenless in three weeks; of the second, 2 came out queenless;

and of the third, I found 2 without any bees, and solid full of honey when I went to put them into the cellar. I had two old colonies that swarmed five times each.

S. M. ROBERTSON.

Grey Eagle, Minn., Jan. 18.

Bees Did Not Do Well.

The last two years the bees did not do well on account of the drouth. In 1894 they did not get enough, so I had to feed them to get them through the winter. The spring of 1895 started out finely till the frost came about May 10, which killed all the blossoms, and the white clover was frozen out so badly that there was hardly any left. But the fall was good, and the bees had 275 pounds of surplus honey. I have 12 colonies. I pack them in two boxes, 8x3, and 3 feet high, and then put chaff all around.

We have had a nice winter; it is so warm to-day (Jan. 22) that the bees are flying. LOUIS HARTING.

Arthur, Iowa.

The Bee-Keepers' Guide: Or Manual of the Apiary,

BY PROF. A. J. COOK.

This 15th and latest edition of Prof. Cook's magnificent book of 460 pages, in neat and substantial cloth binding, we propose to give away to our present subscribers, for the work of getting new subscribers for the American Bee Journal.

A description of the book here is quite unnecessary—it is simply the most complete scientific and practical bee-book published to-day. Fully illustrated, and all written in the most fascinating style. The author is also too well-known to the whole bee-world to require any introduction. No bee-keeper is fully equipped, or his library complete, without "THE BEE-KEEPER'S GUIDE."

For Two New Subscribers and Your Own Renewal.

Send us Two New Subscribers to the Bee Journal and your own renewal (with \$1.00), and we will mail you a copy of Prof. Cook's book FREE as a premium, and also a copy of the 160-page "Bees and Honey" to each New Subscriber. Prof. Cook's book alone is \$1.25, or we club it with the Bee Journal for a year—both together for only \$1.75. But surely anybody can get only 2 new subscribers to the Bee Journal for a year, and thus get the book as a premium. Let everybody try for it. Will you have one?

ORIGINAL BINGHAM SMOKERS

Wonderful Record!

HAVE LASTED 17 YEARS.

—BEST ON EARTH.

Always Give Perfect Satisfaction.

My cool Wire Handle and Bent Nose were patented 1892, are the original, my best invention since my open or direct draft Patent, 1878, that revolutionized Bee-Smokers. My Handle and Nose Patent bent all the other smoker noses. None but Bingham Smokers have all the best improvements. If you buy genuine Bingham Smokers and Honey-Knives you will never regret it. The "Doctor," ¼-inch larger than any other smoker on the market—3½-inch stove, by mail, \$1.50

Conqueror, 3 " "	1.10
Large, 2½-in. " "	1.00
Plain, 2-in. " "	.70
Little Wonder, 2-in., wt. 10 oz.	.60

Bingham & Hetherington Honey-Knives, 50 cents.

T. F. BINGHAM, Farwell, Mich.

7Atf Mention the Bee Journal.

The National Bee-Keepers' Union

ELECTION OF OFFICERS.

The canvass of all the votes received up to the time of closing the polls, on February 1, 1896, showed that 153 ballots were received, and they were given to the Judges of Election to open and count. The following is their Report:

CHICAGO, Feb. 5, 1896.

We, the Committee on Ballots of the National Bee-Keepers' Union, find the votes cast as follows, for Officers for 1896:

Total number of votes cast, 153, of which one was blank.

FOR PRESIDENT—

Hon. R. L. Taylor, 100; Dr. C. C. Miller, 17; Prof. A. J. Cook, 8; Hon. Eugene Secor, 5; A. I. Root, 5; G. M. Doolittle, 2; R. F. Holtermann, 2.—W. Z. Hutchinson, James Heddon, Geo. W. Brodbeck, G. W. Demaree, P. H. Elwood, C. P. Dadant, C. K. Decker, Chas. Dadant, C. F. Muth, Dr. J. P. H. Brown and Frank Benton, 1 each.

FOR VICE-PRESIDENTS.

Prof. A. J. Cook, 116; G. M. Doolittle, 115; Dr. C. C. Miller, 109; Hon. Eugene Secor, 101; A. I. Root, 91; G. W. York, 19; C. P. Dadant, 16; R. F. Holtermann, 16; Hon. R. L. Taylor, 14; E. R. Root, 14; C. F. Muth, 13; Geo. W. Brodbeck, 11; P. H. Elwood, 9; Dr. A. B. Mason, 8; G. W. Demaree, 8; Frank Benton, 7; W. Z. Hutchinson, 6; James Heddon, 6; Charles Dadant, 5; Hon. Geo. E. Hilton, 5; J. H. Martin, 4.—Jas. A. Stone, E. France, Thos. G. Newman, Rev. E. T. Abbott and Mrs. J. Atchley, 3 each.—Wm. McEvoy, J. A. Green, C. A. Hatch and R. Wilkin, 2 each.—B. Taylor, R. McKnight, Bob Ingersoll, C. S. Burley, G. G. Baldwin, James Arnott, H. G. Acklin, H. C. Wheeler, J. LaRue, O. C. Blanchard, M. H. Meudleson, Captain J. E. Hetherington, Wm. Muth-Rasmussen, C. Theilmann, L. A. Aspiwall, J. C. Wheeler, Dr. J. P. H. Brown, D. P. Steveson, E. A. Boone, J. T. Calvert, Mathias Hettel, D. C. McLeod, O. M. Pierson and A. W. Spracklen, 1 each.

FOR GENERAL MANAGER, SEC. AND TREAS.

Thomas G. Newman, 142; Geo. W. York, 4.—C. C. Miller, J. A. Green, J. T. Calvert, M. H. Meudleson and R. Dumphmore, 1 each.

Respectfully submitted,

C. C. MILLER, }
GEO. W. YORK, } *Committee.*

The old Officers are therefore all re-elected, to serve for another year.

THOMAS G. NEWMAN,
147 South Western Ave., Chicago, Ill.

Botanical Gazette.—Any of the readers of the Bee Journal who are interested in a periodical discussing the higher scientific phases of botanical subjects should write for a sample copy of the Botanical Gazette, which may be had by addressing Prof. J. C. Arthur, Purdue University, Lafayette, Ind. Mention this Journal.

Potatoes Sir William Maggle Murphy, World's Fair, Rural N. Y. No. 2, \$1.00 per bushel. 20 New Varieties. Catalogue Free.
J. F. MICHAEL,
1D6t GREENVILLE, OHIO.
Mention the American Bee Journal.

—LEADS THEM ALL S to 24½ %—
See reports of experiments with Comb Foundation at the government station, Lapeer, Mich. FREE—large illustrated Catalog of everything needed in the apiary. Full of information. M. H. Hunt, Bell Branch, Mich.
5Dtf Please mention this Journal.

WINTRY WEATHER WEAKENS

the system, lowers the vitality, and decreases the power of resistance against colds and chills. Many people are feeling weak and shivery just now. They complain of cold hands and feet. Their blood doesn't circulate properly; the raw, bleak air seems to go right through them. Others feel worn out, and lack vigor. They are bilious, nervous, have backaches, headaches, and a pale, sallow complexion. All these symptoms indicate that the liver and kidneys are out of order. Feeble circulation of the blood shows that the system is in a very low condition. People who feel like this are facing some dangers they little suspect.

LOOK OUT

for pneumonia, influenza, or some other dangerous complaint when you are in this state!

If you have any of these symptoms, and are not feeling as well as you ought to feel, do not wait until you are laid up with a serious illness. Act at once. Take something that will build up the system, put the blood in healthful motion, and act on the liver and kidneys. Prevention is better than cure.

There is only one way to get well. There is only one remedy that can make you well. The remedy you need is Warner's Safe Cure which is recommended and prescribed by physicians throughout the world. This great remedy contains the vital principle essential to the maintenance of health and strength. It increases the muscular energy, fortifies the system and builds up every part of the body. It has never been equaled as a cure for liver and kidney complaint, bladder trouble or Bright's disease. It is the great standard remedy, the best remedy, the most reliable remedy known to medical science. Every one who has ever tried it, believes in it.

If your health needs attention, do not experiment with inferior remedies. It is cheaper and wiser to take a remedy that has earned a world-wide reputation, which has stood the test of years, and has proved, in millions of cases, that it can always be depended upon to relieve and cure.

HATCH Chickens BY STEAM—
With the MODEL
EXCELSIOR Incubator



Simple, Perfect, Self-Regulating. Thousands in successful operation. Lowest priced First-class Hatcher made.
GEO. H. STARR,
114 to 122 S. 6th St. Quincy, Ill.

Send 6c. for this Catalogue.

Mention the American Bee Journal. 3A8t

COMB FOUNDATION WHOLESALE AND RETAIL.

Are you going to buy Foundation for Cash, or have you Wax to sell or trade for Foundation and other Supplies? Have you 25 lbs. or more of Wax that you want made into Foundation? If so, do not fail to write me for samples and prices. I make a specialty of working up Wax by the lb., and do it very cheap during the winter. Beeswax wanted at all times.

GUS DITTMER, AUGUSTA, WIS.
Reference—Angusta Bank, 16A4f

Mention the American Bee Journal.

Question - Box.

In the multitude of counsellors there is safety.—Prov. 11-14.

The Best Surplus Arrangement.

Query 5.—What do you think the best surplus arrangement—wide frames, or what?—GA.

Prof. A. J. Cook—I like the T super.

Mrs. L. Harrison—One-pound sections.

Dr. C. C. Miller—T supers suit me the best of all I've tried.

Dr. J. P. H. Brown—Top storing in section cases or holders.

W. R. Graham—I prefer sections or half-depth shallow frames.

H. D. Cutting—I have used the T super with the best results.

R. L. Taylor—Wide frames, if correctly made. Next to that is the Heddon case.

J. M. Hambaugh—Were I a comb-honey specialist, I think I would use the Miller T super.

C. H. Dibbern—I have a method of my own that I prefer to either wide frames or the tin T super.

P. H. Elwood—I have used wide frames and other styles, and do not find very much difference.

G. M. Doolittle—I use wide frames, and enjoy them much more than any "or what" ever invented.

E. France—I use a slatted super holding sections enough to cover the frames. Set it on over the brood-nest.

Emerson T. Abbott—A super with pattern-slats in the bottom, with followers and wedges at the side and end.

W. G. Larrabee—I use a slatted bottom super that holds 16 pounds, two to cover the top of the hive, which I like best.

Jas. A. Stone—4¼x4¼x2-inch sections, in section-cases, on wood strips cut the shape of the bottoms of the sections.

Allen Pringle—I presume you mean for sections. If so, then my answer is, I have never seen anything yet that suited me as well as the wide frames.

J. A. Green—Section-holders. These are wide frames for one tier of sections with separators, but no top-bar, fitting closely into an outer case, with beespace at the top.

G. W. Demaree—I have tried almost everything, and I like the T cases best of all. The "wide frame" is the worst of all the sticky traps I have thrown away, or met with.

J. E. Pond—I use the wide frame, and so far have found it satisfactory. Several kinds of surplus arrangements are used, but I have so far "stuck to" the old plan of wide frames.

B. Taylor—T supers with my slotted separators make the finest finished sections of anything I have used. I shall try single-tier wide frames without any case in connection with the new separators next season, and report.

Eugene Secor—I find mean by wide frames some such arrangement as the new Heddon super, that is all right. If you mean the old Root idea of sections

in wide frames, I don't like them. The new wide-frame section-holder is good. Also the T super.

Rev. M. Mahin—I have found wide frames pretty good, and yet after having used a small number of them at several times, I have discarded them, and I can hardly tell why. What I am using now is a little like the Heddon case, if I know what that is.

SUCCESSFUL FRUIT GROWERS
SPRAY THEIR TREES.
THE DEMING SPRAY PUMPS
ARE THE "WORLD'S BEST"

Send for complete catalogue and treatise on spraying, mailed FREE. **The DEMING CO.**
Henion & Hubbell, Salem, Ohio.
Western Agts., Chicago, Ill.

Mention the American Bee Journal.

MUTH'S HONEY EXTRACTOR
PERFECTION
Cold-Blast Smokers,
Square Glass Honey Jars, Etc.

For Circulars, apply to CHAS. F. MUTH & SON,
Cor. Freeman & Central Aves., Cincinnati, O.
Send 10c for Practical Hints to Bee-Keepers.

Mention the American Bee Journal.

MONEY IN ONIONS

If You Plant the RIGHT SEED.

My new handsomely illustrated SEED BOOK tells all about the best varieties of Onions and Everything of interest in the Seed Line; how to grow and market vegetables successfully—FREE if you write at once—to-day, P. O. Box 637

H. W. BUCKBEE,
ROCKFORD SEED FARMS,
ROCKFORD, ILL.

Mention the American Bee Journal.

TAKE NOTICE!

BEFORE placing your orders for SUPPLIES, write for prices on 1-Piece Basswood Sections, Bee-Hives, Shipping-Crates, Frames, Foundation, Smokers, etc.

PAGE & LYON MFG. CO.

NEW LONDON, WIS.

Mention the American Bee Journal.

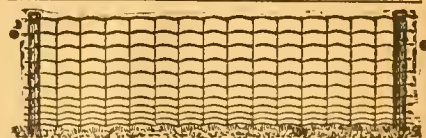

Have You Plenty of Money?

And land? Then buy all kinds of wire fences offered, and give them a fair test. Such an object lesson will prove valuable for yourself, your neighbors, and the

PAGE WOVEN WIRE FENCE CO., Adrian, Mich.

Mention the American Bee Journal.

IF YOU WANT THE

BEE-BOOK

That covers the whole Apicultural Field more completely than any other published, send \$1.25 to Prof. A. J. Cook, Claremont, Calif., for his

Bee-Keeper's Guide.

Liberal Discounts to the Trade.

Bottom Prices

**BRING US BIG TRADE.
GOOD GOODS KEEP IT.**

If you want the best supplies that can be made at a little less cost than you can buy the same goods for elsewhere, write to us for low prices. 1896 Catalogue now ready—ask for it and a free copy of **The American Bee-Keeper** (36 pages).

Address,
**THE W. T. FALCONER MFG. CO.,
JAMESTOWN, N. Y.**

Mention the American Bee Journal.

EVERGREENS!

and Ornamental trees, Nursery grown. 250 Choice Evergreens, 10 varieties, \$2. 400 Ornamental trees, 6 varieties, \$2. 50 other \$5 and \$10 bargains, 100 Scotch Pine, 2 ft. high, \$8; 1,000 10 to 12 inches \$10. All other varieties and sizes cheap. Local Agents Wanted. Send for Illustrated Catalogue. **FREE.**

**D. HILL, Evergreen Specialist,
DUNDEE, ILLINOIS.**
7A5t Please mention the Bee Journal.

HEADQUARTERS for ROOTS' GOODS

Can supply you with all the Fixtures used in an Apiary. Best Goods at Lowest Prices. Catalogue free. 5% discount until March 1st.
JNO. NEBEL & SON, High Hill, Mo.
Mention the American Bee Journal. 4Atf

The Rural Kansan

Is an Agricultural Journal for the busy farmer. It embraces Bee-Keeping and every department of industry connected with the farm. 30 cts. a year, monthly. Sample Free.

A Full **Higginsville Bee-Supplies** on Line of **CATALOGUE FREE.**
**HENRY L. MILLER,
355 Shawnee Ave., TOPEKA, KAN.**
1A13t *Mention the American Bee Journal.*

FOR SALE.

**ALSIKE, CRIMSON, ITALIAN, ALFALFA,
or WHITE CLOVER SEED.**
4A8t **WM. CRAIG, Luce, Mich.**
Mention the American Bee Journal.

Queen-Clipping Device.

I want the address of all who clip Queens and have even the least trouble either in catching or holding them while they are being clipped. I have invented a Device by which it is impossible to injure a Queen either in catching or clipping, unless it is done purposely. With it they are caught and clipped any way desired almost instantly. One does not have to touch the Queen with his hands, whatever. Price, postpaid, 50 cts. Send for Free Circular.
**C. MONETTE,
6A1f CHATFIELD, Fillmore Co., MINN.**

BEES QUEENS

Smokers, Sections, Comb Foundation, And all Apiarian Supplies cheap. Send for FREE catalogue.
E. T. FLANAGAN, Belleville, Ill.
6A26t Please mention the Bee Journal.

Golden Queens FROM— —TEXAS.

My Bees are bred **For Business** as well as for **Beauty and Gentleness.**

Safe arrival and reasonable satisfaction guaranteed. Write for Price-List.

Untested, \$1.00—Tested, \$1.50.

J. D. GIVENS, LISBON, TEX.
Box 3
6A26t Please mention the Bee Journal.

19th Year Dadant's Foundation 19th Year

Is still in the lead, for we use all the latest improvements, including the **NEW PROCESS**, and still make the best goods. Remember that we do not use any acid to purify our beeswax, and that is why our Foundation preserves the smell of the honey and is more acceptable to the bees, than any other. It is kept for sale by

G. K. Hubbard, Fort Wayne, Ind.
L. Hanssen, Davenport, Iowa.
C. Theilmann, Theilmanton, Minn.
E. C. Eaglesfield, Berlin, Wis.
E. T. Abbott, St. Joseph, Mo.
J. M. Jenkins, Wetumpka, Alabama
John Rey, East Saginaw, Mich.
Vickery Bros., Evansville, Ind.

The Jennie Atchley Company, Beeville, Texas.
C. F. Muth & Son, Cincinnati, Ohio
E. Kreschmer, Red Oak, Iowa.
Jos. Nysewander, Des Moines, Iowa.
G. B. Lewis Co., Watertown, Wis.
James Reynolds Elevator Co., Poughkeepsie, N. Y.
Page & Lyon, New London, Wis.
T. H. Strickler, Solomon City, Kansas.

and many other Dealers. All agree in saying that no goods are better than ours.

Those of our customers who formerly bought through Thos. G. Newman can get our Foundation in **Chicago, Ill.**, by addressing us at **56 Fifth Avenue**. We keep no other goods there.

We make a specialty of **Veils and Veil Stuffs** of best quality, cotton and silk.

Langstroth on the Honey-Bee, Revised.

Bee-Keepers' Supplies, Smokers, Sections, Tin Pails, etc.]

Samples of Foundation and Tulle FREE with Circular. Instructions to beginners with Circular. **BEESWAX WANTED.** Send us your address.

CHAS. DADANT & SON,

Mention the American Bee Journal.

HAMILTON, Hancock Co., ILL.

CASH PAID FOR BEESWAX

For all the **good, pure yellow BEESWAX** delivered to our office on or before Feb. 20, 1896, we will pay 26 cents per pound, cash; or 30 cents for whatever part is exchanged for Bee Journal subscription or books that we offer. If you want **cash promptly** for wax, send it on at once. Dark or impure wax not taken at any price. Address plainly,

George W. York & Co., 56 Fifth Ave., Chicago, Ill.

SECTIONS, BEE-HIVES, SHIPPING-CASES

We make a Specialty of these Goods, and defy Competition in

QUALITY, WORKMANSHIP AND PRICES.

Write for Free Illustrated Catalogue and Price-List.

G. B. LEWIS COMPANY, Watertown, Wis.

Be sure to mention the American Bee Journal when you write.

* ROOT'S COMB FOUNDATION! *

New Product.

We are pleased to announce that, having secured control of the new Weed process of manufacturing foundation for the U. S., we are prepared to furnish **Foundation by the New Process**, for 1896. Samples will be mailed free on application, and will speak for themselves.

New Process.

OUR SANDED and POLISHED SECTIONS, well, they will speak for themselves, also.

A Big Success

Our 1896 Catalog

will be ready for distribution now in a few days. Send in your name at once for catalog, samples of the new foundation, and those superb sections, and while you are about it ask for late copy of **Gleanings in Bee-Culture**.

THE A. I. ROOT CO., MEDINA, OHIO.

56 5th Ave., Chicago, Ill.

Syracuse, N. Y.

1024 Mississippi St., St. Paul, Minn.

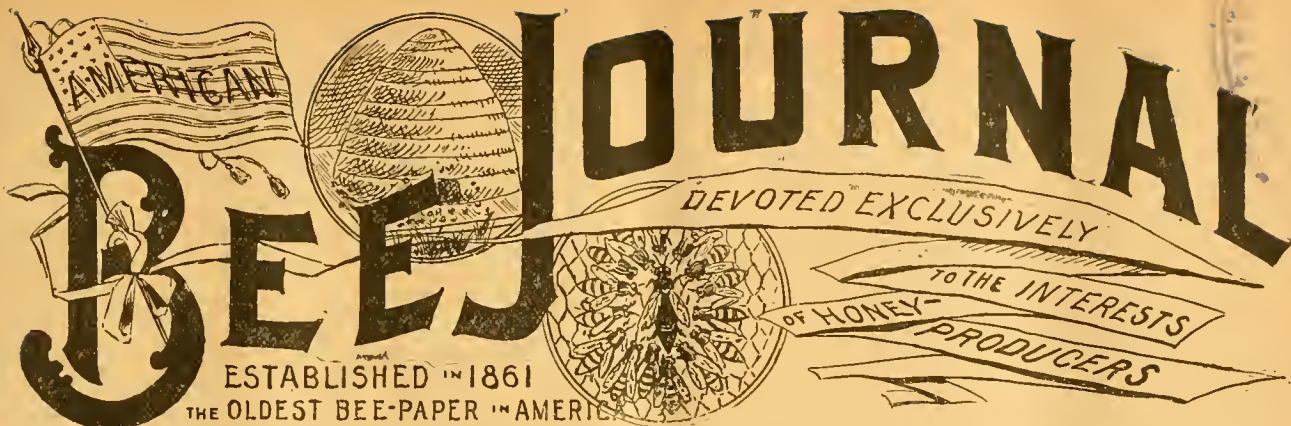

AMERICAN BEE JOURNAL

DEVOTED EXCLUSIVELY TO THE INTERESTS OF HONEY-PRODUCERS

ESTABLISHED 1861
THE OLDEST BEE-PAPER IN AMERICA

Published Weekly, at \$1.00 per annum.

Sample Copy sent on Application.

36th Year.

CHICAGO, ILL., FEB. 20, 1896.

No. 8.



Building Worker-Combs vs. Foundation.

BY G. M. DOOLITTLE.

A correspondent writes that he has seen somewhere in the bee-papers that I secure worker-combs by having them built in nucleus colonies, instead of buying comb foundation, and that he wishes I would tell something about it in the American Bee Journal, as he feels too poor to buy much foundation, as his bees have done little toward furnishing him anything to buy it with during the past three years.

As I have hundreds of nice, straight worker-combs, built in small colonies during the past, I will willingly give all the help I can, for I often think I can thus secure combs at a cost not exceeding one-half what foundation would cost me.

The colonies used in building combs are generally those left after uniting two weak colonies, just before the honey harvest, so as to make one strong one from the two, this strong one giving a good yield of honey, while the part left from the one giving strength to the united colony, is that which builds the combs.

In uniting, all the bees from hive No. 1 are taken to No. 2, except those which adhere to the frame which the queen is on and the sides of the hive, so that hive No. 1 only contains one comb of brood, the queen, and the bees which adhere to the hive. An empty comb is now inserted by the side of the only comb left, and a division-board adjusted to make a hive holding just two combs. When the bees from the united colony fly, the old bees taken on the frames of comb placed in No. 2 return to No. 1, so that we have the two combs there, well crowded with bees. This causes the queen to lay rapidly in the empty comb given, which will be filled with eggs in two or three days, at which time I put an empty frame between the two full ones, as this little colony has no desire to swarm—or for anything else, save to increase its number of worker-bees as fast as possible—they go right to work and fill this frame with as nice and straight worker-combs as ever was made where foundation is used; and this, too, when colonies having no such desire, will be doing comparatively nothing at gathering honey, or anything else.

In about a week this comb is completed, when it is taken out and given to some colony that needs just such a frame of comb and brood, while another empty frame is given which is again taken out when filled, and thus we keep on to the end of the season, when several of these little colonies are united, so as to form one good colony for winter. The extra queens are sold or used in replacing poor ones.

In this way I have gotten as high as 15 beautiful worker-combs built by one of these little colonies in one season, and all done by the bees which hatched from the two combs they had to start with.

Another way to make this little colony profitable is to use it as above till I get ready to take away the first comb built,

when, instead of taking it away I spread the three combs apart and put two empty frames between them. In about ten days these will be filled, when two more empty frames are put in, which will usually be filled with worker-comb, but not always; for by this time they begin to get strong, when some drone-comb may be built in the lower corners. When they will not build worker-comb any longer, the hive is filled up with worker-comb built by other little colonies, so that in the fall I have a nice colony for wintering.

If I do not wish to build the colony up for wintering as above, or it gets ahead too fast, so it will be likely to swarm and thus spoil my plans, I take all but one of its combs away from it, being sure that the queen is left with the bees, also leaving a comb that is completely filled with young brood, so the bees will feel their need of looking out for worker-brood again, when I insert four empty frames—two on either side of the comb of brood left—when I get four nice combs again. The secret of securing worker-comb built is in placing the bees in such shape that they will have no desire to swarm, but, on the contrary, will feel poor, and look ahead to the supplying of a force of worker-bees that they may be able to gather sustenance for winter.

As the united colony will give far more comb honey than would either or both of the colonies if left separate, it will be seen that we have made a gain in honey by this mode of procedure, and the combs we get are entire gain. Had we wished to work for extracted honey instead of comb honey, we probably could have gotten more honey by allowing the two colonies to have remained separate, still, in this case it would be doubtful whether the two separate would have accumulated much more than the united colony.

There is now and then a colony which will think they need some drone-comb under the circumstances given by the last plan, and if it is found that they are building drone-comb in either of the four frames, take away their frame of brood and put a comb containing more or less drone-brood, in its place, when they will cease to build anything but worker-comb.

In these days when we are buying dollars, it is necessary that we take advantage of all the little kinks in bee-culture which will save us anything, for the times are against the producers of wealth, and in favor of our money-kings. It takes 10 pounds of honey now to buy a dollar, while 3½ pounds of the same honey would buy the same dollar in the early 70's. Therefore it behoves us to make the best possible use of the dollars we buy, and not spend them for anything which we can produce at a less cost than the purchase price would be.

Borodino, N. Y.



Keeping Empty Combs from Moths.

BY C. DAVENPORT.

Some time ago Mr. Demaree wanted different ones to give their plan of keeping empty combs from being damaged by moth-worms. I will describe the way I do this, and since I have followed this plan it has been but very little trouble for me to prevent moths from damaging empty combs, or those filled or partly filled with honey, in spite of the fact that moths are very bad and destructive during warm weather in this locality. To me, moths seem to have very strange and mysterious ways, and I don't know but those we have here are different from those in other places, for I believe it has often been said that if empty combs that are free of moth-eggs, as well as moths, are put into a room or box in which

the moth-miller cannot go, they will not be damaged by moths. In this locality, some seasons, such combs so placed would be badly damaged by moth-worms. Combs seem to attract the moth-miller, and where there are many combs in a tight room or box, I believe if the miller cannot get at them she will often lay her eggs in cracks or crevices in the box or building where the combs are, and after the eggs hatch, instinct or something else, causes the moth-worm to crawl through to where the combs are. A young moth-worm can go through a very small hole—so small, in fact, that I believe it would be impossible to make a box out of wood that could keep them out.

Early in the spring, long before any moth-millers were around, I have taken combs that had been in a building all winter where the temperature would be nearly, if not quite, as low as it would be out-doors—and that means cold enough to kill any moth-worms; for in this locality we always have some very cold weather, and generally every winter one or two spells when the temperature will be down to nearly if not quite 40° below zero for two or three days—I have put combs, thus exposed, into tight boxes which had also been exposed all winter, and nailed covers on, and fixed them so that no moth-miller could possibly get inside, yet I have had combs so placed badly damaged by moths.

When I have empty combs to preserve, I also have empty hives, and I always wanted some plan by which I could keep the combs in the hives without their being damaged by moths, and without the trouble and work of sulphuring them every ten days or so. I finally hit upon a plan by which this could be done, with practically no work or expense. This will work just as well if the hives are tiered up out-doors—in fact, I prefer to keep the hives containing the empty or filled combs right in the yard where they can be gotten at easily when wanted.

Now all that is necessary to do this, is to get some tarred paper—common tar building-paper, which can be had from almost any hardware store, or lumber yard; this should be cut just the size of the top of the hive, large enough so that it will come out even with the outer edge of the hive all around. With hives that have the entrance cut from them it will be necessary to nail a strip on to close the crack this entrance would cause when the hives are tiered up. With a hive made on the same principle as the dovetailed, all that is necessary to do is to place the combs in the hive-bodies, then take a bottom-board and turn it bottom side up. (The bottom-board is turned wrong side up, so as not to leave an entrance.) Then spread one of these squares of tar paper on the bottom-board, and set the hive on this paper. Then put another paper on top of this hive, and place another hive on, and so on as high as desired; and if on each tier, or tiers, a piece of this tar paper is put under the bottom hive, between each one, also one on top between the cover and top of the last or top hive, the moth-worms will never damage the combs any, even if the joints between the hives do not fit very tight—at least they never have with me. Of course, if there were moths or moth-eggs in the combs before they were so fixed, they would damage the combs.

These squares of tar paper will last for years, and when not in use can be rolled up together, and thus require but little storage-room. The tar paper will cause the combs to smell of tar, and if they contain honey it will cause it to taste tarry, but this is no detriment to brood-combs or to the honey either, if it is to be given to the bees for their own use. On the other hand, in my opinion, it is healthy and good for them. But none of this tar paper should be used around section or any other kind of honey that is intended to be sold or used at home, for it will cause it to taste of tar, and be a great damage to it.

The only way that I know of to keep comb honey—that is, if it is kept in such a place as it should be—from being damaged by moths, is to sulphur it every two weeks or so during warm weather.

If this article is thought to be worth printing, in my next I will give my method of sulphuring and handling comb honey.

Southern Minnesota.



More About Painting Hives, Etc.

BY E. B. THOMAS.

On page 774 (1895), I observe some kind remarks on my letter on page 746, on painting hives, with Dr. Miller's expression of surprise that the general practice of priming should have obtained in spite of the facts I adduce to the contrary. I think the practice can be explained as follows:

Outside, or house-painting, is generally done on vertical or hanging surfaces, and when the weather is warm and

pleasant; the oil generally used is new, light and thin, and made thinner still by the warmth of the day and the surface to be painted. Therefore, in order that the oil may not "run," some paint is put in to give it body, without thought as to the detriment it will be to the permanence of the finished work. When this priming coat is made with finely-ground lead or zinc, it is bad, but not half so bad as when made by stirring into the oil some of the ocherous earths (chiefly yellow ochre) as is so often seen of late years.

If the old oil I have recommended be used, it will have enough body, and even new oil well worked in with the brush is vastly superior to the usual coat of priming.

As to the practical question in the Doctor's second paragraph, I think I may offer a solution satisfactory to those who desire unpainted hives. Most hives made in the North are of white pine—a light, porous wood, so little subject to warping and shrinking that to this day it is considered by most architects as the only suitable wood for the core of veneered hardwood doors used in expensive houses. White pine, however, does not stand exposure to the weather unless thoroughly protected by paint. But of late years cypress has come into use for various purposes. It is not quite so light in weight as white pine. From its solid doors and interior finish can be made of the most exquisite beauty, according to the selection of the wood. It does not shrink or warp any more than white pine, and when exposed unpainted to the weather, lasts indefinitely. Cypress shingles are said to last 50 years, and then succumb only to the action of the rain wearing away the surface of the wood. I have 40,000 of them on my house, and although they have been there nearly five years, none of them are appreciably warped. This wood is odorless, free from knots, and is a good material for the exterior parts of hives. In New York and New England it is slightly more expensive than white pine, but the difference is far more than made up by the saving in paint. Oil all joints and bearings, and underneath bottom-boards. Use galvanized nails, and no part, not even the tops, will require painting—and they may be bequeathed to your children.

While on the subject of material for hives, let me suggest one reason why bees will sometimes refuse to stay in a new hive. Hives made of Southern pine, as is the usage in the South, or of white pine, as in the North, often contain "fat" or resinous pieces, or knots which are of the same character. On a hot day, whether exposed to the sun or not, these resinous parts exude an odor of turpentine so pungent at times that the desertion of the bees may be thus accounted for.

Lynn, N. C.



Management to Get the Most Honey.

BY JAMES CORMAC.

On page 600 (1895) is an article entitled, "A Different Management of Bees Needed," which was to be followed by this, but circumstances prevented my writing sooner.

The past ten years, in this part of Iowa, have been a continued honey-dearth, so far as white clover is taken into account as a honey-plant, and only those favorably situated near groves containing basswood (linden) can boast of much surplus, and especially those who practice section-honey production.

The flowering of the basswood being of short duration, by the prevailing methods of management a large part of the honey secured by the bees is not secured in the sections; for whenever this flow commenced, the bees became excited to swarming, queen-cells were built as fast as possible, and preparations made to transfer their home. Although sections were on and work commenced therein, at least two-thirds of the colonies would be in the air within a few days, and several at the same time, necessitating a great deal of lively and hard work in catching swarms and moving hives, changing the supers, etc. Following the usual methods of hiving the swarms, I soon found that I had more bees and less honey, than from the colonies that did not swarm at that time, although careful observation convinced me that colonies not swarming, although as strong or stronger, did not secure as much honey as those that were allowed to swarm, but did not place as much in the sections during the flow.

I studied on methods to remedy such a condition, and secure almost all the honey the bees gathered, at the same time permit swarming, because I believe that under this excitement more work can be forced in the sections than when under placid conditions. To prepare and adopt the method to be set forth, and to save time and labor, should you have many colonies or only a few, it is best to clip the queens' wings, although most apiarists know the best time for this is

during fruit-bloom. By having the queens clipped, five minutes is ample time to attend to each colony, as the swarms will return of their own accord, that is, *early or prime swarms*. It is possible that under this management a second issue of the swarm may take place, but not more frequently than will be the case of swarms leaving the hive under usual methods.

Before I give the method, allow me to say here, that I am convinced that bees allowed to swarm can be so managed as to have section comb built out faster than would be done in a colony in a placid or normal condition; because, under the excitement of swarming, wax-scales are secreted more abundantly than under any other conditions, as instinct or reason causes the bees to secrete wax to be used in building up a future home, and these conditions can be used by the apiarist to greatly facilitate comb-building in the sections. This statement does not so much concern those who extract as those who produce comb honey only. It is for the latter class that this is written.

Whenever your bees swarm secure the queen. Screen-wire wound around a round piece of wood or corn-cob is about the most convenient, both for lightness, size, etc., as also a piece can be used as a stopper. A 4-inch square piece of screen-wire from the edge of the web is safest, as no raveled ends are in the way to pierce the queen.

Lay the queen in this cage on the bottom-board in front of the hive from which the swarm issued; open the hive and remove all combs on which are closed cells; bruise all others, place the combs with cells in the rear of the hive, or in a comb-box with adhering bees; push together the remaining combs, fill the empty space outside of the division-board with any material most handy. Close the hive, returning the supers if on, or put on sections. The swarm returns; release the queen, and the conditions are most favorable for comb-building and honey depositing. No honey to be wasted in building comb in the brood-nest, and as honey, pollen and brood fills the hive, all work will be thrown into the sections.

The frames taken out can be put into nucleus hives, or, if you have none, put them into any hive partitioned off to receive them. New frames can be given these as they need them. You can make new colonies with them, or unite when the honey-flow ceases. In uniting, cover the hive you wish to preserve with screen-wire, and set the other on above this; in a day or two unite—harmony all around.

This method will yield you more honey than to throw the bees into a condition where they waste their opportunity of securing a large surplus by building for themselves new brood-combs, as in a short honey-flow work is divided between the brood-nest and the sections, and is too short to finish either.

I hope this will answer Dr. Miller's criticism found on page 632 (1895).

On page 585 (1895) Adrian Getaz writes: "If I could prevent swarming and keep up brood-rearing, and thereby the strength of the colony during the honey-flow, I should get considerable surplus."

On page 545, J. E. Taylor says: "I knew one strong colony was worth two weak ones. I moved hive No. 1 within a foot of No. 2, then moved No. 2 away about 20 feet, and taking each frame I shook off the bees on the alighting-board of No. 1, smoked them, and they entered; also returning bees from both colonies. Before finishing the job, a swarm issued from another hive; I hived them in No. 2, and filled with brood-combs (brood and honey); result, a large surplus from No. 2."

On page 526, R. V. Sauer writes: "I work my bees two, three, and even four stories high, trying to keep them from swarming as much as possible, and only hive such swarms as settle together while swarming, or such as I do not know from which hive they came. All other single swarms I put back from whence they came."

Also see an article on page 648 (1895), from Eugene Secor, which is too long to copy.

On page 573 (1895), is a quotation from the American Bee-Keeper, from the pen of G. M. Doolittle, viz.: "I have been a careful observer for 25 years, and find that when bees are at work best in the sections there is little honey in the brood-chamber during the white honey harvest. It would be a doubtful expedient to use the extractor on combs below, if one expects to secure a large yield of comb honey. If honey accumulates in the combs before the bees are fairly started in the sections, have no fears the bees will carry it up and make room for the queen."

On page 576 (1895) E. Tarr writes that as he has bees enough he hives two or three swarms together and gets large yields.

On page 890 of Gleanings, from the top down 20 lines, therein is written: "It is almost impossible to get even rea-

sonable work in sections with a colony that has not swarmed, while the one that swarms will do almost nothing in the section."—R. C. Aiken, Loveland, Colo. *Why*, the mother colony is decimated in bees, and swarming accelerates their activity.

I think I have supported this question by sufficient quotations to bolster it on all sides—that if no swarming takes place honey is more surely stored; that swarming is conducive to increased activity; that swarms returned to the mother colony give large yields; and the fact of being so much less trouble in taking care of the bees, as one can care for several swarms in the air in less time than one caught in a swarming box or basket.

Eight days of actual gathering during basswood bloom, and two days of rain with no work done, bees treated as above, and also the prevailing methods, the bees that returned gave over two supers of 2½ 1⅞-inch sections filled, and not a completed section in the others. Our fall flow was nothing—plenty of bloom, but no nectar. As one can build up during fruit-bloom by putting surplus hives on the brood-nest, and strengthen the colony, it is not necessary to combine colonies, making them as strong as an 8-frame hive can contain; and when the time arrives for honey-secretion from whatever source it is to be obtained, place the surplus case over the super with an escape over the super, and in the morning the super can be taken off minus the bees. You then have the combs to supply nuclei, if they should require it, until a later flow comes, and the hatched brood is old enough to go to the field. Des Moines, Iowa.



Nectar and Its Secretion.

BY W. H. MORSE.

What is nectar, and what are the conditions necessary to a copious supply of it?

In the first place I want to say that the previous year has very little to do with supplying the nectar for the year following. (I can hear scores say that won't do, but it is a fact, nevertheless.) Let us take, for instance, a small apple-tree in the first year of its existence, and upon careful investigation we shall find that as the sap rises in the spring in this small tree, and, in fact, all trees, it is little more than water impregnated with a small amount of fertilizer held in solution by the surrounding moisture, but when it rises in the spring, and reaches the leaf buds and unfolds them, then the laboratory work begins, the sun's rays of light act on the wonderful organism of the leaf, and the young plant begins to receive from them the prepared sap which goes to build up the plant in general, and stores sufficient chemically-prepared tissue to mature its buds for next year; and so it goes on till it acquires sufficient age to make the peculiar fermentation necessary to produce fruit-buds, and the little parts of the flower are in an embryo state, lying dormant through the winter, but as spring advances the flowers open up, and then the laboratory work is so wonderful—all man's achievements seem puny in the contemplation of this little flower. The sun's rays of light are the great agent in the work. If any one doubts it, put a red-flowering plant in total darkness as soon as its flower-buds can be seen, and give it heat and water, and its flowers and leaves will be white, or almost so. So we see that the sun is the base of the work, marking the petals with such beautiful tints of color, and forming the essential oils which give the flower its perfume, and adds vigor to the pistil and stamens, and to the nectary, which is the part of the flower that is of interest to us as bee-keepers.

Now, I have tried to give the preceding to back up the statement I made, that the preceding year has nothing to do with filling this nectary with nectar. True, it builds it in embryo, but does nothing more. No, friends, it is when the atmosphere is favorable that plant life seems to take on that excessively luxurious growth that delights all lovers of Nature, that the flowers are changing the sap into nectar, depositing it into the nectary by such wonderful process that man cannot imitate it even if he had thousands of years to try. In fact, it would be almost like getting a strawberry from a rosebush, or *vice versa*. I used to think it possible to work that way, but in actual practice I struck snags on all sides, and had to give it up.

But some plants have the power of producing nectar under unfavorable circumstances, such as sweet clover and many others. Then there are plants which it seems take spells and produce an excessive amount of nectar one year, and not any for several years following—tropical plants grown in greenhouses are especially so. I remember a peculiar case of this kind; it was with a plant named "Hoyacarnosa." It

was planted out in a large conservatory, and twined itself to a trellis suspended to the roof, and the year in question it flowered excessively, and secreted so much nectar that it dropped from the flowers, soiling everything underneath them; and the same flowers produced nectar till they perished, as nearly as I can recollect it, six or seven days from the time they began to produce nectar. Now this plant was handled the same in every way for four years afterwards, and if I had not seen what I have described I would have said that the flowers were destitute of any organ to hold nectar, let alone produce any. What should cause it is a knotty point, but such is the case with all nectar-producing plants, which all old bee-keepers know.

Florence, Nebr.



Wintering Bees in New Brunswick.

BY FRANK SHUTE.

In New Brunswick the bees are usually wintered in the cellar, as the winter is dry and cold, with very few warm spells from Dec. 1 to April 1.

About Sept. 1 I examine my hives to see that each has a laying queen, and about 25 pounds of sealed stores. If they lack either I supply them with what is required as soon as possible, and generally I make it a point to feed each colony 5 or 10 pounds of syrup about this time, so that it will rear plenty of young bees for winter. In a fortnight I take off the covers and place on each hive a porous cover that I use from Sept. 15 to May 1, which may be made as follows:

On the bottom of a super or frame of wood the same size as the hive, and about 5 inches high, place a sheet of burlap or any coarsely woven goods, for a bottom, and have it held in place by nailing strips of $\frac{1}{4}$ -inch stuff all the way around on the bottom edge of this frame, so that if there was no sag in the burlap bottom a $\frac{1}{4}$ -inch bee-space would be left over the combs. The box thus formed is to be filled with packing, and in order to keep the burlap bottom from sagging, nail two strips lengthwise inside of the box about 2 inches each side of middle and up from the burlap about $\frac{1}{2}$ inch. Then before putting in the packing, the burlap should be fastened to these strips by needle and thread, or by tacks.

I fill the box thus formed with corkdust, such as grapes are packed in, which I get free from fruit dealers, and which is very light, porous, and warm. Around the hive I sometimes place a winter-case, and the space left between it and the hive I fill with old newspapers folded in the usual way, which I consider is a very clean and convenient form of packing, and which is practically wind-proof.

Then my bees are all right until the ground freezes, and on some fine day, about Nov. 1, I take the winter case off and carry each hive to the cellar, where I place it on two strips in such a way that one end of the hive is about 2 inches higher than the other, thus forming an entrance 2 inches high, and the whole width of the hive, which allows ample ventilation underneath the cluster. Before placing the hive on the strips I place three or four sheets of paper between them so that when dead bees, etc., drop from the cluster, they may be quietly removed by simply pulling out the sheets of paper as each becomes soiled. I place the back end of the hive higher than the front, as there is usually more honey at the back.

When in the cellar I remove the hive-cover proper, which, of course, should be placed on top of the porous cover when the bees are out-of-doors, in order to protect them from rain; but if the packing becomes damp the cover should be raised a little to allow the moisture to escape.

If mice trouble the bees any while in the cellar, have a screen of wire netting, 3 or 4 meshes to the inch, which may be hooked in place at the entrance. Then if the thermometer registers about 45°, my bees will be in first-class condition when I put them out in the spring, which usually is about the middle of April.

Fredericton, N. B.

A New Binder for holding a year's numbers of the American Bee Journal, we propose to mail, postpaid, to every subscriber who sends us 15 cents. It is called "The Wood Binder," is patented, and is an entirely new and very simple arrangement. Full printed directions accompany each Binder. Every reader should get it, and preserve the copies of the Bee Journal as fast as they are received. Why not begin with Jan. 1 to save them? They are invaluable for reference, and at the low price of the Binder you can afford to get it yearly.

If any one desires two of the Binders—one for 1895 and one for 1896—send 25 cents, and they will be mailed to you.

See "Bee-Keeper's Guide" offer on page 125.

CONVENTION PROCEEDINGS

Report of the Illinois State Convention Held at Chicago, Jan. 9 and 10, 1896.

REPORTED BY ERNEST R. ROOT.

(Continued from page 103.)

COMB HONEY PRODUCTION VS. EXTRACTED.

President—I should like to ask for a show of the hands of those who think they can produce more extracted than comb.

Quite a number held up their hands. When the reverse of the question was put, no one responded.

President—Now, I should like to know *why* more extracted can be produced than comb.

Mr. Baldrige—Bees can go to work younger when we are running for extracted honey. If two-thirds of the combs are capped over, we can extract. In the production of comb honey we have to be particular to have *all* the cells capped.

President—How many make a practice of using the sections over again?

A show of hands indicated that the majority did so.

President—How many throw them away?

No hands were raised.

UNFINISHED SECTIONS.

President—We will assume that we have taken off our comb honey, and that we have a lot of unfinished sections. Now, what shall we do with them?

Mr. Baldrige—Extract, and put in a hive under the brood-chamber, and clean them up, and then level them down.

Mr. Draper—It does not pay to extract.

President—What do you do, then?

Mr. Draper—What is fit for chunk honey at all, I cut out and sell as such. The rest I use for feeding up in the spring.

Mr. Baldrige—The extracting of the unfinished sections can be done very rapidly if you have the right kind of extractor. The Cewan answers very nicely for this purpose.

President—Mr. Draper, why do you feed in preference to extracting?

Mr. Draper—Because it is more easily done.

Mr. Wheeler—It is a good deal of trouble to get the bees to take honey out of the sections.

Mr. Baldrige—It is no trouble if you scratch the cap-pings of the combs with a knife. The bees will repair the damage, and in so doing take out the honey.

President—But some bee-keepers would object to going to the trouble of scratching over the surfaces of all their unfinished sections.

Mr. Draper—If bees won't take the honey out when over the hives, scatter them out-doors among the hives. They will be emptied then in short order, I tell you, without "scratching."

President—My method is to put the unfinished sections in hives stacked up, one story above another. These are what I call "piles." These are made perfectly bee-proof except at the bottom; and the entrances are contracted so as to let in only one bee at a time. If we don't have a small entrance, the bees will rush in and tear the surface of the combs too much. Mr. B. Taylor, I believe, has his sections scattered all over the yard so the bees can get at the whole business at once. Then he says the bees don't tear the sections.

Mr. Finch—That is just the point. If you put out only a little honey the bees will pounce on it and tear the comb; but if you put out a lot, and scatter it, no manipulation will take place.

President—If you have only a few unfinished sections, use the stacked-up hive and a small entrance; but if you have a lot, use Taylor's method of scattering through the apiary.

RUNNING AN OUT-APIARY.

Question—"What is the best method of running an out-apiary?"

Mr. Wheeler—My method for prevention of swarming in out-apiaries is as follows: As a preliminary, let me say, hav-

ing 300 to 400 colonies, and doing the manipulating alone, for fear the bees will get away from me before I get all around, I clip all queens' wings. Sometimes after I get them fixed for comb honey they try to abscond for a day or two, hence the necessity of clipping. For comb honey, I put on supers of empty sections at the beginning of the flow of honey. When the desire to swarm appears, I take all combs containing brood from each colony, replacing such combs with empty frames with starters. The queen is left in the old colony with the supers and the empty frames. The combs of wood are put into an empty hive by the side of the old one, enough bees being left on this brood to care for it. These bees soon have a young queen, and can then be treated as any other colony, or, if preferred, they may be returned to the old colony from which they were taken earlier, after the brood has hatched. For extracted honey, I simply place above the brood-chamber empty combs faster than the bees can fill them, not disturbing queen or brood.

Mr. Finch—I should like to ask Mr. Draper whether he has made the out-apiary business a financial success?

Mr. Draper—The year before the North American Association met in Keokuk I made some money, but I have not made any since. If I had a mind to follow up the good localities, as Mr. Walker does, I might still be making money at it; but I have too many irons in the fire.

OLD SECTIONS FILLED WITH COMB.

Question.—“What shall we do with old sections filled with comb?”

Mr. Stewart—Burn them.

Mr. Finch—Cut out the comb and burn the sections. There is no use of burning up wax at any time. Too much good money is represented in it.

Mr. Baldrige—Trim down the comb with a hot knife, or with the comb-leveler, as Mr. B. Taylor does. Bees do not take kindly to the soiled and thickened edges of the combs of unfinished sections as they are left the previous season. I have found it to be a great advantage to level down these combs and take off the soiled edges. I practiced this before Mr. Taylor ever spoke of it in the bee-papers.

Dr. Miller—Yes, and it is an advantage to take off this dirty edge, because it would spoil the appearance of the comb honey when finished by the bees.

Mr. Schrier—I have been cutting down combs of unfinished sections in this way, and find it an advantage. Bees do not like the old, dirty edges to start on anew.

A CHICAGO HONEY EXCHANGE.

Question.—“Is it desirable to organize a honey-producers' exchange in Chicago, something as they are doing in California at the present time?”

Mr. Newman—As General Manager of the Bee-Keepers' Union I have been asked to establish something of the sort for Chicago. I would have one for the whole United States. A honey-depot in some large city, and plenty of money back of it, would be an advantage. It may be a good idea for this and other conventions to study on this matter some.

Mr. Thompson—The right party back of it ought to be a bee-keeper.

Mr. York—I get a good many letters asking if the American Bee Journal cannot help in the disposition of honey. Something in the way of a honey-producers' exchange would be a good thing for Chicago. I am sorry to say there is but one Chicago firm, so far as I know, to whom I can conscientiously recommend bee-keepers to ship their honey. I find there has been handled, in this city, since the latter part of August, or early part of September, 60 carloads of honey, with an average of about 10 tons to a car. One firm has handled about 20 carloads, or 200 tons, and has handled three carloads in one day. One trouble with the market is the rushing in of too much at a time. A carload of honey goes a good ways unless a dealer has a good trade worked up in advance; and when several carloads come in at one time, there is great danger of running down the prices. While Chicago is a good honey market, there is often danger of overdoing even a good thing. There should be a honey-depot in every large city, to which carloads of honey could be shipped as fast as required, then by careful distribution there would be no danger of overloading the market.

Mr. Baldrige—Is it not true that the California Honey-Producers' Exchange would be glad to join with any other body or organization of bee-keepers?

Mr. Newman—I believe Mr. Baldrige is correct. The suggestion I made for a honey-depot I think is the best solution. If we had such a one in Chicago, or any other point, that could make liberal advances on honey, it would be a great help to bee-keepers. The trouble in shipping to so many

different firms is the competition that is brought about. One large, central depot that could handle all the honey could realize better prices.

Mr. York—There is no doubt that a honey exchange would be a great aid to securing and sustaining uniform and better prices for honey. For instance, a new firm begins to handle honey; they quote prices away up in G, get overloaded and somewhat scared, then get rid of the honey in their hands at just about what is offered them by competing dealers. This is no supposed case, but one that I know occurred. Think of fine comb honey selling here in Chicago at 8 cents per pound, and white extracted at 4 cents! It is outrageous. No wonder some reliable dealers prefer to buy of certain other crooked dealers, when they can see the honey, and get it at less price than they would have to pay the producers if they bought it direct. Another thing: The bee-papers can do much to help weed out swindling commission-men, by publishing their crooked transactions. But we editors have to be very careful in such matters, and if accidentally we should be threatened with a libel suit, we would expect to be backed up by our readers and bee-keepers everywhere when thus fighting their battles for them. I should expect the Bee-Keepers' Union to help, too—it could not do better service than to help put honey-buying scoundrels and swindlers behind the bars, where they belong. I believe it would be a good thing if the whole honey-commission business could be dropped, and the honey exchange or depot take its place. I should like to see the latter idea tried, at any rate.

Mr. Newman—Bee-keepers should not keep still. The bee-journals should be notified, and then the bee-keepers should stand by the bee-papers. The Bee-Keepers' Union can doubtless assist; but it was created for one specific object—to defend the rights of bee-keepers. It can and will assist in exposing villainy, and will help to win the case.

Mr. Root—That is just it. Bee-keepers should let the bee-papers know in regard to these unsatisfactory deals. A little suggestion coming from a publisher of a bee-paper will oftentimes have great weight with a commission-house, as I know from some experience I have had.

[Continued next week.]

Questions AND Answers

CONDUCTED BY

DR. C. C. MILLER, MARENGO, ILL.

[Questions may be mailed to the Bee Journal, or to Dr. Miller direct.]

Bee-Killing Insects—Managing Swarming—Detecting Adulterated Honey.

DR. MILLER:—Permit me to thank you for your kindness in answering my questions in the Bee Journal, and to ask some more. While your answers were not quite so encouraging as I had hoped they would be, still I am persuaded they are as near the truth as any one could make them. I do not think I could afterwards accuse you of underrating the disadvantages of the business. I am still determined, however, to try my hand this year at a few colonies. I think time can be found to take care of them, and all I learn about the business will be so much clear gain.

1. Is there any serious trouble in this part of the country from bee-killing insects or birds?

2. What method would you advise for handling swarms by a man who is only home Sundays during the daytime? Is clipping of the queen's wing practiced much?

3. Are there any kind of bees less likely to swarm than others?

4. Is there a simple method by which a greenhorn can tell adulterated extracted honey? I recently bought some warranted pure, which is either manufactured, or which was stored by bees that had lost the sense of taste. It is not fit to eat.

INQUIRER.

ANSWERS.—1. No, you must go South for anything of that kind.

2. I think I'll hardly attempt a direct answer to that question, for so much depends upon circumstances that you

will probably be safer to trust to your own judgment after you are a little more acquainted with the text-books that I know you are studying, than to trust to my advice. I don't know whether clippers or non-clippers are in the majority among those who make bee-keeping a specialty, but there are many who could not easily be induced to do without clipping. Situated as you are, I wouldn't think of getting along without it.

I don't suppose you mean that Sunday is the only day in the week in which you have daylight at home, for in that case I don't believe you'd want to keep bees, but I suppose you mean that you are from home through the part of the day that swarms would be sure to issue. One way to do is to have queen-traps at the entrance to hives, and then when a swarm issues you would find the queen in the trap in the evening or the next morning.

3. Yes, there's a good deal of difference. Carniolans have perhaps the worst reputation as swarmers. I don't know that there's such a great difference between Italians and blacks, but Doolittle thinks there's much difference among bees of the same race. He says he hasn't one swarm now where he formerly had ten, and evidently thinks this has resulted from the fact that his queens have been reared, not from swarming colonies, but over a queen-excluder on a colony with a laying queen and with no thought of swarming.

4. I'm not sure that there is. The method you used—by the taste—is pretty reliable, but sometimes the bees gather what is called honey-dew, that tastes about as bad as any adulterated article. But I don't remember that I ever tasted any with a bad taste, of the bees' gathering, that was not pretty dark in color, and the adulterated article may be very light in color.

You're wrong in judgment as to the bees losing their sense of taste. When they gather bad honey, I think you will find it's not because they think it's good, but because it's the best they can get.

Packing Honey for Long Shipment.

Is it possible to send comb honey from California to Boston without serious damage? If so, how? At Christmas I sent 24 sections, and 15 were broken. They were packed in a strong wooden case, and shipped by express. I want to send more; how can I do it with better success? J. B.

Garvanza, Calif.

ANSWER.—One thing that will probably make a big difference in breakage is to send by freight. Never send comb honey by express. Express goods are handled more rapidly than freight, and a package of only 24 pounds would be thrown by express where it would be handled slowly by freight. It isn't an easy thing to get a single case of comb honey through from California to Boston in whole condition. A carload would be easier. I hardly know what would be the best way. One way to do would be to give no protection whatever, and another would be to try to protect very thoroughly. If you give no protection whatever, merely putting the honey in a case with glass on one or two sides, then the honey being in plain sight through the glass, and the glass showing, too, there would be some likelihood that it would be handled with care. If you try protection, put the case of honey in a box large enough so that you can pack it on all sides with excelsior shavings three or four inches thick.

Finding Queens—Full Sheets of Foundation in Brood-Frames.

1. If the "court" please, I should like to explain a little further regarding the "queen's death," mentioned on page 7. "I don't know" whether you meant to say I am a "slouch" at finding a queen or not, but I am quite sure the queen was not present at the time spoken of. How do I know? When I said "I made two thorough examinations," I meant it, for I think I saw every bee that was on the combs, and perhaps those that were not on the combs. They were not so numerous as to be two or three deep on the combs, but were rather sparsely distributed over the combs. Besides, the queen was quite yellow, and easily distinguished from the others. Further: By hustling around in the neighborhood, I found a weak colony, the queen of which was given me by the owner. This queen was introduced by caging her on a comb as the former one had been; but as the weather following was too cold to open the hive, she was not released for nearly a week. Several days afterward, the weather being fine, I examined them and found the queen all right. Now is not this pretty conclusive evidence that the Italian queen is dead? I mean, does it not prove to the "court," beyond a reasonable doubt,

that that queen was not present when I made those "thorough examinations?"

2. Now for a question regarding the use of comb foundation: A friend of considerable experience in bee-keeping tells me it does not pay to use full sheets in brood-frames. He advises about half sheets; then when a swarm is hived, contract by means of a division-board to about four frames, adding a frame at a time as fast as filled. What do you think of the plan? Would not the bees be pretty sure to fill frames thus with worker-comb?

H. M. S.

Vine, Ohio.

ANSWERS.—1. I'm pretty near stumped, but then I'm stubborn enough to insist that you couldn't be dead certain that the yellow queen was not still present at the time you introduced the last queen. Neither do I insinuate that you're any "slouch" at finding queens. The court admits that the circumstantial evidence is strong, but denies positive proof.

First, as to the careful looking over, not many bees being in the way—I don't know how to explain it, but a good many times I've been baffled in finding a queen in a nucleus so weak that it seemed every bee must be plainly seen. I've looked the combs over and over again, looked in all the corners of the hive, and no queen to be seen, but the next day I'd find her the first thing. Where she hid was and is a mystery, but I'm inclined to think I've had more trouble finding queens in these weaklings than in the strongest colonies.

Secondly. You caged another queen in the hive, and that last queen was accepted all right. Evidently you think the caged queen would not have been accepted if the yellow queen was all right when the last one was released. The court accepts your view as correct. But there's a possibility that although the yellow queen was dead when her successor was released, she was all right at the time the successor was caged. Sometimes I have kept extra queens by putting them in a cage and putting the cage over the brood-frames of a colony having a free laying queen. The caged queens were kept all right, but sometimes the bees have killed their own queen. So while you have strong circumstantial evidence, you mustn't insist there's any positive proof unless you want to be fined for contempt of court.

2. Taking all things into consideration, I prefer to have full sheets of foundation, but there are those whose opinions are entitled to great respect who think differently. W. Z. Hutchinson is a strong advocate for living swarms on starters instead of full sheets. C. J. H. Gravenhorst, high German authority, says the first four or five combs will be built as soon without foundation, but with the succeeding combs the case is different. If you contract to four frames, those four will probably be generally filled with worker-comb, but not always, where there is no foundation; but after those four frames are filled, if you add one frame at a time, you may count on a goodly proportion of drone-comb wherever there is no foundation.

An Interesting Beginning.

I want your advice about a colony of bees that has gone amiss with me. June 26 we moved to the house where we live (rented, of course); it belonged to an old bee-keeper who died in March, 1895. I had no interest in bees, nor ever had been near where they were; it was his son-in-law who rented the place, and asked me if I knew anything about bees. I simply said "No." Well, he said, "Just let them go, and I will set them back in the yard." In the fall there was an even 20 colonies.

Along about the middle of July a friend of mine came to visit me. "Oh," he said, "you have bees." I said, "Yes," in a listless fashion. He looked them all over and said, "I would not give a nickle ahead, for they are not doing anything." His father used to keep bees, so he was that much ahead. That interested me. We went over the lot; they were packed on the summer stands, and it was the middle of July. The brood-chambers were all covered, and what a mess, you have no idea! Spiders, crickets, ants—big black ones, small red ones; moths, and every conceivable rubbish. Some had honey-boxes on. One had a stomach-bitters' bottle on, but not one had the covers off the entrance from the brood-chamber.

Well, we rounded up the honey-boxes, but only got about half a dozen. "Well," he says, "scrub the caps or covers clean, and let them store their honey in that." So scrub I did. I can laugh now, but, Doctor, believe me, I was more in earnest than was ever a Buddhist saying his flower prayer. I cleaned them up, and what a transformation scene! Before, one would not have believed there was a bee around, but after

that my wife could not hang out anything on the lines but she got in the way.

Well, I caught a well-developed bee-fever, and I wanted information. I got some out of an old mechanical recipe-book about making bee-hives, and there were some pieces from the "Bee-Keeper's Text-Book." Picking up a copy of the Michigan Farmer, I wrote to Mr. George Hilton, who sent me samples of several bee-papers, and I sent in my little subscription to the Bee Journal, and also got the "A B C of Bee-Culture," but did not know a box-hive from a Langstroth until a gentleman from Michigan, who was visiting, told me that what I had were "patent hives." Well, then it was winter, and I could not disturb them, so I just let them go and trusted to Providence, but got left.

Now, here is my statement: Of my 20 colonies I found one dead, so that left 19. I averaged about 30 pounds of honey in 1895. My wife settled six swarms, and I lost two, making a gain of 4; I gave a friend one, so I have 3. The bees gathered honey till the 1st or 2nd of October, and I fixed them up for winter the middle of November. I went among them every day or so, and that caused some caustic remarks from some people anent sleeping among the bees, but I put that down to jealousy or meanness, or my helpmeet among the rest.

Well, I found out I could yet learn a little. I found one of the old colonies defunct, or like that bee-paper. You will understand now. I took it into the house and opened its hive; I found no bees to amount to much—say a dozen—a few drones half-hatched out, and stores all right. I cleaned them all up, took all the dead bees away, and put them in a spare room. I suppose they lost their queen and just dwindled away. Shall I give that colony to a young swarm, or properly, the first I can get?

1. Did I lose the queen, and did they dwindle, say from the time they cast the last swarm, or about that time? that was in the middle of August.

2. What shall I do with the frames, 12x10 inches? Shall I have a swarm in the hive as it stands, or take say two frames from each end, that would be four? R. B.

Havana, Ill., Jan. 16.

ANSWERS.—1. The great probability is that the colony swarmed and failed to secure a laying queen afterward. It is no very unusual thing for a young queen to be lost on her wedding-flight.

2. If the frames are not of the size you desire to use, you can either melt up the combs or else cut them out and fasten the worker part in such frames as you desire to use. If you desire to continue the use of that sized frame—mind you, I'm not urging you strongly to use an odd-sized frame—then you can use the whole of the frames to have a swarm on, but it will be a good thing to cut all the drone-comb out of seven or eight of them and fill up with patches of worker-comb cut out of the other one or two combs. Still better than to use them all in one hive it may be best to use two, three or four in two or more hives to put swarms on.

Buying Bees—Keeping Bees Pure.

1. Can I buy a colony of Italian bees in an 8-frame hive with a tested queen? That is, do they sell them that way, or only in nucleus form?

2. What should such a colony cost, packed and delivered at their express office?

3. Have you any of your own in that form? If so, give me your price.

4. If I bought a colony in that condition, could I divide during the honey-flow of white clover or basswood?

5. I have some hybrids. Could I keep my young queens from being fertilized by the hybrids if I went to the trouble of cutting the drone-comb out of the hybrid colonies? There are no other bees within $\frac{1}{2}$ of a mile of my place. They are all hybrids—no Italians in my neighborhood that I know of.

Baraboo, Wis.

H. W. S.

ANSWERS.—1. Yes, full colonies are sold, but not so often as nuclei.

2. You will not be wise to buy anything of the kind this time of the year, and before time to buy you'll find advertisements in this journal, some of them giving the prices of full colonies, and those that don't give prices will be glad to send you a price-list. I can't tell you what their prices will be. But if you want to get a full colony, try to buy from some one not too far off, for express charges are fearful.

3. No, sometimes I have honey to sell, but nothing else except advice, and you can have all of that you want for the

asking, providing you want it in print, for the publishers pay me for that.

4. Certainly, if you get a strong colony from a distance you can divide it or let it swarm, just the same as if you had wintered it.

5. It will be of no use to cut out drone-comb unless you put patches of worker-comb in place of that cut out, for the bees will fill up the empty place with drone-comb 19 cases out of 20. Of course, the more Italian drones and the fewer blacks, the better your chances, but if there are blacks within $\frac{1}{2}$ of a mile there will be a pretty good chance of your bees mixing with them.

Foul Brood—Color and Solar Heat.

1. What degree of heat is necessary to destroy the germs of foul brood?

2. Can there be danger of introducing foul brood by the use of foundation made from wax that was melted in the solar wax extractor?

3. What color has the least tendency to absorb or reflect solar heat? H. C. B.

ANSWERS.—1. I don't know. There has been quite a little discussion and experimenting about it, and some say the germs are destroyed at 212°. Indeed, I don't know that any one directly contradicts this. Dr. Howard, in his book on Foul Brood, says: "That the vitality of the spores of *bacillus alvei* is not always destroyed when exposed to a temperature approaching 212° for 45 minutes...but that boiling for an hour would destroy their vitality."

2. I think it is generally believed that there is no danger of infection from foundation, no matter how the wax may have been melted in the first place, for in making the foundation the wax is held at a point sufficiently high, and for a sufficient length of time, to destroy all spores.

3. Black absorbs the most and reflects the least. White reflects the most and absorbs the least.

Sweet Clover—Leather-Colored Bees.

DR. MILLER:—After reading a great many valuable articles in different bee-papers, and seeing you are interested about sweet clover, and seeing what others have said about it, I will give my experience where we raise alfalfa, sweet clover, and sainfoin. I cut about 375 tons of alfalfa hay, which is good bee-pasture, so I can't tell how much honey sweet clover produces, but after it blooms it is just covered with bees until frosts. One frost will not kill it. Sainfoin is the earliest bee-feed in this country, but it doesn't last. I am well satisfied you can raise more sweet clover bee-feed from sweet clover on the same amount of ground than anything I ever saw. We use the hay to top our stacks, so I can't say how valuable the hay is, as it is always damaged, but here is the secret: It never blooms so profusely when once cut, and if it is seasonable it never stops blooming until it is killed by a freeze. It gets about 8 feet high if let alone. After it is cut it gets about 5 feet, but it is not so full of blooms. You want to cut say half before it blooms, so if it is not seasonable you will be all right. Just before it blooms is the time to cut it for hay and honey.

Our bees do not work on white clover very much. We never get a cell of dark honey. We get 120 pounds to the colony, spring count, of comb honey, on the average one year with another. I produced over 2,000 pounds of comb honey and 1,000 pounds in brood-frames, that I kept over to use next spring. I don't manage my bees like any one else, winter or spring.

Have you what is called leather-colored bees? If so, I want to buy or exchange queens. I have seven fine queens from different yards. You can have any color you like, from the dark imported to the yellowest. OREGON.

ANSWER.—As you have the dark imported, you have the leather-colored, for they're all one and the same thing.

The Alsike Clover Leaflet consists of 2 pages, with illustrations, showing the value of Alsike clover, and telling how to grow it. This Leaflet is just the thing to hand to every farmer in your neighborhood. Send to the Bee Journal office for a quantity of them, and see that they are distributed where they will do the most good. Prices, postpaid, are as follows: 50 for 25 cents; 100 for 40 cents; or 200 for 70 cents.

Now is the Time to work for new subscribers. Why not take advantage of the offers made on page 123?

OLDEST BEE PAPER IN AMERICA

THE AMERICAN BEE JOURNAL

ESTABLISHED IN 1861

PUBLISHED WEEKLY BY
GEORGE W. YORK & COMPANY,
 Editors and Proprietors,

56 Fifth Avenue, CHICAGO, ILL.

REGULAR CONTRIBUTORS:

G. M. Doolittle, of New York. Prof. A. J. Cook, of California.
 Dr. C. C. Miller, of Illinois. Dr. J. P. H. Brown, of Georgia.
 J. H. Martin, of California. Rev. P. T. Abbott, of Missouri.
 Chas. Dadant & Son, of Illinois.

\$1.00 a Year—Sample Copy Sent Free.

[Entered at the Post-Office at Chicago as Second-Class Mail-Matter.]

Vol. XXXVI. CHICAGO, ILL., FEB. 20, 1896. No. 8.



The Wisconsin State Convention was held Feb. 6 and 7, at Madison. The officers elected for the ensuing year are: President, Franklin Wilcox, of Mauston; Vice-President, J. J. Ochsner; Secretary, N. E. France, of Platteville; and Treasurer, H. Lathrop. We have a number of the very valuable essays read at the meeting, which we intend to publish as soon as possible.

Alfalfa or Lucern is the title of Farmers' Bulletin No. 31, issued by the Department of Agriculture at Washington, D. C., some time ago. It not only gives excellent illustrations of alfalfa, but an immense amount of information in the line of its cultivation and value as a forage plant. A copy of this Bulletin can be had for the asking. Write for it if you are interested—and what bee-keeper is not interested in so valuable a honey-yielder as alfalfa has proven itself to be in certain localities of our country?

F. I. Sage & Son Failure.—We were greatly surprised to see in the New York Journal of Commerce and Commercial Bulletin, for Feb. 10, an account of the failure of F. I. Sage & Son, on Feb. 8. This firm have been well-recommended for a long time, and we had every reason to believe them an honorable firm, but it seems they left things in pretty bad shape, for from the published account they very suddenly left for parts unknown. We hope no bee-keeper has lost through them, though we fear they have, for this firm dealt largely in honey as well as other farm produce. Some of their creditors think the liabilities are all the way from \$25,000 to \$50,000. F. I. Sage & Son were originally from Wethersfield, Conn.

That Benton Bee-Book.—Hon. Eugene Secor of Forest City, Iowa, has this suggestion to offer in regard to Bulletin No. 1, prepared by Mr. Benton:

MR. EDITOR:—Let me suggest to the readers of the American Bee Journal that they write to their Congressmen for a copy of Bulletin No. 1, issued by the Department of Agriculture, called "The Honey-Bee." It was written by Frank Benton, of the Division of Entomology. It is a book of 118 pages, well written, clearly printed, and handsomely illustrated. The reason they ought to write to their Congressmen is that the limited number of copies already printed is exhausted. No more can be issued without an appropriation.

If they ask their Congressman for a copy, he will know they are interested in the matter, and will be more likely to vote for a resolution authorizing the Secretary of Agriculture to print another edition.

A resolution has already been introduced, to authorize the printing of 20,000 more. You might say to him, if he cannot get a

copy you hope he will use his influence and vote for the passage of this resolution. This will inform our National Legislators that there is such an industry as bee-keeping—a fact which perhaps many of them do not know, and it may aid us in procuring further legislation in our interests. EUGENE SECOR.

Mr. Secor's suggestion is a good one. We regretted that it came just a little too late for our last issue, but it may yet result in much good to do as directed. It can surely do no harm, and as Mr. Secor says, "it may aid in procuring further legislation in our interests." That's a good point. Let those Washington folks know there is such an industry as bee-keeping, by literally flooding them with requests for copies of Bulletin No. 1, called "The Honey-Bee," by Frank Benton.

A review of this Bulletin we expected to give this week, but there was not room for it. We will try it again next week.

C. R. Horrie & Co.—In a recent editorial referring to this well-advertised firm of Chicago honey-dealers (?), we mentioned their having bought all the list of names of bee-keepers from Mr. Hutchinson that he had for sale. We did not intend to even intimate that Mr. Hutchinson furnished the names after Horrie & Co.'s unsatisfactory dealings with bee-keepers were known. Mr. H. let them have the names *before* he had received a single complaint against them, or of course he wouldn't have sold them the names for any price.

We understand that Horrie & Co. will drop the honey part of their business. It is a great pity that they didn't stop before they began it. Many bee-keepers would be better off now if they had done so. We personally and very strongly advised them to get out of the honey-business long ago, as we decided, after learning of their way of doing business, that they knew no more about the honey-business than a boy 10 years old.

Commission for Selling Honey.—Dr. Miller writes us as follows on the percentage charged by Chicago commission-men for handling honey:

MR. EDITOR:—I got myself into trouble when I said that 5 per cent. was the regular commission for selling honey in Chicago. As I have already said, that statement shows that I haven't very recently shipped honey to commission-men in Chicago. Please say to the friends that no more of them need write to correct me.

I think I am correct in saying that in past years 5 per cent. was the regular thing, no matter whether the amount sent amounted to a dollar or a hundred dollars. But from what a number write, I can hardly make out just what is the rule now, or whether there is any fixed rule upon which all the Chicago houses are agreed. Some say 10 per cent. on all amounts under \$100 and 5 per cent. on amounts over, but others say they have been charged 10 per cent. on amounts of more than \$200. Now can you tell us anything about what the rule is, or is there any rule? C. C. MILLER.

Doctor, we have about concluded that there is a "rule" on the subject among commission-men, and that rule is to charge 10 per cent. on any and every shipment, unless the shipper makes too big a "kick." We think it is all right to charge 10 per cent. on a shipment amounting to *less* than \$100, but to charge the same per cent. on a *larger* sale is next door to robbery, in our opinion.

An Iowa bee-keeper writes us that S. T. Fish & Co. charged him 10 per cent. on a shipment amounting to over \$200; and a Utah honey-producer says in a private letter that J. A. Lamson charged him 10 per cent. on a shipment that sold for over \$500.

We have come to the conclusion that bee-keepers can well afford to peddle their own honey from door to door, rather than hire commission-men to sell it, and, besides, stand the freight, cartage, and possible breakage or leakage.

Coal-Oil Can Frauds.—After reading the following letter received by a Chicago honey-dealing firm, from one of their customers, we think you will agree with us in saying that it is a fraud to use second-hand coal-oil cans for holding honey:

DEAR SIR:—I am very sorry to inform you that I have just returned all of your last shipment of extracted honey. I thought that the California sage was all right, but I found, on heating a couple of cans (as we always do to melt the grain), that the honey had been packed in coal-oil cans, and I did not detect the fraud until the heat developed the oil. You will find that the honey is worthless, and should be returned to the producer at his expense. One can seemed to be worse than any of the others, so I emptied it into a clean can and cut the top out to see just what condition it was really in. On the inside I found that the oil had not been washed out at all—the sides of the can are covered with oil so

much that the honey don't stick to the tin. I sent the empty can along so that you can see for yourselves.

Just examine that empty can—it shows premeditated fraud—the cap has been changed from the original top to the bottom for the purpose of covering up the stamp of the oil company. Now, I claim that the commission merchants are largely to blame for such vandalism. All you would have to do, would be to notify California producers that oil packages would not under any circumstances be accepted. Yours very truly.

HONEY-MAN.

We cannot understand how any bee-keepers can have the "gall," or the poor business sense, to use cans that have had coal-oil in them, for holding honey, when they ought to know that the flavor of honey is very easily affected and totally injured. What poor policy it is to try to save a few cents on cans, and run the risk of having the honey ruined and made wholly unfit for use! Surely, no readers of the American Bee Journal would be guilty of such an act, but if they know any bee-keeper using old coal-oil cans for honey, they should try to stop it if at all possible, for by the wrong-doing of one, or a few, the whole fraternity must sometimes suffer.

Missouri Agricultural Report.—We have just received a copy of The 27th Annual Report of the State Board of Agriculture of Missouri for 1894, prepared by Secretary J. R. Rippey. It is a book of over 350 pages, bound in cloth, and is a credit to the State and its Board of Agriculture. We presume the book is for free distribution in Missouri. About 25 pages of the book are devoted to "Bee-Keeping," in which appear some of the discussions, as well as a number of essays read at the St. Joseph, Mo., convention of the North American Bee-Keepers' Association held in 1894.

We shouldn't wonder if to ex-President E. T. Abbott is due the credit for the fine showing which bee-keeping receives in the Report. When introducing the subject of "Bee-Keeping"—after mentioning the meeting of the North American at St. Joseph—the Report says:

This society represents the industry in the United States and Canada, and as apiculture is a growing and important branch of agriculture, we have thought best to give it a considerable space in this Report. While it may not seem to have become sufficiently advanced locally to justify giving it so much attention, yet we feel that bee-keeping is of very great importance to the farmers of the State. It already adds largely to the income of our people, and we firmly believe that the profits derived therefrom will be greatly increased in the near future, as our citizens become more acquainted with the tools and methods of modern apiculture and its possibilities in our State. There is scarcely a locality in the State where a few bees may not be kept, and some parts of the State are especially suited to the profitable carrying on of this industry in connection with mixed farming.

As advanced methods of agriculture are introduced, and our people, as a result of this, give more attention to the growing of berries, orchards, small fruits and the clovers, the possibilities of apiculture in the State of Missouri will be greatly increased. Believing this to be true, and thinking that it would be in many ways profitable to our readers, we present herewith a lengthy report of the doings of the convention referred to above.



Buying to Sell Again.

Labeling the honey that a bee-keeper buys to supply his customers after his own crop is sold is being discussed a little. Getting up labels praising one's honey as being peculiarly superior to that produced by others, and then buying honey and selling it under such labels would be deception. As labels are usually worded, and as honey is usually bought and sold, I doubt if there will usually be any deception if both lots of honey are sold under the same label. I have bought and sold a great deal of honey, but I don't know as the question was ever asked me if the honey was of my own production, although I have frequently *told* customers that the honey was some that came from so and so, but they never seemed to manifest any particular interest in the matter. As a rule, I think

people don't care who produces the honey so long as it is good. I certainly would not word a label in such a way as to deceive. It may be that some labels are unintentionally deceptive, and if a man is making a business of buying and selling it might be well to have his labels so worded that no one could be deceived even if he tried to be.—Review Editorial.

Age of Bees.

Early last May I hived a swarm of Italians, and next day I found their queen dead under the alighting-board. I gave the colony a queen-cell. The weather was unusually cool at the time, and, several weeks after, I noticed that the hive was queenless; and on opening it I found that the young queen had never emerged from the cell. Laying-workers being present, no effort was made to requeen. In July, noticing that the hive was very heavy, and fearing robbers, I removed the hive and substituted a three-frame nucleus hive on the same stand, and drove the bees from the old hive with smoke. They took refuge in the nucleus hive, which was furnished with frames filled with foundation. Desiring to see how long they would live without a queen, and hoping that they would draw out the foundation, I let the bees remain in the nucleus hive all summer. They drew out the foundation in one frame in a patch about 5 inches in diameter, and survived until October 16, when the last one perished. This is evidence that bees may survive for six months of summer—an occurrence that seems a little unusual in view of what is usually taught in the books. The swarm was secondary, and the queen, consequently, a virgin, and no brood was reared, so that the last survivor was over six months old.—Gleanings.

Beginning of the Bee-Year.

The German wise heads say the bee-keepers' year does not begin either with spring or with January, but with October 1. There, now! All my records and things are adjusted to a bee-year beginning October 4. I'm within three days of it—just by the fortuitous circumstances of buying the apiary on that day. And the experience of so many years shows me that it is indeed just the proper place to divide year from year.—E. E. HASTY, in Review.

Quoting Honey at More Than Actual Market Prices.

Both in and out of the convention I learned that some of the houses, not only in Chicago, but other cities as well, had been making a practice of making special high quotations—at all events, considerably higher than it would be possible for them to realize in the open market. The object of this, of course, was to get consignments from bee-keepers; and in this they succeeded admirably. Well, having received the consignments these firms in many cases do not scruple to meet the sharpest competition in the open market, irrespective of what they had promised in the way of returns to the bee-keeper; and the honey will be sold for several cents lower per pound. Of course, there is complaint; but the commission house gets out of it by claiming a loss in leakage, broken-down comb honey, or poor quality all round. Again, they will claim to sell at quotations. They will quote at, say, 15 cts. per lb., and realize to the bee-keeper perhaps 8 cts. They claim that the honey was sold at 15 cts.; but after taking out the cartage, freight, commission, leakage, and other little items, they will work it around *somehow* so as to net the bee-keeper only 8 cents.—Gleanings Editorial.

A Few Healthy Don't's for Beginners.

In the first place, don't get too many colonies to start with. Two is enough, not more than four or five at the outside. After having secured your start, don't be in too much of a hurry about increasing your colonies. Don't divide them into a number of small colonies and expect to be able to get a crop of honey. With your limited experience you will simply sacrifice your honey crop for increase, and still have no experience in what is essential for a beginner to learn—the art of holding colonies advantageously for securing a crop of honey. Have patience, and don't try to go too fast. Let your efforts be directed to getting your colonies strong for the honey-flow, and always do all you can to discourage swarming rather than encourage it, and then you will find they will increase as fast or faster than your growing knowledge will enable you to handle them proficiently.

After having started in the spring, and had one summer's experience, don't spend your time the following winter inventing a hive that will revolutionize the bee-keeping world, for hives and frames of every conceivable size and shape have been tried, and over a quarter of a century of experience by

the leading scientific bee-keepers has decided, that the hives and frames now catalogued as standard by all supply dealers are the nearest approach to perfection that has yet been attained.

Don't buy hives that take other than a standard frame, for they are sure to be a vexation to you in the end.

Don't conduct new and costly experiments in your apiary until you have had several years of experience in the more common methods of bee-keeping. By that time you will have learned enough to let the other fellow do the experimenting. Experimenting is costly business, as I happen to know by experience. I followed this will-o'-the-wisp two or three years and made some grand inventions and many new and important discoveries, but just as I was about to turn them over to the bee-keeping public and become its everlasting benefactor, I invariably found that some other seeker had been there 10 or 15 years before, and that the thing I had spent so much time and money on had long since been discarded for having no other merit than incumbrance. And so it will be with any that go beyond their light.

Don't fail to get one or two good standard works on bees, and study them carefully. Besides, subscribe to one or more bee journals, or as many as you can afford. I know the beginner is apt to think he cannot afford any, but the truth is, if he has but one or two colonies of bees, he cannot afford to do without them. I take six, and my name is not Vanderbilt either, but I get so much practical good out of them I cannot afford to do with less.—ED. JOLLEY, in American Bee-Keeper.

Shade for Hives.

Sunflowers make a neat, effectual and desirable shade for hives. The seed must be planted early and the ground rich in order to have the plants large enough to furnish shade during the hot days of June and July. Plant five or six seeds in a row four feet long and a foot south of each hive. As the plants grow they can be thinned out if necessary. A sunflower apiary is decidedly picturesque.—Review.

Making a Feed-Syrup for Bees.

At the Home of the Honey-Bees they now incline toward a feed-syrup made by putting cold water into the extractor and pouring in sugar while the reel is run. Continue running the thing 10 or 15 minutes. Proportions half and half; or two of water to three of sugar for late feeding. No clubs—but if we follow all of Ernest's feeding plans will not Lincoln's story of the college graduate who came home and plowed, and followed too strictly his father's direction to "drive directly toward the black beifer"—will not that just about describe the crookedness of our furrow?—E. E. HASTY, in Review.



CONDUCTED BY

DR. J. P. H. BROWN, AUGUSTA, GA.

[Please send all questions relating to bee-keeping in the South direct to Dr. Brown, and he will answer in this department.—EDS.]

Most Likely a Laying-Worker.

DR. BROWN:—What is best to do in the following case? I looked through my hives yesterday (being a warm day) for the first time since Nov. 25. I found all had plenty of stores, and appeared to be strong and healthy, but in one colony I found on the center comb a little patch of drone-brood in worker-cells about three inches square. The brood was partly sealed and partly unsealed. I could not find the queen, but I am not sure that they are queenless, for none of my other queens are laying yet, and this colony had a very fine queen all last year, and was the gentlest 5-banded colony I had. Do you think it is possible that a laying-worker is the cause of it? I shall look at them again in a few days—the next warm day—it has been very cold since. The only reason I think it is drone-brood is because it stands out about ¼-inch beyond the comb when sealed, and is regular in every cell for about 3 inches square, and all in worker-cells on foundation. Where

do the eggs come from? None of the other queens are laying yet. Fruit generally blooms here sometime during February, and they should be starting now.

F. C. D. R.

Abilene, Tex., Jan. 11.

ANSWER.—The colony you refer to has either a very small unimpregnated queen, or a laying-worker—most likely the latter. The brood is drone. As soon as you can, give them a frame of unsealed brood to assist and encourage them. They may start queen-cells, but the queens would be of no service from the fact of you having no drones to fertilize them. Still, by giving a frame of brood occasionally you can preserve the colony until you get drones and then allow them to rear a queen. Before this you had better not allow any queen-cells to mature.

Bee-Smokers—Bee-Quilts.

There is a great deal in being used to a thing, I know, and sometimes it is mighty hard for an old fogey to get used to some of the new-fangled ideas that are set afloat now-a-days. When I began bee-keeping, or rather, when I began "to put on style" in bee-keeping, I did not want to spend much money buying new fixtures. Of course, I had to buy a smoker—not that I could not get along without it (we had been getting along with a roll of rags a long time), but I wanted my neighbors to see that I was progressive—I wanted to get ahead by getting something new. I bought a Clark smoker—I got used to it—learned to handle it, and liked it very much. I found one objection to it—it would not last *always*.

So, after about ten years, I concluded to buy another smoker, and sent to my supply dealer for a Clark smoker, but when I began to smoke with that smoker, I smoked myself instead of the bees—it smoked the wrong way. I sold it to a neighbor, and began to manufacture my own smokers (not for sale) because all the catalogues I could get showed that smoker all twisted out of shape. Not a word have I seen written against the change, and sometimes I wonder if all the good writers are really bee-keepers. Sometimes I think may be the manufacturers are not interested as much in handling bees as in the manufacture of supplies. How practical bee-keepers can tolerate a so-called Clark smoker, with the bellows opening next to the nozzle, I cannot understand. Every time it is opened and shut it is a banter to the bees, which they are sure to resent. Has any one ever suggested that the change was an improvement?

QUILTS OVER THE FRAMES.

On page 46 Mr. Thos. Thurlow asks: "What do people use quilts on top of the frames for? What do they do with them when they get covered with propolis," etc.?

I use a quilt made of smooth cotton cloth, usually called "sheeting," as a covering for the frames or sections, to confine the bees in their proper place, because it is cheaper and more easily handled than a board cover.

When the quilts get pretty well covered with propolis and wax, I give them a good ironing with an iron just warm enough to melt the wax when moved slowly over them several times, and then I have an ideal quilt—a quilt that will keep the bees dry, should there happen to be a leak in the hive-cover. I use the gable hive-cover.

I know nothing of the ripping and cracking that run the bees crazy, but I suggest that when the propolized cloth over a full colony of bees is so very hard that it breaks with a crash, the hive should not be opened unless the bees need feeding, as they will surely be injured by exposure to the cold.

Bessemer, Ala.

C. C. PARSONS.

☞ Bee-keeping offers additional funds to the poorly paid; out-door air to clerk and office-hand; healthful exercise to the person of sedentary habits; opportunity for the poor to reap what would otherwise go to waste; and superior recreation to the student, teacher and professional man, especially to him whose life-work is of that dull, hum-drum, routine order that seems to rob life of all zest.—PROF. COOK.

The McEvoy Foul Brood Treatment is given in Dr. Howard's pamphlet on "Foul Brood; Its Natural History and Rational Treatment." It is the latest publication on the subject, and should be in the hands of every bee-keeper. Price, 25 cents; or clubbed with the Bee Journal for one year—both for \$1.10.

Every Present Subscriber of the Bee Journal should be an agent for it, and get all others possible to subscribe for it.

Book Premiums for Getting New Subscribers

For each New Subscriber to the American Bee Journal sent us by a present subscriber, we will give as a Premium 40 cents' worth of the Books, Pamphlets, etc., described on this page—figuring on the retail price given in connection with each book, etc., below. This is a very easy way to get a lot of most excellent literature.

Free Copy of "BEES AND HONEY" to Every New Subscriber.

Yes, in addition to the above offer, we will mail free a copy of Newman's 160-page "Bees and Honey"—premium edition—to each new subscriber, NOW IS JUST THE TIME to work for big lists of New Subscribers.

The American Bee Journal List Should Easily Be DOUBLED on these Liberal Offers.

BEE-BOOKS

SENT POSTPAID BY

George W. York & Co.,
Chicago, Ills.

Bees and Honey, or Management of an Apiary for Pleasure and Profit, by Thomas G. Newman.—This edition has been largely re-written, thoroughly revised, and is "fully up with the times" in all the improvements and inventions in this rapidly-developing pursuit, and presents the apiarist with everything that can aid in the successful management of an apiary, and at the same time produce the most honey in an attractive condition. It contains 250 pages, and 245 illustrations—is beautifully printed in the highest style of the art, and bound in cloth, gold-lettered. Price, \$1.00.

Langstroth on the Honey-Bee, revised by Dadant.—This classic in bee-culture, has been entirely re-written, and is fully illustrated. It treats of everything relating to bees and bee-keeping. No apiarist library is complete without this standard work by Rev. L. L. Langstroth—the Father of American Bee-Culture. It has 520 pages; bound in cloth. Price, postpaid, \$1.25.

Bee-Keepers' Guide, or Manual of the Apiculture, by Prof. A. J. Cook, of the Michigan Agricultural College.—This book is not only instructive and helpful as a guide in bee-keeping, but is interesting and thoroughly practical and scientific. It contains a full delineation of the anatomy and physiology of bees. 400 pages; bound in cloth and fully illustrated. Price, postpaid, \$1.25.

Scientific Queen-Rearing, as Practically Applied, by G. M. Doolittle.—A method by which the very best of Queen-Bees are reared in perfect accord with Nature's way. 176 pages, bound in cloth, and illustrated. Price, \$1.00.

A B C of Bee-Culture, by A. I. Root.—A cyclopedia of 400 pages, describing everything pertaining to the care of the honey-bee. It contains 300 engravings. It was written especially for beginners. Bound in cloth. Price, \$1.25.

Advanced Bee-Culture, Its Methods and Management, by W. Z. Hutchinson.—The author of this work is too well known to need further description of his book. He is a practical and entertaining writer. You should read his book. 90 pages, bound in paper, and illustrated. Price, 50 cts.

Rational Bee-Keeping, by Dr. John Dzierzon.—This is a translation of his latest German book on bee-culture. It has 350 pages; bound in cloth, \$1.25; in paper covers, \$1.00.

Biene-Kultur, by Thomas G. Newman.—This is a German translation of the principal portion of the book called BEES AND HONEY. 161 page pamphlet. Price, 40 cents.

Conventional Hand-Book, for Bee-Keepers. Thomas G. Newman.—It contains the parliamentary law and rules of order for Bee-Conventions—also Constitution and By-Laws, with subjects for discussion, etc. Cloth, gold-lettered. Price, 25 cts.

Amerikanische Bienezucht, by Hans Buschbauer.—Printed in German. A hand-book on bee-keeping, giving the methods in use by the best American and German apiarists. Illustrated; 138 pages. Price, \$1.00.

Thirty Years Among the Bees, by Henry Alley.—Gives the results of over a quarter-century's experience in rearing queen-bees. Very latest work of the kind. Nearly 100 pages. Price, 50c.

Why Eat Honey?—This Leaflet is intended for FREE distribution, to create a Local Market. 100 copies, by mail, 40 cts.; 500 for \$1.50; 1000, \$2.50. If 500 or more are ordered at one time, your name and address will be printed on them FREE.

How to Keep Honey and preserve its richness and flavor. Price same as Why Eat Honey.

Apiary Register, by Thos. G. Newman.—Devotes two pages to a colony. Leather binding. Price, for 50 colonies, \$1.00; for 100 colonies, \$1.25.

Preparation of Honey for the Market, including the production and care of comb and extracted honey. A chapter from BEES AND HONEY. Price, 10 cents.

Bee-Pasturage a Necessity.—This book suggests what and how to plan. It is a chapter from BEES AND HONEY. Price, 10 cents.

The Hive I Use, by G. M. Doolittle. It details his management of bees, and methods of producing comb honey. Price, 5 cents.

Dr. Howard's Book on Foul Brood.—Gives the McEvoy Treatment and reviews the experiments of others. Price, 25 cts.

Dictionary of Apiculture, by Prof. John Phil. Gives the correct meaning of nearly 500 apicultural terms. Price, 50 cts.

Winter Problem in Bee-Keeping, by G. R. Pierce. Result of 25 years' experience. 50 cts.

Handling Bees, by Chas. Dadant & Son.—A Chapter from Langstroth Revised. Price, 8 cts.

Bee-Keepers' Directory, by H. Alley.—Latest methods in Queen-Rearing, etc. Price, 50c.

Foul Brood Treatment, by Prof. F. R. Cheshire.—Its Cause and Prevention. Price, 10 cts.

Foul Brood, by A. R. Kohske.—Origin, Development and Cure. Price, 25 cts.

History of Bee-Associations, and Brief Reports of the first 20 conventions. Price, 15 cts.

Honey as Food and Medicine, by T. G. Newman.—A 32-page pamphlet; just the thing to create a demand for honey at home. Should be scattered freely. Contains recipes for Honey-Cakes, Cookies, Puddings, Foam, Wines, and uses of honey for medicine. Price, prepaid—Single copy, 5 cts.; 10 copies, 35 cts.; 50 for \$1.50; 100 for \$2.50; 250 for \$5.50; 500 for \$10.00; or 1000 for \$15.00.

When 250 or more are ordered, we will print the bee-keeper's card (free of cost) on the front cover page.

Bee-Keeping for Profit, by Dr. G. L. Tinker.—Revised and enlarged. It details the author's "new system, or how to get the largest yields of comb or extracted honey." 80 pp.; illustrated, 25c.

Emerson Binders, made especially for the BEE JOURNAL, are convenient for preserving each number as fast as received. Not suitable to Canada. Price, 75 cts.

Commercial Calculator, by C. Ropp.—A ready Calculator, Business Arithmetic and Account-Book combined in one. Every farmer and business man should have it. No. 1, bound in water proof leatherette, calf finish. Price, 40 cts. No. 2, in artificial leather, with pocket, silicate slate, and account-book. Price, 60 cts.

Green's Four Books, by Chas. A. Green.—Devoted to, 1st, How We Made the Old Farm Pay; 2nd, Peach Culture; 3rd, How to Propagate Fruit-Plants, Vines and Trees; 4th, General Fruit Instructor. Nearly 120 pages. Fully illustrated. 25 cts.

Green's Six Books on Fruit-Culture, by Chas. A. Green.—Devoted 1st, to Apple and Pear Culture; 2nd, Plum and Cherry Culture; 3rd, Raspberry and Blackberry Culture; 4th, Grape Culture; 5th, Strawberry Culture. 129 pp.; illustrated, 25 cts.

Garden and Orchard, by Chas. A. Green.—Gives full instructions in Thinning and Marketing Fruits; Pruning, Planting and Cultivating; Spraying, Evaporation, Cold Storage, Etc. 94 pages, illustrated. Price, 25 cts.

Kendall's Horse-Book.—35 pictures, showing positions of sick horses, and treats on all their diseases. English or German. Price, 25 cts.

Silo and Silage, by Prof. A. J. Cook.—It gives the method in operation at the Michigan Agricultural College. Price, 25 cts.

Lumber and Log-Book.—Gives measurements of lumber, logs, planks; wages, etc. 25c.

Maple Sugar and the Sugar Bush, by Prof. A. J. Cook.—Full instructions. Price, 35 cts.

Grain Tables, for casting up the price of grain, produce, hay, etc. Price, 25 cts.

Capons and Caponizing, by Dr. Sawyer' Fanny Field, and others.—Illustrated. All about caponizing fowls, and thus how to make the most money in poultry-raising. 64 pages. Price, 30 cts.

Our Poultry Doctor, or Health in the Poultry Yard and How to Care Sick Fowls, by Fanny Field.—Everything about Poultry Diseases and their Care. 64 pages. Price, 30 cts.

Poultry for Market and Poultry for Profit, by Fanny Field.—Tells everything about the Poultry Business. 64 pages. Price, 25 cts.

Turkeys for Market and Turkeys for Profit, by Fanny Field.—All about Turkey-Raising. 64 pages. Price, 25 cts.

Rural Life.—Bees, Poultry, Fruits, Vegetables, and Household Matters. 100 pages. 25 cts.

Strawberry Culture, by T. B. Terry and A. I. Root. For beginners. Price, 40 cts.

Potato Culture, by T. B. Terry.—It tells how to grow them prettably. Price, 40 cts.

Carp Culture, by A. I. Root and Geo. Finley.—Full directions. 70 pages. Price, 40 cts.

Hand-Book of Health, by Dr. Foote.—Hints about eating, drinking, etc. Price, 25 cts.

Alsike Clover Leaflet.—Full directions for growing. 50 for 25 cts.; 100 for 40 cts.; 200, 70c.

Book Clubbing Offers.

(Read Carefully.)

The following clubbing prices include the American Bee Journal one year with each book named. Remember, that only ONE book can be taken in each case with the Bee Journal a year at the prices named. If more books are wanted see postpaid prices given with the description of the books on this page. Following is the clubbing-list:

1. Langstroth on the Honey-Bee.....	\$2.00
2. A B C of Bee-Culture.....	2.00
3. Bee-Keeper's Guide.....	1.75
4. Bees and Honey [Cloth bound].....	1.65
5. Scientific Queen-Rearing.....	1.75
6. Dr. Howard's Foul Brood Book.....	1.10
7. Advanced Bee-Culture.....	1.30
8. Amerikanische Bienezucht [Germ.].....	1.75
9. Biene-Kultur [German].....	1.25
10. Rational Bee-Keeping [Cloth bound].....	2.00
11. Rational Bee-Keeping [Paper bound].....	1.75
12. Thirty Years Among the Bees.....	1.30
13. Bee-Keeping for Profit.....	1.15
14. Conventional Hand-Book.....	1.15
15. Poultry for Market and Profit.....	1.10
16. Turkeys for Market and Profit.....	1.10
17. Capons and Caponizing.....	1.10
18. Our Poultry Doctor.....	1.10
19. Green's Four Books.....	1.15
20. Green's Six Books on Fruit-Culture.....	1.15
21. Garden and Orchard.....	1.15
22. Rural Life.....	1.10
24. Emerson Binder for the Bee Journal.....	1.60
25. Commercial Calculator, No. 1.....	1.25
26. Commercial Calculator, No. 2.....	1.40
27. Kendall's Horse-Book.....	1.10
29. Strawberry Culture.....	1.20
30. Potato Culture.....	1.20
31. Carp Culture.....	1.20
32. Hand-Book of Health.....	1.10
33. Dictionary of Apiculture.....	1.35
34. Maple Sugar and the Sugar Bush.....	1.20
35. Silo and Silage.....	1.10
36. Winter Problem in Bee-Keeping.....	1.30
37. Apiary Register (for 50 colonies).....	1.75
38. Apiary Register (for 100 colonies).....	2.00
39. Bee-Keepers' Directory.....	1.30

Please Send Us the Names of your neighbors who keep bees, and we will send them sample copies of the BEE JOURNAL. Then please call upon them and get them to subscribe with you, and secure some of the premiums we offer.

California

If you care to know of its Fruits, Flowers Climate or Resources, send for a Sample Copy of California's Favorite Paper—

The Pacific Rural Press

The leading Horticultural and Agricultural paper of the Pacific Coast. Published weekly, handsomely illustrated, \$2.00 per annum. Sample Copy Free.

PACIFIC RURAL PRESS,
220 Market St., - SAN FRANCISCO, CAL.
Mention the American Bee Journal.



OUR POULTRY ANNUAL
and Book of Valuable Recipes, 64 large pages, contains 8 beautiful colored plates of fowls, gives description and prices of 45 varieties, with important hints on care of poultry, and pages of recipes of great value to everyone. Finest Poultry Book published for 1896. Postpaid only 10 cts. **C. N. Eowers, Box 24, Dakota, Ill.**

52A13 Mention the American Bee Journal.

WANTED!

10,000 pounds of BEESWAX, for Cash. Address, **LEAHY MFG. CO., Higginsville, Mo.** Mention the American Bee Journal.



SUCCESSFUL INCUBATOR
Our magnificent new catalogue giving full information regarding artificial Hatching & Brooding and treatise on poultry raising sent for 4c stamps. Circular free.

49A13t Mention the American Bee Journal.

For Sale—A Bargain.

119 Colonies of Italian Bees in Chaff Hives. Good House, and 2 acres of Land, with excellent well of water. **E. L. CARRINGTON, 5A4t PETTUS, Bee Co., TEX.**

CALIFORNIA, "WAKE UP!"

The Pacific Bee Journal, devoted to the Protection and Advancement of Bee-Keepers' Interests on the Pacific Slope. 50 cts. per year. Send for sample copy.

THE BENNETT BEE-HIVE COMPANY

now make Foundation at 40 cents per pound. Bee-Hive Bodies (plain corners) 17½c. each. Common Bee-Hive, 2-story. 60 cts. each. Dovetailed Hives, \$1.00 each. Sections and Supplies low. Send for Price-List, and Save Money. 365 E. Second St., **LOS ANGELES.** Mention the American Bee Journal.

Italian Bees for Sale.

Prices will be as follows.

One Colony..... \$6.00
Five Colonies..... 28.00
Ten "..... 50.00

Each Colony will contain one of my \$2.00 Queens.

NUCLEUS COLONIES.

Any size from One frame up. Select Tested Queens, \$2.00 each. or Two for \$3.00. Breeding Queens, \$3.00 to \$5.00. Address,

F. A. CROWELL,
8E2t GRANGER, Ill. Co., MINN.

ALFALFA, CRUONER AND ALSIKE Clover Seed. One or more lbs. by mail 25c.; bushel, \$6.00; peck or more at bushel rates. Invaluable for honey and forage. **Dr. C. L. PARKER,**

8A4t ONONAGA, ONON. CO., N. Y.
WHEN ANSWERING THIS ADVERTISEMENT, MENTION THIS JOURNAL.

General Items.

His Largest Yield.

My largest yield was in 1882—1,960 pounds of comb honey from 14 colonies. I sold it all at 20 cents per pound. Peotone, Ill. **C. SCHRIER.**

Some Big Honey Crops.

In 1882 I secured 10,175 pounds of honey from 60 colonies, spring count, and increased to 150. It was about ¾ extracted and ¼ comb. In the spring I selected one that I thought an average colony, and weighed all the honey taken from it—it footed up 306 pounds of extracted honey, leaving enough in the hive for the bees to winter on. It cast one swarm, and from this I extracted 150 pounds, making a total of 456 pounds, spring count.

In 1889 I got 9,000 pounds of extracted and 4,000 pounds of comb honey from 90 colonies, spring count, and increased to 160. There have been some very poor seasons, but my bees always got enough to winter on. I use a chaff hive, and winter bees on the summer stands. Gilson, Ill. **C. W. McKOWN.**

Sowing Buckwheat for Honey.

On page 37 Dr. Miller quotes from Mr. Quinby, that an acre of buckwheat yielded 25 pounds of honey a day, but says he believes the veteran Quinby was guessing. Any one planting buckwheat for honey would be assured of that fact. Of course, in some localities it will yield more than in others. On my trip in October, 1895, I visited a good many bee-keepers in northern Ohio, and found nearly every one planted several acres of buckwheat for his bees, and said they thought it paid. But my experience would not bear out that assertion. I sowed two acres July 15, 1894, got a good stand, full bloom Aug. 15 to Sept. 1, yet I do not believe my bees stored a pound of buckwheat honey. I never found but a few bees working on it at any time. I attribute their failure to work on it to the fact that the "dry weather honey-vine" began to bloom about the same time, and continued until cut down by frost. This shows more strongly than ever that bee-keepers must not plant for honey alone. Evansville, Ind. **J. C. WALLENMEYER.**

Several Questions Noted.

SWEET CLOVER.—I am pleased to see so much interest taken in sweet clover. It might be of great value to the Southern bee-keeper as a honey-plant. Where it grows here by the roadside, it is alive with bees when there is nothing else for them to work on, or at any time when it is in bloom; but we do not have it in large quantities to get any surplus from it.

PREVENTING APIARY THIEVES.—On page 29 E. C. Culbert speaks of having four vicious dogs to guard one apiary. Why not

enclose the apiary with Page woven wire fence and a barbed wire over that, and put a vicious dog in the enclosure. Use more wire and less dog, and mark the result.

MOVING BEES.—On page 20, W. C. H. asked how to move his bees. Now if those bees were mine I should not consider it a very bad job. If the frames had not been moved or handled since cold weather I should not try to fasten them, and if the hives are in a dilapidated condition, so as to allow the bees to escape all around, the bottom-boards undoubtedly would come off easily, and I should take them off, or rather, take the hives off of them. Then have at hand about 1½ yards of sheeting, and place that on the bottom-board so about 5 inches of it will be out on one side, the balance over the bottom-board and the other side. Now set the hive on this, and when the bees are settled you can fold the sheeting over or around the whole hive, and with a few small nails and strips like bottom-bars or comb-guides, the cloth can soon be made fast, and not a bee can escape. Use the cloth full width, and that will give a good chance to fold over the ends of the hive. The bees will not gnaw out, only don't let the hives rub together and wear a hole through. The cloth or sheeting here would cost 6 cents per yard, or 9 cents per hive—as cheap as wire-cloth for the top of the hive. I have moved bees 13 miles with only cloth like this to keep them in. Clayton, Mich. **C. A. HUFF.**

Bees Did Fairly Well in 1895.

Our bees did fairly well the past season. I got an average of 40 pounds of section honey per colony, varying from 8 pounds to 102 per colony. The Italians are far ahead of the blacks with us. One colony, which was given to us in September, 1894, which we drummed out of a box-hive, gave it an untested Italian queen in October, and wintered on candy, gave us 78 one-pound sections, and a good prime swarm. We have concluded to clip the stings of our queens, and breed out the habit! Champlin, Minn. **W. H. STOUT.**

Sweet Clover Questions, Etc.

That picture on the first page of the Bee Journal for Dec. 19, is enough to make a bee-man turn green with envy. I want to thank Mr. Stolley for the excellent treatise on sweet clover that accompanied it. But to show that human nature is never satisfied, I would like to ask Mr. Stolley a few questions (for Dr. Miller's benefit, you know):

1. How do you cut and handle it when cutting for seed?
2. How do you get it hulled? Can it be hulled with a common clover-huller? Any other way? I am referring to a large lot of two or three acres or more?

I know by the last two years' experience that Mr. Stolley is right in saying that it is a much more reliable plant for honey than white clover, and is not affected by ordinary drouths. It is a wonderful plant to withstand drouths. Speaking of drouths,

Got Something for Nothing!

Did You? Thousands of readers answering my ad. in the past received free by mail at a cost of 20 cents to me, a package of my discovery, **VITLÉ ORE**, and 90 per cent. have written to thank me and send cash order for more, declaring that it had done them more good than all doctors and man-made remedies they ever used. I scorn to take any one's money until convinced at my expense that V.-O. is the best thing in, on, or out of the earth for all who suffer from ills no doctor or drug will cure, such as general debility, feebleness from over-work, worries, cares, protracted sickness, old age, female complaints, all kidney and membranous ailments. It is the only natural, Nature's cure for human ills ever offered to man, and not by a quack doctor or methods peculiar thereto. If you have been bamboozled often, and grievously, by robbers in the medicine business, I am not responsible therefor, but am if V.-O. fails to give greater satisfaction than all else you ever tried. Send the addresses of six sick people and I will do the balance. **THEO. NOEL, Geologist, Tacoma Building, Chicago, Ill.**

Mention the Bee Journal.

The Bee-Keepers' Guide:

Or Manual of the Apiary,

By Prof. A. J. Cook.

This 15th and latest edition of Prof. Cook's magnificent book of 460 pages, in neat and substantial cloth binding, we propose to give away to our present subscribers, for the work of getting NEW subscribers for the American Bee Journal.

A description of the book here is quite unnecessary—it is simply the most complete scientific and practical bee-book published to-day. Fully illustrated, and all written in the most fascinating style. The author is also too well-known to the whole bee-world to require any introduction. No bee-keeper is fully equipped, or his library complete, without "THE BEE-KEEPER'S GUIDE."

For Two New Subscribers and Your Own Renewal.

Send us Two New Subscribers to the Bee Journal and your own renewal (with \$3.00), and we will mail you a copy of Prof. Cook's book FREE as a premium, and also a copy of the 160-page "Bees and Honey" to each New Subscriber. Prof. Cook's book alone is \$1.25, or we club it with the Bee Journal for a year—both together for only \$1.75. But surely anybody can get only 2 new subscribers to the Bee Journal for a year, and thus get the book as a premium. Let everybody try for it. Will you have one?

GEORGE W. YORK & CO.,
CHICAGO, ILLS



HAVE LASTED 17 YEARS.

BEST ON EARTH.

Always Give Perfect Satisfaction.

My cool Wire Handle and Bent Nose were patented 1892, are the original, my best invention since my open or direct draft Patent, 1878, that revolutionized Bee-Smokers. My Handle and Nose Patent bent all the other smoker noses. None but Bingham Smokers have all the best improvements. If you buy genuine Bingham Smokers and Honey-Knives, you will never regret it. The "Doctor," 1/4-inch larger than any other smoker on the market—3 1/2-inch stove, by mail, \$1.50

Conqueror, 3 " " "	1.10
Large, 2 1/2-in. " " "	1.00
Plain, 2-in. " " "	.70
Little Wonder, 2-in., wt. 10 oz.	.60

Bingham & Hetherington Honey-Knives, 80 cents.

T. F. BINGHAM, Farwell, Mich.
7Atf Mention the Bee Journal.

did the readers of the Bee Journal know we had one? Yes, here in western Iowa we haven't had enough snow and rain together, since the middle of last August, to make one good, ordinary rain. It is fine winter weather, but where will our white clover be by spring?

That reminds me of another good trait of sweet clover. Last winter all white and red clover winter-killed here on account of dry winter, but sweet clover came through smiling as usual.

I wish to tell Mr. Peter J. Schartz (see page 807, 1895), that he must not blame a thing for not working right when it isn't put together rightly, or part is gone. If he will nail a strip of tin, or sheet-iron, 3/4 of an inch wide, across each end of those supers of his, that have the section-holders or slats on the bottom side, for the slats to rest upon, and then wedge the sections up tight from both sides and end, if necessary, I will undertake to get it off the hive and sections of honey out of it and cleaned in the same time he takes to get off his T super and clean the sections. If I can't do it I'll stand treat, Peter.

I got about 300 pounds of honey from 15 colonies, and increased to 28 the past season. If any bee-keeper in western Iowa has good comb honey to sell, I would like to urge him very strongly not to sell it for 12 or 14 cents in trade to some store-keeper. As scarce as honey is, you can get 18 or 20 cents per pound cash for good, clean, comb honey. Don't let your honey stay on the hive until the sections are brown and the capping of the honey water-soaked. The honey may be just as good, and even better for it, but it won't sell as readily, or for as good a price. I just wish I could produce as much honey as I could sell for 18 and 20 cents per pound. E. S. MILES, Denison, Iowa.

'Twas the Indian, Not the White Man.

Will you do me the favor to read again the manuscript of my biography, on page 101? Somebody who furnishes copy, or sets type, made a terrible mistake. I wrote: "Here, too, fished and hunted and drank fire-water and begged tobacco, a lone Indian, Johnathan Paul—the last of the Mohegans." Your types made me say that I did the hunting and fishing, and that I drank fire-water and begged tobacco of an Indian! My friends will be surprised to learn that I ever did any of those things. In my boyhood I was too much devoted to my books to spend any time hunting and fishing. Intoxicating liquors were quite freely used by most of the people around me at that time, but I never tasted them unless prescribed by my physician. They were used medicinally much more than now. I never entered a saloon in my life unless it was to call some man out with whom I had business which could not wait his pleasure. As for tobacco, I have never used it in any form.

In my early boyhood there was an Indian living in my native town whom the people called "Johnathan Paul." He spent his time in the way you have made me say I spent mine. When asked to what tribe he belonged, he would mutter "Mohegan." He was the last Indian that ever was seen in that region. It was the recollection of him that led me to write the unfortunate sentence. EDWIN BEVINS, Leon, Iowa.

[Mr. Bevins, we think the fellow that made you appear in such a bad light ought to be—well, what would you do with him? We'll have to own up that it was our fault entirely, and we are glad to give your correction. We are very sorry it occurred, and trust all our readers will read your letter above.—EDITORS.]

A Bee-Cellar Described.

The spring of 1895 I started with two colonies of Italian bees which I purchased in the summer of 1894. The spring was rather backward, and the bees did not get started

POULTRY

40 Standard Breeds Illustrated & fully described in my new Poultry Book. Reliable information for poultrymen & intending buyers. Good stock Ducks & Geese; also Shetland Ponies. Send 6c in stamps.

E. H. COOK, Box 27, Huntley, Ill.

Mention the American Bee Journal. 4A13t

BASSWOOD TREES!

Orders booked now for Spring delivery for Nursery-Grown Basswood Seedlings

5 to 9 inches high, at \$2 00 per 100; 300 for \$5 or \$15.00 for 1000. Parties living east of the Mississippi river will be supplied direct from our Nurseries in Ohio. Satisfaction guaranteed.

A. H. FITCH,
702 Youngerman Bldg., DES MOINES, IOWA.
4Atf Mention the American Bee Journal.

REEDS YELLOW DENT

GRAND SWEEPSTAKES CORN AT ILL. STATE FAIR 1895.

Best Corn in the whole big Corn State of Illinois. Best Yellow Dent from NORTHERN Division, Best Yellow Dent from ALL Divisions. Best corn shown.

MANDSCHEURI BARLEY. Better than Manshury!

Sent out last year by the Wis. Ex. Station. Catalogue of Seed Potatoes, Field Seeds and Garden Seeds.

L. L. OLDS - Clinton - Rock Co. - Wis.

Mention the American Bee Journal.

PATENT WIRED COMB FOUNDATION

Has No Sag in Brood-Frames

Thin Flat-Bottom Foundation

Has No Fishbone in the Surplus Honey.

Being the cleanest is usually worked the quickest of any Foundation made

J. VAN DEUSEN & SONS,
Sole Manufacturers,
Sprout Brook Montgomery Co., N. Y.

For Sale—A Dozen Colonies of Italian and Carniolan Bees in 8-frame Langstroth-Simplicity hives. The Combs all built on full sheets of foundation, wired in, and straight as a board. Seven of the Queens are Imported, and all are of last year's rearing. Will be sold at \$5.50 per colony for imported and \$4.50 for native. Bees are in fine condition with plenty of stores to carry them through. Address:

W. J. CULLINAN,
QUINCY, ILL.

NEW MAMMOTH Poultry Guide for 1896

Finest book ever published, contains nearly 100 pages, all printed in colors, plans for best poultry houses, sure remedies and recipes for all diseases, and how to make poultry and gardening pay. Sent post paid for 15c.

John Bauscher, Jr., box 94 Freeport, Ill.

49A13t Mention the American Bee Journal.



No Hurry! Take Your Time!

Just had a customer who was ten years making up his mind. Using our fence all the time too, as his farm joins a railroad with PAGE between. We send our paper free while you wait.

PAGE WOVEN WIRE FENCE CO., Adrian, Mich.
Mention the American Bee Journal.

Promptness Is What Counts!

Honey-Jars, Shipping-Cases, and everything that bee-keepers use. Root's Goods at Root's Prices, and the best shipping point in the country.

Dealer in Honey and Beeswax. Catalogue Free.

162 MIANS. AVE.
INDIANAPOLIS, IND.

12 Pkgs. tested, pure, fresh garden seeds, 12 cts., postpaid. R. N. Thomas, Shenandoah, Iowa.

TEXAS QUEENS.

If you are in need of Queens, let me have your order. Price-List Free.
8A26t J. D. GIVENS, Lisbon, Tex.

If "The Best is the Cheapest" is applicable to the purchase of anything, it is pre-eminently so to that of trees. You find no seedlings scattered through your orchard if you purchase direct of a thorough nurseryman. The Storrs & Harrison Company, Painesville, Ohio, have been in the nursery business over 40 years, have the reputation of being expert tree growers, and as you will see in our advertising columns offer a valuable catalogue free. If you are in want of trees, plants, seeds, or anything in the nursery line, send them your address on a postal.



50c Trial Sets Of Choice Seeds, Plants and Fruits.

By mail postpaid, safe arrival and satisfaction guaranteed. Order by the letters and the numbers from this advertisement NOW, as these are introductory sets, not in catalogue, an Elegant Annual of 168 pages, which will be sent free with first order. If none of these sets suit you and you want anything in our line send for CATALOGUE FREE. About 60 pages devoted to VEGETABLE and FLOWER SEEDS, 70 to PLANTS and the balance to the CREAM OF THE FRUITS. Trees and plants in these sets are all thrifty and well rooted. Try them.

- Set J—10 elegant profuse blooming Roses, including one of the new famous Crimson Rambler. 50c
- " B—15 pkts choice Vegetable Seeds, 15 sorts and 1 pkt. of our new Golden Hubbard Squash. 50c
- " E—20 pkts choice Flower Seeds, 20 sorts. 50c
- " F—10 fragrant Carnation Pinks, 10 sorts. 50c
- " G—10 Prizes Chrysanthemums, 10 sorts. 50c
- " H—4 superb French Camias, 4 sorts. 50c
- " K—10 large flowered Geraniums, 10 sorts. 50c
- " L—30 fine Gladioli all flowering bulbs. 50c
- " N—10 Tuberoses, 2 double sorts all flowering. 50c
- " O—10 flowering plants all different. 50c
- " P—6 hardy ornamental Shrubs, 6 sorts. 50c
- " Q—6 hardy Climbing Vines, 6 sorts. 50c
- " U—2 elegant Palms, strong plants, 2 sorts. 50c

One-half each of any two sets 50c., any 3 sets \$1.25, 5 sets \$2.00.

Everything of the best for LAWN, CONSERVATORY, PARK, ORCHARD, VINEYARD and GARDEN.

42nd YEAR. 1000 ACRES. 29 GREENHOUSES.

THE STORRS & HARRISON CO., Box 219 Painesville, O.

CARLOADS



Of Bee-Hives, Sections, Shipping-Cases, Comb Foundation, and Everything used in the Bee-Industry.

I want the name and address of every Bee-Keeper in America. No reason why you can not do business with me. I have

Cheap Lumber and Experienced Workmen; a good Water-Power Factory and know how to run it. I am supplying Dealers as well as consumers. Why not you? Send for Catalogues, Quotations, etc. **W. H. PUTNAM, JR.** RIVER FALLS, Pierce Co., Wis.

Mention the American Bee Journal.

WOVEN WIRE FENCE



Over 50 Styles. The best on Earth. Horse high, Bull strong, Pig and Chicken light. You can make from 40 to 60 rods per day for from 14 to 22c. a Rod. Illustrated Catalogue Free. **KITSELMAN BROS.,** Ridgeville, - Indiana.

48Etf Mention the American Bee Journal.

WANTED—200 Colonies of Bees and 4-FRAME NUCLEI, on Simplicity or Hoffman frames, in exchange for Supplies, to be shipped either from here or Medina, Ohio. Send for Catalog to—**GEO. E. HILTON,** 4E4t FREMONT, MICH.

STRAWBERRY PLANTS FOR SALE.

Michigan Grown Plants are the Best.

BUBACH, PARKER EARLE, HATERLAND, WARFIELD AND JESSIE.

Vigorous Plants of the above well-known varieties shipped direct from the Nursery—Lake View Fruit Farm, Gibson, Mich., 100, \$1.00; 200, \$1.50, postage paid. Special price on large quantities. Address.

CHAS. N. TRIVESS, Manager, 635 Chicago Stock Exchange, - CHICAGO, ILL. 6E4t Mention the American Bee Journal.

WANTED—By a young man (23) a position in a good apiary, or apiary and small fruit or gardening business combined, preferably South and near this State, for the coming season. Has already had good experience with bees, and is willing, serviceable, and active. Would appreciate a good home and a generous employer. Is an experienced clerk, with good references. Address. 6E4t **C. C. DOORLY,** Alphin, Va.

Bees, Queens, Nuclei—We will sell, the coming season, 500 Two-Frame Nuclei, with a Choice Warranted Queen, at \$2.50 each. Special prices on large orders furnished. **LEININGER BROS.,** 6E4t FT. JENNINGS, OHIO.

WANTED.

10,000 pounds of **BEESWAX**, for Cash. Address, **LEAHY MFG. CO.,** Higginsville, Mo.

INCUBATORS

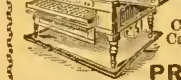

Our 160 page, finely illustrated Combined Poultry Guide and Catalogue will tell you what you wish to know about

PROFITS IN POULTRY
We manufacture a complete line of Incubators, Brooders and Poultry Appliances. Guide and Catalogue 10c. (stamps or silver) Worth one Dollar. **Reliable Incubator & Brooder Co., Quincy, Ill.** 38E15t Please mention this Journal.

COMB FOUNDATION WHOLESALE AND RETAIL.

Are you going to buy Foundation for Cash, or have you Wax to sell or trade for Foundation and other Supplies? Have you 25 lbs or more of Wax that you want made into Foundation? If so, do not fail to write me for samples and prices. I make a specialty of working up Wax by the lb., and do it very cheap during the winter. Beeswax wanted at all times. **GUS DITTMER, AUGUSTA, WIS.** Reference—Augusta Bank. 16Atf

Mention the American Bee Journal.

IF YOU WANT THE BEE-BOOK

That covers the whole Apicultural Field more completely than any other published, send \$1.25 to Prof. A. J. Cook, Claremont, Calif., for his

Bee-Keeper's Guide.

Liberal Discounts to the Trade.

TAKE NOTICE!

BEFORE placing your orders for SUPPLIES, write for prices on 1-Piece Basswood Sections, Bee-Hives, Shipping-Crates, Frames, Foundation, Smokers, etc.

PAGE & LYON MFG. CO. NEW LONDON, WIS.

MILLIONS OF DOLLARS

SAVED ANNUALLY BY FRUIT CROVERS using Deming SPRAYING Outfits. Recommended by leading Horticulturists. 32 page illustrated catalogue and treatise FREE. **The Deming Co., Mfgs., Salem, Ohio.** Henton & Hubbard, Gen'l West. Ag'ts, Chicago. Mention the American Bee Journal.

1896 SAVE MONEY 1896

If you want first-class **ITALIAN QUEENS FOR BUSINESS**, Foundation at Wholesale Prices, Hives, suited for the South, or SUPPLIES, send for Price-List—to

J. P. H. BROWN, AUGUSTA, GA.

until late—did not get any swarms until the last of June.

In May I ordered one colony and a half from another bee-keeper, making three and one-half colonies that I really started the season with. From the time they commenced to swarm they did quite well. I let them swarm naturally, and at the end of the season I had taken 325 pounds of surplus comb honey, and had increased to 17 colonies. One colony which lost its queen, and one late swarm, both went into the cellar rather weak, but the rest were in good condition. I should have tried to build up the weak ones, but I had so much else to do in the fall that I could not see to it.

My bee-cellar is built by first digging in the ground about 4 feet, then a wall of logs hewn on the inside is built inside of the excavation to the height of 6 feet, and over this is a tight board roof, $\frac{1}{2}$ pitch. Outside of this wall, at the distance of 3 feet, is another wall of round logs, built up from the surface of the ground to the level of the inner wall. Over this is a good shingle roof, with space between roofs of 2 feet, which is packed solid with damp marsh-moss, which, when dried, is like a sponge—swells and fills everything snug. There are two doors in front, one opening out, and the other one inside, with the space between of 3 feet of dead air. In the roof there is one 6-inch ventilator, which can be closed entirely if needed. I can stow away 100 colonies very easily, and last winter the temperature only varied 6 degrees all winter, with only two colonies, and so far this winter there has been a fall of 2 degrees. We have winters here where the thermometer registers between 40 and 60 degrees below zero, and I think something similar to such a cellar as I have for wintering is a necessity.

If my bees don't all die this winter, I may write again how they come from cellar. I have been using the 8-frame dovetail hive, but I may change to the 10-frame next season, although I am quite satisfied with results so far from the 8-frame hive. **Nimrod, Minn. E. B. GILMORE.**

SEEDS

SPECIAL OFFER

Made to Build New Business.

A trial will make you our permanent customer.

A Vegetable Garden for the cost of Postage (Premium Collection)—Radish, 10 varieties; Lettuce, 9 kinds; Tomatoes, 7 finest; Turnips, 6 splendid; and Onions, 6 best varieties. **SEND TEN CENTS** to cover postage and packing and receive this valuable collection of seeds postpaid. **R. W. Laughlin, Ada, O.** writes: "Have planted Buckbee's Seeds for years, with the best of success. It is a grand business to handle such a good grade of seeds." Write to-day and receive my new Seed and Plant Book; the best published. I guarantee to please. **H. W. BUCKBEE, Rockford Seed Farms, Box 537, ROCKFORD, ILL.**

WHEN ANSWERING THIS ADVERTISEMENT, MENTION THIS JOURNAL.

MUTH'S

HONEY EXTRACTOR
PERFECT
Cold-Blast Smokers,
Square Glass Honey Jars, Etc.

For Circulars, apply to **CHAS. F. MUTH & SON, Cor. Freeman & Central Aves., Cincinnati, O.** Send 10c for Practical Hints to Bee-Keepers.

The Coil Spring Hustler.—We have just received the January issue of The Coil Spring Hustler, and find it full of interesting matter pertaining to fencing. If any of our readers are not receiving that paper, a copy will be mailed them gratuitously by addressing the Page Fence Co., Adrian, Mich.

Honey & Beeswax Market Quotations.

CHICAGO, ILL., Feb. 14.—White clover and basswood comb is sought after in preference to any other, and commands a better price and now sells at 15c. for clover and 13@14c. for basswood. Other white comb honey sells at 11@12c.; dark, 8@9c. amber, 9@10c., and very slow of sale. Extracted is unusually dull, with large amounts on sale. White clover and Linden, 6@7c.; dark and amber grades, 4½@5c.

Beeswax, 28@30c. R. A. B. & Co.

CHICAGO, ILL., Jan. 20.—We are having good inquiry for fancy comb, but all other grades are selling slow. Dark comb will not sell on this market, and we would advise the producer not to ship it here. We are offering it as low as 9@10c., with no buyers. We quote: Fancy, 15c.; No. 1, 14c.; light amber, 12@13c. Extracted, light, 5@6½c.; dark, 4@5c. Beeswax, 28@30c. J. A. L.

PHILADELPHIA, PA., Jan. 3.—Honey has declined in this market during the holidays. Large lots of California honey arriving, and selling at 5c. in 60-lb. cans. We quote: Comb honey, fancy, 16c.; fair to good, 8@14c. Extracted, 4@5½c.; white clover, 10c. Beeswax, 30c. W. A. S.

BUFFALO, N. Y., Jan. 22.—Sales very light and market dull. We quote: Fancy white, 14@15c.; choice, 11@13c.; buckwheat, 7@9c. Extracted, 4@6c. Beeswax, 25@28c. B. & Co.

CINCINNATI, O., Jan. 22.—Demand is slow for comb honey, which brings 12@14c. for best white. The demand is fair for extracted honey at 4@7c., with a scant supply. Beeswax is in good demand at 25@28c. for good to choice yellow. C. F. M. & S.

KANSAS CITY, Mo., Feb. 8.—The demand for comb and extracted is light. We quote: No. 1 white, 1-lbs., 13@14c.; No. 2, 12@13c.; No. 1 amber, 11@12c.; No. 2, 8@10c. Extracted, white, 5½@6c.; amber, 5@5½c. Beeswax, 22@25c. C. C. C. & Co.

List of Honey and Beeswax Dealers.

Most of whom Quote in this Journal.

- Chicago, Ills.
 - R. A. BURNETT & Co., 163 South Water Street.
- New York, N. Y.
 - HILDRETH BROS. & SEIGELKEN, 120 & 122 West Broadway.
 - CHAS. ISRAEL & BROS., 486 Canal St.
- Kansas City, Mo.
 - O. C. CLEMOMS & CO., 423 Walnut St.
- Buffalo, N. Y.
 - BATTERSON & CO., 167 & 169 Scott St.
- Hamilton, Ills.
 - CHAS. DADANT & SON.
- Philadelphia, Pa.
 - WM. A. SELSER, 10 Vine St.
- Cincinnati, Ohio.
 - C. F. MUTH & SON, cor. Freeman & Central avs.

Sweet Clover, Willow-Herb, Basswood

EXTRACTED HONEY

—For Sale.—

We have made arrangements whereby we furnish **Sweet Clover or Willow-Herb** Extracted Honey, in 60-pound tin cans, on board cars in Chicago, at these prices: 1 can, in a case, 8 cents per pound; 2 cans in one case, 7½ cents.

The **Basswood Honey** is all in kegs holding 170 pounds, net. It is a very superior quality, and the prices are: 1 keg, 8½ cents per pound; 2 kegs or more, 8 cents. Cash must accompany each order.

A sample of either kind of honey will be mailed to an intending purchaser, for 12 cents, to cover postage, packing, etc. We guarantee purity, and that what we ship will be equal to sample.

GEORGE W. YORK & CO.,
CHICAGO, ILLS.

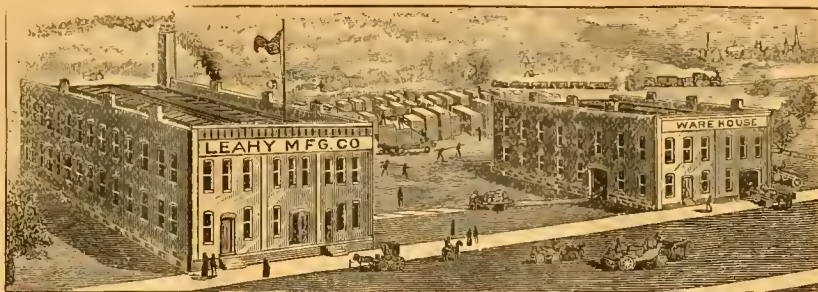

Largest Factory in the West COMPLETE STOCK. Good Supplies and Low Prices. Our Motto.

READ THIS—Mr. Keyes says: The 100 pounds of Extra-Thin Foundation you sent us is superior to anything he ever saw; and I think the same. K. L. TUCKER, Wewahitchka, Fla.
Dear Sirs:—The Sections came duly to hand. Indeed, they are very nice. Yes, sir; they are as good as the best. CHARLES H. THIES, Steelville, Illinois.

Leahy Mfg. Co.:—I have received the bill of goods. I must say they are the choicest lot of Hive-Stuff I have ever received from any place. I admire the smoothness of your work, and your close selection of lumber. Yours very truly, O. K. OLMSTEAD, Orleans, Nebr.

Dear Sirs:—The Sections arrived in due time, and are all O. K. so far as examined. They are simply perfection. I can't see how you can furnish such goods at such low prices. I hope you may live long and do well. Yours respectfully, Z. S. WEAVER, Courtney, Tex.

Gents:—I received the "Higginsville Smoker" all O. K. It's a dandy; please find enclosed stamps for another. Yours truly, OTTO ENOERS, Oswegatche, N. Y.

Gentlemen:—I have bought Supplies from nearly all the large manufacturers by the carload, and I must say yours are as good as the best. Indeed, in many lines they are the best. It is a pleasure to handle them. E. T. FLANAGAN, Belleville, Illinois.

The above unsolicited testimonials are a fair sample of hundreds we receive. Our prices are reasonable and the "Higginsville Goods" are the best.

The "Higginsville" Goods are for sale by the following parties:
Chas. H. Thies, Steelville, Ill. E. T. Flaagan, Belleville, Ill.
Henry L. Miller, Topeka, Kans. E. A. Seeley, Bloomer, Arkansas.
J. W. Rouse & Co., Mexico, Mo. P. J. Thomas, Fredonia, Kans.

And by a number of others.
If you need a Carload of Supplies, or only a Bee-Smoker, write to us. Remember, we are here to serve you, and will, if you give us a chance. **A Beautiful Catalogue Free.**

Address, **LEAHY MANUFACTURING CO., HIGGINSVILLE, MO.**
49A Mention the American Bee Journal.

PLEASANT VALLEY NURSERIES.
Send for Illustrated catalogue of healthy, thrifty trees and plants. Koonce Pear, Sneed Peach and all other leading varieties. **ARTHUR J. COLLINS, Moorestown, N. J.**

36E13t

Please mention the American Bee Journal.

Honey-Clovers & Buckwheat SEED FOR SALE.

We have made arrangements so that we can furnish seed of several of the Clovers and Japanese Buckwheat, by freight or express, at the following prices, cash with order:

	10lb	50lb	100lb
Alsike Clover Seed	\$1.35	\$ 6.25	\$12.00
Sweet Clover Seed	1.25	5.50	10.00
White Clover Seed	2.40	11.35	22.00
Alfalfa Clover Seed	1.20	5.25	10.00
Crimson Clover Seed	1.00	4.00	7.00
Jap. Buckwheat Seed	.45	1.50	2.20

Prices subject to market changes.
The above prices include a good, new two-bushel bag with each order.

We guarantee all Seed first-class in every respect—in fact, THE BEST that can be gotten. Your orders are solicited.

GEORGE W. YORK & CO.,
CHICAGO, ILLS.

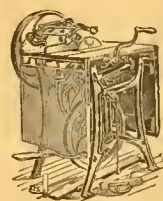

ONE MAN WITH THE UNION COMBINATION SAW

Can do the work of four men using hand tools, in Kipping, Cutting-off, Mitring, Rabbeting, Grooving, Gaining, Dadoing, Edging-up, Jointing Stuff, etc. Full Line of Foot and Hand Power Machinery. Sold on Trial. Catalogue Free.

SENECA FALLS MFG. CO.,
46 Water St., SENECA FALLS, N. Y.
1Aly Mention the American Bee Journal.

DON'T!

Buy Bees or Supplies until you have sent to us for special prices on what you need. The Goods and Prices "are right."

Our '96 Circular now ready.

I. J. STRINGHAM,
105 Park Place. NEW YORK, N. Y.

CLOSING OUT SALE!

We have at this Branch among the Stock purchased of Thos. G. Newman the following stock of Sections—not of our manufacture—which we desire to close out to make room for our

Superior Extra Polished Sections.

In order to close them out quickly we offer them for the next 60 days, or while they last, at these special prices:

White Sections, 4¼x4¼.		Cream Sections, 4¼x4¼.	
3,000 1 15-161,000 for \$1.75	7,000 1 15-161,000 for \$1.25
2,000 for 3.00	2,000 for 2.00
23,500 7-to-ft.5,000 for 7.00	5,000 for 4.50

TRIANGULAR-TOP FRAMES.

We also have a stock of Triangular Top Langstroth Frames at these Special prices:
100 for \$1.00; 300, \$2.70; 500, \$4.00; 1000, \$7.00.

On all freight orders of \$5 or less, at this Branch, please add 25c. for cartage. Catalogue Free.

The A. I. Root Co., 56 5th Ave., Chicago, Ill.

Bottom Prices

**BRING US BIG TRADE.
GOOD GOODS KEEP IT.**

If you want the best supplies that can be made at a little less cost than you can buy for the same goods for elsewhere, write to us for low prices. 1896 Catalogue now ready—ask for it and a free copy of **The American Bee-Keeper** (36 pages).

Address,
**THE W. T. FALCONER MFG. CO.,
JAMESTOWN, N. Y.**
Mention the American Bee Journal.

EVERGREENS!

Send Ornamental trees, Nursery grown. 250 Choice Evergreens, 10 varieties \$2. 400 Ornamental trees, 6 varieties, \$2: 6 other \$5 and \$10 bargains, 100 Scotch Pine, 2 ft. high, \$8; 100 to 12 inches \$10. All other varieties and sizes cheap. Local Agents Wanted. Send for Illustrated Catalogue. **FREE.** Evergreen Specialist.

D. HILL, . DUNDEE, ILLINOIS.
7A5t Please mention the Bee Journal.

HEADQUARTERS for ROOTS' GOODS

Can supply you with all the Fixtures used in an Apiary. Best Goods at Lowest Prices. Catalogue free. 5% discount until March 1st.
JNO. NEBEL & SON, High Hill, Mo.
Mention the American Bee Journal. 4Atf

The Rural Kansan

Is an Agricultural Journal for the busy farmer. It embraces Bee-Keeping and every department of industry connected with the farm. 30 cts. a year, monthly. Sample Free. A Full Line of **Higginsville Bee-Supplies** on hand. CATALOGUE FREE.
HENRY L. MILLER,
355 Shawnee Ave., TOPEKA, KAN.
1A13t *Mention the American Bee Journal.*

FOR SALE.

ALSIKE, CRIMSON, ITALIAN, ALFALFA, or WHITE CLOVER SEED.
4A8t **WM. CRAIG, Luce, Mich.**
Mention the American Bee Journal.

Queen-Clipping Device.

I want the address of all who clip Queens and have even the least trouble either in catching or holding them while they are being clipped. I have invented a Device by which it is impossible to injure a Queen either in catching or clipping, unless it is done purposely. With it they are caught and clipped any way desired almost instantly. One does not have to touch the Queen with his hands, whatever. Price, postpaid, 50 cts. Send for Free Circular. **C. MONETTE,**
6Atf **CHATFIELD, Fillmore Co., MINN.**
Mention the American Bee Journal.

BEEES QUEENS

Smokers, Sections, Comb Foundation, And all Apian Supplies cheap. Send for FREE catalogue. **E. T. FLANAGAN, Bellefonte, Ill.**
6A26t Please mention the Bee Journal.

Fruit Plants

Where to buy them at wholesale price. Send postal for descriptive and wholesale Catalogue of all of the leading varieties of the **Strawberries, Raspberries, Blackberries, Currants, Gooseberries, Grapes and Potatoes.**
EZRA G. SMITH, Manchester, Ont. Co., N. Y.
8Atf Please mention the Bee Journal.

19th Year Dadant's Foundation 19th Year

Is still in the lead, for we use all the latest improvements, including the NEW PROCESS, and still make the best goods. Remember that we do not use any acid to purify our beeswax, and that is why our Foundation preserves the smell of the honey and is more acceptable to the bees, than any other. It is kept for sale by

G. K. Hubbard, Fort Wayne, Ind.
L. Hanssen, Davenport, Iowa.
C. Theilmann, Theilmanton, Minn.
E. C. Eaglesfield, Berlin, Wis.
E. T. Abbott, St. Joseph, Mo.
J. M. Jenkins, Wetumpka, Alabama
John Rey, East Saginaw, Mich.
Vickery Bros., Evansville, Ind.

The Jennie Atchley Company, Beeville, Texas.
C. F. Muth & Son, Cincinnati, Ohio
E. Kretchmer, Red Oak, Iowa.
Jos. Nysewander, Des Moines, Iowa.
G. B. Lewis Co., Watertown, Wis.
James Reynolds Elevator Co., Poughkeepsie, N. Y.
Page & Lyon, New London, Wis.
T. H. Strickler, Solomon City, Kansas.

and many other Dealers. All agree in saying that no goods are better than ours.

Those of our customers who formerly bought through Thos. G. Newman can get our Foundation in **Chicago, Ill.**, by addressing us at **56 Fifth Avenue.** We keep no other goods there.

We make a specialty of **Veils and Veil Stuffs** of best quality, cotton and silk.

Langstroth on the Honey-Bee, Revised.

Bee-Keepers' Supplies, Smokers, Sections, Tin Pails, etc.
Samples of Foundation and Tulle FREE with Circular. Instructions to beginners with Circular. **BEE SWAX WANTED.** Send us your address.

CHAS. DADANT & SON,
Mention the American Bee Journal. **HAMILTON, Hancock Co., ILL.**

CASH PAID FOR BEE SWAX

For all the good, pure yellow **BEE SWAX** delivered to our office till further notice, we will pay 26 cents per pound, cash; or 30 cents for whatever part is exchanged for the Bee Journal, Honey, Books or Seed, that we offer. If you want **cash promptly** for wax, send it on at once. Dark or impure wax not taken at any price. Address plainly.

George W. York & Co., 56 Fifth Ave., Chicago, Ill.

SECTIONS, BEE-HIVES, SHIPPING-CASES

We make a Specialty of these Goods, and defy Competition in **QUALITY, WORKMANSHIP AND PRICES.**

Write for Free Illustrated Catalogue and Price-List.

G. B. LEWIS COMPANY, Watertown, Wis.

Be sure to mention the American Bee Journal when you write.

* ROOT'S COMB FOUNDATION! *

New Product.

We are pleased to announce that, having secured control of the new Weed process of manufacturing foundation for the U. S., we are prepared to furnish **Foundation by the New Process**, for 1896. Samples will be mailed free on application, and will speak for themselves.

New Process.

OUR SANDED and POLISHED SECTIONS, well, they will speak for themselves, also.

A Big Success

Our 1896 Catalog

will be ready for distribution now in a few days. Send in your name at once for catalog, samples of the new foundation, and those superb sections, and while you are about it ask for late copy of **Gleanings in Bee-Culture.**

THE A. I. ROOT CO., MEDINA, OHIO.

56 5th Ave., Chicago, Ill.

Syracuse, N. Y.

1024 Mississippi St., St. Paul, Minn.

AMERICAN BEE JOURNAL

DEVOTED EXCLUSIVELY TO THE INTERESTS OF HONEY PRODUCERS

ESTABLISHED 1861
THE OLDEST BEE-PAPER IN AMERICA

Published Weekly, at \$1.00 per annum.

Sample Copy sent on Application.

36th Year.

CHICAGO, ILL., FEB. 27, 1896.

No. 9.



The "California Bee-Keepers' Exchange."

BY J. H. MARTIN.

[The following is a report of the special meeting of the California Bee-Keepers' Association, and the organizing of the CALIFORNIA BEE-KEEPERS' EXCHANGE.—EDITORS.]

It will be remembered that at the annual meeting of the State Association, held in Los Angeles, Nov. 16 and 17, 1895, a committee was appointed with full powers to formulate plans for an organization that would unite the bee-keep-

was to ratify the work of the committee, and adopt by-laws for the government of the Exchange.

In the absence of Prof. Cook, the meeting was called to order by Mr. C. H. Clayton, the Vice-President. After receiving the report of the committee, and attending to other business that properly belonged to the State Association, the meeting then resolved itself into a committee of the whole, with Hon. J. M. Hambach as chairman. Mr. R. Touchton, of Santa Paula, had formulated a set of by-laws, and they were read, section by section, by the Secretary, and each section was attentively considered, and many of them were discussed at length. Throughout the discussions the best of temper was maintained, and there were no stings with venom that words so often inflict.

Mr. Touchton had drawn the by-laws with such care that there were but few amendments made, and at the conclusion of the discussion, which run well into the second day, they were adopted.

This committee of the whole then adjourned, and those who had become members of the "California Bee-Keepers' Exchange," by the payment of \$1.00, and signing the articles, met for the purpose of electing permanent Directors, and the



Apiary of Mr. A. W. Swan, Centralia, Kans.—See page 137.

ing interests under one head, for the more systematic marketing of our products, and purchase of supplies.

This committee met in Los Angeles, Jan. 6, and as a result articles of organization were drawn up under the co-operation law of 1895 (as it is known in this State). The articles were filed in State and county, and a special meeting of the State Association and all bee-keepers was called for Feb. 3. There was a large gathering of representative bee-keepers at the Chamber of Commerce on that date, and their work

following 11 gentlemen were elected for the counties following the names:

- J. La Rue for Riverside; G. S. Stubblefield, San Diego; R. Touchton, Ventura; C. H. Clayton, Los Angeles; R. B. Herroo, San Bernardino; J. C. McCubbin, Central California; E. A. Honey, Orange; Geo. W. Brodbeck, F. S. Pond, W. T. Richardson and J. H. Martin, at large.

The meeting of members of the Exchange then adjourned, and the Directors appointed a meeting for the next day in

which to elect officers and a general manager. At this meeting, which assembled in the Chamber of Commerce Feb. 5, at 9:30 a.m., W. T. Richardson, of Fremontville, was elected President; Geo. W. Brodbeck, Vice-President; The Los Angeles National Bank, Treasurer; and H. H. Youngken was unanimously elected Secretary and General Manager, and the California Bee-Keepers' Exchange was declared permanently organized.

The committee who formulated the Exchange, and bee-keepers generally, felt the necessity of getting a thorough business man for General Manager, and in selecting Mr. Youngken they went outside of the ranks of bee-keepers. Mr. Youngken comes highly recommended by the bee-keepers of Ventura county. He has been a bookkeeper from youth up, has a practical knowledge of banking, and a wide acquaintance with monied interests. He is the successful manager of a Building and Loan Association, and has successfully built up other organizations. Mr. Youngken thinks that if the honey interests of California are handled in a co-operative and businesslike manner, there are great possibilities before it for the mutual benefit of all concerned.

Bee-keepers seem to be alive to the benefits to be derived from a thorough organization, and before it was three days' old, the Exchange had enrolled upward of 70 members, among them such honey-producers as W. T. Richardson, with his 60 odd tons; M. H. Mendelson, with his scores of tons; Mr. Touchton, a large producer; and others too numerous to mention, who produce honey by the carload.

At this writing, meetings are being held in the various counties, and the ball is rolling. It cannot be expected that great things can be accomplished immediately, but by sticking everlastingly at it, great good will result.

It is the intention of the Exchange to get supplies for all of its members, at the lowest wholesale price. This feature alone would be of sufficient importance to cause every California bee-keeper to belong to the organization. Readers of the American Bee Journal may expect to see more in relation to this movement in the near future. J. H. MARTIN, Sec.

Bloomington, Calif.



Some Subjects Reviewed and Commented Upon

BY DR. C. C. MILLER.

CALIFORNIA BEE-KEEPERS' EXCHANGE.—Whether the competition of California honey in the Northern markets is a good thing for Northern bee-keepers may be questioned, but on page 81, Prof. Cook has put the need of Californians so plainly and forcibly that one cannot help wishing them full success. On the whole, if the plans of the Californians succeed, how can it fail to be a benefit even to Northern producers? For is it not better to have the competition of honey that is sold at living prices than to have that of honey that is sold for almost nothing? Possibly the success of those Southern men may be an example for others, and the market throughout may be improved. At any rate, they seem to be in dead earnest, and that counts for a good deal. Success to them.

OUT VS. IN WINTERING.—In reply to Bee-Master, (page 84) I would say that his first guess is not far from right, that is, for me out-door wintering is many times more unsafe than in-door. If, however, there may be a plan of out-door wintering by which I could be fairly successful, I should very much like to practice it, if for nothing else because in that way the bees are always surrounded with pure air. So I try occasionally wintering in the open on some plan a little different from anything I have previously tried. But it would be foolish to try any large number until I first succeed with a smaller number. Should the one colony that is now on its summer stand come out with flying colors in the spring, the experiment will probably be repeated another winter on a larger scale.

SELLING HONEY ON COMMISSION.—On page 87, Mr. Abbott takes very radical ground—a little too radical, it seems to me. His idea is all right, that it's a risky thing to send honey to men you know nothing about. That's true, and the fact that commission men have things so largely in their own hands makes it all the more important to know about the man you deal with. But if you know your man, and are sure that he's straight and honest, I don't see why there's anything wrong in the principle of selling on commission. Why is the principle any different from hiring a man to peddle honey for you? In either case it is doing business on your capital, and so is the man doing business on your capital who uses your saw to saw your stove-wood.

"Most commission men are honest and honorable,"

says Mr. Abbott. Then find out which they are, and ship to them, if you've no better way to dispose of your honey.

There's just a bit of moonshine in the idea that there's no risk about selling for cash. If a man is dishonest it may be safer to send on commission than to sell for cash. For if you sell to him for cash and he fails to pay on receipt of the honey, you have no recourse at law if the man is not financially responsible; whereas, if you ship to him on commission, and he pockets the proceeds, you can proceed against him as a criminal. Don't condemn the whole commission business just because the miuority of men in it are bad.

T SUPERS AND PATTERN-SLATS.—C. C. Parsons, (page 87) takes such a reasonable view of things that I am sure he'll not take it amiss if I say that I think he would prefer T supers if they were made right and used right. His supers are made after the old way, having the bee-space at the bottom. I'm pretty sure he'd like the improved way better—the space at the top. He'd also find it an improvement to have sections narrow enough to admit a follower. I don't know how he takes sections out of T supers, but I know he can do it very easily if he does it the right way.

NUMBERING HIVES.—Several have lately given their plans for numbering, and some seem to think it an advantage to have the numbers permanently attached to the hives. Probably that's all right with their management, but it wouldn't work in my apiary. The same stand must always have the same number, for it wouldn't do to have a hundred numbers in confusion so a number could not readily be found. Then when the hive is changed to another stand its number must be changed.

LOSING QUEENS BY DOUBLING.—Isn't the experience of S. M. Robertson, on page 110, quite exceptional? If I am not mistaken it is a common practice to double up swarms just as he did, leaving the bees themselves to settle their little differences as to queens, and generally all ends well. If the swarms doubled were all second-swarms, having young queens, it is possible that the queens were lost on the wedding-trip. Even then, the loss of queens was unusual. Marengo, Ill.



A Queen-Clipping Implement Described.

BY C. MONETTE.

Although this might be called the age of machinery, when a person claims and advertises that he has invented a machine that will catch and clip a queen any way desired, and that it is impossible to injure her with said machine, either in catching or clipping, the bee-keeping public is apt to be somewhat skeptical about it, and on this account I have asked to be allowed to explain what the machine or device is.

I keep all laying queens clipped, and consider it a great advantage to have them so, but it was always a good deal of trouble for me to catch and clip queens by hand without danger of injuring them. A laying queen is a very delicate thing to handle without injury, and in spite of myself I would always become nervous and excited when trying to catch and clip a queen by hand; and the more valuable the queen, the more nervous I would be. I have injured a good many. Sometimes I would do it in catching them, and sometimes, after I had caught them all right, I would clip off a leg or two with a wing. It was on this account that I made the clipping device. At first I had no thought of getting it patented or offering it for sale, but I was so much pleased with it myself that I gave, or sent, one to a number of my bee-keeping friends, and in every case they were so pleased, and spoke so highly of it, that I made arrangements to offer it to all who might need it. Although it is said that nothing is perfect, I believe this is so nearly so, that it can never be improved in any way, for it is utterly impossible with this device for the operator to injure a queen, either in catching or clipping, unless he does so purposely. One does not have to touch the queen with his hands whatever, and on this account the scent of a queen is not changed, and she is never balled when she is returned to the bees, as is sometimes the case when a queen is caught and clipped by hand.

The main part of the device consists of a spiral wire cone, made out of small, polished steel wire; it is large at one end and small at the other. In catching, the large end of the cone is placed over the queen, then a tin bottom that is fastened to the wire cone is brought into position under the large end of the cone; the queen is then securely fastened in this cone, and, if one desires, the cone and queen can then be put

or laid down anywhere, the same as if she was in any kind of a cage. When the large end of the cone is placed over a queen, one does not have to wait for her to crawl up. She can, with this wire cone, be picked right up off a comb out of a cluster, or any other place where she can be seen and got at.

The tin bottom to the cone is made and hung in such a way that it is impossible to injure the queen when bringing it in its position to close the cone.

The cone itself being made spiral, and of steel wire, is a very delicate spring up and down, so that in placing it over a queen, if it is purposely brought down quite hard upon her, it will not injure her; but the cone is large enough at the large end so that it can be easily placed over a queen without touching her, and the wires are so close together that when a queen is inside she can never get her head between them. The cone is worked, and the queen caught, with one hand, and this can be done with a heavy glove on.

After the queen is in the cone, another part of the device, which, for the want of a better name, we will call a "follower," is inserted between the bottom wire of the cone and the tin bottom. This follower is padded with soft cloth, and with it she is gently urged up towards the small end of the cone. By holding the cone with the small end up, a queen will almost always, of her own accord, go up into the small end. If she does not, by touching her gently with this follower she will, and then when she is confined in the small end in a space about her own length, the follower is stopped, and with a small hook any one or all four of her wings are pulled out between the wires, and with a knife or scissors they can be cut off any way desired. After her wings are pulled out between the wires, she cannot get them back again, neither can she throw her legs up in the way. The wires of the cone do not press against her in the least—she is merely kept from moving backward or forward much, and, as I have said, the follower, as well as the front of the cone, is padded with soft cloth, so she will not injure herself in trying to back or go ahead.

After her wing or wings are clipped, the small end of the cone is removed, and she is allowed to walk out.

Now, from reading this, one might think that to catch and clip a queen with this device is a long and complicated operation; in reality it is very simple. With this device, in the presence of a number of witnesses, I caught and clipped a queen in 20 seconds. But it sometimes happens that in catching a queen one or more workers are caught at the same time. This causes a slight delay, for then it is better to remove the small end of the cone and let the workers out that way, or the hook can be run between the wires and with it they can be pulled out between them; the wires being steel they will spring apart enough for this.

There is nothing about the device that will get out of order, or wear out, except the cloth, which can be easily replaced by any one. One of them will last many years, even if it was used every day.



Some Suggestions on Several Subjects.

BY J. C. WALLENMEYER.

CATNIP HONEY.—W. J. M., of Cedarville, Mo., asks on page 53, what quality of honey is obtained from catnip. Dr. Miller says he does not know that anybody ever had a pure sample of catnip honey. During 1894, my supply of comb honey ran short, and I bought several hundred pounds of catnip honey from C. F. Muth & Son. I had several grocers waiting for comb honey, and immediately delivered to each of them, several cases from the depot without examining it. In this way it was all sold four hours after arrival here.

I began to receive complaints in a few days, which kept up, until I had all the "beautiful" catnip honey returned to me, as being strong, dark, of sickening odor, and other bad qualities. Everyone knows how strong buckwheat honey is—well, it is not half as bad as catnip. I used to think catnip a very fine honey-plant, seeing my bees work on it all the time, but since getting hold of such a bad mess, I condemn it.

LIQUEFYING HONEY.—R. C. Aiken, on page 55, speaks of the consumer doing his own liquefying of extracted honey, having printed instructions with each package. My experience is that consumers do not want candied honey, will not even try to liquefy it, and any amount of talk is wasted on otherwise intelligent people. Although I offered \$100 to a grocer here if my honey contained a particle of any adulteration whatever, he stubbornly persisted in saying I fed my bees sugar. As long as I supplied him with honey that did not candy, he sold lots of it to his customers. So I made a round

of all grocers every once in a while, and replaced the candied jars of honey. I used No. 50 glass jars, and found they candy more readily than a jar with a cork pushed in tight and tin-foil pressed around it. I can now keep all my honey from candying by pouring hot beeswax on top of it, and corking tight while hot, and it will candy only on very rare exceptions. This is best done by using Muth's square jars, as they have a small "mouth" and do not require much wax.

BEEES STARVING WITH PLENTY OF HONEY.—On page 54, E. B. T. asks Dr. Miller the cause of a large colony of bees dying with plenty of honey in the hive. The Doctor suggests queenlessness, and gradual reduction in numbers until a cold-snap finished them. If the good Doctor looks closer, he will see that E. B. T. says "the colony was a large one, and they were 'all dead'." A more probable cause than that given by the Doctor would be, that they starved on account of not being able to reach the honey without breaking cluster. We hear so much of bees starving with plenty of honey. If a Hill's device were laid across the frames, I claim all bees will live as long as there is a pound of honey in the hive. I have learned this by experience. Only the other day I discovered a large colony starved with at least 30 pounds of honey in the hive, while a little nucleus by its side, with only a pound or so of honey, came through the cold-snap all right.

The nucleus had a Hill's device over the frames, covered with enameled cloth, and a super put on full of clover leaves, which retained all the warmth. The large colony had nothing but the enameled cloth, which was glued down to the top-bars, thus keeping the bees from passing over the frames to the much-coveted stores. All our packing will amount to nothing if we do not allow a space for the bees to pass over the frames.

Evansville, Ind.



Large vs. Small Hives Once More.

BY W. J. DAVIS, 1ST.

On page 34, Dr. Miller says: "Chas. Dadant certainly makes a strong showing in favor of plenty of room in the brood-chamber," etc.

I have read Mr. Dadant's articles on the size of hives with much interest, and while I give him credit for giving his views correctly, just as he views the matter, and in accordance with his experience, yet I regard his views as very misleading to a majority of American bee-keepers.

I am not unmindful of the fact that he can prove his faith in large hives by results, for, if I am not mistaken, he has made a financial success of bee-keeping, and may be one of those "bloated bond-holders"—(a class, by the way, which seem to be increasing of late.) But I opine that his success is due more to location than size of hive, and also to the production of extracted instead of comb honey. I infer, also, from his enormous yields, as reported on page 44—viz., 400 pounds from a single colony in one year. I notice, also, that most of the reports of larger yields reported on page 44 are from the State of Illinois. I very much question whether a single colony in the state of Pennsylvania ever in all her history produced such an amount in a single season. If such a thing has ever occurred and was reported, it has escaped my notice, for I have every volume of the American Bee Journal from No. 1 to the present time.

Though not as old as Mr. Dadant, I have kept bees longer in this country, and kept them in the same locality, and I have tried hives of different sizes, from one holding 24 Langstroth frames, to 12, 10 and 8, the latter of which I now use with the brood-frames shortened five inches in length from the standard Langstroth frames. The favoring condition we lack in western Pennsylvania—the lack of nectar for the bees to gather, the almost total absence of basswood, and the high price of land in the valley of the Brokenstraw, leave but little land for grazing purposes, hence a limited amount of white clover, and no sweet clover to speak of. We would not secure any comb honey one year in five with larger hives.

But notwithstanding all this, we have the advantage of no year being an entire failure, and we have no such thing as foul brood, or bee-paralysis. If I had lived at Hamilton, Ill., I have no doubt I should have used larger hives, and if Mr. Dadant had happened on coming to this country, to have settled in western Pennsylvania he would now be advocating small hives, and his \$200 worth of big hives would be cast aside as mine are.

There is the whole thing in a nutshell. Bees are bees, no matter in what latitude or various surroundings they are kept. But all localities are not alike, neither do all localities

require the same size of hive or the same management, to obtain best results.

Can anyone suppose for a moment that the same kind of hive and same management would apply, whether the bees could work one month in 12, or 4 months in 12, or 8, 10 or 12 months in 12? I think not. Youngsville, Pa.



Comparison of Section Comb Foundation.

BY HON. R. L. TAYLOR,

Superintendent of the Michigan Experiment Apiary.

In making an experiment with comb foundation, I pursued a course differing in some respects from that pursued in former experiments. In the first place all the samples made by others to be used in the experiment were procured in such a way that none of the manufacturers could know that it was to be used by me except the single one which I will explain here is a foundation made by a machine got up by the A. I. Root Co. to make foundation in imitation of that produced by the Given press though the machine itself is a roller mill. Then instead of using a single sample of Given foundation of my own manufacture for comparison as in former experiments I used two—one was freshly made from wax selected on account of its bright yellow color and its hard, brittle character, from a lot of wax which was mostly purchased, and perhaps from five to ten per cent. of the selection was made from cappings. On account of the character of this wax the proper sheeting of it for use in the Given press was decidedly more difficult than is ordinarily the case, as the sheets were so prone to crack in cooling and when they did not crack they were considerably inclined to roll or crinkle. The other was made last year and was from the lot used in making the test a year ago. In the table the former is simply denominated Given while the latter is called the Old Given.

In addition to the three mentioned I procured a sample from each of the three following manufacturers, viz.: C. Dadant & Son, The A. I. Root Co., and M. H. Hunt.

The method of comparison pursued was the same as was employed in last year's trial. Sections nine to the foot were used in cases holding 36 such sections without separators, the theory, I may repeat, being that the kind of foundation best adapted to such use would be worked first and drawn out farthest by the bees, and so be found to contain the most honey. To make the test a fair one, each case was filled with one of the sorts of foundation selected for the trial and the other half with another sort, the two sorts being made to alternate throughout.

As will be seen, the Given foundation made from the hard yellow wax is the kind selected with which to compare each of the other sorts. The table following, in addition to the dis-

TABLE SHOWING RESULTS OF COMPARISON.

Designation.	No. of Pieces 3¼ in. square to the lb.	No. of ft. to the lb.	Weight of ½ case of honey lbs. oz.	Per ct. of excess.	Per ct. of deficit.
{ Dadant's ...	128	12.49	11 11		6.5
{ Given ...	108	10.54	12 8		
{ Root's.....	112	10.92	11 9	8	
{ Given.....	112	10.92	10 11		
{ Root-Given	96	9.39	12 6	3.6	
{ Given.....	104	10.14	11 15		
{ Hunt's.....	120	11.70	10 8	15	
{ Given.....	112	10.92	9 2		
{ Old Given..	100	9.75	12	23	
{ Given.....	96	9.39	9 12		

tinguishing designation, shows in each case the number of pieces 3¼ inches square to the pound, the number of feet to the pound, and the weight of 18 sections. It is hardly necessary to say that the record of each parcel of Given foundation is placed next in position to the record of that sort with which it was compared, thus that treated in the second line of the table was compared with that in the first line, that in the fourth line with that in the third line, and so on.

A word of caution may be necessary lest on a cursory examination of the table some should be misled into fixing the standing of the several foundations considered from the column giving the weight of the honey produced. For instance, in the second line of the table the Given foundation is shown to carry 12½ pounds of honey—the highest amount shown—but that this fact should not be used as an argument in favor of that foundation appears when it is considered that other kinds figure in cases generally less well filled as well as with different antagonists, so to speak.

The columns containing the per cent. of excess and deficit as found from a comparison of each with the "common term"

furnishes a far better criterion. By the use of this it appears that the old Given, though manufactured at least a year before, easily leads all the others in quality. But what is the most remarkable is the great difference shown in the quality of the two samples of Given foundation, and that this is in favor of that sample which had been much the longer made as well as somewhat lighter in weight. No one was ever heard to affirm that age improves the quality of foundation, and with good reason, so the explanation of the discrepancy must be sought elsewhere. Undoubtedly it is to be found in the character of the wax from which the two samples of foundation were made. The hard, brittle character of the wax from which the freshly-made Given foundation came guaranteed its inferiority. If this is true, and it will hardly be questioned, the quality of the wax cuts as great a figure in the quality of the foundation produced as does the method of its manufacture, perhaps more. This suggests important questions for future experiments such as the following: Whence does wax derive the undesirable consistency referred to? Does it come from the character of the honey from which it is produced or from excessive boiling, or from some other occult cause? If the injury is caused by boiling, what amount of heat is effectual in doing the injury? Again, is there any way in which the quality of such wax can be "annealed" by a proper attention to temperature at the time of sheeting it? Is such claim well founded?

Nothing farther need be added in explanation of the table and scarcely more could be said to enforce its lessons.—Review. Lapeer, Mich.

CONVENTION PROCEEDINGS

Report of the Illinois State Convention Held at Chicago, Jan. 9 and 10, 1896.

REPORTED BY ERNEST R. ROOT.

(Continued from page 117.)

Second Day—Forenoon Session.

NUMBER OF COLONIES TO BEGIN WITH.

Question.—"How many colonies should a beginner commence with, in order to attain success?"

This matter was put to a vote, and a majority seemed to think that two was about right.

Mr. Baldrige—The proper answer to this question would depend upon whether the beginner was to have some one to show him. He might then start with four or five. Ordinarily, one will be enough.

COST OF PRODUCING A POUND OF HONEY.

Question.—"Prof. Cook states that the cost of producing honey is, for extracted, 5 to 8 cents; comb, 5 to 7 cents. What is included in these cost figures?"

President—Prof. Cook would have to answer this. He probably figured on foundation, hives, labor, winter losses, and interest on the money.

DEVELOPING THE HOME HONEY-MARKET.

Question.—"How can bee-keepers best develop and hold the home market for honey?"

President—I will tell you what I did. I put up some honey in Muth jars, and took them to the nearest market. That year there was some of the vilest honey stored that I ever had. I took that and put it on the market. I spoiled the trade. Some of the consumers insisted that the honey was adulterated, and others that it was not good.

Mr. York—But what did you do to hold the trade?

President—I didn't hold it!

Mr. Schrier—I sell all my honey at home. It advertises itself so well that I frequently get mail orders for a second lot. If, however, I send honey away, it is always the best. Around home I can sell almost anything, because people all know me; but the honey must be clean. I find I can sell dark as well as light honey.

Question.—"What is your usual crop?"

Mr. Schrier—From 90 to 100 pounds per colony.

Mr. York—Could Mr. Schrier sell more if he bought it?

Mr. Schrier—I bought some of a Chicago honey dealer and sold it. I have no trouble in selling what I buy, so long as I stand back of it and guarantee it.

President—As a rule, which is better—to sell comb honey or extracted?

Mr. Schrier—Comb honey.

President—Let's see the hands.

A vote showed by a considerable majority that comb honey was the easier-selling article. A few thought they could sell extracted easier.

President—A poor article of extracted does not sell as well as a poor article of comb.

CAUSE OF BEE-PARALYSIS.

Question.—“Is bee-paralysis caused by a diseased queen, or by the food consumed by the bees?”

President—I have had but very little experience. At all events, I do not regard it as of much consequence. While it does not trouble me, I know it is a serious matter with some in the South.

Mr. Root—No one seems to know the cause of bee-paralysis. Some think it is a disease inherited from the queen, and therefore that the removal of the queen will cure it. Others take the view that the bees get something from the blossoms that causes the trouble.

Mr. Wheeler—One year, somewhere about the first of June, my bees began to take some sort of disease, and died. I got that year no honey to speak of; and the bees in all my apiaries were affected. I made up my mind that they were getting something from the field that caused the trouble. They did not look like robber-bees, nor did they seem to be bloated, as in the case of those affected by bee-paralysis.

Mr. Root—Some seasons, in early summer, I have seen the same thing in our yard. A close scrutiny in the grass would show bees crawling up the spears of grass and attempting to fly, they drop down, only to repeat the operation. In fact, sometimes I have seen the whole yard in the apiary pretty thickly dotted with the bees in the grass. We could not account for it at the time, but supposed that the bees were getting something from the fields that was making the trouble. Reports have come in showing that this is a real disease, and that others have been bothered by it certain seasons.

Mr. Baldrige—That same malady appeared among my bees one season.

CURING FOUL BROOD.

Question.—“Will foul brood cure itself in a good honey-year?”

Mr. Thompson—Yes.

Mr. Root—Yes.

President—Did the disease re-appear after it went away?

Mr. Thompson—No.

Mr. Walker—I had this year as good a honey-flow as I ever had, yet foul brood made serious havoc among my bees. However, a good honey-flow does seem to have quite an effect in diminishing the virulence of the disease; but it does not cure it with me. The past season I felt that I could not treat the colonies as recommended by Mr. Root—that is, put them on foundation in clean hives—so I cut out the diseased spots in the combs, and burned them. I followed this up for three or four weeks. Some colonies seemed to be cured, and in others the trouble re-appeared. It is hard to lay down absolute rules to apply in all cases.

President—The Germans recommend formic acid for curing foul brood; and as this is supposed to be present in honey, it is possible that a honey-flow helps to cure the disease, owing to the presence of this same acid.

Mr. Baldrige—I think the point is right here: During a honey-flow the bees do not use diseased honey, but they use good, pure, clean honey.

SHIPPING AND SELLING HONEY ON COMMISSION.

Question.—“When comb honey sells on South Water Street (Chicago) for 14 cents, what will it net the producer?”

Mr. York—The honey will net the producer just about 10 cents.

President—We have a blackboard here, and suppose we put down some of the items of expense. Now, first, what ought we to put down for cost of freight?

Mr. Walker—Well, that depends on how far the honey is to go; but somewhere about 40 cents per 100 pounds.

President—Then we will put down 4/10 of a cent as freight. Now, what is the usual commission?

Mr. Walker—Some charge 5 and some 10 per cent.

Mr. Draper—I had rather pay 10 per cent. commission, and get better prices.

Mr. Wheeler—I get just as good prices, and pay only 5 per cent. commission.

After a good deal of discussion, in which all the members participated, the following table appeared on the blackboard:

Selling price of honey per pound.....	.14
Freight.....	.004
Commission at 10 per cent.....	.014
Cartage.....	.002
Loss in leakage.....	.007
Shipping-cases.....	.010

Total expense.....037 .037

Net cash to the purchaser.....103

Mr. York—There! didn't I tell you?—just about 10 cents per pound.

MOVING AN APIARY A SHORT DISTANCE.

Question.—“I have a small apiary that I desire to have removed ten rods, more or less, to another location. How can I do this without loss of bees?”

Mr. Wheeler—Put them into a cellar. Keep them there over winter, and then move them in the spring to where you want them.

Mr. Green—But the question seems to imply that the bees are to be moved immediately. I would say, first, remove the bees all at once, and then remove, so far as possible, all traces of previous landmarks. In the new location, set the hives in the same relative position.

Mr. Baldrige—I would move them when they were flying the thickest—say about the middle of the day. The air will then be filled with bees, and they will then find their location. They might not all go back to the same hives, but that would not matter much, for they would equalize. If in any case they do not equalize properly, change the location of a weak and a strong colony—putting the weak one on the stand occupied by the strong, and the strong on the stand of the weak.

Mr. Green—Common bees will find their location much quicker than Italians.

Mr. Wheeler—Give each colony a ride on a wheelbarrow for about a full hour. Jolt them about a good deal, and then when they are set on their new location, they will stay where they are put.

Mr. Baldrige—I have not time for that.

Mr. Wheeler—This plan that I have just spoken of is Mr. Doolittle's idea. He aims to excite the bees so that, when they are given their freedom on their new location, they will mark that location.

Mr. Draper—When I move my bees to Spanish-needle I fasten up all the hives during the day, and move at night. At that time the bees do not bother the horses. For a day or two after they are set on their new location the bees are cross, I tell you.

BEST WIDTH OF ONE-POUND SECTIONS.

Question.—“What width of one-pound section, $4\frac{1}{4} \times 4\frac{1}{4}$, will be most profitable to use?”

Mr. Green—I think $1\frac{3}{4}$ is a nice width, holding $\frac{3}{4}$ pound, when separators are used, and sells for less than a pound. It is more likely to be of uniform weight than the heavier section.

President—The Canadians, you know, prefer a narrower section—that is, $1\frac{1}{8}$, or $\frac{7}{8}$ to the foot.

Mr. Wheeler—I use and prefer $1\frac{1}{8}$.

President—Why?

Mr. Wheeler—For the same reason as Mr. Green; and, moreover, these narrow sections are more quickly capped over, and I find I get with them fewer unfinished sections.

Mr. Draper—I prefer a 2-pound section, 2 inches wide. It looks bigger.

President—At first I wanted my sections to weigh a full pound; but now I find the dealer wants something holding a little less than a pound—just near enough a pound to make the consumer think he is buying a full pound when he is not. That is cheating. I should want something that would weigh at least a full pound, or at least so much less that the consumer will not be fooled.

Mr. Green—Grocers around us prefer $\frac{3}{4}$ -pound weights. I sell by the section generally, although a few buy by weight. When they buy by the section they know just how much each is costing them, and what their margin of profit is; but they do not always know, when it is bought by the pound.

Mr. Wheeler—I sell by the section.

Mr. Baldrige—I think the majority prefer to sell by the section.

President—Let's have an expression from the convention,

and see what width of section, $4\frac{1}{4} \times 4\frac{1}{4}$, seems to have the preference.

A show of hands revealed the fact that 7 to the foot seemed to have a little bit the lead in the preference; 1% came next; after that, 1%.

NUMBER OF BROOD-FRAMES DURING THE HARVEST.

Question.—“How many combs, Langstroth size, should be left in the brood-chamber during the harvest for comb honey?”

In answer to this, the President called for an expression. The majority favored the 10-frame size—that is, the majority who voted at all. Mr. Green and Mr. Wheeler thought one section of the Heddou hive sufficient, which would be equivalent to 5 Langstroth combs.

Mr. Walker—Does not Mr. Green have swarming from those shallow cases?

Mr. Green—Yes, sir; but I give them another story, or half section, if they need room.

Question.—“How many reduce the brood-room of an old colony during the harvest?”

An expression from the convention showed that there were but very few who did so, while the majority did not.

Question.—“How many hive their swarms on less than the full brood-room?”

A call for an expression showed that the majority did so.

ADVERTISING FOR COMMISSION-MEN.

Question.—“Should the bee-papers accept advertisements of commission-men, soliciting shipments of honey?”

Mr. Green—There is no more reason why they shouldn't, than that the publisher of any trade-journal should not solicit advertisements from people connected with their trade.

Mr. Mandelbaum—The firm I represent has bought largely on commission, but in the future we propose to buy outright. In answer to the question, I think bee-papers should accept advertisements from commission-houses. It is the bee-keepers' own fault if he gets caught by unreliable parties.

Mr. Newman—I should answer the question in the affirmative, providing the bee-papers have investigated the standing of the parties who desire to advertise. The mistake is very often made by the bee-keepers themselves, in not investigating the responsibility of houses that may or may not advertise. I know several parties who have shipped to irresponsible firms; as a result, they have suffered by it. Bee-keepers should go to the banks and ascertain the responsibility of the commission firms that they are not acquainted with. If such firms are not quoted, they should not be trusted.

Mr. Mandelbaum—If any bee-keepers have accounts with commission-houses from which they cannot collect or get satisfactory returns, the firm I represent will be willing to aid them if in their power.

Mr. Walker—Referring to Mr. Newman's point, I would say that a high-quoted firm is not necessarily safe. I want to know whether they are honest.

Mr. Newman—But when you go to the banks you can find out their credit. It is not their capital, but their credit, that should be taken into consideration. Give me the standing of a man who has honor and credit, and I will not be afraid to trust him.

Adjourned to meet at 1:30 a.m.

[Concluded next week.]

A New Binder for holding a year's numbers of the American Bee Journal, we propose to mail, postpaid, to every subscriber who sends us 15 cents. It is called “The Wood Binder,” is patented, and is an entirely new and very simple arrangement. Full printed directions accompany each Binder. Every reader should get it, and preserve the copies of the Bee Journal as fast as they are received. They are invaluable for reference, and at the low price of the Binder you can afford to get it yearly.

If any one desires two of the Binders—one for 1895 and one for 1896—send 25 cents, and they will be mailed to you.

The Alsike Clover Leaflet consists of 2 pages, with illustrations, showing the value of Alsike clover, and telling how to grow it. This Leaflet is just the thing to hand to every farmer in your neighborhood. Send to the Bee Journal office for a quantity of them, and see that they are distributed where they will do the most good. Prices, postpaid, are as follows: 50 for 25 cents; 100 for 40 cents; or 200 for 70 cents.

See “Bee-Keeper's Guide” offer on page 143.

Questions AND Answers

CONDUCTED BY

DR. C. C. MILLER, MARENGO, ILL.

[Questions may be mailed to the Bee Journal, or to Dr. Miller direct.]

Gnawings of the Cappings.

My bees are on the summer stands, and are all right except one colony. I was looking at them last week, and found that one colony had fallen comb at the entrance; I looked in and found that the queen was dead, and the bees were eating off the comb. I found plenty of honey and pollen. What is the matter?
H. M. P.

Keysburg, Ky.

ANSWER.—In winter there is an accumulation of the gnawings of the cappings that the bees let fall. This, however, you would find at all the hives, and is a little like ground-pepper in appearance. If bits of comb are found a fourth of an inch in size, then the mice have probably been gnawing the combs. It's a good plan in winter to have the entrances closed with wire-cloth having three meshes to the inch. This will stop the mice, but allow bees to pass. It would be hard to say what caused the death of the queen.

Some Sweet Clover Questions.

1. Can sweet clover be sown in the spring, so as to get a crop of hay the same year?

2. Would sweet clover be likely to do well in the vicinity of Boston, on rather light land?

3. Is there any other clover that could be sown in the spring so as to give a crop of hay and also to be useful as a honey-plant?

4. If sweet clover was plowed under in the fall, after it had gone to seed, would it come up in the spring?

F. C. J.

ANSWERS.—1. I have had it grow two or three feet high the first year, and it would have made a fine crop of hay, possibly two crops. But it doesn't blossom till the second year.

2. I couldn't be certain about it, but I should expect it to do well. Mrs. Harrison reports that down in Florida it will not prosper, but that's the only report of the kind I ever heard.

3. Possibly crimson clover might fill the bill, although most say it should be sowed in the fall. It is expected to grow only the one season, whether sowed fall or spring.

4. I've had a fine stand by having such ground plowed in the spring, and I see no reason why it would not do just as well if plowed in the fall.

Producing Extracted Honey—Fumigating Combs—Building a Honey-House.

1. In working for extracted honey, would you advise the use of half-depth frames in supers, or full-size Hoffman frames, the same as are used in the brood-chamber?

2. In fumigating your frames of combs, how much sulphur should be used to a given number of frames? Is there danger if a little too much sulphur is used?

3. I want to build a honey-house. Would you kindly give me a few dimensions and instructions necessary for the work-pose? I want it large enough to accommodate the work necessary for 15 or 20 colonies.

I am almost a beginner, and would appreciate as minute instructions as your time will allow in the matter of the honey-house, or anything in the line of extracted-honey advice.

J. M. H.

Mt. Vernon, Ind.

ANSWERS.—1. I don't know which to advise. The half-depth frames are better. In giving additional super room it is better to have shallow frames, so as not to be obliged to give so much room at a time, and indeed it is better not to have so

much surplus-room the first time. The shallow frames are more convenient to uncap. I think it is said the queen is less likely to go up and lay in shallow frames. But it is expensive and inconvenient to keep a set of frames especially for extracting. If you use the same kind of frames as you use in the brood-chamber, you can change from one to the other, so a smaller number of frames will be necessary, and the frames can more easily be all kept in use all the time, and that's better for the combs. But another thing is, that some think that the honey is affected by the old combs in which brood has been reared, and if that be true, then the combs used for extracting should never have brood in them. On the whole, the matter stands in this way: It's better to have shallow frames for extracting, but if you don't want to stand the expense you can get along by using frames the same as in the brood-chamber.

2. It isn't so much a matter of the number of frames as it is of the amount of room in which they are placed. If a thousand combs require a given amount of sulphur, it will take just as much sulphur for a single comb if that single comb is put in the same room. If there are big worms to be killed in your combs, you can hardly use enough sulphur, and if they have just been hatched from the egg it will need very little to kill them. At a rough guess, perhaps a pound of sulphur may be used for a room 10 feet square.

In smoking section honey, there is danger of making the nice, white comb green if an overdose of sulphur is used, but you would probably do no harm by any amount for brood-combs.

3. For 15 or 20 colonies you'll want a room not much smaller than you would need for five times as many. Of course, more room is needed to store the increased amount of honey. Moreover, there's no certainty that you will always be of your present mind as to keeping so few colonies, and it is more comfortable to have plenty of room, and a large room costs less in proportion than a small one. You could get along with a room 7x7, but I wouldn't want it less than 10x-10, and larger would be still better. Figure to have plenty of light, and that will at the same time give you plenty of chance for ventilation. Have it convenient to the apiary, and the lay of the land will have something to say about that. Be sure to keep in mind that you may want to drive a wagon close up to load and unload. So general is the question that it is not likely all points would be covered, no matter how long the answer, and any special questions you may think of will be cheerfully answered so far as ability goes.

Sawdust Paeking in the Spring.

Is it advisable to place sawdust on the top of the brood-frames for the protecting of brood during the spring? Last spring I took the frames out of the half stories, and placed them on the hives with the oil-cloth over the brood-frames, and filled the half-stories about half full of dry sawdust. If this is advisable, how long should they remain on?

Peasleeville, N. Y.

W. H. E.

ANSWER.—I should think it might be of some benefit, although I wouldn't like to be very positive about it. Why not try some hives with, and some without such covering, and compare results? I'd take off the sawdust about the time to put on sections, or a little before, according to convenience.

Wants to Produce Only Beeswax.

What do you consider the best plan to secure the most wax? Bees do well here. Besides a fair yield during the regular seasons, they usually gather some honey and keep up brood-rearing the entire winter, but there is very little sale for honey at any price, while wax sells readily at 50 cents per pound. I have no extractor. What do you think of feeding back honey in comb? and how should it be done?

About how many pounds of honey should make a pound of wax, when fed to the bees? About how many pounds of wax should a strong colony make per annum if worked for wax alone.

I suppose in working for wax I should increase as fast as practicable. If so, what is the best plan to pursue?

Monte Morelas, Mexico.

W. H. C.

ANSWER.—I don't know enough to attempt any answer to some of your questions, and practically know very little about working for wax alone. Whether it can be made profitable or not can only be decided by trial. In the States it is hardly worth the trial, but in Australia it has been thought of. With poor sale for honey, and wax at 50 cents, it's certainly worth the trial.

I think I should try somewhat after this fashion: Have a hive of such size that the queen would have a fair chance to lay and still leave a little room, but very little. As soon as the hive is filled in spring, or a little sooner, add a second story below with starters. I think you'll find the bees build down comb quite rapidly. Cut away the combs as fast as built down, every two or three days if you can stand the work. These combs will have very little honey in them, and will give wax of the finest quality. There may be danger that the combs in the upper story will become filled with honey to such an extent that brood enough will not be reared, so it may be well to keep an eye on this, and either cut out or extract the outside combs occasionally.

Probably the best way to feed back the honey would be to dilute it a half and feed in the open air, providing, of course, other bees don't get it. Otherwise the Miller feeder, or the crock-and-plate feeder would work.

Now, mind you, I'm only guessing at what is best to do.

How to Insure Sections of Honey Shipping Safely.

I wish we could get the collective wisdom of our sages on this matter. But, then, to the confusion of the tyro, their opinions differ so on this, as on most other matters. For instance, B. Taylor, in his Toronto essay, says he fills his section with "moderately heavy foundation," and boastfully remarks that he has sent 200-pound lots 700 miles with three railway transfers without a single section breaking down. Had the "moderately-heavy foundation" anything to do with insuring this safety? Also, had the *viscosity of the honey* (as a result of 60 days storage in an iron-house with free air circulation) anything to do with it? Does he use spiral springs for his crates, or corrugated paper, perhaps? I wish he'd be less tantalizing, and a trifle more explicit. These big fellows just *hint* at things—in a rather supercilious sort of way—telling us youngsters just enough to make us long to know more. I wish you would "squeeze" B. T. a bit on this point.

I said just now that the opinions of our leading lights differ so vexatiously on many minor—aye, and on many major points, too. Now, at this same Toronto convention we have Allen Pringle telling us most emphatically that it is a mistake to use full sheets of foundation, or anything beyond the merest starters, in sections. I wonder if A. P.'s sections travel, as a rule, as safely as Mr. Taylor's. And here let me pass in my humble thank-offering to both these gentlemen for their highly interesting and very valuable essays. These "old boys" take a deal of trouble to give us youngsters, in their essays, the benefit of their long years of experience, and deserve every individual bee-keeper's special thanks.

You would appear to have hit upon a good "dodge" of strengthening sections of honey for traveling by using a top and bottom starter. I mean to try it. What thickness of foundation do you recommend for these starters?

South Africa.

S. D.

ANSWER.—I have generally used the same thickness of foundation in both top and bottom starters. I don't like extra-thin foundation for either place, but if I used it for top starters I certainly would have something heavier for the bottom. Indeed, when I use thin (not extra-thin) foundation at the top, I like for the bottom something a little heavier, or perhaps more properly something with higher sidewalls, so it will not be so likely to topple over.

Getting Bees Out of a Chimney—Separators.

1. What is the best plan to get bees out of a chimney, either just located, or of one or two years' standing?

2. Will bees work better in sections with no separators? I always use full sheets of Van Densen thin foundation.

Last season was a good one with us. I took 4,932 pounds from 50 colonies, spring count. They swarmed but little.

UTAH.

ANSWERS.—1. Sometimes the boarding can be cut away, then by the use of smoke the combs can be cut out and all removed. If no cutting is allowed, then perhaps the easiest way to drive out the bees is by means of carbolic acid. Bees cannot stand the fumes of this, and as soon as it gets too strong they will make for the open air.

2. Possibly there may be a shade of difference, at least in theory, but it isn't enough so that you can detect it in actual practice.

OLDEST BEE PAPER IN AMERICA ESTABLISHED IN 1861

THE AMERICAN BEE JOURNAL

PUBLISHED WEEKLY BY
GEORGE W. YORK & COMPANY,

Editors and Proprietors,
56 Fifth Avenue, CHICAGO, ILL.

REGULAR CONTRIBUTORS:

G. M. Doolittle, of New York. Prof. A. J. Cook, of California.
Dr. C. C. Miller, of Illinois. Dr. J. P. H. Brown, of Georgia.
J. H. Martin, of California. Rev. E. T. Abbott, of Missouri.
Chas. Dadant & Son, of Illinois.

\$1.00 a Year—Sample Copy Sent Free.

[Entered at the Post-Office at Chicago as Second-Class Mail-Matter.]

Vol. XXXVI. CHICAGO, ILL., FEB. 27, 1896. No. 9.



The California Bee-Keepers' Exchange is now started. Mr. Martin tells about it in his interesting article on page 129. Those plucky Californians will be eagerly watched from now on, for if their new venture proves successful we do not see what is to hinder its imitation in nearly every part of the country.

We believe the leading bee-keepers of the Golden State are on the right track. We hope so, for we would like to see the new Bee-Keepers' Exchange develop into a grand institution for the advancement of the financial interests of all its members, by way of disposing of their crops of honey more satisfactorily, and also in the purchase of the necessary apiarian supplies. If bee-culture is to be successfully prosecuted as an industry, the cost of production must be lessened, and then at least a fair price be secured for honey.

We believe the Bee-Keepers' Exchange is a move in the right direction, and we are anxious to see it succeed. The Bee Journal is ready to do whatever it can to aid California bee-keepers, and no doubt it will have the privilege of keeping the members of the Exchange informed regarding the movements of their new organization from time to time.

This will be a good time for every California bee-keeper to subscribe for the American Bee Journal, if not now receiving it regularly. We don't know where they will find more genuine bee-information for the money—52 weekly numbers for only \$1.00. 'Tis so ridiculously cheap that no real bee-keeper can afford to be without it, no matter where he lives.

For a short time we will be able to furnish all the back numbers from Jan. 1, 1896, to new subscribers.

Selling Another's Honey as Your Own.—After reading our several editorials on selling another's honey, one of the Bee Journal's many friends writes us as follows:

MR. EDITOR:—Will you pardon me, if I ask you to turn back once more and carefully examine the question asked by "Missouri," about "one bee-keeper selling another bee-keepers' honey," page 675? The question is so involved that a careless reading might give one the wrong impression, and a first impression is sometimes hard to correct when it is wrong. And just that sort of thing has happened, I think, with you, Mr. Editor, and also with some of those who replied. The question is, "Would it be right?" and the majority of those who reply answer more or less directly, "No." You say, "Yes." I do not believe you have a different standard of right from that majority, and I feel sure that you will answer with them when you answer the question that is asked, and not the one that you mistakenly supposed to be asked.

Just look and see what is asked. "Would it be right?" Would what be right? From what you repeatedly say you take it to

mean buying from another to sell again. No one questions that—not one of those who replied. That isn't the question at all. The question is "Would it be right to sell honey under such circumstances?" Getting the twists out of the question, it is, "Would it be right to sell honey" bought from another "provided I should put my name on it and make my customers believe it is from my apiary?" Instead of answering that question you go to talking about the simple matter of buying to sell again, which has nearly as much to do with the question as if you should argue that I should sell my crop of honey instead of having it all used up on my own table. If you had looked at the real question, I don't believe you would have been so "Hasty" in your remarks on page 24.

HONEY-PRODUCER.

Well, Mr. Honey-Producer, we have taken your advice "to turn back once more and carefully examine the question" asked and answered on page 675 of the Bee Journal for 1895, and we must candidly admit that we did not consider seriously enough the part of the question which reads, "and make my customers believe it is from my own apiary"—really meaning that it was produced by the seller. Why, of course, that would be wrong. And we don't believe those of the repliers who even intimated that it would be right, were any more careful than we were in reading the question. But we are just as certain they are as much opposed to any and every wrongful act as are we.

After saying the above, it looks very clear to us that we owe, and hereby tender, Mr. Hasty an apology for writing as we did concerning him on page 24. While doing this, we would say, however, that we think Mr. H. went a little too far when intimating that certain good people were "rascals."

Although it ought to be unnecessary to say it, we will repeat our statement on page 57, viz.: *It is not right to deceive under any circumstances!*

The Bee-Supply Manufacturers—the largest—were shown in last Gleanings, by way of portraits of all the principal members of the several firms. Mr. G. B. Lewis and Mr. C. E. Parks (now deceased) represent The G. B. Lewis Co.; Mr. W. T. Falconer and Mr. D. E. Merrill, of The W. T. Falconer Mfg. Co.; and Mr. R. B. Leahy and Mr. J. E. Gladish, of the Leahy Mfg. Co. The six pictures make an excellent showing of the manufacturers of supplies used by bee-keepers. If to the foregoing are added The A. I. Root Co., then the list would be complete. Of course there are many who manufacture on a small scale, and are excellent firms, but we presume Gleanings aimed to "show off" the "big guns" in the supply manufacturing line. It was a decided success, and we congratulate our esteemed contemporary upon its enterprise and general "git-up-and-gitness."

"The Honey-Bee: A Manual of Instruction in Apiculture." By Frank Benton, M. S.—This book, already mentioned, is issued as Bulletin No. 1, New Series, U. S. Department of Agriculture, Division of Entomology. It is 6x9 inches, paper cover, 118 pages, 11 of them being blank, the obverse of the beautiful full-page engravings. As already mentioned, the many illustrations are exceedingly fine, there being 88 in all, including the 12 full-page plates. Of course, some of the engravings are the old ones, with which all readers of bee-books are familiar, but most of them are new, more than 30 being original. On page 33 are three cuts that seem to be put in to fill up, no reference being made to them in the reading matter. They represent the manner of handling a frame so as not to have the comb break out—a manner of manipulation that it is hardly worth while to give in these days of wired frames.

The book is divided into 12 chapters, treating of Classification, Kinds of Bees, Manipulation, Establishing an Apiary, Hives and Implements, Pasturage, Spring Manipulation, Securing Surplus, Queen-Rearing, Increase, Wintering, Diseases and Enemies.

The author sets the amount of honey necessary to produce a pound of wax at a higher figure than many do in these latter days, saying that 18 to 20 pounds are necessary to produce a pound of white comb.

The use of the quilt is taught as one of the regular things, although in the most popular hives of the present day no quilts are used. Possibly the extra warmth obtained through quilts would more than repay their extra trouble.

Here is an extract with regard to the use of the veil that some would do well to consider: "To dispense entirely with the bee-veil is a more important consideration, especially to the professional bee-master, than is at first apparent to the inexperienced. Its use injures the eyesight seriously, especially where one is obliged to strain his eyes for hours to see eggs, larvae, etc., in the cells; to hunt out queens and queen-cells, and adjust frames. Besides this, the hindrance to rapid work which the veil causes, as well as the great discomfort of wearing it for hours during hot weather, are considerations worth weighing."

The statement, "If the combs are so old as to be nearly black and to show cell-walls much thickened, they are very objectionable," would be more readily endorsed in England than in this country.

The author has evidently given much attention to the matter

of honey-plants, and he strongly recommends to bee-keepers in Middle and Northern regions a trial of Japan and sulla clovers. A list of honey-plants is given for the North above latitude 40 degrees, for the South below 35 degrees, and one for the Middle section between 35 degrees and 40 degrees. The relative importance of the plants is shown by four different kinds of type. The most important, given in full capitals, are, for the North—raspberry, white and Alsike clovers, linden and buckwheat; for the Middle section—tulip tree, sourwood, alfalfa and sweet clover; for the South—white sage, horsemint, sourwood, saw and cabbage palmetto, black mangrove and alfalfa.

For full sheets in sections, "thin" foundation is advised on page 80, and "extra thin" on page 55.

The author says he has seen 350 queen-cells constructed at one time by a single colony in Tunis. Henry Alley thinks only ten or a dozen good cells can be reared at one time in a colony; but Mr. Benton thinks a large proportion are good in colonies that have several times as many. There are good reasons for believing that the latter is correct in his views. With the right condition, he says "there need be no hesitancy in permitting the construction of hundreds of queen-cells in one colony, if such numbers are needed."

Clipping queens is spoken of in such a way as might mislead the novice to think a queen should be clipped annually.

A good point is given on page 98 which is perhaps new. After removing the old colony to a new location after swarming, introduce a young queen within a day or two. This will secure the destruction of the queen-cells, whereas if the colony were left till the first queen hatched out, it might have enough bees added to its numbers as to warrant swarming.

Some would take issue with Mr. Benton when he advises, at the time of dividing, that the queenless part be left on the old stand.

The plan of dequeening during the honey-flow is not commended, but the author recommends replacing the old queen early in the season with a queen of the same season's rearing.

He has no sympathy with the "pollen theory," and is on the safe side in recommending 40 pounds of winter stores in Northern regions.

On the whole, this book, with its large, clear type, and its plain putting of correct teachings, is a real credit to the author and the Department of Agriculture.

Dr. Peiro's Hints.—In reply to letters of enquiry received from subscribers of the American Bee Journal, we wish to state that though Dr. Peiro cannot continue his "Medical Hints," as in the past, he may be expected to touch upon the most recent medical topics as they occur, from time to time. Further, that he will be glad to reply to all enquiries, giving medical advice desired by our readers, the only consideration being the enclosure of enough stamp for return postage. Address, as before—Dr. Peiro, 100 State St., Chicago, Ill.

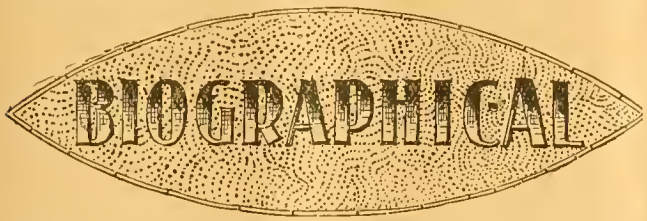

Mr. A. W. Swan and Apiary.

Mr. A. W. Swan was born in Story County, Iowa, in 1858. He spent his early boyhood days on the farm, receiving a common school education. With his parents he moved to western Kansas in 1873, there enduring the disadvantages of pioneer life. While only a boy he developed a remarkable ability for broom-making, and though serving no apprenticeship, by his own ingenuity and persistent effort he has won success.

In 1880 he moved to Nemaha county, Kans., and was married to Miss Orcellia Jackson shortly after. Together they built up a pleasant home in Centralia, and when the future looked bright, and all seemed fair to lead to success, the happy home was blighted, and the wife was called to that better Home beyond, leaving the husband, and daughter of 13 years, to toil a little longer, and experience that great lesson—"learning to labor and to wait."

A few years ago Mr. Swan became interested in bee-culture; believing that he could make a success of this work, he purchased 30 colonies of bees, and by obtaining aid from reading the bee-papers and thoroughly studying the actions of the "busy little bee," he has built up his apiary until it is the best in Nemaha county.

He finds no difficulty in disposing of his honey, and has always received a good price for it.

Mr. Swan is an ever-ready talker on the subject of bees, and is delighted with the work. E. L. S.

The foregoing biographical sketch was kindly written by Miss Emma L. Swan, sister of Mr. S. In the following, Mr. Swan, himself, tells us about some of his bee-keeping experience:

In the spring of 1893 I bought 30 colonies of bees in extra large hives. Not knowing very much about bees I left them in the large hives, and have 16 of them in my apiary yet, as will be seen in the engraving. It is a deep hive, the frames being 11x15 inches, outside measure, or 10x14 inches of comb space in each frame. There being 10 of these frames in each hive, it makes 1,400 square inches of brood-comb. With close observation I found 900 square inches occupied by the queen in the height of brood-rearing, leaving a balance of 500 square inches for the bees to store honey in, consequently the bees are very slow to commence work in the sections—until the best honey-flow is over.

Bees winter well in these large hives on the summer stands, without any protection, having their winter stores directly over the cluster, which is very essential to successful wintering on the summer stands. The only way such hives are profitable is by getting large swarms from them, and then living them in 8-frame hives with full sheets of foundation in the brood-frames, and in three days put on one a super of sections filled with extra-thin foundation. By so doing I get from 24 to 48 pounds of choice comb honey in one-pound sections from a prime swarm. This is the result of actual practice, not theory.

Finding that bees paid me better in 8-frame hives, I transferred the bees and comb from 14 of these large hives in May and June, 1895, and in August I took off 560 pounds of choice comb honey in one-pound sections, nicely finished. At the same time I took 300 pounds from the 16 large hives, in 400 sections finished up in all shapes, leaving me 150 sections that were not fit for market. So, with the experience I have, I shall adopt the 8-frame hive, or in other words, the Hoffman frame, no matter what kind of a hive so it is not too large—not over nine frames for the brood-chamber.

I winter all my bees on the summer stands, with very little loss, if they have plenty of good stores, plenty of young bees, and are properly packed. I believe in late brood-rearing, so that the hives will be full of young bees at the beginning of winter—at least this is my plan, and my bees are wintering nicely. On the first day of January, this year, it was a nice, warm day, and the bees had a cleansing flight, and were carrying out very few dead bees.

The majority of the honey in this part of country is from sweet clover, which grows in all waste places, fence-corners, lanes, streets, and alleys for miles around my place, and it is alive with bees while it is in bloom. This "weed," as the farmers call it, is our best honey-plant—without it I would not keep bees in this locality, as there is nothing else for them to work on after fruit-bloom in the spring until heart's-ease and buckwheat bloom in August.

As I do not make a specialty of bee-keeping, the bees do not get the attention they should have, but with the care they get they pay me very well. A. W. SWAN.



Hive-Numbers and Record-Books.

Now, it seems to me just about as necessary to number or name colonies of bees as it is to name people. If I had to stop and describe each colony of bees by some peculiarity of hive or location every time I wanted to refer to it, instead of saying No. 12 or No. 9, I believe I should get discouraged, and just give up. It seems to me a bee-keeper's time is too valuable to be wasted in that way.

But if there were no other reason for it, I should want them numbered in order that a record might be kept. You know when children dispute with regard to their ages they are always referred to the family Bible. Well, when we want to be sure of our queens' ages we refer to the record-book.

Suppose I go to a colony and find that it is queenless. Is the record-book now of any use to me? Of course it is. I can take the book and look and see if there is any colony I can go to for queen-cells, tell how ripe they are, tell whether it's a colony I want to breed from, whether it's gentle or cross, whether they are good workers or not; in fact, tell all about them.

With a record-book you can sit down and map out your day's work, and know just what you're going to do beforehand. In fact, I don't see how any one can get along without one. If we should forget ours when we go to the out-apiaries, we should have to go back after it, and it would be a difficult thing to keep a record-book without having your colonies numbered.—EMMA WILSON, in *Gleanings*.

Emptying Honey-Cans.

No doubt, most bee-keepers have at times had experience in emptying honey from five-gallon cans into smaller receptacles, and know that to tilt the can up each time a jar is filled, and again lower it, is quite some work. The honey-gates made of tin and leather, such as the Roots sent out some years ago, were quite handy, but just about the time one has a supply of these on hand, he will have to have some new cases, and the chances are that these will have a different-sized screw cap, and his gates will not fit them. Now, let me tell you how to manage it without a gate:

Stand the can on a box, chair or table, far enough from the edge so that when you lay the can over on its side it will project four or five inches over the edge of the table, unscrew the cap, take a smooth piece of section that is not warped, (any other small piece of board will do), place it over the mouth of the can and lay it (the can) down on its side while you hold the piece of section firmly in its place. Now you want an assistant to hold the jars or cans, or at least someone to hand them to you; hold the jar under, and slide the section-piece up until the honey flows out as fast as desired. Usually it will not flow too fast, if opened entirely. When the jar is full, slide the piece down and cut off the flow while you take away the full jar and put an empty one under, and so on. If the honey is not too thick, it will take you less time to fill a number of jars than it has taken me to write this. Try it.—S. E. MILLER, in *Progressive Bee-Keeper*.

Longevity of Bees.

C. Davenport says in *Gleanings*: "One summer I had a strong second swarm issue from a large box-hive. I do not remember the date, but it was just before basswood blossomed. The queen of this swarm was lost, on her mating trip, or in some other way, for I am certain that they did not have a laying queen at any time during the summer. I thought I would let them do without one, to see what they would do. They were hived on combs that contained considerable honey, so they did not have much room to store below; but they filled up what room there was, and then, instead of working much in the sections, they took the world easy.

"In the fall I thought I would unite what few of them were left, with some other colony; but on coming to examine them I was surprised at the amount of bees there was left. There seemed to be nearly as many as when I hived them; so in order to experiment further they were put in the cellar, where the rest were. They came out in good shape in the spring. A queen was given to them; and although they dwindled away very fast, they pulled through all right.

"Now, in this case the workers lived at least 10 or 11 months, not only a few, but thousands of them. But they would not do so every year. If the same thing had been tried the past summer I do not think there would have been a live bee left after they had been in the cellar a month."

Using Unfinished Sections.

Says B. Taylor in *Gleanings*: "Now I will try to answer pointedly Dr. Peete's questions. You, see, Doctor, the sections which I use for extracting and using again were got from the supers I must necessarily use in saving the honey-crop, and not only without extra work or loss, but with an actual saving in both, for we avoided the swarming trouble, and did not curtail, but *increased*, the general surplus crop, and even the crop of *finished comb honey*, so there was no waste of work here. After the honey is extracted from the sections they are returned to the T supers, and on a warm afternoon are all set out at once in the open air; and by dark every section will be cleaned of every particle of honey by the bees, ready for the comb-leveler. Two hours' work will accomplish all the work of having thousands of combs cleaned; but the leveler must be used on every comb. Surely that will be a big

task. No; it is but little more work than to *properly* fill sections with full sheets of foundation, especially where two pieces of foundation are used in each section; and the comb-honey producer who does not use two pieces has not yet learned his trade; so there is but little if any extra work or loss in leveling or using the drawn combs again."

Honey in Butter.

When the butter is salted, add a little sugar or honey, about half a tea-cup full to five or six pounds, and see what a nice flavor it gives to the butter.—MRS. HALLENBECK, in *Progressive Bee-Keeper*.

Apicultural Nomenclature.

I am glad to see the disposition on the part of bee-keepers to use shorter terms in designating various articles and operations in the apiary. Dr. Miller, in the *American Bee Journal*, in place of the circumlocution of saying "carrying bees into the cellar" would "cellar them." He does not say what term he would use when he would take them out; but reasoning from analogy he would "uncellar" them. Perhaps this would be carrying matters a little too far.

So far the new nomenclature includes the word "cellar" as a verb—to put bees into the cellar; "queen and unqueen" for "supplying a colony with a queen and taking one away;" "floor" instead of "bottom-board;" "queen-bar" instead of "queen-excluding honey-board." I am not sure that the substitutes for the last two terms are sufficiently descriptive to be readily understood. I shall be glad to receive a list of short words that are perfectly plain as to their meaning, in place of the longer circumlocutions we are now using. By the way, in York State I heard the bee-keepers using the term "boxing a colony," instead of the longer term, "putting sections on a colony." They almost invariably use the term "boxes" instead of "sections." In the West I have heard the expression "supering" for putting on sections or extracting-supers.—*Gleanings* editorial.

Importance of Longevity in Bees.

Referring to the article of Geo. J. VandeVord in this journal, page 617 (1895), Editor Hutchison says in the *Review*: "Prolificness in queens is almost universally desired. In summing up the desirable qualities of a race of bees, or of a queen, prolificness is almost always put at the head of the list. Occasionally a bee-keeper has had the insight to notice and the courage to say that there are other points of more importance than prolificness: in fact, some have asserted that prolificness is at the expense of other desirable qualities. Every bee-keeper knows that it is not always the most populous colony that stores the most surplus. There is certainly a reason for this, and it is possible that Mr. VandeVord has struck it."

Bees for Australia.

The present mania seems to be for imported American stock. Though considering them superior to queens reared in Italy, yet those from the Eastern States have one defect which would not occur in those bred from climates similar to our own. In the Northeastern States of America for several months in the winter the bees and queen hibernate and cease from all active exercise. This proves of great advantage to the apiarist there, as the bees thereby have a large stock of unused vitality to start work when the spring opens. This lying dormant in winter time will become hereditary and inbred amongst the race, as those which possess this quality have a better chance of surviving the severe winters. We know that all animals have the power of gradually adapting themselves to the changed conditions of their environment, provided the change is not too sudden. Now these qualities which prove advantageous to the American apiarist has the opposite effect here, as over the greater part of Australia the bees can fly almost any day through the winter. Then we want queens that will lay through the winter as well as summer, for if the workers keep flying through the winter, and there are no young bees hatching out to replace them as they die off, the stock will become too weak by spring-time to be of much value as honey-gatherers for the ensuing summer. I believe to this want of hatching brood may be attributed a great deal of what is called spring dwindling.—A. C. CUSACK, in *Australian Bee-Bulletin*.

The Names and Addresses of all your bee-friends, who are not now taking the *Bee Journal*, are wanted at this office. Send them in, please, when sample copies will be mailed to them. Then you can secure their subscriptions, and earn some of the premiums we have offered. The next few months will be just the time to easily get new subscribers. Try it earnestly, at least.

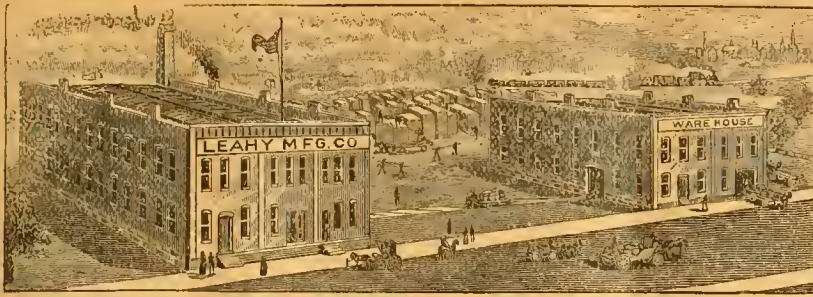

Largest Factory in the West COMPLETE STOCK. Good Supplies and Low Prices Our Motto.

READ THIS—Mr. Keyes says: The 100 pounds of Extra-Thin Foundation you sent us' is superior to anything he ever saw; and I think the same. R. L. TUCKER, Wewahitchka, Fla.
 Dear Sirs:—The Sections came duly to hand. Indeed, they are very nice. Yes, sir; they are as good as the best. CHARLES H. THIES, Steelville, Illinois.
 Leahy Mfg. Co.:—I have received the bill of goods. I must say they are the choicest lot of Hive-Stuff I have ever received from any place. I admire the smoothness of your work, and your close selection of lumber. Yours very truly, O. K. OLMSTEAD, Orleans, Nebr.
 Dear Sirs:—The Sections arrived in due time, and are all O. K. so far as examined. They are simply perfection. I can't see how you can furnish such goods at such low prices. I hope you may live long and do well. Yours respectfully, Z. S. WEAVER, Courtney, Tex.
 Gents:—I received the "Higginsville Smoker" all O. K. It's a dandy; please find enclosed stamps for another. Yours truly, OTTO ENDERS, Oswegathe, N. Y.
 Gentlemen:—I have bought Supplies from nearly all the large manufacturers by the carload, and I must say yours are as good as the best. Indeed, in many lines they are the best. It is a pleasure to handle them. E. T. FLANAGAN, Belleville, Illinois.
 The above unsolicited testimonials are a fair sample of hundreds we receive. Our prices are reasonable and the "Higginsville Goods" are the best.
The "Higginsville" Goods are for sale by the following parties:
 Chas. H. Thies, Steelville, Ill. E. T. Flanagan, Belleville, Ill.
 Henry L. Miller, Topoka, Kans. E. A. Seelye, Bloomer, Arkansas.
 J. W. Rouse & Co., Mexico, Mo. P. J. Thomas, Fredonia, Kans.
 And by a number of others.
 If you need a Carload of Supplies, or only a Bee-Smoker, write to us. Remember, we are here to serve you, and will, if you give us a chance. **A Beautiful Catalogue Free.**
 Address, **LEAHY MANUFACTURING CO., HIGGINSVILLE, MO.**
 49A *Mention the American Bee Journal.*

General Items.

Bees Wintering Finely.

I have 10 colonies of bees, and they are in fine condition for wintering. We had a fine honey crop here last year, in the latter part of the season, though too wet in the spring for much honey. W. W. BUCK.
 New Concord, Ky., Jun. 30.

Electric Humbugs.

In regard to electric batteries and appliances—subjects upon which my opinion is frequently asked—I unhesitatingly say that ninety-nine (I may as well add the other unit) are unmitigated humbugs. The idea that they exercise other than a moral effect is preposterous in the extreme. All "belts," soles, jackets, bands, are simply devices to catch the dollars of gullible people. Nor are "machines"—"electropoise," "motor via," and all the rest of these high-sounding and misleading appliances—other than sheer rubbish. The fact is, the proper application of electricity puzzles physicians whose every-day business is to investigate its merits; and if such is the case, how can a person unaccustomed to its nature and uses hope to profitably use it, even if he were given a practical instrument, instead of the worthless affairs for which large prices are charged? DR. PEIRO.
 100 State St., Chicago, Ill.

Hives—Moving Eggs—Transferring.

Dr. Miller's answer to size of hives (on page 745, 1895), 18 3/4 x 14 7/8 x 9 1/2 inches for a 10-frame hive, does not agree with mine—18 3/8 x 14 1/4 x 10 inches (or 9 1/2 inches below the top of the brood-frames), inside measure. I can't account for that extra 3/8 inch, unless the Doctor uses a dummy with 10 frames, but how will a 14 3/8 inch super or combined crate fit his hive? Ten inches deep makes room for a bee-space above the brood-frames.

I would say for the benefit of J. A. S., of Tracy City, Tenn., that I make my hives two story double-walled, and painted three coats at a cost of 87 cents per hive, empty, including tin rabbits (material surfaced at both sides at \$20 per 1,000).

I think D. D. M., of Tidoute, Pa., on page 761 (1895) had a case of bees moving eggs, and from some other hive, too. I had a case somewhat similar, except the swarming. I used the young queens as soon as hatched for requeening, except the very last one from a colony that swarmed Aug. 14, and she was lost on her wedding-flight. She was all right two or three days after she was hatched. I did not look at that colony again until the young queen should have been laying, but I found no queen or eggs; then I did not look again for a week or ten days, and I found no queen or eggs, but queen-cells with larvae in them, also larvae in drone-cells, but no larvae or eggs in worker-cells; no eggs in either queen or drone-cells at this time. Sept. 16 or 17, I cut the cells when they were in the state of nymph (they appeared to be all right), and introduced a queen caged on a frame of brood, from a nucleus, which was accepted all right.

B. F. Onderdonk (see page 786, 1895), I think, will find bees swarmed just as quick if the queens are clipped, but they will not abscond unless the queen can go with them. His was rather a hard experience, but I don't think he will have rheumatism very soon. The fruit-bloom, tulip and basswood were all killed here by the late frost, and it was too dry for clover and golden-rod. Nearly all my swarms were cast in August, and my surplus, which was small (16 pounds per colony, spring count), was from wild aster, and the brood-chambers are well filled with white honey from aster. I have my bees all packed in double-walled hives on the summer stands, with a Hill's device over the brood-frames, and a piece of bur-

Honey-Clovers & Buckwheat

SEED FOR SALE.

We have made arrangements so that we can furnish seed of several of the Clovers and Japanese Buckwheat, by freight or express, at the following prices, cash with order:

	10lb	50lb	100lb
Alsike Clover Seed.....	\$1.35	\$ 6.25	\$12.00
Sweet Clover Seed.....	1.50	6.50	12.00
White Clover Seed.....	2.40	11.35	22.00
Alfalfa Clover Seed.....	1.20	5.25	10.00
Crimson Clover Seed.....	1.00	4.00	7.00
Jap. Buckwheat Seed.....	.45	1.50	2.20

Prices subject to market changes.

The above prices include a good, new two-bushel bag with each order.

Your orders are solicited.

GEORGE W. YORK & CO.,
 CHICAGO, ILLS.



ONE MAN WITH THE UNION COMBINATION SAW

Can do the work of four men using hand tools, in Ripping, Cutting-off, Mitring, Rabbling, Grooving, Gaining, Dadoing, Edging-up, Jointing Stuff, etc. Full Line of Foot and Hand Power Machinery Sold on Trial. Catalogue Free.

SENECA FALLS MFG. CO.,
 46 Water St., SENECA FALLS, N. Y.
 1Aly *Mention the American Bee Journal.*

DON'T!

Buy Bees or Supplies until you have sent to us for special prices on what you need. The Goods and Prices "are right."
Our '96 Circular now ready.

I. J. STRINGHAM,
 105 Park Place. NEW YORK, N. Y.

CLOSING OUT SALE!

We have at this Branch among the Stock purchased of Thos. G. Newmau the following stock of Sections—not of our manufacture—which we desire to close out to make room for our

Superior Extra Polished Sections.

In order to close them out quickly we offer them for the next 60 days, or while they last, at these special prices:

White Sections, 4 1/4 x 4 1/4.	Cream Sections, 4 1/4 x 4 1/4.
45,500 7-to-ft. { 1,000 for \$1.75	{ 1,000 for \$1.25
{ 2,000 for 3.00	{ 2,000 for 2.00
{ 5,000 for 7.00	{ 5,000 for 4.50

TRIANGULAR TOP FRAMES.

We also have a stock of Triangular Top Langstroth Frames at these Special prices:
 100 for \$1.00; 300, \$2.70; 500, \$4.00; 1000, \$7.00.

On all freight orders of \$5 or less, at this Branch, please add 25c. for cartage. Catalogue Free.

The A. I. Root Co., 56 5th Ave., Chicago, Ill.

READERS Of this Journal who write to any of our advertisers, either in ordering, or asking about the Goods offered, will please state that they saw the Advertisement in this paper.

THROAT AND LUNG DISEASES,
DR. PEIRO, Specialist
 Offices: 1019, 100 State St.,
 CHICAGO. Hours 9 to 4.

Mention the American Bee Journal.

California

If you care to know of its Fruits, Flowers Climate or Resources, send for a Sample Copy of California's Favorite Paper—

The Pacific Rural Press

The leading Horticultural and Agricultural paper of the Pacific Coast. Published weekly, handsomely illustrated. \$2.00 per annum. Sample Copy Free.

PACIFIC RURAL PRESS,

220 Market St., - SAN FRANCISCO, CAL.

Mention the American Bee Journal.



OUR POULTRY ANNUAL

and Book of Valuable Recipes, 64 large pages, contains 8 beautiful colored plates of fowls, gives description and prices of 45 varieties, with important hints on care of poultry, and pages of recipes of great value to everyone. Finest Poultry Book published for 1896. Postpaid only 10 cts. C. N. Bowers, Box 24, Dakota, Ill'

52A13 Mention the American Bee Journal.

BEGINNERS.

Beginners should have a copy of the Amateur Bee-Keeper, a 70-page book by Prof. J. W. Rouse. Price 25 cents; if sent by mail, 28c. The little book and the Progressive Bee-Keeper (a live, progressive 28-page monthly journal) one year, 65c. Address any first-class dealer, or

LEAHY MFG. CO., Higginsville, Mo

SUCCESSFUL INCUBATOR

Our magnificent new catalogue giving full information regarding artificial Hatching & Brooding and treatise on poultry raising sent for 4c stamps. Circular free.

Write now. Des Moines Incubator Co. Box 75 Des Moines, Ia

49A13t Mention the American Bee Journal.

MUTH'S HONEY EXTRACTOR

PERFECTION Cold-Blast Smokers,

Square Glass Honey Jars, Etc.

For Circulars, apply to CHAS. F. MUTH & SON, Cor. Freeman & Central Aves., Cincinnati, O. Send 10c for Practical Hints to Bee-Keepers.

SPRAYING

Will Produce PERFECT FRUIT

We tell you all about spraying and care of fruit in our 32pg. illustrated book—free. Our Pumps and Nozzles win highest honors in every test. The Deming Co., Salem, O. W. Aet., Henion & Hubbell, Chicago

Mention the American Bee Journal.

1896 SAVE MONEY 1896

If you want first-class **ITALIAN QUEENS** FOR BUSINESS, Foundation at Wholesale Prices, Hives, suited for the South, or **SUPPLIES**, send for Price-List—to

J. P. H. BROWN, AUGUSTA, GA.

COMB FOUNDATION WHOLESALE AND RETAIL

Are you going to buy Foundation for Cash, or have you Wax to sell or trade for Foundation and other Supplies? Have you 25 lbs or more of Wax that you want made into Foundation? If so, do not fail to write me for samples and prices. I make a specialty of working up Wax by the lb., and do it very cheap during the winter. Beeswax wanted at all times.

GUS DITMER, AUGUSTA, WIS. Reference—Augusta Bank. 16Atf

lap and four or five thicknesses of rag carpet. I prefer the 10-frame hive with 9 frames and a dummy, then I can contract or enlarge the brood-nest to suit the colony. I like the dummy, for in examining the brood-nest you can take it out and set it down any place, and that gives plenty of room to set the rest of the frames back in the hive as examined, and no danger of robber-bees if there is no honey coming in.

I often see the question asked, When is the best time to transfer bees? I have transferred bees in May, June, July and August. My first colony was transferred from a tree Aug. 15, with not more than 1 1/2 frames of brood and empty comb, no honey. They came through, but were very weak. They built up on golden-rod that fall. Those that were transferred in June and July did not work with the vim that those did that were transferred in fruit-bloom. They worked more like a good prime swarm. Early fruit-bloom is the proper time to transfer.

D. A. HOLEMAN.

Goodwill Hill. Pa., Dec. 14, 1895.

California Anti-Adulteration Law.

Some time ago there was an inquiry in the Bee Journal respecting the California law on adulteration of honey. The following is a copy from the Revised Statutes of this State:

An Act to provide against the adulteration of food and drugs. Approved March 26, 1895.

Sec. 1. No person shall within this State manipulate for sale, offer for sale, or sell any drug or article of food which is adulterated within the meaning of this Act.

Sec. 2 (part of). The term "food," as used herein, shall include all articles used for food or drink by man, whether simple, mixed, or compound.

Sec. 3. Any article shall be deemed to be adulterated within the meaning of this Act: (b) In case of food: (1.) If any substance or substances have been mixed with it, so as to lower or depreciate, or injuriously affect its quality, strength or purity. (2.) If any inferior or cheaper substance or substances have been substituted wholly or in part for it. (3.) If any valuable or necessary constituent or ingredient has been wholly or in part abstracted from it. (4.) If it is an imitation of, or is sold under the name of another article. (5.) If it consists wholly, or in part, of diseased, decomposed, putrid, infected, tainted, or rotten animal or vegetable substance or article, whether manufactured or not; or in the case of milk, if it is produced from a diseased animal. (6.) If it is colored, coated, polished or powdered, whereby damage or impurity is concealed, or if by any means it is made to appear better or of greater value than it really is. (7.) If it contains any added substance, or ingredient which is poisonous or injurious to health.

Provided, that the provisions of this Act shall not apply to mixtures or compounds recognized as ordinary articles, or ingredients of articles of food, if each and every package sold, or offered for sale, be distinctly labeled as mixtures or compounds, with the name and per cent. of each ingre-

redient therein, and are not injurious to health.

Sec. 4. Every person manufacturing, exposing or offering for sale, or delivering to a purchaser, any drug or article of food included in the provisions of this Act, shall furnish to any person interested, or demanding the same, who shall apply to him for the purpose, and shall tender him the value of the same, a sample sufficient for analysis of any such drug or article of food which is in his possession.

Sec. 5. Whoever refuses to comply, upon demand, with the requirements of Section 4, and whoever violates any of the provisions of this Act, shall be guilty of misdemeanor, and shall be fined not exceeding \$100, nor less than \$25, or imprisoned in the county jail not exceeding 100, nor less than 30 days, or both. And any person found guilty of manufacturing, offering for sale, or selling, an adulterated article of food or drug under the provisions of this Act, shall be adjudged to pay in addition to the penalties hereinbefore provided for, all necessary costs and expenses incurred in inspecting and analyzing such adulterated articles of which said person may have been found guilty of manufacturing, selling, or offering for sale.

Sec. 6. This Act shall be in force and take effect from and after its passage.

Los Angeles, Calif. G. A. MILLARD.

Moving Eggs—Numbering Hives.

My 51 colonies come out of winter quarters in poor condition in 1895, and dwindled down to 24, but they increased again to 41, and I got 700 pounds of comb honey in one-pound sections, and 300 pounds of extracted. I sold it in my home market for 15 cents for comb and 10 cents for extracted. I have 41 colonies in the cellar in good condition now. I never had them winter better than they have so far.

In regard to bees stealing or carrying eggs from other hives, I can say positively I know they will. Last spring I had a strong colony that was queenless. A cloud came over the sun, and it got cold, so I didn't like to open any more to get a frame of eggs for them, for they did not have an unsealed egg in the hive. It was five or six days before I got to see them. I opened the hive, and on the empty frame I found a queen-cell with an egg not more than three days old. I looked for more eggs, but not another in the hive, so I took out another empty frame and gave them a frame of eggs and brood; in about a week more I looked, and they had taken some of the eggs from that frame and put into the one with the other queen-cell, and started five or six more, and built some on the one I put in. I watched them closely, and their cell hatched out a fine queen, and they tore the rest down themselves. Now, where did they get that egg if they did not steal it?

I can say that the American Bee Journal has been worth more than \$50 to me in the last five or six years I have taken it, by telling me how to get my money in shape for market, and how to handle my bees to the best advantage. It would seem like losing an old friend to be without it.

The last three years have been poor, but

Got Something for Nothing!

Did You? Thousands of readers answering my ad. in the past received free by mail at a cost of 20 cents to me, a package of my discovery, VITÆ ORE, and 90 per cent. have written to thank me and send cash order for more, declaring that it had done them more good than all doctors and man-made remedies they ever used. I scorn to take any one's money until convinced at my expense that V.-O. is the best thing in, on, or out of the earth for all who suffer from ills no doctor or drug will cure, such as general debility, feebleness from over-work, worries, cares, protracted sickness, old age, female complaints, all kidney and membranous ailments. It is the only natural, Nature's cure for human ills ever offered to man, and not by a quack doctor or methods peculiar thereto. If you have been bamboozled often, and grievously, by robbers in the medicine business, I am not responsible therefor, but am if V.-O. fails to give greater satisfaction than all else you ever tried. Send the addresses of six sick people and I will do the balance.

THEO. NOEL, Geologist, Tacoma Building, Chicago, Ill.

6A4t

Mention the Bee Journal

St. Joe

Is the name of the Hive you want. **PRICE-LIST** now ready. Send stamp and get valuable paper on **WINTERING BEES.**

GOLDEN WYANDOTTE Eggs from fine birds only \$1.00 for 13.

EMERSON T. ABBOTT, St. Joseph, Mo.

HONEY We have a large amount of Pure No. 1 Alfalfa we will sell cheap.

SEED Of those great honey-producing plants—Alfalfa and Cleome or Rocky Mountain Honey-Plant. Alfalfa seed at 7 cts. a lb.

Boss bee-escape Warranted the best, simplest and quickest Escape on the market. Sent postpaid to any address for 50 cts. It can be returned at our expense if it is not as represented, or we will send the Escape on trial to any bee-keeper wishing to test it in good faith. We are agents for the

Ferguson Patent Hive with double-case Super and Wicket-Gate Honey-Board, with the Escape. It is the easiest, quickest hive to handle for the production of comb honey. Address,
E. S. LOVESY & CO.,
355 6th East St., SALT LAKE CITY, UTAH.

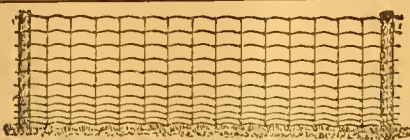

OTHERS COME AND GO

But the **PAGE** stays on forever—that is as long as you need fence. This idea of **permanency** is worth considering when times are hard. You can afford our monthly paper free.

PAGE WOVEN WIRE FENCE CO., Adrian, Mich.

Mention the *American Bee Journal*.

IF YOU WANT THE

BEE-BOOK

That covers the whole Apicultural Field more completely than any other published, send \$1.25 to Prof. A. J. Cook, Claremont, Calif., for hls

Bee-Keeper's Guide.

Liberal Discounts to the Trade.

TAKE NOTICE!

BEFORE placing your orders for **SUPPLIES**, write for prices on 1-Piece Basswood Sections, Bee-Hives, Shipping-Crates, Frames, Foundation, Smokers, etc.

PAGE & LYON MFG. CO.

NEW LONDON, WIS.

Sweet Clover, Willow-Herb, Basswood

EXTRACTED HONEY

—For Sale.—

We have made arrangements whereby we furnish **Sweet Clover or Willow-Herb** Extracted Honey, in 60-pound tin cans, on board cars in Chicago, at these prices: 1 can, in a case, 8 cents per pound; 2 cans in one case, 7½ cents.

The Basswood Honey is all in kegs holding 170 pounds, net. It is a very superior quality, and the prices are: 1 keg, 8½ cents per pound; 2 kegs or more, 8 cents.

Cash **MUST** accompany each order.

A sample of either kind of honey will be mailed to an intending purchaser, for 12 cents, to cover postage, packing, etc. We guarantee purity, and that what we ship will be equal to sample.

GEORGE W. YORK & CO.,

CHICAGO, ILLS.

the bees have paid as well as anything on the farm. I have run my farm of 80 acres, and seen to the bees, and did the work mostly alone. I have my bee-hives all with numbers painted on them, for this reason: When I am in the field to work, and the bees swarm, some one runs out and rings the dinner-bell as hard as possible; then I know what is up, and run for the house, and the wife will say, "Number 14" or "23," as the case may be, "has swarmed;" sometimes she has the queen in the cage already, for I clip the queens' wings. I don't like to climb tall trees. Then I keep a record this way: 14 swarmed June 20, in hive 16; 23 swarmed June 24, in hive 40. Then you see I know just where the old queen is, and when to open the old hive, and cut out the queen-cells. The next year I can look in my book and see just where my old or young queens are.

GEO. H. AURINGER.

Bonniewells Mills, Minn.

Sweet Clover—Bees and Noise.

As the readers of your paper are desirous of picking up all the knowledge possible about sweet clover, I wish to add what little I know about the hardness of the plant.

Last September my little nephew and I took a day's outing in the Chemung valley, near Waverly. Of course, I had my bee-hunting kit with me. After fishing until it ceased to be sport, we commenced a search for honey-plants, in order to find bees. Although the season was the driest ever known in this vicinity, sweet clover was found on a dry, gravelly bar, which was so barren for several rods each way that there was scarcely a plant of any other kind. There were plenty of blossoms on the plants, which were only 2 or 3 feet above the low water mark. Those plants must have been under water many times. Probably three or four days at a time during the spring freshets. As I do not wish to be misleading, I will say that stock might have nipped the plants during the summer somewhat, which caused them to blossom so late in the season.

I never took too much stock in the idea of noise interfering with bees, if the hives or their foundation were not thumped, as I have wintered them in first-class condition under the sitting-room where a large family lived. Dr. Gallup's account of that colony wintering on the willow-tree in that rock-a-bye-baby style, has convinced me still more that noise has little effect if the hives are not jarred, or motions are not seen by the bees.

Lockwood, N. Y.

J. H. ANDRE.

How to Market Honey and Wax.

I live in what is called a poor honey country, not many bees being kept here. I have 13 colonies, and produced, last season, 250 pounds of honey in one-pound sections. My best colony gave 67 pounds. Three swarms went away in the month of August. I have sold three-fourths of my honey, and I have not been to any trouble to do it. I work every day at my trade, and some mornings I carry my sample box of honey, which holds 8 one-pound sections; the box is made of ¾-inch white-wood lumber. It is 10 inches square, and 4½ inches deep. The box has a handle on the 4½ inch side, and is carried like a hand traveling-bag. A cover opens from each side, showing four sections on each side. It can be carried in a wagon without breaking the combs, and looks fine when open to show to a customer.

I get 20 cents a section for all of my honey. I keep a supply at the village store, which sells readily. For that I have made a little show-case of comb foundation. We keep the honey in a box at the store, and set out two sections at a time, in the little case, which is made of black walnut lumber and brood-foundation. The bottom is made of a 1-inch pine board, 10 inches long and 5 inches wide, 2½ inches being left flat for the section to rest on, and 2½ inches of front beveled down to a fine edge. The flat part is covered with white paper, the bevel with foundation. The top is made of ½-inch black walnut lumber. There are four round posts, and a half-round top-rail on top, with grooves in rail, and posts for foundation to catch in. This attracts considerable attention, as most of the people have never seen any foundation.

I mold my wax into small cakes, and get 5 cents a cake for it—that makes 80 cents per pound.

I am looking forward for a good season next year.
GEORGE C. BEALS.
Bridgewater, Mass., Jan. 13.

Report of a Chicago Bee-Keeper.

My apiary is located on 43rd and Colorado avenue, in a good place, surrounded by a 6-foot board fence, the boards of which are pointed at the top. On the northwestern portion of the grounds stands a neat cottage, the grounds being surrounded by a 16-foot alley. My 12 hives face the east. I have sufficient room for 100 hives.

I winter my bees on the summer stands. Although I have tried many plans for indoor protection, I prefer the former. The amount of honey from eight of these colonies was 700 pounds; three of them I built up. I got 108 pounds from one colony of blacks; the amounts from the others averaged from 70 to 80 pounds. They are all in prime condition.

I have an oak-tree stump that I found in the woods by the World's Fair Grounds. It is a monster, with bees and honey, and stands 6 feet high. It is interesting to see them slip out from two entrances. I would not take \$30 for it.

I notice by reports that the honey crop has been very slim for some years. I think the bee-keepers have to blame themselves for the light crops. If all the bee-keepers took the pains to scatter sweet clover over waste places and grounds, the reports would be quite different from what they are. They talk about all kinds of hives, and their sizes, but sweet clover is the best "hive" made.

I sold 700 pounds of honey at 15 cents per pound.
TIMOTHY O'DONNELL.
Chicago, Ill., Jan. 28.

Phenol Cure for Foul Brood.

I will now give my experience with phenol and the way I used it. I had five colonies to experiment with. Nos. 1 and 2 were very bad, Nos. 3, 4 and 5 were strong, with not much foul brood to be seen, but some cells in every comb. The 5 colonies were treated with half a pint of syrup for three weeks every evening, with 1-500 part of phenol.

Colonies Nos. 1 and 2 I poured the syrup all over the brood in the comb the first two evenings; after that I poured it around the brood on every comb, so they were bound to get it right against the brood. Nos. 3, 4 and 5 I poured the syrup around the brood-nest in every comb in the hives.

This was in July, 1895. There was but little honey coming in at the time. At the end of three weeks' treatment the colonies were just as bad as when the treatment was begun, and the result was I kept the disease in my apiary through the season. If any readers of the *American Bee Journal* have made a success with the phenol cure, I hope they will give it, so the readers can see how they used it. Also, it would be good if those who failed would state how they used it, for I have cured a good many

colonies by the starvation cure, and also by Mr. McEvoy's method.

Where I could have counted 100 colonies two years ago, I could not find 10 colonies to-day, not 2 miles from my apiary, yet I have to keep my bees from increasing too fast. The country was full of foul brood wherever there were bees, and it was impossible to keep the bees from getting at such honey, for the farmers had combs lying around everywhere.

Summit Mills, Pa. D. D. JOHNSON.

Early Brood-Rearing, Etc.

I have been in the bee-business three years in southern California. The more I am with the bees the better I like them and the care of them. My bees have the name of being the quietest in the community, still I think it advisable to wear a veil while handling them, as they are not of the non-stinging variety. But what I started to tell is, that they have a quantity of brood in all stages at this time. Is that not something unusual for this season of the year? There has been but very few days this winter that they have not carried in pollen. There has never been a time this winter that there has not been flowers of different kinds. At present they are bringing in some honey. We have just had a fine rain, and are hoping for a good crop the coming season. I have 140 colonies in good condition. I use the Lengstroth 10-frame hive.

E. E. WILSON.

Del Rosa, Calif., Jan. 22.

Honey & Beeswax Market Quotations.

CHICAGO, ILL., Feb. 21.—White clover and basswood comb is sought after in preference to any other, and commands a better price and now sells at 15c. for clover and 13@14c. for basswood. Other white comb honey sells at 11@12c.; dark, 8@9c. amber, 9@10c., and very slow of sale. Extracted is unusually dull, with large amounts on sale. White clover and Linden, 6@7c.; dark and amber grades, 4½@5c.

Beeswax, 28@30c.

R. A. B. & Co.

PHILADELPHIA, PA., Jan. 3.—Honey has declined in this market during the holidays. Large lots of California honey arriving, and selling at 5c. in 60-lb. cans. We quote: Comb honey, fancy, 16c.; fair to good, 8@14c. Extracted, 4@5½c.; white clover, 10c.

Beeswax, 30c.

W. A. S.

CINCINNATI, O., Feb. 18.—Demand is fair for choice comb honey, at 12@14c. in a jobbing way. Extracted is slow at 4@7c.

Beeswax is in good demand at 25@30c. for comb to choice yellow.

C. F. M. & S.

KANSAS CITY, Mo., Feb. 19.—The demand for comb and extracted is fair. We quote: No. 1 white, 1-lbs., 13@14c.; No. 2, 11@12c.; No. 1 amber, 10@11c.; No. 2, 8@10c. Extracted, white, 5½@6½c.; amber, 5@5½c.

Beeswax, 20@25c.

C. C. C. & Co.

Catalogs for 1896.—We have received the following Catalogs, Price-Lists, etc., a copy of which may be obtained upon application, always being careful to say you saw their advertisement in the American Bee Journal:

Geo. E. Hilton, Fremont, Mich.—Bee-Keepers' Supplies.

M. H. Hunt, Bell Branch (near Detroit), Mich.—Bee-Keepers' Supplies.

Ezra G. Smith, Manchester, N. Y.—Small Fruit Plants.

L. L. Olds, Clinton, Wis.—Seeds.

Storrs & Harrison Co., Painesville, Ohio.—Seeds, Plants, Trees, etc.

Emerson T. Abbott, St. Joseph, Mo.—Apian Supplies, Household Conveniences, etc.

UTAH.—The Utah Bee-Keepers' Association will hold their semi-annual meeting in Room 54, City and County Building, Salt Lake City, Apr. 6, 1896, at 10 a.m. All are invited. "In union is strength. By industry we thrive." Come, and bring your friends, and enjoy a good time. A full program in the interest of the industry will be presented. The Association needs your aid; then let every one do his full duty for our own interest and self-preservation.

Provo, Utah.

Geo. E. DUDLEY, Sec.

SOME BOOK REVIEWS.

"DOMESTICATED ANIMALS: Their Relation to Man and his Advancement in Civilization," is the title of a new book published by Charles Scribner's Sons, N. Y. It was written by Prof. Shaler, of Harvard University, contains about 300 pages, is finely illustrated, and sells for \$2.50. The dog, the horse, cattle, sheep, swine, domesticated birds, and, under the head of "Useful Insects," the honey-bee, receive attention. His talk about bees is interesting, but contains nothing new, and is marred by some blunders such as scientific men, who are not practical bee-keepers, are apt to make. The chapters on the "Rights of Animals" and the "Problem of Domestication" should be carefully read by all who have an opportunity. Prof. Shaler shows a keen sympathy with the animal kingdom, and he is an able and instructive writer. Such a book cannot fail to do good.

"THE WORLD OF MATTER: A Guide to the Study of Chemistry and Mineralogy." This book is published by D. C. Heath & Co., Boston, Mass. It was written by Prof. H. H. Ballard, A. M., who has exhibited on every page a peculiar aptness to teach. He begins with a commonplace thing—a piece of ice—and then takes up such subjects as water, air, earth, quartz, carbon, iron, chlorine, salt, etc. He talks about these in a way that is sure to interest, hold the attention, and instruct the reader from the start. This is another one of the books which make the student feel that he is studying THINGS as they ARE, rather than theories about them. It will be found a valuable book, especially where there is a family of children growing up.

"AGRICULTURE" is the title of a late work written by R. H. Wallace, and published by J. B. Lippincott Co., Philadelphia, Pa.; price \$1.25. It was written by a citizen of another country, but the principles of agriculture are the same the world over. Every phase of what is generally called "Agriculture" receives a brief but careful discussion in language that can be easily understood. The bee-keeper will be interested in the recognition which the busy little workers receive in the chapter on "Blossoms and their Functions." "The yield of fruit trees," he tells us, "has often largely increased by the introduction of bees into the neighborhood." "The flowers, as it were, tempt the bees unconsciously to help them to reproduce themselves by the combined means of pretty sights and dainty fare." So the busy bee is slowly receiving the recognition its importance merits in the literature of the country, and this recognition cannot fail to bear fruit in time.

The book contains over 300 pages, is filled with illustrations of agricultural implements and products, has an excellent index, is well bound and neatly printed. The price, considering the quality of the contents, is very reasonable.

BOTANY.—Wherever the science of botany is made a study, the name of Asa Gray is familiar, and his text-books have so long been a standard in this country that it seems like a superfluity to write of them. We desire, however, to invite the attention of the reader to a new edition of his "Field, Forest and Garden Botany," published by the American Book Co., Chicago, Ill., price, \$1.45. This edition has been thoroughly revised by Prof. Bailey, of Cornell, and the searcher after information will find it up to date in every respect, and thoroughly reliable. The bee-keeper will notice many plants mentioned in this edition, which were not found in the earlier editions, that are of special interest to him—and more attention is called to their value as honey-producers. We are glad to note this, for a general recognition of the industry in the literature of the country cannot fail to prove of material advantage to it.

This book, bound with "Gray's Lessons," under the general title of "Gray's School and Field-Book of Botany," price, \$1.80, is almost a necessity to those who have any interest in the study of plants, and should be in every home where there are children. The "Lessons" furnish the "Key," or nomenclature of the subject, giving all the essential facts as to the growth and development of plants, and the second part enables the student to properly name and classify any of the common plants of the Northern, Middle, and Southern States.

Any of the above books may be ordered through the Bee Journal office.

Bee-Keeper's Guide—see page 143.

PERSONAL MENTION.

PETER EHL, of Sherrills, Dubuque Co., Iowa, would like to correspond with some bee-keeper living near Traverse City, Mich., about locating there.

THE BLUEST THING OUT is the Progressive Bee-Keeper, or at least the *outside* is very blue-covered. But the *inside* is bright re(a)d-ing. Greatly improved this year.

MR. W. Z. HUTCHINSON contributes some very interesting and practical articles these days to the columns of The Country Gentleman, one of the oldest and best agricultural periodicals of this country.

DR. GEORGE DUNCAN, of Embro, Ont., Canada, died Jan. 23. He was one of the oldest bee-keepers in the Province, having made apiculture a deep study, and was recognized as an authority.

MR. JOHN NAU, of Middletown, Iowa, made the Bee Journal office a call recently. He comes to Chicago about once a year with a carload of stock. He thinks the prospects are good in his region for a honey crop this year.

DR. C. C. MILLER and FAMILY (Mrs. Miller and Miss Emma Wilson) were in Chicago the first week in February. The Doctor came in to help count the ballots cast by the members of the National Bee-Keepers' Union for the election of officers for 1896.

MR. JAS. A. STONE, the good Secretary of the Illinois State Bee-Keepers' Association, was requested to write an essay on "Bee-Husbandry" for their local farmers' institute, Feb. 20 and 21. We are sure it was well done, for Mr. Stone possesses the "know how."

MR. N. STAININGER, of Tipton, Iowa, called on us recently. He was on his way home from a trip through western Tennessee. He thinks some of changing from his present location—may go to Missouri. Mr. S. had 25,000 pounds of honey in 1889, part comb and part extracted.

HYGIENIC LIVING is the title of a most excellent 4½-page article by Mr. Allen Pringle, of Canada, in the January Review. He's a great quill-pusher when he "gets a-going." He's a good deal of a physiologist, phrenologist, bee-ologist, and—well, that's pretty much the "gist" of him, anyway.

List of Honey and Beeswax Dealers.

Most of whom Quote in this Journal.

Chicago, Ills.

R. A. BURNETT & Co., 163 South Water Street.

New York, N. Y.

HILDRETH BROS. & SEIGELKEN,
120 & 122 West Broadway.

CHAS. ISRAEL & BROS., 486 Canal St.

Kansas City, Mo.

C. C. CLEMOMS & Co., 423 Walnut St.

Buffalo, N. Y.

BATTERSON & Co., 167 & 169 Scott St.

Hamilton, Ills.

CHAS. DADANT & SON.

Philadelphia, Pa.

WM. A. SELSER, 10 Vine St.

Cincinnati, Ohio.

C. F. MUTH & SON, cor. Freeman & Central avs.

NEW YORK.—The Seneca County and Central New York Bee-Keepers' convention will be held at Hayt's Corners, Seneca Co., N. Y., at 9 o'clock, Mar. 5, 1896. All are cordially invited to attend. An oyster dinner will be served to all visitors. C. B. HOWARD, Sec. Romulus, N. Y.

The Bee-Keepers' Guide:

Or Manual of the Apiary,

By Prof. A. J. Cook.

This 15th and latest edition of Prof. Cook's magnificent book of 460 pages, in neat and substantial cloth binding, we propose to give away to our present subscribers, for the work of getting new subscribers for the American Bee Journal.

A description of the book here is quite unnecessary—it is simply the most complete scientific and practical bee-book published to-day. Fully illustrated, and all written in the most fascinating style. The author is also too well-known to the whole bee-world to require any introduction. No bee-keeper is fully equipped, or his library complete, without "THE BEE-KEEPER'S GUIDE."

For Two New Subscribers and Your Own Renewal.

Send us Two New Subscribers to the Bee Journal and your own renewal (with \$3.00), and we will mail you a copy of Prof. Cook's book FREE as a premium, and also a copy of the 160-page "Bees and Honey" to each New Subscriber. Prof. Cook's book alone is \$1.25, or we club it with the Bee Journal for a year—both together for only \$1.75. But surely anybody can get only 2 new subscribers to the Bee Journal for a year, and thus get the book as a premium. Let everybody try for it. Will you have one?

GEORGE W. YORK & CO.,
CHICAGO, ILLS

Question-Box.

In the multitude of counsellors there is safety.—Prov. 11-14.

Single or Double Brood-Chambers for 12 Frames.

Query 6.—I am inclined to think I want 12 frames or more in the brood-chamber. Is it best to have these in a single hive large enough to contain all, or to use two eight-frame hives, filling up the vacancy with dummies?—IND.

Mrs. L. Harrison—I prefer 8-frame hives.

W. G. Larrabee—I would use them all in one story.

Dr. C. C. Miller—I don't know. I'm trying to find out.

Prof. A. J. Cook—I prefer the two-story 8-frame hive.

J. M. Hambaugh—I would use the 12 frames in one body.

J. A. Green—I should prefer to have them all in one hive.

Dr. J. P. H. Brown—I would have them in a single story.

B. Taylor—I would make the frames deeper, and use 10 in a hive.

W. R. Graham—I would want all my brood-frames in a single hive.

G. M. Doolittle—If I used 12 frames I should put them in a single hive.

P. H. Elwood—If I used no more than 12 frames I should put them into one story.

Mrs. J. N. Heater—If I had to use 12 frames, I should certainly have them all in one hive.

Jas. A. Stone—Whatever number of frames I would have, I think best to have them all in one hive.

Chas. Dadant & Son—We much prefer a single story for brood, with dummies if needed to reduce the space.

E. France—Use two 8-frame hives one over the other. We use three 8-frame hives, that is, three tiers high.

R. L. Taylor—Better have a single hive large enough to hold 12 frames, and fill that up partly with dummies.

C. H. Dibbern—I think I should prefer the single hive for comb honey, and the two hives for extracted honey, but I would omit the dummies.

H. D. Cutting—It depends upon the size of frame. Why don't you say what you are using? I don't believe you want 12 Langstroth frames in a brood-chamber in Indiana, any more than we do in Michigan.

Emerson T. Abbott—I do not want any "dummies" in a brood-chamber. There are too many "dummies" lying around in the country now. If I wanted more than eight frames, and used a two-story hive, I should prefer 16.

Eugene Secor—If you winter bees on the summer stands, perhaps one hive would be preferable. If in a cellar, such a hive would be too large to handle. I would not use 16 frames in either case, but your conditions may be different.

Allen Pringle—You have struck a vexed question. Some of the "lights" have been at that a long time, with no sign of stopping. Let them go on with

it to the crack of doom, and not only will everybody have his own opinion still, but nobody will be much the wiser. If you must have "12 frames or more" in the brood-chamber, I would advise the double 8 duly dummies.

G. W. Demaree—I would want them in a single live-body, like the Dadants make their hives. But I doubt very much if you don't learn that 9 or 10 Langstroth frames in the brood apartment is preferable, one year after another.

Rev. M. Mahin—I cannot imagine why you want 12 or more frames in the brood-chamber, unless you want something on the Heddon plan. If I wanted 12 or more I would have about 20; and I would have them about 12 inches long and 6 inches deep, and have 10 below and 10 above.

J. E. Pond—This is a question that can only be determined by yourself and by experimenting. Different localities affect this question to such an extent that experiments are the only guide to determine the matter. I prefer a 10-frame Langstroth hive, tiered up to suit the condition of matters during the honey-flow.



POULTRY

40 Standard Breeds Illustrated & fully described in my new Poultry Book. Reliable information for poultrymen & intending buyers. Good stock Ducks & Geese; also Standard Poultry. Send 6c in stamps.

E. H. COOK, Box 27, Bentley, Ill.

Mention the American Bee Journal. 4A13t



Promptness Is What Counts!

Honey-Jars, Shipping-Cases, and everything that bee-keepers use. **Root's Goods at Root's Prices,** and the best shipping point in the country. Dealer in Honey and Beeswax. Catalogue Free.

162 Mass. Ave. **Walter S. Ponder**
INDIANAPOLIS, IND.

CALIFORNIA, "WAKE UP!"

The Pacific Bee Journal, devoted to the Protection and Advancement of Bee-keepers' interests on the Pacific Slope. 50 cts. per year. Send for sample copy.

THE BENNETT BEE-HIVE COMPANY

now make Foundation at 40 cents per pound. Bee-Hive Bodies (plain corners) 17½c. each. Common Bee-Hive, 2-story, 60 cts. each. Dovetailed Hives, " \$1.00 each.

Sections and Supplies low. Send for Price-List, and Save Money.

365 E. Second St., **LOS ANGELES.**

PATENT WIRED COMB FOUNDATION

Has No Sag in Brood-Frames
Thin Flat-Bottom Foundation
Has No Fishbone in the Surplus Honey.

Being the cleanest is usually worked the quickest of any Foundation made

J. VAN DEUSEN & SONS,
Sole Manufacturers,
Sprout Brook Montomery Co., N. Y.



NEW MAMMOTH

Poultry Guide for 1896. Finest book ever published, contains nearly 100 pages, all printed in colors, plans for best poultry houses, sure remedies and recipes for all diseases, and how to make poultry and gardening pay. Sent post paid for 15c. John Bauscher, Jr., box 94 Freeport, Ill.

49A13t Mention the American Bee Journal.

TEXAS QUEENS.

If you are in need of Queens, let me have your order. Price-List Free.

8A26t **J. D. GIVENS, Lisbon, Tex.**

WHEN ANSWERING THIS ADVERTISEMENT, MENTION THIS JOURNAL.



ORIGINAL BINGHAM SMOKERS

Wonderful Record!
HAVE LASTED 17 YEARS.
—BEST ON EARTH.

Always Give Perfect Satisfaction.

My cool Wire Handle and Bent Nose were patented 1892, are the original, my best invention since my open or direct draft Patent, 1878, that revolutionized Bee-Smokers. My Handle and Nose Patent bent all the other smoker noses. None but Bingham Smokers have all the best improvements. If you buy genuine Bingham Smokers and Honey-Knives you will never regret it. The "Doctor," ¼-inch larger than any other smoker on the market—¾-inch stove, by mail, \$1.50

Conqueror, 3 "	1.10
Large, 2½-in. "	1.00
Plain, 2-in. "	.70
Little Wonder, 2-in., wt. 10 oz.	.60

Bingham & Hetherington Honey-Knives, 80 cents.

T. F. BINGHAM, Farwell, Mich.
7A1f Mention the Bee Journal.

12 Pkgs. tested, pure, fresh garden seeds, 12 cts., postpaid. R. N. Thomas, Shenandoah, Iowa.

Bee-Keepers' Photograph.—We have now on hand a limited number of excellent photographs of prominent bee-keepers—a number of pictures on one card. The likeness of 49 of them are shown on one of the photographs, and 121 on the other. We will send them, postpaid, for 50 cents each, mailing from the 121 kind first; then after they are all gone, we will send the 49 kind. So those who order first will get the most "faces" for their money. Send orders to the Bee Journal office.

Bottom Prices

**BRING US BIG TRADE.
GOOD GOODS KEEP IT.**

If you want the best supplies that can be made at a little less cost than you can buy the same goods for elsewhere, write to us for low prices. 1896 Catalogue now ready—ask for it and a free copy of **The American Bee-Keeper** (36 pages).

Address,
**THE W. T. FALCONER MFG. CO.,
JAMESTOWN, N. Y.**
Mention the American Bee Journal.

Mention this paper.



EVERGREENS!

and Ornamental trees, Nursery grown. 250 Choice Evergreens, 10 varieties \$2. 400 Ornamental trees, 6 varieties, \$2; 6 other \$5 and \$10 bargains, 100 Scotch Pine, 2 ft. high, \$8; 1,000 10 to 12 inches \$10. All other varieties and sizes cheap. Local Agents Wanted. Send for Illustrated Catalogue. **FREE.**

**D. HILL, Evergreen Specialist,
JUNO, ILLINOIS.**
7A5t Please mention the Bee Journal.

ROOTS A great reduction in Prices on Hives and Sections. Other bargains in Apian Supplies. State what you need and we will give you low prices. 36-p. Catalogue Free.
JNO. NEBEL & SON, High Hill, Mo.
Mention the American Bee Journal. 4A26t

The Rural Kansan

Is an Agricultural Journal for the busy farmer. It embraces Bee-Keeping and every department of industry connected with the farm. 30 cts. a year, monthly. Sample Free.
A Full Line of **Higginsville Bee-Supplies** on hand.
CATALOGUE FREE.
**HENRY L. MILLER,
355 Shawnee Ave., TOPEKA, KAN.**
1A13t *Mention the American Bee Journal.*

FOR SALE.

**ALSIKE, CRIMSON, ITALIAN, ALFALFA,
or WHITE CLOVER SEED.**
4A8t **WM. CRAIG, Luce, Mich.**
Mention the American Bee Journal.

Queen-Clipping Device.

I want the address of all who clip Queens and have even the least trouble either in catching or holding them while they are being clipped. I have invented a Device by which it is impossible to injure a Queen either in catching or clipping, unless it is done purposely. With it they are caught and clipped any way desired almost instantly. One does not have to touch the Queen with his hands, whatever. Price, postpaid, 50 cts. Send for Free Circular. **C. MONETTE,
6Atf CHATFIELD, Fillmore Co., MINN.**
Mention the American Bee Journal.

BEES QUEENS
Smokers, Sections, Comb Foundation, and all Apian Supplies cheap. Send for FREE catalogue. **E. T. FLANAGAN, Belleville, Ill.**
6A26t Please mention the Bee Journal.

Fruit Plants Where to buy them at wholesale price. Send postal for descriptive and wholesale Catalogue of all of the leading varieties of the **Strawberries, Raspberries, Blackberries, Currants, Gooseberries, Grapes and Potatoes.**
EZRA G. SMITH, Manchester, Ont. Co., N. Y.
8Atf Please mention the Bee Journal.

CASH PAID FOR BEESWAX

For all the good, pure yellow **BEESWAX** delivered to our office till further notice, we will pay 26 cents per pound, cash; or 30 cents for whatever part is exchanged for the Bee Journal, Honey, Books or Seed, that we offer. If you want **cash promptly** for wax, send it on at once. Dark or impure wax not taken at any price. Address plainly,

George W. York & Co., 56 Fifth Ave., Chicago, Ill.

19th Year Dadant's Foundation 19th Year

Is still in the lead, for we use all the latest improvements, including the **NEW PROCESS**, and still make the best goods. Remember that we do not use any acid to purify our beeswax, and that is why our Foundation preserves the smell of the honey and is more acceptable to the bees, than any other. It is kept for sale by

G. K. Hubbard, Fort Wayne, Ind.
L. Hansco, Davenport, Iowa.
C. Theilmann, Theilmanton, Minn.
E. C. Eaglesfield, Berlin, Wis.
E. T. Abbott, St. Joseph, Mo.
J. M. Jenkins, Wetumpka, Alabama
Jona Rey, East Saginaw, Mich.
Vickery Bros., Evansville, Ind.

The Jennie Atchley Company, Beeville, Texas.
C. F. Muth & Son, Cincinnati, Ohio
E. Kretzmer, Red Oak, Iowa.
Jos. Nysewander, Des Moines, Iowa.
G. B. Lewis Co., Watertown, Wis.
James Reynolds Elevator Co., Poughkeepsie, N. Y.
Page & Lyon, New London, Wis.
T. H. Strickler, Solomon City, Kansas.

and many other Dealers. All agree in saying that no goods are better than ours.

Those of our customers who formerly bought through Thos. G. Newman can get our Foundation in **Chicago, Ill.**, by addressing us at **56 Fifth Avenue**. We keep no other goods there.

We make a specialty of **Veils and Veil Stuffs** of best quality, cotton and silk.

Langstroth on the Honey-Bee, Revised.

Bee-Keepers' Supplies, Smokers, Sections, Tin Pails, etc.

Samples of Foundation and Tulle FREE with Circular. Instructions to beginners with Circular. **BEESWAX WANTED.** Send us your address.

**CHAS. DADANT & SON,
HAMILTON, Hancock Co., ILL.**

Mention the American Bee Journal.

SECTIONS, BEE-HIVES, SHIPPING-CASES

We make a Specialty of these Goods, and defy Competition in

QUALITY, WORKMANSHIP AND PRICES.

Write for Free Illustrated Catalogue and Price-List.

G. B. LEWIS COMPANY, Watertown, Wis.

Be sure to mention the American Bee Journal when you write.

* ROOT'S COMB FOUNDATION! *

New Product.

We are pleased to announce that, having secured control of the new Weed process of manufacturing foundation for the U. S., we are prepared to furnish **Foundation by the New Process**, for 1896. Samples will be mailed free on application, and will speak for themselves.

New Process.

OUR SANDED and POLISHED SECTIONS, well, they will speak for themselves, also.

Our 1896 Catalog

will be ready for distribution now in a few days. Send in your name at once for catalog, samples of the new foundation, and those superb sections, and while you are about it ask for late copy of **Gleanings in Bee-Culture**.

A Big Success

THE A. I. ROOT CO., MEDINA, OHIO.

56 5th Ave., Chicago, Ill.

Syracuse, N. Y.

1024 Mississlppi St., St. Paul, Minn.

THE AMERICAN BEE JOURNAL

DEVOTED EXCLUSIVELY TO THE INTERESTS OF HONEY-PRODUCERS

ESTABLISHED 1861
THE OLDEST BEE-PAPER IN AMERICA

Published Weekly, at \$1.00 per annum.

Sample Copy sent on Application.

36th Year.

CHICAGO, ILL., MARCH 5, 1896.

No. 10.



Artificial Swarming, or Dividing for Increase.

BY CHAS. DADANT & SON.

It appears that very few, even among our leading bee-keepers, put into practice a system of artificial increase of colonies, at the present time. It is probably owing to the fact that the great majority of them use small hives, and for this reason have a great number of natural swarms—more, in fact, in some instances, than they desire. With us, the case is different, our large hives and our method of producing extracted honey altogether cause so little swarming that we hardly make up for winter losses, even in the best seasons, by the harvest of swarms. This has led us to rely altogether upon artificial increase, which we consider as much better for the apiarist.

It is our purpose to give in detail our mode of management. To say that we follow this method, at all times, would be a false statement. We are a little, nay, very much, like the old minister, who after a very eloquent sermon on temperance, was found in a rather equivocal condition by the roadside. "My friend," said he, "do as I say, don't do as I do."

Friend bee-keeper, read this, then do as—you please.

We believe that the Italian bee is superior to the common bee; we believe, also, that if we breed from the best queens, we are likely to have the best swarms. We believe that, in breeding bees, we should consider honey-production first, gentleness next, hardiness next, and lastly, color. We consider the drones as important, in the making of a good apiary, as the queens. With the present improved methods, the production of queens and of drones is entirely subject to the will of the apiarist.

In early spring, our aim is to examine all the hives and remove from them, as much as possible, all defective worker-combs and all drone-combs, except such of the latter as we judge advisable to leave in some of our best colonies. We do this in early spring, because at that time, the combs contain the least honey or brood. It is a mistake to cut out combs that are full of honey during a scarcity of crop, for the leakage will incite robbing. It is also a mistake to wait, for the removal of the drone-combs, until these combs are filled with brood; for all the feed and time spent on these drones are wasted. If to man, time is money, to the bees time is honey. In overhauling an apiary, during spring, it takes but little time to cut out all the drone-comb in sight. This should, of course, be replaced at once, by worker-comb, which can be taken from dead colonies, or, if none is at hand, by small pieces of comb foundation. But comb is much better, at that time, and we would prefer to cut up one or two combs from the brood-chamber of some weak colony which did not occupy them, and use them for this purpose. These combs may be replaced later on by foundation, or the colony may be caused to rebuild them. A comparatively weak colony is much less liable to build drone-comb than a powerful one.

If we removed the drone-comb, without replacing it by some worker-cells, each strong colony would be sure to replace every inch of it by the same kind. If we allowed the drones to be brought to the hatching-point before removing the comb, we should lose as much feed and work as was needed to rear three worker-bees for every two drones. In a square foot of comb this loss amounts to almost as much as a small swarm. □

With us, swarming usually takes place in June, and we therefore aim to make our increase early in that month. The drones must be reared in May, and to do this with success, we place one or two large sheets of drone-combs—not too old—in the middle of one of our best colonies noted for honey-production, gentleness, hardiness and color. Gentleness and color usually go together, unless you have Cyprus bees, and then we pity you. We have had those Cyprians, and have seen every living being stung about the farm, from the baby to the grandmother—from the rooster to the calf.

Let not the reader understand that we do so entirely away with drone-combs as to prevent the rearing of a single one, in the hives where they are not wanted. No, perfection is never attained, and it is next to impossible to prevent the colonies from rearing some drones; but with a little care, the greater quantity, by far, is reared in the colonies that we select, and at a much earlier date than in the other colonies; so our queens, if reared early, will have many chances to meet the best. By rearing good drones, we not only improve our stock, but that of our neighbors' also, and this, sooner or later, will redound to our benefit, as our daughters, indeed, do not always marry at home.

If we could control the fertilization of our queens, as we do the breeding of our cows, matters would be very much simplified.

Next comes the rearing of the queens. This is a very important matter, for we must not make swarms unless we have queens to give them. "Queens cost nothing," says Hutchinson. That is not our experience. Good queens, at the time when we need them worst—before the swarming season—are very expensive. You can buy some cheap ones, but they are cheap goods, after all, and it is much better to rear your own, if you have the right kind of bees in your apiary.

Our first step—say about May 25—is to remove the queen, with a couple quarts of young bees and a comb of hatching brood, from our best colony. We do not remove the colony itself from its stand, as we have seen it done, because it leaves the hive with too few bees to keep the combs warm during the cool nights, and it is of great importance that our young queens be kept very warm and be fed plentifully. Yet, if it is thought advisable, the queen and the swarm may be left on the stand, and the hive of brood, now queenless, may be placed on the stand of another strong colony. This is getting one swarm from two hives. Understand that we are doing all this, just to get one colony to rear queen-cells. This colony should not be the same as that from which the drones are reared, for we mean to avoid in-and-in breeding, and the drone-rearing colony should be kept strong, lest its bees should start killing those early-reared drones. In a bad season, late spring, rainy weather, they may want to kill them anyhow, before they are needed. In that case a little feed will stop the butchering.

Each colony, from which the queen is removed as above stated, may be depended upon to rear from 4 to 10 queen-cells. The number varies greatly. More cells will be reared if we cut openings in the combs containing eggs or young larvae, and if we feed a little. It appears that the bees dislike to destroy

any part of their work—that is why they nearly always build their cells on the outside, or lower edge, of the combs.

If we make longitudinal, or even perpendicular, openings through the combs, after removing the queens, say 24 hours afterwards—or when they have ascertained their loss—they will build a number of queen-cells along these openings, because they can do so without injuring any of their brood, while doing the repairing.

Feed, to a colony that is rearing queen-cells, is beneficial, if furnished sparingly and only at night, over the brood, so as not to excite robbing. The feed we use in spring differs from that which we would give them in the fall. It would be some thinner, and be given often, and in small quantities. During a good season, feeding is superfluous, and the weather and conditions of the bloom should be considered.

Hamilton, Ill.

[Concluded next week.]



Bee-Keeping and Living in Southern California

BY DR. E. GALLUP.

I know of one choice location for an apiary for sale. There are about 5 acres set out to fruit, and 75 acres of tillable land, and two good springs of water. A man that wants to work could fix it up in splendid shape in short order. There are but very few good, choice bee-ranches for sale, as the most of the bee-keepers know when they have a good thing, and are bound to keep it. It is not every one that can get hold of a place that he can raise fruit, stock, etc., in connection with an apiary, and you Eastern people must understand that one can plant corn from March to July, some grain from November to April—he can choose his own time to plant, sow and harvest, and not interfere with his bee-keeping at all. So that in a poor bee-season he is always prepared to make a good living, anyhow.

Read what Prof. A. J. Cook says about California as a bee-keeping State, on page 2. He admits that he may be enthusiastic, and so am I. If I were a little younger man, I would drop every other business and go into bee-keeping again. The obstacle of a low price for honey will certainly be overcome as soon as the bee-keepers unite and get down to business. Bees can be kept so as to be self-sustaining in our poorest seasons, and in good seasons with extracted honey at 5 cents per pound, the profits are large, especially where one or two men can take from 20 to 30 tons in a season. Bees gather something in the valleys the entire year.

A swarm clustered in a hedge across the street from me the latter part of June, 1895; I hived them, and they filled their hive and a super. I have taken out six combs of honey and used it in the family. The hive is now full, and the bees have worked constantly with the exception of six days, and now (Jan. 8) the mercury stands at 70° in the shade on the north wall of the house, and every afternoon the young bees have their sport the same as yours do in June. They are carrying in pollen and breeding right along, and of course, gathering some honey.

I am asked what the prospect is for the next season. That I cannot tell. We have had but very little rain so far, but one thing I have noticed—our late rains (if we have them) produce the best seasons, both for crops and honey. Orange county has thousands of acres of moist lands that produce every year, rain or shine. Then we have a splendid system of irrigation for our dry or fruit lands. The land-owners own the whole system of irrigating canals, so the expense is but nominal. All the expense is for keeping the canals or ditches in repair, and paying men for looking after and delivering water. We have the best system of irrigation, and the cheapest. Our water is not owned and controlled by a grasping monopoly that can raise the price of water at any time they see fit.

I look forward to the time when bee-keeping will be carried on to quite an extent in our valleys, and I find, on inquiry, that there is a great sight more of it than formerly. People are becoming educated, and learning that bees are not such a nuisance in the fruit-orchard as they supposed. Orange county is located right on the coast, so we have none of the oppressive heat that they have in the interior. The farther one gets from the Old Pacific, the more he feels the heat.

Eastern people have an impression that we are so far south that it must be excessively hot in summer, and many a one that has spent the winter here is sure, and positive, it is so warm in winter that it must be extremely hot in summer; but in summer we have the cool, health-giving breeze that comes up every morning at about half past 8 o'clock, directly

from the ocean. Our warmest weather is in April and September, before the coast winds get established, and after it ceases.

There, I have written the above in answer to numerous inquiries.
Orange County, Calif.



Poisonous Honey—Do Bees Ever Store It?

BY NOVICE.

On page 825 (1895) is reprinted an article from the New York Sun, which purports to give an account of the poisoning of two persons from the use of honey coming from a locality where the mountain laurel is abundant. I am glad that J. W. S. calls the attention of bee-keepers to this publication. A. I. Root in the "A B C of Bee-Culture," apparently lends credit to the notion that the honey gathered from mountain laurel is poisonous. I submit to the readers of the American Bee Journal that it is time to find out whether there is any truth at all in the idea that bees in this country ever store honey that is deleterious to man. For one, I must say that I am a skeptic on this subject. I do not believe that in the order of Nature, the bee, which seems to have been created for man, should not have been gifted with an instinct that would protect it, and man himself, from the consequences that would result from gathering poisonous nectar.

This *a priori* conclusion is supported in my own experience by facts. Last spring, when I began to extract, there were not less than 40 acres of land within a mile of my apiary covered with this mountain laurel. The creek in whose swamp it grows, runs within 100 yards of my house, and I extracted honey from all my colonies at least twice while the laurel was in bloom, and though every family in the town ate of the honey, not a single whisper has been heard that the honey was not wholesome. I am a professional man, and have not up to this time produced any honey for market. Most of my crop of 70 gallons for the season past, has been given away to friends, and only six gallons sold this year, so that it may be understood that I have no interest in disguising the truth, and that I am impartial in this matter. I know that bees visit mountain laurel here, and that the honey they store is perfectly harmless.

Not being a botanist, I do not know that there is only one variety of mountain laurel. I have mailed to the editor a leaf of the shrub we call mountain laurel. The vulgar name is "ivy," and it is true that the leaves are poisonous to cattle. A hungry cow will chew the leaves when opportunity offers, sometimes in the winter, and it results in loss of muscular power, trembling of the limbs, and in extreme cases death takes place unless strong stimulants are given.

The leaf is of a dark, glossy green. The shrub or bush grows in sandy creek swamps, and to the height of from 10 to 15 feet. The flowers are in clusters of a pale pink color with specks of darker pink. The petals are joined together in such manner that they form an irregular-shaped cup, and are singularly delicate and handsome in appearance. It is an evergreen. Now, if this be the mountain laurel, I can truthfully and confidently assert that the honey is not poisonous.

The statements to the effect that the purchaser of honey in the country may chance to buy honey that is poisonous, are calculated to injure the sale of honey in the markets everywhere, and I suggest to the readers of the "Old Reliable" that it is desirable that this matter be thoroughly canvassed in the bee-papers. Let those who keep bees where mountain laurel grows speak out, and if it is untrue that mountain laurel honey is poisonous, the truth should be made clear to the world.

Our good friend A. I. Root, in his hand-book on bee-culture, furnishes an illustration of the mode in which people come to rash conclusions upon insufficient evidence. He publishes a very accurate drawing of the flower of the yellow jessamine, which perfumes our Southern forests in February and March, and states upon the authority of a Southern apiarist that the pollen of the jessamine is poisonous to bees. The apiarist knew that the root of the yellow jessamine contained an element used in medicine, which, when taken in large quantity, produced the effects of a poison. He saw his bees dying with symptoms of a disease which would be recognized by many apiarists, and which disease infected apiaries at the worst in February and March, may be seen in every month in the year. He concluded that the yellow jessamine was responsible for the death of his bees. There are scores of Southern apiarists whose bees range among the flowers of the yellow jessamine, who could tell Mr. Root that the very estimable gentleman whom he quoted was altogether mistaken,

and that in apiaries free from disease the yellow jessamine does no harm.

The object of this article is to challenge the attention of bee-keepers to the subject of alleged poisonous honey. Is there satisfactory proof to be had from any quarter that in this country—North, South East or West—the instinct of the bee cannot be relied on to defend itself against poisonous plants?
Columbia, Miss.

[The leaf referred to by Mr. Ford we did not find. Possibly it was lost, or perhaps he forgot to enclose it as intended. We should be glad to hear from any or all who can speak from experience on this subject.—EDITORS.]



No. 2.—Experiences, Impressions and Reflections After Five Years of Bee-Keeping in California.

BY RAMBLER.

[Continued from page 167.]

I had not been long in the vicinity before I discovered an apiary of 170 colonies, that I secured to work on shares. I preferred at this time to work an apiary rather than to buy, for the very good reason that I did not have loose money enough to buy with. I wished, furthermore, to test the climate, the honey-resources, and various features of the country before I settled down permanently.

The apiary was a typical California outfit—the hives upon a gentle slope close to a rugged mountain, the chief features of which was the absence of trees, and the presence of immense granite boulders. On the lower side of the apiary was an 8x12 extracting-cabin, and some ten yards below it an immense galvanized-iron honey-tank, that would easily hold six tons of honey. The wind had free course here, and old, empty extracting-supers and empty tin honey-cans had been whisked around promiscuously amongst the hives and surrounding bushes.

The honey-extractor was an old, wooden four-frame affair—such were made here several years ago—antiquated but effective. There was a cover for it, but some one had left it on the floor. In the bottom of the extractor was about six inches of candied honey, in which were several dead mice and a gray ground-squirrel—all well submerged and well preserved. In some of the promiscuous tin cans was a good supply of honey; the screw caps had been left off, or taken off by some prowler, and the bees having access to the contents, proceeded to drown themselves by the quart, or until no more bees could get into the cans.

The big tank had also been left with a defective cover, and a good bait of honey in the bottom; in this I found over two bushels of dead bees, and a few mice; larger victims could not get through the crevices above, or they surely would have been there.

The owner of the apiary was interested in a furniture store in Riverside, and amongst the various boxes in which furniture is crated, there is much good lumber; this lumber-pile, the furniture wagon and horse, were put to my disposal, and out of the lumber, some boards rough, some smooth, some thick, some thin, a few wide, and many narrow, I obtained enough to build a lean-to adjoining the extracting-cabin. This work lasted several days, and when completed I had a room 8x12 to live in; and to make things homelike I adjusted a mattress to a home-made bedstead, and brought out several conveniences. I could not circulate around much in that house. The household goods took up considerable room, and then that portion near the eaves was not elevated enough for a tall man to stretch himself in perpendicularly; but I had all out-doors before me, and plenty of sunshine, and so my confined quarters were tolerable.

As this was my first experience in baching, I could not cut myself loose at once from social privileges, and, in addition to my bachelor quarters in the apiary, I rented a room in town, and spent Sundays and other portions of the week when not busy in the apiary, in town.

The apiary was five miles from Riverside, and in the absence of a horse I performed the journeys to and fro on foot.

Besides building the cabin, the remaining portions of January and February were spent in regulating things, and examining the condition of the bees. The odds and ends of cans had been piled at one side in the brush, where they could not tumble before the wind. The extractor and tank had been cleaned and sealed, and on the latter I fitted a frame hinged

in the middle and covered with wire-cloth—this allowed access, and kept out bees and vermin.

The first thing that dawns upon the stomach of the fresh bachelor, is the lack of a knack in cooking. He has seen pots and kettles and skillets on the stove at home, and has seen them filled and emptied, and if any instructions in cooking have been given at such times the instructions went into one ear and out at the other. Cooking upon a two-wick oil-stove has various phases of discouragement, and in the absence of milk and eggs the pancakes will persist in being soggy. So canned victuals are used, and good bread—thanks to a bakery and a tight tin can in which to keep the bread from drying up. As Sancho Panza blessed the man that invented sleep, so I shouted several times with unctious, "Blessed is the man that invented bread and butter!"

My bad cooking led me to make several journeys to get a square meal at the restaurant. But it is a dull scholar that cannot learn, and afterward, with a nice little stove, I became so proficient as to call forth remarks of admiration from some of the leading benedicts on this coast.

My various walks to town were not altogether uninteresting, for in February, when a good portion of the East is struggling in snow, here many-hued flowers began to appear. Alfillaree is the first little blossom that appears in January, and more plentiful in February. It is a plant of low habit, and a very small pink blossom, with only four tiny sepals, and scarcely a half-inch in diameter. After abundant rains these blossoms carpet the ground, the bees securing enough honey from them to greatly invigorate brood-rearing.

The absence of rain at this time, and the depredations of a large herd of sheep, kept down the growth so that the bees found but little honey.

There is another plant—a modest bush, bearing the antiquated name of "old man"—the little racemes of dull yellow blossoms, yield a great amount of pollen which the bees greedily gather, and the failure of the alfillaree is not altogether a calamity.

In a great many apiaries in this State, and especially in this one, the bees had to do considerable rustling to find water. This valuable liquid was a mile away. I believe it is an unsolved problem how far bees will go for water, or how small an amount will tend to the prosperity of the colony, but I do know that at times 150 colonies will get away with nearly a half barrel of water in a day. This being a fact, it must decrease the honey-yield of any apiary when a large force is diverted from honey-gathering to the gathering of water. Such localities are occupied because they are exceptionally good honey-localities, and the manager of the apiary has to follow the example of the bees and haul water for domestic purposes. When a team was not handy my vehicle was an old, rickety wheelbarrow, and two five-gallon honey-cans; and I wish to remark that it is no pastime to wheel water a mile when the air is full of gnats and flies, anxious to lap the sweat from the laborer's brow when both hands are employed on the handles of the wheelbarrow. If the operation is performed in the early morning or evening, when flies are not out in force, the operator's face or neck will commence to itch in an unaccountable manner, and the wheelbarrow is allowed to rest while the troubled parts are attended to.

I have a profound sympathy for bees remote from water, and though the flies and the itch do not bother them, high winds greatly impede their work, and at such times they are crazy for every drop of water exposed near the apiary. Some bee-keepers are provident enough to haul water for their bees in the height of the honey season, but it is always the owner and his team. I never knew a person working an apiary on shares, with only a companionable wheelbarrow, to do such a thing.

In February the flowers begin to spring up in greater profusion, and my walks from town, while tiresome to the lower limbs, are a never-ending source of pleasure to the head. The California lark, with his bright yellow corselet, ever bappy, and perched upon a sage-stalk or a chemise bush, pours forth his set piece of music, and upon my approach flits ahead with a song in his throat and secures another perch. Thus over and over again his song is rehearsed, but ever pleasant because from a thing of life and companionship in a desert place. But if the lark is prone to repeat his melody to the verge of monotony, the mocking-bird is the opposite in his ever-changing and never-ending warbles. Even in the night his subdued chattering and whistles are heard as he perches near the nest of his mate, and lends encouragement to her maternal duties. It is the height of pleasure at any time to "listen to the mocking-bird!"

"Winged mimic of the woods! thou motley fool!
Who shall thy gay buffoonery describe?
Thine ever-ready notes of ridicule

Pursue thy fellows still with jest and jibe.
Wit, Sophist, Songster Yorrick of thy tribe.
Thou sportive satirist of Nature's school,
To thee the palm of scoffing we ascribe,
Arch mocker and mad abbot of misrule."
[To be continued.]



Preparing and Moving Bees on a Wagon.

BY J. R. SLEASE.

Some time ago I saw in the Bee Journal some explicit directions for moving bees in ramshackley hives, a distance of 7 miles. As I have had considerable experience in hauling bees at distances varying from 3 to 100 miles, over the worst of Rocky Mountain roads, I thought that my ideas of moving bees might be useful to those who have them to move.

The best time is immediately before the working or breeding season, in the latter part of winter or early spring. Leave the hives just as the bees sealed them down for winter. A strip of stiff spring burlap (the opener the better) two inches wide and two inches longer than the hive-entrance, doubled in at the ends and pushed into it with a thin knife-blade, placed on the center line so that it goes in double, with a small wire nail in each end, is all the closing they need for either a long or short haul on smooth roads. On rough roads a good cord or wire tied tightly around each hive will answer, and on very rough roads a cleat should be nailed on each corner of the hive, long enough to nail to both cover and bottom, where bottoms are loose.

To prepare the wagon, take the bed off and couple it 12 feet long for plank 16 feet long, or 16 feet long for plank 20 feet. Floor the wagon with 2-inch plank if the road is reasonably good; if rough, lay a 2x4 crosswise on each end of plank floor—one behind the front wheels and another in front of the hind wheels; floor on top with inch boards, and pin-spikes or bolt the four corners, and you have a platform that you can haul the bees over any road in perfect safety, if you have a good team, and the driver is neither scary nor balky.

Choose a good, moonlight night. Close the hives as early as possible, put on as many as you can, and drive through as soon as your team can walk it. Put off the hives and open them at once. Put a board or some obstruction in front of each hive to compel, or rather induce, the bees to locate, and repeat each evening until the bees are moved. I have hauled bees on this plan two hives deep, more than 100 miles. I was on the road four or five days, and passed several miles in which the wheels constantly hopped from one rock to another, without touching ground.

If the hives are bad, cover down as soon as loaded with a wagon sheet, tarpaulin, or old bed-quilts, to keep as dark as possible.

FASTENING FOUNDATION.

After trying many methods, we set our frames in the sunlight until they get warm, lay the wax (foundation) to the wood, and roll, in case of brood-frames, or press, in case of sections, with the Parker fastener. We work with 12,000 to 16,000 pounds of honey a year, and cannot follow round-about methods. Roswell, New Mex.

[Those who have very full acquaintance with the Parker foundation fastener, say that for one who has many sections to fill with starters, it is entirely too slow and too hard work, and that after you get the hang of the Daisy fastener, you could hardly be hired to use the Parker.—EDITORS.]

A New Binder for holding a year's numbers of the American Bee Journal, we propose to mail, postpaid, to every subscriber who sends us 15 cents. It is called "The Wood Binder," is patented, and is an entirely new and very simple arrangement. Full printed directions accompany each Binder. Every reader should get it, and preserve the copies of the Bee Journal as fast as they are received. They are invaluable for reference, and at the low price of the Binder you can afford to get it yearly.

If any one desires two of the Binders—one for 1895 and one for 1896—send 25 cents, and they will be mailed to you.

The McEvoy Foul Brood Treatment is given in Dr. Howard's pamphlet on "Foul Brood; Its Natural History and Rational Treatment." It is the latest publication on the subject, and should be in the hands of every bee-keeper. Price, 25 cents; or clubbed with the Bee Journal for one year—both for \$1.10.

CONVENTION PROCEEDINGS

Report of the Illinois State Convention Held at Chicago, Jan. 9 and 10, 1896.

REPORTED BY ERNEST R. ROOT.

(Continued from page 134.)

Second Day—Afternoon Session.

CURING FOUL BROOD WITHOUT DRUGS.

Question.—"Can foul brood be destroyed without destroying the colony, and without resorting to drugs? If so, how?"

Mr. Walker—I tried Mr. Root's plan of shaking the bees off from the diseased combs, and putting them on frames of foundation in clean hives. This worked well, but it was too expensive at the time on account of the waste of brood and combs which had to be burned. I tried, also, pruning or cutting out diseased spots of honey, as I would find them in looking over the hives. This worked very well while the honey-flow was good.

Mr. Baldrige—The plan I use and recommend is the one I described in the Bee-Keepers' Review a couple of years ago. I bore a hole through the front of the hive that has the disease, and attach a bee-escape. What I used is a perforated tin cone. The entrance is now closed, and the hive removed a few inches to one side of the stand it occupied, and a clean hive with a frame of brood and adhering bees is put in its place. The queen is caged in the diseased hive for a day, when she is removed and allowed to run into the new hive on the old stand. It is evident that no bee can get in or out of the old hive except by the escape, and in from 30 to 60 days they will all be out—the bees in the old hive, as well as those yet to be hatched from the brood. I thus save, as you see, all the brood that is good for anything. At the end of the 60 days I remove the old hive, disinfect it, and burn the combs.

Mr. Walker—I tried that plan, and it did not succeed. I consider it very risky on account of robbers.

Mr. Wheeler—I wonder if there are two diseases very similar. I have seen in my yard a sort of false foul brood. It resembled the real disease, but never amounted to anything, and finally it went off itself.

Mr. Root—Yes, we have seen the same thing in our yard. The cappings of the brood will become punctured, sometimes sunken, and the larvæ will shrivel up, and turn yellow and brown; but it lacks one important symptom, and that is, pronounced ropiness of the diseased matter. What we mean by ropiness is this: If a toothpick or spear of grass be inserted in the dead matter in the cell, it will adhere to the point as it is slowly drawn out, like spittle; and if it is drawn out still further the filament will break, the two ends lying back to their points of attachment. I have seen very slight ropiness with this false foul brood, but it is easily distinguished from the other.

Mr. Draper—I have had something similar in my apiary. Larvæ would soon die after hatching from the egg. I did not dare to risk it, so I burned all such colonies. I saw the same thing at J. M. Hambaugh's, who declared it was not foul brood at all. It seems to come on in July and August.

Mr. Walker—I have had dozens of such cases as these, and do not care a snap for them. With me it comes on at all times, and is not ropy.

Question.—"How fast is foul brood likely to travel?"

Mr. Walker—It often gets a start before the apiarist suspects it.

Mr. Thompson—Can the germs be carried in the air?

Mr. Root—Possibly, but probably not. Its chief method of propagation seems to be through honey containing the diseased germs that robbers get hold of.

GETTING WOMEN TO ATTEND CONVENTIONS.

Question.—"What can be done to get women to attend conventions?"

Mr. Stewart—I invited my wife to come, and she came.

Miss Candler—If they keep bees they will want to come. I have had as high as 86 colonies, and now I have 54. My average per colony was 60 pounds in 1895.

President—We have quite a number of other ladies present. Let us hear from them.

Mrs. Poindexter—I commenced with 11 colonies, and increased and added till I had 200. These 200 we had in three locations in DeWitt country, 12 or 15 miles apart. At my home yard I had 80 colonies. At the time we had 200, we had 12,000 pounds of comb honey, besides what extracted was taken.

Mrs. Stow—I had 37 colonies in the spring of 1895, and increased them to 60. I now have 55; 5 were destroyed by the mice. My crop was 1,200 pounds.

MICE DESTROYING COLONIES.

Question.—“What should be done to prevent mice from destroying colonies?”

Mr. Draper—Contract the entrances so the mice cannot get in.

President—I use wire-cloth three meshes to the inch, tacked over an entrance that is two inches deep, as long as the entrance of the hive is wide.

STORING HONEY AND NUMBER OF BROOD-FRAMES.

Question.—“Will bees store as much honey when there are 16 frames in the brood-nest as when there are only 8?”

Mr. Walker—A friend of mine, Mr. N. Doane, of Breckenridge, Mich., tried the 16's and 8's. He said the 16's were ahead.

Mr. Ellis.—Bee-trees, you know, have large brood-capacities, and they generally contain considerable honey.

Mr. Draper—The Dadants have been preaching large hives for years. I use them myself, and prefer them. I see that Mr. Root has been testing larger hives, and I should like to have him tell what he knows about them.

Mr. Root—I have reported in Gleanings from time to time my experiments in testing 8-frame and 16-frame colonies at our out-yard. Colonies in the latter gave us more honey by considerable; in fact, they were the only ones last season that seemed to get any honey at all; and, more than that, they do not offer to swarm. While the 8-framers did little or nothing toward getting honey, they gave us no little annoyance swarming out. There may be localities and conditions when a single 8-frame body will give the better results; for the present, at least, I should prefer the double hive. Perhaps I ought to state that we were running this out-yard for extracted honey.

Mr. Walker—Last season I got better results from large hives, especially from 3-story 10-framers. But large hives will not give the honey unless you have the bees and a good honey-flow. However, I should be satisfied with a 12-frame hive for extracted, and 10-frame for comb honey.

Mrs. Stow—I hive swarms on 7 frames, and later on I add 3 others, as the need of the colony may demand.

Mr. Draper—Bro. Root ought to get a good scoring for pushing an 8-frame hive in his catalogue when he says he can get better results with large hives! [Laughter.]

Mr. Root—Yes; but all people do not think alike. We give our customers their choice between 8, 10, and 12-frame hives; but we generally recommend them to get the 8, and then if their locality or honey-flow justifies it, they can use two 8-frame bodies, one above the other. So far as I can yet see, the 8-frame hive, for the present at least, offers a very good solution for the large and small hive problem.

Question.—“Will two 8-frame hives, one above the other, give as good results as one large hive containing 16 frames all in one brood-chamber?”

Mr. Walker—I should prefer the single brood-chamber.

Mr. Thompson—I would have two.

Mr. West—I get more honey from one 8 than from two 8's.

Mr. Draper—I want large hives for brood-nests, and I want that brood-nest all in one. I want it full of bees and brood; then when the honey-flow comes on, I put shallow extracting Dadant supers on top.

THE AMALGAMATION QUESTION.

Mr. Newman—If there is nothing else before the convention, I should like to see an expression from this body regarding the advisability of amalgamating the North American Bee-Keepers' Association with the National Bee-Keepers' Union.

President—In order to vote intelligently, perhaps it will be well for us to discuss for a few minutes some of the objections as well as the advantages of such a union of the two societies. Mr. Newman, will you tell us some of the objections that have been urged against this amalgamation?

Mr. Newman—Occupying the position that I do, I take no sides; but from letters that have come in, entering their protest, it is evident that some can see no advantage. Others object to taking the funds given to the Union for defense and

using them for some other purpose after the two societies are combined. Again, others say that the objects and interests of the two societies are dissimilar.

President—I have been an advocate of amalgamation, and can see no disadvantage, but some very decided advantages, in favor of it. For one thing, the two combined societies would have a larger membership, greater influence, and, consequently, more power.

Mr. York—There are many reasons why amalgamation is desirable. As I understand it, there would be no change in the constitution of the amalgamated society that would weaken the effectiveness of the present Bee-Keepers' Union. I believe we will have a representative apiarian society much sooner in this country with the two societies in one than if they remain separate. It would be a saving of expense in membership fees, and I see no good reason why arrangements could not be made to present to each member a year's subscription to his choice of one of the bee-papers besides. [See editorial on this subject on page 152 of this number.—Eds.]

After some further discussion a rising vote was taken to test the feeling of the convention as to the desirability of amalgamating the two societies. The vote was practically unanimous for amalgamation.

As many were desirous of going home, the convention adjourned at 3 p.m. ERNEST R. ROOT, *Sec. pro tem.*

Questions AND Answers

CONDUCTED BY

DR. C. C. MILLER, MARENGO, ILL.

[Questions may be mailed to the Bee Journal, or to Dr. Miller direct.]

Bees Uneasy in the Cellar.

I have my bees in a cellar which is very damp. I can keep the cellar about an even temperature now, but I think it will be too warm as the weather gets warmer. Bees seem uneasy when the cellar door is opened, leaving the hives and flying out. The cellar being under the kitchen is the reason I think it will be too warm. Would you advise me to put the bees out and leave them out? A. B.

Bladensburg, Ohio.

ANSWER.—I think I'd try to leave the bees in the cellar till they can fly when put out. If you put them out during weather too cold for them to fly, you may ruin them thereby. There will be no trouble whatever in making the cellar all right for them if there is an outside window or door. Just open the door or window as soon as it begins to get dark in the evening, and by morning they will be quiet. Don't be alarmed if they make a tremendous racket when the cellar is first opened, running all over the hives. They'll quiet down by morning, and in the morning if they appear to want to fly out you can darken again. If the cellar opens only on the inside the case will be more difficult, but by leaving the door open at night, that goes from the kitchen to the cellar, and also leaving the kitchen door open you can probably get them cooled off. After all, it is not so much that they need to be cooled off as it is that they need to have the air changed. Very likely a warm day will come in March when you can put them out.

Honey from Flax—Smartweed and Heart's-Ease Honey—Wintering Bees.

On page 394 (1895) M. R. asked these questions: “Does flax yield honey? Can bees gather it? If so, what color is the honey?” This spring I sowed 2 bushels of flax seed on about two acres of ground, which gave me a very nice stand. I sowed it the latter part of April, and for 10 or 12 days past it has been in bloom, and the bees just swarm on it. Close by I have a strip of alfalfa that has been in bloom ever since the flax has, but so far I have failed to see any bees on it—they fly right over it and go to the flax, which is, except the alfalfa, the only bloom we have at the present writing.

The bees get only honey from flax, and no pollen. The

color of the honey is a light, golden amber, and has a very fine flavor; it is very thick, and does not run out of the cells in handling the frames.

I read several times in the American Bee Journal about people not knowing the difference between smartweed and heart's-ease. If they will take a leaf or two in the mouth and chew it, if it doesn't smart it's heart's-ease; if it isn't heart's-ease they will soon find out which of 'tother it is.

I have read and heard that a great many bees died the past winter and spring, and to hear the bee-keepers tell it, they say, "Yes, and they had a lot of honey, too. Now, what do you suppose caused them to die?" Well, I told them I didn't know. One man told me he had 5 colonies, and this spring, when the weather became warm, he examined them, and found that the honey was nearly all gone out of three hives, and the other two had quite a lot of honey, so he fed the first three. And just think! the two that had lots of honey died, and the other three he saved, he said. It happened that shortly after I went out to see this man and his bees. I found he had three nice, strong colonies, and in looking to the other two hives I found in one three frames, and in the other four frames that had quite a lot of capped honey. I took my knife and picked the capping off, which was tough and hard, and found the cells full of candied honey. Now, Doctor, don't you think if this man had fed the other two colonies as he did the first three, he would have saved them all? Glenwood, Nebr., June 22, 1895. J. C. K.

ANSWER.—Mr. Editor, here's a letter that I received more than six months ago. I got it on the way to the cars as I was leaving home, put it in a pocket of my sachel, and there it remained until now. I sincerely beg the pardon of Mr. Knoll and yourself, and I think I'll not consider it safe hereafter to put letters in a grip. Fortunately the present one is of such general interest that it has not spoiled by keeping.

The question as to whether those colonies would have been saved had the owner fed them, is one that I dare not answer. There are so many "if's" in the case. If the honey was in easy reach, for there are times when bees starve with plenty in the hive, and yet outside of the cluster. As a rule, I wouldn't expect a colony to starve if their honey was all candied, but there may have been something so exceptional in this case that feeding might have been their salvation.

Buying Two-Frame Nuclei.

I am a beginner in the bee-business. I bought one colony last spring, and have three at present. I intend to buy 10 more in the spring. Do you think it would be advisable to buy two-frame nuclei? A. C. P.

Leavenworth, Wash.

ANSWER.—That depends somewhat upon circumstances. If you can get bees near home, probably you will do best to get full colonies. If you can only get them from quite a distance, then it may be best to get the nuclei, for the expressage on a full colony would be too much.

Moving Bees—Honey from Sweet Clover—Carniolans vs. Italians.

As I am going to move my bees in the spring, I should like your advice on some things.

1. How do you fasten the screen over the entrance? Do you simply tack it on, or do you use strips of thin wood to hold it? How do you fasten the bottom-board, super and cover? or will I have to take the super off? I thought to leave it on with the chaff cushion, etc. Of course, I will move them before it gets warm. I have the dovetail hives.

2. Do you think the bees will store any surplus from sweet clover? It grows thick on the roadsides for three or four miles where I intend to have my bees. Does it take many acres to make any show in the hive?

3. Are Carniolan bees as good as Italians, as to work and gentleness? G. E. N.

Bishop Hill, Pa.

ANSWERS.—1. Late numbers of this paper will give you information on moving bees, and you will do well to read the article of J. R. Sease, on page 148. My hives are specially prepared, so that all I have to do is to slide a stopper of wire-cloth into saw kerfs of the deep, reversed bottom-board. Then the entrance is securely closed. You will see how Mr. Sease does it, by crowding a piece of coarse burlap into the entrance, and if the weather is cool enough that will answer all right.

If so warm that you want to use the wire-cloth, you can double a strip of wire-cloth, letting the stiff, doubled edge rest down on the bottom-board, and the upper part can be fastened against the front of the hive by a strip of wood nailed on. I fasten on my hive bottom-boards mostly by screws, the hives being specially prepared for this, but latterly I have used with great satisfaction what are called "tobacco staples," 1½ inches wide with legs ¾ inch long. Drive one of the points into the hive and the other into the bottom-board, using four staples, and you will find it will hold solid. Two more such staples hold the cover on. If you want to keep the supers on, you could use the same staples.

2. Of course, if there's enough sweet clover on the roadside the bees will store surplus from it. The editor spoke of some lately that I suspect was gathered from the roadside, and I wish he would find out all about it and tell us how much ground was perhaps occupied with sweet clover and how many colonies of bees worked on it to get that surplus. [We would kindly ask Mr. Armstrong (of whom we got the honey) to tell us "all about it," if he will kindly do so.—EDITORS.]

3. Some like Carniolans much, but in general the Italians seem to be the most popular. Carniolans are very gentle and great swarmers.

One-Frame Nucleus—Basswood Bloom.

1. Will a 1-frame nucleus make a fair colony? If not, how many will it take?

2. How old is basswood before it blooms? I am going to set out some in the spring, and would like to know.

Lakewood, N. J.

R. C. R.

ANSWERS.—1. A single frame nucleus may make a fair colony. Of course, it must have a fair start and a fair chance. If it is started early—say before the end of May—the frame well filled with brood mostly sealed, and an abundance of bees to cover the whole frame, the season good, and continuing late, you may have a fair colony before winter. But take an average frame of brood with adhering bees and you better have three of them, to feel sure of a fair colony by fall.

2. The age at which lindens bloom varies, and I don't know what ought to be the average at which a plantation ought to be expected to bloom, but at a guess I would set it somewhere about 10 years. If any one knows more definitely about it, I shall be glad to be corrected.

Keeping Two Queens in One Hive—Uniting—Keeping Down Increase.

1. Is there any known way to keep two queens in the same hive? I cannot get my queens to keep the hives full enough of bees to suit me, although I get from 50 to 75 pounds of surplus comb honey to the hive. I believe that if I could get two queens to work in the same hive, that I could get my hives so full of bees that I could double my surplus. I have young queens from Texas, Arkansas, Pennsylvania, Ohio and Illinois, but they seem to be but little improvement over the ones I rear. The best ones I have bought are from Texas; one of these queens swarmed early; I hived her on full combs of honey and full sheets of foundation; about six weeks afterward I was looking through the hive, and found a young queen on the same comb with the old queen, and on the same side of the comb within 4 inches of her, so she must have known of her presence; as I had a queenless colony at the time I introduced the young queen to that colony. Again in the fall I found another young queen in the same hive, which I removed and introduced to a black colony. I have since wished that I had not removed the last queen, but watched results; if they had both continued to work together I might have had a colony large enough to suit me. I shall watch that hive closely the coming season, and if I again find two queens I can tell what two will do.

2. I have several colonies of black bees in trees which I wish to remove before my young queens begin to fly. Can I unite the blacks with my Italians just before the main honey-flow? If so, how can I unite without the Italians killing the blacks? I have never yet been successful in uniting bees, but have lost several colonies in trying to unite them.

3. Not wishing to run more than 50 colonies, how can I keep down increase, as I do not wish any swarms to go to the timber? J. W. G.

Gazelle, Calif.

ANSWERS.—1. Occasionally two queens will be found in a hive working peacefully side by side, but as a rule they are mother and daughter, the mother being so near her end that

she soon disappears. It is doubtful whether there is any known way to have two queens laying permanently on the same combs. In England what is known as the Wells hive is used, and a good deal has been said about it. Practically, if I understand the matter rightly, it is a large hive with a perforated division-board through the center, the perforations being burned through, and not large enough to allow the passage of a worker. Perforated zinc over the top prevents the queens from going up, and there is a queen on each side. The workers of each side work peaceably together in the super. Some report good success with this hive, and others say they get better results by having the queens in two separate hives.

I have some doubts whether you would find any real advantage in it, even if you could get two queens to work permanently side by side. One trouble with the Wells hive is that when one side swarms the other side is likely to follow its example. Very large colonies of bees have been found with single queens, and it is just possible that the size of your hives has something to do with the number of bees present. If the hive is so small that the queen hasn't room enough to lay all she would, then you would have no more bees in that hive if 40 queens were present.

I might say in this connection that in several cases I have had two queens (mother and daughter) laying in the same hive at the same time, and I've left them so, but I never noticed that such a hive was filled with bees beyond the average.

2. Kill the black queen two or three days before uniting. Then dump them all (blacks and Italians) into the same hive, getting them all mixed up together, giving them some smoke, and half an hour later give them their combs. If any fighting is seen, smoke till they promise to behave.

3. If you keep your queens clipped, no prime swarms will go to the timber. When a swarm issues, hive the swarm on the old stand after first removing the old hive to a new stand. That will so weaken the old colony that a second swarm is not likely. But some say this is not always effective. It will be more effective if you set the old hive close beside the swarm, after hiving the swarm on the old stand, and then a week later move the old hive to a new stand. Then in the spring unite until you have the desired number.

Unusual Actions of a Queen.

Last summer I ordered a queen from an Ohio breeder. When she arrived I introduced her to a queenless colony, not very strong—it contained about 4 or 5 frames—and filled a 10-frame Langstroth hive about half full. The next morning, when I opened the hive, I found the bees hard at work trying to get her out, so I opened the cage and set it down on the bottom of the hive. The bees rushed right into the cage, and they kept on running in and out, and quite a number of the bees covered the bottom of the hive, standing with their heads down and fanning. After awhile the queen came out and ran in amongst the bees and commenced fanning like a worker-bee; she fanned there for about half a minute, and then ran toward the combs. Is this a common occurrence for queens? I have never seen one act that way.

F. B.

Searsboro, Iowa.

ANSWER.—A queen does not usually act in that way. She hardly ever moves her wings as you see her moving over the combs, even when she travels pretty rapidly, but sometimes when there is special cause for excitement she moves in a different way, making her wings go as if trying to fly, but hardly just like a worker ventilating. Still, they sometimes look a good bit like it.

Wants to Know if It is Sweet Clover.

I have seen so much about sweet clover that I should like to know if it is what we have. It is a biennial, and makes quite a growth the first year, but no blossoms. The next spring the roots look very much like a parsnip, a foot long, and one inch to an inch and half thick at the crown. I have pulled them up, and they will keep a long time out of the ground, the same as parsnips. We set out a row in the kitchen garden last spring, four feet apart; they made a very rapid growth, and blossomed early. They branched from the bottom, and every branch is a blossom, and as it grows it forms seeds, and the ends are blossoms. The branches are from two to three feet, and the main stalk is from five to six feet tall, and branches clear to the top.

I would as soon think of feeding my cow on a brush-pile. If cut for the cow it would have to be cut before it branched,

then it would be of no use to the bees. Our bees work on it early and late. It is covered in the fall with seeds and blossoms, and it takes a very hard frost to kill it. It will not grow here unless cultivated. Bee-keepers could make it pay to grow it for the seed if they had a market for it, as I should think it would yield a pint of seed to a root.

H. N. L.

South Warren, Maine.

ANSWER.—One cannot be certain from your description whether sweet clover is the plant you have or not. While the roots are quite large, one would hardly compare the roots to parsnips. If the plant will not grow without cultivation it can hardly be sweet clover. The fact that your cow will not eat it settles nothing one way or the other. Cattle will not eat sweet clover that are not used to it, neither will they eat alfalfa. Look on page 805 of this Journal for 1895, and the picture there given may help you to decide.

Italianizing—Foundation for Sections—Finding Black Queens.

I have a few colonies of bees and would like to Italianize them?

1. What time would you advise me to purchase my queens, and where?

2. I shall have to buy some foundation, and would like to have you tell me (by putting full sheets of foundation into each section) how many ought a pound to fill, using medium surplus foundation?

The principal honey-flow is in the spring.

3. What is a good way to find a black queen in the hive when I want to Italianize the colony?

C. S. W.

ANSWERS.—1. Perhaps you'll do well not to try to Italianize too early. You can't get queens very early without paying more for them, and it is not quite so easy to have a queen accepted kindly, and if you lose a queen early in the season the loss is more serious than later. Wait till June.

As to where to get queens, that belongs rather in the advertising columns than here. Other things being equal, it is better to get from breeders not too far away, although when queens are sent by mail it doesn't make such a great difference about distance. Now-a-days they are sent safely thousands of miles in the mails.

2. By "medium surplus" I suppose you mean what is classed in the trade as "thin." A pound of this will make full sheets for about 100 $4\frac{1}{2} \times 4\frac{1}{2}$ sections.

3. There is no short cut toward finding a queen. You've got to look till you find her. Don't use much smoke or you'll set the bees to running, and then it's very hard to find a queen. You'll be likely to find her on one of the combs that contain brood. If you don't find her after looking two or three times over the combs, the likelihood is that you'll not find her if you keep on for half an hour. But if you close the hive and come back in half an hour, you may find her then first thing.

Honey as Food and Medicine.—A new and revised edition of this 32-page pamphlet is now issued. It has 5 blank pages on which to write or paste recipes taken from other sources. It is just what its name indicates, and should be liberally distributed among the people everywhere to create a demand for honey. It contains a number of recipes on the use of honey as food and as medicine, besides much other interesting and valuable information. Prices, postpaid, are: Single copy, 5 cts.; 10 copies 35 cts.; 50 for \$1.25; 100 for \$2.00. Better give them a trial. Send all orders to the Bee Journal office.

Back Numbers.—We have on hand a few back numbers of the Bee Journal for 1895, which we will mail to any one wishing them at 15 copies for 20 cents. They will all be different dates, but we have no complete sets for the year. Just send us 20 cents in stamps or silver, and we'll send you 15 copies. No doubt there are many new subscribers who will be glad to take advantage of this offer.

The Alsike Clover Leaflet consists of 2 pages, with illustrations, showing the value of Alsike clover, and telling how to grow it. This Leaflet is just the thing to hand to every farmer in your neighborhood. Send to the Bee Journal office for a quantity of them, and see that they are distributed where they will do the most good. Prices, postpaid, are as follows: 50 for 25 cents; 100 for 40 cents; or 200 for 70 cents.

See "Bee-Keeper's Guide" offer on page 159.

THE OLDEST BEE PAPER IN AMERICA ESTABLISHED IN 1861

THE AMERICAN BEE JOURNAL

PUBLISHED WEEKLY BY

GEORGE W. YORK & COMPANY,

Editors and Proprietors,

56 Fifth Avenue, CHICAGO, ILL.

REGULAR CONTRIBUTORS:

G. M. Doolittle, of New York.

Prof. A. J. Cook, of California.

Dr. C. C. Miller, of Illinois.

Dr. J. P. H. Brown, of Georgia.

J. H. Martin, of California.

Rev. E. T. Abbott, of Missouri.

Chas. Dadant & Son, of Illinois.

\$1.00 a Year—Sample Copy Sent Free.

[Entered at the Post-Office at Chicago as Second-Class Mail-Matter.]

Vol. XXXVI. CHICAGO, ILL., MAR. 5, 1896. No. 10.

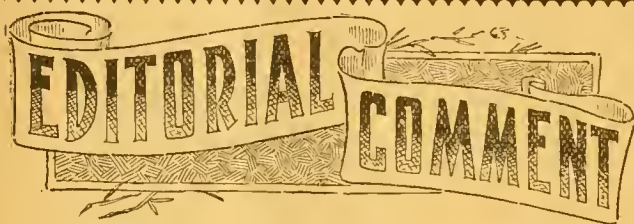

Selling Bogus Honey.—Mr. J. C. Stewart, of Hopkins, Mo., writes us that there are two young men traveling in Iowa, claiming to live in Osceola and Davenport, selling honey in pails. They buy sugar, melt it, and stir in some comb honey. They have sold in Creston and farther west, to Mr. Stewart's knowledge. He says bee-keepers may publish the two frauds, using his name, if they wish. Pass it along.

That Missouri Agricultural Report.—We referred to this Report on page 121, and intimated that Rev. E. T. Abbott had something to do with the apicultural part of it. Since then we have learned that Mr. Abbott prepared all of the matter in it about bees ready for the press, besides writing all the introduction and comments on the apiarian essays. He also wrote the essay on page 213, on "Poultry on the Farm," but for some unaccountable reason he was not given credit for any of it. When a man furnishes 34 pages of such matter—all of which it took no little time to prepare, and that without pay—it would seem that he should have some credit for it. Missouri bee-keepers are under obligation to Mr. Abbott for his efforts to advance the interests of bee-culture in their good State.

The Benton Bee-Book.—Mr. M. M. Baldrige, of St. Charles, Ill., says of this book, recently issued by the U. S. Department of Agriculture:

In many respects it is a good book for general distribution, but it should be sent out free by the Agricultural Department, and there should be as many copies printed as the demand calls for, no matter whether it be 5,000 or 500,000. I shall do what I can to have this done. I shall remind the Representative of my Congressional District that I want a free copy, and that I know of a host of others who would also like to get one. It is a disgrace that the Agricultural Department should be permitted or compelled to charge for any of the publications emanating therefrom.

M. M. BALDRIDGE.

In the same envelope with the above, Mr. B. enclosed the following item, taken from the Chicago Tribune, thinking it might afford a little amusement for our readers:

MAY GATHER HONEY ALL THE NIGHT.

Morton the Butt of the Wits in the House.

Washington, D. C., Feb. 15.—[Special.]—Members of Congress are having lots of fun nowadays with Secretary Morton. Whenever business is dull in either House or Senate somebody is sure to start the racket over the Secretary's defiance of the law in the matter of the distribution of seeds. The Department of Agriculture has been made a target for all the wits in the House, for it

contains a number of scientific departments which are not generally supposed to be of a vast amount of benefit to practical farmers, and when Secretary Morton abolished the seed distribution he took the rooms that were occupied by that bureau for the divisions of ethnology, ornithology and mammalogy. When the House struck its favorite subject to-day Mr. Quigg made a few pertinent remarks about the Department having gone into the publishing business, and instanced a book on the honey-bee, which he said contained nothing new.

This started up Col. Hepburn, of Iowa, who, with a serious face, inquired whether any of the members of the committee could inform the House if it were true, as had been rumored, that the Department of Agriculture was making important experiments to see whether or not it would be possible to cross the honey-bee with the lightning-bug, so that the busy bee would be able to flit from flower to flower and store away honey as well after dark as in the broad glare of the sun.

We believe it would be a good idea if each Congressman could be presented with a copy of Mr. Benton's book, and read it carefully! While there may be "nothing new" in it for the expert bee-keeper, the average Congressman would be surprised at the wonders it would reveal to him.

Judging Honey.—It is probably a mistake to suppose that a man who is well informed otherwise on the subject of bee-keeping is necessarily a good judge of honey. No matter how successful a man may be, if he has for years kept his colonies by the hundred and marketed his honey by tons, if his surplus crop has always been from only one source he is no judge of honey obtained from other sources. Not a great while ago a man who is considered quite an authority in bee-keeping was handed a sample of beautiful sweet clover honey, known to be pure. On being asked what he thought of it, he tasted it and replied he thought the larger part of it might be glucose. It was simply a flavor with which he was not familiar, and he was not competent to judge. Very likely the best judges as to kinds and qualities of honey are the men who have handled it for years from many different sources, such as the veteran Chas. F. Muth. A dealer who handles comb honey exclusively would not be as good a judge as one who handles principally extracted honey. Comb honey goes mostly on its looks, extracted by its taste.

Alfalfa Honey Candying.—The following, which we take from a private letter dated Feb. 4, touches on the subject of the candying of alfalfa honey:

In a recent article in *Gleanings*, a Mr. Fish made the statement that "Utah comb honey candies quickly"—which of course means Colorado honey, too. I venture to say that if alfalfa comb honey is treated rightly, it will candy little sooner than white clover honey.

The first year I kept bees, 60 pounds of comb honey were kept upstairs in the house, and it did not candy at all, though it was not all used up until late the following spring. I have had unfinished sections which were about two-thirds candied in April or May. But they were kept in a box resting on the ground. Of course, comb honey is not always treated rightly in any State. I have seen four or five hundred pounds in a commission house which was partially candied in January. But to say alfalfa comb honey candies quickly is misleading.

We had supposed that alfalfa honey—particularly the extracted—would candy or granulate much more quickly than most other honey. At least we thought that had been our experience, but we shall be glad to know that we were mistaken. It may be that if the same care is taken with alfalfa comb honey, it will candy no sooner than other comb honey. We should be glad to have an expression on this matter from any one who feels competent to speak thereon. We would not desire to injure the sale of alfalfa honey by saying that it candies more quickly than other honeys, if such is not the fact. Alfalfa is one of our favorite honeys, and we would like to get at all the truth regarding it.

The Amalgamation of the North American Bee-Keepers' Association, and the National Bee-Keepers' Union seems to be "hanging fire." So far, about all the communicative we have received concerning it have been against the amalgamation idea. Those who are in favor of it seem to keep very still about it. Possibly many do not care a tinker's dime, one way or the other. If such be the case, we feel it must be on account of not understanding the objects to be gained by amalgamation.

So far as we are personally concerned, it makes but little difference whether there is any amalgamation or not, but we do be-

lieve that if the two existing societies were united, it would mean a grander organization than either of them is now. If "In union there is strength," it seems it would apply most beautifully in this instance.

Unless there is an amalgamation, and a broadening out of the usefulness of the Bee-Keepers' Union, we feel almost certain there never can be a large membership; and without a good-sized membership very little can be done in the line of securing the legislation that the industry of bee-keeping needs so badly. If an organization composed of some 10,000 live members were to present a petition to any State legislature, think you they would receive a cold shoulder? Or, if they were to ask something reasonable and evidently needful, from the hands of the United States Congress, think you they would not be heard? We firmly believe that if American bee-keepers were fully organized, and alive to their own best interests, they would receive more justice than they have been in the habit of getting.

In conclusion we would say, that so long as the present good objects of the Bee-Keepers' Union are not in the least interfered with, but are to be incorporated into the constitution of the proposed new society, we cannot understand *why* any one should oppose the amalgamation.

Free Analysis of Drinking-Water.—The department of chemistry of the University of Illinois, at Champaign, has been engaged during the year on the analysis of drinking-waters. The last Legislature made an especial appropriation for this purpose, and the work is being carried on very thoroughly and systematically. Already over 500 analyses have been made by the department. The only expense to the individual is the actual cost of expressage. Purity of drinking-water is so important to the health of a community that the water in every well in general use should be carefully examined at least once a year.

An Event in London, says a "stray straw" in Gleanings, was a presentation, to the Lady Mayoress, of a representative collection of native honey, contributed by women bee-keepers, or the wives and daughters of bee-men in various parts of Great Britain. Object, to popularize the use of British honey "as an essential article of the household dietary." Might do that here, but who would be the Lady Mayoress? If she of New York were selected, there might be trouble with Mrs. Swift, of Chicago.

Impurities on the bottom of a beeswax-cake can be more easily scraped off while the cake is still hot. So says the British Bee Journal.



Future of Bee-Keeping.

Of all the humbings palmed off on a susceptible and long-suffering public the glucose syrups and candies made of the same material—or a cheaper and more inferior—are the worst. Another reason why honey is not so generally used as formerly is the common belief that it is adulterated.

And there is no use to deny the fact. I frequently see in grocery stores an article offered for sale as extracted honey which has all the outward appearance and internal evidence of being "made" in a laboratory very much larger than a bee's stomach. Consumers buy this stuff, but its use doesn't popularize honey.

Right here let me digress far enough to say that in my opinion the invention of the extractor was the worst *improvement* (?) that ever happened to this industry. With the advent of the extractor began the necessity for the bee-keeper to defend the purity of his product. If the article is to be produced hereafter in the same generous quantities as formerly there is a rich field for the labors of the Bee-Keepers' Union.

Legislation must be procured in the interest of pure food. Every offender must be prosecuted to the full extent of the law. There is no use of trying to produce honest honey in competition with syrup made of 15-cent corn.

Perhaps you think my liver is disordered, and you may ask if there is no bright side to the picture.

To convince you that I am no pessimist I have the following prescription to offer in addition to the above suggestion regarding legislation:

1st. Produce only comb honey, and put it up in such "taking" packages that it will find its way onto the tables of those who can afford to pay for *luxuries*. That's what comb honey is and always will be.

2nd. Encourage small bee-keepers (the adjective has reference to numbers of colonies).—Hon. Eugene Secor, in Review.

Currants Preserved in Extracted Honey.

Considerable quantities of white currants preserved in extracted honey have been imported lately from France, and are selling freely, at long prices, to dealers in fancy groceries. A glass containing hardly a gill retails at 25 cents. Evidently only the best selected white currants are used, slightly cooked—just enough to take off the raw taste but not injure the fine flavor—and preserved in nice extracted honey. This confection is not too sweet, but has the most captivating flavor, and is destined to wide popularity. Here's a point for some one to make a profitable little business putting up such preserves for market.—American Agriculturist.

Does the Food Affect the Temper of Bees?

It is a mooted question among bee-keepers, as to whether the food which is given to the larvæ of a colony determines their character; or, in other words, whether the larvæ from a gentle queen, when placed in and fed by a vicious colony, will become less gentle, and *vice versa*, Mr. Bertrand formerly believed in this kind of so-called "heredity," but he takes it all back now, after experimenting in this line with his gray Caucasian queen. He selected a very bad and vindictive colony of his, killed their queen, and replaced her by the Caucasian queen on Aug. 24, 1894. She laid splendidly, and her colony was the strongest and most advanced of all in April, 1895. And her bees? well, they were remarkably gentle; and, although Mr. Bertrand never used any smoke or veil when he worked with them, yet he never received a solitary sting from them. The experiment, of course, is only a single instance, and "one swallow does not make a summer;" yet Mr. Bertrand's prior opinion is thoroughly shaken by it. The force of the argument, I might add, is increased by the fact that these foreign races, when transferred to other countries, often *lose* their gentleness. The Egyptian bee, for instance, hardly ever uses its sting "at home," while, when taken to Europe, it becomes very bad (Revne, page 211).—CHARLES NORMAN, in Gleanings.

Getting Others Into Bee-Keeping.

J. D. Evans, Islington.—I would like to know if it is advisable for the Bee-Keepers' Association to encourage an increase in the number of bee-keepers. I notice in the journals that a large quantity of honey is being wasted, and I want to know if we as bee-keepers, who desire to make something out of the business, should desire to increase the number in the profession.

The Chairman—What do you think about it yourself?

Mr. Evans—I do not think so. I do not think the doctors and lawyers go around seeking to get more in their profession. It makes me red-hot when I see this. I think it is simply committing suicide, and therefore think it is a mistake on our part to encourage other people to leave any business and take up bee-keeping.

Mr. Frith—I think there is another feature of the question—Can we produce, or over-produce, a good quality of honey, and can we have too many qualified progressive bee-keepers? Take the dairy industry; butter brings just as much to-day as it did 25 years ago, that is, taking it for a number of years. Take the cheese industry; very little was produced in this country 25 years ago, and it didn't bring any better price than it does to-day, yet the production of cheese has increased 100 per cent. in this country. It seems to me Mr. Evans is mistaken in his remarks, and there is room for qualified bee-keepers all over the country. My experience leads me to this conclusion, that if we have qualified bee-keepers just the same as in any other industry, it will increase our market rather than overdo it.—Ontario Convention Report, in Canadian Bee Journal.

Book Premiums for Getting New Subscribers

For each New Subscriber to the American Bee Journal sent us by a present subscriber, we will give as a Premium **40 cents' worth** of the Books, Pamphlets, etc., described on this page—figuring on the **retail price** given in connection with each book, etc., below. This is a very easy way to get a lot of most excellent literature.

Free Copy of "BEES AND HONEY" to Every New Subscriber.

Yes, in addition to the above offer, we will mail free a copy of Newman's 160-page "Bees and Honey"—premium edition—to each new subscriber. **NOW IS JUST THE TIME** to work for big lists of New Subscribers.

The American Bee Journal List Should Easily Be **DOUBLED** on these Liberal Offers.

BEE-BOOKS

SENT POSTPAID BY

George W. York & Co.,
Chicago, Ills.

Bees and Honey, or Management of an Apiary for Pleasure and Profit, by Thomas G. Newman.—This edition has been largely re-written, thoroughly revised, and is "fully up with the times" in all the improvements and inventions in this rapidly-developing pursuit, and presents the apiarist with everything that can aid in the successful management of an apiary, and at the same time produce the most honey in an attractive condition. It contains 250 pages, and 245 illustrations—is beautifully printed in the highest style of the art, and bound in cloth, gold-lettered. Price, \$1.00.

Langstroth on the Honey-Bee, revised by Dadant.—This classic in bee-culture, has been entirely re-written, and is fully illustrated. It treats of everything relating to bees and bee-keeping. No apiarist's library is complete without this standard work by Rev. L. L. Langstroth—the Father of American Bee-Culture. It has 520 pages; bound in cloth. Price, postpaid, \$1.25.

Bee-Keepers' Guide, or Manual of the Apiary, by Prof. A. J. Cook, of the Michigan Agricultural College.—This book is not only instructive and helpful as a guide in bee-keeping, but is interesting and thoroughly practical and scientific. It contains a full delineation of the anatomy and physiology of bees. 400 pages; bound in cloth and fully illustrated. Price, postpaid, \$1.25.

Scientific Queen-Rearing, as Practically Applied, by G. M. Doolittle.—A method by which the very best of Queen-Bees are reared in perfect accord with Nature's way. 176 pages, bound in cloth, and illustrated. Price, \$1.00.

A B C of Bee-Culture, by A. I. Root.—A cyclopedia of 400 pages, describing everything pertaining to the care of the honey-bees. It contains 300 engravings. It was written especially for beginners. Bound in cloth. Price, \$1.25.

Advanced Bee-Culture, Its Methods and Management, by W. Z. Hutchinson.—The author of this work is too well known to need further description of his book. He is a practical and entertaining writer. You should read his book. 90 pages, bound in paper, and illustrated. Price, 50 cts.

Rational Bee-Keeping, by Dr. John Dzierzon.—This is a translation of his latest German book on bee-culture. It has 350 pages; bound in cloth, \$1.25; in paper covers, \$1.00.

Bienen-Kultur, by Thomas G. Newman.—This is a German translation of the principal portion of the book called BEES OF HONEY. 10-page pamphlet. Price, 40 cents.

Convention Hand-Book, for Bee-Keepers. Thomas G. Newman.—It contains the parliamentary law and rules of order for Bee-Conventions—also Constitution and By-Laws, with subjects for discussion, etc. Cloth, gold-lettered. Price, 25 cts.

Amerikanische Bienenzucht, by Hans Buschbauer.—Printed in German. A hand-book on bee-keeping, giving the methods in use by the best American and German apiarists. Illustrated; 138 pages. Price, \$1.00.

Thirty Years Among the Bees, by Henry Alley.—Gives the results of over a quarter-century's experience in rearing queen-bees. Very latest work of the kind. Nearly 100 pages. Price, 50c.

Why Eat Honey?—This Leaflet is intended for FREE distribution, to create a Local Market. 100 copies, by mail, 40 cts.; 500 for \$1.50; 1000, \$2.50. If 500 or more are ordered at one time, your name and address will be printed on them FREE.

How to Keep Honey and preserve its richness and flavor. Price same as Why Eat Honey.

Apiary Register, by Thos. G. Newman.—Devotes two pages to a colony. Leather binding. Price, for 50 colonies, \$1.00; for 100 colonies, \$1.25.

Preparation of Honey for the Market, including the production and care of comb and extracted honey. A chapter from BEES AND HONEY. Price, 10 cents.

Bee-Pasturage a Necessity.—This book suggests what and how to plan. It is a chapter from BEES AND HONEY. Price, 10 cents.

The Hive I Use, by G. M. Doolittle. It details his management of bees, and methods of producing comb honey. Price, 5 cents.

Dr. Howard's Book on Foul Brood.—Gives the McEvoy Treatment and reviews the experiments of others. Price, 25 cts.

Dictionary of Apiculture, by Prof. John Phin. Gives the correct meaning of nearly 500 apicultural terms. Price, 50 cts.

Winter Problem in Bee-Keeping, by G. R. Pierce. Result of 25 years' experience. 50 cts.

Handling Bees, by Chas. Dadant & Son.—A Chapter from Langstroth Revised. Price, 8 cts.

Bee-Keepers' Directory, by H. Alley.—Latest methods in Queen-Rearing, etc. Price, 50c.

Foul Brood Treatment, by Prof. F. R. Cheshire.—Its Cause and Prevention. Price, 10 cts.

Foul Brood, by A. R. Kohnke.—Origin, Development and Cure. Price, 25 cts.

History of Bee-Associations, and Brief Reports of the first 20 conventions. Price, 15 cts.

Honey as Food and Medicine, by T. G. Newman.—A 32-page pamphlet: just the thing to create a demand for honey at home. Should be scattered freely. Contains recipes for Honey-Cakes, Cookies, Puddings, Foam, Wines, and uses of honey for medicine. Prices, prepaid—Single copy, 5 cts.; 10 copies, 35 cts.; 50 for \$1.50; 100 for \$2.50; 250 for \$5.50; 500 for \$10.00; or 1000 for \$15.00. When 250 or more are ordered, we will print the bee-keeper's card (free of cost) on the front cover page.

Bee-Keeping for Profit, by Dr. G. L. Tinker.—Revised and enlarged. It details the author's new system, or how to get the largest yields of comb or extracted honey. 80 p.; illustrated, 25c.

Emerson Binders, made especially for the BEE JOURNAL, are convenient for preserving each number as fast as received. Not available to Canada. Price, 75 cts.

Commercial Calculator, by C. Ropp.—A ready Calculator, Business Arithmetic and Account-Book combined in one. Every farmer and business man should have it. No. 1, bound in water proof leatherette, calf finish. Price, 40 cts. No. 2, in the artificial leather, with pocket, silicate slate, and account-book. Price, 60 cts.

Green's Four Books, by Chas. A. Green.—Devoted to, 1st, How We Made the Old Farm Pay; 2nd, Peach Culture; 3rd, How to Propagate Fruit-Plants, Vines and Trees; 4th, General Fruit Instructor. Nearly 120 pages. Fully illustrated. 25 cts.

Green's Six Books on Fruit-Culture, by Chas. A. Green.—Devoted 1st, to Apple and Pear Culture; 2nd, Plum and Cherry Culture; 3rd, Raspberry and Blackberry Culture; 4th, Grape Culture; 5th, Strawberry Culture. 129 pp.; illustrated. 25 cts.

Garden and Orchard, by Chas. A. Green.—Gives full instructions in Thinning and Marketing Fruits; Pruning, Planting and Cultivating; Spraying, Evaporation, Cold Storage, Etc. 94 pages, illustrated. Price, 25 cts.

Kendall's Horse-Book.—35 pictures, showing positions of sick horses, and treats on all their diseases. English or German. Price, 25 cts.

Silo and Silage, by Prof. A. J. Cook.—It gives the method in operation at the Michigan Agricultural College. Price, 25 cts.

Lumber and Log-Book.—Gives measurements of lumber, logs, planks; wages, etc. 25c.

Maple Sugar and the Sugar Bush, by Prof. A. J. Cook.—Full instructions. Price, 35 cts.

Grain Tables, for casting up the price of grain, produce, hay, etc. Price, 25 cts.

Capons and Caponizing, by Dr. Sawyer's Fanny Field, and others.—Illustrated. All about caponizing fowls, and thus how to make the most money in poultry-raising. 64 pages. Price, 30 cts.

Our Poultry Doctor, or Health in the Poultry Yard and How to Cure Sick Fowls, by Fanny Field.—Everything about Poultry Diseases and their Cure. 64 pages. Price, 30 cts.

Poultry for Market and Poultry for Profit, by Fanny Field.—Tells everything about the Poultry Business. 64 pages. Price, 25 cts.

Turkeys for Market and Turkeys for Profit, by Fanny Field.—All about Turkey-Raising. 64 pages. Price, 25 cts.

Rural Life.—Bees, Poultry, Fruits, Vegetables, and Household Matters, 100 pages. 25 cts.

Strawberry Culture, by T. B. Terry and A. I. Root. For beginners. Price, 40 cts.

Potato Culture, by T. B. Terry.—It tells how to grow them profitably. Price, 40 cts.

Carp Culture, by A. I. Root and Geo. Finley.—Full directions. 70 pages. Price, 40 cts.

Hand-Book of Health, by Dr. Foote.—Hints about eating, drinking, etc. Price, 25 cts.

Alsike Clover Leaflet.—Full directions for growing. 50 for 25 cts.; 100 for 40 cts.; 200, 70c.

Book Clubbing Offers.

(Read Carefully.)

The following clubbing prices include the American Bee Journal one year with each book named. Remember, that only ONE book can be taken in each case with the Bee Journal a year at the prices named. If more books are wanted see postpaid prices given with the description of the books on this page. Following is the clubbing-list:

1. Langstroth on the Honey-Bee.....	\$2.00
2. A B C of Bee-Culture.....	2.00
3. Bee-Keepers' Guide.....	1.75
4. Bees and Honey [Cloth bound].....	1.65
5. Scientific Queen-Rearing.....	1.75
6. Dr. Howard's Foul Brood Book.....	1.10
7. Advanced Bee-Culture.....	1.30
8. Amerikanische Bienenzucht [Germ.].....	1.75
9. Bienen-Kultur [German].....	1.25
10. Rational Bee-Keeping [Cloth bound].....	2.00
11. Rational Bee-Keeping [Paper bound].....	1.75
12. Thirty Years Among the Bees.....	1.30
13. Bee-Keeping for Profit.....	1.15
14. Convention Hand-Book.....	1.15
15. Poultry for Market and Profit.....	1.10
16. Turkeys for Market and Profit.....	1.10
17. Capons and Caponizing.....	1.10
18. Our Poultry Doctor.....	1.10
19. Green's Four Books.....	1.15
20. Green's Six Books on Fruit-Culture.....	1.15
21. Garden and Orchard.....	1.15
22. Rural Life.....	1.10
23. Emerson Binder for the Bee Journal.....	1.60
24. Commercial Calculator, No. 1.....	1.25
25. Commercial Calculator, No. 2.....	1.40
26. Kendall's Horse-Book.....	1.10
27. Strawberry Culture.....	1.20
28. Potato Culture.....	1.20
31. Carp Culture.....	1.20
32. Hand-Book of Health.....	1.10
33. Dictionary of Apiculture.....	1.35
34. Maple Sugar and the Sugar Bush.....	1.20
35. Silo and Silage.....	1.10
36. Winter Problem in Bee-Keeping.....	1.30
37. Apiary Register (for 50 colonies).....	1.75
38. Apiary Register (for 100 colonies).....	2.00
39. Bee-Keepers' Directory.....	1.30

Please Send Us the Names of your neighbors who keep bees, and we will send them sample copies of the BEE JOURNAL. Then please call upon them and get them to subscribe with you, and secure some of the premiums we offer.

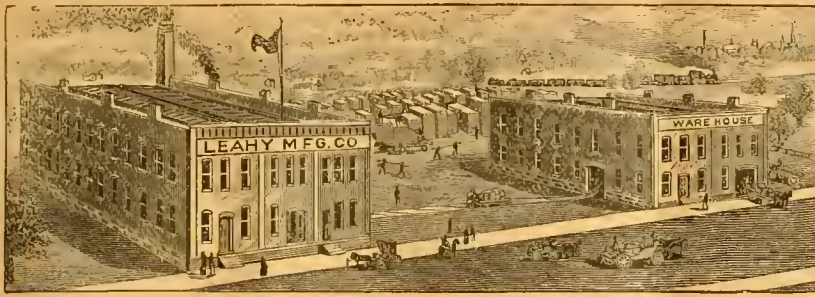

General Items.

Outlook Good for 1896.

We had a good honey crop in 1895, and the outlook is now good for 1896. We are in the centre here of oceans of sweet clover—the saving clause for honey-producers as long as the present drouthy conditions exist in this part of Illinois.

D. L. DURHAM,
Kankakee, Ill., Feb. 1.

Look for a Good Honey Crop.

I consider the Bee Journal worth 10 times the price to any enterprising bee-keeper. Bees are gathering pollen now with a great rush. We are looking for a good honey crop, as everything seems right for it.

W. S. DOUGLASS,
Lexington, Tex., Feb. 2.

A California Report for 1895.

From my 72 colonies, spring count, I secured 6,500 pounds of fine section honey and 400 pounds of extracted. I held back all but 10 swarms, and sold 9 of them at once. I sold 6,400 pounds of comb honey at 10 cents, and got this price because I took extra pains in casing up as well as getting it from the hives as soon as completed, to avoid travel-stain.

G. K. HUBBARD,
Riverside, Calif.

An Engineer Bee-Keeper.

I like the Bee Journal very much, and have derived a great amount of information from its columns. I have kept bees for only one year, and keep them for pleasure and profit combined. I am employed by the railroad company as an engineer, and just devote my spare time to the bees. From 5 colonies in the spring they increased to 9, and gave me 200 pounds of surplus honey. It was a poor season on account of the dry weather.

Conemaugh, Pa. Wm. Wright, Jr.

Antitoxine—Electrical Rays.

I always rejoice in concurring with all practical means for the relief or cure of human ailments, but the public is now and then led to hope in methods or appliances not yet established by that only true gauge of success—Experience. Hence, I advise no serious expectation from the use of the now vaunted "Antitoxine" that is being urged as the great remedy for all infectious and mortal diseases, recognizing the fact that, so far, its failures have more than kept pace with reported success.

Nor need you, as yet, go into ecstasy over the recent electrical rays and vibrators that are expected to revolutionize all treatments. I will hail their success—when it comes.

DR. PEIRO,
100 State St., Chicago, Ill.

Southern East Tennessee Convention.

The Southern East Tennessee Bee-keepers' Association held its special session at Cookson's Creek, Jan. 11, with Pres. M. T. Fouts in the chair. Owing to inclemency of weather the meeting was lightly attended. After the usual routine of business, the membership proceeded to make their 1895 report, which showed an average increase of 90 per cent., the average surplus per colony, spring count, 24 pounds, highest 72 pounds, lowest 16 pounds. All agreed that the heavy rains during our main honey-flow detracted much from surplus reports.

I had been conducting an experiment to ascertain the amount of stores necessary for wintering in this locality, which shows for the 45 days ending Jan. 11, 1896, in my apiary there was an average consumption

Largest Factory in the West COMPLETE STOCK. Good Supplies and Low Prices Our Motto.

READ THIS—Mr. Keyes says: The 100 pounds of Extra-Thin Foundation you sent us' is superior to anything he ever saw; and I think the same. R. L. TUCKER, Wewahitchka, Fla.
Dear Sirs:—The Sections came duly to hand. Indeed, they are very nice. Yes, sir; they are as good as the best. CHARLES H. THIES, Steelville, Illinois.
Leahy Mfg. Co.:—I have received the bill of goods. I must say they are the choicest lot of Hive-Stuff I have ever received from any place. I admire the smoothness of your work, and your close selection of lumber. Yours very truly, O. K. OLMSTEAD, Orleans, Nebr.
Dear Sirs:—The Sections arrived in due time, and are all O. K. so far as examined. They are simply perfection. I can't see how you can furnish such goods at such low prices. I hope you may live long and do well. Yours respectfully, Z. S. WEAVER, Courtney, Tex.
Gents:—I received the "Higginsville Smoker" all O. K. It's a dandy; please find enclosed stamps for another. Yours truly, OTTO ENDERS, Oswegatche, N. Y.
Gentlemen:—I have bought Supplies from nearly all the large manufacturers by the carload, and I must say yours are as good as the best. Indeed, in many lines they are the best. It is a pleasure to handle them. E. T. FLANAGAN, Belleville, Illinois.
The above unsolicited testimonials are a fair sample of hundreds we receive. Our prices are reasonable and the "Higginsville Goods" are the best.
The "Higginsville" Goods are for sale by the following parties:
Chas. H. Thies, Steelville, Ill. E. T. Flanagan, Belleville, Ill.
Henry L. Miller, Topeka, Kans. E. A. Seeley, Bloomer, Arkansas.
J. W. Rouse & Co., Mexico, Mo. P. J. Thomas, Fredonia, Kans.
And by a number of others.
If you need a Carload of Supplies, or only a Bee-Smoker, write to us. Remember, we are here to serve you, and will, if you give us a chance. **A Beautiful Catalogue Free.**
Address, **LEAHY MANUFACTURING CO., HIGGINSVILLE, MO.**
49A *Mention the American Bee Journal.*

Honey-Clovers & Buckwheat SEED FOR SALE.

We have made arrangements so that we can furnish seed of several of the Clovers and Japanese Buckwheat, by freight or express, at the following prices, cash with order:

	10lb	50lb	100lb
Alsike Clover Seed.....	\$1.35	\$ 6.25	\$12.00
Sweet Clover Seed.....	1.50	6.50	12.00
White Clover Seed.....	2.40	11.35	22.00
Alfalfa Clover Seed.....	1.20	5.25	10.00
Crimson Clover Seed....	1.00	4.00	7.00
Jap. Buckwheat Seed....	.45	1.50	2.20

Prices subject to market changes.
The above prices include a good, new two-bushel bag with each order.
Your orders are solicited.
GEORGE W. YORK & CO.,
CHICAGO, ILLS.

ONE MAN WITH THE UNION COMBINATION SAW
Can do the work of four men using hand tools, in Ripping, Cutting-off, Mitting, Rabbeting, Grooving, Gaining, Dadoing, Edging-up, Jointing Stuff, etc. Full Line of Foot and Hand Power Machinery Sold on Trial. Catalogue Free.
SENECA FALLS MFG. CO.,
46 Water St., SENECA FALLS, N. Y.
1Aly *Mention the American Bee Journal.*

DON'T!

Buy Bees or Supplies until you have sent to us for special prices on what you need. The Goods and Prices "are right."
Our '96 Circular now ready.
I. J. STRINGHAM,
105 Park Place. NEW YORK, N. Y.

CLOSING OUT SALE!

We have at this Branch among the Stock purchased of Thos. G Newman the following stock of Sections—not of our manufacture—which we desire to close out to make room for our **Superior Extra Polished Sections.**
In order to close them out quickly we offer them for the next 60 days, or while they last, at these special prices:
White Sections, 1 1/4 x 4 1/4.
40,500 7-to-ft. at these low prices—1,000 for \$1.75; 2,000 for \$3.00; 5,000 for \$7.00
TRIANGULAR-TOP FRAMES.
We also have a stock of Triangular Top Langstroth Frames at these Special prices:
100 for \$1.00; 300, \$2.70; 500, \$4.00; 1000, \$7.00.
On all freight orders of \$5 or less, at this Branch, please add 25c. for cartage. Catalogue Free.
The A. I. Root Co., 56 5th Ave., Chicago, Ill.

MUTH'S HONEY EXTRACTOR
PERFECTION
Cold-Blast Smokers,
Square Glass Honey Jars, Etc.
For Circulars, apply to CHAS. F. MUTH & SON.
Cor. Freeman & Central Aves., Cluinnati, O.
Send 10c for Practical Hints to Bee-Keepers.

HATCH Chickens BY STEAM—
With the MODEL
EXCELSIOR Incubator
Simple, Perfect, Self-Regulating. Thousands in successful operation. Lowest priced first-class Hatcher made.
GEO. H. STAHL,
114 to 122 S. 6th St. Quincy, Ill.

BIG BARGAINS IN ROSES, PLANTS, AND SEEDS

Our GRAND SET of 13 Elegant Ever-blooming ROSES for only 50 Cts. by mail, post-paid, safe arrival and satisfaction guaranteed.

These roses are fine healthy plants and will bloom all this Summer in pots or planted out. We guarantee them to be by far the best 50 cts. you ever invested in roses, as follows:

Kaiserin Augusta Victoria.—(New.) Pure White elegant. **Grace Darling.**—Silvery, Peach a beauty. **Clothilde Souper.**—This is everybodys favorite. **Bridesmaid.**—the most charming Pink Rose. **Pearl of the Gardens.**—Deep Golden Yellow. **Sunset.**—Beautiful shades of Copper and Gold. **Scarlet Bedder.**—the richest and brightest of all Red Roses. **Franciska Kruger.**—yellow flushed pink charming color. **Mad. Waterloo.**—the famous Tulip Rose. **Rheingold.**—deep Citron and Gold, a remarkable color. **Mad. Welche.** Amber Yellow, deepening toward the center. **Mad. Hoste.**—A Pure Snow White, none better. **Duchess de Brabant.**—Amber Rose, delicately tinged apricot.

What You Can Buy for 50 Cents.

- | | |
|--|---|
| Set 34—13 Ever-blooming Roses all different. . . 50 c. | Set 42—20 Large Flowered Pansy Plants. . . 50 c. |
| * 35—12 Fragrant Carnation Pinks, 12 kinds, 50 c. | * 43—15 Coleus, will make a bright bed. . . 50 c. |
| * 36—8 Lovely Flowering Begonias, all sorts, 50 c. | * 44—12 Double and Single Fuchsias, all colors 50 c. |
| * 37—13 Geraniums, all colors and kinds, . . 50 c. | * 45—6 Choice Hardy Shrubs, 6 sorts, . . . 50 c. |
| * 38—15 Choice Prize Chrysanthemums, . . 50 c. | * 46—30 Pkts Flower Seeds, no two alike. . . 50 c. |
| * 39—4 Choice Decorative Palms, try them, . 50 c. | * 47—20 Pkt's elegant Sweet Peas, all different 50 c. |
| * 40—5 Dwarf French Cannas, 5 kinds, . . . 50 c. | * 48—18 Pkt's Choice Vegetable Seeds 18 sorts 50 c. |
| * 41—12 Sweet Scented Double Tube Roses, . 50 c. | |

You may select half of any two sets for 50 cents, or 3 complete sets for \$1.25, any 5 sets for \$2.00, the entire 15 sets for \$5.00, or half of each set for \$2.50. Get your neighbor to club with you. Our catalogue free. **ORDER TO-DAY.** We will hold the plants and ship them any time you may desire. Address,

36E13t THE GREAT WESTERN PLANT CO., Springfield, Ohio.

St. Joe

Is the name of the Hive you want. **PRICE-LIST** now ready. Send stamp and get valuable paper on **WINTERING BEES.**

GOLDEN WYANDOTTE Eggs from fine birds only \$1.00 for 13.

EMERSON T. ABBOTT, St. Joseph, Mo.

PLANTS AND TREES AT FIRST COST.

PLEASANT VALLEY NURSERIES, ARTHUR J. COLLINS, Moorestown, N. J.

250,000 Peach Trees



100,000 Plum, best European and Japan.
150,000 Pear, Standard and Dwarf.
75,000 Cherry, Morellos, Hearts, etc.
150,000 Apple, Quince, Apricot.
100,000 Nut Bearing Trees.
2,000,000 Small Fruits and Grapes.
750,000 Roses, Everblooming and Hardy.

1,000 Car Loads Ornamentals.

Full supply Flower and Vegetable Seeds, Plants, Bulbs, etc. Elegant 168 page catalogue free. Send for it before buying. Everything mail size post-paid. Larger by express or freight. Safe arrival and satisfaction guaranteed. We occupy 1 1/2 miles on the bank of Lake Erie. No harder, healthier trees are grown on the continent. Why not procure the best direct from the grower and avoid all commissions. It will save you money.

42nd YEAR. 1000 ACRES. 29 GREENHOUSES.
THE STORRS & HARRISON CO., Painesville, O. Box 223

MAKE A NOTE OF THIS!

ALL READY FOR 1896.



Appreciating the advantages for procuring Basswood Lumber, and the splendid Shipping facilities of Marshfield, we have established a Factory for the manufacture

—THE ONE-PIECE SECTION.

We have all new and up-to-date Machinery for the manufacture of the "One-Piece Section." Have a Saw-Mill in connection with our Factory, enabling us to get the finest material to be had, for "One-Piece Sections."

Write for Price-List, and also for prices on Sections in any quantity you may want.

THE MARSHFIELD MFG. CO.,
MARSHFIELD, Wood Co., WIS.

Dec. 1s 1895, 6Ctf Mention the American Bee Journal.

per colony of only 1 2-9 ounces per day. The largest amount consumed by any one colony was 2 ounces, the least was 1 ounce. The strength of the colonies was a fair average for this locality. I contend that at this rate of consumption the 25 to 30 pounds usually claimed to be necessary in the standard works would be superabundant here; however, I admit that consumption with the beginning of brood-rearing will be much more rapid, but it remains to be seen how much.

Several of our membership, who had attended the International Bee-Congress at Atlanta, were present, and it is something surprising how looking upon the faces of such veterans as A. I. Root, Poppleton, Demaree, Foose, Bentou, Osteen, Hart, the Browns, Danzenbaker, Calvert, Hubbard, and Mrs. Harrison, and listening to their words of wisdom, can fire the enthusiasm of their younger brethren. No trouble to look around and tell who had visited the Congress. I feel sure these meetings are good for the fraternity.

Fetzeron, Tenn. W. C. COPELAND, Sec.

Bro. Ben's Report for 1895.

Increase of bees 150 per cent. Average per colony, spring count, 100 pounds of extracted honey of fine quality. Main source of honey supply, basswood, buckbrush, sweet clover, wild cucumber and fruit-bloom.

Red clover and most kinds of grass may be kept very green, by putting into the barn in alternate layers of the grass and dry oats straw—layers about one foot thick, beginning and ending with a layer of the straw. I see no reason why the same would not preserve sweet clover, at least it is worthy of a trial.

BRO. BEN.
Grant Centre, Iowa, Feb. 10.

From a Young Lady Bee-Keeper.

The past season was a poor one, freezing and drouth being the cause. We started last spring with 45 colonies of bees and increased to 55. So far this winter we have not lost any. From the 45 colonies we got 4,000 pounds of extracted honey and 600 pounds in sections. We have all our bees in chaff hives on the summer stands. Almost all the bees had a good flight Jan. 29. Two laying queens in one hive were mentioned recently by G. W. Williams. We also have two queens in one hive. We call them "mother and daughter," but they were there only in the summer; in the fall the old queen was gone. The 2-queen hive was 3 Langstroth 10-frame bodies, filled with brood, and 2 for surplus honey. This made 5 Langstroth hives, or one hive and 4 upper stories, or 50 frames with honey and brood. We took 385 pounds of extracted honey last year from this hive, and it had 40 pounds for winter. This colony did not swarm. We would be pleased to hear from Mr. Williams again, whether his 2 queens live through the winter. My pa takes the Bee Journal. I am only 9 years old. My name is—

MISS EMMA BANKER.
Golden Gate, Minn.

What the Bees Worked On.

I had six colonies in the spring of 1895, three of them being strong and three medium. I took from them, in September, 427 pounds of comb honey, an average of 71 pounds per colony; this by actual weight, not by sections.

Now, when I see a honey-yield reported I always want to know where it came from, and I report accordingly.

The first flowers to which my bees had access in early spring were those of the tag-alder. After four or five days these were killed by frost. Shortly after, the willows offered them a fine field for over two weeks. We have both the swamp and upland willows. The latter grow on the pine plains, and are rich in honey and pollen. Just as the huckleberry bushes and fruit-trees came into bloom, a big snow-

Sweet Clover, Willow-Herb, Basswood EXTRACTED HONEY

—For Sale.—

We have made arrangements whereby we furnish **Sweet Clover or Willow-Herb** Extracted Honey, in 60-pound tin cans, on board cars in Chicago, at these prices: 1 can, in a case, 8 cents per pound; 2 cans in one case, 7½ cents.

The **Basswood Honey** is all in kegs holding 170 pounds, net. It is a very superior quality, and the prices are: 1 keg, 8½ cents per pound; 2 kegs or more, 8 cents.

Cash must accompany each order.

A sample of either kind of honey will be mailed to an intending purchaser, for 12 cents, to cover postage, packing, etc. We guarantee purity, and that what we ship will be equal to sample.

GEORGE W. YORK & CO.,
CHICAGO, ILLS.

IF YOU WANT THE BEE-BOOK

That covers the whole Apicultural Field more completely than any other published, send \$1.25 to Prof. A. J. Cook, Claremont, Calif., for his

Bee-Keeper's Guide.

Liberal Discounts to the Trade.

PERFECT FRUIT

IS PRODUCED BY SPRAYING.

Our 32-page Illustrated Spray Catalogue tells **How and When** to Spray—mailed Free. **THE DEMING CO.,** Gen'l Western Ag'ts. **Henion & Hubbell, Chicago.** **Salem, Ohio.**

Mention the American Bee Journal.

TAKE NOTICE!

BEFORE placing your orders for SUPPLIES, write for prices on 1-Piece Basswood Sections, Bee-Hives, Shipping-Crates, Frames, Foundation, Smokers, etc.

PAGE & LYON MFG. CO.
NEW LONDON, WIS.

HONEY We have a large amount of Pure No. 1 Alfalfa we will sell cheap.

SEED Of those great honey-producing plants—Alfalfa and Cleome or Rocky Mountain Honey-Plant. Alfalfa seed at 7 cts. a lb.

Boss bee-escape Warranted the best, simplest and quickest Escape on the market. Sent postpaid to any address for 50 cts. It can be returned at our expense if it is not as represented, or we will send the Escape on trial to any bee-keeper wishing to test it in good faith. We are agents for the

Ferguson Patent Hive with double-case Super and Wicket-Gate Honey-Board, with the Escape. It is the easiest, quickest hive to handle for the production of comb honey. Address,

E. S. LOVESY & CO.,
355 6th East St., SALT LAKE CITY, UTAH.
Mention the American Bee Journal. 9Atf



OUR POULTRY ANNUAL

and Book of Valuable Recipes, 64 large pages, contains 8 beautiful colored plates of fowls, gives description and prices of 45 varieties, with important hints on care of poultry, and pages of recipes of great value to everyone. Finest Poultry Book published for 1896. Postpaid only 10 cts. **C. N. Bowers, Box 24, Dakota, Ill.**

52A13 *Mention the American Bee Journal.*

BEGINNERS.

Beginners should have a copy of the Amateur Bee-Keeper, a 70-page book by Prof. J. W. Rouse. Price 25 cents; if sent by mail, 28c. The little book and the Progressive Bee-Keeper (a live, progressive 28-page monthly journal) one year, 65c. Address any first-class dealer, or

LEAHY MFG. CO., Higginsville, Mo.

storm followed by a week of cold weather, killed all honey-yielding flowers. Then for some weeks the bees were comparatively idle.

Next came the wild red-raspberry, which usually furnishes a large amount of delicious honey. But the freezing weather above-mentioned killed so many of the raspberry buds that the yield from this source was much less than usual.

The first-plant to yield honey in abundance was epilobium, sometimes called "fireweed." The bees began on it early in July, and continued to gather honey from it for over six weeks. Epilobium honey is as white and palatable as that stored from white clover.

A few days before the epilobium went out of bloom the golden-rod blossomed in great abundance, and lasted until cold weather closed the labors of "the little busy bee" for the season.

I might add that during the month of July my bees had access to the blossoms of some eight acres of cranberry vines, but I think little honey was gathered from them, although persevering efforts seemed to be made to extract sweets therefrom.

Usually in this vicinity honey is gathered from the bloom of the huckleberry, the swamp maple (a shrub growing to the height of 15 or 20 feet), and the basswood, but the past season all these were failures. The dandelion and wild strawberry were a little help in their season.

My bees went two miles, or over, for epilobium. The golden-rod was abundant all around them.

Walton, Mich.

Hive Question Solved for Himself.

My crop for 1894 was 7,000 pounds—700 pounds of comb and the rest extracted—from 50 colonies, and increased to \$2. I wintered and springed 72, secured in 1895 6,300 pounds—1,200 pounds of comb, and the rest extracted, and increased to 112 colonies. They are wintering finely in a sawdust-packed building.

I have solved the hive question to my satisfaction. The 8-frame is just right, exactly for a hen's-nest, but for bees I want nothing smaller than 12 frames for extracted, and for comb I use the divisible hive, with 16 frames 6x17½. These hives give me good satisfaction, but I don't like to handle them. They are hauging frames, ¾-inch top-bar, with ¼-inch space between—very little trouble with burr-combs. I have no trouble with queens going from one story to the other.

Ono, Wis., Jan. 18. W. H. YOUNG.

Results of the Past Season.

My report for the year 1895 is as follows: About 1,800 pounds of extracted honey from about 55 colonies here at Eldora; about 1,200 of basswood and 600 of buckwheat—all of excellent quality. My 40 colonies that were in Jasper county did not do as well, only producing about 900 pounds of surplus honey.

I sell my basswood honey at 12½ cents, and buckwheat honey at 10 cents a pound. I moved my bees from Jasper county here by railroad about Nov. 20; waited a few days for them to have a flight before putting them into the cellar, but had to put them into winter quarters without having a flight. Those here I put in nice condition, but left them stopped up a short time, waiting for the other bees to have a flight. (I loosened the sticks so they could get ventilation.) I think that I never had so many bees to take up from the bottom of the cellar as this winter. I lay it to those moved not having a cleansing flight after moving, and leaving those here at home stopped up a few days after putting into the cellar. The bees seem to be doing pretty well (with the exception of too many dead bees on the bottom of the cellar). I put 88 colonies into winter quarters.

Should nothing happen to the white clover from now on, I think that we will get some clover honey next summer. I

CARLOADS



Of Bee-Hives, Sections, Shipping-Cases, Comb Foundation, and **Everything** used in the Bee-Industry.

I want the name and address of every Bee-Keeper in **America**. No reason why you cannot do business with me. I have Cheap Lumber and Experienced Workmen; a good Water Power Factory and know how to run it. I am supplying Dealers as well as consumers. Why not you? Send for Catalogues, Quotations, etc. **W. H. PUTNAM,** 1E RIVER FALLS, Pierce Co., WIS.

Mention the American Bee Journal.

WOVEN WIRE FENCE

Over 50 Styles! The best on Earth. Horse high, Bull strong, Pig and Chicken tight. You can make from 40 to 60 rods per day for from 14 to 22c. a Rod. Illustrated Catalogue Free. **KITSELMAN BROS.,** Ridgeville, - Indiana.

48Et *Mention the American Bee Journal.*

WANTED—200 Colonies of Bees and 4-FRAME NUCLEI on Simplicity or Hoffman frames, in exchange for Supplies, to be shipped either from here or Medina, Ohio. Send for Catalog to—**GEO. E. HILTON,** 4E4t FREMONT, MICH.

Mention the American Bee Journal.

STRAWBERRY PLANTS FOR SALE.

Michigan Grown Plants are the Best.

BUBACH, PARKER EARLE, HAVERLAND, WARFIELD AND JESSIE.

Vigorous Plants of the above well-known varieties, shipped direct from the Nursery—Lake View Fruit Farm, Gibson, Mich. 100, \$1.00; 200, \$1.50, postage paid. Special price on large quantities. Address,

CHAS. N. TRIVENS, CHICAGO, 635 Chicago Stock Exchange, - CHICAGO, ILL. 6E4t *Mention the American Bee Journal.*

WANTED—By a young man (23) a position in a good apiary, or apiary and small fruit or gardening business combined, preferably South and near this State, for the coming season. Has already had good experience with bees, and is willing, serviceable, and active. Would appreciate a good home and a generous employer. Is an experienced clerk, with good references. Address,

6E4t **C. C. DOORLY, Alphin, Va.**

Mention the American Bee Journal.

Bees, Queens, Nuclei—We will sell, the coming season, 500 Two-Framed Nuclei, with a Choice Warranted Queen, at \$2.50 each. Special prices on large orders furnished. **LEININGER BROS.,** 6E4t FT. JENNINGS, OHIO.



INCUBATORS

Our 160 page, finely illustrated Combined Poultry Guide and Catalogue will tell you what you wish to know about

PROFITS IN POULTRY

We manufacture a complete line of Incubators, Brooders and Poultry Appliances. Guide and Catalogue 10c. (stamps or silver) **Worth one Dollar.** Reliable Incubator & Brooder Co., Quincy, Ill.

38E13t Please mention this Journal.

Italian Bees for Sale.

Prices will be as follows.

One Colony \$6.00
Five Colonies 28.00
Ten " 50.00

Each Colony will contain one of my \$2.00 Queens.

NUCLEUS COLONIES.

Any size from One frame up. Select Tested Queens, \$2.00 each, or Two for \$3.00. Breeding Queens, \$3.00 to \$5.00. Address,

F. A. CROWELL, 8E2t GRANGER, Fill. Co., MINN.

Mention the American Bee Journal.

DO NOT ORDER UNTIL YOU HAVE WRITTEN US FOR PRICES ON

The "Boss" One-Piece Section



Also D. T. Hives, Shipping-Crates and Other Supplies.

We have completed a large addition to our Factory, which doubles our floor room; we are therefore in better shape than ever to fill orders on short notice. **Send for Price-List**

J. FORNCROOK,

WATERTOWN, Jeff. Co., Wis., Jan. 1st, 1896.
Mention the American Bee Journal.

FOR

ADEL BEES AND QUEENS

Address, **HENRY ALLEY,**
6Ct WENHAM, MASS.

Barnes' Foot-Power Machinery.

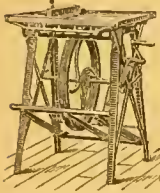

Read what J. I. PARENT, of CHARLTON, N. Y., says—"We cut with one of your Combining Machines, last winter 50 chaff hives with 7-in. cap, 100 honey-racks, 500 broad frames, 2,000 honey-boxes and a great deal of other work. This winter we have double the amount of beehives, etc., to make and we expect to do it with this Saw. It will do all you say it will. Catalogue and Price-List

Free, 45Ct Address, W. F. & JOHN BARNES, No. 995 Ruby St., Rockford, Ill.

The RURAL CALIFORNIAN

Tells all about Bees in California.

The Yields and Price of Honey; the Pasturage and Nectar-Producing Plants; the Bee-Rauches and how they are conducted. In fact the entire field is fully covered by and expert bee-man. Besides this, the paper also tells you all about California Agriculture and Horticulture. \$1.50 per Year; Six Months, 75 cents. Sample Free.

THE RURAL CALIFORNIAN,
218 N. Main St., - LOS ANGELES, CALIF.

Potatoes

Sir William, Maggie Murphy, World's Fair, Rural N. Y. No. 2, \$1.00 per bushel. 20 New Varieties. Catalogue Free.

J. F. MICHAEL,
1D6t GREENVILLE, OHIO.

Mention the American Bee Journal.



Promptness Is What Counts!

Honey-Jars, Shipping-Cases, and everything that bee-keepers use. **Root's Goods at Root's Prices,** and the best shipping point in the country. Dealer in Honey and Beeswax. Catalogue Free.

Walter S. Ponder
162 Mass. Ave. INDIANAPOLIS, IND.

-LEADS THEM ALL S to 24 1/2 B-

See reports of experiments with Comb Foundation at the government station, Lapeer, Mich. **FREE**—large illustrated Catalog of everything needed in the apiary. Full of information. **M. H. Hunt, Bell Branch, Mich.** 5Dt Please mention this Journal.

California ❁❁

If you care to know of its Fruits, Flowers Climate or Resources, send for a Sample Copy of California's Favorite Paper—

The Pacific Rural Press

The leading Horticultural and Agricultural paper of the Pacific Coast. Published weekly, handsomely illustrated, \$2.00 per annum. Sample Copy Free.

PACIFIC RURAL PRESS,

220 Market St., - SAN FRANCISCO, CAL.

have been used to bees from boyhood, and am a lover of the profession. This country is too cold for me; I would like to find a good location in the South, where I can produce both honey and fruit. I would like to correspond with some one living in a good location for both bees and fruit, either in East Tennessee, southwest Virginia, western Georgia, western North Carolina, Alabama, Mississippi, Louisiana and Texas. If some one living in the places named, and where the location is suitable, will write me a short letter, or send me their address, I will consider it a favor. **W. C. NUTT,**
Eldora, Iowa, Feb. 10.

Moving Bees by Wagon.

The question was asked on page 20 about the way to prepare bees to haul overland on a common farm wagon. As I have hauled bees over rough mountain roads with complete success, I can tell W. C. H. how I prepared my bees.

I made light bottoms and tops of 1/2-inch lumber, and cut holes 5 inches square in both bottom and top, and covered both openings with wire-cloth, nailing 1-inch square cleats on both tops and bottoms to keep them from splitting; this will give plenty of air. The frames were loose-hanging, and I made some sticks 3 x 1 1/4 inches nailed crosswise, one over the frames at each end, with small wire nails awled in, so as not to jar the bees too much while nailing. Then I saw that all cracks were stopped. I put a nail in each frame, and hauled the bees 80 miles. Place the hives lengthwise of the wagon. **J. R. GIBSON,**
Tucker, Mo.

The Home Market is the Place.

I have sold my apiary of bees, including hives and "fixings," so I am out of the bee-business for a while at least. I have kept bees for the past 22 years. In the spring I intend to start in new. For the past two years about all my honey has been mixed with honey-dew, and I have had to sell it for about half the price of white honey. Taking all the years together, I have sold tons of honey which paid a big profit for the amount of time and money invested. I never sold a pound to commission merchants, and never have failed to find a home market for all the honey I have had. I think it is safe to say that thousands of dollars are lost to bee-keepers in Vermont every year by shipping their honey to Boston and New York to be sold on commission. Vermont produces no more honey than she can consume herself, and would if she had the chance, paying good prices to the producer. I know a number of merchants that get all their choice Vermont honey by way of Boston cheaper than I can afford to sell it to them here. Comb honey sells here for 20 cents, and Western extracted for 15 cents per pound. **Sharon, Vt., Feb. 2. C. A. MARSH.**

Some Folks Need Educating.

Rev. E. T. Abbott thinks it is just and right to tax bees. Here in Wisconsin they are taxed. Then comes our weed commissioner and pulls up our sweet clover. I sowed the seed on my own ground, and had a nice, large field of sweet clover, but the weed commissioner cut it down. I have been a member of the Bee-Keepers' Union, and I think it could help us in this matter. I think our State has made a mistake. Probably our officers are too poor to buy honey, so they destroy our sweet clover. **Pulcifer, Wis., Feb. 4. HENRY STARK.**

Death of Mr. C. H. Pond.

My father, C. H. Pond, died on the morning of Jan. 14, after an illness of several months. He had been a sufferer from heart disease for the past three years. He had been engaged in horticulture and apiculture for the past ten years. I shall continue in

SEE THAT = LIVE = SEEDS FROM GROWER TO PLANTER

New and Wonderful Varieties sold at lowest growing prices. I give you middleman's profit and **Seeds that Crow.** Novelty Presents free with orders. My New Seed and Plant Book **FREE.** Write now before they are gone.

H. W. BUCKBEE,
Rockford Seed Farms,
P. O. Box 637, ROCKFORD, ILLS.

WHEN ANSWERING THIS ADVERTISEMENT, MENTION THIS JOURNAL.

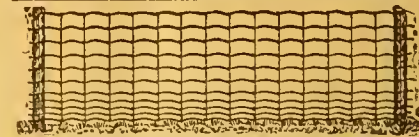

OVER 100 RAILROADS.

Are now using our fence to protect their right of way, and yet our railroad business amounted to only one fifth of the whole amount for 1895. The **PAGE** is winning its way with all classes.

PAGE WOVEN WIRE FENCE CO., Adrian, Mich.

Mention the American Bee Journal.

WHITE FACED BLACK SPANISH POULTRY

40 Standard Breeds Illustrated & fully described in my new Poultry Book. Reliable information for poultrymen & intending buyers. Goodstock Ducks & Geese; also Shetland Ponies. Send 6c in stamps

E. H. COOK, Box 27, Bentley, Ill.

Mention the American Bee Journal. 4A13t

COMB FOUNDATION WHOLESALE and RETAIL.

Are you going to buy Foundation for Cash, or have you Wax to sell or trade for Foundation and other Supplies? Have you 25 lbs or more of Wax that you want made into Foundation? If so, do not fail to write me for samples and prices. I make a specialty of working up Wax by the lb., and do it very cheap during the winter. Beeswax wanted at all times.

GUS DITTMER, AUGUSTA, WIS.
Reference—Augusta Bank. 16At

Mention the American Bee Journal.

PATENT WIRED COMB FOUNDATION

Has No Sag in Brood-Frames

Thin Flat-Bottom Foundation

Has No Fishbone in the Surplus Honey.

Being the cleanest & usually worked the quickest of any Foundation made

J. VAN DEUSEN & SONS,

Sole Manufacturers,
Sprout Brook Montgomery Co., N. Y.

Mention the American Bee Journal

1896 SAVE MONEY 1896

If you want first-class **ITALIAN QUEENS FOR BUSINESS,** Foundation at Wholesale Prices. Hives, suited for the South, or **SUPPLIES,** send for Price-List—to

J. P. H. BROWN, AUGUSTA, GA.

Mention the American Bee Journal.

READERS Of this Journal who write to any of our advertisers, either in ordering, or asking about the Goods offered, will please state that they saw the Advertisement in this paper.

the bee-business. I intend to move my bees to the timber in the spring, where I shall be surer of getting a good flow of honey. I have always helped my father in his backyard. He did not get much honey last year, as it was so dry that white clover was a failure, as was buckwheat and other fall plants.

I have 64 colonies in the winter quarters, and they seem to be doing nicely. Honey seems to be a drug on the market here, and goes off slowly at 10 and 12½ cents per pound. There have been some fellows around selling "extracted honey," and I found out where they bought 50 pounds of sugar to make it with. It seems to me that such men could be "put through" for such business.

WILLETT POND.

Kasson, Minn., Jan. 30.

Honey & Beeswax Market Quotations.

CHICAGO, ILL., Feb. 28.—White clover and basswood comb is sought after in preference to any other, and commands a better price and now sells at 15c. for clover and 13@14c. for basswood. Other white comb honey sells at 11@12c.; dark, 8@9c. amber, 9@10c., and very slow of sale. Extracted is unusually dull, with large amounts on sale. White clover and linden, 6@7c.; dark and amber grades, 4½@5c.

Beeswax, 28@30c.

R. A. B. & Co.

NEW YORK, N. Y., Feb. 24.—Market quiet. White comb in fair demand at 11@14c. Very little demand for buckwheat comb at 8@9c. Extracted selling fairly well, principally California, at 5½@5¾c., and some buckwheat moving at 4@4½c.; Southern, 5@5½c. per gallon; white clover and basswood, 5½@6c.

Beeswax unchanged.

H. B. & S.

CINCINNATI, O., Feb. 18.—Demand is fair for choice comb honey, at 12@14c. in a jobbing way. Extracted is slow at 4@7c.

Beeswax is in good demand at 25@30c. for good to choice yellow.

C. F. M. & S.

KANSAS CITY, Mo., Feb. 19.—The demand for comb and extracted is fair. We quote: No. 1 white, 1-lb., 13@14c.; No. 2, 11@12c.; No. 1 amber, 10@11c.; No. 2, 8@10c. Extracted, white, 5½@6½c.; amber, 5@5½c.

Beeswax, 20@25c.

C. C. C. & Co.

List of Honey and Beeswax Dealers.

Most of whom Quote in this Journal.

Chicago, Ills.

R. A. BURNETT & Co., 163 South Water Street.

New York, N. Y.

HILDRETH BROS. & SEBELKEN.

120 & 122 West Broadway.

CHAS. ISRAEL & BROS., 486 Canal St.

Kansas City, Mo.

C. C. CLEMOMS & Co., 423 Walnut St.

Buffalo, N. Y.

BATTERSON & Co., 167 & 169 Scott St.

Hamilton, Ills.

CHAS. DADANT & SON.

Philadelphia, Pa.

WM. A. SELSER, 10 Vine St.

Cincinnati, Ohio.

C. F. MUTH & SON, cor. Freeman & Central avs.

Bee-Keepers' Photograph.—We have now on hand a limited number of excellent photographs of prominent bee-keepers—a number of pictures on one card. The likeness of 49 of them are shown on one of the photographs, and 121 on the other. We will send them, postpaid, for 50 cents each, mailing from the 121 kind first; then after they are all gone, we will send the 49 kind. So those who order first will get the most "faces" for their money. Send orders to the Bee Journal office.

NEW YORK.—The Seneca County and Central New York Bee-Keepers' convention will be held at Hayt's Corners, Seneca Co., N. Y., at 9 o'clock, Mar. 5, 1896. All are cordially invited to attend. An oyster dinner will be served to all visitors. C. B. HOWARD, Sec. Romulus, N. Y.

PERSONAL MENTION.

HON. GEO. E. HILTON, of Fremont, Mich., expects to establish two or three out-apiaries in the willow-herb district this year. Mr. H. is a hustler, and one of Michigan's best bee-keepers.

MR. WM. McEVoy, who is Ontario's energetic foul-brood inspector, and also Vice-President of the North American Bee-Keepers' Association, says: "The American Bee Journal is great value for the money, and I prize it very much."

MR. E. B. HUFFMAN, of Homer, Minn., writes thus: "For my part I would as soon think of attempting to work at blacksmithing without coal as to keep bees without the Bee Journal. Our bees seem to be wintering all right so far, and we are expecting lots of honey this year."

MR. G. K. HUBBARD, of Riverside, Calif., wrote thus Feb. 21: "No rain worth considering, and no prospects for honey." We regret to learn that Mrs. Hubbard "is still very miserable in health." They went from Indiana to California, hoping that Mrs. H. would find relief.

MR. GEO. W. BRODBECK, of Los Angeles, Calif., wrote us on Feb. 18, as follows: "The prospect for a honey season is *very poor*, and unless we get more rain we fear a repetition of 1894." We hope the bountiful showers may come in due season, not only in California, but in all parts of our beloved land.

MISS EMMA WILSON—Dr. Millar's "aparian helpmate," we were going to say—writes occasionally for Gleanings. She isn't afraid "to speak out in meeting," either. Neither has she contracted the habit of saying, "I don't know." She believes in numbering hives, and keeping a record-book. Speaks from experience.

MR. THOS. M. PIERCE, of Pawtucket, R. I., called at our office last week. He is the President of the Bee-Keepers' Educational Society, which meets monthly in Providence, R. I. It was through this organization that Mr. G. M. Doolittle lectured recently on the subject of bees. If all the members of that Society are as wide-awake and good-natured as Mr. Pierce, they must have grand good times at their meetings. Success to "Little Rhody's" band of beekeepers!

MR. L. C. FRANCIS, of Springfield, is one of the oldest members of the Illinois State Bee-Keepers' Association. In the time of the War he sold honey at 35 cents a pound. On one occasion he sent a carload of honey to St. Louis that netted him \$2,000. Since honey has become so cheap he does not do much with his bees, but turns his attention to his farm. Oh, for old-time honey prices and crops! Then we wouldn't hear so much about "hard times," and bee-keepers would feel more like paying up their subscriptions to the bee-papers. But they make a very great mistake when they drop the papers during the poor years, as in one of the missed copies they may fail to see an idea that is worth dollars to the man who is wise enough to "keep up with the times" even if they be a trifle "hard." To think that any real bee-keeper can't afford \$1.00 in a whole year for a good bee-paper! Why, he can't afford to do without the good paper, if he only knew it!

UTAH.—The Utah Bee-Keepers' Association will hold their semi-annual meeting in Room 54, City and County Building, Salt Lake City, Apr. 6, 1896, at 10 a.m. All are invited. "In union is strength. By industry we thrive." Come, and bring your friends, and enjoy a good time. A full program in the interest of the industry will be presented. The Association needs your aid; then let every one do his full duty for our own interest and self-preservation. GEO. E. DUDLEY, Sec. Provo, Utah.

The Bee-Keepers' Guide:

Or Manual of the Apiary,

BY PROF. A. J. COOK.

This 15th and latest edition of Prof. Cook's magnificent book of 460 pages, in neat and substantial cloth binding, we propose to give away to our present subscribers, for the work of getting new subscribers for the American Bee Journal.

A description of the book here is quite unnecessary—it is simply the most complete scientific and practical bee-book published to-day. Fully illustrated, and all written in the most fascinating style. The author is also too well-known to the whole bee-world to require any introduction. No bee-keeper is fully equipped, or his library complete, without "THE BEE-KEEPER'S GUIDE."

For Two New Subscribers and Your Own Renewal.

Send us Two New Subscribers to the Bee Journal and your own renewal (with \$3.00), and we will mail you a copy of Prof. Cook's book FREE as a premium, and also a copy of the 160-page "Bees and Honey" to each New Subscriber. Prof. Cook's book alone is \$1.25, or we club it with the Bee Journal for a year—both together for only \$1.75. But surely anybody can get only 2 new subscribers to the Bee Journal for a year, and thus get the book as a premium. Let everybody try it. Will you have one?

TEXAS QUEENS.

If you are in need of Queens, let me have your order. Price-List Free.

SA26t J. D. GIVENS, Lisbon, Tex.

ORIGINAL BINGHAM SMOKERS



Wonderful Record!

HAVE LASTED 17 YEARS.

—BEST ON EARTH.

Always Give Perfect Satisfaction.

My cool Wire Handle and Bent Nose were patented 1892, are the original, my best invention since my open or direct draft Patent, 1878, that revolutionized Bee-Smokers. My Handle and Nose Patent bent all the other smoker noses. None but Bingham Smokers have all the best improvements. If you buy genuine Bingham Smokers and Honey-Knives you will never regret it. The "Doctor," ¼-inch larger than any other smoker on the market—3½-inch stove, by mail, \$1.50

Conqueror, 3" ..	1.10
Large, 2½-in. ..	1.00
Plain, 2-in. ..	.70
Little Wonder, 2-in., wt. 10 oz.	.60

Bingham & Hetherington Honey-Knives, 80 cents.

T. F. BINGHAM, Farwell, Mich.

7Atf Mention the Bee Journal.



12 Pkgs. tested, pure, fresh garden seeds, 12 cts., postpaid. R. N. Thomas, Shenandoah, Iowa.

Grind Your Feed Grain.—Just because corn is cheap is no reason why the farmer should waste it by feeding it whole. Economy as well as the health and thrift of the animal demands that grain of all kinds should be ground to produce the best results in feeding. This being true, it then becomes a mere question of the selection of the proper machine with which to grind the grain. The "Peerless," which is manufactured by the Joliet Strowbridge Co., of Joliet, Ill., seems to offer a good many advantages to the farmer, as it requires no power separate from the machine itself, and grinds ear corn and cob quickly, easily and finely. Send for their Catalogue about their Feed Grinder, and correspond with them. They also handle a full line of agricultural implements.

Bottom Prices

**BRING US BIG TRADE.
GOOD GOODS KEEP IT.**

If you want the best supplies that can be made at a little less cost than you can buy the same goods for elsewhere, write to us for low prices. 1896 Catalogue now ready—ask for it and a free copy of **The American Bee-Keeper** (36 pages).

Address,

**THE W. T. FALCONER MFG. CO.,
JAMESTOWN, N. Y.**

Mention the American Bee Journal.

EVERGREENS!

and Ornamental trees, Nursery grown. 250 Choice Evergreens, 10 varieties \$2. 400 Ornamental trees, 6 varieties, \$2. 50 other \$5 and \$10 bargains, 100 Scotch Pine, 2 ft. high, \$8; 1,000 10 to 12 inches \$10. All other varieties and sizes cheap. Local Agents Wanted. Send for Illustrated Catalogue. **FREE.**

**D. HILL, Evergreen Specialist,
J. DUNDEE, ILLINOIS.**

7A5t Please mention the Bee Journal.

ROOTS

A great reduction in Prices on Hives and Sections. Other bargains in Appliance Supplies. State what you need and we will give you low prices. 36-p. Catalogue Free.

JNO. NEBEL & SON, High Hill, Mo.

Mention the American Bee Journal. 4A26t

The Rural Kansan

Is an Agricultural Journal for the busy farmer. It embraces Bee-Keeping and every department of industry connected with the farm. 30 cts. a year, monthly. Sample Free.

A Full Line of **Higginsville Bee-Supplies** on hand.

CATALOGUE FREE.

HENRY L. MILLER,

355 Shawnee Ave. TOPEKA, KAN.

1A13t Mention the American Bee Journal.

FOR SALE.

**ALSIKE, CRIMSON, ITALIAN, ALFALFA,
or WHITE CLOVER SEED.**

4A8t **WM. CRAIG, Luce, Mich.**

Mention the American Bee Journal.

Queen-Clipping Device.

I want the address of all who clip Queens and have even the least trouble either in catching or holding them while they are being clipped. I have invented a Device by which it is impossible to injure a Queen either in catching or clipping, unless it is done purposely. With it they are caught and clipped any way desired almost instantly. One does not have to touch the Queen with his hands, whatever. Price, postpaid, 50 cts. Send for Free Circular. **C. MONETTE,**

6A1f **CHATFIELD, Fillmore Co., MINN.**

Mention the American Bee Journal.

BEES QUEENS
Smokers, Sections,
Comb Foundation,
And all Appliance Supplies
cheap. Send for
FREE catalogue. **E. T. FLANAGAN, Bellefonte, Ill.**

6A26t Please mention the Bee Journal.

Fruit Plants

Where to buy them at wholesale price. Send postal for descriptive and

wholesale Catalogue of all the leading varieties of the **Strawberries, Raspberries, Blackberries, Currants, Gooseberries, Grapes and Potatoes.**

EZRA G. SMITH, Manchester, Ont. Co., N. Y.

8A1f Please mention the Bee Journal.

CASH PAID FOR BEESWAX

For all the good, pure yellow **BEESWAX** delivered to our office till further notice, we will pay 26 cents per pound, cash; or 30 cents for whatever part is exchanged for the Bee Journal, Honey, Books or Seed, that we offer. If you want **cash promptly** for wax, send it on at once. Dark or impure wax not taken at any price. Address plainly,

George W. York & Co., 56 Fifth Ave., Chicago, Ill.

19th Year Dadant's Foundation 19th Year

Is still in the lead, for we use all the latest improvements, including the **NEW PROCESS**, and still make the best goods. Remember that we do not use any acid to purify our beeswax, and that is why our Foundation preserves the smell of the honey and is more acceptable to the bees, than any other. It is kept for sale by

G. K. Hubbard, Fort Wayne, Ind.
L. Hanssen, Davenport, Iowa.
C. Theilmann, Theilmann, Minn.
E. C. Eaglesfield, Berlin, Wis.
E. T. Abbott, St. Joseph, Mo.
J. M. Jenkins, Wetumpka, Alabama
John Rey, East Saginaw, Mich.
Vickery Bros., Evansville, Ind.

The Jennie Atchley Company, Beeville, Texas.
C. F. Muth & Son, Cincinnati, Ohio
E. Kretzmer, Red Oak, Iowa.
Jos. Nysewander, Des Moines, Iowa.
G. B. Lewis Co., Watertown, Wis.
James Reynolds Elevator Co., Poughkeepsie, N. Y.
Page & Lyon, New London, Wis.
T. H. Strickler, Solomon City, Kansas.

and many other Dealers. All agree in saying that no goods are better than ours.

Those of our customers who formerly bought through Thos. G. Newman can get our Foundation in **Chicago, Ill.**, by addressing us at **56 Fifth Avenue**. We keep no other goods there.

— We make a specialty of **Veils and Veil Stuffs** of best quality, cotton and silk.

Langstroth on the Honey-Bee, Revised.

Bee-Keepers' Supplies, Smokers, Sections, Tin Pails, etc.

Samples of Foundation and Tulle FREE with Circular. Instructions to beginners with Circular. **BEESWAX WANTED.** Send us your address.

CHAS. DADANT & SON,

Mention the American Bee Journal.

HAMILTON, Hancock Co., ILL.

SECTIONS, BEE-HIVES, SHIPPING-CASES

We make a Specialty of these Goods, and defy Competition In

QUALITY, WORKMANSHIP AND PRICES.

✉ Write for Free Illustrated Catalogue and Price-List.

G. B. LEWIS COMPANY, Watertown, Wis.

✉ Be sure to mention the American Bee Journal when you write. ✉

* ROOT'S COMB FOUNDATION! *

We are pleased to announce that, having secured control of the new Weed process of manufacturing foundation for the U. S., we are prepared to furnish **Foundation by the New Process**, for 1896. Samples will be mailed free on application, and will speak for themselves.

OUR SANDED and POLISHED SECTIONS, well, they will speak for themselves, also.

Our 1896 Catalog

will be ready for distribution now in a few days. Send in your name at once for catalog, samples of the new foundation, and those superb sections, and while you are about it ask for late copy of **Gleanings in Bee-Culture.**

THE A. I. ROOT CO., MEDINA, OHIO.

56 51th Ave., Chicago, Ill.

Syracuse, N. Y.

1024 Mississippi St., St. Paul, Minn.

A Big Success

New Product.

New Process.

AMERICAN BEE JOURNAL

DEVOTED EXCLUSIVELY TO THE INTERESTS OF HONEY-PRODUCERS

ESTABLISHED 1861
THE OLDEST BEE-PAPER IN AMERICA

Published Weekly, at \$1.00 per annum.

Sample Copy sent on Application.

36th Year.

CHICAGO, ILL., MARCH 12, 1896.

No. 11.



General Hints on a House-Apiary.

BY B. TAYLOR.

(Read at the Wisconsin State Convention, Feb. 6 and 7, 1896.)

I will give a few thoughts upon the subject of house-*apiaries*, drawn from six seasons' experience with that method of caring for bees.

To make bee-keeping pay, we must have good crops of surplus salable honey, and to get that we must have plenty of

it would furnish all the prime conditions for perfect winter quarters. I reasoned by having the hives near together, and packing a number of them properly with a cold-excluding and warmth-retaining blanket of dry sawdust, that each single hive would co-operate with its neighbor in retaining heat, and thus secure mutual warmth, even temperature at all times, and especially protection from sudden harmful changes of temperature in the critical breeding season—*early spring*. I reasoned that the bees would be at liberty to take a cleansing flight several times during winter, on warm days, and that such flights would be more healthful for the colonies than five or more months of cellar confinement. Yes, theoretically, the house-*apiary* furnishes *all* the conditions that reason demands for successful fall, winter, and spring protection.

I have not been disappointed, for five winters' practical experience has proved the house a good, safe place to winter bees in. I have, it is true, had some loss each winter in the house, but there was each year still greater loss, with equally good colonies, in a first-class cellar. I have each season got better results in surplus honey in the house than in the open yard. Perhaps this may have come from giving the bees in the house a little the best care. Feeding, and many other

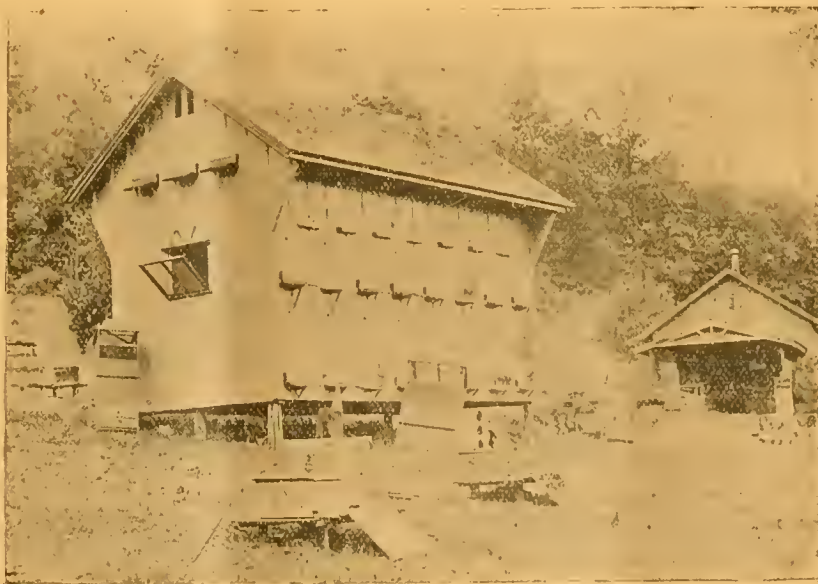

Mr. B. Taylor, of Forestville, Minn., and His House-*Apiary*.

healthy bees in early spring, so a large army of workers may be bred in time for the white clover harvest, and in order to have those early bees, successful wintering is indispensable. Moses Quinby long ago declared what our experience has proved true, viz.: That two-thirds of the failures in bee-keeping come from failure in successful wintering. The house-*apiary*, then, to be practical must be a good place to winter bees in.

When first resolved to try a house-*apiary*, I reasoned that

necessary things are more easily done in the house. Robbing, cross bees, wet grass, hot sun, and many other nuisances are unknown in the house. It is a great comfort to be able to open a hive at any time, and not be troubled with robbers.

I put my bees into the cellar last year on Nov. 8; the bees in the house have had two splendid plays since then. They were out Jan. 8, and yesterday (Jan. 30) they were out *en masse*. In both of these flights not enough bees chilled to speck the snow.

In regard to the construction of houses, I have been unable to discover anything better than my new house-apiary. It is cheap and simple, and fills all practical demands so far as I can see. Some have advocated building with packed walls, and made warm enough so the hives would need no packing, but the cost would be greatly increased, and no practical good gained. Several good houses have been illustrated in the bee-papers in the last year or two, but in principle they are the same as my own. Some have used the shelf to set the hives on, without a bottom-board. This is not good. We need to handle and change hives in the house, and when the hives set directly on the shelves, every time a hive is lifted the shelf will be left covered with crawling bees, and they must be brushed away to give place for the new hive that must be set down. I have the same bottom-boards for the hives in the house as for the out-yard work. When I lift a hive I move bottom and all to a table near by. If I need to move the hive from the bottom, I carry the bottom with its crawling bees outside, and they will return home.

In the swarming season, if we want increase, we will need to move the hive that has swarmed to a new stand outside, and a movable bottom-board is needed for the reason I have given. I mention this seemingly trifling part because some may wish to build, and Mr. Root says in the "ABC of Bee-Culture," that the bees you must necessarily have under foot in a house is a great nuisance. I have not crushed a gill of bees on the floor in my five years' practice. Gentle Italians that will not rush from the hive when opened are a great comfort in the house. It is also a great comfort to have hives with frames that can be taken out and returned with certainty to their proper place quickly, and without any prying and scraping; and frames handle more conveniently when placed lengthwise of the shelves.

I like the plan of building house-apiaries on posts raised two feet from the ground, for it is the only cheap, practical way of entirely getting rid of that unbearable nuisance—rats and mice—which are sure to undermine stone-walls and dirt floors. In my house rats and mice have no place they can sit on to gnaw, and I have entire immunity from them.

I regard house-apiaries as especially adapted to out-yards, having all the facilities for properly caring for bees in themselves the year around, and without increased cost over open yards; I contemplate increasing my honey-business in that way.

In writing this I have only tried to give general helpful thoughts to those who may wish to build. A house-apiary is not easily changed after once built, and I caution you to investigate and know what you want before you build. If you make no mistakes, you will not afterward regret having made "a house-apiary."
Forestville, Minn.



The Amalgamation Question Again.

BY HON. J. M. HANBAUGH.

There has probably been enough said on this question already, but as the matter is still open to discussion, I trust no one will take exceptions to me having my "say;" and now that I have become a citizen of the banner honey-producing county of the banner honey-producing State of the United States, with once more a small apiary at my command, I feel somewhat disposed to arise and make myself known.

When this subject first came to my notice from the masterly pens of quite a number of the Bee Journal contributors, I was favorably impressed with the idea, and was disposed to give it my hearty approval, but after mature deliberation, and reading the able arguments on the opposite side in the controversy, I have become convinced that the amalgamation of the North American and the Bee-Keepers' Union would not be in accord with the best interests of the two societies, and the bee-keepers' interest in general throughout the United States.

In the first place, I will state that the Bee-Keepers' Union is National and not international, and to combine the two societies under one code, would necessitate an entire change of constitution, by-laws, and the entire *modus operandi*. And now the question naturally comes up, are the two societies reconcilable?

In a financial point of view, which of the two old societies would have the greater amount of money to replenish the treasury of the new society? Our General Manager of the Bee-Keepers' Union reports the balance in the Treasury, Dec. 31, 1895, to be \$771.61; while the report of the Secretary of the North American, at Toronto, Sept. 6, 1895, reports a balance of \$7.53. Is there not a chance here for a bone of contention?

Again, by our abandoning the National feature to become international, do we not embrace in our territory the entire

northern hemisphere, which would take in Canada, Mexico, and the British Possessions of North America? In so doing would our brethren across the borders be willing to accept a tax that would place them on an equal footing with us financially? or would we have to hold the amount from the Bee-Keepers' Union as a gratuitous fund to be used alike in the interests of the pursuit regardless of boundary lines?

Now, friends, in all fairness and justice, would it not be more consistent to have the matter fairly explained before the members of the Bee-Keeper's Union, and give them an opportunity to vote for or against the amalgamation, ere you seek to change the situation that prompted them to contribute their money?

The Bee-Keepers' Union was organized for the mutual protection to its members against unjust encroachments and "assaults of the enemies of the pursuit;" and with this banner in the hands of our bold and indefatigable General Manager—Thos. G. Newman—success has perched upon our banner, and bee-keepers have had a bulwark of defense, that few pursuits can boast of; and with all due deference to other members composing the organizers and promoters of the Bee-Keeper's Union, to Thos. G. Newman belongs the honor of its universal beneficence to the bee-keepers' cause; and to dethrone him from a position in which he has proven himself our greatest benefactor, we believe would not be in accord with the true rules of etiquette and the best interests of the pursuit.

The Union as it now stands with our highly-esteemed General Manager, Thos. G. Newman, at the helm, is too potent a power for good to be destroyed by the cohesion of other societies. It is our safe-guard against unjust encroachments, and a terror to wrong-doers. What more could we desire of one society? Let the Union stand, is our motto.

Escondido, Calif.



Artificial Swarming, or Dividing for Increase.

BY CHAS. DADANT & SON.

(Continued from page 146.)

Now that we have our queen-cells reared—for we aim to make enough of the colonies queenless to rear all the cells we need for our swarms—our next step is to make small swarms, something like what queen-breeders call "nuclei," after Langstroth, but these nuclei, instead of being made in diminutive hives with microscopic frames, are made in the ordinary style of hives, with from two to four frames of brood, bees and honey, and a division-board, or dummy, to reduce the space.

To make these swarms we do not take anything from our honey-producing colonies. These are left in full possession of all their strength, which they need to produce a good crop. In an apiary of, say 50 colonies, only enough of the best are broken up, as previously stated, to furnish all the queen-cells we need; after this, we make the division from the colonies which would not be likely to produce any honey. In every apiary there are a number of colonies, which, either owing to weakness in early spring, to lack of fecundity in the queen, to a shortage in their supplies, or to other unaccountable cause, are late in their brood-rearing, and become strong only when the crops are at its height, or past its best. They are then in possession of a large lot of brood, and will hatch many bees that will only serve to consume the stores; for they will be fit to work only after the crop is over. These are the colonies that we use to make our swarms. In a state of nature, not one swarm would be harvested from them; and if they did swarm, their progeny would not be desirable, since, in all probability, their queens are only second-best in prolificness. As we have our queens all reared, and all from the best stock, it does not matter from which hives we take our increase.

On the 9th day after the queens have been removed, as mentioned in the previous article, we open our queenless hive, or hives, and count the queen-cells. We then make as many nuclei, with two frames of brood, and two frames of honey, and pollen, and bees enough to cover them, as we have queen-cells left, after leaving one to each hive. On the next day, after the bees have ascertained their loss, we insert the queen-cells (after the method of queen-breeders) in these queenless nuclei. We can take as many as two swarms from one hive; but this is not advisable. We prefer to take only one from each, with nearly all the young bees that the hive contains; for many of them will return to the parent hive. If the weather is cool, and we can keep the hives shaded, we close up these nuclei until the next day; so they become accustomed to their new habitation. Care must be taken, of course, not to remove the queen with the bees, and it is always best to find her. If we took her with the swarm, our aim would be foiled, for she would destroy the queen-cell when we insert it, and

the queenless colony, from which she was removed, would then be compelled to rear another, an inferior queen like herself.

The colonies, from which these combs of brood and feed have been removed, are at once supplied with frames full of foundation, and in a few weeks those hives are again filled. If we do not wish to use full sheets of foundation, we make it a point to remove all, or nearly all, the combs, and furnish these bees with a large lot of empty frames, with only starters, or guides; for we have noticed that, unless a colony is almost without comb, it will, if strong, during a good crop, build a great many drone-cells. A swarm, beginning in an empty hive, will invariably build 90 per cent. of worker-comb. A colony with only three combs to build, if strong in bees, during the harvest, will build half of these in drone-comb. For this reason, we let only comparatively weak colonies, and colonies with young queens, do the comb-building. Most important of all, we do not give any empty space to a queenless colony, for they would build nothing but drone-comb. It is for this reason that we do not wish our nuclei to have any more bees than are necessary to keep the brood warm, until their queens are fertile and laying. We also believe that a colony while queenless is somewhat discouraged; that the bees do not work with enthusiasm, and we want to use as few bees as possible for this purpose.

In about 10 to 14 days after the queen-cells have been introduced, most of our queens are laying, and the little colonies may be reinforced by giving them more bees, and more drone-combs, if we have them. The same colonies that have been used to furnish the bees, may be called upon to do this. The swarms, according to their strength, may be given empty frames, in which they will most probably build nice worker-combs. If foundation is used, and we generally use it, the advance is very much more prompt.

In all these manipulations, we must be careful not to leave a swarm, that has brood with too few bees; not to divide a weak colony, or give a queenless colony any empty space, in which they might build.

The swarms which have been made must be examined, so they may not rear additional queen-cells, and swarm with the young queen first hatched. We have seen very weak colonies divide up in this way. The swarms, in which the young queens are inserted, while yet in their cells, may destroy those cells, and try to rear some of their own brood; or the young queen may be lost in her wedding-trip, and this must be all attended to. These accidents may look as quite a hindrance to the success of the method, and may annoy some people, but, after all, they do not amount to anything, when compared to the trouble given by natural swarming.

In our eyes, the advantage of our system rests in the being able to save, for honey-production, the very colonies that are most likely to yield honey, and to use, for increase, such colonies as would give little if any profit; while we are, at the same time, breeding our bees from our best stock, and the increase thus made is, so to speak, of the gilt-edge kind. It is worth quite a little trouble to attain this end, and the profit reaped is two-fold.

Hamilton, Ill.



The Cheshire Cure for Foul Brood.

BY WM. F. CLARKE.

On page 19, we are informed that several parties mentioned by name have tried the Cheshire drug treatment for foul brood and found it a complete failure. It is further stated that any medicated syrup strong enough to cure foul brood would kill all the sound larvae and every bee in the colony. One of the persons named is said to have "sprayed the diseased combs with acids so strong, that the combs fairly smoked" and then it failed to cure them of foul brood.

This is not the Cheshire remedy for foul brood. The Cheshire prescription is simply to get the bees to consume syrup medicated with phenol. In his great work, Vol. II, page 562, he speaks of many, who "with a perversity which is almost incredible say that phenol will not cure, for they have given it in the food-bottle, but the bees would not take it." On the next page he asserts that if the bees can be induced to take the phenolated syrup they "will use a curative quantity of it."

So far as I know, I am the only bee-keeper on the American Continent who has patiently investigated the Cheshire method and got to the bottom of it. He prescribes from the 500th to the 750th proportion of phenol. I am inclined to think the drug is not always of the same potency. At any rate, the main difficulty is to get the bees to take the mixture. When they will do that, it is plain sailing. My eyes were

opened when, after many failures I at last got a foul-broody colony to take the phenolated syrup. I fed them 20 pounds of it in the fall. Next spring and all through the following season they were the best colony I had. Of all the many pretty processes in bee-keeping, there is nothing prettier than to see how the bees will clean out the foul brood when once you get them onto a diet of phenolated syrup. It is like magic, the way it works.

Ridicule is not argument. I am not lecturing the people with solemn airs on what science teaches. I am dealing with facts and speaking of what I know. Deliberately, I wish to put myself on record as asserting that the Cheshire treatment, as he prescribes it, is what I have called it—"a cheap and easy cure for foul brood," in all curable cases. It is also a remedy, in comparison with which every other I have tried is "vanity and vexation of spirit." I can bide my time, assured that sooner or later, in this case as in every other, "*magna est veritas et prevalebit.*"

I will only add that the man who does not know how to feed a colony of bees medicated syrup without their being robbed by other bees is not much of a bee-keeper, and had better look into Mr. Benton's new book on "The Honey-Bee," page 117, and learn the Cheshire way to prevent robbing.

Guelph, Ont.



The Past and Present of Bee-Keeping.

BY G. M. DOOLITTLE.

Having occasion, lately, to look over an old diary to find something that was called in question, I ran across an item which was written by a friend to prove that bee-keeping was always to be a lucrative business, which item read as follows:

"Notwithstanding the great demand for bees, and the immense quantities of honey that are produced from year to year, the amount largely increasing each year, I do not see any reason to think that overstocking or overproduction is a factor that need trouble us in this generation. At any rate, I don't see that the price of nice honey is any lower than years ago."

This was written in 1884, or about 12 years ago, and in reading there was a strange sound to it; strange, not only from the standpoint of 1896, but from the standpoint of 1869, as well, at which time I commenced to keep bees. I fell to wondering if "this generation" that existed 12 years ago had passed away, for surely, if I read our present bee-literature aright, both "overstocking" and "overproduction" are causing a wail to come from nearly every hand. Hear Mr. Hutchinson telling in the Review how the forests have been cut off, the swamps been dried and the fence-corners cleaned out, till the flora which we had a few years ago—which invited the little busy bee to a sumptuous feast—was becoming nearly as scarce as the trails of the Indian. Then hear Dr. Miller, and others, asking if the good old times will ever come again? All of which point to the fact, that whether overstocked or not, from some reason the average bee-keepers does not secure the average good crops of honey that they did years ago.

Then look at the talk of low prices, the planning to form a honey-association, and the ceasure of our commission-men, who realize only 10 cents a pound for nice white comb honey to their consigners, where they sell at 14 cents, and ask yourself if overproduction is not figuring in this matter of low prices. If it is not overproduction that makes the low prices for honey, what is it? Commission-men were not formerly criticised for charging 10 per cent., for that was the usual charge during the early seventies. All must admit that the market price of honey is much lower than it formerly was, and when 10 per cent. is taken from a low price it hurts the honey-producer much worse than it does to have the same per cent. taken from a high price. Small honey-producers can sell their honey to advantage about home, in neighboring villages, but the large producer must always seek a market for his produce in the large cities, and the price obtained in these cities has very much to do with home prices; hence the "market price" is what we have to look to in determining whether overproduction has had anything to do with the matter of prices.

I commenced bee-keeping 27 years ago the present spring, and at that time honey in six-pound boxes, having glass on two sides, brought 25 cents per pound, delivered at the railroad, while in the fall of 1869 I was offered by a party from New York city, 50 cents per pound for the little I had, the advance of 100 per cent. being caused by a very poor season during 1869, so that the supply was very much less than the demand.

The season of 1870 being an extra-good one, the price fell back to 25 cents again, at which price I sold my crop of

that year, as well as that of 1871 and 1872. Owing to the loss of bees during the preceding winter, the supply was insufficient again, so that in the fall of 1873 I sold at 27 cents, taking my whole crop, light and dark, together, while in 1874 I received 28½ cents per pound for the whole of my crop. Those prices brought more persons into the business, which, with but little loss in wintering, caused honey to drop, so that 26 cents was the price I obtained in 1875, while in 1876 the supply was again adequate to the demand, and 25 cents was the selling price.

That the readers of the American Bee Journal may know something of the past, without going over the matter for themselves, I have carefully looked up the market reports as given in our bee-papers, and here give an average of quotations as I found them. For 1874, 28 to 30 cents; 1875, 27 to 30; 1876, 23 to 25; 1877, 20 to 22; 1878, 12 to 16; 1879, 20 to 22; 1880, 18 to 20; 1881, 18 to 22; 1882, 22 to 25; 1883, 18 to 20; 1884, 17 to 19; 1885, 15 to 18; 1886, 14 to 16; and during the past 10 years the prices have ranged between those of 1886 and the 13 to 15 cents of the present. Previous to 1874 I fail to find any quotations in any of the bee-papers which I have.

From the above it will seem that honey quotations at present, and for the past 10 years, are fully 100 per cent. lower than they were in the early seventies. Another thing, which is, that honey in such shape as was sold from 1868 to 1873 at 25 cents or above, per pound, would not net to-day over 6 to 8 cents in any market. To bring from 13 to 15 cents now, honey must be very fancy, in one-pound-sections, without glass, which means nearly if not quite six times the labor and expense to the bee-keeper that six pounds of honey, in one box, meant 25 to 30 years ago, so that honey really does not bring, taking all these items into consideration, much more than one-third what it did "years ago." Wherein lies the trouble? Is it not overproduction, which my old friend of years ago said would be no factor "in this generation?" If not in overproduction, wherein does it lie? Will not some one tell us, for when we know the cause we may be able to apply a remedy?

Borodino, N. Y.

CONVENTION PROCEEDINGS

The Ontario Bee-Keepers' Convention.

The annual meeting of the Ontario Bee-Keepers' Association was held in Brantford, Jan. 15, 16, 17, 1896. The almost entire absence of a honey crop last year prevented a large attendance, and it was noticeable that some of those present were not in the best of humor, which condition had an undesirable effect upon the harmony of the sessions—more sweetness needed. Notwithstanding the fact that a programme was prepared that might have brought out much valuable discussion, the time was so much occupied with personal differences that not only was the time lost, but peaceable members became so much disgusted and annoyed with the proceedings that almost all the utility was taken out of the convention. It is a matter of regret that expert bee-keeping delegates should gather together from the very extremities of the Province, and not have an opportunity of teaching and learning lessons from each other's experiences, to be disseminated through the press, so that smaller bee-keepers may glean points whereby they may improve their methods. We would not be understood that the majority of the members who attend this convention from year to year are unreasonable cranks, but when a few men are allowed to break the peace of the whole gathering, the directors and other officers are more to blame than perhaps they allow themselves to believe. We have attended the last two annual meetings, and have come to the conclusion that unless the directors and officers combine against such dissensions as have characterized these two conventions, the money expended in holding such would be more productive if devoted to some better directed enterprise.

PRESIDENT HALL'S ADDRESS dealt with the salient features of the industry. It was recommended that bee-keepers who get foul brood co-operate with the Inspector as carefully

as possible in stamping it out. It gave him pleasure to realize that Europeans are seeking Canadian honey; he therefore felt the necessity of having the Pure-Honey Bill passed, so that the reputation of Canadian honey may arrive at the position which will make it desirable to honey-consuming markets. The President also recommended that packages be stamped, on the same principle as the branding of Canadian cheese. [Mr. Hall's address will appear later.—Ed.]

FOUL BROOD.—The report of the Foul Brood Inspector, Wm. McEvoy, showed that 85 bee-yards were visited, 32 of which were affected with the disease. Owing to the severe frost in May, followed by the continued drouth, the brood of many colonies died from starvation, which, in many cases, was taken for disease, and therefore a great demand was made for inspection, which fact indicates that bee-keepers are becoming more anxious for visits from the Inspector than heretofore. A few years ago much opposition was met from bee-keepers who now welcome inspection, knowing that the desire is to cure and not to kill, except when a cure cannot be otherwise obtained.—[Mr. McEvoy's Report will also appear soon.—Ed.]

Among the communications read was a letter from the Rev. W. F. Clarke, of Guelph, in which the Foul Brood Inspector was strongly condemned for having destroyed a number of his colonies by fire. To this, Mr. McEvoy explained that he had spent a great deal of time endeavoring to have a cure effected, but ultimately found that destruction by fire was the only wise method to pursue. After hearing both sides of the case, the convention endorsed the Inspector's actions in this as in all other cases. A vote of thanks was then tendered to him for his good work, and a resolution was passed to the effect that the association have confidence in their Inspector, and that they believe his method of cure is the best known.

THE PURE-HONEY BILL.—Mr. S. T. Pettit reported on the Pure-Honey Bill, which has been introduced into the House of Commons, but had not as yet passed all the readings. The purpose of the Bill is to prevent the production of sugar-honey, and ultimately to have the same effect on the honey industry of Canada as the law against "filled" cheese has on the cheese reputation and business. Mr. Pettit was one of a committee last year to go to Ottawa in its interest, and, although he did not succeed in getting the Bill through, he felt convinced that all that is necessary for its passage is continued effort by the association for a short time longer. One very good argument in favor of such a Bill was the presence of a sample of adulterated honey brought to the meeting by one of the directors, who obtained it from a grocery-store. It was in a glass vessel sealed with a paper stamped "Canadian honey." The stuff was mildly sweet, light in color, and thin. While it was not unpleasant to taste, its after effects were of such a character as to disgust a consumer with honey as an article of food. A sample of this so-called "Canadian honey" was recently subjected to the Dominion Analyst for analysis, when it was found to contain too much glucose syrup and more than the average per cent. of water. It was, therefore, evident that it had been adulterated with these substances. The only opposition offered to further pressing the passage of the Bill was by one member, who has always claimed that the Adulterated Food Act already covers the necessary ground. He therefore considered it unwise to expend any more money over it. It was, however, claimed by several intelligent members that the presence of such stuff as was proved to be upon the market showed that the passage of such an Act as is now being pushed is necessary in order to develop a demand for honey and to protect honest honey-producers. It was resolved that Mr. Pettit's report be accepted, and also that the former committee still prosecute the Passage of the Pure-Honey Bill.

HONEY-PACKAGES.—The question was asked, whether it were wiser to sell honey in packages, charging for gross weight for honey and package, or for net weight of honey. For instance, when honey is 10 cents per pound, is it wise to sell 10 pounds net of honey in a pail, or should the value of the pail be retained in honey? Several dealers claimed that the price of the vessel should be added to the honey in asking a price, as it was difficult to get extra for the pail, or get it returned in good order. It was, therefore, advised that 25-pound pails be used as far as possible, because the value of the pail was relatively small compared to the honey contained, and it is also of more value to the receiver, because of its size.

FOUNDATION IN SECTIONS.—While all agreed that at least a starter be used all around the edge, so as to avoid creep-holes between the wooden side and the comb, it was generally conceded that whole foundation of clear wax, about 10 or 12 feet to the pound, gave very satisfactory results in the production of comb honey. Too heavy foundation is apt to cause "fish-bone" comb.

SHIPPING COMB HONEY.—It is fairly evident that Manitoba will furnish a good market for a large quantity of comb honey annually, if of good quality and well packed. It was advised that sections to be shipped should be full and uniform, and packed so tightly that they cannot shift or rub. Mr. Hall, who has shipped as high as \$1,100 worth to Manitoba in one shipment, without any loss, recommends that not less than 200 pounds be put into a package, and that the package be long in form, and have two handles, so that it may be lifted by railroad men, and not rolled and tumbled. Mr. McKnight, who also ships to Manitoba, recommends using light but strong cases holding 12 sections each, packed on edge, three high and four deep. He also recommended that the case have a glass front, and that the crate be protected by laths nailed up and down the ends, the back, and cornerwise across the front; the sections should have comb attached all around, and that excelsior be used as packing to avoid crushing.

VENTILATION OF HIVES IN WINTER.—It is now generally admitted that upward ventilation is not desirable, but that front and back bottom ventilation should be given. It was recommended that the top of the hive be hermetically sealed with propolized cloth. For out-door wintering, six inches of straw should form the top, side and back packing; a less thickness is desirable on the south side, so that the warmth of the sun may penetrate to some extent on bright days. It is advisable to have a dead-air space on top. The subject of packing was gone into, and brought out points to the effect that dry leaves, well packed in, are entirely best when there is any possibility of rain getting in; but where a positively water-tight roof and box is used, dry sawdust answers all requirements.

WINTERING BEES.—Mr. Pettit is of the opinion that in the dead of winter, if bees are in the very best condition, they will be almost perfectly quiet. Other good bee-keepers claim that the bees are all right when a low hum of contentment, so-called, can be heard. The most generally accepted theory offered was that in large apiaries it is impossible to have all the colonies quiet at once. When they are in the best condition, the different colonies will each have their spells of humming and quietness.

BUSINESS.—The by-laws were adjusted to harmonize with the new Agricultural Act. It was also resolved that hereafter the reports of affiliated societies be in by Dec. 1, instead of Jan. 1, so that the annual meeting may be held in December.

A resolution was passed to the effect that each affiliated society be entitled to send two delegates to the annual convention, and the fee of \$5.00 paid by each affiliated society entitles the delegates to full privileges of members in voting, etc.

It was resolved, on recommendation of a committee appointed by the President, that the President, Vice-President, 2nd Vice-President and Secretary each represent on the Board the district from which they come, and that each of the nine directors represent one of the remaining nine districts, so that each district has representation.

ELECTION OF OFFICERS.—President, R. F. Holtermann, of Brantford; 1st Vice-President, J. K. Darling, of Almonte; 2nd Vice-President, W. J. Brown, of Chard; Secretary, W. Couse, of Streetsville; Treasurer, M. Emeigh, of Holbrooke. Auditors—J. D. Evans, of Islington; D. W. Heise, of Bethesda. Foul Brood Inspectors—Wm. McEvoy, of Woodburn; F. A. Gemmill, of Stratford. Directors—W. B. Holmes, of Atheus; Allen Pringle, of Selby; J. W. Sparling, of Bowmanville; A. E. Pickett, of Nassagaweya; J. Armstrong, of Cheapside; A. E. Sherrington, of Walkerton; F. A. Gemmill, of Stratford; W. A. Chrysler, of Chatham; N. H. Hughes, of Barrie. Delegates to Fair Boards—Toronto, R. H. Smith, of Palmerston; Western, John Newton, of Thamesford.

The next annual meeting will be held in Toronto in December, 1896. The date was left to the Executive.

AN OPEN SESSION.—The second evening's meeting was thrown open to the citizens, and partook of the nature of an entertainment. Mayor-elect Elliott very ably filled the chair. After welcoming the bee-keepers to the "Telephone City," he made a few well-chosen and pleasing remarks. He expressed his appreciation of the work the Foul Brood Inspector is doing, and also wished the association success in obtaining pure honey legislation. Mr. McKnight, of Owen Sound, delivered an eloquent address, which was attentively listened to. Mr. Holtermann, the newly-elected President, gave an interesting address on the past, present, and future of bee-keeping. Some references were made to the care of honey, and to the natural history of the bee. He also hoped to see Canadian honey placed upon the English market by the Dominion Government. The programme was interspersed by highly-appreciated selections given by the "Telephone City Quartette." At the close of the entertainment the delegates were right

royally banqueted by the newly-elected President.—The Farmers' Advocate.

The Bee-Convention at Kankakee, Ill.

On Feb. 8 about 25 bee-keepers of Kankakee county met in Kankakee to discuss apiculture and the desirability of organizing a county society. The idea of permanent organization met with hearty support, and resulted in the election of D. L. Durham President, F. S. Tinslar Secretary, and the appointment of a committee to draft a constitution and by-laws to be presented to the next meeting.

It was the general opinion that 1895 was a very profitable season here for bee-keepers, and that all bees went into winter quarters in excellent condition. One bee-keeper reported his crop (from 19 colonies, that increased to 27 during the season) at an average of 123 pounds of comb honey in sections, which we consider a very good showing. Sweet clover seems to have been the main source of supply.

Mr. Durham had owned bees five years. He had 4 colonies, and took 150 pounds from 2 of them last summer. Most of the honey was from sweet clover and heart's-ease.

Dr. Pottinger had 16 colonies, and took 300 pounds from 5 colonies.

Dr. Tinslar had only 2 colonies, began late, and had 18 pounds of surplus from one hive.

B. T. Brady had one colony, and secured 80 pounds of surplus, mostly basswood and sweet clover.

William Mote had 8 colonies, and secured 200 pounds, mostly sweet clover.

William Cooper had kept bees since 1853, often as high as 80 colonies, now down to one. He came to learn, not to talk.

Mr. Saltsider had 16 colonies, and took off 1,008 pounds, mostly sweet clover.

L. B. Bratton had 35 colonies in various hives; never made a business of it; took probably 1,000 pounds last year; sold and gave away a great deal.

F. C. Stewig had 3 colonies, and took off 160 pounds—basswood and sweet clover.

B. T. Graham started with 18 colonies last spring, increased to 26, and had 2,210 pounds, mostly basswood and sweet clover.

Chas. Lehnuz had 6 colonies that gathered 170 pounds. He had kept bees many years, but only since using frame hives had he been satisfied.

Charles Ring had 30 colonies to start with, and took, from 20, 2,450 pounds, and from the other 10 he extracted 250 pounds, and had as much left. Last season was a good one. Without sweet clover last year the crop would have been a failure.

Some discussion then took place on various matters, and it was decided to make the organization permanent, and hold frequent meetings.

F. S. TINSLAR, Sec.

The Seneca County, N. Y., Convention.

The 13th annual convention of the Seneca County Bee-keepers' Association was held Dec. 19, 1895, representatives from adjoining counties being present. This was one of the most interesting and instructive meetings yet held by the Association. The most progressive bee-keepers of this and Tompkins county were among the speakers, who gave valuable information, gleaned from many years of experience.

The forenoon session consisted mostly of a social order, and initiating and getting acquainted with new members. After partaking of a bountiful repast served by the lady members, the meeting was opened by song and prayer, followed by the President's address, by Fred S. Emens, a very able essay, ending with a poem, "The Honey-Bee." "Advantages of being a member of the Bee-keepers' Association," J. F. Hunt, who thought that the instructions given at these meetings were often of great value in an apiary, and recommended that the officer assign each member a certain subject to experiment on and report at the next meeting; also to establish uniform prices at home to improve our home market.

Reports of members of honey crop and success in wintering the past season: The average winter loss reported being 14 per cent., the greatest loss being 40 per cent., the smallest loss 4 per cent. The greatest losses reported were those just starting in the pursuit, while the smaller losses were reported by those ripe in experience of apiculture. The same could be said of the report of the honey crop, the greatest amount of surplus honey being taken by those of the most experience.

The total number of pounds of honey reported by the

members was 50,000, gathered by 750 colonies of bees. It is estimated that there was produced in the county 20,000 pounds of honey, gathered by 500 colonies of bees, not reported.

The question-box was next opened, followed by some valuable talk by B. D. Scott, on the home market and its improvement. Best method of preventing increase, also to increase, by J. C. Howard. Remove the queen about June 20; if you do not wish to increase, destroy her and let the colony rear a new queen. To increase, place the queen with about three frames of brood in a new hive, giving them frames as they are in need of them.

The following officers were elected for the coming year: President, F. S. Emens; Vice-President, J. B. Whiting; Secretary and Treasurer, C. B. Howard.

The next meeting will be held at Hayt's Corners, at the call of the officers.

Romulus, N. Y.
C. B. HOWARD, Sec.

The Mesa County, Colorado, Convention.

An interesting convention of Mesa county bee-keepers was recently held.

Mr. J. U. Harris being chosen as temporary chairman, called the meeting to order, and in a few well chosen words stated to those present that the meeting had been called to arrange co-operation in buying supplies and disposing of honey at better prices; and for the general diffusion of apicultural knowledge.

On motion, J. U. Harris was chosen President, M. V. B. Page Vice-President, M. A. Gill Secretary, and J. P. Utterback Treasurer, by acclamation; the President appointed an Executive Committee consisting of Messrs. Kane, of Fruita, Wm. Dittman, of Plateau, and J. R. Penniston, of White-water; a committee of three was appointed, consisting of Messrs. Page, Patterson and Gill, to draft a constitution and by-laws.

The question was raised in regard to foul brood. Mr. Kane, of Fruita, stated that there was at the present time a great deal of foul brood existing in the lower end of the valley. All seemed to be alive to the fact that it was their duty as an organization to stamp out this disease in the county, it being ascertained through the bee-inspector, Mr. Leach, that there were at this time about 5,000 colonies of bees in Mesa county.

The Ontario County, N. Y., Convention.

At the Ontario County Bee-Keepers' Association's annual session held in Canandaigua recently, various subjects of interest to apiarists were discussed. Pres. Walter F. Marks, in his annual address, advocated the adoption by the society of a system of marketing, whereby the producers of first-class honey would be assured of securing first-class prices. He would have an inspector appointed by the society to place a stamp upon all No. 1 honey, which stamp would bear the seal of the Association, and be a guarantee to purchasers, of the quality of the product. The plan was adopted, and E. H. Perry was appointed honey-inspector.

The Secretary read a translation from a German publication, entitled, "Gravenhorst on Apis Dorsata," which contained comments on an essay read before the local association last year, prepared by Frank Benton, of Washington, D. C. After the reading of the essay it was moved by H. L. Case, that the petition offered at the last annual meeting for the introduction of the Apis Dorsata be endorsed by the Association. This was done, and the Executive Committee was instructed to have the petition printed and circulated.

The following officers were elected: President, W. F. Marks, of Chaptinville; Vice-Presidents—Lee Smith, H. L. Case, E. H. Perry; Secretary, Ruth E. Taylor, of Bellona; Treasurer, Heber Roat; Honey-Inspector, E. H. Perry, of South Bristol. The Association has a membership of 40, including honorary members.

The question-box was an interesting feature of the meeting. Among the exhibits were different samples of comb foundation, manufactured by J. Van Deusen & Son, A. I. Root Co., Schmidt & Thiele, and Ang. Weiss. J. Van Deusen, of Sprout Brook; F. A. Salisbury, of Syracuse, and C. B. Howard, of Romulus, Secretary of the Seneca County Bee-Keepers' Association, were welcome visitors, and participated in the discussions of the meeting.

Every Present Subscriber of the Bee Journal should be an agent for it, and get all others possible to subscribe for it.

Questions AND Answers

CONDUCTED BY

DR. C. C. MILLER, MARENGO, ILL.

[Questions may be mailed to the Bee Journal, or to Dr. Miller direct.]

Different Names for Sweet Clover.

In the seed stores of San Francisco they know nothing of sweet clover seed. What is its other name?

CALIFORNIA.

ANSWER.—*Mellilotis alba*, melilot, white melilot, Bokhara, Cabul clover, and honey-lotus.

Another Odd-Size Frame.

What objections can be raised against a 10-frame hive with frames 10x15½ inches, inside measure; hive 17 3/16-x13 3/8x10½ high, to correspond with T super for 28 sections, contents 3,000 inches, making a more conducive brood and wintering possibility?

J. M.

Carthage, Ohio.

ANSWER.—One objection is that the frame is an odd size. Aside from that you'll probably like it. The frame is not so large as the Dadant or Quinby.

Double or Single Walls for Wintering.

1. Which is best, double or single walled hives to winter bees on the summer stands, where the thermometer indicates 20° below zero at times?

2. What will bees build up on quickest in the spring? Why?

MASS.

ANSWERS.—1. If the hives are to be left without any protection, perhaps the double walls would winter best. A cellar might be better than either.

2. I don't know. Some say they'll build up best in double walls because warmer; some say in single walls because the heat of the sun has better chance to get in its work.

Transferring and Other Matters.

1. I have bought an 8-frame hive, put in full sheets of brood foundation and starters of two or three inches in the sections. I want to get my bees into this hive at the right time, and in the right way; that is, in a way that can be managed by a man who never saw bees handled at all. Is Mr. Heddon's "short way," given on page 299 of the "A B C of Bee-Culture," the one for a novice? Can I make two colonies while transferring?

2. Now, as to comb honey or extracted: Recently you advised an inquirer to try both. Would you give this counsel to one who lives in a country that produces honey nearly uniformly dark-colored? or is such honey more salable in the extracted form?

3. Should a quilt, cloth, canvas, or some such thing be placed over the sections? None came with my hive; but I have seen something referred to bearing all those names, and more.

4. Mr. Root advises that hives be placed on the ground; but I am getting old, and don't like stooping much. All the bees I have ever seen have been placed on benches. Will that not do for me?

There are not many bees kept around here (about 5 miles from Oakland), and "I don't know" whether this is a good place for bees or not; but I don't expect to do much more than supply some of my friends, and enough for my own family; although an addition to my income would not come amiss these hard times.

5. Perhaps you will excuse me for saying that there are too many words in the "A B C of Bee-Culture," and it takes some time to find what you want.

6. Another thing: We are told to open the hives while many of the bees are out in the fields, and keep in subjection those that are at home, by smoking. But are not bees returning all the time, and how will they behave when they find some one meddling with their hive? G. W. W.

Oakland, Calif.

ANSWERS.—1. If there is no one to watch for swarms, perhaps you can't do better than to use the Heddou plan of transferring. If convenient to watch for swarms, it may be better to let them swarm naturally, hive the swarm in the new hive, setting it in place of the old hive after removing the old hive to a new place, then 21 days later drive the bees, either uniting with the swarm or putting in a separate hive. If you are anxious for increase you can make two colonies in this way, or in either way. If the colony is not very strong, better keep it all in one.

2. Probably extracted will be the best thing for you, but I think you may be interested in getting a little comb honey, if for nothing but the fun of it.

3. Your hive is probably dovetail, which has a flat cover, and makes no use of sheets or quilts. When supers are put on the hive, the flat cover is put directly over the sections without any sheet or quilt. Sheets or quilts are not used as much now as in the past.

4. A few bee-keepers prefer to have their hives set up high enough to work at them standing without stooping over. I'm like you, I don't like to stoop. More than that, I'm too lazy to stand up when I can sit down, so I set my hives close to the ground, and always have a seat to sit on when at work at a hive. It is possible, however, that in some places it may be better to have the hives elevated by way of protection from some animal or insect that may be an enemy to the bees.

5. Yes, I'll excuse you, for the present, for saying there are too many words in the "A B C of Bee-Culture." Wait just a little while, and you'll say there are not enough. Some things, perhaps many things, in it are given in which you feel no particular interest, and others are treated more fully than you care for, but there are others who wouldn't miss those superabundant words for a good deal.

6. A bee stings in defence of its life or its home. A pinched bee stings in defence of its life. A free bee only in defence of its home. A bee that comes from the field has nothing to do with the defence of its home, and I don't believe you could get such a one to sting in any other way than by catching and pinching it. But as a matter of actual practice, handle the bees when it suits you, providing it isn't too cold. You'll find times though, when they are so cross that it will best suit you to let them alone, especially when there is a sudden check to the honey-flow.

Combs With Old Dead Brood.

Last fall, in taking frames out of the hives and replacing with frames filled with honey for the bees to winter on, I found 4 or 5 frames that I took out contained a small amount of brood. These frames are all nice worker-comb. I set them away in the shop. Will this dead brood do any harm to give to the bees this spring, or would I better melt the combs up? Luce, Mich.

W. C.

ANSWER.—It is not at all likely that the dead brood will do any harm, only it will be well not to give too much of it to one colony at the same time. The bees will do wonders in the way of cleaning up dirty combs, but it is possible to give them so much nastiness that they will desert the hive rather than undertake the job. If, however, the dead brood is dry, as it probably is, there will hardly be any danger that you will overdo the matter.

Nucleus-Box Method of Making Nuclei.

In Mr. Doolittle's work on "Queen-Rearing," he gives a method of making nuclei by means of the nucleus-box, where one has bees in an upper story and queen-excluder between the two stories. I want to make some nuclei in nucleus-boxes for the purpose of introducing some virgin queens, and perhaps some valuable queens from a distance, but I do not want to put on any upper stories. Would there be so much danger of getting the queen as to deter one from shaking the bees from the outside frames of any colony that could spare them, if you wanted to make nuclei in this way? E. B.

ANSWER.—If I understand correctly, the risk would be too great. I suppose you're perhaps counting that the queen would not be likely to be on one of the outside combs. Of

course she is, or has been, wherever there is brood, and whenever you find a frame outside the brood that has bees enough on it to make it worth while to take, the queen may think it worth while to be there.

If you're going into the business of making nuclei, let me tell you an item that perhaps you don't know: A queenless colony is ever so much better than a colony having a queen, if you want to take away bees for a nucleus. Take the frames with adhering bees from a colony having a queen, put each frame separately in a nucleus hive, and so many of the bees will return to the old colony that enough will not be left to take care of the brood. But take the frames in the same way from a queenless colony, and the bees will pretty much all stay just where they're put. At least that has been my experience in a number of cases.

If I wanted to make nuclei, and didn't want to look for a queen, I think I'd do something like this: Divide the brood and bees of a colony into two equal parts, putting them in two hives side by side on the old stand. Four days later lift out the frames with bees and put them where you want them, taking them from the hive that contains no eggs.

Wood-Veneer Foundation.

What about the wood-veneer foundation mentioned some time ago. Is it in any way superior to all-wax brood-foundation? H. B.

ANSWER.—I don't know. I never saw any of it, and was not prepossessed in its favor, because at one time foundation with a tinfoil base was lauded, and failed on trial. But some who have tried the foundation you mention say they have found it a success. It will be in order for any, or all, who have tried it, to say with what result, whether successful or not.

Laying of the Queen—A Boy's Question.

1. As far as I have learned, the queen lays her egg in the empty cell. Now, is the cell filled with honey after the egg is put in, or is the cell capped over without anything in but the egg? As I am a young beginner, I would like to learn all I can about bees. W. L. Z.

ANSWER.—I remember in one instance to see an egg in a cell with pollen in a hive with a normal laying queen, but I never yet saw an egg in a cell with honey. The egg is laid in a clean, empty cell, hatches out into a little grub in about three days, then for about five days the nurse-bees feed it, and then it is sealed over. No honey is put into a cell that contains an egg or a larva. It would be a good plan for you to get a text-book on bees, that would inform you about this and many other things.

Producing Extracted Honey—Comb Honey in the Out-Apiary—Separators or Full Sheets of Foundation?

1. In working for extracted honey, would you use full-size or half-depth frames above the brood-chamber?

2. Would you use a queen-bar between the brood-chamber and extracting-supers?

3. Can I run an out-Apiary for comb honey, if I have the queens' clipped, without having some one to watch for swarms?

4. If I use separators, do I need to use full sheets of foundation in sections? Or is it more profitable to use full sheets, anyway? H. H. P.

Baraboo, Wis.

ANSWERS.—1. If I didn't care anything for expense, I'd use half-depth. The full-depth have the advantage that they can be used interchangeably in the brood-chamber. But some think that the honey is affected by being in combs that have contained brood, so that, all things considered, the weight of argument may be in favor of the shallow frames for surplus honey. Dadant says the queen is not so likely to go into shallow frames where no excluders are used.

2. With deep frames I should want excluders. If shallow frames are used in the super it is possible that excluders might not be needed.

3. I don't know. I've done it for some years, but it might be more satisfactory than it is.

4. Although there isn't much difference, you'll probably get along better with full sheets than starters when you don't use separators, but so far I have thought it advisable to use both full sheets and separators.

THE OLDEST BEE PAPER IN AMERICA

THE AMERICAN BEE JOURNAL

ESTABLISHED IN 1861

PUBLISHED WEEKLY BY
GEORGE W. YORK & COMPANY,
 Editors and Proprietors,

118 Michigan St., CHICAGO, ILL.

REGULAR CONTRIBUTORS :

G. M. Doolittle, of New York. Prof. A. J. Cook, of California.
 Dr. C. C. Miller, of Illinois. Dr. J. P. H. Brown, of Georgia.
 J. H. Martin, of California. Rev. E. T. Abbott, of Missouri.
 Chas. Dadant & Son, of Illinois.

\$1.00 a Year—Sample Copy Sent Free.

[Entered at the Post-Office at Chicago as Second-Class Mail-Matter.]

Vol. XXXVI. CHICAGO, ILL., MAR. 12, 1896. No. 11.



Removal Notice.—In order to get more room, we have removed from 56 Fifth Ave. to 118 MICHIGAN ST., where all our correspondents should now address us. We are on the 3rd floor in the large brick building on the southwest corner of La Salle and Michigan Streets—one block north and one block east of the Chicago & Northwestern Passenger Station. Remember, we are on Michigan Street, not Michigan Avenue. The latter is used almost wholly as a boulevard and residence thoroughfare, while the former (where we are) is a business street.

The Toronto Convention Report is now issued in pamphlet form, and will be mailed free to those who became members of the North American at Toronto, in a few days—just as soon as we can reach it after getting settled in our new office. This fulfills our offer to furnish a bound copy of the Report to Toronto members free of cost; any one else desiring a copy, can have it by sending us 25 cents in stamps, when it will be mailed promptly. As we had less than 100 copies of the Report bound, it will be necessary to order at once, if you wish to get it.

Mr. Thomas G. Newman—the Manager of the National Bee-Keepers' Union—expects to remove to San Diego, Calif., with his family about April 10. This will be welcome news to his many friends in the sunset State. Mrs. Newman's health, and that of Mr. N., have been quite bad for some time, and it is with the hope of recuperating weakened energies that they make the change. We trust the invigorating climate of southern California will do wonders for them, and that they will favor the Bee Journal with frequent reports.

Next week we will publish an article from Mr. Newman, on the amalgamation subject. Hon. J. M. Hambaugh puts in a vigorous protest this week, on page 162.

All Honey Commission-Men are not thieves and swindlers, as some of our readers might think from reading recent denunciations of certain unreliable ones in the Bee Journal. No, sir; we know there are good, honest men in the commission business, and we believe that all who are found in

the honey and beeswax dealers' list on another page are treating their customers all right. If not, we want to know it, for we will not keep their names in the Bee Journal after being assured of any crooked dealing on their part.

During the past year we have refused and cast out what will amount to a loss to us of about \$200 a year in advertising, just because we became satisfied that they were not treating customers as they should. As we have said before, we will not knowingly advertise for a dishonest firm. We will endeavor to protect our subscribers in every way possible, even if we must suffer the loss of money from advertising that we need. But we believe our readers will appreciate our efforts, and send us more than enough new subscriptions to make up for all loss in advertising from any dishonest commission-men.

Mr. E. Kretchmer, of Red Oak, Iowa, thinks he was slighted on page 136, where several of the leading supply manufacturers were named, and Mr. K. was omitted. Of course, it was quite unintentional on our part; we had no thought of doing him, or any other firm, an injustice. Come to think of it, the Page & Lyon Mfg. Co., and J. Fornbrook, of Wisconsin, should also be included.

From a publisher's standpoint, it might easily be decided that "the largest" firms are also those that should advertise the most extensively. That may be one reason why some were overlooked. We should think that large bee-supply manufacturers would also advertise largely in the best bee-papers, for the papers really create the demand for new supplies in their untiring effort to reach every bee-keeper in the land. Sometimes we think dealers and manufacturers do not sufficiently appreciate this fact. But, of course, they are supposed to know their own business best, and we may be wrong about it. However, we venture the suggestion that the most successful in any line do the most advertising—judiciously, of course.

"The California Bee-Keepers' Exchange is now fully on its feet," writes Prof. Cook. "Articles of incorporation have been adopted; directors appointed for each of the counties of Southern California; one of the best bee-keepers of the State elected for President, and a very bright business man appointed as Secretary and Manager. This last gentleman will give his entire time to the Exchange, and if we may judge from the enthusiasm already shown in favor of the movement, it will not be difficult to secure the co-operation of the whole bee-fraternity of Southern California. This gentleman will at once commence to work up markets for the coming year, so that by the time the honey is ready for sale, it will be known just where it is to be sent, and what prices may be secured. It is expected that the membership fee, together with one-sixth of the honey crop—which every member of the Association is to promise—will give all needed funds for the necessary preliminary work. The bee-keepers are wide-awake in this matter, and are very hopeful of the results."

A Bee-Keepers' Arbor Day has been suggested by Mr. N. Levering, the editor of the apiarian department of The California Cultivator. He says:

Bee-forage is a most important question for bee-keepers' consideration on account of the diminution of the forage by agriculture and grazing, which, in part, accounts for short honey crops in many parts of the country. An increase of bee-forage will remedy the deficiency in a great measure. This can readily be done by concerted action on the part of the apiculturists who reside in the mountain districts, and wherever there are lands not susceptible of cultivation, by planting trees whose bloom yields nectar, and such other plants and vegetation as contribute to the bee's storehouse. This would soon bring about a perceptible increase of honey as well as bees. Planting by a few would secure the desired object only to a limited extent, whereas if all plant each year for a

few years the result would be most gratifying. The wonderful advantage that would be derived from such a movement can readily be seen by every careful observer and practical apiarist. The gain in honey and the saving of bees owing to the proximity of feed would be very remunerative for the labor and expense incurred.

I sincerely trust that the State association, at its called meeting, will take some action in the matter by fixing a day for the planting of trees and other feed, to be known as "Bee-Keepers' Arbor Day," and urge bee-keepers to organize Bee-Keepers' Arbor Associations throughout southern California.

I have given the matter considerable thought, and regard it most important and feasible, and deserving the most careful consideration of all who are interested in the future prosperity of apiculture.

All kinds of forage should be planted that will contribute to the bee, and are most suitable to the soil and locality.

In trees I would call special attention to the sugar eucalyptus. It is a vigorous bloomer, rich in nectar. Other varieties that bloom at various seasons of the year should be planted, among which are early and late willow. The acacia is also good, and requires but little and often no irrigation. The sages, horehound, and many other plants of a nectar-yielding character, the seeds of which can be sown upon the waste-places of the mountains during the rainy season will soon repay in a luxurious growth and much nectar. If this suggestion is not acted upon now, the time is not far distant when it will be.

We think Mr. LeVering has made a good suggestion, and we hope that "The Bee-Keepers' Arbor Day" will not be limited to California, but that everywhere bee-keepers will resolve to plant annually some honey-yielding trees or other forage for their bees. Very often they may be able to induce their neighbors to plant or sow what will be beneficial to bees, and thus will the object be doubly helped. Why not begin this spring to plant and sow?

Benton Book Resolution.—On March 3, we received the following letter from Mr. Hilton, which refers to the Benton Book:

WASHINGTON, D. C., Feb. 28, 1896.

HON. GEO. E. HILTON, Fremont, Mich.—

My Dear Sir:—My resolution to have a reprint of the work on Apiculture, passed the Senate at yesterday's session. I think there will be no trouble in securing its passage by the House.

If this result is secured, of course you know how pleased I shall be to send copies to you as you may desire.

Very truly yours, J. C. BURROWS.

So there is good prospect of every bee-keeper being able to have a free copy of "The Honey-Bee," by Mr. Benton.

Mr. Burrows is one of Michigan's able Senators in Washington, and shows his interest in bee-keeping by his works. The Senate has done a wise thing in thus recognizing apiculture, and no doubt the House of Representatives will also distinguish itself by endorsing the Resolution as soon as it has a chance to do so.

Somnambulist's Big Yield of honey failed to appear in connection with the other large reports on page 43, but it was given in the Progressive Bee-Keeper later, and is as follows:

Friend Flanagan encourages us by reference to many of the large crops in the past, and Editor York copies the article complete in January 16th number of American Bee Journal, and at the same time gives any others who may so desire a chance to blow, by kindly inviting them to relieve themselves through the medium of this journal, but as that would incur extra postage and delay, I'll take my chances right here and now, and just say that a certain sleepy-head not only dreamed of, but realized, 22,000 pounds of comb honey from 114 colonies, spring count, in a single season.

Pretty good for a "sleepy-head." But, surely, Sommy must have been awake that season, in order to do the necessary hustling to take care of so large a crop.

Now is the Time to work for new subscribers. Why not take advantage of the offers made on page 175?



Growing Basswoods from Cuttings.

In Gleanings I read about how to grow basswood and mulberries. Either will grow from cuttings, as will all soft woods, if cuttings are made from ripe wood. For basswood and mulberries, take off this year's growth, soon after the leaves have fallen off. Cut from 8 to 12 inches long; tie up in small bundles; place in damp sand, not wet; for if too wet they will die; and if kept in a warm cellar they will have calloused over by spring, when they can be carefully set in rows, and covered with a mulch of straw or leaves so as to keep them damp and shaded. They will soon start out leaves and roots, and will grow, if properly cared for, six feet high by fall.—JOHN CRAWFORD, in Gleanings.

Alfalfa in Ohio—Cultivation and Value.

The Ohio Experiment Station has made repeated attempts to cultivate it, both at Columbus and in Wayne county, but the difficulty of getting a stand is so great, and the plant is so particular about its soil, that we do not expect its culture ever to become general in Ohio, although there are some regions of the State where it would seem that it ought to thrive.

To those who wish to experiment with it we offer the following suggestions: Select a loose soil, preferably sandy, lying above a gravelly or porous sub-soil, with, if possible, a subterranean water supply. The soil conditions which are found in many of our river bottom lands would seem to be most favorable. Avoid a soil on which water stands, or one having a hardpan near the surface.

Prepare the land by plowing and harrowing most thoroughly, as soon as it can be worked in the spring. Sow the seed (which should be American grown) at the rate of 20 to 30 pounds to the acre, and cover it with a light harrow. When the weeds have grown to sufficient height, clip them off with a mowing machine, with the cutter-bar turned up so as not to cut close to the ground, repeating this as the weeds grow during the season.

No crop is to be expected during the first season, but it should give two cuttings the second year, and after that about three cuttings each year. If a good stand is secured on snitabile soil it will not need renewing for many years.

The New York State Experiment Station, at Geneva, has succeeded in securing a fine stand of alfalfa, which has thus far endured the winters, and there are isolated instances of successful culture on the gravelly loams of Southwestern Ohio and on the sandy lands of the lake shore.—Ohio Exp. Sta. Bulletin.

Cleansing Wax With Acid.

The following questions are asked Dr. Miller, in American Bee Journal, page 745:

1. How much sulphuric acid should I apply to a gallon crock full of old combs to take the wax out of the cocoons?
2. Is it injurious to a tin vessel?
3. How is it applied to old combs?

L. H. L.

ANSWERS.—1. I'm not familiar with the matter from experience but I think about a small tablespoonful to a gallon of water.

2. Yes.

3. I think the wax is stirred in the water, and allowed plenty of time to do its work, then the wax is melted and separated as usual.

From answer 3 it would appear that Dr. M. means to stir the combs in cold water with the acid. Now, that is just what stumps me. I never tried a scheme of that kind, and do not believe that the acid could do any work, so far as purifying the wax is concerned, no odds how long the combs were left in the solution. Refiners use sulphuric acid to cut the dirt and color out of crude oil, and then cut the oil out with caustic soda. But oil is a liquid; and if you want acid to cut the dirt out of wax you must turn that into a liquid. This can be done only by heat. The doctor conveys the idea that the work of the acid is done while the old combs are lying in the solution of cold water and acid. This is the one thing, the only thing, that I didn't know. This is what surprised and astonished me—astonished me so much that I don't believe it yet, and I will tell you why. You notice the answer concludes, "then the wax is melted and separated as usual." Now, Doctor, there

is where the acid does its work—on the liquid wax; for when would it drive the dirt to the bottom, out of old comb? This process will cleanse the wax if it is boiled in the same water in which it is soaked because the acid is in it. But it is bad engineering. It will boil over very easily.

Now, L. H. L., sit down at the feet of experience, and learn. Here are three things you should not do: 1. Never go near a kitchen stove to melt wax. It is dangerous. 2. Don't melt it in any place where any thing can catch fire, even if the whole country burns down. 3. Never put any acid in until your wax is completely melted—every bit of it, out of your old comb. When it is done boiling, pour your acid in slowly—very slowly—stirring your wax all the time until it is milky—quite milky. When you have thoroughly stirred and mixed it, let it settle. The acid drives all the dirt to the bottom, and in a little while you can dip it out carefully—not going to the bottom of the wax—and run it into merchantable cakes.—Skylark, in *Gleanings*.

The Dark and the Bright Side.

"Well! the bees will die anyway, fix them as you will. I do not want much to do with the pesky things. They are too uncertain. You never know when you are going to have a good year for honey or whether it will pay to fuss with them."

"I think you are looking all on the dark side of bee-keeping. We must look on all sides for a little profit. I get a great deal of pleasure from my bees, as well as considerable profit some seasons. Bee-keeping is a good school-teacher. It teaches one patience and perseverance."

"We farmers must work at something that will pay."

"That is very true, but do you know when you plow and drag your ground for potatoes that you will get a crop? You must mark the ground, plant and fertilize, cultivate, hoe, put on paris green three or four times, hill them up, dig them, carry them into the cellar and sell them for only 15 cents a bushel, if you sell them just now. Very soon you may hear they are 20 cents, and thinking they will be no higher in price you will carry them out of the cellar, load them into a wagon, draw them to a car perhaps three or four miles away, and for over 40 bushels you will receive \$8.00. This is not very large pay for the amount of work, but it is what is being done this fall, yet you would not say you will never plant any more potatoes, or sell your farm. Our dividends did not net us more than 35 to 40 cents for 100 pounds of milk some months this season at the factory. We would not sell our cows because of the drought of one or two seasons. We must look on the bright side of things. Keep our bees and love them. Work the harder. Raise a little of many things. We as individuals and a nation are very wicked. We must learn to look to God, the source of all blessing, more than we ever have before, and we will then reap a rich reward.—MRS. OLIVER COLE, in *American Bee-Keeper*."

Three Stray Straws from *Gleanings*.

A record book has this advantage, that it can be referred to at any time, and is often useful in furnishing testimony as to events that transpired years ago.

M. Bertrand, editor of the *Revue*, accepted with favor the theory that bees inherit character from the nurses. He introduced a Caucasian queen of great gentleness into a very vicious colony, and the progeny of the new queen showed no trace of viciousness. He is now very doubtful as to the correctness of the theory.

The report of the U. S. Secretary of Agriculture quotes the English honey market as giving "Thurber-Whyland's white-sage, strained, 1-pound jars" at only 1c. a pound more than "Californian in original cans." One can not help pitying that poor cent in having so much to do in covering the expense of jars and putting up. The report innocently remarks, "It would be ruinous to send adulterated honey to England."

Importance of Strong Colonies Under all Circumstances.

Some write as though a colony could get too strong. How it is possible to get one too strong without doubling, I cannot understand. I know that, in poor seasons, only strong colonies will do well, even in getting winter stores. In a *fair* season the strong colony will outstrip the average colony; and in a *good* season the strong colony must certainly do the best, for surely two pounds of bees can and will gather more honey than one pound. I have never been able to believe that apiarists are able to get colonies so strong that they refuse to work. I admit there is a little more energy in proportion to numbers

when the energy is necessary to get the brood-nest into shape; but this does not apply to the colony already in prime strength.

I can always get more and better work in the sections when I have colonies so strong that they *must* occupy the super. If the flow comes very freely while it does last, we do not notice it so much; but when the gain is one to two, and even three pounds a part of the time, per day, it is almost impossible to get *even reasonable* work in sections with a colony that has not swarmed; while the one that swarms will do almost nothing in sections; but two colonies put together in one hive (the bees and enough brood to fill the hive) will do fair to good work.

This year (1895) our flow began June 20. My scale hive colony was stronger than the average, and was not allowed to swarm. It is a 10-frame hive. The gain from June 20 to July 15 (the extent of the flow) was an average of 2½ pounds per day. The best day's work was 6 pounds. This colony gave about 25 sections. Many other average colonies in nine-frame hives, and a few in eight-frame, gave from nothing to about one super, the majority not giving 10 good sections. In one case I put the force of two colonies in one nine-frame hive, and got two 28-section supers. Another colony on nine frames had the forces from two other colonies added, and gave three 28-section supers. All the evidence goes to show that, if I had *doubled the forces* of all, preserving the old stock in original hives, I should have had as many colonies in the end, and about doubled my surplus.—R. C. AIKEN, in *Gleanings*.

Difference in Colonies.

For instance, the colony which I would call best on May 15 might become one of the poorest by June 25, at which time the honey harvest was about to arrive. This as a rule, would be owing to a failing queen, as I have often noticed that a colony which wintered extremely well and goes to breeding rapidly in early spring, does not equal one that wintered only fairly well, but commences brood rearing in earnest on May 1. The reason is that by about May 25 to June 1 the queen in the stronger one ceases to be as prolific as the other, and this allows the bees to put the first honey coming in into the brood-combs, rather forcing it into the sections, as does the other through her extra-prolificity later on. I have often noticed that if the bees are allowed to get the start of the queen so as to store much honey in the brood-chamber during the first of the honey harvest, that colony will be an unprofitable one.

The remedy is to give each colony only as many combs as the queen will keep occupied with brood, and when a colony is found having a failing queen, either give another queen or remove a part of the brood-combs. Again, the giving of a colony a large amount of surplus room to start with has a tendency to make that colony an unprofitable one. As it has not a force of bees large enough to occupy the whole of the surplus department at once they seem to become discouraged, and instead of taking possession of a part of it, they will often cluster outside the hive, and crowd the brood out with honey, sometimes never entering the sections at all. I usually give only room in the surplus apartment to the amount of 20 pounds, and a part of this space has combs in it left over from the previous season, thereby coaxing the bees into the sections with their first loads of new honey. In a week, more room is given, and so on as I see each colony needs, as all colonies are looked after once a week at this time of year, if possible.—G. M. DOOLITTLE, in *Progressive Bee-Keeper*.

Poultry with Bees.

Dr. J. H. Ashley says in *Gleanings*: "We believe from personal experience that the raising of poultry furnishes just what we are looking for; namely, an occupation not laborious, but whose returns for faithful attention are sure, and where the most active labor comes at that season of year when bees need the least attention. This is equally suitable for the bee-keeper who does the work himself, or for him who, like ourselves, while actively engaged in professional work, wants something at home which, by way of change, furnishes pleasure and relaxation, and still makes it profitable to keep a good active man of all work. By keeping a few standard-bred fowls of a variety giving a profusion of eggs and fine bodies, we have the pleasure of seeing fine birds of uniform size and color, and having on our tables fresh eggs, and fowls of our own raising; and, even without any special effort by advertising, there will be a demand among our friends and neighbors for sittings of eggs, with an occasional call for a trio, or pen of birds from our pure-bred stock, which, sold at even a moderate price, will soon more than repay the difference in the original cost between starting with thoroughbreds and common fowls; and in nothing does blood tell more surely than in fowls."

See "Bee-Keeper's Guide" offer on page 173.

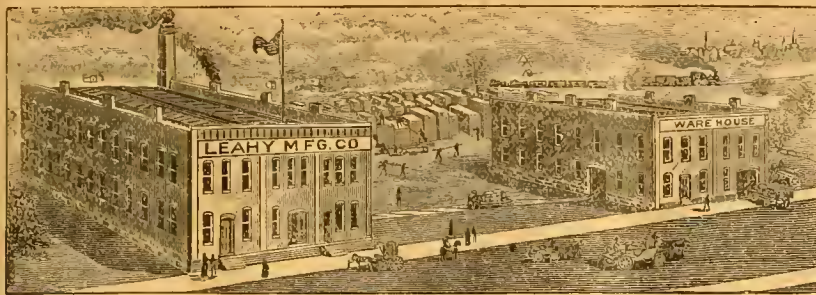

Largest Factory in the West

COMPLETE STOCK.
Good Supplies and Low Prices
Our Motto.

READ THIS—Mr. Keyes says: The 100 pounds of Extra-Thin Foundation you sent us' is superior to anything he ever saw; and I think the same. R. L. TUCKER, Wewahitchka, Fla.
Dear Sirs:—The Sections came duly to hand. Indeed, they are very nice. Yes, sir; they are as good as the best. CHARLES H. THIES, Steeleville, Illinois.

Leahy Mfg. Co.:—I have received the bill of goods. I must say they are the choicest lot of Hive-Stuff I have ever received from any place. I admire the smoothness of your work, and your close selection of lumber. Yours very truly, O. K. OLMSTEAD, Orleans, Nebr.

Dear Sirs:—The Sections arrived in due time, and are all O. K. so far as examined. They are simply perfection. I can't see how you can furnish such goods at such low prices. I hope you may live long and do well. Yours respectfully, Z. S. WEAVER, Courtney, Tex.

Gents:—I received the "Higginsville Smoker" all O. K. It's a dandy; please find enclosed stamps for another. Yours truly, ORTO ENDERS, Oswegathe, N. Y.

Gentlemen:—I have bought Supplies from nearly all the large manufacturers by the carload, and I must say yours are as good as the best. Indeed, in many lines they are the best. It is a pleasure to handle them. E. T. FLANAGAN, Belleville, Illinois.

The above unsolicited testimonials are a fair sample of hundreds we receive. Our prices are reasonable and the "Higginsville Goods" are the best.

The "Higginsville" Goods are for sale by the following parties:
Chas. H. Thies, Steeleville, Ill.
Henry L. Miller, Topeka, Kans.
J. W. Rouse & Co., Mexico, Mo.

And by a number of others.
If you need a Carload of Supplies, or only a Bee-Smoker, write to us. Remember, we are here to serve you, and will, if you give us a chance. A Beautiful Catalogue Free.

Address, LEAHY MANUFACTURING CO., HIGGINSVILLE, MO.
49A Mention the American Bee Journal.

Honey-Clovers & Buckwheat

SEED FOR SALE.

We have made arrangements so that we can furnish seed of several of the Clovers and Japanese Buckwheat, by freight or express, at the following prices, cash with order:

	5lb	10lb	25lb	50lb
Aisike Clover	\$.80	\$1.35	\$3.50	\$ 6.25
Sweet Clover	1.10	1.80	4.25	8.00
White Clover	1.50	2.40	6.00	11 00
Alfalfa Clover	.75	1.20	3.00	5.25
Crimson Clover	.65	1.00	2.50	4.00
Jap. Buckwheat	.30	.45	1.00	1.50

Prices subject to market changes.

The above prices include a good, new 25-cent two-bushel bag with each order.

Your orders are solicited.

GEORGE W. YORK & CO.,
CHICAGO, ILLS.



ONE MAN WITH THE UNION COMBINATION SAW

Can do the work of four men using hand tools, in Rippling, Cutting-off, Mitering, Rabbering, Grooving, Gaining, Dadoing, Edging-up, Jointing Stuff, etc. Full Line of Foot and Hand Power Machinery Sold on Trial. Catalogue Free.

SENECA FALLS MFG. CO.,
46 Water St., SENECA FALLS, N. Y.
1A1y Mention the American Bee Journal.

DON'T!

Buy Bees or Supplies until you have sent to us for special prices on what you need. The Goods and Prices "are right."

Our '96 Circular now ready.

I. J. STRINGHAM,
105 Park Place. NEW YORK, N. Y.

CLOSING OUT SALE!

We have at this Branch among the Stock purchased of Thos. G Newman the following stock of Sections—not of our manufacture—which we desire to close out to make room for our

Superior Extra Polished Sections.

In order to close them out quickly we offer them for the next 60 days, or while they last, at these special prices:

White Sections, 4¼x4¼.

40,500 7-to-ft. at these low prices—1,000 for \$1.75; 2,000 for \$3.00; 5,000 for \$7.00

TRIANGULAR-TOP FRAMES.

We also have a stock of Triangular Top Langstroth Frames at these Special prices:

100 for \$1.00; 300, \$2.70; 500, \$4.00; 1000, \$7.00.

On all freight orders of \$5 or less, at this Branch, please add 25c. for cartage. Catalogue Free.

The A. I. Root Co., 56 5th Ave., Chicago, Ill.

MUTH'S HONEY EXTRACTOR PERFECTION Cold-Blast Smokers, Square Glass Honey Jars, Etc.

For Circulars, apply to CHAS. F. MUTH & SON, Cor. Freeman & Central Aves., Cincinnati, O. Send 10c for Practical Hints to Bee-Keepers.

A Bargain—EARLY QUEENS.

119 Colonies Italian Bees in Chaff Hives: two acres land; good house; excellent well.

Early Queens—Tested, \$1.50; Untested, 75c.

E. L. CARRINGTON,
11A4t PETTUS, Bee Co., TEX.

WHEN ANSWERING THIS ADVERTISEMENT, MENTION THIS JOURNAL.

General Items.

Some Good Honey-Yields.

Father began keeping bees at South Chester, Vt., when 17 years old. He owned bees from that time until his death, which occurred Jan. 16, 1894, at which time we had 150 colonies. I think I was born with the same love for the little bee that father had.

The largest yield we ever had was in 1890, taking 20,000 pounds from 100 colonies.

In the spring of 1894 I fed my 100 colonies about 125 pounds of rye-flour; they bred up strong, and the last half of May and all of June they hung on the outside of hives, and did nothing but eat honey. There was nothing for them to get. Then the first of July they began on the basswood, and I extracted 10,000 pounds, besides leaving them plenty for winter. Last spring the same thing occurred again. Now the question is, does it pay to breed them up early in the season?

Some years the white clover blossoms, and the bees store hundreds of pounds of honey in June, but who can tell six weeks before hand whether it will blossom or not?

I was just reading in my last Bee Journal where some one asks how much honey an acre of buckwheat will yield. If I were to answer that question I would say it depends a great deal upon the atmosphere. Last year there was at least 100 acres of buckwheat in reach of my bees, and they did not store a pound of honey from it.

My 101 colonies in chaff hives had a splendid flight Jan. 10.

F. B. FARRINGTON,
Strawberry Point, Iowa.

A Virginia Report.

There are not many bee-keepers in Norfolk county, but quite a number in other counties in Virginia. I have kept bees but little over two years. I love to work among them. My cousin gave me one colony of black bees in a box-hive the spring of 1893. Then I got three swarms from the one colony, and but very little honey. The four colonies wintered all right without feeding. In January, 1894, I bought 8 colonies of Italian-hybrid bees, in box-hives, for \$22. The 12 colonies wintered without feeding. During the summer of 1895 I had 25 swarms from the 12 colonies. I killed 12 of the weak colonies after the honey-flow was over. I got very little honey last year.

In December, 1895, I bought 5 colonies of Italian bees in 8-frame hives from a bee-keeper in Illinois, for \$25, and the expressage on them to Norfolk was \$16. I thought that was like paying for them twice.

I have now 30 colonies of bees in good condition, wintering on the summer stands. Our hives are in rows 6 feet apart each way. We have evergreen trees between the hives. The ground is seeded with white clover, which is our main honey-plant here. A few days ago we sent for some sweet clover seed, which we expect to try this year as a honey-plant.

I can't see how any one can keep bees without taking one or more bee-papers. Norfolk, Va., Feb. 1. W. W. SEELEY.

A Beginner's Experience.

I am a novice in bee-culture, having put my first colony into a Quinby-Dadant hive June 27, 1895. My father has kept bees for the last 30 years in the box-hive, or beegum, as we call them. He has been moderately successful, considering the hives and other disadvantages, compared with the present bee-appliances; having had at one time 75 colonies, but for the want of the proper attention they have dwindled down to only 12 now.

About June 1, 1895, I happened to read an article on bees in an agricultural paper, and it just set me all a fire in bee-culture. I at once sent for "Langstroth on the

St. Joe

Is the name of the Hive you want. **PRICE-LIST** now ready. Send stamp and get valuable paper on **WINTERING BEES.**

GOLDEN WYANDOTTE Eggs from fine birds only \$1.00 for 13.

EMERSON T. ABBOTT, St. Joseph, Mo.

BUY "DIRECT FROM FACTORY," BEST MIXED PAINTS

At **WHOLESALE PRICES**, Delivered **FREE** For Houses, Barns, Roofs, all colors, and **SAVE** Dealers profits. In use 54 years. Endorsed by Grange & Farmers' Alliance. Low prices will surprise you. Write for Samples. O. W. INGERSOLL, 289 Plymouth St., Brooklyn, N. Y.

Mention the American Bee Journal.

KAFFIR CORN

The new drought-resisting wonder; yields 60 to 80 bushels to the acre. Better than corn for stock and poultry. Will grow anywhere. Raise your own seed. Write for information and prices. Sample "Genuine Fox Brand," plenty to plant 2000 sq. ft., with directions, for nine 2-ct. stamps. **SHERMAN & WHITE**, 655 Otto Street, CHICAGO, ILL.

WHEN ANSWERING THIS ADVERTISEMENT, MENTION THIS JOURNAL.



TURKEY SUBDUED AT LAST.

In spite of the common belief that she could not be restrained, an eastern man raised an immense flock, pent up with **PAGE**, from the egg to the oven. See picture in "Hustler." **PAGE WOVEN WIRE FENCE CO.**, Adrian, Mich.

Better than 10% Discount!

By comparing the following with the customary prices of Foundation they will be found to be better than a 10% discount. Prices are f. o. b., not to any size.

COMB FOUNDATION.

	1lb	5lb	10lb	25lb
Heavy or Medium.....	45c	42c	40c	38c
Light.....	45c	44c	42c	40c
Thin.....	50c	49c	47c	45c
Extra Thin.....	55c	54c	52c	50c

Samples Free. Watch this advertisement for changes. Better buy now, before prices advance. **BRESWAX**—30c cash, 32c trade, delivered. **HIVES, SECTIONS, SMOKERS, ETC.**, always in stock. **PRICES** are right. Order before the rush. **W. J. FINCH, JR.**, SPRINGFIELD, ILLS.

Mention the American Bee Journal.

SUCCESSFUL INCUBATOR

Our magnificent new catalogue giving full information regarding artificial Hatching & Brooding and treatise on poultry raising sent for 4c stamps. Circular free.

Write now. **Des Moines Incubator Co.**, Box 78 Des Moines, Ia.

11A9t Mention the American Bee Journal.

California

If you care to know of its Fruits, Flowers Climate or Resources, send for a Sample Copy of California's Favorite Paper—

The Pacific Rural Press

The leading Horticultural and Agricultural paper of the Pacific Coast. Published weekly, handsomely illustrated, \$2.00 per annum. Sample Copy Free.

PACIFIC RURAL PRESS, 220 Market St., SAN FRANCISCO, CAL.

SPRAYING

WILL PRODUCE PERFECT FRUIT.

Our illustrated catalogue tells you **HOW** and **WHEN** to spray—mailed **Free** to fruit Growers and Dealers. The largest and best line of Spray Pumps and Nozzles in the world.

THE DEMING CO. Mfrs. Salem, Ohio.
Western Agency: Henion & Hubbell, Chicago.

Mention the American Bee Journal.

COMB FOUNDATION WHOLESALE and RETAIL.

Are you going to buy Foundation for Cash, or have you Wax to sell or trade for Foundation and other Supplies? Have you 25 lbs. or more of Wax that you want made into Foundation? If so, do not fail to write me for samples and prices. I make a specialty of working up Wax by the lb., and do it very cheap during the winter. Beeswax wanted at all times.

GUS DITTMER, AUGUSTA, WIS.
Reference—Augusta Bank. 16A1t

Mention the American Bee Journal.

PATENT WIRED COMB FOUNDATION

Has No Sag in Brood-Frames

Thin Flat-Bottom Foundation

Has No Fishbone in the Surplus Honey.

Being the cleanest is usually worked the quickest of any Foundation made

J. VAN DEUSEN & SONS,
Sole Manufacturers,
Sprout Brook Montgomery Co., N. Y.

Mention the American Bee Journal.

HONEY

We have a large amount of Pure No. 1 Alfalfa we will sell cheap.

SEED Of those great honey-producing plants—Alfalfa and Cleome or Rocky Mountain Honey-Plant. Alfalfa seed at 7 cts. a lb.

Boss bee-escape Warranted the best, simplest and quickest Escape on the market. Sent postpaid to any address for 50 cts. It can be returned at our expense if it is not as represented, or we will send the Escape on trial to any bee-keeper wishing to test it in good faith. We are agents for the

Ferguson Patent Hive with double-case Super and Wicket-Gate Honey-Board, with the Escape. It is the easiest, quickest hive to handle for the production of comb honey. Address,

E. S. LOVESY & CO.,
355 6th East St., SALT LAKE CITY, UTAH.
16A1t

Mention the American Bee Journal.

Promptness Is What Counts!

Honey-Jars, Shipping-Cases, and everything that bee-keepers use. **Root's Goods at Root's Prices**, and the best shipping point in the country. Dealer in Honey and Beeswax. Catalogue Free.

Walter S. Ponder
162 Mass. Ave.
INDIANAPOLIS, IND.

Mention the American Bee Journal.

LEADS THEM ALL S TO 24 1/2 %

See reports of experiments with Comb Foundation at the government station, Lapeer, Mich. **FREE**—large illustrated Catalogue of everything needed in the apiary. Full of information. **M. H. Hunt, Bell Branch, Mich.**
5D1t Please mention this Journal.

Potatoes

Sir William, Maggie Murphy, World's Fair, Rural N. Y. No. 2, \$1.00 per bushel. 20 New Varieties. Catalogue Free.

J. F. MICHAEL,
1D6t GREENVILLE, OHIO.

Mention the American Bee Journal.

Honey-Bee," revised by Dadant, then I read the works of many noted apiarists, or their experiences and modern improvements very enthusiastically. Then I transferred a colony as aforesaid, and later two more, and then I bived a new swarm, all from my father's apiary.

Also, on July 29 there was a very small swarm issued from one of the old box-bive colonies, and I bived it in a one-frame observatory hive, and had a peculiar occurrence afterward. One fine day in August I was in my apiary, and all at once I heard the swarming of bees, I hastily examined my transferred colonies, one of which I almost knew was absconding, and lo, and behold! they were all working nicely. The swarm commenced trying to settle on a limb just above my observatory hive, and I just waited patiently and said to myself, "I'll be a colony ahead in a few minutes;" and, sir, those bees could not settle on that limb worth a cent, from some cause, and I got impatient wondering what was the matter. I went up and examined the limb for the queen, but could not find her. By and by I guess they found the queen in the observatory hive, and, much to my surprise, they began to tumble in, and it was but a few moments until they had it full and running over. There I was, and hardly knew what to do first. Well, I took off the top and procured the queen and put her in another hive which I had placed on the table with the observatory hive, and began to rake the bees from off the front, top and sides of the little hive, for they had it entirely covered up.

I put all the bees (except enough to take care of the little hive) into the big one, and set it away off to one side, and it was but a short while until everything was lovely. Now, the bees in the little hive had to rear a new queen, which they did, and I watched the proceedings very closely, and it was quite a lesson to me. I now have 5 good, strong, thrifty colonies, and hope that I may increase to quite a number this year. **Tupelo, Ark., Feb. 1. J. E. JONES.**

"Fat" Bees—All Honey in Sections.

"A peep into the hive even before cold weather is yet here reveals the fact that nearly all the bees are very clumsy, and they resemble very closely the comb-builders of the working season. By weighing a given number of these bees you will observe that they are much heavier than the bees of early spring, and about equal in weight to bees well-filled with honey. By dissecting you will find that their plumpness and weight are not caused by a distension of their honey-sacs, or an accumulation in their intestines, but by the development of flesh and blood as in other fattened animals. Upon the principle of fat producing heat in other animals, the fat bees are able to generate heat much longer than if they were poor and had to carry all their fuel in their honey-sacs."

In looking over one of my papers to day I noticed the above, and thinking that may be it will be of some use I copy it and send it to you.

Bees were bringing in pollen yesterday. Would the readers of the American Bee Journal like to know how to get all their honey in sections? **C. C. PARSONS,** Bessemer, Ala., Feb. 3.

[As our readers want to learn all they can, no doubt they will be pleased to read about your method of "getting all the honey in sections."—Ed.]

Wintering Bees in Nebraska.

Bees in southeastern Nebraska went into winter quarters in good condition, and so far my loss has been but 6 out of 131 in my home apiary. I leave my bees on the summer stands facing the south, and pack three inches of leaves on the west side and north end of the hives, leaving the east side and south end without any protection.

After trying the cellar, and wintering on summer stands without protection, I was

Sweet Clover, Willow-Herb, Basswood

EXTRACTED HONEY

—For Sale.—

We have made arrangements whereby we furnish **Sweet Clover or Willow-Herb Extracted Honey**, in 60-pound tin cans, on board cars in Chicago, at these prices: 1 can, in a case, 8 cents per pound; 2 cans in one case, 7½ cents.

The Basswood Honey is all in kegs holding 170 pounds, net. It is a very superior quality, and the prices are: 1 keg, 8½ cents per pound; 2 kegs or more, 8 cents.

Cash must accompany each order. A sample of either kind of honey will be mailed to an intending purchaser, for 12 cents, to cover postage, packing, etc. We guarantee purity, and that what we ship will be equal to sample.

GEORGE W. YORK & CO.,
CHICAGO, ILLS.

IF YOU WANT THE BEE-BOOK

That covers the whole Apicultural Field more completely than any other published, send \$1.25 to Prof. A. J. Cook, Claremont, Calif., for his

Bee-Keeper's Guide.

Liberal Discounts to the Trade.

OUR POULTRY ANNUAL and Book of Valuable Recipes, 64 large pages, contains 8 beautiful colored plates of fowls, gives description and prices of 45 varieties, with important hints on care of poultry, and pages of recipes of great value to everyone. **Finest Poultry Book published for 1896.** Postpaid only 10 cts. **C. N. Bowers, Box 24, Dakota, Ill.**
52A13 *Mention the American Bee Journal.*

TAKE NOTICE!
BEFORE placing your orders for SUPPLIES, write for prices on 1-Piece Basswood Sections, Bee-Hives, Shipping-Crates, Frames, Foundation, Smokers, etc.
PAGE & LYON MFG. CO.
NEW LONDON, WIS.

1896 SAVE MONEY 1896
If you want first-class **ITALIAN QUEENS** FOR BUSINESS, Foundation at Wholesale Prices, Hives, suited for the South, or SUPPLIES, send for Price-List—to
J. P. H. BROWN, AUGUSTA, GA.
Mention the American Bee Journal.

CARLOADS
Of Bee-Hives, Sections, Shipping-Cases, Comb Foundation, and Everything used in the Bee-Industry.
I want the name and address of every Bee-Keeper in America. No reason why you cannot do business with me. I have Cheap Lumber and Experienced Workmen; a good Water-Power Factory and know how to run it. I am supplying Dealers as well as consumers. Why not you? Send for Catalogues, Quotations, etc. **W. H. PUTNAM,** 18 RIVER FALLS, Pierce Co., WIS.
Mention the American Bee Journal.

BEGINNERS.
Beginners should have a copy of the Amateur Bee-Keeper, a 70-page book by Prof. J. W. Rouse. Price 25 cents; if sent by mail, 28c. The little book and the Progressive Bee-Keeper (a live, progressive 28-page monthly journal) one year, 65c. Address any first-class dealer, or
LEAHY MFG. CO., Higginsville, Mo.
Mention the American Bee Journal.

convinced that some other method should be adopted, so I tried the plan of packing all around, as is usually advised. I found no better success from this method. While packing all around kept out cold to some extent, it also kept out the heat from the sun, and many thus packed, especially if in a shady place, filled with frost and perished.

My losses from the three methods of wintering I formerly tried averaged 25 per cent., and by the plan I have adopted for the last three years not over 10 per cent.

In the first place, an apiary should be free from shade and face the south, and the hives should set either on the ground, or very nearly so, and the super should be filled with wheat chaff, leaving on the enameled cloth, under which I would recommend placing the small sticks reaching across at least six of the center frames; this will allow the bees to go from frame to frame. The outside packing should extend nearly to the top of the super, and be of dry leaves.

I sold 10 colonies to H., a neighbor, in the spring of 1894, and although I gave him directions how he should pack his bees, he disregarded it, and moved them all up to one place in a row, and packed them collectively with leaves on all sides except the front. In the spring he found them all dead, with plenty of honey. I also sold C. and B. 14 colonies at the same time; they packed the same way, and lost all except 4, which were in old-fashioned box-hives. I could mention many other instances of losses by packing all around the hives, but perhaps the above is sufficient. I do not contend that my way, or any other method of packing, will keep the heat up in the hive, but I do believe it prevents cold winds entering the hive through cracks, that is about all, except the chaff in the super, that probably helps to retain heat.

In our State about 1-6 to ¼ of the days in winter the sun shines very warm, and if hives are packed all around, the heat on warm days will have little effect in thawing out accumulated frost. The hive-entrance should be large, and not allowed to close by snow, frost, or dead bees. Four of my losses this winter were from smothering, and the other from starving, with plenty of honey in the hive. The bees clustered during a cold spell on empty combs.

J. L. GANDY.
Humboldt, Nebr., Jan. 31.

Sweet Clover and Alfalfa.
In reading the proceedings of the Illinois State Bee-Keeper's Convention, on page 69, the question of planting for honey and pasturage engaged my attention. I believe this to be one of the most important subjects in relation to bee-keeping, especially when we consider the changing conditions going on around us, our forests being removed, the flora changed, making bee-keeping as a specialty a very uncertain occupation. I do not intend saying much on the subject, as the last season left convincing proof of the necessity of increasing our pasturage by sowing of honey-producing plants. In this section bee-keepers within reach of sweet clover can report 100 per cent. increase, and some wonderful yields of comb honey; bees going into winter quarters heavy with natural stores, and strong in bees.

The question I wish more particularly to refer to is alfalfa as a honey-plant. From the glowing accounts of the great yields of honey from the alfalfa fields of the South and southwestern States, one would be led to believe that the same results might be expected from alfalfa wherever it may be sown, which is not the case. I saw in Gleanings for Feb. 1, a perfect picture of alfalfa, and a comment as follows:

"Permit us to say once more, that any one who contemplates making any test of alfalfa at all should send for Farmers' Bulletin No. 31, Department of Agriculture, Washington, D. C. In the alfalfa bulletin we find nothing in regard to its value as a honey-plant. It seems a little strange that such a complete and exhaustive treatise should omit to mention that the plant pro-

The Bee-Keepers' Guide:

Or Manual of the Apiary,

By Prof. A. J. Cook.

This 15th and latest edition of Prof. Cook's magnificent book of 460 pages, in neat and substantial cloth binding, we propose to give away to our present subscribers, for the work of getting new subscribers for the American Bee Journal.

A description of the book here is quite unnecessary—it is simply the most complete scientific and practical bee-book published to-day. Fully illustrated, and all written in the most fascinating style. The author is also too well-known to the whole bee-world to require any introduction. No bee-keeper is fully equipped, or his library complete, without "THE BEE-KEEPER'S GUIDE."

For Two New Subscribers and Your Own Renewal.

Send us Two New Subscribers to the Bee Journal and your own renewal (with \$3.00), and we will mail you a copy of Prof. Cook's book FREE as a premium, and also a copy of the 160-page "Bees and Honey" to each New Subscriber. Prof. Cook's book alone is \$1.25, or we club it with the Bee Journal for a year—both together for only \$1.75. But surely anybody can get only 2 new subscribers to the Bee Journal for a year, and thus get the book as a premium. Let everybody try for it. Will you have one?

GEORGE W. YORK & CO.,
CHICAGO, ILLS.

TEXAS QUEENS.

If you are in need of Queens, let me have your order. Price-List Free.

8A26t **J. D. GIVENS, Lisbon, Tex.**

Mention the American Bee Journal.

POULTRY
40 Standard Breeds Illustrated & fully described in my new Poultry Book. Reliable information for poultrymen & intending buyers. Good stock Ducks & Geese; also Shetland Ponies. Send 6c in stamps
E. H. COOK, Box 27, Rutley, Ill.
Mention the American Bee Journal. 4A13t

ORIGINAL BINGHAM SMOKERS
Direct Draft Patent Bingham Bee-Smoker
Wonderful Record!
HAVE LASTED 17 YEARS.
BEST ON EARTH.
Always Give Perfect Satisfaction.
My cool Wire Handle and Bent Nose were patented 1892, are the original, my best invention since my open or direct draft Patent, 1878, that revolutionized Bee-Smokers. My Handle and Nose Patent bent all the other smoker noses. None but Bingham Smokers have all the best improvements. If you buy genuine Bingham Smokers and Honey-Knives you will never regret it. The "Doctor," ¼-inch larger than any other smoker on the market—¾-inch stove, by mail, \$1.50
Conqueror, 3 " " 1.10
Large, 2½-in. " " 1.00
Plain, 2-in. " " .70
Little Wonder, 2-in., wt. 10 oz. .60
Bingham & Hetherington Honey-Knives, 50 cents.
T. F. BINGHAM, Farwell, Mich.
7A7f *Mention the Bee Journal.*

12 Pkgs. tested, pure, fresh garden seeds, 12 cts., postpaid. R. X. Thomas, Shenandoah, Iowa.
Mention the American Bee Journal.

BEE-SUPPLIES!

We have the best equipped factory in the West. Capacity, one carload a day; and carry the largest stock and greatest variety of everything needed in the apiary. Assuring **BEST** goods at **LOWEST** prices, and prompt shipment.

Illustrated Catalog, 80 pages, Free

Address,

E. KRETCHMER, RED OAK, IOWA.

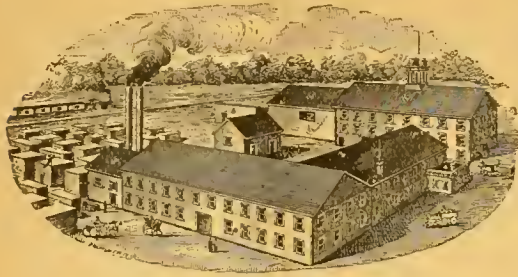

duces some of the finest honey in the world; and it has for several years been shipped by the carload from regions where alfalfa is largely grown."

From the above one would suppose that alfalfa may be grown anywhere with the same results. Ten years ago I invested in alfalfa seed, and up to the present time I have never seen a bee upon it. This coincides with several prominent bee-keepers at the recent Illinois State Bee-keepers' Convention. I am of the opinion that there is a large belt of territory on the North American continent where alfalfa is grown, and it is of no use whatever as a honey-producing plant. For the benefit of bee-keepers it would be well to have its limits defined, so that those wishing to try it may not waste their money upon it and meet with disappointment.

I hope this may open the way to a friendly discussion on this subject for the benefit of bee-keepers.

Toronto, Ont. JOHN McARTHUR.

Report for 1895—An Old Elm.

I commenced the spring of 1895 with 15 colonies, having no loss in wintering. They did quite well the first part of the season, especially on raspberry. White and Alsike clover furnished a moderate amount, but did not last long; after those we usually have more or less basswood, but it was less last year—none to speak of, with scarcely anything from fall flowers. They showed little propensity for swarming, but increased slightly by dividing, but united in September to the original number. My yield, per colony, was 40 pounds of comb honey and 10 pounds of extracted. I fed mostly sugar syrup to winter. Altogether it was a rather poor season.

About the large honey yields, I will say that the most I ever knew of being taken from one colony, spring count, was 172 pounds; the parent colony was allowed to swarm once, and the new swarm furnished the 100 pounds. That was nearly 20 years ago, and before I had any bees. I think it could hardly be done around here now. The most I ever got from one colony was 72 pounds of comb honey and 20 pounds of extracted. The colony did not swarm, or seem inclined to.

I have just finished cutting up an elm tree, which I think is perhaps the oldest tree in this portion of the country. If the rings or circles around the heart are reliable indications of the age—and they undoubtedly are—it was 350 years old, and must have been quite a tree when the Pilgrims landed. There were the remains of two different swarms of bees in the tree, but for some reason they failed to survive long. It was an enormous tree, measuring 41 inches in diameter inside of the bark, at a height of 7½ feet from the ground, and made, when worked into cord-wood, 3½ cords. It was nearly sound, the circles in some places indicating very hard seasons.

FRANK CHAMPEON.

Exeter, Maine, Jan. 24.

A Report—Robbing—Frosted Plums.

I began the season of 1895 with 13 colonies, having been reduced from 58 to 13 by

the previous dry year, and the past was not a real good honey season, but pretty good, at least towards the close. My bees averaged about 77 pounds per colony, and a good quality of honey. About 300 of this was from basswood, but it is not so good as clover honey.

I am trying to learn something every year, and when able to be out I try to gain some practical information every day. One new feature that I have tried and succeeded in, is to have two laying queens in one colony at the close of the season. I put away three colonies with two queens in each, so as to have queens to supply any deficiency that may occur in that line in the spring. Should none occur, I have a good laying queen to sell to some of my less fortunate neighbors.

I also learned how to prevent robbing, and it may be a very old method for ought I know among the fraternity. Nevertheless, I will give it: After having opened a hive, I found the robbers entering both at the top and bottom. I took the paint brush and painted all around the top where they crawled in under the lid, then took a bunch of grass and laid it in front, and made it thoroughly wet, so that all bees crawling through became quite wet. This put a stop to the robbing, instant.

Last spring my 20 plum trees set very full of fruit, and I intended to spray the trees the day following, but that night it was very cold, and when I got up in the morning I found the plums all frozen hard. I had heard mother tell about putting cold water on garden plants to draw the frost out, so I took the spray pump, and water from the well, and sprayed the trees until the water dropped from the leaves. After having done this, I went to the house feeling very blue, for I had great hope for my plums, as this was the first crop that I had on these trees. I awaited results, but expected when the sun came up to find all my plums on the ground, as others had done, but to my surprise and delight they were all right, and the trees were full of as nice fruit as I ever saw, while my neighbor near by had none. Whether the water did it or not, I don't know.

Glendon, Iowa.

O. P. MILLER.

Not a Failure Last Year.

Through the Bee Journal I learn of the success or failure of bee-keepers from nearly all parts of North America, except northwestern Minnesota. There are a number (mostly farmers) that keep bees in this section of the State, and some of them take the Bee Journal—and they all ought to take it—but as I see no communication from any one in this part of the State, I will give a brief account of my own and my neighbors' success. (We had no use for the word "failure" last season—if there was failure it was the fault of the man, not of the season.)

Last spring I had 4 colonies, and one died after I removed them from the cellar to the summer stands, leaving me 3 good colonies. I had 6 swarms issue; one absconded one day during my absence, and I united 2 small swarms; this gave me 7 colonies to put into the cellar last fall. Bees were not put into winter quarters until the last of

November here; I put mine into the cellar Dec. 3, and they had a flight only a few days before. I took 150 pounds of honey in one-pound sections, or 50 pounds to the colony, spring count. I find a ready sale for all the honey I have to spare, at 17 cents per pound.

My family can all handle bees without gloves or veil, except one daughter, who can't go within sight of bees without getting stung. I was obliged to be absent a few days during the swarming season, and I told this daughter to watch the bees, and call her brother if any swarms issued. She wanted to know if I would give her a swarm if she would give them. Certainly, I would. Well, the day I left home a swarm came out, and she hived them, and they not only filled the brood-chamber, but stored 28 pounds of surplus honey in one-pound sections. My daughter has married since then, and of course she will take the Bee Journal.

Some of the bee-keepers here have taken from 75 pounds to 85 pounds of surplus honey per colony last season. Taking some of the correspondents of the Bee Journal as authority, there are no apiarists here—they are only bee-keepers. I do not know of any one that keeps more than 8 or 10 colonies of bees. They are kept mostly by farmers, not for profit, but for the honey for family use.

S. B. SMITH.

Keenville, Minn.

Honey & Beeswax Market Quotations.

CHICAGO, ILL., Feb. 28.—White clover and basswood comb is sought after in preference to any other, and commands a better price and now sells at 15c. for clover and 13@14c. for basswood. Other white comb honey sells at 11@12c.; dark, 8@9c. amber, 9@10c., and very slow of sale. Extracted is unusually dull, with large amounts on sale. White clover and Linden, 6@7c.; dark and amber grades, 4½@5c.

Beeswax, 28@30c.

R. A. B. & Co.

PHILADELPHIA, PA., Mar. 6.—Honey has been selling freely, there being considerable call for comb honey, and the war in Cuba has made extracted honey sell to the baking trade who previously used Cuba honey. We quote: Fancy comb, 15c.; fair to good, 11@13c.; fair, 9c. Extracted, 4½@5½c.; pure white clover, 10c. Beeswax, 30c.

W. A. S.

NEW YORK, N. Y., Feb. 24.—Market quiet. White comb in fair demand at 11@14c. Very little demand for buckwheat comb at 8@9c. Extracted selling fairly well, principally California, at 5½@5¾c. and some buckwheat moving at 4@4½c.; Southern, 5@5½c. per gallon; white clover and basswood, 5½@6c. Beeswax unchanged.

H. B. & S.

CINCINNATI, O., Mar. 7.—Demand is fair for choice comb honey, at 12@14c. in a jobbing way. Extracted is slow at 4@7c.

Beeswax is in good demand at 25@30c. for good to choice yellow.

C. F. M. & S.

KANSAS CITY, MO., Feb. 19.—The demand for comb and extracted is fair. We quote: No. 1 white, 1-lbs., 13@14c.; No. 2, 11@12c.; No. 1 amber, 10@11c.; No. 2, 8@10c. Extracted, white, 5½@6½c.; amber, 5@5½c. Beeswax, 20@25c.

C. C. C. & Co.

List of Honey and Beeswax Dealers.

Most of whom Quote in this Journal.

Chicago, Ills.

R. A. BURNETT & Co., 163 South Water Street.

New York, N. Y.

HILDRETH BROS. & SEGELKEN,
120 & 122 West Broadway.
CHAS. ISRAEL & BROS., 486 Canal St.

Kansas City, Mo.

C. C. CLEMOMS & Co., 423 Walnut St.

Buffalo, N. Y.

BATTERSON & Co., 167 & 169 Scott St.

Hamilton, Ills.

CHAS. DADANT & SON.

Philadelphia, Pa.

WM. A. SELSER, 10 Vine St.

Cincinnati, Ohio.

C. F. MUTH & SON, cor. Freeman & Central avs.

Book Premiums for Getting New Subscribers

For each New Subscriber to the American Bee Journal sent us by a present subscriber, we will give as a Premium **40 cents' worth** of the Books, Pamphlets, etc., described on this page—figuring on the **retail price** given in connection with each book, etc., below. This is a very easy way to get a lot of most excellent literature.

Free Copy of "BEES AND HONEY" to Every New Subscriber.

Yes, in addition to the above offer, we will mail free a copy of Newman's 160-page "Bees and Honey"—premium edition—to each new subscriber. **NOW IS JUST THE TIME** to work for big lists of New Subscribers.

The American Bee Journal List Should Easily Be **DOUBLED** on these Liberal Offers.

BEE-BOOKS

SENT POSTPAID BY

George W. York & Co.,
Chicago, Ills.

Bees and Honey, or Management of an Apiary for Pleasure and Profit, by Thomas G. Newman.—This edition has been largely re-written, thoroughly revised, and is "fully up with the times" in all the improvements and inventions in this rapidly-developing pursuit, and presents the apiarist with everything that can aid in the successful management of an apiary, and at the same time produce the most honey in an attractive condition. It contains 250 pages, and 245 illustrations—is beautifully printed in the highest style of the art, and bound in cloth, gold-lettered. Price, \$1.00.

Langstroth on the Honey-Bee, revised by Dadant.—This classic in bee-culture, has been entirely re-written, and is fully illustrated. It treats of everything relating to bees and bee-keeping. No apiarian library is complete without this standard work by Rev. L. L. Langstroth—the Father of American Bee-Culture. It has 520 pages; bound in cloth. Price, postpaid, \$1.25.

Bee-Keepers' Guide, or Manual of the Apiary, by Prof. A. J. Cook, of the Michigan Agricultural College.—This book is not only instructive and helpful as a guide in bee-keeping, but is interesting and thoroughly practical and scientific. It contains a full delineation of the anatomy and physiology of bees. 460 pages; bound in cloth and fully illustrated. Price, postpaid, \$1.25.

Scientific Queen-Rearing, as Practically Applied, by G. M. Doolittle.—A method by which the very best of Queen-Bees are reared in perfect accord with Nature's way. 175 pages, bound in cloth, and illustrated. Price, \$1.00.

A B C of Bee-Culture, by A. I. Root.—A cyclopaedia of 400 pages, describing everything pertaining to the care of the honey-bees. It contains 300 engravings. It was written especially for beginners. Bound in cloth. Price, \$1.25.

Advanced Bee-Culture, Its Methods and Management, by W. Z. Hutchisson.—The author of this work is too well known to need further description of his book. He is a practical and entertaining writer. You should read his book. 90 pages, bound in paper, and illustrated. Price, 50 cts.

Rational Bee-Keeping, by Dr. John Dzierzon.—This is a translation of his latest German book on bee-culture. It has 350 pages; bound in cloth, \$1.25; in paper covers, \$1.00.

Bienen-Kultur, by Thomas G. Newman.—This is a German translation of the principal portion of the book called BEES AND HONEY. 10 page pamphlet. Price, 40 cents.

Convention Hand-Book, for Bee-Keepers. Thomas G. Newman.—It contains the parliamentary law and rules of order for Bee-Conventions—also Constitution and By-Laws, with subjects for discussion, etc. Cloth, gold-lettered. Price, 25 cts.

Amerikanische Bienenzucht, by Hans Buschbauer.—Printed in German. A hand-book on bee-keeping, giving the methods in use by the best American and German apiarists. Illustrated; 138 pages. Price, \$1.00.

Thirty Years Among the Bees, by Henry Alley.—Gives the results of over a quarter-century's experience in rearing queen-bees. Very latest work of the kind. Nearly 100 pages. Price, 50c.

Why Eat Honey?—This Leaflet is intended for FREE distribution, to create a Local Market. 100 copies, by mail, 40 cts.; 500 for \$1.50; 1000, \$2.50. If 500 or more are ordered at one time, your name and address will be printed on them FREE.

How to Keep Honey and preserve its richness and flavor. Price same as Why Eat Honey.

Apiary Register, by Thos. G. Newman.—Devotes two pages to a colony. Leather binding. Price, for 50 colonies, \$1.00; for 100 colonies, \$1.25.

Preparation of Honey for the Market, including the production and care of comb and extracted honey. A chapter from BEES AND HONEY. Price, 10 cents.

Bee-Pasturage a Necessity.—This book suggests what and how to plan. It is a chapter from BEES AND HONEY. Price, 10 cents.

The Hive I Use, by G. M. Doolittle. It details his management of bees, and methods of producing comb honey. Price, 5 cents.

Dr. Howard's Book on Foul Brood.—Gives the McEvoy Treatment and reviews the experiments of others. Price, 25 cts.

Dictionary of Apiculture, by Prof. John Phil. Gives the correct meaning of nearly 500 apicultural terms. Price, 50 cts.

Winter Problem in Bee-Keeping, by G. R. Pierce. Result of 25 years' experience. 50 cts.

Handling Bees, by Chas. Dadant & Son.—A Chapter from Langstroth Revised. Price, 8 cts.

Bee-Keepers' Directory, by H. Alley.—Latest methods in Queen-Rearing, etc. Price, 50c.

Foul Brood Treatment, by Prof. F. R. Cheshire.—Its Cause and Prevention. Price, 10 cts.

Foul Brood, by A. R. Kohnke.—Origin, Development and Cure. Price, 25 cts.

History of Bee-Associations, and Brief Reports of the first 20 conventions. Price, 15 cts.

Honey as Food and Medicine, by T. G. Newman.—A 32-page pamphlet: just the thing to create a demand for honey at home. Should be scattered freely. Contains recipes for Honey-Cakes, Cookies, Puddings, Foam, Wines, and uses of honey for medicine. Prices, prepaid—Single copy, 5 cts.; 10 copies, 35 cts.; 50 for \$1.50; 100 for \$2.50; 250 for \$5.50; 500 for \$10.00; or 1000 for \$15.00.

When 250 or more are ordered, we will print the bee-keeper's card (free of cost) on the front cover page.

Bee-Keeping for Profit, by Dr. G. L. Tinker.—Revised and enlarged. It details the author's "new system, or how to get the largest yields of comb or extracted honey." 80 p.; illustrated, 25c.

Emerson Binders, made especially for the BEE JOURNAL, are convenient for preserving each number as fast as received. Not mailable to Canada. Price, 75 cts.

Commercial Calculator, by C. Ropp.—A ready Calculator, Business Arithmetic and Account-Book combined in one. Every farmer and business man should have it. No. 1, bound in water proof leatherette, calf finish. Price, 40 cts. No. 2 in fine artificial leather, with pocket, silicate slate, and account-book. Price, 60 cts.

Green's Four Books, by Chas. A. Green.—Devoted to, 1st, How We Made the Old Farm Pay; 2nd, Peach Culture; 3rd, How to Propagate Fruit-Plants, Vines and Trees; 4th, General Fruit Instructor. Nearly 120 pages. Fully illustrated. 25 cts.

Green's Six Books on Fruit-Culture, by Chas. A. Green.—Devoted 1st, to Apple and Pear Culture; 2nd, Plum and Cherry Culture; 3rd, Raspberry and Blackberry Culture; 4th, Grape Culture; 5th, Strawberry Culture. 129 pp.; illustrated. 25 cts.

Garden and Orchard, by Chas. A. Green.—Gives full instructions in Thinning and Marketing Fruits; Pruning, Planting and Cultivating; Spraying, Evaporation, Cold Storage, Etc. 94 pages, illustrated. Price, 25 cts.

Kendall's Horse-Book.—35 pictures, showing positions of sick horses, and treats on all their diseases. English or German. Price, 25 cts.

Silo and Silage, by Prof. A. J. Cook.—It gives the method in operation at the Michigan Agricultural College. Price, 25 cts.

Lumber and Log-Book.—Gives measurements of lumber, logs, planks; wages, etc. 25c.

Maple Sugar and the Sugar Bush, by Prof. A. J. Cook.—Full instructions. Price, 35 cts.

Grain Tables, for casting up the price of grain, produce, hay, etc. Price, 25 cts.

Capons and Caponizing, by Dr. Sawyer, Fanny Field, and others.—Illustrated. All about caponizing fowls, and thus how to make the most money in poultry-raising. 64 pages. Price, 30 cts.

Our Poultry Doctor, or Health in the Poultry Yard and How to Cure Sick Fowls, by Fanny Field.—Everything about Poultry Diseases and their Cure. 64 pages. Price, 30 cts.

Poultry for Market and Poultry for Profit, by Fanny Field.—Tells everything about the Poultry Business. 64 pages. Price, 25 cts.

Turkeys for Market and Turkeys for Profit, by Fanny Field.—All about Turkey-Raising. 64 pages. Price, 25 cts.

Rural Life.—Bees, Poultry, Fruits, Vegetables, and Household Matters, 100 pages. 25 cts.

Strawberry Culture, by T. B. Terry and A. I. Root. For beginners. Price, 40 cts.

Potato Culture, by T. B. Terry.—It tells how to grow them profitably. Price, 40 cts.

Carp Culture, by A. I. Root and Geo. Finley.—Full directions. 70 pages. Price, 40 cts.

Hand-Book of Health, by Dr. Foote.—Hints about eating, drinking, etc. Price, 25 cts.

Alsike Clover Leaflet.—Full directions for growing. 50 for 25 cts.; 100 for 40 cts.; 200, 70c.

Book Clubbing Offers.

(Read Carefully.)

The following clubbing prices include the American Bee Journal one year with each book named. Remember, that only ONE book can be taken in each case with the Bee Journal a year at the prices named. If more books are wanted, see postpaid prices given with the description of the books on this page. Following is the clubbing-list:

1. Langstroth on the Honey-Bee.....\$2.00
2. A B C of Bee-Culture..... 2.00
3. Bee-Keeper's Guide..... 1.75
4. Bees and Honey [Cloth bound]..... 1.65
5. Scientific Queen-Rearing..... 1.75
6. Dr. Howard's Foul Brood Book..... 1.10
7. Advanced Bee-Culture..... 1.30
8. Amerikanische Bienenzucht [Germ.]..... 1.75
9. Bienen-Kultur [German]..... 1.25
10. Rational Bee-Keeping [Cloth bound]..... 2.00
11. Rational Bee-Keeping [Paper bound]..... 1.75
12. Thirty Years Among the Bees..... 1.30
13. Bee-Keeping for Profit..... 1.15
14. Convention Hand-Book..... 1.15
15. Poultry for Market and Profit..... 1.10
16. Turkeys for Market and Profit..... 1.10
17. Capons and Caponizing..... 1.10
18. Our Poultry Doctor..... 1.10
19. Green's Four Books..... 1.15
20. Green's Six Books on Fruit-Culture..... 1.15
21. Garden and Orchard..... 1.15
22. Rural Life..... 1.10
23. Emerson Binder for the Bee Journal..... 1.60
24. Commercial Calculator, No. 1..... 1.25
25. Commercial Calculator, No. 2..... 1.40
26. Kendall's Horse-Book..... 1.10
27. Strawberry Culture..... 1.20
28. Potato Culture..... 1.20
29. Carp Culture..... 1.20
30. Hand-Book of Health..... 1.10
31. Dictionary of Apiculture..... 1.35
32. Maple Sugar and the Sugar Bush..... 1.20
33. Silo and Silage..... 1.10
34. Winter Problem in Bee-Keeping..... 1.30
35. Apiary Register (for 50 colonies)..... 1.75
36. Apiary Register (for 100 colonies)..... 2.00
37. Bee-Keepers' Directory..... 1.30

Please Send Us the Names of your neighbors who keep bees, and we will send them sample copies of the BEE JOURNAL. Then please call upon them and get them to subscribe with you, and secure some of the premiums we offer.

Bottom Prices

**BRING US BIG TRADE.
GOOD GOODS KEEP IT.**

If you want the best supplies that can be made at a little less cost than you can buy the same goods for elsewhere, write to us for low prices. 1896 Catalogue now ready—ask for it and a free copy of **The American Bee-Keeper** (36 pages).

Address,
THE W. T. FALCONER MFG. CO.,
JAMESTOWN, N. Y.
Mention the American Bee Journal.

Mention this paper.



EVERGREENS!

and Ornamental trees, Nursery grown. 240 Choice Evergreens, 10 varieties \$2. 400 Ornamental trees, 6 varieties, \$2; 6 other \$5 and \$10 bargains, 100 Scotch Pine, 2 ft. high, \$8; 1,000 10 to 12 inches \$10. All other varieties and sizes cheap. Local Agents Wanted. Send for Illustrated Catalogue. **FREE.**

D. HILL, Evergreen Specialist,
DUNDEE, ILLINOIS.

7A5t Please mention the Bee Journal.

ROOTS GOODS

A great reduction in Prices on Hives and Sections. Other bargains in Apian Supplies. State what you need and we will give you low prices. 36-p. Catalogue Free.

JNO. NEBEL & SON, High Hill, Mo.
Mention the American Bee Journal. 4A26t

The Rural Kansan

Is an Agricultural Journal for the busy farmer. It embraces Bee-Keeping and every department of industry connected with the farm. 30 cts. a year, monthly. Sample Free.

A Full Line of **Higginsville Bee-Supplies** on hand. **CATALOGUE FREE.**
HENRY L. MILLER,
355 Shawnee Ave., TOPEKA, KAN.
1A13t *Mention the American Bee Journal.*

FOR SALE.

ALSIKE, CRIMSON, ITALIAN, ALFALFA, or WHITE CLOVER SEED.
4A8t **WM. CRAIG, Luce, Mich.**
Mention the American Bee Journal.

Queen-Clipping Device.

I want the address of all who clip Queens and have even the least trouble either in catching or holding them while they are being clipped. I have invented a Device by which it is IMPOSSIBLE to injure a Queen either in catching or clipping, unless it is done purposely. With it they are caught and clipped any way desired almost instantly. One does not have to touch the Queen with his hands, whatever. Price, postpaid, 50 cts. Send for Free Circular. **C. MONETTE,**
6Atf **CHATFIELD, Fillmore Co., MINN.**
Mention the American Bee Journal.

BEES QUEENS

Smokers, Sections, Comb Foundation, And all Apian Supplies cheap. Send for FREE catalogue. **E. T. FLANAGAN, Bellefonte, Ill.**
6A26t Please mention the Bee Journal.

Fruit Plants

Where to buy them at wholesale price. Send postal for descriptive and wholesale Catalogue of all of the leading varieties of the **Strawberries, Raspberries, Blackberries, Currants, Gooseberries, Grapes and Potatoes.**
EZRA G. SMITH, Manchester, Ont. Co., N. Y.
8Atf Please mention the Bee Journal.

CASH PAID FOR BEESWAX

For all the good, pure yellow **BEESWAX** delivered to our office till further notice, we will pay 26 cents per pound, cash; or 30 cents for whatever part is exchanged for the Bee Journal, Honey, Books or Seed, that we offer. If you want **cash promptly** for wax, send it on at once. Dark or impure wax not taken at any price. Address plainly,

George W. York & Co., 118 Michigan St., Chicago, Ill.

19th Year Dadant's Foundation 19th Year

Is still in the lead, for we use all the latest improvements, including the **NEW PROCESS**, and still make the best goods. Remember that we do not use any acid to purify our beeswax, and that is why our Foundation preserves the smell of the honey and is more acceptable to the bees, than any other. It is kept for sale by

G. K. Hubbard, Fort Wayne, Ind.
L. Hanssen, Davenport, Iowa.
C. Theilmann, Theilmanton, Minn.
E. C. Eaglesfield, Berlin, Wis.
E. T. Abbott, St. Joseph, Mo.
J. M. Jenkins, Wetumpka, Alabama
John Rey, East Saginaw, Mich.
Vickery Bros., Evansville, Ind.

The Jennie Atchley Company, Beeville, Texas.
C. F. Muth & Son, Cincinnati, Ohio.
E. Kretschmer, Red Oak, Iowa.
Jos. Nysewander, Des Moines, Iowa.
G. B. Lewis Co., Watertown, Wis.
James Reynolds Elevator Co., Poughkeepsie, N. Y.
Page & Lyon, New London, Wis.
T. H. Strickler, Solomon City, Kansas.

and many other Dealers. All agree in saying that no goods are better than ours.

Those of our customers who formerly bought through Thos. G. Newman can get our Foundation in **Chicago, Ill.**, by addressing us at **118 Michigan Street**. We keep no other goods there.

We make a specialty of **Veils and Veil Stuffs** of best quality, cotton and silk.

Langstroth on the Honey-Bee, Revised.

Bee-Keepers' Supplies, Smokers, Sections, Tin Pails, etc.

Samples of Foundation and Tulle FREE with Circular. Instructions to beginners with Circular. **BEESWAX WANTED.** Send us your address.

CHAS. DADANT & SON,

Mention the American Bee Journal.

HAMILTON, Hancock Co., ILL.

SECTIONS, BEE-HIVES, SHIPPING-CASES

We make a Specialty of these Goods, and defy Competition in

QUALITY, WORKMANSHIP AND PRICES.

Write for Free Illustrated Catalogue and Price-List.

G. B. LEWIS COMPANY, Watertown, Wis.

Be sure to mention the American Bee Journal when you write.

* ROOT'S COMB FOUNDATION! *

New Product.

We are pleased to announce that, having secured control of the new Weed process of manufacturing foundation for the U. S., we are prepared to furnish **Foundation by the New Process**, for 1896. Samples will be mailed free on application, and will speak for themselves.

New Process.

OUR SANDED and POLISHED SECTIONS, well, they will speak for themselves, also.

Our 1896 Catalog

A Big Success

will be ready for distribution now in a few days. Send in your name at once for catalog, samples of the new foundation, and those superb sections, and while you are about it ask for late copy of **Gleanings in Bee-Culture**.

THE A. I. ROOT CO., MEDINA, OHIO.

118 Michigan St., Chicago, Ill.

Syracuse, N. Y.

1024 Mississippi St., St. Paul, Minn.

AMERICAN BEE JOURNAL

DEVOTED EXCLUSIVELY TO THE INTERESTS OF HONEY-PRODUCERS

ESTABLISHED 1861
THE OLDEST BEE-PAPER IN AMERICA

Published Weekly, at \$1.00 per annum.

Sample Copy sent on Application.

36th Year.

CHICAGO, ILL., MARCH 19, 1896.

No. 12.



Bee-Forage—Some Important Suggestions.

BY PROF. A. J. COOK.

The general failure of the honey crop for so many seasons during the last decade in nearly all portions of the country, and the absolute failure in arid regions like Southern California, whenever the rainfall comes short of a certain limit, gives to this subject of honey-plants, more than merely a passing interest.

In the great North East of our country, before the great forests of basswood and tulip were cleared away, and the great marshes with their profusion of bonaset, golden-rods, asters, etc., were drained—and possibly, we may add, before the extreme seasonal drouths, consequent upon the removal of the forests and draining of swamps—each and every season was a honey season, and the expression of "honey-years" had no significance, and so was unheard among bee-keepers. In California, if the rainfall is less than 15 inches, experience proves that the honey-production will range from nothing to less than half the maximum crop.

These facts make it desirable that the bee-keeper should study thoroughly the bee-forage of the country, should know the honey-plants, the quality and quantity of honey which each is likely to produce, and the effect of drouth and other seasonal peculiarities upon the nectar-secretion of each species.

This subject suggests two practical considerations, both of which will engage the thoughtful attention of every wise bee-keeper: In securing a location, he will give earnest heed to the native bee-plants, hoping to secure a rich bee-pasturage, without any extra labor, in the natural resources of his neighborhood. Many a Michigan and Wisconsin bee-keeper has been led to rejoice in by-gone years, because of the near proximity to his bee-yard of a grand forest of basswood, or of a broad expanse of marsh-land. Even today, the great basswood forests of Wisconsin make that, perhaps, the leading honey-state of the great North East. Year after year the willow-herb of the pine-clearings of Northern Michigan, supplemented by the berry-bushes of the same treeless tracts, has given a rich honey crop of finest quality to the bee-keepers of that region. If the apiary is along a stream, so that variation in moisture will prolong the season of bloom, then the bee-keeper will rejoice in greater prosperity. Mr. Doolittle and others along the Mohawk River in New York have felt the benefit of such location. In Southern California a good range of white and ball sage in both valley and canyon, hard by the apiary, followed by generous acres of wild buckwheat, will give a wondrous crop in seasons of bounteous rainfall. If eucalyptus and alfalfa are found in quantity, then he may be more independent of the rainfall.

After the location is decided, then the enterprising bee-keeper will anticipate drouths, winds, cool seasons, and endeavor to add to the native resources of his section, which he

will almost always be able to do, so that if possible he may rejoice in a bountiful honey harvest each season. Let us consider what may be wisely attempted in this direction.

It is well if the bee-keeper has so wisely located that he will be content to make his location his permanent home. Then he can fix up his apiary so that it will be his pride, and the pride of his section. This will make his bee-keeping more than a mere business, it will become his pleasure, and he will mingle poetry with the prose of life. Once permanently located, and the bee-keeper may well set to work to make his locality all that it is possible to make it. By proper thought and wise management this may be easily and cheaply done.

In the first place, let me urge, that it will not pay to plant good land with bee-plants exclusively for honey. My own experiments, extensively carried on for a series of years, at the Michigan Experiment Station, as also private experiments by others, make this more than mere opinion—make it really demonstrated fact. But it will pay oftentimes to scatter seed of the mints, sweet clover, viper's bugloss, great willow-herb, etc., on all waste places near by the apiary. It will pay to line the roadside with tulip, linden and other nectar-producing trees, and get our neighbors to do the same, even if we have to pay something towards the purchase of these trees. Mr. D. A. Jones did very much of such work about his home at Beeton, Ont. Mr. Root planted out many basswoods at Medina, and now is reaping the advantage which must swell with the years. To raise buckwheat and Alsike, and induce one's neighbors to do so, may be very wise. All this, the tree-planting, and buckwheat and Alsike growing pays, aside from the bees and honey, and should receive most thoughtful attention by all our bee-keepers. I believe that bee-keepers of the East may well adopt these suggestions. With little expense, they may add materially to their income by just such planting or tree-setting.

Sometimes by moving bees the bee-keeper can keep in the range of bee-forage. Many bee-keepers have added greatly to their incomes by moving bees to regions of basswood bloom or fall flowers.

Mr. Harbison told at a recent Farmers' Institute at San Diego, Calif., how he secured a large growth of hall-sage, by planting, and how it increased the value of his location very materially. This was on waste hill land, and so all clear gain. There are great areas of such tracts along the mountains and in the canyons of this favored region, and Mr. Harbison's suggestion may well receive thoughtful attention.

Another bee-tree—or bee-trees, for there are, it is said, more than one hundred species—which Californians should observe and study with the greatest care, is the eucalyptus. It is destined to become the great shade-tree of this State. It blossoms from September to April, depending upon the species; is a favorite with the bees whenever in bloom, and seems to furnish much and excellent honey. Some of the trees are wondrously beautiful, and the tassel-like bloom, white, buff, or crimson, with the curious caps to the flower-buds is not only wondrously beautiful, but exceedingly interesting. Eucalyptus globulus, or blue-gum, is the common one. This tree has an entirely different foliage when young from that of later growth and years. The white blossoms are showy, and are freely visited by the bees. But it blossoms in winter when the bees are not numerous and when they are mostly shut in the hives, so that the amount of honey is not great, though I knew bees to get not a little blue-gum honey during the last winter. I have some of this honey now, and have just sampled it. It is amber-colored, very sweet, and has a very peculiar

iar flavor, which I think might become very pleasant with use, but I doubt if it would be as well liked at first. It is claimed that this honey has rare medicinal properties, which seems not at all improbable. The deep-red showy blossoms of eucalyptus *fissifolia*, which will make this tree a great favorite, blossoms from August to October, and attracts the bees. By proper selection of species we can have blossoms from August to April.

Eucalyptus robusta is quite a favorite for planting in this locality at present, because of its beautiful habit, and foliage, and the strong, thrifty growth which it makes. It blossoms at the same time with the common blue-gum.

Eucalyptus cornicalyx, so called from the long, horn-like cap that covers the bloom in bud, blossoms in October and November. It is so curious and interesting that it may well be planted. I saw the bees thick about the blossoms in November while the cap was only slightly raised and not yet fallen from the blossoms. I have much hope from these eucalyptus. They come from arid Australia, and more than likely will be indifferent to the most severe droughts. Indeed, this is more than a guess, for the winter of 1893-1894 was one of the driest ever known in this region. The bees were idle—entirely idle—all through the following summer. I saw not the least evidence of honey-gathering after fruit in March and April. Yet my bees gathered quite an amount of honey in December and January of the following winter from the blue-gum.

I think it behooves all of us in Southern California to keep close watch of our bees and their storing from eucalyptus, and at all such times be sure to make note of date of bloom, earliest and latest, and unless the species is surely known, send bark, leaves, bud and blossom to some one who can identify it, that we may learn the most valuable species. Bee-keepers near Smiley Heights, Redlands, where there are over 80 species of this genus, or at Santa Monica, where the State Forestry Station is located, and where there are a large number of species of the eucalyptus, can do excellent service in this direction. I am trying to secure such data, and already have a long list of species with rate of growth and time of bloom.

I think bee-keepers may well do all in their power to encourage road-side and field-planting of eucalyptus. Such plantations as are being made all over the grand Elysian Park at Los Angeles, are large with promise to bee-keepers. It is said that there are over 1,000 colonies of bees in buildings in the city. No doubt they get much of their food from the eucalyptus groves that are so numerous and so attractive to others than bees. We all do well to make a close study of bee-forage, and whenever we notice bees thick upon any bloom, be sure to find the name of the plant that attracts. The Bulletin just issued by the Department of Agriculture, Washington, D. C., has extended and carefully prepared tables of bee-plants, with time of bloom. We should all do what we may to make such tables fuller and more complete and accurate. It is also very desirable to make a note of the color and excellence of the honey, and the power of the plants to secrete at times of severe drouth. Claremont, Calif.



Organization Among Bee-Keepers—Amalgamation.

BY THOMAS G. NEWMAN.

After having read the American Bee Journal of March 5, which came to hand this morning, I feel like making a few remarks on the subject of Organization.

At the Convention held in Chicago on Jan. 10, as the report shows, a vote was taken upon the desirability of uniting these two Societies into one, viz.: The North American Bee-Keepers' Association and The National Bee-Keepers' Union. I was called upon for some remarks on the subject, and then stated that my position as Past President of the former, and General Manager of the latter, prevented me from influencing opinion relative to the amalgamation, especially as there has now been developed a very strong feeling of opposition thereto, and it seems that now no consolidation can receive the united and active interest, which should be the result if amalgamation takes place.

In an editorial on this subject, on page 152, it is stated that, "So far about all the communications we have received concerning it have been against the amalgamation idea. Those who are in favor of it, seem to keep very still about it." The fact that this is so, seems to be very surprising, but it is not only a fact in the office of the American Bee Journal, but also in the office of the National Bee-Keepers' Union. Either there is nothing more to be said in favor of amalgamation, or else there has been a very marked change of opinion on the sub-

ject, during the past few months, after reading the many articles in the bee-periodicals opposing the scheme.

It is universally conceded that the Bee-Keepers' Union has a record to be proud of. That it is, in every sense of the word, "a power in the land;" what it lacks in numbers is made up in influence, in the records of its victories in the courts throughout the nation. Many seem to think that by hitching on the Association to the Union it might retard its onward course, or in other words, be a useless appendage to it—a real hindrance.

I must say that I do not indorse this position. The united societies by a largely increased membership, might become powerful, if rightly managed. It might be able to influence both State and National Legislation and thus bring great good to the pursuit, but if it does not have unanimous approval and co-operation of the bee-keepers of America, then the amalgamation could only be abortive and would be detrimental, not only to the Societies, but to the pursuit in general.

I therefore want to say, that unless there is a decided and united effort made, the amalgamation scheme should be abandoned entirely. The editor of the American Bee Journal states that nearly all the communications he has received on the subject have been in opposition thereto. My experience tallies with that. Nearly all the communications I have received at the office of the Bee-Keepers' Union have been decidedly opposed to the amalgamation. Unless this is reversed within the next 30 days, by the receipt of letters from those who favor it, I shall request the Advisory Board to decide the matter as to whether it shall be submitted to vote or not, and at the same time I feel constrained to say to them personally, that I do not believe it will be to the interest of the Bee-Keepers' Union to incur the expense of a special election for that in which the friends of the measure have not interest enough to advocate and defend.

By the March number of Gleanings I notice that in California they have organized a "Bee-Keepers' Exchange" whose headquarters is at Los Angeles. This is now a third organization of a similar nature among bee-keepers, and if amalgamation is to rule, then this also must be taken into the fold.

To my mind, though consolidation was possible last September, it is now not only impracticable but also impossible. I do not say this for the purpose of influencing a decision one way or the other, but I have been importuned by the members of the Union to state my real opinion of the matter in public print, and acceding to this general request, I have penned the above article and hope that it will be taken in the spirit that it is intended, i. e., for the general good of the pursuit.

Chicago, Ill., March 4.



Best Size of Hive for Comb Honey.

BY EDWIN BEVINS.

The discussion as to the best size of hive to use for comb honey production drags its slow length along, and I suppose bee-keepers will have to get in what they have to say on the subject soon, or the editors will get tired and shut their doors in their faces.

It is more than probable that I have no business to criticize anything that Dr. Miller, or Mr. Doolittle, or Mr. Dadant, write or say about anything pertaining to apiculture, but, at the risk of annihilation, I will venture a few remarks on some things that have recently appeared from the pens of some of these gentlemen on the subject of hive-construction, or rather, the best size of hive for the comb honey producer to use.

With regard to Dr. Miller, on this question, he maintains his position astride the fence with a poise and tenacity that is admirable. And the Doctor is not to be blamed. Nothing has appeared in the discussion so far to cause any one to tumble off suddenly on either side. The majority of comb honey producers, I believe, are on the fence with the Doctor. Most of them, I suppose, have been brought up on the "standard," and they fear that a change of diet may not agree with them.

Mr. Doolittle argues for the use of a small brood-chamber in order that we may have a hive full of bees for the harvest. Mr. Dadant advises the use of a large one for the same purpose. Here we have the spectacle of two eminent apiarists advocating and practicing directly opposite systems of management in order to bring about the same result. When Greek met Greek the barbarians looked on with awe. Until one or the other of these combatants receives his death wound, or retreats from the field, it may be prudent for some bee-keepers to keep their positions on the fence.

When I read "Langstroth Revised," I was impressed with the reasons given by the revisers for the use of large hives instead of small ones. But as they said that they did not

produce comb honey, and advised beginners to produce extracted honey instead, I could not see what authority they had to speak for the comb honey producers. In a recent article by Mr. Chas. Dadant, which appeared in the American Bee Journal, he says that he has tried the large hives by the side of the small ones for comb honey for years, and that the large hives gave best results. For awhile after reading this my position on the fence was not as comfortable as it was before, and I almost tumbled off on the side of the big hives.

But now comes Mr. Doolittle in the January Progressive Bee-Keeper, with an account of experience, and an array of arguments, that had the effect to make me assume as upright a position on the fence as ever Dr. Miller did.

Mr. Doolittle's experiments seemed conclusive, that the small brood-chamber hive was best for him. Mr. Dadant's experience seemed equally conclusive that the large brood-chamber hive was best for him. In what position does this leave the rest of us who have not experimented except with bodies perpendicular, the right leg on one side of the fence and the left one on the other?

It may be well to observe here that Mr. Doolittle gives the particulars of his experience. It was not an experience of much magnitude. I do not know, but I believe, that Mr. Dadant's experiments were conducted on a much larger scale, and covered a considerable period of time. Will Mr. Dadant please give us the details of his experience?

But with Mr. Doolittle's experience I was more favorably impressed than I was with his arguments. I fail to see how necessarily we have "more hands to hoe potatoes in March" and "more hands to hoe potatoes in October" when we use the big brood-chamber hives than when we use the little ones. I mean more in proportion to the size of brood-chamber. As a matter of fact, I suppose there are more bees in the big hives all the time. That is what we use the big hives for—to have more bees. If we have more all the time, we must necessarily have more during the honey-flow, and why will they not gather more surplus than the smaller number in the smaller hive? You answer, "Because there is more empty space in the brood-chamber for the bees to fill." But is there any more in proportion to the strength of the colony, when both colonies are as strong as the varying sizes of the hives will permit? I do not believe there is. I have never noticed any excessive number of bees around these big hives in March, and none too many in October, but always a plenty of them in June, and they went into the extracting supers as early and as readily as the bees in the smaller hives went into the section-cases.

I have used section-cases on some of these large hives, but not extensively enough to prove anything. Most bee-keepers agree that a large hive is best for extracted honey. Whether Mr. Doolittle is one of these I do not now remember. If there is such an over-abundance of bees in the big hives in March and October, when worked for comb honey, why is there not the same over-abundance when worked for extracted honey? Is this over-abundance any more detrimental in the one case than in the other?

Again, if you have a very prolific queen in one of these large hives, as you ought to have, will she not keep the cells so full of brood in its various stages that there will really be no more room comparatively for storing honey in the brood-chamber than there will be in the smaller hive? If she will, then the bees are compelled to go above, the same as the others. Mr. Doolittle remarks that enough is as good as a feast. This is one of the cases where a little too much would seem to be just enough. I should very much dislike the job of going over a large apiary to equalize stores.

One of the standing complaints about small hives is that the apiarist's work is very much augmented if he tries to prevent swarming, and that his surplus is likely to be very much reduced if he lets the bees have their own way. When we take into consideration the lessened liability of the bees to swarm when large hives are used, it seems to me that when the brood-chambers are once filled, a given number of colonies in the large hives should in a given time yield a larger amount of surplus than the same number of colonies in the small hives. I believe with Mr. Dadant, that they will do it. Satisfactory evidence that they will is yet to be produced.

I have this winter made 10 hives, 20 inches long and 12 inches deep to take 10 frames. If life is spared, and health permits, I shall keep on making these hives till I have 25 of them. They will be used for comb honey in comparison with 25 of the 8-frame dovetailed hives, as soon as I can get the large hives filled with bees and comb. I propose to fight it out on this line if it takes not only all summer, but many summers. It is by such means that a satisfactory solution of the question must be reached, if ever reached at all.

Leon, Iowa.

The Honey-Competition Fallacy.

BY J. H. MARTIN.

I notice on page 130, that Dr. Miller uses these words: "Whether the competition of California honey in the Northern markets is a good thing for Northern bee-keepers, may be questioned."

I think Dr. Miller, and a great many other well-intentioned bee-keepers, use the word "competition" rather loosely when applied to California honey, or honey from any other far western State.

It is easy to see that there may be competition in the production and marketing of potatoes or apples, and various other products that are almost universally grown, and are staple articles; but when we consider that there are over 70,000,000 people in the United States, and only a little over 63,500,000 pounds of honey produced—less than one pound per capita—it is difficult to see why the cry of competition should arise. I suppose it arises because it is the easiest way to explain, or to account for, low prices. But I believe if we look a little further we will see that California or Arizona honey cannot compete with Northern honey, or *vice versa*. The one great competition to both California and Northern honey is glucose, when in all of our leading markets glucose is mixed with our honey and sold to the consumers openly, and said consumers, when told that of two samples before them one is honey one-fourth part of which is glucose, the other pure honey, will nearly always take the mixed goods in preference to the other, owing to its lighter color and less-pronounced flavor.

If glucosed honey is sold in that way, it is a perfectly legitimate business, and, gentlemen bee-keepers, what are you going to do about it?

Again, if there was competition between California and Northern honey, what would be the result when there is a total failure of the crop in California? The price surely should run up to a figure to sort of balance the deficiency, but does it? How much did the price advance in the autumn of 1894, when all of the Eastern markets knew that the crop was a failure here? The fact did not make any apparent difference in prices.

I know it sounds discouraging to Northern bee-keepers to see in the market reports, "Market well supplied; several cars of California honey arrived;" but not a word do you hear about the cars of glucose that have arrived, and be the honey crop great or small, about the same amount of so-called honey will be sold; but in this case the most of it will be sold as pure honey. You have laws in every State, I think, against adulteration—what are you going to do about it, gentlemen bee-keepers? And why don't you wake up and do something?

Again, let us bring up another point: 70,000,000 of people, and 63,500,000 pounds of honey. Suppose we increase our output of honey to two pounds per capita, or 140,000,000 pounds. Seems to me there is a screw loose now somewhere, if we do not get a good price for our honey. Is it competition? No, sir! *It is a failure to distribute it in a wise and systematic manner.*

A little further along in his review, the Doctor says: "Possibly the success of those Southern men may be an example to others, and the markets throughout may be improved." That's just it, Doctor. No one would rejoice more than the California bee-keepers to see every bee-keeper in our broad land benefitted by our example. But, Doctor, don't put your hands in your pockets and be content to whistle: "'There's a good time coming;' those California fellows are going to bring it!" You want to get around and organize in every honey-producing State, and then instead of trying to sneak in under the mantle of the Union, the North American Bee-Keepers' Association (as I have more fully pointed out in Gleanings) should arise like a Phoenix from the dust, and become the great central head—the North American Bee-Keepers' Exchange. With thorough organization all over the continent, there would be but little chance for adulterators. The glorious time for which we have been longing would arrive, with its attendant benefits.

Bloomington, Calif.



President's Address at the Ontario Convention.

BY J. B. HALL.

It rejoices my heart that so many of us are spared to meet in convention, and that so large a number are here, notwithstanding the discouragement of the past season, many of us having had a total failure in honey, and had to feed our colonies to carry them through the winter. But truly the apiarist is a hopeful being, and most of us are nursing our pets with

the hope of a harvest in the summer of 1896. I trust that our hopes may be realized.

I am sure that you with me feel and regret the loss and death, and miss the kindly face, of our esteemed friend, the late F. A. Rose, of Balmoral, who has met with us so often at our annual meetings.

I would suggest for your consideration, that By-Law No. I, be amended by adding thereto—"That those opposed to the interests of its welfare be rejected or expelled by a majority vote of the meeting of members." I think you will see the need of this change in said By-Law, as the Association has no means of refusing membership to those who may oppose its best interests, through the public press or otherwise, who, as members of the Association, use such membership to give force to their statements, the reverse of the unanimous vote of the Association.

Also that some stated time be made with a stenographer for the delivery of the written report, as in the past the Revising Committee has been very much troubled by delay. Also that some practical apiarist be present when the report is being re-written, to give the stenographer assistance where he has "caught the sound incorrectly." I also think you will do well by choosing at a full meeting the Revising Committee.

I feel that as bee-keepers, and as an Association, we are greatly indebted to our representatives, and to the Parliament of Ontario, for their generous and kindly feeling to the apiarists of Ontario, and especially for giving the Province an efficient Foul Brood Inspector, whose services are put at our command. I am also pleased that the bee-keepers throughout the Province (excepting one or two would-be scientists) who cheerfully, willingly, and thoroughly followed the Inspector's instructions (and made a clean job by so doing) now have healthy and clean apiaries, and will be in a position to reap a bountiful harvest, if the Ruler of All causes the nectar to secrete in the flowers.

I am pleased that so many in Europe have been seeking our product, and hope that in the year 1896 we may have a full crop, and that the demand for it may be great. I find that our honey gives satisfaction to our British friends, and I urge that all of us put up and sell only first-class goods, and by so doing the demand for our product will increase.

I would urge you to push the pure honey legislation, for if obtained it will give us a position as honey-producers second to none in the world, for then our goods would be the guarantee of the Government of Canada as regards its purity, and that will go far with the British consumer. When permitted, put your name and address on each package.

An item may be of interest to some present—and the Executive Committee submit it for your consideration—in connection with the meeting of the North American, held in Toronto. Your Secretary and President were urged to call a meeting of the Board of Directors, to meet said North American and welcome its members to Toronto and to the Province of Ontario. To have complied with these wishes would have cost \$175.00, and this expense the Executive decided was not advisable, so they called together for that and other purposes the Executive Committee at a cost of \$20.85, thus saving to the Society \$154.00.

I am pleased that our Secretary is able to report an increase of County or District societies affiliating with Ontario, thus showing an increase of interest in apiculture.

Allow me to repeat, that I hope your labors of 1896 will be rewarded by an abundance of choice honey, to gladden your hearts and supply the demand of the honey-loving public.

Woodstock, Ont., Jan. 14.



Co-operation in Marketing Honey.

BY W. D. FRENCH.

Since I have undertaken to agitate the subject of an organization of bee-keepers, wherein a bee-keepers' union could be formed that would enhance the value of honey, and place the product directly before the people, in a manner heretofore described, I have been flooded with letters from the different States, extending from Maine to Washington; the drift of which tends to encourage my effort.

I am aware of the fact that nothing can be done with the present Bee-Keepers' Union, until other matters, which are now pending before that body, are settled. But I may as well say that I have the necessary assurance that steps will be taken at the proper time—co-operation in that direction has been pledged.

If Prof. Cook, Dr. Miller, and many others so prominently appearing before the bee-keeping world, could only see and read so many expressions favorable to the question which I

have sought to accomplish, I feel sure their attention would at least be brought to that subject.

There are thousands of people who are scientific, practical, and advanced apiarists, who do not write bee-literature for publication, or speak in public upon such subjects, not being gifted in that direction, but who are sound, sensible, thorough, and ready to accept practical ideas, especially that which tends to elevate the pursuit that we follow.

I do not wish to speak despairingly of any scheme which has a tendency to elevate or advance the pursuit or in any manner benefit the bee-keeping fraternity; but the time is sure to arrive when apiarists of all States will see that nothing short of a union of bee-keepers will accomplish the object which is so vital to their interests, and without which is so detrimental to the bee-keepers of California.

The scope of the Bee-Keepers' Union, as it now exists, is too narrow to ever warrant a large membership, consolidation with the North American notwithstanding; the benefits to be derived therefrom are isolated. Hence, the great mass of bee-keepers are not justified in contributing to its existence. Whereas, a union co-operated as a unit, systematically equalizing and distributing the product of the bees, thus rendering aid to every bee-keeper, and inducing them to become its members, would, in a short time, enlist every apiarist in our land.

Foster, Calif.



CONDUCTED BY

DR. J. P. H. BROWN, AUGUSTA, GA.

[Please send all questions relating to bee-keeping in the South direct to Dr. Brown, and he will answer in this department.—EDS.]

A Word to Southern Bee-Keepers.

The Southern Department of the American Bee Journal has been established for your benefit, hence we hope that you will avail yourselves of its advantages for throwing light on the seeming mysteries of the hive; and for unraveling, solving and making clear many of the problems that confront the beginner in bee-keeping. Send along the questions that you want answered, and we will take pleasure in giving you all the light we can.

There are many Southern bee-keepers of experience that have treasured up valuable ideas on bee-management and honey-production, that if put on paper and sent to the American Bee Journal for the Southern Department, might prove a blessing to many a beginner now groping in the dark. Dot down your experience, and let us have it.

J. P. H. BROWN.

Feeding Bees.

Lose no time to examine and ascertain the condition of all your colonies, for between now and the first of April is the most trying time with bees in the South. Last fall the bees laid up no great amount of stores, and hundreds of colonies will need feeding, otherwise they will "go up" before April. Feed regularly where needed, but always do it carefully—see that no sweets are exposed to strange bees, for if you start robbing you will have trouble.

Distinguishing Italians from Hybrids.

DR. BROWN:—Is there any way to distinguish whether bees are pure Italians or hybrids, when one knows nothing of them except that the stock was originally pure?

The bees commenced bringing in pollen Jan. 20, and have been working ever since. They are getting some honey now from peach, huckleberry, plum, and early pear bloom.

Ocean Springs, Miss., Feb. 24.

E. W. H.

ANSWERS.—The usual way of distinguishing pure Italians is by having the abdomen of the workers marked by three

yellow bands. The shade of these bands may vary from a bright yellow to a dark leather color. Very often the band next to the thorax may be indistinct, and only plainly perceptible when the abdomen is distended with honey. The workers of the whole hive should be of these markings; but when you find bees in the colony with one and two bands, some black and some with three bands, the queen is mated, and the term "hybrid" is applied to the inmates.

The pure Italians maintain their position on the combs better when the hive is opened and a comb removed, than any other race of bees. Hybrids are more prone to run and scamper, to leave the combs and take to the sides of the hive; and, besides, they are crosser than pure Italians.

Basswood Trees.

DR. BROWN:—Where can I get basswood trees, and when? I also want directions for planting, if they will grow this far South, and any other information concerning them, as I wish to purchase a few and try them here.

New Orleans, La.

J. B. D.

ANSWER.—You can get basswood trees from almost any Northern nursery. Plant any time from October till March, but the sooner they get in the ground the better, so as to give the tree a chance to throw out young roots before the hot weather comes on.

CONVENTION PROCEEDINGS

The Colorado State Bee-Keepers' Convention.

REPORTED BY F. L. THOMPSON.

The 16th annual convention of the Colorado State Bee-Keepers' Association was held in Denver, Jan. 20, 21 and 22, 1896.

S. M. Carlzen moved that an assistant secretary be appointed to take reports suitable for publication in the daily press and agricultural and bee journals, so that the Secretary could confine his attention to the minutes, and take part in the proceedings. F. L. Thompson was appointed.

MARKETING HONEY.

The first number on the program was Marketing Honey. S. M. Carlzen, of Montclair, read an essay, which may be condensed as follows:

Last season I increased my apiary from 28 to 61 colonies, and sold my crop for \$74.65, at the rates of 12½ cents wholesale up to 25 cents retail.

I suggest that we try to open up a Honey Exchange. I can recommend a competent business man as agent who is willing to give bonds for your protection.

I hope you will take action to have our industry represented by suitable floats at the second annual festival of Mountain and Plain, which will be celebrated next October in Denver.

Mr. F. L. Thompson says in the American Bee Journal, Dec. 12, 1895: "I believe Mr. Carlzen's locality is overstocked." Perhaps yours is, too. Why cannot we find a remedy? We should decrease instead of increase the number of our colonies. To sell our surplus colonies will not help matters. If it requires 100 pounds of honey a year to carry a colony of bees through, and if you have 100 colonies of bees in a locality where 50 are enough to gather the harvest, your loss is 5,000 pounds of honey. If you sell 50 colonies to your neighbors, you have not thereby relieved your locality. Put two colonies in one. Your wants will be met, and your bill of supplies decreased.

Our honey crops can be increased. Last spring I bought, from Nebraska, 100 4-year-old linden trees, which cost me in Denver 7 cents a piece. All but five lived and did well, and 12 bore an abundance of blossoms. These trees will be set out in my vicinity, regardless of other compensation, wherever irrigation and care is assured.

S. M. CARLZEN.

A committee to see that bee-keeping be represented in the festival of Mountain and Plain, according to Mr. Carlzen's suggestion, was appointed later.

Rev. F. O. Blair, of Trinidad, also read an essay on marketing honey, in substance as follows:

My bee-keeping is a kind of side-show. I have never produced a large amount, and do not expect to. I have a market in Trinidad for all the honey I can produce, which is chiefly extracted. I put it up in pails holding 5, 8 and 10 pounds, and of course it soon candies. The labels on the pails includes directions for liquefying so as not to ruin the flavor. Each customer melts it to suit himself, and I hear no complaints. I sell a single pail for 12½ cents a pound. If a man takes 50 or 100 pounds, I sell for 10 cents; if 500, for 9 cents.

F. O. BLAIR.

The subject was discussed as follows:

N. C. Alford—If Mr. Carlzen had had a large amount he could not have sold it at 12½ cents, especially in these times. People will provide substitutes for honey.

F. Rauchfuss—Farmer bee-keepers damage us. Their honey is poor. Some of it is sold in the supers. Much of it is sold for 8 cents.

V. Devinny—That honey is retailed at 10 cents. Honey, now, after such competition is past, has been sold for 17 cents. This shows what might be done. The only remedy is to buy up such honey, but I doubt whether it is practical to do so.

F. Rauchfuss—To get a higher price, sell by the case instead of by weight.

A. M. Preston—There is a home market for the small crop, but not for the full crop. We should combine to get our produce near the consumer, and ship in carload lots.

Mr. Devinny, representing the committee on legislation, then made his report. He had put in a bill for an appropriation of \$500 only, and had worked faithfully for seven or eight days. The bill passed as far as the Senate. There was much other legislation at that time, and things were rushed so that many bills were passed by, this among them. One clause of the printed matter which he distributed among the members of the assembly is as follows:

"The production of honey and wax is no longer an experimental enterprise, but promises to become a vast and profitable industry of the State, when its advantages are more generally known and understood by the people, and it should receive a full share of legislative aid as do the growing of fish or wild game, upon which thousands of the people's hard-earned dollars are annually lavished."

Mr. Carlzen, representing the committee on securing a room in the Capitol for the use of the Association, and the committee on adulteration, reported that both bills had passed the House, and had not been called up in the Senate.

Some of the foul brood inspectors made their reports. They will be given later, when all are in. A discussion on foul brood ensued, as follows:

FOUL BROOD.

Mr. Alford—The management which requires mixing up bees and changing frames in spring will surely spread foul brood.

Mrs. Rhodes—That has been my experience.

Mr. Preston—And mine.

Mr. Devinny—The foul brood law ought to be repealed.

Several members here gave instances of the insufficiency of the system of inspection.

Mr. Devinny—Bees should not be inspected after Sept. 1.

F. Rauchfuss—Suppose the weather is fine, and one wishes to buy and remove bees—a clean bill of health is wanted.

H. Porter—Bees can be inspected any day when they fly strong.

D. L. Tracy—We have got to have class legislation.

Mr. Preston—There are days in almost every month in Colorado when bees fly. They can be inspected without injury as long as they don't rob.

Mr. Devinny—The law provides for transferring. That cannot be done any month in the year.

F. Rauchfuss—One hundred and fifty colonies in Mesa county had to be burned. It is really cheaper to do so. If the inspector burns, we know it's done.

Mr. Devinny—Did the State pay for those bees?

F. Rauchfuss—No.

Mr. Devinny—That is where the law is unjust. No man has a right to destroy property. Even law cannot be a law unto itself; and when the bees are burned, that destroys the evidence of foul brood.

Mr. Preston—I had the constitutionality of the law looked

up by the best lawyer in my county. He said, "Go ahead—if the bee-keeper can show damages, the county has to pay for it."

Pres. Aikin—Mr. Deviny errs in so sweepingly condemning the law. Certainly, good can be done. But the law is not right as it stands. It condemns property without recompense.

Mr. Preston—Dr. Howard claims that foul-broody hives can be exposed without again generating the germ.

Mr. Deviny—It is the honey that passes through the stomachs of the nurse-bees that we have to look out for. Clean the hives, don't burn them, and keep foul-broody honey away; that's all.

Mr. Porter—Do the germs increase in honey?

Mr. Preston—According to Dr. Howard, they do not, but they are preserved by it. [Inspector Adams was not present at this time, or he would doubtless have said something. See his article on page 248 of the American Bee Journal for 1895.—F. L. T.]

Mr. Thompson next read an essay on management of swarms, an abridgement of which follows:

MANAGEMENT OF SWARMS.

In Colorado it is safe to say that three-fourths of the difference between success and failure in keeping bees lies in the proper treatment of swarms. Every colony should give a surplus in the poorest season.

The ordinary management is to set the swarm in a new location, leaving the old colony in its place, with the super on it. When the swarm has filled its brood-chamber, it also is given a super. This is according to Nature.

But bees in a state of nature don't set out to produce what we call surplus honey. They divide their forces during the flow; whereas the one golden rule we should keep in mind is that which is well stated in the words of Mr. Demaree: "A system of management that will keep the full working-force of the colony together during the entire honey-flow."

When swarming is allowed, the swarm only should get the super, and it should be set on the old location, the old colony being removed elsewhere later on. If increase is wanted, the old colony is first made to contribute all the bees it can spare to the swarm, and then left to itself, and only expected to build up to a full colony by fall. Not many bees are necessary for this.

Perhaps the best way is to set the old colony by the side of the swarm a few days, then shake off all its bees in front of the swarm except such as are on one comb (or more according to weather or advancement of season) which contains the best-looking queen-cell, then remove what is left of the old colony (*i. e.*, all the brood and the smaller part of the bees) to a new location. As Mr. Demaree rightly says, there is no need of any fuss about it. There is only one operation to remember, and when you have done that, you have done everything, and done it thoroughly. This also prevents after-swarms, which are a regular nuisance, and do not pay anyhow. If more increase is wanted, the old colony, instead of giving bees to the swarm, can be divided into nuclei. This is a plan I have successfully practiced.

When increase is not wanted, the simplest way is to proceed as before, and give the swarm in a contracted brood-chamber (preferably shallow rather than narrow) with a queen-excluder. It will not be worth much in the fall, but it will have stored lots of surplus. It can then be united to the old colony.

There is another plan, followed by Mr. Lyman, of Illinois, by which it is the swarm which survives and the old colony which is united to it. I have tried it with good success, but do not know whether it is any better. This plan has been described in the American Bee Journal, Vol. 34, page 211.

F. L. THOMPSON.

Next came an essay by D. L. Tracy, entitled, "Natural Swarming," most of which follows:

NATURAL SWARMING.

There has not been a year since I commenced to handle bees but what they have paid expenses, and a little more, up to a very fair profit.

If I were starting in the coming spring with plenty of colonies on hand, I should only save the largest swarms. I should send the small swarms back into their hive. I would place the swarm in the new hive, carry it to where I wished it to stand, and let them alone from 24 to 60 hours. When another swarm came off I would take it to the first one, lay a board or white cloth in front of the hive, gently lay them upon it, give swarm No. 1 a good puffing with the smoker, gently puff No. 2, and as they go in catch the queen and pinch off her head. This is my plan when I only desire to save a

few swarms. The hive will be full of bees, and with any nectar in the flowers will give a surplus.

My second plan, when I do not wish to enlarge my apiary, is to use a 10-frame hive, filled not with brood-frames, but with seven wide frames, the old style 8-section holder used in a double body; or, use section-holders. This will fill the brood-chamber with 56 one-pound sections. Proceed as with the first plan, and on the third day—not later, for after the third day the queen may commence to deposit eggs—open the hive and take the frames out gently. Some of the sections will have been drawn out by this time. Lay them on a board or cloth in front of the hive, puff them a little with the smoker, and as they go in catch the queen. Pinch her head. Close the hive and let them alone until the next day. If a swarm comes off, run them into the queenless hive the same as before, catching and killing the queen. Put on supers according to the size of the swarms.

With this plan you have two things to contend with—a laying worker or the "blues." The laying worker is the hardest to contend with. The blues may be overcome by baiting with partly-filled sections. Should the bees commence to dwindle too much before the sections are capped over, add another swarm or part of one.

This hive must be watched very closely, for often the bees seem to go all at once. I have had a hive like this with 150 sections full, and not a handful of bees in it.

I like this plan better than the first, and it seems more humane than the practice of some to put the swarms in boxes and kill them in the fall.

D. L. TRACY.

The latter essay was then discussed:

Mr. Deviny—I don't like the plan for poor seasons; too many are lost.

Mr. Tracy—I do not run all my bees that way.

H. Rauchfuss—What kind of combs do they build?

Mr. Tracy—Straight.

Mr. Porter—When you are looking for a queen, how about other swarms coming out?

Mr. Tracy—I don't care if 17 swarms get together, if they have no queen.

H. Rauchfuss—Are there not too many bees in a hive sometimes? We tried the plan of running the bees of two colonies into a third hive between the other two, by means of an automatic device. It did not work. There was too much hanging out. But when by means of the same device we turned the bees of only one hive into an empty hive, it worked all right. In that empty hive we set one frame of brood, which was removed when the queen began to lay.

Pres. Aikin—My average last year with the unqueening system was 100 pounds per colony. Three colonies together in one empty hive gave three good supers. Two others in one hive gave two supers. I do not think there can be too many bees.

F. Rauchfuss—The reason why we did not succeed with so many bees, is that we had too many young bees. Your unqueening system cuts off the supply of young bees.

Mr. Tracy—My plan was suggested by Mr. Aikin's principle of having no young bees to feed.

Pres. Aikin—Don't leave them hopelessly queenless too long. A colony that has laying workers is useless for honey.

H. Rauchfuss—We had a case of laying workers in which in spite of queen-cells in the hive, comb was built around and on the queen-cells (which were fastened on a stick by the Doolittle method), and eggs laid by the workers in that comb. We had several cases of a young queen in the hive at the same time the workers were laying.

When the colonies are weak, queens will seldom lay 5 or 6 eggs in a cell as laying workers do, but when an egg is found on pollen, it is a sure sign of laying workers.

PRODUCING EXTRACTED HONEY.

This subject was next on the program, but as no essay had been handed in, it was taken up by discussion.

Mr. Porter—I have almost concluded it would have been better if the extractor had never existed. We can get nearly as much comb honey. There is the trouble of adulteration to contend with. We can't educate people on that subject. I used to think so, but have given it up. There is no question that there is much adulteration.

Mr. Deviny—Adulteration is on the increase. Extracting encourages it.

H. Rauchfuss—There is not so much adulteration as some imagine. Some people get notions in tasting. In a large grocery a clerk told me that some 5-gallon cans they had contained adulterated honey. It was as nice alfalfa honey as I ever tasted. But that is the disadvantage of extracted honey.

Another disadvantage of extracting is that winter losses are too heavy. There is a tendency to extract too close. The colonies are not in as good condition as when run for comb honey. I don't know the reason exactly. Possibly the bees are benefited by producing wax.

Mrs. Booth—Somebody stole my extractor 10 years ago, and I was glad of it.

Mr. Porter—It is hard to keep up the stock when extracting. Colonies out of honey and weak in bees are very apt to result. A man took charge of an apiary for me for several years, and extracted altogether. He understood his business; he never extracted from the brood-chamber; but that apiary kept running down. The bees do not store so much below. Of course, extra frames of honey can be saved, and the stock can be kept up; but does it pay?

Mr. Rauchfuss—If a queen-excluder is used, more honey is stored below than otherwise.

Mr. Blair—I have no trouble in educating people. Quite a number of my colonies are set aside for strengthening others by frames of brood. When the flow comes, the strengthened colonies roll it in.

Pres. Aikin—My experience is much like Mr. Porter's. When colonies are given full sets of combs, they put almost every bit of honey above, if they are good ones. Therefore, we want large hives. Plenty of honey in the spring means plenty of bees. The 8-frame hive here is a mistake. It will not succeed. But I have an idea that in the future we might produce extracted honey and let the bees build the comb. We could let somebody steal our extractors, run the combs through rollers so as to thoroughly crush them, drain the mass, and get the finest honey and wax.

Mr. Rauchfuss—We once let the bees build their combs from starters in producing extracted honey. We transferred 47 colonies. They each had 4 or 5 combs, after being transferred, and built the rest. We also put on an upper story with inch starters. They averaged 109 pounds in 17 days. But of course there was a loss in profit. These colonies did not swarm, because we gave them young queens.

Mr. Devinny—There is always a little difference of taste in favor of comb honey. Possibly there is some chemical action by contact of the honey with the wax.

(Continued next week.)



Swarming Contagious.

L. A. Aspinwall says in Review: "Although my chief object in the production of artificial comb [made of wood] was to prevent swarming, I saw other possibilities; and, although, as a non-swarmer it was not a complete success where located among swarming colonies, still, when isolated I have never known colonies in artificial comb to cast a single swarm. This was abundant evidence to my mind that the swarming impulse is contagious. The aggregation of numerous colonies under the control of man, places the bee under unnatural circumstances which favor contagion of every kind. When isolated, the absence of drones is sufficient to prevent swarming. Modern bee-keeping, with the use of comb foundation to exclude drone-comb, certainly restrains swarming to some extent."

Many Bees, Much Honey.

In the spring I selected an ordinary colony of bees, and set it apart for extracted honey. I built them up as fast as possible and when the fruit-trees came in bloom the queen had brood in 12 frames, and from that source I obtained 16½ pounds. A few days after this the 12 frames, bees and all, were set in a hive four feet long, and a division-board placed at the rear of the frame of comb. Once a week two more empty combs were inserted in the center of the brood-nest until the hive contained 20 combs well filled with brood. As white clover was not yielding honey, the hive was filled out with frames of empty comb, which numbered 32. I did not expect that queen would occupy any of these last 12 combs, but in this I was mistaken, for before white clover was through

yielding honey I found brood in every one of the 32 combs, which if placed compactly together, was fully equal to 15 frames of brood, coming out to the wood all around. Each frame would give at least 100 square inches, making all due allowance for the few cells of pollen that would be scattered about in different cells, and each square inch gives 50 worker-bees, hence there were 5,000 bees to hatch out each of these frames every 21 days, or 75,000 from the fifteen frames. The average life of the bee in the working season is 45 days, hence it will be seen that the queen can place two and one-seventh generations of bees on the stage of action, to where one generation dies off. Two and one-seventh times 75,000 equal 160,700, as the number of bees in the hive during the basswood yield. From clover, they gave 186 pounds; from basswood 287½ pounds, and from buckwheat, 76 pounds, making 566 in all.—G. M. DOOLITTLE, in American Bee-Keeper.

Building Out Drone Foundation Quicker Than Worker.

I wrote an article about a year ago, telling the result of my experience in using drone-foundation in the sections. I claimed that, when the regular (or worker) size was used, the bees would not finish it and cap it as soon as they would when drone size was used; and when a starter was used, the bees would change it to drone.

I have experimented by having each alternate section all drone and all regular; and last season I "kept tab" on 550 sections and find: The drone sections are finished 13 to 68 hours before the regular, or average of about 32 hours. In the height of the honey-flow, hours are worth money. I wish some of the older bee-keepers would give us their experience on this point. I will use drone foundation in all my sections hereafter.—HARRY DWIGHT.

[At the time your article was published I called for reports; but, if I am correct, none were received. Bees, it is true, seem to prefer, for storage, drone-comb; but the trouble, as I then pointed out, was that the queen, not having drone-comb in the brood-nest, was quite sure to go into the sections if filled with drone-foundation. But this can be overcome by the use of perforated-zinc.—ED.]

The New Weed Process Comb Foundation.

Just as soon as we got the new Weed process of making foundation nicely under way, we sent Mr. O. O. Poppleton, of Stewart, Fla., sample sheets of the product, and sample sheets of the old foundation, same weights and size. These he was to test in the apiary as soon as the weather would permit, to determine the relative sag or stretch of two kinds of foundation in the hive. After he had made his first tests, he wrote us that the difference was slightly in favor of the new process; but the weather was hardly suitable to arrive at satisfactory results. A month or so later we heard from him again, under date of Feb. 19, giving more exhaustive experiments, the result of which showed that the sag by the old process, or dipped foundation, he had been trying, was nearly five times greater than by the new process.

Mr. Poppleton, cautious as he is, desires to test the matter further, when the weather is hotter, and will report again. He adds: "It looks as though your claim—that the new method gives extra toughness to the wax—is correct." Anyone who works the two kinds, the new and the old, in his hands can readily see the difference; and it is not surprising at all that the bees should discover the marked difference in favor of the new foundation. Incidentally it may be remarked that the bees can work this wax in a much cooler temperature than the old dipped product.—Gleanings.

Syrup by the Cold Process vs. that by the Old Way.

Last winter, and so far this winter, we tried, and are trying, syrup by the cold process, and so far as we can see, it is fully equal (if not superior) to the ordinary syrup made ¾ water and ¼ sugar where heat was used; and by the cold process we have used the sugar and water half and half, and it was then brought more nearly to the consistency in which bees find the raw nectar in the flowers. Such thin syrup, I am sure, is ripened better whether heat is used or not; and when sealed in the combs, for us at least, it makes very much better stores. None of sugar syrup has shown the least tendency toward granulation, and the bees last winter came out on it in perfect condition. I do not believe heat has very much to do with it either way. Mechanical mixtures can be effected perfectly by vigorous stirring, either hot or cold, providing the sugar is in proportion of half and half, and this, in our experience, is quite thick enough in order to insure ripening on the part of the bees. They will then reduce it down themselves to the right consistency, if you give them a chance.—Gleanings.

THE OLDEST BEE PAPER IN AMERICA ESTABLISHED IN 1861

THE AMERICAN BEE JOURNAL

PUBLISHED WEEKLY BY

GEORGE W. YORK & COMPANY,

118 Michigan St., - CHICAGO, ILL.

REGULAR CONTRIBUTORS:

G. M. Doolittle, of New York. Prof. A. J. Cook, of California.
 Dr. C. C. Miller, of Illinois. Dr. J. P. H. Brown, of Georgia.
 J. H. Martin, of California. Rev. E. T. Abbott, of Missouri.
 Chas. Dadant & Son, of Illinois.
 B. Taylor, of Minnesota.

\$1.00 a Year—Sample Copy Sent Free.

[Entered at the Post-Office at Chicago as Second-Class Mail-Matter.]

Vol. XXXVI. CHICAGO, ILL., MAR. 19, 1896. No. 12.



California Bee-Keepers' Exchange.—We have received a copy of the By-Laws of this new organization, and have been much interested in reading its pages. All California bee-keepers should address the Exchange, P. O. Box 152, Los Angeles, for a copy of the By-Laws and such other information as may be ready to send out. Surely, every bee-keeper in that State will wish to become a member of the Exchange. We believe that instead of its resulting in the least detrimentally to honey-producers outside of California, the Exchange is going to prove a great blessing. They certainly have set other States a good example. Bee-keepers must unite if they ever expect to get and keep what is justly their right.

Sweet and Alsike Clover.—This month and next are the months in which to sow the seed of sweet clover—that excellent honey-yielding plant. What a wonderful addition to the bee-forage of the country would there be, if every bee-keeper would sow say only 10 pounds of sweet clover seed each year! In a very few years we believe the effect would be easily noticed in the increased crop of honey gathered.

Above all things, do not fail to sow some Alsike clover seed also; and get your farmer neighbors to do the same. Better send to us for 50 of the Alsike clover leaflets, and hand them around. Only 25 cents for the 50 copies.

Wood-Base Foundation.—We have received the following about wood-base foundation, from Mr. E. B. Huffman, of Homer, Minn.:

EDITOR BEE JOURNAL:—I have just received a sample of foundation sent me from a certain manufactory, called "veneered comb foundation." It is made especially for the brood-chamber, very thin wood with foundation on either side. Do you consider it good, or in what way do you consider it best to arrange the foundation in the brood-chamber where one runs for comb honey?
 E. B. HUFFMAN.

Very few reports have been received as to foundation with wood base. One or two have reported favorably. If others have tried it, it may be well to report the result, no matter whether favorable or otherwise.

The Benton Bee-Book Resolution passed the House of Representatives March 9, as shown by the following letter which was sent to Hon. Geo. E. Hilton, of Michigan:

WASHINGTON, D. C., Feb. 9, 1896.

HON. GEO. E. HILTON:—I am glad to inform you that the Bulletin called "The Honey-Bee," is to be reprinted, Resolution having passed the House this morning to print 20,000 additional copies for distribution.

I have been pushing this matter in different directions ever since your letter was received. As soon as I get a supply to my credit, I will send you as large a quota of my portion as I can spare. Your friend,
 R. P. BISHOP.

As the above Resolution will probably pass the Senate, and Senator Burrows' Bill will pass the House, this will make 35,000 more copies of Mr. Benton's book.

Some time ago Mr. Hilton sent in a list of his customers of 1895, and some others; the Department of Agriculture notified them of his action, also that their names had been listed, and that they will receive a copy as soon as published. Mr. H. expects to get enough copies through his Congressmen to supply his new customers the coming season, without any cost or trouble to them.

Of course, now that there will be an ample edition for all printed, the only thing necessary will be for those who desire Mr. Benton's book, to simply send a request for it to the Department of Agriculture, Washington, D. C.

These congressmen who labored to secure this National recognition of bee-culture, and all who voted for the Resolutions, deserve the hearty thanks of bee-keepers everywhere. It ought to result in an increased interest in apiculture throughout the whole United States.

Experiments in Bee-Keeping.—Mr. B. Taylor said this in the Farm, Stock and Home:

I am wintering some 40 colonies in two-story hives of 2,000 inches of comb space, and at least 50 pounds of honey per colony. I had intended to stop experimenting, but there are yet many unsettled things in bee-keeping, and I shall go on testing methods hereafter with more care than ever. I will set three large double hives, with their rich stores, on the summer stands, treat all as near alike as possible, and then keep a strict record of which gives the earliest and largest swarms, which class gives the most salable honey during the season, and then figure the comparative profit of each.

A Horticultural Fable.—Mr. A. O. Packard, of Lindale, Tex., kindly sent us the following clipping, with the request that "a little apiarian light be let in upon the mind of the editor of Meehan's Monthly:"

In the Horticultural Department of Meehan's Monthly, for December, there is an article which will be of great interest to bee-keepers, for it is made clear that half-starved bees will attack fruit in spite of the claims of bee-keepers to the contrary. The writer says:

"That honey-bees destroy grapes, raspberries, and other fruits is a well-known fact, though bee-keepers and bee-journals dispute it. The creatures are not able to bite the skin, but, in the grape particularly, they start near the attachment of the berry with its stalk where it requires scarcely any force to thrust the tongue through. There are some bee-keepers who are the essence of meanness—people who keep bees without taking the slightest interest in providing flowers, and who line their pockets out of the predatory practices forced on the industrious bee. It is too bad that these useful creatures should be led to their destruction by the want of conscience in their owners; but there is nothing left for those troubled as our correspondent is, but to hang up bottles of sweetened liquid out of which the little thieves cannot escape. It is believed that bees would not steal fruit, if the bee-owner provided flowers for them. It is easier to gather honey than to suck grapes."

It seems strange that such an able paper as Meehan's Monthly should publish matter that betrays so much ignorance on the part of the writer. It's bad enough to have a writer in a horticultural department who knows nothing

about bees, but when he knows nothing about grapes it's carrying matters a little too far. Did ever any one see a bee "thrust the tongue through" "near the attachment of the berry with its stalk?" The tongue is delicate as a camel's-hair pencil. Just try pushing the latter into a grape "near the attachment" or anywhere else. Besides that, if he had ever seen grapes worked upon by bees, he would invariably have found that they were working through a perforation made not "near the attachment," but right through the part farthest away, the perforation being made by birds or wasps before the bee can have the slightest effect upon it.

The "essence of meanness" is to have a colony of bees without providing a nice little posy bed 10 feet square for each colony, so that no bee would ever go 10 rods from home!

Now will Meehan's Monthly do the *amende honorable* by telling its readers no bee can puncture a grape at any part; that bees fly in all directions a mile or more from their home, and would be likely to pay little attention to flowers planted close by their hives; that they more than pay for all theectar they gather by means of the aid they give in fertilizing the flowers; that an acre of flowers planted by the bee-keeper would not ensure that the bees would keep away from a vineyard within half a mile; that bottles of sweetened liquid would not prove very effective; that so far as they did trap bees, the man who should hang them up would be guilty of a criminal act, and liable to prosecution; and that it is sorry such stuff ever got into its usually reliable columns?

A Many-Named Honey-Plant.—A "stray-straw" in Gleanings reads thus: "Shamrock, the national emblem of Ireland, is nothing more nor less than our much-valued white clover. It is worn in honor of St. Patrick, who is said to have plucked a leaf of this plant to represent the Trinity. The botanical name is *Trifolium repens*. It is also called Dutch clover, white trefoil, white meadow trefoil, creeping trifolium, creeping clover, stone clover, honeysuckle-grass, honeysuckle-clover, and, in Germany, sheep-clover, field, bee, and little clover. The French name is triplet, trefle blanche, or blanc; Spanish, trefol blanco; German, weisser Klee; Italian, trifoglio."

Questions AND Answers

CONDUCTED BY

DR. C. C. MILLER, MARENGO, ILL.

[Questions may be mailed to the Bee Journal, or to Dr. Miller direct.]

Feeding Bees Short of Stores.

I expect to put my bees out the first day of March, if it is not too bad weather. I have them in a good cellar made purposely for bees, but they are very light. Yesterday my bees flew—five colonies that I had out-doors this winter. I have 71 colonies all together. How can I feed them? Honey is scarce around here this spring, but some of my bees have more honey than they need. They are all in patent hives. Would it do to take a frame from those that have lots of honey, and put it into another hive? Is home-made molasses good enough to feed them, and light brown sugar?

C. W. A.

ANSWER.—It will be all right to take a frame from the colonies that have too much and give to the others. Home-made molasses and brown sugar will do to feed as soon as it is warm enough for the bees to fly every two or three days. In

fact, when bees can fly all the time you can safely feed them anything they'll take, if it isn't actual poison. But when they cannot fly there's nothing better than sealed honey. When you can't have that, use a syrup of granulated sugar. It wouldn't be best to feed syrup in the middle of the winter, but it's all right for spring. Use the crock-and-plate method that has been described in back numbers. Fill your crock half full of granulated sugar, then fill up nearly full of water, cover the crock with one or two thicknesses of woolen cloth or six thicknesses of cheese cloth, lay a plate over it upside down, then turn the whole business upside down, crock, plate and all. Set it on top of the frames, and set an empty hive over it so the outside bees can't get in.

Bees Dying—Use of Foundation—How Many Supers to the Colony?

1. One of my hives is exposed to the full rays of the sun. The other day it was very bright, although the temperature was 8° below freezing, yet a goodly number of bees left the hive, whether to explore, or what, I don't know. Many of them never returned. They were frozen, apparently. Now what is troubling me is whether those bees would have died any way, or whether I should shelter the hive to prevent them dying so suddenly.

2. Would you advise a beginner to use full sheets of foundation in getting combs, or follow Doolittle's plan, as given recently?

3. In working for comb honey, how many supers would you advise per colony?

CARNIOLUS.

ANSWERS.—1. While many of those bees may have been of such age that they would soon have died inside the hive, I'm afraid some of them in full vigor were enticed by the bright sun to their death. So it might have been better if the hive had been shaded.

2. That's a hard question to answer. Opinions differ. Gravenhorst, high German authority, says that the bees will do about as well without foundation as with it for the first five combs, but after that it is best to have foundation. Taking into account the great length of time that the combs are to last, and the straight and true combs one can be sure of with foundation, and all worker-cells, I prefer to use full sheets of foundation. But I'll not quarrel with those who think differently. If any difference is to be made on account of one's being a beginner, I should certainly say that the beginner has the stronger reason for using full sheets of foundation.

3. Circumstances control that entirely. Last season I put one super on each hive. And that was one too many. Sometimes five or more are needed. When a super is about half filled it's time to add a second. And when there's only about half a super of empty space in the two supers that are on, both taken together, then it's time for a third, and so on. In general it's well to have ready in advance about twice as many supers as you'll need for an average season, for the coming season may happen to be one of the extra-good ones.

Fire in the Bee-Cellar.

I have 100 colonies of bees in a damp stone cellar. The first part of the winter (before we had any snow) the temperature was 34°, then as the snow began to gather around the building it rose to 38°, and now it stands at 40°. I put a small coal-stove in the cellar, and built one fire in it, which raised the temperature to 50°, but the next day it was back to 40° again. The bees have plenty of splendid honey, and are quiet, with no signs of dysentery, and very few dead bees on the cellar-bottom. The temperature will probably go a little higher as the snow gets deeper. Would it be best to make a fire occasionally, or run one most of the time, even if it keeps the temperature up to 50°? I never kept them in this cellar before?

Mapleton, Maine.

E. T.

ANSWER.—It isn't easy always to tell without trying, just what is best. The thing that's wanted is to keep the bees so they will be in the quietest condition possible without being too cold. For even if bees are in very bad condition, you can quiet them down considerably by running the temperature down below zero. The air of the cellar should be pure and sweet, with no smell of diarrhea. Now if you can manage to keep a constant fire in the cellar so as to keep the same temperature all the time, and have the bees very quiet, then you better keep the fire going all the time. Cellars differ, and

thermometers differ, and your cellar may be as cold for the bees at 50° as your neighbor's at 40°, for there may be 10° difference in the thermometers. A dry cellar will allow the bees to be quiet at a lower temperature than a damp one. So you see you must cut and try. If putting a fire in the cellar makes the bees noisy at first, you needn't feel troubled about that, but if the fire keeps the cellar at 50°, and the bees continue noisy for 24 or 48 hours, then you better let the fire die down and build one again a week later. If you can keep the fire going all the time, and hold the temperature day after day at that point where the bees are the most quiet—and that will probably be somewhere in the neighborhood of 45°—then keep a steady fire. Otherwise put in an occasional fire, and in the case of an occasional fire you can let the temperature run higher than if you kept it going all the time. It will do no harm if the temperature runs up for a short time to 60° or more, but it might be dangerous to keep a constant fire at that.

Variety of Brood-Combs—Marking Hive-Entrances—Thrown-Out Brood.

1. I have a lot of brood-combs which I intend to use at swarming-time next season. There are a lot solid full of foundation, and just as many frames solid with straight worker-comb, a lot empty, with a little over 1/16x1/2 inch wax starter instead of foundation, and a few dozen that contained drone-comb, little patches which I cut out. Now how could I use all of these the best, or with the best results? Would it do to have them mixed, or each kind alone, when hived on small quarters, or will they build out the partly-filled frame again with drone-comb? How about the starters? I always prevent after-swarming by moving the parent hive on the eighth day.

2. I see at these packed bees (sheds) on a warm day that bees fly, they don't know which is there own home. They don't fight, but fly from one bridge to another, 4 inches apart; each bridge being 16 inches wide. How would it do to put some kind of a mark above each entrance, and when I remove the sheds this spring to put the same mark on each hive, or wouldn't you mark them?

3. I bought a colony in a box-hive from a neighbor, moved them home, and sometime in January I noticed chilled brood at the box-hive entrance, and among the packed ones at this date, I couldn't see any pushed-out brood, just as if they were not at breeding. January was not so cold, and bees had several flights, but February was colder, sometimes a little below zero. Without knowing how the packed ones turn out, would you think there was no chilling nor brood pushing out? Each packed colony has about 30 pounds of honey, and good sugar and water fed early to some to make the 30 pounds.

Brickerville, Pa.

E. B. K.

ANSWERS.—1. The first thing to do is to cut out all drone-comb starters and melt them up. Don't think of saving anything by using it for starters in any comb in which the queen is ever expected to lay. With drone starters the bees are more likely to continue building drone-comb. Very likely you'll do best not to mix the foundation and empty combs. Bees are more likely to build worker-comb the first few days after swarming than they are later. So it may be a good plan to crowd a swarm onto four or five frames, and when those are about filled give the balance of the frames filled with foundation.

2. Yes, it's a good plan to have something by which the bees can mark their own entrances. A post or a board standing between two entrances is a good thing. Any kind of a mark will help.

3. I think you needn't be very anxious about the brood you saw thrown out. You'll probably find them all right in spring.

Transferring During Maple Bloom.

To-day (Feb. 18) my bees are coming in loaded with pollen and honey. If this continues, would it do to transfer? The soft maples will be in bloom in about two weeks, and the bees work on them more than on fruit-bloom, at least here at my place. My bees have a good deal of honey. If I transfer I can put this into the new hive.

Perris, Oreg.

W. D. M.

ANSWER.—Having no personal experience in the matter, I wouldn't like to speak positively, but I suspect that it will be well to wait till later than maple bloom. Even if the bees work more on maple than on fruit-bloom, the weather during

soft-maple bloom is not so warm as in fruit-bloom, and after being transferred the bees need weather warm enough to work wax in good shape so as to make all needed repairs. You could tell by trying a single hive during maple.

Alfalfa Growing.

A correspondent at Platteville, Iowa, which is on the southern line of the State, writes as follows:

"As I am thinking of sowing some alfalfa, I want to know what kind of success it has had in Iowa. Will it grow on any kind of soil? What kind of soil does it favor? Do you think it would do well in southern Iowa? How much seed should be sowed to the acre? Which do you think the most profitable, alfalfa or red clover? When should alfalfa be sowed and how should the ground be prepared? Should it be cut or pastured the first year? Should it be sowed with a nurse crop?"

There are a good many instances of successful alfalfa growing in Iowa, and a good many in the southwestern part of the State. There are also a considerable number of failures, some of which have been due to bad methods in sowing and growing, and some to an improper selection of the soil; for replying to the second question put by our correspondent, alfalfa will not grow on every soil. It does best on a deep sandy soil, underlaid by a loose, permeable subsoil. It will not grow where there is an excess of water in the soil, nor where there is hardpan between the surface and the permanent water table, which should not be less than six or eight feet below the surface. Success with alfalfa seems to depend upon large root growth, and this root growth ceases if the roots reach water too soon. We think there are many places in southern Iowa where alfalfa would do well.

The seed weighs 60 pounds to the bushel. For a hay crop it is customary to sow from one-third to a half bushel, and for a seed crop from eight to nine quarts, say from 15 to 18 pounds. As to which is the most profitable, alfalfa or red clover, a direct answer is hardly possible. The feeding value of alfalfa is nearly a half greater in protein than that of clover of equal quality, one-sixth less in carbohydrates and somewhat less in vegetable fat. Where both do well, the alfalfa is much the larger producer, and it also has the advantage of being a perennial, lasting with suitable management, soil and climate, indefinitely. It has the disadvantage of being harder to cure than hay, and it suffers greater loss from shattering of leaves, which is the most valuable part of the hay.

Alfalfa should be sowed or drilled as early in the spring as the ground is warm and the danger from late frosts has passed. The ground should be plowed deep and the surface should be made smooth and mellow. The seed should be covered lightly, not to exceed an inch, using a light harrow or brush, or if broadcasted just before rain no harrowing or brushing will be necessary. It should not be cut or pastured the first year, but its chief enemy during the first season being weeds it will be advantageous to mow two or three times during the season with the cutter-bar set high, leaving the cuttings on the field as a mulch. It should not be sowed with a nurse-crop, although there are some experiences where fairly good results have been obtained without a nurse-crop.—The Homestead.

Removal Notice.—In order to get more room, we have removed from 56 Fifth Ave. to 118 MICHIGAN ST., where all our correspondents should now address us. We are on the 3rd floor in the large brick building on the southwest corner of La Salle and Michigan Streets—one block north and one block east of the Chicago & Northwestern Passenger Station. Remember, we are on Michigan Street, not Michigan Avenue. The latter is used almost wholly as a boulevard and residence thoroughfare, while the former (where we are) is a business street.

A New Binder for holding a year's numbers of the American Bee Journal, we propose to mail, postpaid, to every subscriber who sends us 15 cents. It is called "The Wood Binder," is patented, and is an entirely new and very simple arrangement. Full printed directions accompany each Binder. Every reader should get it, and preserve the copies of the Bee Journal as fast as they are received. They are invaluable for reference, and at the low price of the Binder you can afford to get it yearly.

If any one desires two of the Binders—one for 1895 and one for 1896—send 25 cents, and they will be mailed to you.

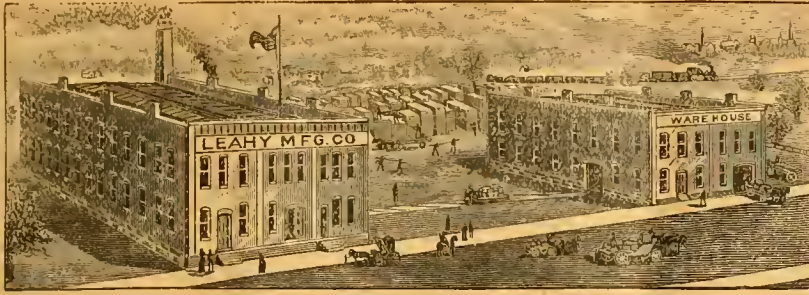

Largest Factory in the West COMPLETE STOCK. Good Supplies and Low Prices. Our Motto.

READ THIS—Mr. Keyes says: The 100 pounds of Extra-Tin Foundation you sent us is superior to anything he ever saw; and I think the same. R. L. TUCKER, Wewahitchka, Fla.
 Dear Sirs:—The Sections came duly to hand. Indeed, they are very nice. Yes, sir; they are as good as the best. CHARLES H. THIES, Steelville, Illinois.
 Leahy Mfg. Co.:—I have received the bill of goods. I must say they are the choicest lot of Hive-Stuff I have ever received from any place. I admire the smoothness of your work, and your close selection of lumber. Yours very truly. O. K. OLMSTEAD, Orleans, Nebr.
 Dear Sirs:—The Sections arrived in due time, and are all O. K. so far as examined. They are simply perfect. I can't see how you can furnish such goods at such low prices. I hope you may live long and do well. Yours respectfully. Z. S. WEAVER, Courtney, Tex.
 Gents:—I received the "Higginsville Smoker" all O. K. It's a dandy; please find enclosed stamps for another. Yours truly. OTTO ENDERS, Oswegatke, N. Y.
 Gentlemen:—I have bought Supplies from nearly all the large manufacturers by the carload, and I must say yours are as good as the best. indeed, in many lines they are the best. It is a pleasure to handle them. E. T. FLANAGAN, Belleville, Illinois.
 The above unsolicited testimonials are a fair sample of hundreds we receive. Our prices are reasonable and the "Higginsville Goods" are the best.
The "Higginsville" Goods are for sale by the following parties:
 Chas. H. Thies, Steelville, Ill. E. T. Flanagan, Belleville, Ill.
 Henry L. Miller, Topeka, Kans. E. A. Seeley, Bloomer, Arkansas.
 J. W. Rouse & Co., Mexico, Mo. P. J. Thomas, Fredonia, Kans.
 And by a number of others.
 If you need a Carload of Supplies, or only a Bee-Smoker, write to us. Remember, we are here to serve you, and will, if you give us a chance. **A Beautiful Catalogue Free.**
 Address, **LEAHY MANUFACTURING CO., HIGGINSVILLE, MO.**
 49A *Mention the American Bee Journal.*

Honey-Clovers & Buckwheat SEED FOR SALE.

We have made arrangements so that we can furnish seed of several of the Clovers and Japanese Buckwheat, by freight or express, at the following prices, cash with order:

	5lb	10lb	25lb	50lb
Alsike Clover	\$.80	\$1.35	\$3.50	\$ 6.25
Sweet Clover	1.10	1.80	4.25	8.00
White Clover	1.50	2.40	6.00	11.00
Alfalfa Clover	.75	1.20	3.00	5.25
Crimson Clover	.65	1.00	2.50	4.00
Jap. Buckwheat	.30	.45	1.00	1.50

Prices subject to market changes.
 The above prices include a good, new 25-cent two-bushel bag with each order. Add 25 cents to your order, for cartage, if wanted by freight.
 Your orders are solicited.
GEORGE W. YORK & CO.,
 CHICAGO, ILLS.



ONE MAN WITH THE UNION COMBINATION SAW
 Can do the work of four men using hand tools, in Rippling, Cutting-off, Mitring, Rabbeting, Grooving, Gaining, Dadoing, Edging-up, Jointing Stuff, etc. Full Line of Port and Hand Power Machinery Sold on Trial. Catalogue Free.
SENECA FALLS MFG. CO.,
 46 Water St., SENECA FALLS, N. Y.
 1A1y *Mention the American Bee Journal.*

SECTIONS

\$1.50 a M. 3 M, \$4.25.
 These ARE NOT Seconds, but perfect Sections. As they are not up to our present high standard, we wish to close them out. Sample free. Widths—7-to-foot, 1 15-16 in., and 2 in.
Catalog of Bees & Supplies FREE.
I. J. STRINGHAM,
 105 Park Place. NEW YORK, N. Y.

MOVED TO LARGER QUARTERS!

In order to take care of the business properly at this Branch, we have moved to **118 Michigan St., [3rd Floor]**, within two blocks of the Northwestern Passenger station, where we've secured larger quarters, making room for a **Full Assortment**. A carload of Goods is being put up at Medina for Stock here, and will be in the rooms here very soon. Send along your orders, remembering that we guarantee satisfaction, and at prices as low as the best quality of Goods can be furnished for. **Special Prices** on a lot of Stock we are closing out. Send for CATALOG and a List of Goods at Special Prices.
 In order to close them out quickly we offer some good Sections, for the next 30 days, or while they last, at these special prices:
 White Sections, 4 1/4 x 4 1/4.
 35,000 7-to-ft. at these low prices—1,000 for \$1.75; 2,000 for \$3.00; 5,000 for \$7.00
TRIANGULAR=TOP FRAMES.
 We also have a stock of Triangular Top Langstroth Frames at these Special prices:
 100 for \$1.00; 300, \$2.70; 500, \$4.00; 1000, \$7.00.
 On all freight orders of \$5 or less, at this Branch, please add 25c. for cartage. Catalogue Free.
The A. I. ROOT CO., 118 Michigan St., CHICAGO, ILL.
 Geo. W. York, Mgr. *Please mention the American Bee Journal.*

MUTH'S HONEY EXTRACTOR
 PERFECTION
 Cold-Blast Smokers,
 Square Glass Honey Jars, Etc.
 For Circulars, apply to CHAS. F. MUTH & SON, Cor. Freeman & Central Aves., Cincinnati, O. Send 10c for Practical Hints to Bee-Keepers.

A Bargain—EARLY QUEENS.
 119 Colonies Italian Bees in Chaff Hives: two acres land; good house; excellent well.
Early Queens—Tested, \$1.50; Untested, 75c.
E. L. CARRINGTON,
 11A4t P'ETTUS, Bee Co., TEX.

Question-Box.

In the multitude of counsellors there is safety.—Prov. 11-14.

Better Marketing of Honey.

Query 7.—Along the line of marketing the honey crop, what are the most needful requirements now, in order that producers may realize better financial results?—CALIF.

- Jas. A. Stone—I give it up.
- W. G. Larrabee—Higher prices.
- R. L. Taylor—Selling the honey crop in the home market.
- B. Taylor—To sell in your home market, direct to consumers.
- J. A. Green—Better quality, and better methods of marketing.
- Dr. C. C. Miller—Perhaps a better quality of extracted honey.
- H. D. Cutting—I don't know, unless it is a "change of Administration."
- Dr. J. P. H. Brown—Co-operation—in packing, in transportation, in selling.
- E. France—When we have honey we use barrels holding 360 pounds each.
- J. M. Hambaugh—Create an appetite for honey, by pushing sales in every home.

- Rev. M. Mahin—Have a good article, neatly put up, and sell at and near home.
- W. R. Graham—For the retail market, neatness is the first essential, small packages, all neat and new.
- Prof. A. J. Cook—Full co-operation among producers; I believe that, aided by our journals. This is practical.
- Mrs. L. Harrison—Cultivate their home market. Use honey in their families, in lieu of sugar syrups, as far as practicable.
- C. H. Dibbern—The best comb honey now appearing on the market is hard to improve on, but much that is offered is still put up in a careless, slovenly way.
- P. H. Elwood—A good knowledge of the honey-yield in the different sections of our country, together with a knowledge of the cost of producing honey, and co-operation in marketing.
- Emerson T. Abbott—Pluck, energy, push, keenness of perception, and a feeling that you are able to take care of yourself without any help from the law or your neighbors, provided you are *let alone*.

- Chas. Dadant & Son—Salesmen at home. You need some one who will talk to your neighbors and get them to eat honey. You have no idea, till you try, of the sales that can be effected by a live peddler.
- Mrs. J. N. Heater—If producers will counsel together instead of under-selling each other, then make consignments of carefully graded honey to honest dealers who are responsible, they can do much toward bettering said results.

Allen Pringle—"The most needful requirements" are: First, put nothing on the market but good, pure, ripe honey, cleanly and tidily put up; second, let every bee-keeper work up the home market for all it is worth, instead of shipping his honey off to some commission man; third, diminish the cost of

production by applying the highest science and the best art to the business, for this is tantamount to increasing the price.

Eugene Secor—Don't neglect the home market to send your honey to large cities. California honey is now selling in my local market at one cent less than my own. Who realizes the most profit from its production, myself or the other fellow?

J. E. Pond—I don't know anything in regard to this matter, as I don't produce any honey to sell. My idea is, however, that the requirements are: The best honey, in well-filled sections, carefully cleaned, and sent to the market in attractive form. If this won't sell honey nothing will.

G. M. Doolittle—Legislation in favor of the producers of wealth instead of trusts, combines, and monopolies. The trouble is not that the price of honey is too low, but that what we have to buy with our honey is too high, or out of proportion. Legislation is all in favor of the plutocrats or parasites, and against the producers of wealth.

G. W. Demaree—The most needed thing I know of is a great deal of energy to improve the "home market" for honey. As long as nearly all the honey is crowded into the city markets its price will decline. I have a friend who markets nearly his whole crop of honey from a spring wagon in the country and small villages, at a price from 30 to 50 per cent. above the quoted city markets.

Convention Notices.

TEXAS.—The Texas State Bee-Keepers' convention will be held on April 1 and 2, 1896. All bee-keepers are invited.
L. Blossom, Tex. W. H. WHITE, Sec.

UTAH.—The Utah Bee-Keepers' Association will hold their semi-annual meeting in Room 54, City and County Building, Salt Lake City, Apr. 6, 1896, at 10 a.m. All are invited. "In union is strength. By industry we thrive." Come, and bring your friends, and enjoy a good time. A full program in the interest of the industry will be presented. The Association needs your aid; then let every one do his full duty for our own interest and self-preservation.
GEO. E. DUDLEY, Sec.
Provo, Utah.

Ready Mixed Paints.—There was a time when people supposed that good paint could only be produced by the use of whitelead and oil. That argument is still driven with considerable force by many painters, because it is profitable for them to do so. The Ingersoll's Liquid Rubber Paints are much cheaper and are guaranteed to be the best and most durable that money will buy. These paints are free from the objections of "chalking" and will not scale or fade. They are sold largely all over the country. To all those wishing to inform themselves on this matter, we suggest that they correspond with O. W. Ingersoll, of the Patron's Paint Works, Brooklyn, N. Y., whose advertisement is on another page.

Bee-Keepers' Photograph.—We have now on hand a limited number of excellent photographs of prominent bee-keepers—a number of pictures on one card. The likeness of 49 of them are shown on one of the photographs, and 121 on the other. We will send them, postpaid, for 50 cents each, mailing from the 121 kind first; then after they are all gone, we will send the 49 kind. So those who order first will get the most "faces" for their money. Send orders to the Bee Journal office.



50c Trial Sets Of Choice Seeds, Plants and Fruits.

By mail postpaid, safe arrival and satisfaction guaranteed. Order by the letters and the numbers from this advertisement NOW, as these are introductory sets, not in catalogue, an **Elegant Annual of 168 pages**, which will be sent free with first order. If none of these sets suit you and you want anything in our line send for **CATALOGUE FREE**. About 60 pages devoted to **VEGETABLE and FLOWER SEEDS, 70 to PLANTS and the balance in the CREAM OF THE FRUITS**. Trees and plants in these sets are all thrifty and well rooted. Try them.

- Set J—10 elegant profuse blooming Roses, including one of the new famous **Crimson Rambler**. 50c
- " E—20 pkts choice **Vegetable Seeds**, 16 sorts and 1 pkt. of our new **Golden Hubbard Squash**. 50c
- " F—10 fragrant **Carnation Pinks**, 10 sorts, 50c
- " G—10 Prize **Chrysanthemums**, 10 sorts, 50c
- " H—4 superb **French Cannas**, 4 sorts, 50c
- " K—10 large flowered **Geraniums**, 10 sorts, 50c
- " L—30 fine **Gladioli**, all flowering bulbs, 50c
- " N—10 **Tuberose**s, 6 noble sorts all flowering, 50c
- " O—10 flowering plants all different, 50c
- " P—6 hardy **ornamental Shrubs**, 6 sorts, 50c
- " Q—6 hardy **Climbing Vines**, 6 sorts, 50c
- " U—2 elegant **Palms**, strong plants, 2 sorts, 50c

- FRUIT TREES, ETC. MAIL SIZE.**
- Set 103—8 **Peaches**, 4 sorts, 50c
 - " 104—8 **Apple**, 4 sorts, 50c
 - " 105—2 **Pear**, 2 sorts, 2 **Cherry**, 2 sorts, 50c
 - " 106—4 **Grapes**, 3 sorts, 50c
 - " 107—10 **Grapes**, all Concord, 50c
 - " 108—4 **Gooseberries**, 4 sorts, 50c
 - " 109—10 **Currants**, 3 sorts, 50c
 - " 110—30 **Raspberries**, 5 sorts, 50c
 - " 111—50 **Strawberries**, 5 sorts, 50c

One-half each of any two sets 50c., any 3 sets \$1.25, 5 sets \$2.00.
Everything of the best for **LAWN, CONSERVATORY, PARK, ORCHARD, VINEYARD and GARDEN.**
42nd YEAR. 1000 ACRES. 29 GREENHOUSES.

THE STORRS & HARRISON CO., Box 219 Painesville, O.

St. Joe

Is the name of the Hive you want. **PRICE-LIST** now ready. Send stamp and get valuable paper on **WINTERING BEES.**

GOLDEN WYANDOTTE Eggs from fine birds only \$1.00 for 13.

EMERSON T. ABBOTT, St. Joseph, Mo.

WOVEN WIRE FENCE
Over 50 Styles
The best on Earth. Horse high. Built strong. Pig and Chicken tight. You can make from 40 to 60 rods per day for from 14 to 22c. a Rod. Illustrated Catalogue Free. **KITSELMAN BROS.,** Ridgeville, - Indiana.

48Etf Mention the American Bee Journal.

STRAWBERRY PLANTS FOR SALE.

Michigan Grown Plants are the Best.

BUBACH, PARKER EARLE, HAVERLAND, WARFIELD and JESSIE.

Vigorous Plants of the above well-known varieties, shipped direct from the Nursery—Lake View Fruit Farm, Gibson, Mich., 100, \$1.00; 200, \$1.50, postage paid. Special price on large quantities. Address.

CHAS. N. TRIVESS, Manager, 635 Chicago Stock Exchange, - CHICAGO, ILL.

6E4t Mention the American Bee Journal.

WANTED—By a young man (23) a position in a good apilary, or apilary and small fruit or gardening business combined, preferably South and near this State, for the coming season. Has already had good experience with bees, and is willing, serviceable, and active. Would appreciate a good home and a generous employer. Is an experienced clerk, with good references. Address.

6E4t C. C. DOORLY, Alphin, Va.

Bees, Queens, Nuclei—We will sell, the coming season, 500 Two-Frame Nuclei, with a Choice Warranted Queen, at \$2.50 each. Special prices on large orders furnished. **LEININGER BROS.,** FT. JENNINGS, OHIO.

6Etf

Cheap for Cash—ITALIAN BEES

In 10-frame (size 9 1/4 x 17 1/2) hive, \$4. Italian Queens, \$1.50. Address.

OTTO KLEINOW, 122 Military Avenue, DETROIT, MICH.
12E3t Please mention the Bee Journal.

HATCH Chickens by STEAM With the **MODEL EXCELSIOR Incubator**
Simple, Perfect, Self-Regulating. Thousands in successful operation. Lowest priced First-class Hatchery made. **G. O. R. STABLE,** 114 to 122 S. 6th St. Quincy, Ill.

INCUBATORS
Our 160 page, finely illustrated Combined Poultry Guide and Catalogue will tell you what you wish to know about **PROFITS IN POULTRY**. We manufacture a complete line of Incubators, Brooders and Poultry Appliances. Guide and Catalogue 10c. (stamps or silver) Worth one Dollar. **Reliable Incubator & Brooder Co., Quincy, Ill.**
38E15t Please mention this Journal.

The Rural Kansan

Is an Agricultural Journal for the busy farmer. It embraces Bee-Keeping and every department of industry connected with the farm. 30 cts. a year, monthly. Sample Free.

A Full **Higginsville Bee-Supplies** on Line of **CATALOGUE FREE.**

HENRY L. MILLER, 355 Shawnee Ave., TOPEKA, KAN.

1A13t Mention the American Bee Journal.

NEW MAMMOTH POULTRY GUIDE showing colored plate of chickens in natural colors. Finest book ever published. Almost 100 pages. Tells all about Poultry for Profit or Pleasure. Price only 15c. **JOHN BAUSCHER, JR.,** Box 94 Freeport, Ills.
12A7t Mention the American Bee Journal.

FLOWER SEEDS
SURPRISE COLLECTION
SPECIAL OFFER
Made to secure 500,000 new customers. **8 PKGS.** Seeds sure to grow and blossom. Note Postpaid for..... **10 cts.** the varieties:—Pansy 50 colors, Phlox 20 varieties, Pink 15 finest shades, Petunia 12 latest colors, Balsam 10 grand sorts, Pony 10 elegant shades, Mignonette, sweet, very fragrant, and Everblooming Sweet Alyssum.
E. U. Kimbark, Evanston, Ill., writes: "It is a pleasure to plant Buckbee's Seeds—they always grow." * * * * * Add three cents extra to cover postage and receive New Instructive and Beautiful Seed and Plant Book.
H. W. BUCKBEE, P. O. Box No 537, **Rockford Seed Farms, ROCKFORD, ILL.**
Mention the American Bee Journal.

BUY "DIRECT FROM FACTORY," BEST MIXED PAINTS

At WHOLESALE PRICES, Delivered FREE For Houses, Barns, Roofs, all colors, and SAV'Y Dealers profits, in use 54 years. Endorsed by Grange & Farmers' Alliance. Low prices will surprise you. Write for Samples. O. W. INGERSOLL, 289 Plymouth St., Brooklyn, N. Y.

Mention the American Bee Journal.

KAFFIR CORN The new drought-resisting wonder; yields 60 to 80 bushels to the acre. Better than corn for stock and poultry. Will grow anywhere. Raise your own seed. Write for information and prices. Sample "Genuine Fox Brand," plenty to plant 2000 sqr ft., with directions, for nine 2-ct. stamps. SHERMAN & WHITE, 655 Otto Street, CHICAGO, ILL.

WHEN ANSWERING THIS ADVERTISEMENT, MENTION THIS JOURNAL.

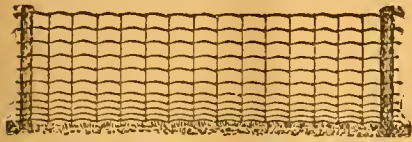

TURKEYS BY THE ACRE

The February Hustler gives a view of a five acre Turkey Park, Fenced with Page, from which over two thousand fine birds were shipped last fall. Send for free copy.

PAGE WOVEN WIRE FENCE CO., Adrian, Mich. WHEN ANSWERING THIS ADVERTISEMENT, MENTION THIS JOURNAL.

Better than 10% Discount!

By comparing the following with the customary prices of Foundation they will be found to be better than a 10% discount. Prices are f. o. b., cut to any size.

COMB FOUNDATION.

Table with 4 columns: Weight (1lb, 5lb, 10lb, 25lb) and Price (Heavy or Medium, Light, Thin, Extra Thin).

Samples Free. Watch this advertisement for changes. Better buy now, before prices advance. BEESWAX—30c cash, 32c trade, delivered. HIVES, SECTIONS, SMOKERS, ETC., always in stock. PRICES are right. Order before the rush. W. J. FINCH, Jr., 11A St. SPRINGFIELD, ILLS.

Mention the American Bee Journal.

Advertisement for a Successful Incubator, featuring an illustration of the device and text describing its features and availability.

11A St. Mention the American Bee Journal.

California

If you care to know of its Fruits, Flowers Climate or Resources, send for a Sample Copy of California's Favorite Paper—

The Pacific Rural Press

The leading Horticultural and Agricultural paper of the Pacific Coast. Published weekly, handsomely illustrated, \$2.00 per annum. Sample Copy Free.

PACIFIC RURAL PRESS, 220 Market St., - SAN FRANCISCO, CAL.



E. KRETCHMER, RED OAK, IOWA. Mention the American Bee Journal. 12E8t

General Items.

A North Dakota Report.

The season of 1895 was not as good for honey as the year before. We had very little if any basswood bloom, our white clover killed out considerable a year ago this winter, and we did not have as good a fall flow of honey as then. I went into winter quarters a year ago last fall with 5 colonies, came through with 4, bought 2 more last spring, and went into winter quarters this winter (in the cellar) with 23 colonies. I run for increase of stock instead of honey, and took off something over 150 pounds of extracted honey, and two supers of comb honey. I had several colonies rather light for winter, but all are alive yet, and if they go through whole, I shall think that I have pretty nearly solved the wintering problem, and will probably give another statement sometime. Fargo, N. Dak., Feb. 6. J. B. JUDD.

The "Dovetailed" Corner Again.

I desire to make a correction of some errors made by the manufacturers of apiarian supplies in calling part of their goods by the wrong name, in the method they use in putting them together. Expert foremen and skilled mechanics use four principal methods in putting two pieces of dressed lumber together to form a corner at right angles, viz.: 1st, Rabbeted corner; 2nd, Mitered corner; 3rd, Interwoven-Tenon corner; and 4th, Dovetailed corner. Methods 1st, 2nd and 3rd depend entirely upon the nails to hold the corner together, while method No. 4 will hold itself together by the use of a little glue, or a few small nails to hold the dovetail in place. The strongest and best of the four, different plans is the dovetailed corner, and part of the manufacturers of hives and sections put much stress on the word "dovetail," and call their hives and sections "dovetailed" hives and dovetailed sections, whereas, the way they are now putting them together there is no dovetail about them.

I now suggest that the manufacturers of hives and sections drop the word "dovetail," and use in its place "interwoven-tenon" hives, and interwoven-tenon sections, or block-cornered hives and block-cornered sections. By doing so it will save being smiled at by men that understand the different methods and names used in putting two pieces of dressed plank together to form a corner at right angles. Clintonville, Ohio. T. H. COE.

[This is a matter that has been mentioned many times in print and elsewhere, but as all have come to use the word "dovetail" in connection with hives and sections, and thoroughly understand it, it would seem hardly necessary to make the effort to change to what would undoubtedly be a little more correct. There are many misnomers in the world, but they have come to be so well understood that to endeavor to correct them would be almost a hopeless task.—EDITORS.]

From "Mountain View Apiary."

MR. EDITOR:—I am not qualified to give instruction in bee-lore, and if I were, the galaxy of writers whose articles fill your columns would certainly make it unnecessary for me to do so. But I sometimes see under the heading, "General Items," letters that while they contain no instruction, are very interesting—they in a sense gather the family of "bee-people" nearer together, and as bees flourish best in the cluster, when it is cold, so perhaps may the bee-masters.

With this thought as a motive, I send a brief description of our plantation. We

Advertisement for Successful Fruit Growers, featuring Deming Spray Pumps and contact information for The Deming Co.

Advertisement for The Patent Wood-Veneer Foundation, offering wax and supplies for beekeepers.

Advertisement for Comb Foundation Wholesale and Retail, listing various hive components and prices.

Advertisement for Patent Wired Comb Foundation, highlighting its benefits and manufacturer information.

\$3.00 Worth for \$2.00!

Until further notice, we propose to give you a chance to get some good reading-matter for the long winter evenings, at half price.

Send us \$2.00, and we will mail you your choice of \$3.00 worth of the following booklets, and also credit your subscription to the American Bee Journal for one year:

- List of booklets for sale at half price, including titles like 'Poultry for Market and Profit', 'Our Poultry Doctor', etc.

GEORGE W. YORK & CO., CHICAGO, ILLS.

Advertisement for Walter S. Powder, featuring a product image and text about promptness in shipping.

The Hive I Use, by G. M. Doolittle. It details his management of bees, and his methods for the production of honey. Price, 5 cents

**Willow-Herb, White Sage, Basswood
EXTRACTED HONEY**

—For Sale.—

We have made arrangements whereby we furnish **Willow-Herb or White Sage Extracted Honey**, in 60-pound tin cans, on board cars in Chicago, at these prices: 1 can, in a case, 8 cents per pound; 2 cans in one case, 7½ cents.

The Basswood Honey is all in kegs holding 170 pounds, net. It is a very superior quality, and the prices are: 1 keg, 8½ cents per pound; 2 kegs or more, 8 cents. Cash must accompany each order.

A sample of either kind of honey will be mailed to an intending purchaser, for 10 cents, to cover postage, packing, etc. We guarantee purity, and that what we ship will be equal to sample.

GEORGE W. YORK & CO.,
CHICAGO, ILLS.

**IF YOU WANT THE
BEE-BOOK**

That covers the whole Apicultural Field more completely than any other published, send \$1.25 to Prof. A. J. Cook, Claremont, Calif., for his

Bee-Keeper's Guide.

Liberal Discounts to the Trade.

OUR POULTRY ANNUAL and Book of Valuable Recipes, 64 large pages, contains 8 beautiful colored plates of fowls, gives description and prices of 45 varieties, with important hints on care of poultry, and pages of recipes of great value to everyone. Finest Poultry Book published for 1896. Postpaid only 10 cts. **C. N. Bowers, Box 24, Dakota, Ill.**

52A13 *Mention the American Bee Journal.*

TAKE NOTICE!

BEFORE placing your orders for SUPPLIES, write for prices on 1-Piece Basswood Sections, Bee-Hives, Shipping-Crates, Frames, Foundation, Smokers, etc.

PAGE & LYON MFG. CO.
NEW LONDON, WIS.

1896 SAVE MONEY 1896

If you want first-class **ITALIAN QUEENS** FOR BUSINESS, Foundation at Wholesale Prices, Hives, suited for the South, or SUPPLIES, send for Price-List—to

J. P. H. BROWN, AUGUSTA, GA.
Mention the American Bee Journal.

CARLOADS



Of Bee-Hives, Sections, Shipping-Cases, Comb Foundation, and **Everything** used in the Bee-Industry.

I want the name and address of every Bee-Keeper in **America**. No reason why you cannot do business with me. I have Cheap Lumber and Experienced Workmen; a good Water-Power Factory and know how to run it. I am supplying Dealers as well as consumers. Why not you? Send for Catalogues, Quotations, etc. **W. H. PUTNAM, 1E RIVER FALLS, Pierce Co., Wis.**

Mention the American Bee Journal.

BEGINNERS.

Beginners should have a copy of the Amateur Bee-Keeper, a 70-page book by Prof. J. W. Rouse. Price 25 cents; if sent by mail, 28c. The little book and the Progressive Bee-Keeper (a live, progressive 28-page monthly journal) one year, 65c. Address any first-class dealer, or

LEAHY MFG. CO., Higginsville, Mo.
Mention the American Bee Journal.

(Andrews & Weeks) call our place, "Mountain View Apiary." We are situated on a tableland about 1,000 feet above the Santa Ana river, commanding a view of the river and its valley, the valleys and mountains beyond, that delights the eyes of all beholders. We have two out-apiaries—one up the the river two miles, the other down four miles—all three face the river, and are backed by lofty and almost inaccessible mountains.

One year ago we had about 300 colonies distributed among the three apiaries, but almost all of them were weak, and out of spirits on account of the very discouraging conditions of the previous year. We sold 48,000 pounds of honey of a high grade, and held over 4,000 pounds as capital for a bad season, should there be one.

On Feb. 1 we had about 190 colonies in the home apiary, and 180 and 90 respectively in the out-apiaries; every colony in a prosperous condition, each having stores enough on hand to take it through an Eastern winter.

In November, 1895, we put all down into a single story, except about 50, that were too populous to be crowded into a house of one room, but now many of them are storing new honey so fast, and filling the brood-chamber so rapidly, that we expect by March 1, or sooner, to commence putting on the supers again. So if Nature is kind to us, furnishing the requisite amount of moisture, we expect to have some honey to place upon the market early in the season. Up to this date, however, we have had about two inches of rain, and are waiting for the other 15 or 16 with what patience and resignation we can command, but in the meantime we are not taking any orders, and if the near future does not develop considerable moisture, I fear we shall have bees to sell instead of honey.

The flora of this locality is all that the most fastidious bee, or sanguine bee-master, could desire; but in this land of everlasting sunshine, it often fails to materialize, on account of too much sunshine and too little dampness.

We are delighted to see that Rambler has commenced a series in the American Bee Journal. While I would not even intimate that our Bee Journal can be improved, but certainly among the other good things found in its columns Rambler's can come in on the principle that we cannot have too much of that which is good.

Orange, Calif., Feb. 2. G. W. WEEKS.

Don't Eat in Winter Confinement.

I asked for a test of this question, and a report of same through the columns of the Bee Journal some two months ago, and yet see no reply.

After receiving the offer of such a valuable premium from Mr. Heise, on page 718 (1895), I then set in with great eagerness for the prize, and on Nov. 10 I selected a colony on the summer stands, and weighed it carefully. It weighed just 50 pounds. Being a box-hive I fixed it so I could weigh it handily with a pair of true 50 pound scales. I have weighed that hive some 12 times in the last two months—it is just two months to-day since I commenced the test—and in that time my bees have had four fights, and to-day they weigh just 48 pounds. I weighed each time when I saw that they were going to have a fight, and in the evening after fight, and found, to my satisfaction, that all that was lost was in the fight, with and by the so-called "dysentery."

Now I say, if two months holds good and proves that bees do not eat in close winter confinement, why won't three or four months do the same? It will, and if Mr. Heise will watch his bees, he will find out to his satisfaction that the 25 to 30 pounds of honey that each of his colonies makes away with, is during the warm days in the spring, long before there is any bloom to gather honey from. This is my particular time to give my bees attention, and to feed, if I see they need it.

I have never lost but few bees in winter—I never think of wintering them except on

The Bee-Keeper's Guide:
Or Manual of the Apiary,

BY PROF. A. J. COOK.

This 15th and latest edition of Prof. Cook's magnificent book of 460 pages, in neat and substantial cloth binding, we propose to give away to our present subscribers, for the work of getting new subscribers for the American Bee Journal.

A description of the book here is quite unnecessary—it is simply the most complete scientific and practical bee-book published to-day. Fully illustrated, and all written in the most fascinating style. The author is also too well-known to the whole bee-world to require any introduction. No bee-keeper is fully equipped, or his library complete, without "THE BEE-KEEPER'S GUIDE."

For Two New Subscribers and Your Own Renewal.

Send us Two New Subscribers to the Bee Journal and your own renewal (with \$3.00), and we will mail you a copy of Prof. Cook's book FREE as a premium, and also a copy of the 160-page "Bees and Honey" to each New Subscriber. Prof. Cook's book alone is \$1.25, or we club it with the Bee Journal for a year—both together for only \$1.75. But surely anybody can get only 2 new subscribers to the Bee Journal for a year, and thus get the book as a premium. Let everybody try for it. Will you have one?

TEXAS QUEENS.

If you are in need of Queens, let me have your order. Price-List Free.

8A26t **J. D. GIVENS, Lisbon, Tex.**
Mention the American Bee Journal.

WHITE FACED BLACK SPANISH POULTRY

40 Standard Breeds Illustrated & fully described in my new Poultry Book. Reliable information for poultrymen & intending buyers. Good stock Ducks & Geese; also Shetland Ponies. Send 6c in stamps **E. H. COOK, Box 27, Huntley, Ill.**

Mention the American Bee Journal. 4A13t

ORIGINAL BINGHAM SMOKERS

Wonderful Record!

HAVE LASTED 17 YEARS.

—BEST ON EARTH.

Always Give Perfect Satisfaction.

My cool Wire Handle and Bent Nose were patented 1892, are the original, my best invention since my open or direct draft Patent, 1878, that revolutionized Bee-Smokers. My Handle and Nose Patent bent all the other smoker noses. None but Bingham Smokers have all the best improvements. If you buy genuine Bingham Smokers and Honey-Knives you will never regret it. The "Doctor," ¼-inch larger than any other smoker on the market—¾-inch stove, by mail, \$1.50

Conqueror, 3"	1.10
Large, 3½-in. "	1.00
Plain, 3-in. "	.70
Little Wonder, 2-in., wt. 10 oz.	.60

Bingham & Hetherington Honey-Knives, 80 cents.

T. F. BINGHAM, Farwell, Mich.
7A1f *Mention the Bee Journal.*

READERS of this Journal who write to any of our advertisers, either in ordering, or asking about the Goods offered, will please state that they saw the Advertisement in this paper.

the summer stands, and giving them the proper attention at the proper time, and I doubt very much if there is any other plan that will beat it. It seems that is their nature, has been their habit, and they do winter successfully in the timber high up in a tree, often with a large hole below, but they see well to closing all air-spaces above them.

As I have said before, my experience is self-experience, as the saying is. It cost me nothing, still I value it highly. I like the Bee Journal, and don't think I could do without it. Now, in conclusion, I will say to Mr. Heise: Come over and bring the pig-tail with you, but divide the red apple between yourself and your children; keep the two pieces of chalk to write upon the wall that bees do not eat while confined in winter quarters. ANDREW COTTON.
Pollock, Mo.

Extracting-Combs and Tar Paper.

I have been requested to say whether extracting-combs protected from moths with tar paper by the method I described on page 113, would cause the first honey extracted from them to taste of tar; and if the bees will work as well in such combs. I think the bees would work in them just as well, but I believe the first extracting from such combs would taste of the tar, although I cannot say from actual experience, for while some years I produce a good deal of extracted honey, I have never had any extracting-combs to preserve, for I only extract unfinished sections, and from the brood-nests in the fall, and in the latter case the combs are returned to the bees, and they are fed sugar syrup with which to fill them up again for winter stores.

C. DAVENPORT.

Southern Minnesota.

"Only a Cold."

I'm just off the skirmish line of what portended a serious case of pneumonia. And you need waste no sympathies on a person who knows so well the certain tendencies of lung fever, and is so careless regarding precautions for its prevention, or even proper care when the symptoms are strong upon him. No; I say that a person who knows better, and is heedless of consequences, deserves a lesson—and I've just had a good one! It's the same old story with which we tickle our big conceits—"only a cold." Yes, that's it. And "colds" are just the accidents that more often bring us into close relations with the undertaker. Then, too, it is not always possible to determine where the results of lung fever are going to end. Certainly, one's lungs are never again so strong as before the attack, and often enough it lays broad foundations for consumption.

The wise will take timely care of a "cold."
DR. PEIRO.
100 State St., Chicago, Ill.

Wintering Bees—Selling Honey.

January 24 being a beautiful, springlike day, I went into the apiary, and seeing the entrances of some of the hives indicated a lack of scavengers, I thought I would turn in and help, so I got two bottom-boards (as I have two sizes of hives, the double and single walled). I took a camp stool and set it just back of the hive, puffed a little smoke in if the bees were cross, put the hive on the stool, and the extra bottom-board where the hive was, lifted the hive off its bottom-board and put it on the new one, then cleaned off the bees and cappings from the other, and used it in like manner for the next, and so on throughout the yard.

In some hives you will find over a pint, others not over a dozen bees; at the same time you can determine the condition of each hive. Some of mine were apparently as heavy as in the fall, while some were very light, but on opening the lightest I was surprised to find ample stores to last until spring; then if it is cold and wet I

will put on the supers and feed them with the unfinished sections that I saved for that purpose, if they need it. They are unprotected on the summer stands, with sealed covers, that is, if they wished to seal them, but I find some colonies have not theirs sealed, which gives ample upper ventilation, I think, to satisfy the greatest stickler for that hobby.

Our honey crop here was very short, only 200 pounds from 64 colonies—on account of drouth and a forest fire, which burned everything green.

I sell finished sections, regardless of color, for 25 cents retail, 20 cents wholesale; extracted 15 cents per pound, and in 3/4-pound bottles for 15 cents, 1/2-pounds, 10 cents; in Mason jars, 50 cents. How is that for a home market? The very thought of a commission dealer makes me tired. I sell my honey, or I keep it, and would if I had tons of it. No, no commission in mine, if you please. I would not insult the bees by selling their hard earnings for 3 cents per pound by the barrel. When it comes to selling it at 3, 4 or 5 cents per pound, I would convert it into vinegar or wine, or whatever you choose to call the product, and get at the rate of 16 cents per pound in that way. I know I am poor, but I allow no man to rob me on the commission plan, not if I know it. J. E. PRICHARD.

Port Norris, N. J., Jan. 27.

Honey & Beeswax Market Quotations.

CHICAGO, ILL., Mar. 13.—White clover and basswood comb is sought after in preference to any other, and commands a better price and now sells at 15c. for clover and 13@14c. for basswood. Other white comb honey sells at 11@12c.; dark, 8@9c. amber, 9@10c., and very slow of sale. Extracted is unusually dull, with large amounts on sale. White clover and Linden, 6@7c.; dark and amber grades, 4 1/2@5c.
Beeswax, 28@30c. R. A. B. & Co.

PHILADELPHIA, PA., Mar. 6.—Honey has been selling freely, there being considerable call for comb honey, and the war in Cuba has made extracted honey sell to the baking trade who previously used Cuba honey. We quote: Fancy comb, 15c.; fair to good, 11@13c.; fair, 9c. Extracted, 4 1/2@5 1/2c.; pure white clover, 10c. Beeswax, 30c. W. A. S.

NEW YORK, N. Y., Feb. 24.—Market quiet. White comb in fair demand at 11@14c. Very little demand for buckwheat comb at 8@9c. Extracted selling fairly well, principally California, at 5 1/2@5 3/4c., and some buckwheat moving at 4@4 1/4c.; Southern, 50@55c. per gallon; white clover and basswood, 5 1/2@6c.
Beeswax unchanged. H. B. & S.

CINCINNATI, O., Mar. 7.—Demand is fair for choice comb honey, at 12@14c. in a jobbing way. Extracted is slow at 4@7c.
Beeswax is in good demand at 25@30c. for good to choice yellow. C. F. M. & S.

KANSAS CITY, MO., Mar. 8.—The demand for comb and extracted is fair. We quote: No. 1 white, 1-lb., 13@14c.; No. 2, 11@12c.; No. 1 amber, 10@11c.; No. 2, 8@10c. Extracted, white, 5 1/2@6c.; amber, 5@5 1/2c.
Beeswax, 20@25c. C. C. C. & Co.

List of Honey and Beeswax Dealers.

Most of whom Quote in this Journal.

Chicago, Ills.

R. A. BURNETT & Co., 163 South Water Street.

New York, N. Y.

HILDRETH BROS. & SEIGELKEN,
120 & 122 West Broadway.
CHAS. ISRAEL & BROS., 486 Canal St.

Kansas City, Mo.

C. C. CLEMOMS & Co., 423 Walnut St.

Buffalo, N. Y.

BATTERSON & Co., 167 & 169 Scott St.

Hamilton, Ills.

CHAS. DADANT & SON.

Philadelphia, Pa.

WM. A. SELSER, 10 Vine St.

Cincinnati, Ohio.

C. F. MUTH & SON, cor. Freeman & Central avs.

PERSONAL MENTION.

HON. J. M. HAMBAUGH, of Southern California, wrote us as follows, March 4: "We have had uncomfortable weather the last three days, but just what we have been praying for, viz.: RAIN—about 2 1/4 inches having fallen the last 36 hours. But it is cold and windy. There is lots of snow on the mountains. These rains insure a honey crop for 1896."

DR. MILLER AND FAMILY have all been suffering from severe attacks of Mr. Grippe. We could sympathize with them exactly, for we had a tussle with the fellow, ourselves, and know just how he tries to "down" his victims. At last accounts, all our Marengo friends were "on the improve." Good for them. Hope they'll come off victorious.

EDITOR HUTCHINSON is giving his readers a whole lot of "Pringleism" nowadays, *via* hygienic living. Wonder why he doesn't make that a "special topic." Surely, 'tis of sufficient importance. Mr. Pringle seems to know how to get well and keep well. But if all followed Mr. P.'s good advice, what would become of all the M. D.'s? Probably they'd have to do like editors—look out for themselves.

MR. E. B. WEED, the inventor of the new-process foundation, made us a very short but pleasant call last week. He was on his way to the Dadants, to set up machinery built by The A. I. Root Co., for making the new-process foundation. We understand that Mr. Weed has one or more inventions that promise to make some big strides in freedom. Of course this "Weed" is not the ordinary, useless kind, but a valuable species, and will doubtless impress his worth upon the industry of apiculture in a lasting and beneficial way.

GEO. W. BRODBECK, of Los Angeles, Calif., wrote thus on Mar. 3: "Unheralded and unbeckoning to the weather prophet, it began raining this morning, and should we at this late day be so fortunate as to have much rain, we Californians will be very happy, indeed, for such an incident has not happened in this country since 1884, when, during the month of March, there was a precipitation of over 17 inches, resulting in an unusually good honey-year. We'll hold our breath now until we see what this month brings for us in 1896."

Catalogs for 1896.—We have received the following Catalogs, Price-Lists, etc., a copy of which may be obtained upon application, always being careful to say you saw their advertisement in the American Bee Journal:

Gus Dittmer, Augusta, Wis.—Comb Foundation and Bee-Keepers' Supplies.

E. H. Cook, Huntley, Ill.—Silverwood Poultry and Stock Farm.

I. J. Stringham, 105 Park Place, New York, N. Y.—Apianian Supplies, Bees and Queens.

HONEY We have a large amount of Pure No. 1 Alfalfa we will sell cheap.

SEED Of those great honey-producing plants —Alfalfa and Cleome or Rocky Mountain Honey-Plant. Alfalfa seed at 7 cts. a lb.

Boss bee-escape Warranted the best, simplest and quickest Escape on the market. Sent postpaid to any address for 50 cts. It can be returned at our expense if it is not as represented, or we will send the Escape on trial to any bee-keeper wishing to test it in good faith. We are agents for the

Ferguson Patent Hive with double-case Super and Wicket-Gate Honey-Board, with the Escape. It is the easiest, quickest hive to handle for the production of comb honey. Address,

E. S. LOVESY & CO.,
355 6th East St., SALT LAKE CITY, UTAH.
Insertion in the American Bee Journal. 9Atf

Bottom Prices

**BRING US BIG TRADE.
GOOD GOODS KEEP IT.**

If you want the best supplies that can be made at a little less cost than you can buy the same goods for elsewhere, write to us for low prices. 1896 Catalogue now ready—ask for it and a free copy of **The American Bee-Keeper** (36 pages).

Address,
THE W. T. FALCONER MFG. CO.,
JAMESTOWN, N. Y.
Mention the American Bee Journal.

ROOTS GOODS A great reduction in Prices on Hives and Sections. Other bargains in Apianian Supplies. State what you need and we will give you low prices. 36-p. Catalogue Free.
JNO. NEBEL & SON, High Hill, Mo.
Mention the American Bee Journal. 4A26t

Queen-Clipping Device.

I want the address of all who clip Queens and have even the least trouble either in catching or holding them while they are being clipped. I have invented a Device by which it is impossible to injure a Queen either in catching or clipping, unless it is done purposely. With it they are caught and clipped any way desired almost instantly. One does not have to touch the Queen with his hands, whatever. Price, postpaid, 50 cts. Send for Free Circular. **C. MONETTE,**
6Atf CHATFIELD, Fillmore Co., MINN.
Mention the American Bee Journal.

I ARISE



TO SAY to the readers of the **BEE JOURNAL** that **DOOLITTLE**

has concluded to sell **BEEES and QUEENS**—in their season, during 1896, at the following prices:

- One Colony of Italianas on 9 Gallip frames, in light shipping-box \$6.00
- Five Coloniae..... 25.00
- Ten Coloniae..... 45.00
- 1 untested queen. 1.00
- 6 " " Queens 5.50
- 12 " " " " 10.00
- 1 tested Queen... \$1.50
- 8 " " Queens. 3.50
- 1 selected tested queen 2.00
- 8 " " " Queens 4.00

Select tested queen, previous season's rearing 4.00
Extra Selected for breeding, THE VERY BEST. 5.00
About a Pound of BEEES in a Two-frame Nucleus, with any Queen, \$2.00 extra.

Free Circular free, giving full particulars regarding the Bees and each class of Queens.
Address

G. M. DOOLITTLE,
12A25t BORODINO, Onon. Co., N. Y.
Mention the American Bee Journal!

BEEES QUEENS
Smokers, Sections, Comb Foundation, and all Apianian Supplies cheap. Send for FREE catalogue. **E. T. FLANAGAN, Belleville, Ill.**
6A26t Please mention the Bee Journal.

Fruit Plants

Where to buy them at wholesale price. Send postal for descriptive and wholesale Catalogue of all of the leading varieties of the **Strawberries, Raspberries, Blackberries, Currants, Gooseberries, Grapes and Potatoes.**
EZRA G. SMITH, Manchester, Ont. Co., N. Y.
8Atf Please mention the Bee Journal.

CASH PAID FOR BEESWAX

For all the **good, pure yellow BEESWAX** delivered to our office till further notice, we will pay 26 cents per pound, cash; or 30 cents for whatever part is exchanged for the Bee Journal, Honey, Books or Seed, that we offer. If you want **cash promptly** for wax, send it on at once. Dark or impure wax not taken at any price. Address plainly,

George W. York & Co., 118 Michigan St., Chicago, Ill.

MY CATALOGUE IS FULL of valuable information about Trees and Plants All the Standard and NEW VARIETIES.
Send for Catalogue. **IT IS FREE.** PLEASANT VALLEY NURSERIES, Arthur J. Collins, MOORESTOWN, N. J.

19th Year Dadant's Foundation 19th Year

Is still in the lead, for we use all the latest improvements, including the **NEW PROCESS**, and still make the best goods. Remember that we do not use any acid to purify our beeswax, and that is why our Foundation preserves the smell of the honey and is more acceptable to the bees, than any other. It is kept for sale by

T. H. Strickler, Solomon City, Kansas.
G. K. Hubbard, Fort Wayne, Ind.
L. Hansaen, Davenport, Iowa.
C. Theilmann, Theilmanton, Minn.
E. C. Eaglesfield, Berlin, Wis.
E. T. Abbott, St. Joseph, Mo.
J. M. Jenkins, Wetumpka, Alabama
John Rey, East Saginaw, Mich.
Vickery Bros., Evansville, Ind.

The Jennie Atchley Company, Beeville, Texas.
C. F. Muth & Son, Cincinnati, Ohio
E. Kretzmer, Red Oak, Iowa.
Jos. Nyswander, Des Moines, Iowa.
G. B. Lewis Co., Watertown, Wis.
James Reynolds Elevator Co., Poughkeepsie, N. Y.
Louisiana Bee-Keepers' Supply Manufactory, Donaldsonville, La.
Page & Lyon, New London, Wis.

and many other Dealers. All agree in saying that no goods are better than ours.

Those of our customers who formerly bought through Thos. G. Newman can get our Foundation in **Chicago, Ill.**, by addressing us at **118 Michigan Street**. We keep no other goods there.

We make a specialty of **Veils and Veil Stuffs** of best quality, cotton and silk.

Langstroth on the Honey-Bee, Revised.

Bee-Keepers' Supplies, Smokers, Sections, Tin Pails, etc.
Samples of Foundation and Tulle FREE with Circular. Instructions to beginners with Circular. **BEESWAX WANTED.** Send us your address.

CHAS. DADANT & SON,
Mention the American Bee Journal. HAMILTON, Hancock Co., ILL.

SECTIONS, BEE-HIVES, SHIPPING-CASES

We make a Specialty of these Goods, and defy Competition in **QUALITY, WORKMANSHIP AND PRICES.**
Write for Free Illustrated Catalogue and Price-List.

G. B. LEWIS COMPANY, Watertown, Wis.

Be sure to mention the American Bee Journal when you write.

**BEAUTIFUL
Transparent
TOUGH
and yet
PLIABLE.**

**REDUCED
PRICES**

NEW-PROCESS WEED FOUNDATION —DELIGHTS ALL—

RECENT COMPARATIVE TESTS IN FLORIDA show that the old-process dipped wax will sag or stretch in the hive nearly five times as much as that by the new Weed process.

Our New Sanded and Polished Sections and Bee-hive Material are the Finest Product that money and machinery can turn out. **CATALOG FREE.**

THE A. I. ROOT CO., MEDINA, OHIO.

118 Michigan St., Chicago, Ill. Syracuse, N. Y.
1024 Mississippi St., St. Paul, Minn.

AMERICAN BEE JOURNAL

ESTABLISHED 1861
THE OLDEST BEE-PAPER IN AMERICA

DEVOTED EXCLUSIVELY
TO THE INTERESTS
OF HONEY-PRODUCERS

Published Weekly, at \$1.00 per annum.

Sample Copy sent on Application.

36th Year.

CHICAGO, ILL., MARCH 26, 1896.

No. 13.



Something About Beginning The Season.

BY G. M. DOOLITTLE.

As the time is near at hand when our bees, which have been housed in the cellar all winter, must be placed on their summer stands and cared for, I thought perhaps I could not do better at this time than to tell the readers of the American Bee Journal something of how I manage at the beginning of the season when working for comb honey, as I now expect to follow this article with four or five more on the production of comb honey.

I follow a different plan in setting the bees out of the cellar from what most apiarists do, and after trying all the plans for years which have been given, I like this much better than any other. Beginning with the first day that the bees which are out-doors (I almost always leave a few colonies on summer stands during the winter) gather pollen, I commence at about 3:30 o'clock, p. m., (if the mercury stands as high as from 50° to 60° in the shade) to put out a part of them, say from 10 to 20 colonies, as the case may be, scattering them about the yard so they will be as far apart as possible and yet be within the limit of what space I wish the yard to occupy. This is done so that I need keep no track of where they formerly stood, and yet not have any mixing of bees, as would be the case were all set out at once or near together. Where all are put together, as most apiarists do this work, there will be more or less of colonies mixing up, unless each colony is put on the same stand they occupied the fall previous. To so put them requires a great deal of extra work, numbering hives, stands, etc., which is quite an inconvenience, along this line, and even then does not prevent some colonies getting far more than their share of bees.

To put out, I place my spring wheel-barrow and lighted smoker near the door of the bee-cellar, when I carefully open the door and quickly step in and get the first hive nearest the door, placing it on the wheel-barrow, when the door is immediately shut again. The bees in the hive now begin to realize that their long winter nap is at an end, and if I took no precautions would soon be out of the hive and in the air, losing their home and stinging fearfully. To avoid this, I now blow four or five puffs of smoke in at the entrance to keep them quiet, when the entrance is closed by laying a square stick in front of it, when the hive is wheeled and placed on the stand it is to occupy. The stick is now taken from the entrance and the bees allowed to fly. This they will do as leisurely as they would had they not been disturbed at all, while had not the smoke been given, they would have all piled out of the hive with a rush. This going out slow is a great advantage to them in marking their location and repelling robbers. The next pleasant day more are put out in the same way, and at about the same time, scattering them about as before, but paying no attention as to how near they come to those put out at

the same time. I sometimes put out about the same number in the morning of a pleasant day, beginning to carry out as soon as the mercury reaches 45°, because in this case the bees must get through their thickest flight before those already out become active, or else there is danger from robbing. In fact, those put out in the morning are much more liable to be robbed, especially if a little weak, and for this reason I put out the most of them in the afternoon. By this plan all of the fatigue usually attending this work is overcome, as well as the mixing of the bees, keeping record of where each hive stood the year before, etc.

As soon as put out, the next is to see that all have plenty of stores, and if in a tight-bottomed hive, clean off the bottom-board. As I use loose bottom-boards, a clean bottom-board is placed on the wheel-barrow to set the hive on as it comes from the cellar, so I do not have to disturb the bees afterward, on this account.

To find out about the honey or stores, the first cool morning I go to the hive, take off the cover, and carefully raise the quilt or honey-board, and look for sealed honey along the top-



Miss Mathilda Candler, Cassville, Wis.—See page 200.

bars of the frames. If plenty is seen they are all right till they are to be looked after three weeks later. If little or none is seen, they must be fed, for if we are to reap the best results from our bees they must have plenty of stores at this time to encourage brood-rearing.

For feed at this time, I prefer combs of sealed honey set in next to the cluster, to anything else. If no such can be had, we must feed sugar syrup, of course; but the feeding of syrup or extracted honey, thus early in the season, entices many bees out to perish in unfavorable weather.

Three weeks later, the hives are opened for the first time (unless we have some essential cause for opening them sooner) and the brood-nest reversed by placing the two center combs of brood on the outside and the outside ones in the center. By so doing, a great gain is made, as all of the older brood is in the central combs, which are generally filled nearly to the outside next the frame, while only small patches of eggs and small larvæ are in the outer ones. This reversion causes the now inside frames to be filled entirely with brood in the shortest space of time, while there is little danger of chilling any brood in this way.

Remember, it is only the combs that actually have brood in them that are to be reversed, not all the combs in the hive, for, if this latter was to be done at this time, much harm would be the result. At this time we should also know that each colony has plenty of stores to last two or more weeks, for at no time should the bees feel that they must economize in honey, if brood-rearing is to go on rapidly, which it now must if we are to get a good harvest of honey. Borodino, N. Y.



Getting Women to Attend Conventions.

BY MRS. N. L. STOW.

At the Chicago meeting of the Illinois State Bee-Keepers' Association, this question was asked by our worthy President:

"What can we do to interest the women, and get them to attend our conventions?"

The question was not fully answered. That all who are interested in bees, will be glad to attend if they have opportunity there is no doubt, as there is so much to be heard there that we do not get in our printed reports, and, as far as I have been able to judge, those who have attended have been most cordially and graciously received, so they can have no cause for complaint on that score. The best solution of the question would be, to let each man begin at home—bring the wife, daughter, or sister, and having his own there, he will be more likely to tolerate his neighbors'.

If you have any female relative you can inveigle into the business, do so, and make her think, if you can, that she is as much interested as you are, financially, or otherwise, and you will have a most efficient helper, and you won't have to ask her twice to attend the convention with you. While the wife and daughter may be the best help for the apiarist, I object to making them a convenience. It may look sordid, but if there is any money in the business they should share enough in it to feel that they are working for themselves as well. That, of course, is an individual matter, but—"All work and no play makes Jack a dull boy," applies here as well as anywhere, and they should get as much fun, or profit, out of it as you do yourselves.

I have never advised a woman to go into bee-keeping independently; all have not a natural taste for it, and there is so much expense attending it, that a woman should think well before venturing; but for one with a love for nature studies, and strength for out-door work, it is an ideal occupation, especially as a helper or director of an apiary. There is activity and mental stimulus enough to give it a zest, and lift it out of drudgery.

Some of our best ladies are interested in bee-culture. One whose name is well known in high social circles in Chicago, has put bees on her summer home in the country, and has made the care of them a study, and took charge of them herself last summer.

To my young sisters who may be restive in your country home, and ambitious to try city life, I would say—Don't. Our large towns and cities are full enough of struggling humanity. Make the most of your opportunities where you are. Try bee-keeping, or anything else that will keep your lives pure and sweet. If you are aiming for higher culture, then I bid you God-speed; but cheap finery is not culture. Hamerton says: "The essence of intellectual living is a constant preference for higher thought, over lower thought, and this preference may become the habit of a mind which has not any considerable amount of information." Evanston, Ill.



Large vs. Small Hives—The Double 8-Frame.

BY CHAS. DADANT.

On page 34, Dr. Miller asks me: "What about a big lot of bees reared too late to work on the harvest?"

In a previous article, I have shown that the colonies which are the most likely to rear a big lot of bees too late for the harvest are those that are too weak at the beginning of the

harvest to gather a big crop of honey. The others being strong at the beginning of the harvest, fill the cells early, and the breeding is more likely to decrease in them early. Those hives, which breed largely late, we have shown that we use for increase, putting their bees where they will do the most good.

But what if we rear a big lot of bees in every one of our hives before, during and after the harvest? You will, or course, grant that the number of idle bees will only be proportionately larger in our hives than in the small hives. I would rather have a large lot of bees during the whole year, in my hives, than to have as small a lot as can be reared in an 8-frame hive. A big lot of bees—after the spring harvest—will make the hive ready for a big fall harvest; for I take it for granted that you have two distinct crops, as we have. A big lot of bees, in the fall, will give the colony a chance to winter better, rear young bees earlier, and—since they have a larger proportion of honey—with no more proportionate expense than a small colony. I think we all agree that a large number of bees in the hive, in spring, insures a better chance for a spring harvest; and nothing entices a queen to breed as a large lot of bees in a well supplied hive.

Dr. Miller continues: "Even if it is admitted that the 8-frame hive is too small, why, Mr. Dadant, can we not use two of them for each colony?"

Of course, this can be done, and in fact, is done, often, but we have tried it and do not like it at all, especially when we try it side by side with the large hives. The 8-frame hive doubled, increases the space too much—it gives 16 frames instead of 8, furnishing about 4 frames more than is needed for the most prolific queens.

Now let us compare the two hives, the one with the large Quinby frames and the double 8-frame hive, beginning with October.

The colony in the 16-frame hive, if strong, inhabits the entire two stories. The honey may be scattered through the two stories, or it may be only in the upper tier. If it is scattered in both, there is a chance that the upper story will not have enough to winter all the bees. If it is only in the upper story, it is quite likely that the colony will be crowded, in that one story. There may also be some brood in the upper, and in the lower story. Then you cannot remove one and leave the other, unless you wait longer than is advisable. You have to examine both these stories. Thus, not only your visit is long, and excites robbing, but you must either leave both stories with too much room, or give yourself a great deal of trouble in removing the superfluous combs. With the large hive, after the supers are removed, we can, at a glance, tell whether the bees have enough to winter. If they cannot cover all the combs the removal of one frame, and moving up of the dummy, reduces the space quickly. If they cover all the combs, and you see honey in every frame, it is evident that they have enough, and they are ready for winter. The work is done faster than with the two stories, and the colony is in more compact shape, if very strong, than in two stories, and in better condition for winter. There is no need of disturbing the brood-nest and exposing the combs.

Let me say here, that we have never adopted, at home, the cheaper way of making the hive-cap of the same size as the body, for economy's sake. Our caps are all made larger than the bodies, and telescope on them in the old way, being supported as with the good, old Langstroth hive, with cleats all around. The hive is a little more expensive, but we have a better fit, and a much better protection against robbers, moths, cold, etc. An open joint will do in the summer, but in other seasons, especially in spring, we want a well closed cover. Then we have more room to put on an oilcloth or a straw-mat. We even broaden the top edge of our hives, by nailing a slat all around, on the outside, over which the cap fits. Supers, honey-boards, etc., are much more readily adjusted, in this way.

In the spring, these large hives have more of a supply than your 8-frame hive, if the latter has been reduced to a single story, for winter, as we suppose you expect to do. We can, at a glance, tell whether our bees have sealed honey left, which is usually our test for knowing whether they can go through the rough weather of March and April without feed. With your double 8-frame hive, reduced, you will probably have to feed the strongest colonies—the very ones which are the best off with us, unless, as I said before, you have left the double story on. When the crop comes, all we have to do is to put on the surplus boxes; while you have to wait for the opportunity of doubling your hive again. If this is done too soon, you make your bees cold by giving them so large an empty space. If too late, they may have prepared to swarm already. With us, the hives which have been narrowed up by removing one or two combs, can be re-supplied, one comb at a time, if advis-

able. You cannot do this, and yet, you must acknowledge that it is of very great importance to keep the bees with room, and yet, as warm as possible during the spring months.

Our method saves work and gives the bees just the space they want. It leaves enough honey with them for the entire winter, unless the supply was short, in which case you are no better off than we are.

If your bees are so strong that they can use nearly two stories the season through, you have an unwieldy hive, easily tipped by strong winds, the bees are less cosy, the cluster more scattered, and the expense of keeping two small hives is just as great as that of the one large hive.

If we had to use the 8-frame hive, we should not use a double story, but a story and a half, which would make about the right space, but we prefer to use the half-stories only for the surplus.

Hamilton, Ill.



Some Subjects Reviewed and Commented Upon

BY DR. C. C. MILLER.

SIZE OF HIVES.—Referring to the remarks of D. A. Holeman, on page 130, I must say that the size I gave on page 745 is really the size of the Dovetail hive instead of the Simplicity. It's the size, however, that I would make the Simplicity hive if I should make such a hive, which I don't think I'll ever do. Mr. Holeman is right in supposing a dummy is used in the hive, and I wouldn't like to be without it. It gives so much better chance to get out the first frame.

With regard to super, I'd have that the same size as hive, and I'd have a dummy in that, too.

QUEEN-CLIPPING DEVICE.—When I first saw the advertisement of this implement, I said to myself it didn't amount to anything, if indeed it wasn't a humbug, but after reading the description on page 130 I must confess I think it would be a fine thing for many an inexperienced person, and possibly it might be a decided help to those with much experience.

HOUSE-APIARIES ON POSTS.—Does B. Taylor find no disadvantage in having his house-apiary on posts, on account of its being colder?

AMALGAMATION.—Is there something in the climate that makes bee-keepers in California think the attachment of the North American to the Union would be a damage? Mr. Hambaugh has come to be a Californian, and his views have undergone a change. I do really believe, Mr. Hambaugh, that you Californians have the views you have, simply from some misunderstanding.

On page 162, you think a big change would be necessary to unite the two because one is national and the other international. I believe that is a mistake as to fact, for unless I am utterly mistaken one is international as much as the other. So that point needs no discussion.

As to the "bone of contention," there might be a bone of that kind if there was to be a division, and one society get less money than the other, but when all the money and all the members are one, where is the chance for contention?

That question about "abandoning the national feature to become international" falls to the ground if I am right in thinking the Union is already international. Moreover, our brethren across the border are no more obliged to accept a tax than we on this side. If I don't want to pay my dollar I can stay out of the Union, and so can a Canadian.

Yes, you're right, the whole thing should be fully understood, and I've no idea there will be any action taken without a fair vote of the members of the Union.

Now look here, Mr. Hambaugh, the last time I looked into your pleasant face, (I wish I could look into it again) you seemed perfectly sane, but you surely must have been suffering a temporary aberration when you wrote that word about dethroning Thos. G. Newman. Who in the world was talking about dethroning him? Besides, if I wanted to have him dethroned I could vote against him as manager without any amalgamation, and what more could I do if the two societies were united? What difference can the amalgamation possibly make as to his election?

Now, friends, if there's any reason against amalgamation, by all means let's have it. But if there's any way by which the numbers can be increased, don't oppose that way through errors of imagination.

Marengo, Ill.



Now is the Time to work for new subscribers. Why not take advantage of the offers made on page 175?

Amalgamation and a National Bee-Keepers' Association.

BY GEO. W. BRODBECK.

Have you ever thought of the possibility of the proposed annexation of the National Bee-Keepers' Union to the North American Bee-Keepers' Association as being a misleading one, and, should this consummation take place, it would not be what our needs demand?

Is it not true that every organization of prominence in connection with bee-culture that has existed in this country which has gone through the varied phases of consolidation, etc., is a thing of the past?

Is it not true that some of the very individuals who are seeking to enlarge the capacity of the North American are but repeating their past history?

If past failures have followed like projects, have we any assurance that the proposed one will be a success?

If the National Bee-Keepers' Union had no bank account, would the effort to secure control of it by the members of the North American be just as strong?

Have the members of the Union expressed dissatisfaction with their organization, and a desire to consolidate with the North American?

Is it not true that the Union has been a success up to the present?

Is it not the bounden duty of the officers of an organization to protect its interest without discrimination?

We leave the reply to these questions to the readers, but especially to the members of the Union.

Our Canadian brethren have thoroughly entrenched themselves by effective home organizations, and one of the late results of their labor and combined influence was the enactment of a prohibitory adulteration act by the Canadian Parliament. We, unfortunately, have no such organization, consequently our bee-periodicals find it incumbent to request the bee-keepers to appeal to their congressmen, and in all likelihood that ends it; and this very method has been demonstrated quite recently in the American Bee Journal and Gleanings in the effort to secure a re-issue of Mr. Benton's bee-book; and yet we are prone to prate about our advanced state in bee-culture, when there does not exist a single organization in the United States representing the bee-keepers of this great land, capable of meeting the demands of the times!

'Tis true, we have our county and State organizations, in which we take just pride, but right here our influence ends, and that is why we are so helpless outside of our own domain. We believe that the realization of this condition has resulted in impressing itself upon the minds of some, that this proposed new project of amalgamation would fill this long-felt want, and the sooner we rid ourselves of this assurance the nearer we will be to the accomplishment of our desires, and the attainment of our objects.

How would it be possible for an affiliated association, composed of two elements, and one of those elements of foreign competition, entering the halls of our republican form of government, and claim to represent the American bee-keepers (we have no thought of reflecting upon our Canadian friends)? Why, the very thought is absurd and preposterous! Nothing but a representative United States organization can ever represent our bee-keepers within our legislative halls, and it is a blot upon our history, both past and present, that no such organization exists in the United States to-day.

We appeal to every State and county organization, and to every individual bee-keeper of foreign or native extraction, who claims this land as his home, and whose sentiments are in accord with those expressed, to join hands with all others who favor the upbuilding and protection of the bee-keepers' interests by the organization of a National Bee-Keepers' Association.

Los Angeles, Calif.



Hives and Systems of Management.

BY JOSEPH THIRY.

Never before has our bee-literature been so valuable to the wide-awake and successful bee-keepers as it is now. One of the most important and valuable discussions is that on the bee-hive—the proper size of brood-chamber, and the most economic and labor-saving systems of bee-keeping; for these are the ones that will come out ahead in the present competition with low prices. Of course there will always be advocates of the various types of hives and systems, but the great majority will agree with me, that there are but three systems to-day that are worthy of consideration, namely: the Dadant, the Tinker, and the Heddon. I believe there is not a place on the

face of the earth (where bees are kept) that one of the above systems can't be worked to the best advantage. Outside of these systems I do not consider bee-keeping a profitable business—at least in this part of the country.

The Dadant hive will be the best for those who still stick to the single story brood-chamber, and far better than the Langstroth hive, for several reasons. For me, the Langstroth hive has seen its best days, for it is too deep to tier up to the best advantage, either for brood or honey, and it is too shallow to give the best result in wintering. In fact, I have seen but few who could honestly recommend it as the best hive.

What gave the Langstroth hive its prominence was the great advantage it afforded the manufacturers, who made the hive to sell, requiring boards of but 10 inches in width, which are the cheapest, and in their eagerness to sell the cheapest, the Langstroth hive was universally adopted.

Dr. Tinker has a far better bee-hive and system, and his frame is far ahead of the standard Langstroth frame; it is handier to manipulate, and the bees will build better and truer combs in these smaller frames. It is also handy for handling hives instead of frames, which is another short cut in handling bees.

The single case is just right for contracting, for building up colonies in spring, and for those who want increase. This little hive is just the thing for living late swarms (if swarming is allowed), and the brood-chamber, containing 800 inches, is sufficient to winter most colonies, although two are better. And the great beauty of the hive is that a queen will pass from one case to the other without the least trouble, which they will not do with the standard Langstroth, unless they are in the very best condition.

A young and vigorous queen, right in her prime of fertility, I have found will enter without any trouble the double standard Langstroth, other conditions being equal, but such queens are not always on hand, and another thing is, that adding 8 Langstroth combs makes too much of a change, and will retard brood-rearing, unless it is done at just the right time; and a change in the weather would do great damage to colonies thus expanded; therefore, 800 inches of comb is the best for safety.

I would like to hear of the success others are having with this bee-hive. I am sure that but few will have anything to say against it. Another great advantage is that the combs used in the brood-chamber can also be used to the best advantage in producing extracted honey, doing away with the nuisance of two kinds of combs in the same hive; and it is next to impossible to produce a gilt-edge article with deep extracting-combs, as the bees are loth to enter it, and there will be ripe honey at the upper edge, and thin, watery honey at the lower edge, which spoils the quality. The same applies to the production of comb honey, and the deep comb will not give the best result with the bee-escape.

For those who desire a closed-end reversible frame, the New Heddon hive is the ideal. I consider the New Heddon hive and system of bee-keeping the best for all purposes, but it would be better if the brood-case was a little larger, for it is claimed by some that in producing comb honey the bees are inclined to carry pollen to the sections. Findlay, Ohio.

Honey as Food and Medicine.—A new and revised edition of this 32-page pamphlet is now issued. It has 5 blank pages on which to write or paste recipes taken from other sources. It is just what its name indicates, and should be liberally distributed among the people everywhere to create a demand for honey. It contains a number of recipes on the use of honey as food and as medicine, besides much other interesting and valuable information. Prices, postpaid, are: Single copy, 5 cts.; 10 copies 30 cts.; 50 for \$1.00; 100 for \$1.75. Better give them a trial. Send all orders to the Bee Journal office.

Back Numbers.—We have on hand a few back numbers of the Bee Journal for 1895, which we will mail to any one wishing them at 15 copies for 20 cents. They will all be different dates, but we have no complete sets for the year. Just send us 20 cents in stamps or silver, and we'll send you 15 copies. No doubt there are many new subscribers who will be glad to take advantage of this offer.

The McEvoy Foul Brood Treatment is given in Dr. Howard's pamphlet on "Foul Brood; Its Natural History and Rational Treatment." It is the latest publication on the subject, and should be in the hands of every bee-keeper. Price, 25 cents; or clubbed with the Bee Journal for one year—both for \$1.10.

See "Bee-Keeper's Guide" offer on page 206.

CONVENTION PROCEEDINGS

The Colorado State Bee-Keepers' Convention.

REPORTED BY F. L. THOMPSON.

(Continued from page 183.)

An essay from Theodore Lohf, of Brighton, was read, on the "Use of Foundation." The chief points are as follows:

THE USE OF COMB FOUNDATION.

For surplus, I use as narrow starters as possible, say $\frac{1}{2}$ to $\frac{3}{4}$ inch, in order to have a nice article of honey, and to save foundation, which is equal to money. I fasten starters with the Daisy foundation fastener. It is easy to put in 2,000 starters a day.

I find the sections must be well warmed and dried after folding, or else the wax will not stick. If only one starter should become loose, the loss might be three sections in the super.

For brood-frames I use full sheets. I have not succeeded at all times in former years with wired frames; while working for comb honey, I do not care for them. The bees require little help in working the combs straight when started right. I hang a frame of foundation between two straight combs. I find it valuable in building up weak colonies and in preventing strong ones from building drone-comb.

THEODORE LOHF.

The essay was then discussed.

H. Rauchfuss—I should do just the opposite—use full sheets above and starters below. More honey results. There is danger of swarms swarming again when hived on full sheets, even when they have dwindled. Very strong colonies do not swarm as much as medium or weak colonies. I have hived swarms on drawn combs which started queen-cells in three days, and then swarmed. Before I'd use full combs I'd cut them out and melt them in the solar extractor. Never use drawn combs except for building up weak colonies and nuclei. Don't use unwired sheets unless you want more drone-comb than in any other way. The foundation will stretch at the top. The nicest work in comb-building is at the very first of the flow. My most perfect combs are built by nuclei, from starters over wires in the first part of the season. If swarms build rapidly, even their comb will stretch. Foundation in weak colonies late in the season may not be worked at all, except to have holes gnawed in it.

Pres. Aikin—It is very bad advice to use foundation without wire.

H. Rauchfuss—Even with wire, combs from full sheets are not so nice as combs built from starters. They are like a sheet of tin which has been pounded. They bulge every way.

Pres. Aikin asked the convention how many had found that by using full sheets they would get an abundance of drone-comb by the stretching of the foundation. A rising vote was taken. The majority had found it so.

The most important question in the question-box was:

WHAT DO YOU KNOW OF THE LONGEVITY OF DIFFERENT COLONIES OF BEES?

H. Rauchfuss—I had one colony which was not very strong, not even medium. Not long after it received a super, it filled it. It continued that way all summer, and kept up only four frames of brood. Such a colony I consider a weak one. But it outstripped every colony in the yard. We had another which for three years was the best one. It was never more than medium in strength. The reason for such cases is, that the bees lived longer, and did not have to support so much brood for the same results.

Pres. Aikin—The system of unqueening ought to give the opportunity to observe this point, but I did not have my attention called to it. I had one colony which lost every queen given to it, yet it stored abundance of honey, though it had very few bees at the end of the season. The question is a very complicated one, and requires much care in observation. Queens lay freely at different times. Some writer has said that a queen with a large thorax is better.

F. Rauchfuss—The colony referred to by my brother had

an Italian queen which was mismated. It happened to be the colony which we had on scales, so that a good record was taken, and we naturally observed the brood closely. It always had less brood, and was always the best working colony. The queen was of medium size. The workers were mostly 3-banded.

Mr. Carlzen—That hive stood at the end of the row, as I observed. They say the end hive in a row gets more bees.

H. Raufuss—But they were not strong in bees. Besides, the hive and its surroundings were so peculiarly marked that the bees could not have mistaken their location. The queen was clipped, so we knew it was the same one. The colony never attempted to swarm.

Mr. Porter—In Italianizing I noticed one case by observation of the black and yellow bees. In that way the chance for deciding is more favorable. But this matter requires a good deal of science.

Mr. Deviny—Such things ought to be brought before the Agricultural College by the Secretary.

F. Raufuss—I have already suggested it, but the college is overburdened with work, and is without some facilities. I suggested an experiment in foul brood, but that region is free from foul brood, and they do not want to introduce it. Experimenting takes a long time.

Mr. Alford—The professors are confined nine months in the year. They want a vacation. This comes just when such work can best be done. An experiment station would be better. The only time they can give to such matters is between the 1st of April and the middle of June, when they are busy with their classes.

SECOND DAY—SECRETARY'S REPORT.

The season of 1895 was, as far as honey-production is concerned, one of the poorest the bee-keepers of Colorado, and of the whole United States, ever experienced. But in spite of the scarcity of our products, prices have not advanced; on the contrary, comb honey was sold in the Denver market last fall at a lower figure than ever before, and extracted honey only held about its own. Beeswax is the only article which is in good demand at fair prices. It would be well for bee-keepers to work so as to increase the wax-production of their apiaries.

The past season the bee-keepers of the United States have suffered the loss of their greatest benefactor, the Rev. L. L. Langstroth, the inventor of the movable-frame hive, and author of that standard work on bee-culture, "The Hive and the Honey-Bee." The California State Bee-Keepers' Association invites the co-operation of the bee-keepers of the world for the purpose of erecting a suitable monument to his memory, and I hope the bee-keepers of this State will not stand back.

On account of the poor season, the need of organization for the purpose of disposing of our products was not much felt; but anticipating a good crop the coming season, it would be well to take steps toward that end now.

FRANK RAUFUSS.

THE PRESIDENT'S ADDRESS.

Ladies and Gentlemen :—We have met once more in the capacity of the Colorado State Bee-Keepers' Association. We come together to see each other face to face; to give and receive; to tell our experience since last we met; to discuss ways and means of bettering our condition as bee-keepers; and, I hope, to help each other to be better in every way.

The past year has been one of much disappointment. We looked for good crops, but they came not. We hoped for living prices for the little we did produce, and in this have been disappointed. Selfishness is the prevailing motive in the conduct of affairs in general. True, there are many good and honest people; nevertheless, the prevailing custom of business is to get all it can—"all the traffic will bear"—right or wrong. That bee-keepers may crucify this spirit is my ardent desire. We should be as willing to give as receive; to help one another.

This organization is known as the Colorado State Bee-Keepers' Association. It has met annually for 15 years, and has done much good to its members and the apiarists of the State in general. If I mistake not it was through this organization that our foul brood law was brought about. I will not try to enumerate all the benefits to the apiarists accruing from the organization; but that much good has come, I think all will admit.

But is there not more that can be done? Can we not devise some way by which we may have a reasonable fund in our treasury? To do good work we must be thoroughly organized. Organization means labor and expense. That this should be borne from year to year by a few, and the many

reap the benefit, is not right. We need many members and more money. I hope to see the bee-keepers all over the State brought into contact by means of the State association. I do recommend thorough organization, but not with selfish motives. Let our efforts be to foster, defend and protect, and not for greed and oppression. Almost every business interest except the agricultural is organized, and why not we? Indeed we must do so or be crushed. Most organizations at first are fostering and protective, but as they grow in power become the instruments of oppression. So long as we can work in the former spirit I say organize; but for greed, never, no never!

Our country is vast in extent, and we send products to and receive from far distant places and people. Capitalization and organization together with the great transportation facilities favor and are fast leading us into specialism. In the days of the past each family was complete in itself, buying little and selling little, producing what they used, and doing without what they could not produce; but now we exchange our honey, corn, pork, beef, potatoes, and whatever we produce, for the products of others, thus becoming dependent upon one another, which also gives much greater opportunity for unjust methods, and the more so the greater the combination and capitalization. Were it possible for me to use all my own productions, or place the same at home where I know everybody with whom I deal, and also the needs of the people, I would not care a snap for organization; but since I must exchange with strangers, knowing not with whom I deal, nor where the greatest need of my product is, and even if I did know, and a greedy transportation company lies between me and the needy place, the need of a protective organization appears.

It behooves us, then, to organize and co-operate; to place our products to the best advantage through the help of one another; to protect ourselves against injustice. Supply and demand should regulate prices, and co-operation foster and protect.

I therefore recommend that this organization—which is but a mere speck of what it should be—reach out to the limits of the State; that we establish some method of continually knowing the supply and location of honey throughout the State, and the market that will best receive it. I do not recommend that we antagonize the honest honey merchant; but rather that we centralize the business with those we know to be the right kind of men, or sell through an agent of the Association who is practically one of us, and whose interests are those of the Association. Helter-skelter selling, and slipshod work, is certainly not the best for the pursuit, nor for the best interests of the consumer. The California fruit-growers have already accomplished a system of selling similar to the foregoing, and the bee-keepers of that State are now organizing to the same end.

A fostering association is at all times right, but I much deplore the condition of affairs that necessitates combination for defence. The State (Nation) should foster all its interests, but she does not. I know there are the so-called protective tariff laws; but as for benefit to the masses they are about as protective as was the "sugar bounty" law that helped the wealthy sugar manufacturers directly, and a few farmers indirectly, while the mass of over 300,000 bee-keepers had to compete with cheap sugar, especially on their extracted honey. Organized buying and selling would both be a benefit, but the more so in the selling, because the sales should far exceed the purchases, in apianian lines.

Every bee-keeper in the State—both great and small—should be in frequent communication with this organization in a central office, and do business intelligently. The manager should know where honey is most wanted, and ship from the point nearest, or where it would be to the most advantage. One great obstacle in the way is the fact that so many producers are so encumbered with debts that they must and will sell at once if possible, and regardless of prices or needs of the market. This demoralizes prices both by the direct cut often offered to induce purchasers, and by putting the product on a market not ready to receive it. I do not know how we are to overcome these obstacles, but I do think we should make the effort at once.

Methods of packing and marketing extracted honey also need attention at your hands. We have no retail package that is practical for shipping, and at the same time proportionally cheap. We now depend upon the wholesale package for a shipping package, and depend on the city mixer to repack in suitable retail packages. We should have a retail package that can be used as are those of fruits, the goods going to the consumer in the original packages, and without any tinkering on the part of middle-men.

I have not by any means exhausted the subject, but have

tried to start you in the right direction, and now wait for you to develop the thoughts, if it seems wise in the eyes of this Association to do so. R. C. AIKIN.

(Continued next week.)

Questions AND Answers

CONDUCTED BY

DR. C. C. MILLER, MARENGO, ILL.

[Questions may be mailed to the Bee Journal, or to Dr. Miller direct.]

When and How to Transfer.

I have a colony in a box-hive; they did not swarm last year, and I am going to put them into a Langstroth hive this spring. When and how would it be advisable to drive them into the new hive? C. H. L.

ANSWER.—During fruit-bloom is the favorite time. Many prefer to let them swarm first. Full instructions for transferring are given in back numbers, and in all the bee-books.

Sowing Sweet Clover Seed on Sod.

I have a waste place of about three acres, partly overgrown with blackberry bushes, etc. It was never cleared of stumps or stumps, or plowed. Do you think sweet clover would grow on such a place, if sown on the sod? I intend to sow some this spring? E. T.

Chain Dam, Pa.

ANSWER.—I once sowed a number of acres with sweet clover on sod. Not one seed in a thousand grew. But I think you would get a catch if you would sow very early (in the fall might have been better) then have a lot of stock run over the ground so as to tramp the seed into the ground thoroughly.

Comb-Space—Frame Sizes and Measurements—Spring Dwindling—Enamel Cloth Covers.

1. Is this the correct way to find the comb space in a hive—find the number of square inches (inside measure) in a frame, multiply by two, and by the number of frames in the hive?

2. Can you tell me the sizes of the frames, and the number in each hive, of the following kinds of hives: Dadant, Quinby, Gallup, and Heddon?

3. When a frame measurement is given, how is it obtained? Is it outside measurement, disregarding the projections of the top-bar?

4. My bees are troubled very much with spring dwindling, and I would like some advice on the subject. The hives are situated in a warm place under a hill, and the least sunshine calls the bees out to their death by cold winds, etc. I do not care for very early breeding in the spring, because of the many sharp freezes after warm weather sets in, so I think it might be a good plan to shade the entrances with the summer shade-boards, removing them during really warm days. The only objection I can think of, is that shading the entrances shades the hives, and hinders early brood-rearing; but, as I have said, I would not care for that. What do you think?

5. Do you use enameled cloth to cover brood-frames, or simply the cover? I find the bees try to weld the cover, frames and hive together, and I have used heavy oilcloth raised a bee-space by sticks to prevent the welding process. I would like to discard that arrangement if you think the bee-space is of no special value to the bees, and simply use a sheet of enameled cloth.

6. Is there any special form you would like questions to be in, such as writing on one side only, numbering, etc.? Don't think by this that I am going to flood you "off the fence" with questions. BEE-FEVER PATIENT.

ANSWERS.—1. Of course, that gives the actual amount of comb-surface in the hive, providing the frames are completely

filled, but it is not customary to multiply by 2. So, if the inside measure of a frame is 8x10, the comb-surface in that comb would be called 80 inches.

2. Quinby, 18 $\frac{1}{2}$ x11 $\frac{1}{4}$; Gallup, 11 $\frac{1}{4}$ x11 $\frac{1}{4}$; Heddon, 18 1/16x5 $\frac{3}{8}$. I think the Dadant is the same as the Quinby, only $\frac{1}{4}$ inch deeper.

3. Yes.

4. It may be well to try shading the entrances as you suggest, or at least part of them. If you shade part it will give you a chance to compare results.

5. I used enamel cloth for many years, but use none with the flat cover. To be sure, the bees glue together the hive and cover, and I prefer to have them do so. If they didn't, the first strong wind would blow off the cover. I suspect from what you say that the bees build comb between the top-bars and the cover. Perhaps you have too much space. One-fourth inch is all that should be between top-bar and cover. I never used anything under the oilcloth, but put it directly on the frames. The bees always took care to make passages over the top-bars by crowding in bee-glue.

6. It helps to have questions numbered, and although I can make out to answer questions in any shape almost, still it is a pleasure to have plain and distinct writing. So far as I am concerned, I don't care how many sides of the paper you write on, but printers are better-natured if you use only one side.

Time to Make Honey-Vinegar.

How long a time does honey and water ferment before it becomes vinegar? C. W. L.

ANSWER.—E. France says he takes two years to make vinegar. T. F. Bingham says a year or less. If you make it strong with honey it will take longer to make than if it is weak.

Variation of Bee-Cellar Temperature.

1. Will the temperature of a cellar be any higher with 100 or more colonies than with only five or less in it?

2. If so, how much will it vary?

3. Will the temperature be more even with 100 than with five or so? NEBRASKA.

ANSWERS.—1. Yes, the heat from the bees themselves makes a difference. The smaller the cellar, and the more crowded the bees, the more difference will be shown.

2. I don't know, and it would be very hard to get an entirely reliable answer. If you had two cellars exactly alike in every particular so you could compare, then you could find out something about it. With only one cellar I don't know how you could find out for certain. The variation would probably not be at all constant. Under some circumstances the variation might be more than twice as much as under others.

3. Probably you wouldn't notice much difference as to evenness, although the larger number ought to keep the temperature a little more even.

How and When to Transfer.

How do you transfer bees? I have 6 colonies in old Langstroth hives, and have 10 new alternating hives which are smaller, being 18 11/16x5 11/16, 2-story brood-chamber. The question with me is, how and when to transfer these 6 colonies from Langstroth hives to these alternating hives, to get the best results in increase and honey (in your judgment). Of course there are many things that might make vastly different results, but of these unforeseen things I must take my chances, as I did at the front in 1861 to 1864.

C. E. M.

ANSWER.—To transfer from a larger to a small frame ought not to be a very difficult matter. Upon a table place some newspapers spread out, and on this place one of the frames of comb to be cut out, having previously placed under the frame some pieces of common wrapping-twine. Cut all around the comb with a sharp, thin case-knife heated from time to time. Now lift off the frame, leaving the comb on the table. Place the new frame over the comb, and with the knife mark around the inside of the frame on the comb. Take the frame off and cut the comb so as to fit in the frame, being sure to have it rather a snug fit. Now crowd the new frame down over the comb. If the strings were placed right in the first place, you will have six or eight of them at intervals, so that all you have to do now is to tie the two ends of each

string together over the top-bar. If the comb should happen to be such that it fits loosely for any considerable distance, crowd in little pieces of comb to wedge it in place. In lifting the comb from the table, it will be a help if you have previously put on the table a board a little larger than the frame. Then you can lift board and all, turning it so the top-bar will be uppermost before removing the board. If drone-comb is present, cut it out and replace with patches of worker-comb. Perhaps you can fill a frame or two with pieces fitted together.

It may be well for you to take out about half the frames at first, then when you get these transferred remove the old hive from the stand and set the new hive with the transferred combs in its place, then brush the bees from the remaining comb into the new hive, filling up the hive after you have transferred the balance.

Transferring can be done almost any time, but you will probably do as well to take the time of fruit-bloom. After two or three days you can remove the strings and save the bees the trouble of gnawing them out.

Another Frame-Spacer.

I send a pattern of a spacer that I am going to try this summer, although I suppose it has been tried and discarded long ago. It looks to me as if it will be satisfactory. Please give me your opinion. There are lots of bees in the woods. I found four colonies last fall. Bees in this part of British Columbia fly out occasionally through the winter; they were out Feb. 16, gathering honey for the first from the chickweed, on the 19th bringing in pollen from the willow; the 20th was too cold. One thing here against bee-culture is the springs, which are generally chilly and wet, although some times it is very warm and pleasant. M. S.

Steveston, B. C.

ANSWER.—According to the pattern sent, each end-bar is made with a shoulder at top and bottom. The plan is not new, and some like it, but where the frames are not put in the extractor, there is no advantage perhaps over the use of common nails driven in the right depth for spacers.

Starting in Bee-Keeping.

If a person wishes to begin in bee-keeping, and must buy his bees of some dealer, which way is the best to have them shipped—by the pound, by the nucleus, or by the colony? Which way would you do, everything considered?

E. B.

ANSWER.—In this case, if I understand it rightly, it isn't a question as to where or from whom, but that part being settled, it's simply a question as to which of the three ways it is best for the beginner to get his start by. It will cost less to get them by the pound for expressage, but a beginner isn't supposed to have everything in good shape to set to work a lot of bees with nothing else. If, however, the bees are to be got a long distance, so that the expressage is a very serious matter, then it may be quite a saving to get the bees by the pound, and get hives, etc., by freight. This presupposes, however, that the beginner has read up pretty well in advance. But in ordinary cases, especially if only one or two colonies are to be started, then I wouldn't advise getting by the pound. Much the same reasoning will apply to nuclei and full colonies. If the distance is great, there will be a saving of expressage by getting nuclei. Otherwise it will be better to get full colonies.

Another item comes in to be considered, and that is the length of the purse. If a merchant in good circumstances is about to start in bee-keeping, and he doesn't care much for the matter of expense, by all means let him get full colonies. But if his clerk is the one, and that clerk is hardly earning enough to get him decent clothes, better get nuclei.

Cleaning Out Unfinished Sections.

Having a large number of unfinished sections, I would like to know if the bees that are a little short of stores as the season opens would remove the honey that is in them, they being placed in supers and put on top of the hive. O. L.

ANSWER.—If they are short of stores, and if the weather is warm enough for the bees to go up, they will take the honey out of the sections placed over. If your object is to get the sections emptied so as to have them filled again, you will

do well to do something more than to merely place them in supers on the hive. For there is likely to be some candied honey in them, and the bees will not be sure to empty out all the little granulations. If any are left in, even though so little that you don't see it, it will spoil your section honey next summer. Unfinished sections, to be used over again, should be cleaned out by the bees at the close of the harvest, before there is time for any granulation. After the bees have had a chance to empty the sections on the hive, put them out where all the bees can get at them. They will clean them out a good deal better there than on the hive. But there's danger of their tearing the combs to pieces. There are two ways to avoid this. The best way is to put out enough at a time so that all the bees in your apiary can find plenty of room to work on the sections. If you put out a single section for a dozen of colonies to work at, you may count the comb won't be worth much when they're done with it. But if you have only a few sections, then instead of having them all open as you do when you have plenty, go to the other extreme and allow an entrance to the sections only large enough for one bee to enter at a time. But never again carry unfinished sections over the winter with the intention of having the bees clean them out in the spring. The fall's the time for that job.

Facts About Sweet Clover.

If sown with oats or other grain, it is apt to become choked out, before the plants get a start, and should it be desirable to sow in this way, the grain should be put in very thin. It has always seemed to me that it would be a good plan for bee-keepers who are also farmers to sow sweet clover quite extensively and show neighboring farmers that it is a valuable plant, quite worthy of their attention aside from bee-keeping. If cut the first year in September it will produce a fine crop of hay, quite equal to alfalfa, and the plants will not be injured. Show farmers that it may be pastured for a month or more in early spring to great advantage the second year. It may then be plowed under to fertilize the land, but of course that would destroy it as a honey-plant. At the present price of seed, I am surprised that farmers do not raise it for that alone—it would surely pay better than many other crops. Farmers seem to be prejudiced against the plant and we should try to teach them that they are wrong, and that it is really one of their best friends.

Show them that if they want to get rid of it from the field, they have but to cultivate it thoroughly for two years, or turn in plenty of stock for a few years, and hardly a plant will remain. If we but show farmers how this, and other honey-producing plants can be profitably raised by them, the sooner will we hasten the time when "The good years will come again."—C. H. DIBBENS, in Canadian Bee Journal.

Shall We Use Separators?

I first used separators in 1872, on a small scale, to try the feasibility of them. These were cut so as to leave one-half inch at top and bottom of the sections, as I felt sure that they would retard the labor of the bees in the sections, inasmuch as they divided the bees into small clusters, apparently. To test the matter thoroughly, I used fully as many without separators, and with other colonies I went so far as to leave the bottom pretty much entirely off the sections, using only a thin strip to hold the sections together at the bottom, to see how much gain there would be by the most frequent communication all throughout the whole brood-chamber and surplus apartment, but at the end of the season, each part of the apiary tried was about equal as regards the surplus.

One thing I found, which was, that in my anxiety to get all the communication possible, I had made a blunder in cutting the tin too narrow, for the bees built the honey-cells out too long at the top and bottom of the sections, thus making them so they could not well be crated, without causing the honey to leak more or less. The next year the tin was cut wider, and also many separators were slotted so as to divide the bees as little as possible and other colonies were prepared with sections without separators. No perceivable difference, as to yield, was the result, again, while many of the sections used without separators could not be crated for market, and had to be disposed of the best way I could.

I finally adopted a separator as wide as the inside of the section, less one-quarter of an inch at the top and bottom, with no perforations of any kind, and today, although I have experimented many ways since then, I see no reason for abandoning separators, or changing what I decided upon in any way, but, on the contrary, see many reasons for still continuing their use.—G. M. DOOLITTLE, in Progressive Bee-Keeper.

OLDEST BEE PAPER IN AMERICA

THE AMERICAN BEE JOURNAL

ESTABLISHED IN 1861

PUBLISHED WEEKLY BY

GEORGE W. YORK & COMPANY,

118 Michigan St., CHICAGO, ILL.

REGULAR CONTRIBUTORS:

G. M. Doolittle, of New York. Prof. A. J. Cook, of California.
 Dr. C. C. Miller, of Illinois. Dr. J. P. H. Brown, of Georgia.
 J. H. Martin, of California. Rev. E. T. Abbott, of Missouri.
 Chas. Dadant & Son, of Illinois.
 B. Taylor, of Minnesota.

\$1.00 a Year—Sample Copy Sent Free.

[Entered at the Post-Office at Chicago as Second-Class Mail-Matter.]

Vol. XXXVI. CHICAGO, ILL., MAR. 26, 1896. No. 13.



A National Bee-Keepers' Association is proposed by Mr. Brodbeck, on page 195. If such is ever organized we would suggest that it be called "The United States Bee-Keepers' Association" instead of "National." We have a National Bee-Keepers' Union, and to use the same descriptive word for another society, perhaps composed of the same members, might lead to confusion and possible annoyance.

Mr. Brodbeck is quite right, we think, when he intimates that our country ought to be able to have a grand bee-keepers' association all its own. Other countries have such, and why not we?

Home Marketing of Honey is now receiving a good deal of attention in some of our contemporaries. Good thing. It's high time bee-keepers are learning to work the "gold-midges" near their homes instead of rushing their honey off to city markets, and often into the hands of untrustworthy commission-dealers. As "charity begins at home," so should honey-selling. If you love your neighbors as you should, you'll see to it that they all are well supplied with honey before sending a pound to city markets. The home demand must first be worked up, and then supplied with a good article. No trouble to hold it then. Think well along this line before you have another crop of honey to dispose of. It will pay.

The Benton Bee-Book Again.—Last week we received the following just a little too late to appear in the previous number of the Bee Journal:

FRIEND YORK:—Senator Burrows' Concurrent Resolution as amended, providing for the reprint of 20,000 copies of Bulletin No. 1, on "The Honey-Bee," has passed both branches of Congress, and is now in the hands of the printer. Of this edition, 15,000 copies will be distributed by Members of Congress, and 5,000 by the Department of Agriculture. The Department informs me they now have over 2,000 applications on file, and as soon as it is known that a new edition is to be published, they will be swamped. Will you kindly ask your readers to apply to their Senators or Representatives for copies. Should their allotment be exhausted, the requests will then go to the Department of Agriculture. This will serve two purposes, viz.: Relieve the Department of Agriculture, and impress upon Congress the extent of our industry,

and the appreciation by the bee-keepers of the work and their efforts in the interest of their constituency.

Very truly yours,

GEO. E. HILTON.

Now we hope that all who wish to have a copy of Mr. Benton's book will follow Mr. Hilton's directions, as given above. Be sure to apply through your Congressmen instead of the Department of Agriculture, and see to it that the names of all the bee-keepers you know are sent in for the book. It is not always that every bee-keeper has a chance to get something for nothing, or merely for the asking. But here is a case where it seems to be the fact. Send in your request at once—to one of your Congressmen—Senator or Representative.

Comb-Honey Production.—In this number of the Bee Journal, Mr. Doolittle tells how to begin the season, and that article will be followed by others from his practical pen along the line of comb-honey production. Then, next week, Mr. W. Z. Hutchinson will commence a series of four articles on "Producing Comb Honey in Michigan." Those who wish to produce comb honey will find in the articles of Mr. Doolittle and Mr. Hutchinson a lot of valuable instruction, which will well repay careful reading and heeding.

We believe that this year we have secured many of the very best writers on the subject of bees in this country—in fact, we have not spared expense in getting reading-matter for the Bee Journal, and we believe that our readers are appreciating it, and will do all they can to show their appreciation, not only by way of promptly paying their own subscriptions, but will get as many of their neighbor bee-keepers as possible to take the Bee Journal regularly. It will pay to help educate all your surrounding bee-keepers, so that they will be likely to produce a better article of honey, and then not spoil a good home market afterward.

The Langstroth Monument Fund.—As our experience tallies exactly with that of Gleanings in regard to this fund, we give here an editorial from that paper for March 15:

It will be remembered that, a few issues ago, a movement was started to build a suitable monument over the grave of Father Langstroth, said monument to be purchased with subscriptions received from bee-keepers. I regret to say that so far only a few subscriptions have been received. I cannot believe it is because of a lack of appreciation, nor because times are so very hard, but because it has been put off. I wish to say that even small subscriptions are very acceptable—amounts of 50 cents and \$1.00. These, as fast as received, will be credited and acknowledged; but if sent with other remittances, be sure to designate which is for the Langstroth monument fund. I believe that all the supply manufacturers, if not a good many of the dealers, should be willing to give more largely than bee-keepers who buy of them; but, in the meantime, let the small subscriptions come in. It would indeed be a reproach upon us, if, having attempted to raise funds for a suitable monument, we should fail.

Miss Mathilda Candler, whose portrait is shown on the first page this week, is one of Wisconsin's fair lady bee-keepers, living at Cassville. She began bee-keeping about seven years ago, by buying two colonies of bees in box-hives, which increased to four, and the next spring were transferred to Langstroth hives.

Miss Candler uses the 10-frame Langstroth, and thinks that is none too large, for the queen keeps them pretty well filled; also, the bees are apt to be better prepared for winter. The outside frames are nearly always solid full of honey.

She works mostly for comb honey, running only a few colonies for extracted, and extracting such unfinished sections as are not readily sold. She cuts out and sells as broken comb all not heavy enough to sell in the sections. The extracted sections, after being cleaned by the bees, are melted into

wax, or, if nice and clean, are used again the next season. In using these sections, Miss C. puts a row at each of the sides of the super, and one row in the middle, and fills out with new sections, using separators between each row. She thinks it pays to use them in this way.

Miss Candler puts the supers on when the raspberries begin to bloom—being about two weeks before clover begins to bloom—and gives the bees plenty of time to get ready for storing the honey, if there is any. But the last few years have been so dry, that the clover is nearly all gone, and her harvest has been mostly from basswood and fall flowers.

She winters her bees on the summer stands, in a box or frame with a hole cut in, to come even with the entrance of the hive. To the top edge is tacked a piece of canvas or muslin. This is set over the hive and filled in with sawdust. It is something like a sack, which is pinned shut over the top of the hive with pins. Her bees winter better when prepared in this way, than in any other way she has tried.

Miss Candler attended some of the sessions of the late Illinois convention, where we had the pleasure of meeting her. We hope to hear occasionally from her by way of something from her experience in the bee-yard. We wish all women bee-keepers to feel free to "have their say" in the Bee Journal. This is one of their "rights" we shall take pleasure in seeing that they get.

The Next North American Meeting—where will it be held? Again we want to suggest the experiment of following the G. A. R. encampment this year. As the Grand Army meets in St. Paul in September, and that city will be pretty well crowded then, we think that Minneapolis would be the proper place. All could get round-trip tickets to St. Paul, and then a small street car fare would take them to Minneapolis in a few minutes more. It seems to us this plan is worth trying, as the railroad fare will be only *one cent a mile* at that time.

While we know that it was practically decided at the St. Joseph convention that the North American in 1896 should go to Lincoln, Nebr., still we also know those good Western people are willing that the success of this year's meeting shall not be prevented by holding the North American so strictly to its pledges in a matter of this kind. Doubtless some other year, and that very soon, the G. A. R. will meet in Lincoln or Omaha, and then, if we find it a good thing to follow it around, there will be such a big meeting of bee-keepers as will simply astound our Nebraska friends, although accustomed to big things.

What does the Executive Committee say? Will they let the North American try the plan of *assuring* its members of low rates, by meeting with the G. A. R.? We would like to see it just once, any way, for we feel that ever afterward it would be the settled thing, and then wherever the annual G. A. R. meeting is announced, all bee-keepers would know that the North American will be there, too.

Asking Questions to be answered in the department of "Questions and Answers" is all right for any or all who are subscribers to the Bee Journal. But we have no space to waste on people who do not think enough of the Bee Journal to pay for it and get it regularly. We invite our paying subscribers to send in their questions—to us or Dr. Miller—but we do not feel under any obligations to answer questions in the Bee Journal when asked by a bee-keeper who is trying to "sponge" his information. We have just had such a case—a fellow in Kentucky who ordered this journal for some time, refused to pay for it, and then sent Dr. Miller a lot of questions, with the request that they "be answered in the American Bee Journal." Not much. Only honest people can patronize our question and answer departments, if we know it.



How to Feed Bees Profitably.

The rapid breeding in the early part of the season uses up the stores in the hive and very frequently leaves the combs empty at the beginning of the honey harvest, and they will be filled with the choicest honey from the flowers before the sections will receive any attention from the bees; and sometimes, in a poor season, this takes about all of the honey that the bees are able to gather and there will be nothing for the bee-keeper to show but stings.

This has seemed to me to be a grand opportunity for successful and profitable feeding, and I have made it an opportunity for exchanging sugar for honey by feeding the bees liberally at this time, filling their store-combs with sugar syrup for winter stores, and getting in exchange the choicest honey from the flowers in the sections. By this plan there is a possibility of some surplus if any honey is gathered from the field.

Of course there is a premium on this exchange, just how much depends on several things.

A part of the feed given at this time will be converted into young bees, which will become a part of the working-force to gather the surplus honey, and a part will be sealed up in the store-combs for winter stores. The part that becomes winter stores is without doubt a safe investment. The part which is consumed in rearing brood, rearing more bees to gather more honey, is, I am sure, still better.

Sugar and water in about equal parts thoroughly dissolved is all that is needed. Don't try to fix up or doctor it in any way, let the bees do that themselves. Don't imagine that you can help the bees in their work of ripening the feed at any time by making it thicker.

You will only hinder instead of helping them. Don't feed too fast; about 3 pounds of sugar per day is enough.

The wide-awake farmer feeds and cares for his horses to increase their working ability; his cows for the milk and butter; his sheep for the wool, and the poultry for the eggs. No sensible-up-to-the-times-farmer would think of making his business profitable without he did this, and yet there are very many bee-keepers who seem to cling to the uncertain possibilities of the bees working for nothing and boarding themselves; of getting a crop without any outlay.

But suppose the season should be a failure, how are you going to get your money back that you have paid out for sugar? I have been asked. My bees will be ready for business when the next season opens, instead of hovering on the ragged edge of starvation for half the year and then have to be fed to be worth anything.—H. R. BOARDMAN, in Bee-Keepers' Review.

Windbreaks.

In regard to windbreaks, I would not advise going to the expense of setting out trees of any kind, because it takes so many years for them to mature sufficiently to be of any service. It is true, we have around our apiary a row of tall evergreens; but they have been 17 years in growing, and it is only for the last three or four years that they have been of much service. They make a perfect windbreak—the very best—but they are very expensive; and by the time they would be of service many an apiarist might be out of the business. As a general rule we would advise the selection of a locality where natural windbreaks may be found. The apiary can often be located in the L that is sometimes formed by the barn and wagonshed. If, however, there is only one place where the apiary can be located, and that has no windbreak, I would advise putting up a tight board fence, say six or eight feet high, using cedar posts if you can get them. This will last a good many years, and be ready for immediate use.

No, windbreaks do no harm in shutting out summer-breezes. If the bees have sufficient entrance they can create ventilation enough to keep the hive cool, providing they have a little assistance in the way of shade.—E. R. ROOR, in Gleanings.

Every Present Subscriber of the Bee Journal should be an agent for it, and get all others possible to subscribe for it.



Largest Factory in the West **COMPLETE STOCK.**
Good Supplies and Low Prices
 Our Motto.

READ THIS—Mr. Keyes says: The 100 pounds of Extra-Thin Foundation you sent us is superior to anything he ever saw; and I think the same. R. L. TUCKER, Wewahitchka, Fla.
 Dear Sirs:—The Sections came duly to hand. Indeed, they are very nice. Yes, sir; they are as good as the best. CHARLES H. THIES, Steelville, Illinois.
 Leahy Mfg. Co.:—I have received the bill of goods. I must say they are the choicest lot of Hive-Stuff I have ever received from any place. I admire the smoothness of your work, and your close selection of lumber. Yours very truly, O. K. OLMSTEAD, Orleans, Nehr.
 Dear Sirs:—The Sections arrived in due time, and are all O. K. so far as examined. They are simply perfection. I can't see how you can furnish such goods at such low prices. I hope you may live long and do well. Yours respectfully, Z. S. WEAVER, Courtney, Tex.
 Gents:—I received the "Higginsville Smoker" all O. K. It's a dandy; please find enclosed stamps for another. Yours truly, OTTO ENDERS, Oswegatche, N. Y.
 Gentlemen:—I have bought Supplies from nearly all the large manufacturers by the carload, and I must say yours are as good as the best. Indeed, in many lines they are the best. It is a pleasure to handle them. E. T. FLANAGAN, Belleville, Illinois.
 The above unsolicited testimonials are a fair sample of hundreds we receive.
 Our prices are reasonable and the "Higginsville Goods" are the best.
 The "Higginsville" Goods are for sale by the following parties:
 Chas. H. Thies, Steelville, Ill. E. T. Flanagan, Belleville, Ill.
 Henry L. Miller, Topeka, Kans. E. A. Seelye, Bloomer, Arkansas.
 J. W. Rouse & Co., Mexico, Mo. P. J. Thomas, Fredonia, Kans.
 And by a number of others.
 If you need a Carload of Supplies, or only a Bee-Smoker, write to us. Remember, we are here to serve you, and will, if you give us a chance. **A Beautiful Catalogue Free.**
 Address, **LEAHY MANUFACTURING CO., HIGGINSVILLE, MO.**
 49A *Mention the American Bee Journal.*

General Items.

Large Yields of Honey.

On page 44 is published a list of large yields of honey. While I have never kept a strict account of all my bees any season, I have kept an account of a few of the best. In 1894 I got from my five best colonies 1,500 pounds of extracted honey, getting a little over 400 pounds from the best single colony. This count was commenced in the early part of June, after I had divided my bees and strengthened them up for the honey-flow. In 1895 this same colony I divided, getting three new swarms and 400 pounds of honey from the whole. In the spring of 1895 they were the first to fill the hive to overflow, so I commenced dividing them up, manipulating to the best advantage until I obtained six new swarms and a little over 500 pounds of honey, but we could only call them one colony, spring count; but then they are what Mr. S. M. Broyles (see page 78) calls "Mormon bees," but they are rustlers, I tell you. They are leather-colored, and "up to date."
 Salt Lake City, Utah. E. S. LOVESTY.

It Pays to Care for Bees.

The honey-flow the past season was good. Those who had strong colonies secured a good crop of honey, and those that did not look after them received a small crop, and they wonder why they did not get as good a crop as those who looked after them. They think that they must get as much without taking any care of the bees as those who take care of them.

It is just the same with bees as with cows, horses or sheep—if you don't take care of them you won't receive anything from them. If bee-keepers would take care of their bees just half as well as they do their other stock, they would get something from them, but no, they think they must go it without any care, and bring in lots of honey. Such people you can never get to read a paper or take one. If they would read the valuable American Bee Journal, they would see why they did not get better returns.
 E. Blackstone, Mass. A. T. BALL.

Honey-Clovers & Buckwheat SEED FOR SALE.

We have made arrangements so that we can furnish seed of several of the Clovers and Japanese Buckwheat, by freight or express, at the following prices, cash with order:

	5lb	10lb	25lb	50lb
Alsike Clover	\$.80	\$1.35	\$3.50	\$ 6.25
Sweet Clover	1.10	1.80	4.25	8.00
White Clover	1.50	2.40	6.00	11.00
Alfalfa Clover	.75	1.20	3.00	5.25
Crimson Clover	.65	1.00	2.50	4.00
Jap. Buckwheat	.30	.45	1.00	1.50

Prices subject to market changes.
 The above prices include a good, new 25-cent two-bushel bag with each order. Add 25 cents to your order, for cartage, if wanted by freight.
 Your orders are solicited.
GEORGE W. YORK & CO.,
 CHICAGO, ILLS.



ONE MAN WITH THE UNION COMBINATION SAW
 Can do the work of four men using hand tools, in Rippling, Cutting-off, Mitring, Rabbiting, Grooving, Gaining, Dadoing, Edging-up Jointing Stuff, etc. Full Line of Foot and Hand Power Machinery Sold on Trial. Catalogue Free.
SENECA FALLS MFG. CO.,
 46 Water St., SENECA FALLS, N. Y.
 1A1y *Mention the American Bee Journal.*

SECTIONS
 \$1.50 a M. 3 M, \$4.25.
 These ARE NOT Seconds, but perfect Sections. As they are not up to our present high standard, we wish to close them out. Sample free. Widths—7 to 10 in., 15-16 in., and 2 in.
Catalog of Bees & Supplies FREE.
I. J. STRINGHAM,
 105 Park Place. NEW YORK, N. Y.

A Correction.

In the report with my signature on page 107, I was referring to Mr. J. Z. Rhodes, of Verdale. I think he must have made a mistake; if not, he has done better than the writer, who has kept bees here for the last 20 years. Having spent the summer in Oregon, I did not keep any last season, but I shall try it again here in cold Minnesota, but it is away ahead of the Coast as regard bees and honey, and many other things. As one writer said, speaking of Texas as a bee State—All that was lacking was plenty of rain and good society. That strikes any arid country. M. S. SNOW.
 Osakis, Minn., Feb. 13.

Dummies and Rats.

Mr. Editor:—On page 143, in my reply to the Query 6, as to "Single or Double Brood-Chambers for 12 Frames," the printer sets off my answer at a tangent. One wrong letter does much mischief, and the word it ends, being a brand new one, the reader would not be apt to supply the right letter to make the new word. As Dr. Miller, yourself and others, were going ahead at a great rate coining new words in Apicultural Nomenclature, I thought I had as good a right as anybody to coin one, and so I coined one, but it had to come to grief before it saw the light.
 The querist wanted to know whether it was best to have his 12 frames in a single hive or in "two 8-frame hives, filling up the vacancy with dummies." The last sentence of my reply was: "If you must have 12 frames or more in the brood-cham-

MOVED TO LARGER QUARTERS!

In order to take care of the business properly at this Branch, we have moved to 118 Michigan St., [3rd Floor], within two blocks of the Northwestern Passenger station, where we've secured larger quarters, making ample room for a Full Assortment. Send along your orders, remembering that we guarantee satisfaction, and at prices as low as the best quality of Goods can be furnished for. **Special Prices** on a lot of Stock we are closing out. Send for CATALOG and a List of Goods at Special Prices.
 In order to close them out quickly we offer some good Sections, for the next 30 days, or while they last, at these special prices:
White Sections, 4 1/2 x 4 1/4.
 25,000 7-to-ft. at these low prices—1,000 for \$1.75; 2,000 for \$3.00; 5,000 for \$7.00
TRIANGULAR-TOP FRAMES.
 We also have a stock of Triangular Top Langstroth Frames at these Special prices:
 100 for \$1.00; 300, \$2.70; 500, \$4.00; 1000, \$7.00.
 On all freight orders of \$5 or less, at this Branch, please add 25c. for cartage. Catalogue Free.
The A. I. ROOT CO., 118 Michigan St., CHICAGO, ILL.
 Geo. W. York, Mgr. *Please mention the American Bee Journal.*

MUTH'S HONEY EXTRACTOR
 PERFECTION
 Cold-Blast Smokers,
 Square Glass Honey Jars, Etc.
 For Circulars, apply to CHAS. F. MUTH & SON, Cor. Freeman & Central Aves., Cincinnati, O. Send 10c for Practical Hints to Bee-Keepers.

A Bargain—EARLY QUEENS.
 119 Colonies Italian Bees in Chaff Hives: two acres land; good house; excellent well.
Early Queens—Tested. \$1.50; Untested, 75c.
 11A4t **E. L. CARRINGTON,**
 PETTUS, Bee Co., TEX.

BUY "DIRECT FROM FACTORY," BEST MIXED PAINTS

At WHOLESALE PRICES, Delivered FREE For Houses, Barns, Roofs, all colors, and SAVE Dealers profits. In use 54 years. Endorsed by Grange & Farmers' Alliance. Low prices will surprise you. Write for Samples, O. W. INGERSOLL, 289 Plymouth St., Brooklyn, N. Y.

Mention the American Bee Journal.

MURDERED

We have killed high prices. Give me a trial order and be convinced that good Queens can be reared for 50 cts. each. Untested, 50 cts.; Tested, 75 cts. Golden Italians, 3-Banded Italians, and Silver-Gray Carniolans, all the same price. Best of References given.

C. B. BANKSTON,

13Atf CHRISMAN, Burleson Co., TEX.

Mention the American Bee Journal.

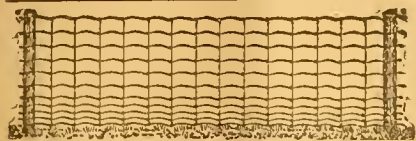

BRITISH GOLD COMING BACK

On Feb. 17th we received an order from an English Railway for another ten miles of fence, also a remittance in £ s. d. for the last ten miles. This third order proves that the favorite American fence suits the Englishman also.

FACE WOVEN WIRE FENCE CO., Adrian, Mich.

WHEN ANSWERING THIS ADVERTISEMENT, MENTION THIS JOURNAL.

Better than 10% Discount!

By comparing the following with the customary prices of Foundation they will be found to be better than a 10% discount. Prices are f. o. b., cut to any size.

COMB FOUNDATION.

Table with 4 columns: Weight (1lb, 5lb, 10lb, 25lb) and Price (45c, 42c, 40c, 38c for Heavy or Medium; 45c, 44c, 42c, 40c for Light; 50c, 49c, 47c, 45c for Thin; 55c, 54c, 52c, 50c for Extra Thin).

Samples Free. Watch this advertisement for changes. Better buy now, before prices advance. BEE SWAX—30c cash, 32c trade, delivered. HIVES, SECTIONS, SMOKERS, ETC., always in stock. PRICES are right. Order before the rush.

W. J. FINCH, JR., SPRINGFIELD, ILLS.

Mention the American Bee Journal.

Advertisement for a Successful Incubator, featuring an illustration of the device and text describing its features and availability.

Mention the American Bee Journal.

California

If you care to know of its Fruits, Flowers Climate or Resources, send for a Sample Copy of California's Favorite Paper—

The Pacific Rural Press

The leading Horticultural and Agricultural paper of the Pacific Coast. Published weekly, handsomely illustrated, \$2.00 per annum. Sample Copy Free.

PACIFIC RURAL PRESS,

220 Market St., - SAN FRANCISCO, CAL.

TEXAS QUEENS.

If you are in need of Queens, let me have your order. Price-List Free.

J. D. GIVENS, Lisbon, Tex.

Mention the American Bee Journal.

ber, I would advise the double 8 duly dummied." Now, so far as I know, I am the father of that last word—dummied—but the printer put an "s" in the place of the last d, and so spoiled both word and sentence.

I now come to Rats. If any reader of the Bee Journal knows how to circumvent rats that are too cute to eat poison of any kind, no matter how it is mixed, or go into any trap, no matter how it is set, that is the man or brother I wish to hear from (through this journal) right away. Let Dr. Miller, who answers all sorts of questions, speak; but he must keep back that "Don't know." Let anybody and everybody speak who has a plan. Never mind telling me about cats as traps—I know all about that—but have no cats.

Selby, Ont. ALLEN PRINGLE.

[If Mr. Pringle knew how we studied over that new word "dummied," and from his writing couldn't possibly make anything but the old "dummies" out of it, he'd have some sympathy for us. When a word is coined, it should stand out new, bright and plain, then even such mortals as editors wouldn't stumble over it, and get all "dummied" up. We'll try, in the future, to look out for new words when they are "fired" at us, for we know how exasperating it is to have new things spoiled.—Ed.]

Gathering Pollen.

My bees are building up nicely. The weather is fine, and bees loaded with pollen are coming in. I started brood early in January by feeding corn meal, and on Jan. 10 I noticed the first load of natural pollen come in. I had one colony that was short on stores; I fed them by filling both sides of the combs with honey. A colony near by robbed them, and they made no effort to protect their stores. The robber colony was so strong that they cleaned them out in one day, so I removed the hive that had been robbed, and put the bees into another hive, and gave them frames of sealed honey. They now defend themselves, and are doing nicely. I left them 50 feet from their old stand. The queen I found on the hive-cover on Dec. 24, that I mentioned in the American Bee Journal, has left the hive again, and I have failed to find her, as she failed to return this time.

Waring, Tex., Feb. 14. SUBSCRIBER.

Wintering Bees.

I think my way of wintering bees has proved as satisfactory as any. I built my bee-house in the fall of 1892, and I put in 65 colonies, some of them being nuclei. I put them in Nov. 24, 1892, and took out 63 colonies April 8, 1893. It was a poor year in our section for surplus honey; the increase for 1893 was to 95 old and young colonies, which I sold down to 89 colonies; these I put into the bee-house Nov. 25, and took out 89 April 17 and 18, 1894, without any loss.

It was a poor year here in 1894 for surplus honey—had only about 500 pounds of salable honey, and increased to 155 colonies. In the fall I shook the bees out of 13 heavy colonies, which left me 142, which I put into the bee-house Nov. 26, and in April, 1895, I took out 141 in good condition, the one dying for want of honey. I put on some sections May 8, which the bees took hold of in good earnest—they put as high as 15 to 20 pounds in some of the supers, and on May 11 it was dark and lowry, on the 12th cold and snowy, and at night it froze the ground one inch or more on the beet beds in the garden. This put a damper on honey-gathering, for the white clover, Alsike and raspberry were past commencing to bloom; they were frozen black as could be, and it froze all the young growth on basswood, so I do not think there was a basswood bloom in our town. There was no honey coming in for some time, until white clover and white daisy sprouted again; by this time the bees had consumed most of the honey

they had stored, and what they had in the hive. I had to put in some frames of honey to supply their wants.

I sold 50 colonies the day after the freeze, and traded others for work, and so reduced my bees down to about 84 colonies. My first swarms for 1895 were on May 29 and 31. Bees did not store any surplus honey to speak of, only 800 or 900 pounds from 84 colonies, spring count. They increased to 110 colonies and 10 nuclei, which I put into the bee-house Nov. 37, most of them being very heavy with honey, but I think not as heavy with bees as they should be, on account of the long spell of dry weather that we had, and no fall flowers for the bees to work on so as to keep up breeding.

Our home market for honey is only 8 cents per pound, and slow sale at that. I have not seen a section of white honey in our vicinity that was stored in 1895. Our surplus honey was mostly from buckwheat, with the exception of the first that was amber in color. I think one thing our poor seasons here are due to, is that there are too many bees kept for the territory they occupy; there are nearly 300 colonies besides mine within a radius of 4 miles around my bee-yard.

My bees seem to be wintering finely so far, and I am looking forward to the season of 1896 to be a good one for honey.

ANDREW M. THOMPSON, Canaseraga, N. Y., Jan. 29.

Wintering Well.

Bees seem to winter well, better so far than usual. The weather is warm for this time of year—50 degrees above to-day. We have had only three or four days of sleighing this winter, and but little snow is left.

C. THELMANN, Theilmanton, Minn., Feb. 23.

Wintering Nicely.

I started last spring with two colonies, increased to six, and got 65 pounds of comb honey, mostly buckwheat. There was not much early honey on account of the frosts. My bees had their last flight Jan. 18, and are wintering nicely.

HERBERT C. TOWLE, Northwood Narrows, N. H., Feb. 20.

Sweet Clover in Texas.

I have 10 acres of sweet clover now sown, and will sow 5 acres more next week. I think I will have sweet clover honey another year. I have had from one to two acres of sweet clover for the past four years. It is a perfect success here, and bees work on it with great vigor; but I have never had any pure sweet clover honey.

J. D. GIVENS, Lisbon, Tex.

Sweet Clover Honey in Colorado.

I was surprised when I read the article on page 78, by S. M. Carlsen, in regard to sweet clover honey. He says: "Here in Colorado we despise it, because it spoils the sale of our alfalfa honey, if mixed." My experience is just the reverse. The beekeepers here prize sweet clover above all other plants, both for the quality and quantity produced.

I have produced thousands of pounds of both alfalfa and sweet clover honey, as well as a mixture of the two. I have sold honey all over this corner of Colorado, and have never had any honey rated as anything but first-class. When people have a preference it is always for the sweet clover.

At our altitude (7,000 feet) our alfalfa begins to bloom the first week in July. For three weeks we have pure alfalfa honey. About the last week in July the sweet clover comes in, and we get a mixture for about two or three weeks. Then the alfalfa in waste-places dries up, the first cutting of alfalfa is all up, the second has not bloomed, and we have absolutely no other plant in bloom but sweet clover. We count on our

Say, Please Bother Jumbo for Copy of
That Practical Beautiful Jocose Paper,
The PACIFIC BEE JOURNAL.

—BEE-KEEPING IN—

CALIFORNIA, OREGON, WASHINGTON, NEVADA,
IDAHO, UTAH, ARIZONA, COLORADO.

All Easterners should keep in "touch"
on the "LAND OF SUNSHINE"—the **COMING BEE-LAND.**

Address, **PACIFIC BEE-JOURNAL.**
365 East Second Street, LOS ANGELES, CALIF.

best comb honey during the time that the honey is pure sweet clover, as it is whiter and thicker, and has a flavor that is not excelled by any.

Isn't it possible that Mr. Carlzen has some weed in his neighborhood that spoils his sweet clover honey?

There has been a strong prejudice here against the plant, as it takes possession of ditches and fence-corners and every waste nook. Some of the farmers have tried making hay of it, and those who cut it at the proper time found that stock would eat it in preference to alfalfa. Those who put it up after it got woody and strong, declare that it is a bad weed, and that we ought to have a law compelling people to exterminate the pest. So it seems there is a difference of opinion about it outside of the quality of its honey.

Mancos, Colo. MRS. A. J. BARBER.

Bees in Good Condition.

Beautiful day, this. Bees are out having a jollification, all in apparently good condition.

JAS. W. WILLIAMS.
Appleton City, Mo., Feb. 16.

Report for 1895.

I have 40 colonies on the summer stands, packed on top with dry leaves. I think they are wintering nicely. I got 900 pounds of nice comb honey last season. I have kept bees 30 years, and think they pay when properly cared for.

S. M. COX.
Angola, Ind., Feb. 19.

Bee-Keeping in West Virginia.

My bees are on the summer stands, and have been wintering very well. At this time they are very strong. I had 82 colonies that went into winter quarters; most of them were in good condition. Bees swarmed very much here last summer, some colonies swarming as many as two or three times, which kept the parent colony from storing much surplus honey, but there was a good sugar tree, basswood and tulip or whitewood bloom here, and bees did well. A great many swarms went to the woods.

J. C. WILLIAMSON.
Williamson, W. Va., Feb. 15.

Leather-Colored Italians, Etc.

Referring to Dr. Miller's comment on my article on page 29, in regard to non-swarming bees, I may say that I am not a large bee-keeper, my average being from 5 to 10 colonies, as I have not time to attend to many. Of course, if I kept a large number I have no doubt I would have some swarms, as I do not claim that my bees are any different from others of their kind; they are what are called "leather-colored Italians," but I might say here that they are not like the Italians I had at one time, away back in 1870—when the drones and bees were out in full force it was like a shower of gold in front of the hive.

Now for the size of the hive I use: It is 18 inches long, 12 inches deep, and 12 $\frac{1}{2}$ inches wide inside, with 12 frames placed across the hive. I like them better than the frames lengthwise, as I find them handier for extracting, which I do alto-

gether, as it pays me better than comb honey. The supers are the same as the hive, and are interchangeable, and if the queen happens to go up and fill 4 or 5 frames, as she sometimes does, they come in handy to start a nucleus, giving it the queen, letting the old colony rear another.

I have no doubt if I went in for producing comb honey, I might want a different hive, and would probably have the same trouble with swarming as many others seem to have.

JNO. MCKIMMIE.
Niagara, Ont.

Not a Cold Winter.

This has not been a very cold winter here so far, but the bees have not had a chance to fly since Nov. 20.

I would like to correspond with some of the readers of the American Bee Journal living in the State of Washington, on the west side of the mountains.

Luce, Mich., Feb. 13. WM. CRAIG.

Prospects in Washington.

We have just had three days of freezing, down to 20 degrees above zero, which is quite an extreme for us to have, especially at this time of the year. So far we have had fine weather, and it is fine now except it is cold. Our gardens are in fine shape. Roses had a 1 $\frac{1}{2}$ inch growth on them March 1, but to-day is a little warmer, and I expect to-morrow the ground will be soft again. Bees have been bringing in pollen since Jan. 15; usually they commence about Feb. 20. Clover is coming up finely all around.

G. D. LITTOOY.
Tacoma, Wash., March 3.

Bee-Keeping in Arkansas.

I commenced in the spring of 1895 with 50 good colonies and 40 nuclei. From all that were in good condition I got about 100 pounds to the colony, all comb honey in one-pound sections. My honey was all gathered in the month of May. It rained the month of June, but we didn't get any basswood honey last year. Our basswood commences blooming about June 10, so our crop was from holly, black-gum and ratan. I missed a fall crop for the first time in 10 years, as it was so dry here that the peas and mint did not yield any nectar.

I closed the season with 120 colonies. My honey netted 10 cents a pound in my home market.

We have had a nice winter—the temperature has gone down to 14 degrees above zero only twice, with an average of 44 degrees through January and February.

My golden Italians are in the lead with the 3-banded or Carniolans.

Ozan, Ark., Feb. 12. J. W. TAYLOR.

Answers to Some Questions.

Dr. Miller calls me out again on page 73, to answer questions, which I will try to do. I can tell only on an average (but that's all), as I only worked with the bees after coming from work after 5 o'clock.

In June the average was about 10 frames; August, from 13 to 14 frames in all of them. This brood was in the two lower stories. Occasionally some greedy queen would lay

MILLIONS OF DOLLARS
SAVED ANNUALLY BY
FRUIT CROVERS using
Deming SPRAYING Outfits
Recommended by leading Horticulturists.
32 page illustrated catalogue and treatise FREE
The Deming Co., Mfrs., Salem, Ohio.
Henton & Hubbell, Gen'l West. Ag'ts, Chicago.
Mention the American Bee Journal.

The Patent Wood-Veneer Foundation.

Bee-keepers should give it a test, and my All-Wax Foundation. I will guarantee there is no better made. Now is the time to send wax to be worked up. Send for Samples and Catalogue with low prices. Wax wanted at 30c cash.

AUG. WEISS, Hortonville, Wis.
12A13t Please mention the Bee Journal.

Mention the American Bee Journal.

POULTRY
40 Standard Breeds Illustrated & fully described in my new Poultry Book. Reliable information for poultrymen & intending buyers. Good stock Ducks & Geese; also Shetland Ponies. Send 6c in stamps
E. E. COOK, Box 27, Huntley, Ill.



Mention the American Bee Journal. 4A13t

IF YOU WANT THE

BEE-BOOK

That covers the whole Apicultural Field more completely than any other published, send \$1.25 to Prof. A. J. Cook, Claremont, Calif., for his

Bee-Keeper's Guide.

Liberal Discounts to the Trade.

NEW MAMMOTH POULTRY GUIDE showing colored plate of chickens in natural colors. Finest book ever published. Almost 100 pages. Tells all about Poultry for Profit or Pleasure. Price only 15c.
JOHN BAUSCHER, JR., Box 94 Freeport, Ill.
12A7t Mention the American Bee Journal.



TAKE NOTICE!

BEFORE placing your orders for SUPPLIES, write for prices on 1-Piece Basswood Sections, Bee-Hives, Shipping-Crates, Frames, Foundation, Smokers, etc.

PAGE & LYON MFG. CO.

NEW LONDON, WIS.

WHEN ANSWERING THIS ADVERTISEMENT, MENTION THIS JOURNAL.

Promptness Is What Counts!
Honey-Jars, Shipping-Cases, and everything that bee-keepers use. **Root's Goods at Root's Prices**, and the best shipping put in the country.
Dealer in Honey and Beeswax. Catalogue Free.
Walter S. Ponder
162 Mass. Ave.
INDIANAPOLIS, IND.
Mention the American Bee Journal.



PATENT WIRED COMB FOUNDATION

Has No Sag in Brood-Frames

Thin Flat-Bottom Foundation

Has No Fishbone in the Surplus Honey.

Being the cleanest is usually worked the quickest of any Foundation made

J. VAN DEUSEN & SONS,

Sole Manufacturers,
Sprout Brook Montgomery Co., N. Y.

Mention the American Bee Journal

New England Supply Depot!

You can get the most complete Bee-Hive, also other Supplies, at—**H. ALLEYS,**
Room 5, 82 Water St., - BOSTON, MASS.

13Dtf Mention the American Bee Journal.

in the third story, obliging me to place it down and put an outside comb from the lower story in its place. Bee-zinc would prevent this trouble, but to my notion this is not nearly so much work for me as crawling through the zinc for the bees. Then I do not believe that more than one out of ten will want more than two stories to lay and rear brood in. Two of them swarmed very much, and both at the same time. Old queens proved to be the cause, or at least seemed to be.

E. St. Louis, Ill. H. E. LEVELING.

Wintering All Right.

Bees were wintering all right in the cellar in this vicinity up to Feb. 18. I have 36 colonies in good condition, and if we can have some rain in May we may have some clover honey. We had a lot of rain before Christmas, and there is about 10 inches of snow now, with very cold weather. There are about 100 acres of Alsike clover within one mile of my apiary. I did not get any clover honey in 1895—it was too dry in the spring. I got 2,500 pounds last year, mostly from buckwheat and black-beard weed. I am sowing sweet clover along the roadside and on waste-places, for I think it is the best honey-plant I have.

I have taken the American Bee Journal ever since I began to keep bees (four years), and would not get along without it if it cost \$2.00 a year.

JACOB WIRTH.
Rickel, Ills., Feb. 21.

Feeding Bees—Bees Starved.

February was a nice month, warm and springlike here. The bees could fly and eat whenever they felt like it, and I rather guess they worked too hard at it, for there are lots of them that will fly no more. Out of 35 colonies there are only 24 left, and I have been feeding all the syrup they would take the last week of February. I fed in the open air; 10 pounds of granulated sugar, 10 pounds of boiling water; put the sugar into a tin pail, pour in the water, and stir with the mush-paddle until all is dissolved, then set away to cool. When lukewarm pour into milk-pans, or bread-pans, or any shallow vessel, and cover with cheese-cloth, and set out in the apiary. If you do not have the cheese-cloth, fill with clean corn-cobs, then pour in your syrup.

February 28 and 29 the bees worked strong on soft-maple bloom. March 1 was cloudy and cold; the 2nd cloudy and colder; the 3rd it snowed until noon, and is still cloudy and cold.

There have been more bees that died of starvation this winter than I ever knew in one winter before.

J. C. BALCH.
Bronson, Kans., March 3.

Crimson Clover Growing.

I have seen Dr. Miller's comment on page 98, in regard to what I said on page 78 about my 4 acres of crimson clover. The piece is apart of a 6-acre field that I intended to sow to buckwheat next season, so it will not be disturbed until time to sow buckwheat. By that time it will show plainly whether it is going to be worth leaving or not. If it is, I will leave it for the seed to ripen; if not, I will plow it up and sow to buckwheat, as originally intended.

My idea was that if it was sowed in the fall, and blossomed in May, as they tell about, I could get the crop off (or plow it under for a fertilizer) in time to sow a crop of buckwheat, and thereby improve the land and still not miss a crop. If crimson clover will work here as they tell about, it is just what I want. The blossoms for the bees, the clover as a fertilizer, followed with buckwheat for the bees, and still get a crop off the land; and if this piece should be a failure, I will try again, but next time I will know more about when to sow it, as I have a brother-in-law that is foreman at our State Experiment Station, and he

That Queen-Clipping Device Free!

PLEASE READ THE FOLLOWING OFFER:

We have arranged with the inventor of the new Queen-Clipping Device (Mr. Montette), to offer it to our present subscribers as a Premium for getting NEW subscribers. Send us just one new name for the American Bee Journal a year (with \$1.00), and we will mail you the Queen-Clipping Device FREE; and will also send a copy of Newman's 160-page book—"Bees and Honey"—to the new subscriber. Or, the Queen-Clipping Device will be sent postpaid for 50 cts. But why not get it as a Premium by the above offer? You can't earn 50 cts. any easier. Almost every bee-keeper will want this Device. See page 130 (Feb. 27) for full description of it. Complete directions accompany each one sent out. It is a most ingenious and useful article. Address,

GEORGE W. YORK & CO., 118 Michigan St., Chicago, Ill.

ORIGINAL BINGHAM SMOKERS

Wonderful Record!

HAVE LASTED 17 YEARS.

—BEST ON EARTH.

Always Give Perfect Satisfaction.

My cool Wire Handle and Bent Nose were patented 1892, are the original, my best invention since my open or direct draft Patent, 1878, that revolutionized Bee-Smokers. My Handle and Nose Patent bent all the other smoker noses. None but Bingham Smokers have all the best improvements. If you buy genuine Bingham Smokers and Honey-Knives you will never regret it. The "Doctor," 1/2-inch larger than any other smoker on the market—3/4-inch stove, by mail, \$1.50

Conqueror, 3"	1.10
Large, 2 1/4-in.	1.00
Plain, 2-in.	.70
Little Wonder, 2-in., wt. 10 oz.	.60

Bingham & Hetherington Honey-Knives, 80 cents.

T. F. BINGHAM, Farwell, Mich.
7Atf Mention the Bee Journal.

BEGINNERS.

Beginners should have a copy of "the Amateur Bee-keeper, a 70-page book by Prof. J. W. Rouse. Price 25 cents; if sent by mail, 28c. The little book and the Progressive Bee-keeper (a live, progressive 28-page monthly journal) one year, 65c. Address any first-class dealer, or

LEAHY MFG. CO., Higginsville, Mo.

Dadant's Foundation in Chicago!

No other Goods kept there.

Send for Price-List.

CHAS. DADANT & SON,
118 Michigan St., CHICAGO, ILL.
13Atf Please mention the Bee Journal.

CHEPER THAN EVER!

Hilton's White T Supers
Chaff Polished Foundation
Hives Sections Smokers

And everything needed in the apiary.

1896 Catalog of 36 pages free.

GEO. E. HILTON,
13Atf FREMONT, MICH.
Mention the American Bee Journal.

HATCH Chickens BY STEAM—
With the **MODEL EXCELSIOR Incubator**

Simple, Perfect, Self-Regulating. Thousands in successful operation. Lowest priced first-class hatcher made.

GEO. H. STUBB,
111 to 122 S. 6th St. Quincy, Ill.

Circulars free. Send for this Catalogue.

Mention the American Bee Journal.

Honey & Beeswax Market Quotations.

CHICAGO, ILL., Mar. 20.—White clover and basswood comb is sought after in preference to any other, and commands a better price and now sells at 15c. for clover and 13@14c. for basswood. Other white comb honey sells at 11@12c.; dark, 8@9c. amber, 9@10c., and very slow of sale. Extracted is unusually dull, with large amounts on sale. White clover and Linden, 6@7c.; dark and amber grades, 4 1/2@5c.

Beeswax, 28@30c. R. A. B. & Co.

KANSAS CITY, Mo., Mar. 18.—The demand for comb and extracted is fair. We quote: No. 1 white, 1-lbs. 13@14c.; No. 2, 10@11c.; No. 1 amber, 11@12c.; No. 2, 8@10c. Extracted, white, 5 1/2@6c.; amber, 5@5 1/2c.

Beeswax, 20@22c. C. C. C. & Co.

CINCINNATI, O., Mar. 19.—Demand is fair for best white comb honey, at 12@14c. in a jobbing way. Extracted is fair at 4@7c. Supplies of both are fair.

Beeswax is in good demand at 25@30c. for good to choice yellow. Arrivals are not adequate to the demand.

C. F. M. & S.

PHILADELPHIA, Pa., Mar. 6.—Honey has been selling freely, there being considerable call for comb honey, and the war in Cuba has made extracted honey sell to the baking trade who previously used Cuba honey. We quote: Fancy comb, 15c.; fair to good, 11@13.; fair, 9c. Extracted, 4 1/2@5 1/2c.; pure white clover, 10c. Beeswax, 30c. W. A. S.

NEW YORK, N. Y., Feb. 24.—Market quiet. White comb in fair demand at 11@14c. Very little demand for buckwheat comb at 8@9c. Extracted selling fairly well, principally California, at 5 1/2@5 3/4c., and some buckwheat moving at 4@4 1/2c.; Southern, 5@5 1/2c. per gallon; white clover and basswood, 5 1/2@6c.

Beeswax unchanged. H. B. & S.

List of Honey and Beeswax Dealers.

Most of whom Quote in this Journal.

- Chicago, Ills.**
R. A. BURNETT & Co., 163 South Water Street.
- New York, N. Y.**
HILDRETH BROS. & SEGELKEN,
120 & 122 West Broadway.
- CHAS. ISRAEL & BROS., 486 Canal St.
- Kansas City, Mo.**
O. C. CLEMOMS & Co., 423 Walnut St.
- Buffalo, N. Y.**
BATTERSON & Co., 167 & 169 Scott St.
- Hamilton, Ills.**
CHAS. DADANT & SON.
- Philadelphia, Pa.**
WM. A. SELSER, 10 Vine St.
- Cincinnati, Ohio.**
C. F. MUTH & SON, cor. Freeman & Central avs.

Bee-keepers' Photograph.—We have now on hand a limited number of excellent photographs of prominent bee-keepers—a number of pictures on one card. The likeness of 49 of them are shown on one of the photographs, and 121 on the other. We will send them, postpaid, for 50 cents each, mailing from the 121 kind first; then after they are all gone, we will send the 49 kind. So those who order first will get the most "faces" for their money. Send orders to the Bee Journal office.

\$3.00 Worth for \$2.00 !

Until further notice, we propose to give you a chance to get so ne good reading-matter for the long winter evenings, at **half price**.

Send us \$2.00, and we will mail you your choice of \$2.00 worth of the following book-lets, and also credit your subscription to the American Bee Journal for one year:

- Poultry for Market and Profit..... 25c
- Our Poultry Doctor..... 30c
- Turkeys for Market and Profit..... 25c
- Capons and Caponizing 30c
- Rural Life..... 25c
- Preparation of Honey for the Market. 10c
- Bee-Pasturage a Necessity..... 10c
- Hive 1 Use, by Doolittle..... 5c
- Foul Brood, by Dr. Howard..... 25c
- Foul Brood, by Kohnke..... 25c
- Foul Brood, by Cheshire..... 10c
- Bee-Keeping for Profit, by Dr. Tinker... 25c
- Kendall's Horse-Book—Eng. or German... 25c
- Silo and Silage, by Prof. Cook..... 25c
- Hand-Book of Health, by Dr. Foote..... 25c
- Maple Sugar and the Sugar Bush..... 35c
- Potato Culture, by Terry..... 40c
- Carp Culture, by Root & Finney..... 40c
- Strawberry Culture, by Terry & Root... 40c
- Bleccn Kultur, by Newman [German]... 40c
- Winter Problem in Bee-Keeping [Pierce]. 50c
- Bee-Keepers' Directory, by Henry Alley. 50c
- Advanced Bee-Culture, by Hutchenius... 50c
- 5 Honey as Food and Medicine..... 25c

GEORGE W. YORK & CO.,
CHICAGO, ILLS.

HONEY We have a large amount of Pure No. 1 Alfalfa we will sell cheap.
SEED Of those great honey-producing plants —Alfalfa and Cleome or Rocky Mountain Honey-Plant. Alfalfa seed at 7 cts. a lb.

Boss bee-escape Warranted the best, simplest and quickest Escape on the market. Sent postpaid to any address for 50 cts. It can be returned at our expense if it is not as represented, or we will send the Escape on trial to any bee-keeper wishing to test it in good faith. We are agents for the **Ferguson Patent Hive** with double-case Super and Wicket-Gate Honey-Board, with the Escape. It is the easiest, quickest hive to handle for the production of comb honey. Address,

E. S. LOVESY & CO.,
355 6th East St., SALT LAKE CITY, UTAH.
Mention the American Bee Journal. 9Atf

Willow-Herb, White Sage, Basswood EXTRACTED HONEY —For Sale.—

We have made arrangements whereby we furnish **Willow-Herb or White Sage Extracted Honey**, in 60-pound tin cans, on board cars in Chicago, at these prices: 1 can, n a case, 8 cents per pound; 2 cans in one case, 7½ cents.

The Basswood Honey is all in kegs holding 170 pounds, net. It is a very superior quality, and the prices are: 1 keg, 8½ cents per pound; 2 kegs or more, 8 cents.
Cash MUST accompany each order.

A sample of either kind of honey will be mailed to an intending purchaser, for 10 cents, to cover postage, packing, etc. We guarantee purity, and that what we ship will be equal to sample.

GEORGE W. YORK & CO.,
CHICAGO, ILLS.

Convention Notices.

TEXAS.—The Texas State Bee-Keepers' convention will be held on April 1 and 2, 1896. All bee-keepers are invited.
L. Blossom, Tex. W. H. WHITE, Sec.

UTAH.—The Utah Bee-Keepers' Association will hold their semi-annual meeting in Room 54, City and County Building, Salt Lake City, Apr. 6, 1896, at 10 a.m. All are invited. "In union is strength. By industry we thrive." Come, and bring your friends, and enjoy a good time. A full program in the interest of the industry will be presented. The Association needs your aid; then let every one do his full duty for our own interest and self-preservation.
Geo. E. DUDLEY, Sec.

Provo, Utah.

sowed a little piece of crimson clover every month last season to test it.

If I have any success with the clover, or discover anything about it that I think would be of any interest to the bee-keeping fraternity, I will report it.

SCOTT LAMONT.

Jarret, Minn., Feb. 25.

Another House-Apiary, Etc.

I have been a reader of the "Old Reliable" two years, and would not think of trying to get along without it. I have 26 colonies of bees, wintering in the cellar. I have a two-inch cold-air pipe, and all are in fine condition. I keep them in a building throughout the gathering season. My building is a copy of H. P. Langdon's, of New York, with two exceptions, viz.: mine is one foot wider, and instead of a board floor, I filled within the walls stones, covering them nicely with coarse sand. I can walk about or work at anything, and do not jar the hives in the least. Everything is handy, and what a comfort it is, indeed, to care for them in this way! One can perform the work for four times as many colonies in the same time as when kept out-of-doors, and surely more honey is secured.

I nearly forgot to mention that I use this building for poultry in the winter, and in the spring, after having cleaned and purified this sand floor, no one can tell that the fowls had ever been inside of it, for no roosts or nests are near enough to the building so that it could in any way be soiled.

The building cost \$50, is 12x25 feet, nicely made, within 2 rods of our house, thus making it very handy in both winter and summer. I have had poultry in it this makes the second winter; the first winter I sold \$28.90 worth of eggs, and I will do as well this winter. My bees occupied it last summer, for the first time. My crop of honey was 1,089 pounds in one-pound sections, and sold at 15 cents. S. E. ROOP.
Fertile, Iowa, Feb. 21.

Bees in Fine Condition.

The prospects here for a honey crop are very poor, as we have had less rain so far than any other year since I have been in the State, which is seven years. Bees are generally in fine condition.

F. C. WIGGINS.

San Diego, Calif., Feb. 15.

Bees Had a Joyful Time.

This has been a beautiful day, the mercury at sunrise being 29 degrees above zero; at 10 a. m., 42 degrees; in the shade at noon, 45 degrees, and in the sun, 55 degrees. My bees had what I call a "melee;" they were out in full force—every hive seemed to send out a joyful anthem, as they have not had such a flight since last November. My bees were on the summer stands packed in chaff, outside cases. I use the 10-frame hive. When they swarm it means bees, but my 8-frame hives gives small swarms, and not many left at home to keep house.

Iouia, Mich., Feb. 26. JACOB MOORE.

Warm Weather in Virginia.

Our bees have wintered nicely so far, but it has been so warm that they have eaten a lot of honey—so much that I thought best to feed some of the weak colonies, if it was late for feeding. February 13 I fed the weakest of them. After feeding I had about nine pounds of syrup left, which I put into a kettle and put some hay in it, so that the bees would not drown. I put it in the apiary so that all the bees could get some. Would you believe it?—a colony, queen and all, left its hive and clustered on a board standing by the back of a hive, close to where I had the syrup. Not knowing it was a colony at the time, I thought they were waiting their turn to get at the syrup, there being so many bees on it all the time!

The Bee-Keepers' Guide:

Or Manual of the Apiary,

By PROF. A. J. COOK.

This 15th and latest edition of Prof. Cook's magnificent book of 460 pages, in neat and substantial cloth binding, we propose to give away to our present subscribers, for the work of getting new subscribers for the American Bee Journal.

A description of the book here is quite unnecessary—it is simply the most complete scientific and practical bee-book published to-day. Fully illustrated, and all written in the most fascinating style. The author is also too well-known to the whole bee-world to require any introduction. No bee-keeper is fully equipped, or his library complete, without "THE BEE-KEEPER'S GUIDE."

For Two New Subscribers and Your Own Renewal.

Send us **Two New Subscribers** to the Bee Journal and your own renewal (with \$3.00), and we will mail you a copy of Prof. Cook's book FREE as a premium, and also a copy of the 160-page "Bees and Honey" to each New Subscriber. Prof. Cook's book alone is \$1.25, or we club it with the Bee Journal for a year —both together for only \$1.75. But surely anybody can get only 2 new subscribers to the Bee Journal for a year, and thus get the book as a premium. Let everybody try for it. Will you have one?

GEORGE W. YORK & CO.,
CHICAGO, ILLS.

COMB FOUNDATION !

Wax always wanted for Cash or in Exchange for Fdn. or other Supplies. My trade is established on **Low Prices** and the merit of my **Foundation. Orders filled promptly.**

WORKING WAX INTO FDN. BY THE LB. A SPECIALTY. Wholesale prices to dealers and large consumers. Send for Prices and Samples to—**GUS DITTMER, AUGUSTA, WIS.** Reference—Augusta Bank. 1Atf

Mention the American Bee Journal.

DO YOU LOVE YOUR WIFE

Then save her strength, save her health, save her beauty and make her happy by buying her a **FAULTLESS QUAKER DISH WASHER.**

It is a marvel of simplicity and a wonder for utility. Washes, rinses, dries & polishes in two minutes. Lasts a lifetime. It sells quickly.

Everybody wants it when they once see it. Agents make money rapidly. Write today for terms etc. **The Quaker Novelty Co. Salem, Ohio.**

13A4t Please mention the Bee Journal.

Kansas Bee - Keepers !

—SAVE FREIGHT—

A Car-load of "Higginsville Bee-Supplies" just received. GET MY CATALOGUE.

HENRY L. MILLER,
355 Shawnee Ave., TOPEKA, KAN.
1A13t *Mention the American Bee Journal.*

1896 SAVE MONEY 1896

If you want first-class **ITALIAN QUEENS** FOR BUSINESS, **Foundation** at Wholesale Prices, **Hives**, suited for the South, or **SUPPLIES**, send for Price-List—to

J. P. H. BROWN, AUGUSTA, GA.
Mention the American Bee Journal.

But as night was near, and they remained there, I took a small stick and began to spread them a little, as there were so many. I found a queen among them; I took her with the bees to the hive they came from, put them at the entrance, and they all went in. Before taking them back, I looked into the hive and found they had plenty of honey to last them through the winter. Now, why did they leave the hive like that?

We have not had more than 10 cold days this winter here. It is so warm that the fruit-trees are budding already; if it keeps warm like this until March, and then comes cold, we will have very little fruit this year.

W. W. SEELEY.

Norfolk, Va., Feb. 15.

Tolerably Good Season in 1895.

The past season was only a tolerably good one in this part of Missouri. In the early spring of 1895 the weather was warm; fruit-bloom of all kinds was early and abundant. As the weather was fine, the bees were able to work on the bloom early and late, so they soon filled their hives to overflowing with brood and considerable honey. About May 10 there came a cold spell that lasted until fruit-bloom was gone, then we had very little honey and no swarms until basswood bloom, which was about July 10. This bloom was very good. The colonies averaged about one swarm each, and gathered on an average about 36 pounds of comb honey, which sold in my home market at 20 cents per section of one-pound. After basswood bloom my bees barely made a living.

Later on I will tell how the bees wintered, and how I managed them when I discovered, late in the fall, that they would not have enough stores to winter on.

JOHN W. BEATTY.

Excelsior Springs, Mo., Feb. 15.

A Beginner's Experience.

In 1894 I started into winter with 4 colonies of bees, and in the spring I had none. I never knew there were any books that tell how to keep bees. Last spring I bought two colonies, and now I have seven in good condition. I use the 8 and 10 frame Langstroth hive. I don't think I could keep bees without the American Bee Journal. Look through one year's subscription, and see how many valuable points it gives.

HARVEY BROKAW.

Newville, Ohio, Feb. 17.

Sweet Clover—An Open Winter.

I do wish that I was able to answer all the questions satisfactorily propounded to me regarding sweet clover since I wrote that last article on it. I have found out since, to fully satisfy me, that I am every bit as much of a "know nothing" as Dr. Miller at times pretends to be. If I am always to be "cornered" the way I have been, when I write a piece for the American Bee Journal, I think I had better "swear off," and keep mum in the future. Nearly every day I receive letters of inquiry, and, of course, I try my level best to satisfy those anxious to learn more about sweet clover. However, I am glad to know that sweet clover is on the boom, and those interested will have to try it on their own hook, in their respective localities, and thus satisfy themselves.

I am sorry to say to Mr. E. S. Miles, of Denison, Iowa, that I never attempted to harvest the seed of melilot in any considerable quantity, hence I do not know how it is best handled. But still, I have my idea how I think it ought to be done.

To handle the unchecked growth of sweet clover for the purpose of securing the seed, is out of the question, I think. By cutting it before blooming in the month of June, and then harvest the second growth when properly matured, strikes me as being the proper way to proceed. The second growth admits of being cut and handled by a self-binding machine, I think; and thus could

be handled. But the seed drops off easily when very dry, and it, no doubt, requires careful handling to prevent this, so as to secure the seed.

It would be interesting to learn the *modus operandi* in practice in the province of Bokhara, from which the imported melilot seed is shipped here. All the imported seed of melilot is well hulled, while all the seed grown in this country is largely still in the hull when sold;—and here I will drop the subject, because—"I don't know" anything positive about it.

We have had, so far, an extremely mild and open winter, and my bees (on the summer stands in my bee-shed) have wintered perfectly. They have consumed more of their stores than in former winters. On Feb. 21 I found in most hives from one to three combs with more or less capped brood in them. I have re-arranged them where needed, and supplied some colonies with reserve combs well filled with honey, so that they will need no further attention until about April.

From Jan. 1 until now, my bees had just 20 flights—a little too much of a good thing in winter, I think. I presume, though, that March and April will come in and do some equalizing, by bringing us one cold wave after another, and the bees then will suffer the consequences.

WM. STOLLEY.

Grand Island, Nebr., Feb. 24.

[We hope that any of our readers who know will tell us how to handle sweet clover in order to get the seed from it. There are many particulars about this plant that ought to be more generally known, and we shall be very glad to publish everything that is sent us regarding it. We know its honey is very fine, and we think its real value as a general utility plant on the farm needs only to be more widely known to insure a more general growing of it throughout the country. Then will the bees and their keepers laugh in the abundance of sweets which the hives will always contain.—EDITOR.]

Bees Killed with Poison.

On March 21, 1895, I shipped by express four colonies of Italian bees to H. R. Hearne, of Robinson county, Tex. He reported lately to me that he received them all right, and they did well—swarmed eight times. About the latter part of August he put poison on his cotton, for the purpose of killing the boll-worm. The bees were at work on the cotton-bloom at the time, and in ten days they were all dead. Now he wants more bees of the same kind.

The poison consisted of Paris green and London purple, put on in a dry state with a blower. The bees never returned from the field where they got the poison. All died from home, leaving their hives full of nice honey, and not a dead bee, or a live one, in the hives.

This should be a warning to bee-keepers, to be careful how they use poison.

Hunt Co., Tex.

W. R. GRAHAM.

Sweet Clover Starts Out-Apiaries.

Sweet clover is the best thing I know, considering the continuous growth and never-failing honey-producing qualities. Thirty years ago I sowed it along the banks of a creek which runs near my apiary, and it has been carried down stream by high water reaching the Cuyahoga river four miles away, and several miles down that, catching on to the sand-bars and low places until the quantity thus self-sown warranted me in establishing an out-apiary at the junction of the creek and river, four miles away, and I am contemplating establishing another, three or four miles further down.

Bedford, Ohio, Feb. 29.

J. B. HAINS.

Magic Section Press and FOUNDATION FASTENER is an invention made by James Cormac, of Des Moines, Iowa. He says this about it:

It does perfect work. No foundation will loosen from the section. $\frac{3}{4}$ -inch wide starters, or any width to a full section, with the ease and surety of attachment, and can be used when too cold to fasten with any machine that fastens by pressure. All malleable iron and steel, except the box and lamp. Lamp is brass, with metal chimney with isinglass opening to see the blaze of wick. Dimensions, $7\frac{1}{4} \times 7\frac{3}{8}$. When packed, lamp is in the box; closes sections from two inches to as narrow as made.

TO OPERATE.—Lay the section on the door by bringing the ends together as

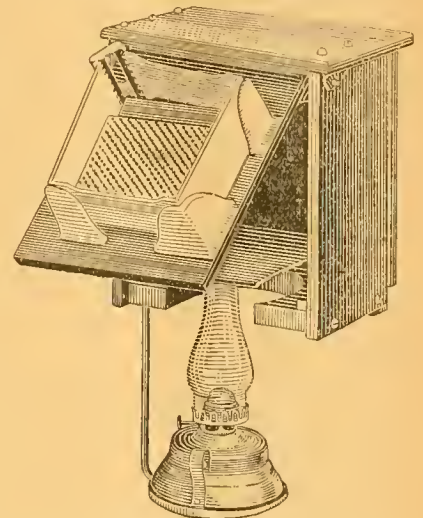

shown in the etching, with your left hand on the handle (not shown), close the door, allow the "starter" to touch the hot iron plate, slacken pressure on door, bring foundation down on section, the door opens and the work is done.

ONE HANDLING OF SECTIONS.—The "Magic" is fastened to stand, table or shelf by two malleable iron clamps attached to back of box. From three to four thousand per day can be closed and filled with one of these "Magics." A child can operate it. Cannot get out of order. The lever that closes the section is hinged with ball socket and provided with a rod and nut on bottom of box; by turning nut will throw the door outward.

TO USE IT.—Open the door, which is hinged on the upper end; if spring is not on the lever, place it on, and if the pin is out of head block place that in. Now you shut the door and it will open itself, ready to receive a section. Place the lamp in position, as shown in engraving. Lay section on door, one scallop end up, one straight side to left and to right; by shutting the door you will gain instruction. When commencing to work, cut your foundation and pile it up handy; pile one-piece sections up with wide end toward you, with grooves uppermost; as you lay section on door, close door with one hand and pick up foundation with the other, and lay it on block; touch tongue; if your lamp is of right blaze the wax will melt at the touch as you open the door; that melted, follows the foundation and is deposited on section, holding it safe and sure.

I claim for this machine that each year a person having 15 to 20 colonies of bees and producing section honey can save the price of machine.

BEE-KEEPERS!

Send me Cabinet or Card Photograph and 25 cts., and I will send you $\frac{1}{2}$ doz. Minette Photographs made on best Aristotype paper, EXACT LIKENESS. R. E. PETERMAN, Bee-keeper and Photographer.

13A

GRIFFON, N. C.

Bee-keeper's Guide—see page 206.

Bottom Prices 28c Cash Paid for Beeswax!

**BRING US BIG TRADE.
GOOD GOODS KEEP IT.**

If you want the best supplies that can be made at a little less cost than you can buy the same goods for elsewhere, write to us for low prices. 1896 Catalogue now ready—ask for it and a free copy of **The American Bee-Keeper** (36 pages).

Address,
**THE W. T. FALCONER MFG. CO.,
JAMESTOWN, N. Y.**

Mention the American Bee Journal.

ROOTS & GOODS A great reduction in Prices on Hives and Sections. Other bargains in Apian Supplies. State what you need and we will give you low prices. 36-p. Catalogue Free.
JNO. NEBEL & SON, High Hill, Mo.
Mention the American Bee Journal. 4A26t

I ARISE



TO SAY to the readers of the **BEE JOURNAL** that **DOOLITTLE**

has concluded to sell—**BEEES and QUEENS**—in their season, during 1896, at the following prices:

One Colony of Italians on 9 Gallup frames, in light shipping-box \$6.00
Five Colonies..... 25.00
Ten Colonies..... 45.00
1 untested queen. 1.00
6 " queens 5.50
12 " " 10.00
1 tested Queen... \$1.50
3 " Queens. 3.50
1 select tested queen 2.00
3 " Queens 4.00

Select tested queen, previous season's rearing. 4.00
Extra Selected for breeding, THE VERY BEST. 5.00
About a Pound of BEES in a Two-frame Nucleus, with any Queen, \$2.00 extra.

☞ Circular free, giving full particulars regarding the Bees and each class of Queens.
Address

G. M. DOOLITTLE,

12A25t BORODINO, Onond. Co., N. Y.

BEES Smokers, Sections, Comb Foundation, and all Apian Supplies cheap. Send for FREE catalogue. E. T. FLANAGAN, Belleville, Ill.
6A26t Please mention the Bee Journal.

Fruit Plants

Where to buy them at wholesale price. Send postal for descriptive and

wholesale Catalogue of all of the leading varieties of the **Strawberries, Raspberries, Blackberries, Currants, Gooseberries, Grapes and Potatoes.**

EZRA G. SMITH, Manchester, Ont. Co., N. Y.
8A1f Please mention the Bee Journal.

CARLOADS



Of Bee-Hives, Sections, Shipping-Cases, Comb Foundation, and **Everything** used in the Bee-Industry.

I want the name and address of every Bee-Keeper in America. No reason why you cannot do business with me. I have Cheap Lumber and Experienced Workmen; a good Water-Power Factory and know how to run it. I am supplying Dealers as well as consumers. Why not you? Send for Catalogues, Quotations, etc. **W. H. PUTNAM, JR.**
RIVER FALLS, Pierce Co., Wis.

Mention the American Bee Journal.

For all the **good, pure yellow BEESWAX** delivered to our office till further notice, we will pay 28 cents per pound, cash; or 32 cents for whatever part is exchanged for the Bee Journal, Honey, Books or Seed, that we offer. If you want **cash promptly** for wax, send it on at once. Dark or impure wax not taken at any price. Address plainly,

George W. York & Co., 118 Michigan St., Chicago, Ill.

SECTIONS, BEE-HIVES, SHIPPING-CASES

We make a Specialty of these Goods, and defy Competition in

QUALITY, WORKMANSHIP AND PRICES.

☞ Write for Free Illustrated Catalogue and Price-List.

G. B. LEWIS COMPANY, Watertown, Wis.

☞ Be sure to mention the American Bee Journal when you write. ☞

19th Year Dadant's Foundation 19th Year

Is still in the lead, for we use all the latest improvements, including the **NEW PROCESS**, and still make the best goods. Remember that we do not use any acid to purify our beeswax, and that is why our Foundation preserves the smell of the honey and is more acceptable to the bees, than any other. It is kept for sale by

T. H. Strickler, Solomon City, Kansas.
G. K. Hubbard, Fort Wayne, Ind.
L. Hanssen, Davenport, Iowa.
C. Theilmann, Theilmanton, Minn.
E. C. Eaglesfield, Berlin, Wis.
E. T. Abbott, St. Joseph, Mo.
J. M. Jenkin, Wetumpka, Alabama
John Rey, East Saginaw, Mich.
Vickery Bros., Evansville, Ind.

The Jennie Atchley Company, Beeville, Texas.
C. F. Muth & Son, Cincinnati, Ohio
E. Kretchmer, Red Oak, Iowa.
Jos. Nysewander, Des Moines, Iowa.
G. B. Lewis Co., Watertown, Wis.
James Reynolds Elevator Co., Poughkeepsie, N. Y.
Louisiana Bee-Keepers' Supply Manufactory, Donaldsonville, La.
Page & Lyon, New London, Wis.

and many other Dealers. All agree in saying that no goods are better than ours.

Those of our customers who formerly bought through Thos. G. Newman can get our Foundation in **Chicago, Ill.**, by addressing us at **118 Michigan Street**. We keep no other goods there.

We make a specialty of **Veils and Veil Stuffs** of best quality, cotton and silk.

Langstroth on the Honey-Bee, Revised.

Bee-Keepers' Supplies, Smokers, Sections, Tin Pails, etc.

Samples of Foundation and Tulle FREE with Circular. Instructions to beginners with Circular. **BEESWAX WANTED.** Send us your address.

CHAS. DADANT & SON,

Mention the American Bee Journal.

HAMILTON, Hancock Co., ILL.

—LEADS THEM ALL 8 to 24 1/2 %—
See reports of experiments with Comb Foundation at the government station, Lapeer, Mich. **FREE**—large Illustrated Catalog of everything needed in the apianry. Full of information. **M. H. Hunt, Bell Branch, Mich.**
5Dt1 Please mention this Journal.

READERS Of this Journal who write to any of our advertisers, either in ordering, or asking about the Goods offered, will please state that they saw the Advertisement in this paper.

**BEAUTIFUL
Transparent
TOUGH
and yet
PLIABLE.**

NEW - PROCESS WEED FOUNDATION —DELIGHTS ALL—

RECENT COMPARATIVE TESTS IN FLORIDA show that the old-process dipped wax will sag or stretch in the hive nearly five times as much as that by the new Weed process.

**REDUCED
PRICES**

Our New Sanded and Polished Sections and Bee-Hive Material are the Finest Product

that money and machinery can turn out. **CATALOG FREE.**

THE A. I. ROOT CO., MEDINA, OHIO.

118 Michigan St., Chicago, Ill.

Syracuse, N. Y.

1024 Mississippi St., St. Paul, Minn.

AMERICAN BEE JOURNAL

ESTABLISHED 1861
THE OLDEST BEE-PAPER IN AMERICA

DEVOTED EXCLUSIVELY
TO THE INTERESTS
OF HONEY-PRODUCERS

Published Weekly, at \$1.00 per annum.

Sample Copy sent on Application.

36th Year.

CHICAGO, ILL., APRIL 2, 1896.

No. 14.

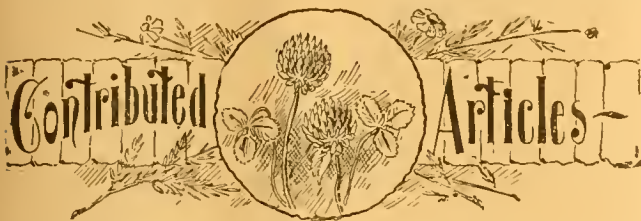

Insuring Sections of Honey Shipping Safely.

BY B. TAYLOR.

The following paragraph was published on page 135, having been written to Dr. Miller :

I wish we could get the collective wisdom of our sages on this matter. But, then, to the confusion of the tyro, their opinions differ so on this, as on most other matters. For instance, B. Taylor, in his Toronto essay, says he fills his sections with "moderately-heavy foundation," and boastfully remarks that he has sent 200-pound lots 700 miles with three railway transfers without a single section breaking down. Had the "moderately-heavy foundation" anything to do with insuring this safety? Also, had the *viscidit* of the honey (as a result of 60 days' storage in an iron-house with free air circulation) anything to do with it? Does he use spiral springs for his crates, or corrugated paper, perhaps? I wish he'd be less tantalizing, and a trifle more explicit. These big fellows just hint at things—in a rather supercilious sort of way—telling us youngsters just enough to make us long to know more. I wish you would "squeeze" B. T. a bit on this point. S. D.

The loss from breakage in shipping comb honey is very great, and any light on the subject is important to the general bee-keeping fraternity. I will try to give my experience in preparing and shipping, in as plain terms as possible.

The first step is to have the combs built firmly to all four sides of the section, and to do this to a certainty, narrow sections—not more than seven to the foot—are best. I use eight to the foot. I have used thousands of sections two inches wide, but I never could get the bees to fasten the combs so firmly to the wood as in the narrower sections. In the wide sections there would be a small part of the comb that would be fastened to the wood in the center of the sides and top, and commonly not fastened at all to the bottom.

When I first used the 1½-inch sections, they would hold only about ¾ pound of honey, and I invented the Handy slotted and cleated separators to remedy this defect. They not only did this, but much more, for ever since I began to use them the sections have been filled and capped solid, right plump to the edge of the sections, in a way that never has been, nor can be, done with a smooth, solid separator. With solid separators the bees will leave holes in the combs at the corners, so they can pass from comb to comb. If the combs were made solid on all sides there would be no passage from comb to comb, except by going over the tops or under the bottoms, and this they wisely refuse to do. But with the slotted separators there is a free passage from comb to comb right through the center of the super. The bees do not need to leave a passage in the combs; and the honey is built and capped solid to the sections on all sides. For making beautiful comb honey, that will ship safely, I claim the narrow sections, in connection with the Handy slotted and cleated separators, to be a great improvement over the old ways.

But to be sure of having every section complete, there must be two pieces of foundation in each section—a strip ½-inch wide at the bottom, and the larger top piece to come ½ inch from this, and both pieces must be fastened exactly in the center of the sections, and so they will stick for all time to a certainty.

Let me say before leaving this subject, that the Handy separators are not used between each section, but only between each two combs. They will last a lifetime, and are cheaper than plain ones in the end, besides giving very much more fancy honey.

Now we have our honey as it will be when taken from the hives, and we must cure it. And here there are two points to be looked after. The first is to have the honey in the *very highest excellence as to quality*; and, second, to have it in the highest perfection for *handling and shipping*. Happily these two points both require the same treatment, viz.: To keep the honey in a very warm, dry, well-ventilated room for at least six weeks. This I do by putting the supers on end with an inch space between them, in my iron curing-house. I have the house of iron only because the warm sunshine will keep it at the right temperature very cheaply, and then mice, rats, and other pests are certain to not get in. But any room that can be kept near 100° will cure the honey equally well. One of the finest lots of honey I ever had was cured in a bed-room in a farm-house, directly over a large cook-stove that was fired up 20 hours each day.

Honey, after being treated in this fashion, has an excellence for the table that is unknown to those that eat it directly from the hives, or store it in an unventilated, cold room; and is so thick and strong as to ship with safety where honey can be shipped at all.

For shipping in 200-pound lots, I make a crate much in the style of those in use to ship one-piece sections. Those crates are four inches longer than the width of five of my 20-pound section-cases, and five inches deeper than two tiers of said cases. The large crate is made of light stuff, but is nailed very strong, and has a solid bottom of thin stuff. On this bottom I lay evenly two inches, when packed, of clean straw; then on this several thicknesses of waste paper. Five 20-pound crates are placed close together in the crate; this will leave them two inches from the end of the large crate, and this space is packed moderately solid with straw to make a cushion to receive and soften any end-jar in the cars.

On these first five crates is spread one inch of fine straw, paper laid on it, and five more crates put in as before, paper laid on top, and straw laid on as thick as is possible, so the cover can be nailed over all. I use pressure in nailing the cover on, as the fruit-men do in packing apples, for we must prevent all jumping of the honey in the large crate.

I must not forget to say that the large crate is just wide enough so the cases will fit snugly endwise, and no packing is used in this part. The glassed ends of the crates are all placed on one side, and the slats that make the large crate are far enough apart so the honey is plainly to be seen. The top strip that is used for the sides of the crate is long enough to project 8 inches at both ends, for the railroad men to lift it by.

The crate is now plainly marked with directions to set it lengthwise in the car, and is always sent by freight. This crate is too large for one man to handle, and it is all ready for two to carry conveniently without rolling. I have never lost a nickle from breakage in them. Forestville, Minn.

Spring Work in the Apiary.

BY WM. S. BARCLAY.

As the season is rapidly approaching when the bees will have to be examined, a few words in relation to the manner of handling them may not be out of place.

To those who have wintered their bees out-doors and at the same time used single hives, I will here say that they are more fortunate than myself if their bees are not troubled with dysentery. To avoid this great trouble I would advise that the single hives be enclosed in an outside case, and that they be packed now (as if for winter) on all sides except the front of the hive, and if the weather is warm enough for them to fly, that they be fed rye meal; if not warm enough, that the meal be liberally scattered over the tops of the combs. I remember one instance at least in which this treatment relieved me of some serious cases of loss from this my greatest spring trouble.

Those who have used double hives which have not been packed in their vacant spaces in the winter, should see that it is done at once. So far as my locality is concerned, I am not yet sure that it is not of greater consequence to pack at this time, than it is to do so in order to meet the rigors of a severe winter. In all outside packing I would advise that it should be put in quite loosely, as in this way we are more apt to avoid dampness, and this is our great object in packing.

As to feeding to increase brood-rearing, I have almost concluded that no matter how much honey may be in the hive, if we place feeding-honey, or sugar syrup in the proper position in the brood-nest it will be greedily taken by the bees, and thus be promotive of increased brood-rearing. By the proper position I mean by placing it out-side the division-board. I like this much better than feeding lightly every day above the brood-nest; it accomplishes the same purpose, and saves much time and labor.

Another matter that has been much practiced and written about is that of brood-spreading. This is a subject that should be approached with great caution—indeed, after practicing it to a limited extent for some years past, I have serious doubts that there is anything gained by the practice; and where it is attempted, I would insist that no spreading of brood should be attempted until the colony has at least four or five combs of sealed brood, and not even then, unless there is promise of continued favorable weather. If it is then attempted, it will be found that a little sugar syrup filled about one-third of the way down the combs, given for eggs, will cause them to be filled with brood much sooner than if given empty.

The danger to be encountered in spreading the brood is to be attributed to the rapid and variable changes of the weather in which the bees, in closing the cluster, uncover their brood, and thus a portion of it is killed. I find after this has occurred the colony almost always becomes discouraged to such an extent that it is almost impossible to induce them to rear bees in time for the honey harvest, and thus the bees are reared only to become consumers instead of honey-gatherers, so that I much prefer to blanket down tight over the combs, not even using a "Hill's device," and then use plenty of packing over the brood-nest, leaving an empty space next the roof of the hive, and if feeding is done, let it be in the brood-nest outside of a division-board, as before spoke of.

In my locality, natural pollen will be very late this season, and as I find that the feeding of rye meal is a great assistance to brood-rearing, I would recommend that this, or other pollen-giving material, be given freely to the bees.

Beaver Pa., March 17.



Mr. Aikin on the Swarming Question.

BY ADRIAN GETAZ.

In the Bee-Keepers' Review for December, Mr. R. C. Aikin, in an excellent contribution on the swarming question, says:

"In the American Bee Journal for Nov. 14, 1895, page 731, I find the following sentence by Mr. Adrian Getaz: 'Excepting the case of loss of queen, queen-cells are constructed only when three conditions are present, viz.: 1st, a honey-flow; 2nd, a number of young bees, and 3rd, the laying of the queen restricted by either the lack of space (or rather empty combs) or a failure in the fecundity of the queen.' In the article from which I quote, he advances the theory that the bees under such conditions have a surplus of larval food which is used in the construction of queen-cells, hence swarming results."

The idea that the surplus of larval food is the cause of swarming is not original with me. It was discussed extensively in Gleanings during 1889, and advocated by quite a

number of our leading writers, chiefly Messrs. Stachelhausen and Hasty. Dr. Miller and Editor A. I. Root also endorsed it. In some of the foot-notes Mr. Root insisted that previous to swarming, larval food is found in the embryo queen-cells, even quite awhile before any egg is deposited therein. He also stated that the idea of a surplus of larval food being the cause of swarming had first been advanced by Adair, several years before.

All seem to have taken the ground that the swarming notion originates with the young bees on account of the surplus of larval food. This, I cannot see; it does not seem to me that the young bees, which have hardly ever been out, should be the ones to get dissatisfied and want to swarm.

On the other hand, I can very well conceive that having more larval food than they can use in feeding the queen and young brood, they construct queen-cells, and, perhaps at first, only store the food in them until finally eggs are laid there also. Once the queen-cells constructed and getting pretty far advanced, the old queen begins to realize (probably as Mr. Hasty says, by the scent of the cells) that rivals are there. She gets excited and tries to destroy them, the bees instinctively try to protect them, and finally the excitement reaches the point where swarming takes place.

That the plurality of queens, or queen and queen-cells, is the immediate cause of swarming seems to be admitted without doubt, at least as far as I can see. If two or more queens are at liberty, a fight ensues, and only one remains. If one is free and the others in cells, and protected by the bees, or caged by the apiarist (this I know by experience), the free queen, after attempting to destroy her rivals, will swarm. Further on Mr. Aikin says:

"But what causes this surplus of larval food? I can see a reason in the activity and stimulus of the honey-flow, the greater number of nurse-bees, and the surplus augmented by a decreased amount of brood caused by crowding the queen; but if these are the causes of building cells, why do they not continue until the close of the flow? If the colony can be gotten safely past the first part of the flow (or through the first 10 or 15 days) without swarming, we may have present all the conditions named, and yet the swarming will decrease 25 to 75 per cent."

This may depend upon a great many circumstances, and I would like to know more about it.

In my locality honey comes in irregularly, and in moderate quantity at the best, from the first of April (fruit blossoms) to the middle of July, or a little later (sourwood). Until the first of June, or about then, should queen-cells be constructed, which is nearly always the case, swarming follows invariably. During that time the weather, at least during the night, is not very warm yet; and the bees remain crowded in the brood-nest, and in one, or perhaps two, supers immediately above. The result is that the queen gets easily crowded for space, and that when queen-cells are constructed, they are fully protected by the bees.

After that date, or about, the conditions change. I always put plenty of supers on my hives so that they will not be too warm. I find then (I mean after June 1) that the temperature is high enough to permit the bees to break up the cluster entirely, and work anywhere in the hives, and I find them scattered in all the supers instead of being concentrated in the brood-nest and immediately above. The higher temperature also favors the building of comb and storing in the supers. The result is that the brood-nest is no more crowded with honey and bees; and the queen has enough empty combs to lay in.

If through failure of fecundity of the queen the construction of queen-cells takes place, the bees are not crowded enough to sufficiently protect them, and the queen succeeds (I say "succeeds" not "is permitted") in destroying them, or if the old queen is nearly worn out, and has not the energy to do it, the first virgin born will surely do it thoroughly.

Does the above apply to Mr. Aikin's locality? I don't know. I would like to know. In his case, judging by his writings, the question of temperature does not seem to play any part. Until some time in June, he has but little nectar, then all at once the flow comes in abundance, and with the flow excessive swarming during a week or two. I should suggest the following explanation:

At the opening of a heavy flow the bees get somewhat excited, the same as they do when feeding begins, rush for the nectar, and crowd the brood-nest. It is also known that comb-building is not well started until after a few days. So they will at first literally clog the brood-nest, then after a few days the comb-building is well under way, the excitement diminished, the honey carried from the brood-nest into the supers, and the swarming decreases consequently.

That is only a supposition. I would like to hear more

about it from Mr. Aikin, especially what part the changes of temperature may play in the matter.

I will quote yet another paragraph :

"Mr. Getaz is evidently wrong in his theory that a surplus of larval food causes the building of queen-cells. Take from the most prosperous colony all its brood, and you at once take away its swarming; yet such proceeding ought to leave the colony with a *superabundance* of larval food and nowhere to use it."

I think Mr. Aikin is certainly wrong in this, or I do not understand him. In a colony ready to swarm, we find quite an amount of sealed brood, only a limited amount of young brood to feed, and a still more limited amount of space to lay eggs in; nurse-bees also in quantity, and more of them are "borning" daily from the sealed brood.

We remove all the brood—what is the result? By the operation we at once give the queen plenty of room to lay, and in a day or two there will be plenty of larvæ to feed. At the same time the daily increase of nurse-bees from sealed brood is taken away, and with them the surplus of larval food. Does not that show that the withdrawal of brood has increased the amount of larval food needed, and decreased the source of supply, and therefore there is more surplus to put in the construction of queen-cells? Knoxville, Tenn.



Some Subjects Reviewed and Commented Upon

BY DR. C. C. MILLER.

UNKIND FLINGS.—"Now that we have for the first time a Southern journal, devoted to our favorite pursuit, ought we not, as Southern men, come gallantly to the support of the brave lady who has dared to undertake the enterprise of editing a Southern journal? It seems that her spirit of enterprise, or something she has said or done, has so provoked the spleen of a contributor to one of the above-named periodicals, that he was not long since moved to make the charge that this lady has been cribbing from the files of the American Bee Journal in order to make the columns of her journal more interesting. Later, he says in explanation, that she has been using in the Southland Queen, some articles that she wrote for the Bee Journal. Reading these unkind flings, I was moved to wonder if the writer had never felt, from mother, sister or wife, that love and devotion that, once experienced, renders the very name of woman sacred to a gentleman."

The above is said by "Novice" in the Southland Queen, and it seems a little strange that that paper should allow it to pass without comment. I suppose I am the contributor referred to, and I never made any "unkind flings" in the case, nor made any charge of cribbing. I said the articles were copied from the American Bee Journal, and in saying that I said just what the Southland Queen itself said. Knowing the facts in the case, the Southland Queen will please do the fair thing by making the proper correction.

THAT "FALLACY."—After reading what J. H. Martin has to say on page 179, I smole a quiet smile and said to myself, "Mr. Martin's reasoning machine is somewhat out of gear." Just shake yourself awake, Mr. Martin, and see how it looks. You say less than one pound per capita is used, and because so little is used the bringing of a lot of California honey North doesn't make competition. Say, J. H., were you really awake when you said that? No, I don't believe I use the word "competition" "rather loosely" so long as a heavy shipment of honey from California brings down the price in the Chicago market.

AMALGAMATION.—On page 178, Manager Newman says the expressions so far given are mainly against amalgamation of the North American and the Union. I can hardly believe a square vote of the Union would show a majority against amalgamation. It certainly didn't look that way at Toronto, and at the last Chicago convention the vote of the Union members there was all in favor of amalgamation.

Now, friends, will those of you that are opposed to amalgamation please give us your reasons? I don't remember seeing any reasons given except those based on a misunderstanding.

I was one of the first members of the Union, and have always been loyal to it. I want to see it continue and increase. As matters stand at present the prospect is that it will go out of existence. There's no use blinking the fact that it is now on the down-grade as to members. Give the members the additional advantage of the North American for the same money, and are they not more likely to stick by?

Marengo, Ill.



See "Bee-Keeper's Guide" offer on page 221.

No. 1.—Producing Comb Honey in Michigan.

BY W. Z. HUTCHINSON.

The first thing to be considered is the bees. As to variety of bees I know of nothing superior to a cross between the Italian and German. Italians are better foragers than the black or German bees. When the pasture is near, and the flow good, the blacks will gather as much honey as any bees; but when the nectar must be sought for far and wide, the Italians will be found the more industrious. If the Italians are better field-bees, they are excelled by the blacks as "house-keepers." They (the blacks) keep the brood-nest more compact, are better comb-builders, enter the spers more readily, and cap their combs whiter. The Italians are the bees to bring in the honey, the blacks the ones to handle it to the best advantage after it is in the hive. The Italians might be compared to the man who goes out in the field to labor—the blacks to the woman who stays in the house and manages to the best advantage the products of the man's labor. Of course, we cannot make any such arrangement with the black and Italian varieties of bees; at least, not any *permanent* arrangement. By introducing a black queen to an Italian colony of bees there would probably be a short time when the majority of the field-workers would be Italians, and most of the nurses and wax-workers would be blacks, but such a division of labor would not last long—the Italians would soon be gone and the blacks in their place. Such a plan would not be practical, but a cross between the Italian and German is eminently so. A cross between these two varieties is not one whit behind the Italians as workers, and comes pretty well up to the blacks as "house-keepers." If such cross-bred bees are lacking in any respect it is in those characteristics possessed by the black bees.

Possessed of the right kind of bees, the next step is to see that they are present in sufficient numbers at the time the surplus is to be gathered. Each bee-keeper must understand his locality and work accordingly. In those localities where the main harvest comes in the fall, but little attention is necessary to have the colonies strong in numbers by the time the harvest is ready; but when it begins in June, or the last of May, and lasts only six weeks, or less, where there is no basswood, it is of the utmost importance that the colonies be populous at the beginning of the season. Not only must they be populous, but the combs must be full of brood. As a rule, I don't believe it is profitable to change about combs in the brood-nest for the sake of getting them more completely filled with brood. By this I don't mean that more honey per colony might not thereby be secured, but it takes too much time. If the number of colonies is limited, and it is not practical to increase the number, and their owner has nothing else to do, such work might be advisable. When possible, it is better to have more colonies, up to the capacity of the field, and do less work per colony. In the early years of my bee-keeping I did a great deal of "fussing" with the bees. Latterly, in producing comb honey, the bees have almost managed themselves. They have been taken from the cellar, the sections put on and taken off at the proper times, the swarms hived, the bees put back into the cellar upon the approach of winter, and that has been about all there has been to it. I know I have never produced honey so cheaply as by what *some* would call slipshod methods. With the sectional Heddon hive it is all right to transpose the two sections just before the opening of the honey harvest. This is a sort of wholesale, short-cut method of inducing the bees to more completely fill the combs with brood, that I endorse it. But don't do it too early. Better let the brood-nest remain entirely undisturbed than to chill some of the brood.

Perhaps all do not understand how transposing the sections of a Heddon hive will act as a greater inducement. Bees aim to keep their brood-nest in a globular shape. Cut this globe in two horizontally, and place the upper half below the lower one, and it will be seen that the two spherical sides are brought together in the center, while the broad, flat surfaces are brought to the top and bottom. In their endeavor to again bring the brood next to a globular shape, the bees fill cells with brood that would not have been filled had the brood-nest been left undisturbed.

There is one more thing that can be done to induce a safe extension of the brood-nest early in the season, that is, surrounding the hives with some packing material. In ordinary seasons this may not be of much benefit, and I believe it is possible to so apply it that no good will result—possibly harm. The packing must not be too thick; if it is, it will deprive the bees of the benefit of the sun's rays. Strong colonies may be able to take care of themselves under such circumstances, but it means death or disaster to a weak colony. The packing should be of such a thickness that the warmth from several

hours' sunshine will surely reach the bees. The packing will become warmed up during the day and retain it a good share of the coming night, besides preventing the too rapid escape of heat from the colony, thus acting as a sort of caloric balance-wheel. Two inches of dry sawdust is sufficient for spring-packing. There is one more point in connection with this packing that ought to be heeded, and that is the color of the packing boxes—they must be *dark*. Light colors reflect the rays of the sun, dark absorbs it. Venetian red is a good color.

I know that Mr. R. L. Taylor's experiments of last year showed no advantage in spring protection, but the spring was not one that favored protection—was a warm spring—and I fear that the packing was too thick. The benefits of protection show to the best advantage when a long spell of warm weather is followed by a "freeze-up" lasting several days. I one year lost nearly half of my bees by such a "freeze-up" about the middle of May, coming on the heels of about three weeks of fine weather. Colonies that were packed did not mind the cold. The raising of a cushion in a packed hive would show the bees crawling about all over the combs, while in a hive with no protection the bees were closely clustered, leaving large quantities of brood exposed. Weak colonies unpacked perished outright; medium-sized ones suffered the loss of much brood, while the *extra-strong* ones did not seem to suffer much loss, even if not packed.

I have no quarrel with those whose methods and localities are adapted to large hives, but to producing comb honey in my locality I prefer a small brood-nest. I want a hive of such a size that an ordinary queen with ordinary management can fill it with brood by the opening of white clover.

I would not unite weak colonies in the early spring. Without being able to explain just why, I know that several weak colonies united into one will, within a week after, dwindle down to the size of one of the weak ones at the time of uniting. As a rule, I would see that each colony had a good queen and plenty of stores, then tuck it up warmly and let it alone until the time approaches for putting on the supers. If at this time I found many colonies not strong enough to work for comb honey, I would take the brood from one, two, or three of these weak colonies, as the case might be, and give it to one colony—just filling the hive with brood. A hive thus treated will soon be overflowing with bees. The colonies robbed of brood can be left to build up into sufficient strength for wintering, if nothing more.

I have devoted considerable space to the bees, but it must not be forgotten that in the production of comb honey no point is of more importance than that of having the hives *overflowing* with the *right kind* of bees at the beginning of the harvest. Having gotten the bees, I will, in my next, tell how to use them.

Flint, Mich.



Ontario Foul Brood Inspector's Report.

BY WM. M'EVROY.

During 1895 I visited bee-yards in the counties of Lambton, Middlesex, Oxford, Brant, Elgin, Norfolk, Wentworth, Lincoln, Perth, Wellington, Peel, York, Ontario, Hastings and Simcoe. I examined 85 apiaries and found foul brood in 32 bee-yards, and other kinds of dead brood in many others. The great frosts in May, and the dry weather that set in right after, and continued for so long a time, was very hard on all apiaries on account of its shutting off the honey-flow when the colonies had large quantities of larvae to feed. When the *unsealed* stores was used up the bees in many cases did not uncap the old sealed honey fast enough to keep pace with the large amount of larvae that required so much feeding, and the result was a good deal of starved brood, in several colonies, which was mistaken for foul brood in many cases. The great failure of the honey-flow would have led to the wholesale spread of foul brood through robbing setting in by the bees when the diseased colonies were being treated, if I had not taken particular pains to warn the bee-keepers well, and insisted upon everything being done exactly as I ordered. I went in for putting every diseased apiary in grand order, and for having as many, if not more, colonies at the close of the season as when I began. In every part of the province that I went into I found the bee-keepers were pleased when I called on them to examine their apiaries, with the exception of three men; one of these men had only four colonies, and they were bad with foul brood, and near other apiaries. I explained to him how to cure, and urged him to do so; I also warned him of the great danger of his keeping the disease so near other bee-yards, but it was all no use—he refused to cure. I waited for over six weeks for that man to get his few colonies cured; he

did not even try to do anything, then there was nothing left for me to do but to go and burn his foul-broody colonies so as to save other bee-keepers from having their apiaries ruined by his diseased stock.

I burned one colony that was nearly dead with foul brood, for a bee-keeper that I never could get to cure his few colonies, or do his duty like other men. I burned three very badly diseased colonies in the same apiary the year before. When a bee-keeper can cure a few colonies of foul brood in a short time, and is urged to do so, time after time, and will not do it after being given every possible chance, then I have to stamp the disease out by fire for the public good.

I burned 13 colonies for another bee-keeper, that were nearly dead with foul brood, in fact, some colonies in the same apiary had died right out with the plague. I did my best with that man several times to melt up his diseased combs, and burned three foul-broody colonies for him before, but all that had no effect on him, he would, and did, risk using old, diseased combs until his apiary got into a horrid state with foul brood. I then stamped the plague out again by fire, so as to save the valuable apiaries in the same locality.

I was very much pleased with the way all the other bee-keepers went to work and cured their apiaries of foul brood, and some of these men had nearly 100 diseased colonies when they started to cure.

Five years ago last spring when I set out to get all the diseased apiaries in the Province cured of foul brood, I soon learned that I had undertaken a tremendous job. I found the bee-yards in every locality that I went into at that time in a horrible state with foul brood, and the disease spreading at an alarming rate then. And to make matters worse, many were selling when they saw it. I had first to take the greatest of pains to explain to every bee-keeper how to cure his colonies of foul brood, and then see that they made no mistakes, and that led to my having to write very many long letters to them, hours after I should have been in my bed, so as to help them out, by explaining everything again, which I always did.

I have handled the disease in six cities and 36 counties, and made a great success of ridding out the disease by getting thousands of colonies cured of foul brood and put in grand order. Several sales of diseased colonies had taken place by the very best of men amounting to hundreds of dollars. I soon found that neither the buyers nor sellers knew that the colonies had foul brood at the time of sale. I was chosen as the sole judge by all these parties. And in one case a note for \$240.00 had been given. I decided what I believed to be just and very fair to all, and I am very much pleased to say that I satisfied both the buyers and the sellers, and got everything settled very nicely.

Five years ago last summer, while on my rounds through the Province, I often met with opposition from the bee-keepers. Many of the small bee-keepers looked on the inspection business as a something gotten up to drive them out of bee-keeping, and several had no faith in a cure. Some expected that I was going to stamp the disease out by fire. I was astonished to find so many holding such views in so many parts of Ontario. I felt very sorry for those people, and took the greatest of pains explaining to them that I came to cure and not to destroy any colony if the bee-keepers would take hold and cure after I told them how to do it. Things have taken a great change since then. I don't find any more opposition, but all very willing to have me call and examine their apiaries.

My railway fares, time, and livery hire, for 1895, amounted to \$673.40. Woodburn, Ont.

[The foregoing report was read at the last meeting of the Ontario Bee-Keeper's Association, after which it was moved by Mr. Frith, and seconded by Mr. Chrysler, that the Foul Brood Inspector's Report be adopted. Carried.]

It was also moved by Mr. R. H. Smith, and seconded by Mr. John Newton, that the Ontario Convention desires to express its appreciation of the work done by the Government in the curing of the various foul-broody apiaries throughout the Province, by the Foul Brood Inspector, William McEvoy, and gives their hearty indorsement of the methods of curing as adopted by him; also, to express themselves as believing Mr. McEvoy's methods for curing foul brood to be the best at present known. Carried.—EDITOR.]



The McEvoy Foul Brood Treatment is given in Dr. Howard's pamphlet on "Foul Brood; Its Natural History and Rational Treatment." It is the latest publication on the subject, and should be in the hands of every bee-keeper. Price, 25 cents; or clubbed with the Bee Journal for one year—both for \$1.10.

CONVENTION PROCEEDINGS

The Colorado State Bee-Keepers' Convention.

REPORTED BY F. L. THOMPSON.

(Continued from page 198.)

The subject of organization was then discussed.

Mr. Alford—We have about four times as many bee-keepers as we need. I have not sold any honey in Colorado for five years. The marketing of honey is what we should attend to.

H. Rauchfuss—We cannot afford to ship in small amounts. We must combine, and educate bee-keepers to produce marketable honey. That is what our organization is here for. But it does not fill the bill. How shall we do it? I don't know—but it must be done. If the organization is a success, bee-keepers will join.

Mr. Deviny—Profit depends on putting the honey where it belongs. A man in Texas wrote me for two carloads. I thought surely I could get it for him, but couldn't find it in Colorado, because it had already been promised elsewhere.

Mr. Alford—There is no trouble in finding a market. We have not too much honey, but we have bee-keepers enough.

Mr. W. L. Porter read an essay entitled "Our Association," most of which is here given:

OUR ASSOCIATION.

Organization means civilization. I do not think we have any reason to be discouraged. Our society compares well with any similar society of the country. But we might have better attendance, and thereby achieve better results. To find the combination is the problem. If we could combine, there is no doubt but what we could obtain better prices. The retail price of honey this winter is 15 cents, straight. Now the retail dealer is willing to pay \$3.00 per case of 24 sections, and still sell at that price. Allowing 25 cents for jobbing, this would make the price we should obtain \$2.75 per case. Instead of that, \$2.40 is about the average. This means 35 cents loss to each case.

This is a good illustration of what goes on every year. Many of us do not dream of what might be done if we had a Union, and could all sell honey through it. But we have to face the thing as it really is. We, the honey-producers, are not united. The only remedy is to work towards educating the indifferent fellows to an appreciation of the benefit of fellowship. For our meetings to draw, we should have them as social as possible.

I have thought it would be well to give one of our meetings—perhaps the evening session—to social culture and entertainment. We might have a program interspersed with music, essays, songs and speeches. This meeting might be made so very interesting that we would go away feeling that it alone amply repaid us for coming out.

The subject of the busy bee is attracting great attention in our public schools. Great stress is put on the teaching of the science and natural history of the bee to the children. Why not ask our professor at the Agricultural College to prepare a popular lecture on the science of the bee, with special drawings to illustrate, and then invite the teachers who are interested to be present, and allow them to ask questions, and give them the benefit of our many years of profound experience?

We could also save, if we had more funds. I would suggest that we make the admission to the society \$1.00 for male, and 50 cents for female, members.

Our meetings should be a means of education by which we may be kept abreast with the latest discoveries in our profession. It should be a financial aid. Through our society we should be able to learn the demand and supply of honey, so we can market to better advantage.

On the supply business I will not say much. But in my judgment it can be carried on better by local societies. There are several reasons for this. In a locality it is very often the case that some certain standard of goods has been introduced, such as the Langstroth hive or the Dovetailed, and that locality would have to buy of the house that produces that particular kind. Then it is better to have the goods shipped direct to that point in a car lot than to be shipped to another

point and then reshipped, which would take extra time and extra freight. Hence, wherever there is a locality with a number of bee-keepers, let them come together and organize and correspond with manufacturers and dealers for prices of such goods as they may need, and favorable results will come.

In the same way the honey can be disposed of. The people of each locality can get together and arrange to ship one or more cars of honey out. For instance, we may call Greeley one point; Fort Collins another, Longmont another, and so on.

These societies will have a tendency to educate the people in the benefits of association, and finally they will wish to take one step higher, and so we will have them up to the State meetings.

I have thought it might do good to make the place of our State meetings migratory. We could meet at Greeley, Fort Collins, Longmont, and once in awhile in the famous Arkansas Valley. In this way, as we push our ship around, a few barnacles would catch on and perhaps would stick. In this way we would become better acquainted with each other and see more of our grand State, which is to be the banner honey State of the Union.

There might be an objection to this when we have an ax to grind in the Legislature, and would want to be on the ground to do it.

W. L. PORTER.

ORGANIZATION AND MARKETING.

The discussion on organization continued:

R. H. Rhodes—The Secretary has the names of 143 bee-keepers, while the usual membership is 25 or 30. Keep the fee as it is (50 cents for male members, and 25 cents for female members). Increased membership brings increased funds.

Mr. Deviny—Members here should write to those from a distance to stay with them during the session.

L. Booth—There must be a State organization. Let our Secretary and other officers contract *directly* for supplies—let the local organizations get their supplies through *our* Secretary and Executive Committee.

Pres. Aikin—We might imitate the Citrus Fruit Exchange in California. There is a central office and a representative in communication with all growers. He is also in communication with the principal markets. Orders come to him, and he fills them from appropriate parts of the State. Supply and demand do not always regulate prices, on account of "corners." Therefore, let us not organize for greed—to raise the price especially, but to help those in debt to sell to the proper quarters at fixed prices. Small lots at low prices should not affect the market. We are to hold our produce for a short time. As soon as the small lots are cleared off, consumers must look to us for the rest of what they want. As a result of advertising, firms all over the country have written me for honey. I sold all my extracted at 7 cents. We haven't enough honey. If we had more, so that merchants would frequently call on us, the prices would be firmer. The package has something to do with it. Large packages are a detriment. The grocer gets disgusted after buying one can. He won't handle it in that shape. Extracted honey should be in small packages in large crates. In that way it may be made a staple article. I wrote to a commission firm about this. At first they discouraged the idea, but finally said, "Try it." If I can sell my honey that way, I can let it go for 1 to 3 cents a pound less, as the work of transferring from large to small packages would be saved.

J. B. Adams—A Chicago firm wrote to me asking, "What can we buy Colorado honey for? It must be at such a price as to compete with California honey." But in their second letter they said, "We can sell all first-class Colorado honey for a good price in competition with California honey." That shows why the honey we ship should be first-class. We can't produce enough to supply all the first-class honey wanted. Since then I have received requests for 3½ carloads. They all want it first-class.

Mr. Alford—On commission?

Mr. Adams—No, sir.

Mr. Alford—Sell *none* on commission. Sell it f. o. b. here. My experience with selling on commission has been such that I want no more of it.

Mrs. Shute—It is possible that Chicago man Mr. Adams referred to saw the Colorado honey at the World's Fair. A Chicago newspaper said: "The public conceded the awards to the Colorado honey."

J. E. Lyon—Even if only two or four get together, it pays to organize. Then we can first send a man ahead to sell, and afterwards send the honey, at a cost of not more than a cent a pound. I have shipped honey to Illinois in 500-pound lots. It is always wanted. It is never necessary to undersell.

Pres. Aikin—I have shipped to many States. They all said mine was fine honey.

F. Rauchfuss—There used to be an organization here for that purpose. Each member was a stockholder. That is the only way to have it.

L. Booth—That failed from bad management. That is the trouble with stockholding.

Pres. Aikin—The Citrus Fruit Exchange have succeeded. They have controlled half the output of Southern California. They have a central office controlled by managers elected by stockholders. Their orders come in, and their markets are worked up, before the season opens. A car goes to all markets. It does not have to be reshipped. The rebate in freight rates goes to the producer instead of the commission-men.

Mr. Deviny—One method would be to make a contract or agreement to furnish so much honey to be shipped. If you sign an agreement to furnish goods, it is just like a note.

F. Rauchfuss—We should reach those who do not find it convenient to attend, but who would receive benefit by being members.

SECURING SURPLUS IN ADVERSE SEASONS

was next treated of in an essay by V. Deviny. From forgetfulness, Mr. Deviny's essay was not procured, but in substance it was as follows:

I shall only treat one aspect of this question. Honey-production requires the production of young bees early in the season. When animals are in unnatural conditions we should help them. Our bees are not native to Colorado. Since there are many warm days in which bees fly before natural pollen comes, flour should be fed. I have practiced feeding wheat flour for many years, and have found nothing better. Last year I fed 150 pounds to about 100 colonies. I press the flour firmly down in the bottom of the vessel, and set it at an angle of 45°. In this way the bees do not get in and smother.

V. DEVINY.

Mr. Adams—I recommend mixing the flour with an equal quantity of clean chaff. It gives them plenty of room.

Mr. Deviny—I have tried mixing the flour with coarse materials, but do not like it. The bees split their wings. By my method they do not get in at all.

Mrs. Booth—I spread the flour along a table 15 or 20 feet in length. The bees do not smother.

R. Patterson—How long before the honey-flow should flour be fed? Do you look at light colonies at the same time? They will be incited to use up their honey.

Mr. Deviny—I do not feed before March 1.

Mr. Adams—I commence to feed as soon as they will take.

Mrs. Booth—Be careful about feeding too soon. Once about April 1 my hives were overflowing with bees, and I lost 12 or 15 colonies by starvation. It rained several days, and they could not fly for fruit-bloom.

Mr. Adams—I gave my reply on the supposition the bees had enough stores.

Mr. Alford—I would like to be troubled with too many bees. I don't care how early they get strong enough.

Mr. Tracy—Watch for lightness of stores by lifting hives. Always keep full combs on hand to replenish.

Mr. Alford—I feed 4 or 5 bushels of oats. I never touch the hives before April 1, then put in full combs when necessary. There is more danger of starving about June 10 than any other time. But the colonies are so strong then it is hard to get honey in. So I feed inferior honey outside on boards to tide them over.

Pres. Aikin—I feed flour as soon as they will take it, to keep them from bothering my neighbors, and from going to the flour-mills and getting lost, and I would feed anyhow. In feeding liquid honey outside, look out. I will give an instance: Last spring I took about 600 pounds of feed honey, which was fully half water, to an out-apiary of 80 colonies. Arriving at 4 p.m., I poured it over a large quantity of extracting-combs outside, and at once passed along the hives, flinging a few drops of honey on each alighting-board, and tapping or kicking the hives to bring the bees out, and to patch colony on its guard. For a few minutes they did not know where to look for the source of the supply, kept nosing around each others' hives, and, oh my, how cross they were! But when they began to carry the feed in, I could open hives just as in a honey-flow. The honey was all gone at half-past five.

Mr. Alford—Did you visit that apiary next day?

Pres. Aikin—No, but I have done so on similar occasions. There was no robbing. It is just as when a honey-flow stops. Each colony is on its guard.

H. Rauchfuss—Don't buy sugar for that purpose when you can get extracted honey for 5 or 6 cents a pound. It would be profitable to know which goes farther.

F. Rauchfuss—To use honey instead of sugar will assist other bee-keepers.

Pres. Aikin—Outside feeding should be done in the afternoon, as late as possible, so that the honey will all be in the hives before the neighbors' bees know where it is.

Mrs. Booth—I have had no trouble with robbing by this method. I fed to prevent robbing, and succeeded.

Mr. Carlzen—How close to the hives do you feed?

Pres. Aikin—Anywhere; 10 to 50 feet.

Mr. Adams—How often?

Pres. Aikin—As often as necessary.

Mr. Patterson—But what need is there of such broadcast feeding? Why not feed the weak colonies only, and feed them inside? I have a lot of swarms which were without honey in the fall, and I am trying to feed them now.

Mr. Porter—I don't think it advisable to feed at this season of the year. But in June the colonies are all alike and all out.

H. Rauchfuss—Don't fuss with weak colonies by feeding. If you have not enough bees, you can buy up heavy colonies in the vicinity for \$2.00 apiece, and unite your weak colonies with them, if you do not want to kill them.

Mr. Alford—I didn't succeed in keeping the ground clear longer than a year in my neighborhood, by buying up.

Pres. Aikin—In outside feeding, those frames found filled with honey can afterwards be put where they are wanted.

Mr. Adams—How should the feed be diluted?

Mr. Porter—Half and half. Outside feeding is all right.

Pres. Aikin—If it is too thick they will danb each other.

(Concluded next week.)

Questions AND Answers

CONDUCTED BY

DR. C. C. MILLER, MARENGO, ILL.

[Questions may be mailed to the Bee Journal, or to Dr. Miller direct.]

Spraying Fruit-Blossoms.

Is there any danger to bees or honey from spraying fruit-trees in bloom with poisonous solutions? G. S. C.

ANSWER.—Yes, most decidedly. The man who sprays fruit-trees in bloom doesn't know his business. It can do no good whatever to the blossoms, and may do harm. In some places the law will not allow spraying fruit-blossoms.

Bees Need a Cleansing Flight.

I noticed one of the hives in the cellar this morning had the bottom-board and part of the front well smeared with something like propolis. I suppose the colony has bee-diar-rhea. What would you do? I do not want to put them out for at least two weeks yet. There seems to be plenty of bees in the hive, and they are quiet. READER.

ANSWER.—Air the cellar thoroughly, and if you can do so, warm it up at the same time. But nothing will answer so well as to have warm weather come so the bees can fly.

Dividing Colonies for Increase.

As I will not be at home this summer to attend to my bees, I wish you would advise me as to the best way to divide them, as I wish the increase and do not want them to swarm.

Olympia, Wash.

SUBSCRIBER.

ANSWER.—It isn't the easiest thing to know what is the best way to divide without knowing all about the circumstances. Even in the same apiary one colony might be so different in its conditions from another that a different plan should be used. In your case, if I understand rightly, the idea is to prevent the bees swarming, and at the same time have the increase, only being in the apiary on stated occasions. So I'll try to give you one way of doing—a very easy way:

As soon as the bees get fairly to work and begin to increase in numbers, give each colony a second story, putting the hive with empty combs or foundation under the full one. Very likely the bees will work down into this lower story more or less, and at any rate the extra room will have a tendency to prevent swarming.

About the time of the beginning of the main harvest, lift off the upper story and put it on a new stand, leaving the queen on the old stand in the partially empty hive. This makes your work very little, and if you do nothing more each hive put on a new stand will rear its own queen, but it will be a great help if you can give to each a cell ready to hatch.

The Queen-Clipping Device.

Who and where is Mr. Monette? I am anxious to learn more about his queen-clipping machine. J. W. P.

ANSWER.—Mr. Monette is at Chatfield, Minn., and is a well-informed practical bee-keeper. I have never seen his device, but from the explanation given in a late number of this journal, I should think it might be a good thing.

Lucern or Alfalfa—Sweet Clover.

Can you inform me about a grass called lucern? In American Bee Journal of 1894, page 434, in "Bee-Notes by the Wayside," Mr. E. S. Lovesy speaks of lucern. Where can the seed be bought? Is it sweet clover? Will it grow in this State? How many kinds of sweet clover are there, and which is the best for bees? J. R. F.
Rochester, N. Y.

ANSWER.—Lucern is the same as alfalfa. I only know of the white and yellow sweet clover, and I believe the white is best, but I never saw much yellow.

Size of the Hive.

Which is the better size for a bee-hive, 13 $\frac{1}{2}$ x20x10, or 13 $\frac{1}{2}$ x20x12 inches, outside? It seems to me 10 inches in depth is rather shallow. F. M. C.

ANSWER.—Most bee-keepers prefer a frame not so deep as would be taken in a hive 12 inches deep. The additional two inches makes quite a difference about taking out and putting in the frames. Some would prefer the deeper hive on account of the increased capacity, but others would say it is better to have two stories of the shallower frames. Opinions vary widely, and its one of those questions you'll have to settle for yourself. Just now, for myself, I'm inclined to try two stories with standard sized frames.

Turning Honey into Wax by Feeding.

I have had a dim idea or plan in mind for some months, and would like to know what you think of it. I do not think that I can depend entirely for support upon the bees, as the honey-flow is not very heavy. There is no clover, and almost no basswood bloom here, but plenty of locust, some golden-rod and wild flowers. The yield from locust is very uncertain, and cannot be depended upon. I am afraid that what little I could do in the way of artificial pasturage would not be much help.

I like to manage an apiary first rate, but I am afraid I must have some other business than bee-keeping if I stay here. My idea is to give the bees as much freedom as possible in their house-keeping arrangements, examining them once or twice in the spring and summer, and seeing that they are in good condition for winter. Having clipped queens, some one at home can easily manage swarming with the bees in 10-frame Langstroth hives tiered up so as to furnish plenty of room.

As I cannot attend to them closely during the proper time, comb-honey is out of the question. I might do as the Dadant's do, and, during my slack times in business, after the season is over, extract all surplus. But there is a serious objection to extracted honey with me—it is from badly mixed sources, and is what I call strong or rank honey, and does not have ready sale. Therefore I should like to turn those surplus frames of honey into wax.

In the late fall I can easily get away from business for two or three weeks. At that time I should like to feed back the

surplus honey for the wax it will bring. The combs that contain the surplus and those obtained by feeding back should make quite a quantity of wax from 25 colonies of bees. I will give a few points, as I think of them, in favor of the plan:

1. The combs being new, they would be easily worked into wax by any method.
2. It would be A No. 1. in quality, and would bring the highest price.
3. The market price of wax in New York is as high, or higher, than in other cities, I think.
4. The great demand for it would insure a good market.
5. There would be no trouble from granulation in feeding back for wax, as the result is neither comb nor extracted honey, nor winter stores.
6. The feeding back would fill the hives with young bees, which I think is a good point.

As comb and extracted honey seem to be out of the question with me, I should like your advice as to whether you think it would add something to my income to follow this plan. I do not expect great returns, but if it would bring me in a small sum every year—that with the pleasure of handling the bees, would satisfy me. In what way would you feed back the honey? Would you ncap it and place it at a short distance from the apiary, or would you feed it in the hive? If so, how? A. M.

Stamford, Conn.

ANSWER.—If you have 1,000 pounds of extracted honey of so poor quality that you can get only 5 or 6 cents a pound for it, and feed it all back to the bees, I've no kind of an idea that all the wax you could get from it would begin to bring you as much money as the honey before feeding. You can't get all the honey turned into wax, only enough to contain the honey. Don't try it on a large scale.

Bees That Store No Honey.

I have had a colony of bees in a Langstroth hive for about 10 years, and it never swarmed and never gathered any honey, but seemed to be very strong through the honey season. I never look to the hive, as it is so much trouble. Can you tell me what is wrong? R. H. E.
Springfield, Tenn.

ANSWER.—Hard to tell. The bees may be very poor stock, and a change of queen might help. There may be a great deal too much drone-comb, and cutting this out and giving worker-foundation would be a good thing.

Queen-Excluding Honey-Boards and Extracting.

Does it pay to buy queen-excluding honey-boards when producing extracted honey? If they are not used will the queen enter the spers so as to discommode the apiarist?

B. D. D.

ANSWER.—A large number think it pays well. There is a growing tendency to avoid extracting from combs that have brood in them. Still, there may be no great need of excluders if the brood-nest is very large and the extracting-combs are spaced wide apart. Dadant says queens are not so likely to go up if extracting-combs are shallow.

Is Foxglove Honey Poisonous?

1. Is honey gathered from digitalis or foxglove poisonous?
2. "Would you advise starting an apiary in a neighborhood where it grows. AMATEUR.

ANSWERS.—1. I don't know. I don't believe it is. I confess to just a little skepticism about there being much, if any, honey that is poisonous.

2. I might possibly make a mistake in the matter, but I shouldn't pay any attention to foxglove. Even if the honey is objectionable, is there enough of it to make any difference? Perhaps it might be well to say that there is such a thing as honey being in effect poisonous to the bees, even when all right for people to eat. In some places bees get honey that seems all well enough, only the bees can't winter on it, so it might as well be poison for them.

Every Present Subscriber of the Bee Journal should be an agent for it, and get all others possible to subscribe for it.

THE AMERICAN BEE JOURNAL

ESTABLISHED IN 1861

OLDEST BEE PAPER IN AMERICA

PUBLISHED WEEKLY BY

GEORGE W. YORK & COMPANY,

118 Michigan St., CHICAGO, ILL.

REGULAR CONTRIBUTORS:

G. M. Doolittle, of New York. Prof. A. J. Cook, of California.
 Dr. C. C. Miller, of Illinois. Dr. J. P. H. Brown, of Georgia.
 J. H. Martin, of California. Rev. E. T. Abbott, of Missouri.
 Chas. Dadant & Son, of Illinois.
 R. Taylor, of Minnesota.

\$1.00 a Year—Sample Copy Sent Free.

[Entered at the Post-Office at Chicago as Second-Class Mail-Matter.]

Vol. XXXVI. CHICAGO, ILL., APR. 2, 1896. No. 14.



Bees and Honey in Illinois.—The Statistical Report issued by the Illinois State Board of Agriculture at the close of 1895, gives the following for the apiarian industry for last year:

Of the 427,667 pounds of honey produced in Illinois last year, 151,823 pounds was produced in the northern division of the State, 105,925 pounds in the central, and 169,919 pounds in the southern division. The average price received was 13 cents per pound, and the total value, \$56,534.

There were 50,760 colonies of bees reported in Illinois in 1895.

Well, that is a beginning. May be this year beeswax can be included in the Report. We wish they would separate the honey into extracted and comb.

The Next North American Meeting.—We have received the following about the 1896 meeting of the North American Bee-Keepers' Association, from ex-President Emerson T. Abbott, of St. Joseph, Mo.:

I see that the Nebraska people have begun to make arrangements for the next meeting to be held at Lincoln, and I do hope there will be no thought of holding the meeting at any other point. It seems to me that every member, who was at St. Joseph, especially owes it to our Nebraska friends to do all he or she can to aid in fulfilling the implied promise which was made that the next meeting should go to Lincoln. Let us go there next fall, and carry out our part of the contract, and then I for one will vote to have the next meeting at any time or place that seems to offer the best inducements.

I am inclined to think that the bee-keepers of the country will be a unit as to Lincoln when they fully understand the conditions under which the Nebraska people voted to send the last meeting to Canada. EMERSON T. ABBOTT.

We should like to hear from those good Nebraska people that were at the St. Joseph meeting. How do Messrs. Stilson, Whitcomb, and others, feel about meeting at the same time and place as the Grand Army this year?

Corrections.—On page 182, second column, and second line of Mr. Alkin's first remark, the number should be 10 instead of 100. On the same page and column, in the first line of the second paragraph of H. Rauchfuss' second remark, the word "not" was omitted. It should read, "queens will not seldom lay 5 or 6 eggs," etc.

California Bee-Keepers' Exchange.—The By-Laws of the California Bee-Keepers' Exchange, contained in a neat little pamphlet of 23 pages, form a very interesting document. To give any definite idea of what is contained in those 23 pages would take too much space, but a few points may be pointed out:

Membership is confined to actual producers of honey, and admission to membership is carefully guarded. Each member pays an admission fee of \$1.00, and then 75 cents dues four times a year. Each member is required to turn into the Exchange his annual product of honey, but he can sell direct to the consumer in the home market. The Exchange retains 5 per cent. of the proceeds of extracted honey, and 2½ per cent. of comb. The amount thus retained, after paying current expenses forms a guarantee fund. The guarantee fund may be loaned to the permanent fund, and then there's an arrangement by which the members may get back part of the funds of the Exchange if it gets too flush. Debt may be incurred to the amount of \$50,000. The Exchange will receive honey from those not members, charging, besides the expenses of marketing, a commission of 5 per cent. for extracted honey, and 2½ per cent. for comb.

The Exchange seems to mean business, and its career will be watched with very great interest.

The American Bee-Keeper for March, contains a real funny editorial, in which it condemns very strongly what it is pleased to call, "so many 'soft' sayings, self-praise, mutual editorial flattery, and railings over personal domestic misfortunes as are found in the bee-journals of the country."

As an actual fact, in that self-same March American Bee-Keeper, we find items and articles with these suggestive headings:

"Kissing;" "An Attentive Gallant;" "An Old Love-Letter;" "Aud then He Proposed;" "The Fin de Siecle Damsel," etc.

Talk about "soft sayings"—why, the above seem pretty mushy! "People in glass houses," etc.

Apis Dorsata Once More.—The Ontario County, N. Y., Bee-Keepers' Association seems to be determined that the "Giant Bee of India" shall be brought to this country, whether or no. We have received the following from the President of that Association:

CHAPINVILLE, N. Y., March 16, 1896.

MR. EDITOR:—We enclose an open letter to the bee-keepers of the United States, that we would like to have published in the American Bee Journal. We also enclose a copy of the Petition. We had hoped that others more capable would lead in the matter, but becoming disgusted with the delay of those who are supposed to look after the apicultural progress of the country, we decided to move in the matter if we moved alone. We are acting entirely on our own responsibility, with "malice toward none, and charity for all."

Yours fraternally,

EXEC. COM. ONT. CO., N. Y., B.-K. A.

W. F. MARKS, *Chairman*.

The "letter" referred to by Mr. Marks, reads as follows:

OPEN LETTER TO THE BEE-KEEPERS OF THE UNITED STATES.

Fellow Bee-Keepers:—We have prepared for circulation a petition asking the Secretary of Agriculture of the United States to take steps to secure and introduce "Apis dorsata"—the Giant Bee of India—into this country. It is a duty that the Government owes, and is willing to render our industry. (See Report of Secretary of Agriculture, 1893, page 25.) Owing to the rapid disappearance of the bumble-bee the introduction of these bees will soon be a necessity in the successful growing of red clover for seed, if for no other purpose. That these are a distinct and large race of bees there is no doubt, but of their practical value we know nothing, and never will know until we have thoroughly tested them. As progressive bee-keepers and honey-producers, we should not rest until

every spot on this earth has been searched, and every race of honey-bees has been tested. We should do it for the advancement of scientific and progressive apiculture, for ourselves and for posterity. Prof. Cook said in the American Bee Journal, Oct. 25, 1890, page 708:

"It is not creditable to the enterprise of our time that the Orient is not made to 'show its hand,' and any superior bees that may be in existence in Africa, India, Ceylon, or the Philippine Islands, brought here for our use and test."

Our Association has taken hold of this with sincerity, and expects the united support of the bee-keepers of this country, and with their support the end of the nineteenth century will witness a new era in apiculture, in which the bee-keepers of the United States will take a leading part. Life is too short for further delay. There is much to gain and nothing to lose. We are determined to succeed, and want your active assistance.

Yours fraternally,

EXECUTIVE COMMITTEE,

Ontario Co., N. Y., Bee-Keepers' Association.

Copies of these petitions may be obtained by any one who will circulate them, by addressing,

W. F. MARKS, Chapinville, N. Y.

The following is a copy of the Petition which the Ontario Co., N. Y., Bee-Keepers' Association is desirous to have circulated for signatures:

To the Honorable, the Secretary of Agriculture, Washington, D. C.:

The bee-keepers of this country are aware of the existence in the East Indies of a large honey-bee, known as "*Apis dorsata*," reliably reported to be an excellent wax-maker and honey-gatherer. It is believed that these bees would be of great advantage to the apiarian and agricultural interests of the country—a belief which only actual trial will ever confirm. The bee-keepers are thankful, and appreciate all favors received from the Government, yet they have asked for, and have received, perhaps, less than any other branch of Agriculture of equal importance. Realizing that, if we are going to have "*Apis dorsata*" domesticated during "our day and generation," it is time to begin, and since repeated individual efforts have failed to import these bees alive, we, the undersigned bee-keepers and farmers, respectfully and earnestly petition you to take steps to insure their introduction into the United States. In this we represent the sentiment of a majority of the progressive bee-keepers of the country. The Secretary of Agriculture, in his report for 1893, page 25, says: "The Entomologist, Prof. Riley, strongly recommends, as a part of the work for this fiscal year, an attempt to introduce from Ceylon the Giant Bee of India; therefore, the interested attention of bee-keepers in the several States is directed in a special manner to these suggestions."

We, therefore, pray that our petition will receive immediate and favorable consideration.

In order to get an expression from some more of the "progressive bee-keepers of the country" on this subject, we hereby request that all who reply to questions found in the "Question-Box" department of the American Bee Journal, please send us on a postal card their opinion regarding the matter of importing "*Apis dorsata*," as proposed by this Petition. If they will do it at once, we can publish the replies this month yet. Such expression will no doubt be an aid to others in deciding whether or not they wish to help in the undertaking. It seems to us that if, as proposed, "*Apis dorsata*" will prove such a great acquisition, a petition issued by the North American Bee-Keepers' Association would carry with it greater weight when it comes before the Washington authorities.

Kindly let us have a prompt response from those who represent our "Question-Box."

The Rural Kansan has been purchased by the Progressive Bee-Keeper, and its subscribers will hereafter receive the latter paper. So writes Editor Leahy, of the Progressive. It's a good move. In the first place, the "Kansas Bee Journal" was started; then the name was changed to "Rural Kansan," and now it drops out altogether. 'Tis just as we expected. There is no need of more new bee-papers or other farm papers. There are more papers published now

than are well supported, and for any one to rush into the newspaper business these days shows a lack of good sense. Of course, the older papers can stand it all right, no matter if a thousand new ones are started, but what folly it is for any one to throw away good money on such useless and needless ventures. "A word to the wise," etc.

Grading Comb Honey.—This subject is brought up again in Gleanings for March 15, after a hibernation of several years. Mr. Thos. Elliott, of Harvard, Ill., who mentions it, thinks that Dr. Miller's grading, offered in 1892, would suit the majority, and says that what is wanted now is "action," as "the matter was discussed all that was necessary." Mr. Elliott says further:

My plan now is to print small, cheap slips, reading something like this:

The honey in this crate is graded according to the rules laid down by the Miller grade, which is as follows:

FANCY.—Combs straight, white, well filled, firmly fastened to wood on all four sides; all cells sealed; no pollen, propolis, nor travel-stain.

NO. 1.—Wood well scraped, or entirely free from propolis; one side of the section sealed with white cappings, free from pollen, and having all cells sealed except the line of cells next the wood; the other side white, or but slightly discolored, with not more than two cells of pollen, and not more than ten cells unsealed beside the line of cells touching the wood; comb fastened to the wood on four sides.

NO. 2.—Three-fourths of the total surface must be filled and sealed; wood well scraped of propolis.

NO. 3.—Must weigh at least half as much as a full-weight section. For the Classes of honey I would suggest the four already in use, sufficiently understood from the names alone; namely, LIGHT, AMBER, DARK, MIXED.

Parties buying or selling honey will please quote this grade.

The grade marked on the crate would designate the contents. Larger copies could be printed for the use of commission men and dealers. A slip could be put into every crate sold, and placed where they would do the most good. Having once gained a foothold, it would surely spread.

THOS. ELLIOTT.

In a footnote to the foregoing, Editor Root said:

This was a compromise of the grading suggested by J. A. Green and W. C. Frazier—the grading proposed at Albany, and the one at Chicago, combining, as I understand it, according to the best judgment of the Doctor, the best points in all. Some of the former gradings were too exact, and too difficult to comply with. Others were too wordy. If I remember correctly, no other grade since that time was suggested, and I am going to assume, at least, that our readers at the time had no particular objection to it.

I was sorry that the subject of grading was dropped some years ago, without coming to any decision. I have always felt that a poor grading was better than none at all, providing that all could adopt the same system in referring to their qualities of honey. Now, lest we get into the same snarl we did before, in criticising and suggesting until no grading was left, I would suggest that, if this Miller is not so "awfully" bad, we adopt it.

I am of the opinion the bee-journals can do as much as, or more, in this line than any association or convention of bee-keepers. If they (the journals) were to agree on some system of grading, and then request all their commission men to quote prices on honey according to that grading, it would not take very long before it would be universally applied. Gleanings stands ready to co-operate with any of its cotemporaries.

We think the great difficulty will be to get the commission men to co-operate with the bee-papers in this matter, still a trial could do no harm, and might lead to much good. The American Bee Journal also "stands ready" to join hand with the other bee-periodicals in an attempt to establish a system of grading. Surely, there is need enough for it. Shall we all try to have the "Miller grading" used?

Honey as Food and Medicine.—A new and revised edition of this 32-page pamphlet is now issued. It has 5 blank pages on which to write or paste recipes taken from other sources. It is just what its name indicates, and should be liberally distributed among the people everywhere to create a demand for honey. It contains a number of recipes on the use of honey as food and as medicine, besides much other interesting and valuable information. Prices, postpaid, are: Single copy, 5 cts.; 10 copies 30 cts.; 50 for \$1.00; 100 for \$1.75. Better give them a trial. Send all orders to the Bee Journal office.

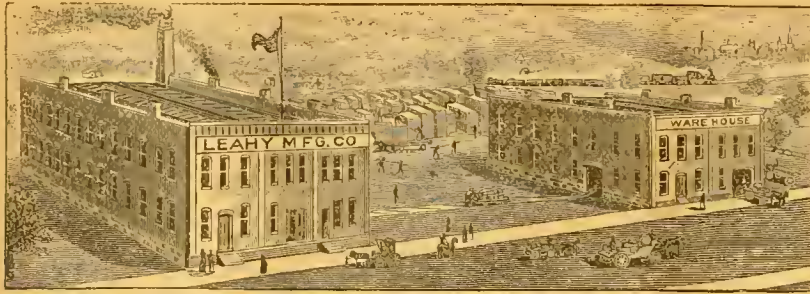

Largest Factory in the West **COMPLETE STOCK.**
Good Supplies and Low Prices
Our Motto.

READ THIS—Mr. Keyes says: The 100 pounds of Extra-Trip Foundation you sent us is superior to anything he ever saw; and I think the same. R. L. TUCKER, Wewahitchka, Fla.
 Dear Sirs:—The Sections came duly to hand. Indeed, they are very nice. Yes, sir; they are as good as the best. CHARLES H. THIES, Steelville, Illinois.
 Leahy Mfg. Co.:—I have received the bill of goods. I must say they are the choicest lot of Hive-Stuff I have ever received from any place. I admire the smoothness of your work, and your close selection of lumber. Yours very truly, O. K. OLMSTEAD, Orleans, Nebr.
 Dear Sirs:—The Sections arrived in due time, and are all O. K. so far as examined. They are simply perfection. I can't see how you can furnish such goods at such low prices. I hope you may live long and do well. Yours respectfully, Z. S. WEAVER, Courtney, Tex.
 Gents:—I received the "Higginsville Smoker" all O. K. It's a dandy; please find enclosed stamps for another. Yours truly, OTTO ENDERS, Oswegatche, N. Y.
 Gentlemen:—I have bought Supplies from nearly all the large manufacturers by the carload, and I must say yours are as good as the best. Indeed, in many lines they are the best. It is a pleasure to handle them. E. T. FLANAGAN, Belleville, Illinois.
 The above unsolicited testimonials are a fair sample of hundreds we receive. Our prices are reasonable and the "Higginsville Goods" are the best.
The "Higginsville" Goods are for sale by the following parties:
 Chas. H. Thies, Steelville, Ill. E. T. Flanagan, Belleville, Ill.
 Henry L. Miller, Topeka, Kans. E. A. Seeley, Bloomer, Arkansas.
 J. W. Rouse & Co., Mexico, Mo. P. J. Thomas, Fredonia, Kans.
 And by a number of others.
 If you need a Carload of Supplies, or only a Bee-Smoker, write to us. Remember, we are here to serve you, and will, if you give us a chance. **A Beautiful Catalogue Free.**
 Address, **LEAHY MANUFACTURING CO., HIGGINSVILLE, MO.**
 49A *Mention the American Bee Journal.*

CHEAPER THAN EVER

Hilton's White T Super
Chaff Polished Foundation
Hives Sections Smokers
 And everything needed in the apiary.
1896 Catalog of 36 pages free.
GEO. E. HILTON,
 13Atf FREMONT, MICH.
Mention the American Bee Journal.



ONE MAN WITH THE UNION COMBINATION SAW
 Can do the work of four men using hand tools, in Ripping, Cutting-off, Mitring, Rabbering, Grooving, Gaining, Dadoing, Edging-up, Jointing Stuff, etc. Full Line of Foot and Hand Power Machinery Sold on Trial. Catalogue Free.
SENECA FALLS MFG. CO.,
 46 Water St., SENECA FALLS, N. Y.
 1Aly *Mention the American Bee Journal.*

Dadant's Foundation in Chicago!

No other Goods kept here. Send for Price-List.
CHAS. DADANT & SON,
 118 Michigan St., CHICAGO, ILL.
 13Atf Please mention the Bee Journal.

SECTIONS

\$1.50 a M. 3 M. \$4.25.
 These ARE NOT Seconds, but perfect Sections. As they are not up to our present high standard, we wish to close them out. Sample free. Widths—7 to foot, 1 1/2-16 in., and 2 in.
Catalog of Bees & Supplies FREE.
I. J. STRINGHAM,
 105 Park Place. NEW YORK, N. Y.

MOVED TO LARGER QUARTERS!

In order to take care of the business properly at this Branch, we have moved to 118 Michigan St., [3rd Floor], within two blocks of the Northwestern Passenger station, where we've secured larger quarters, making ample room for a **Full Assortment**. Send along your orders, remembering that we guarantee satisfaction, and at prices as low as the best quality of Goods can be furnished for. **Special Prices** on a lot of Stock we are closing out. Send for CATALOG and a List of Goods at Special Prices.

In order to close them out quickly we offer some good Sections, for the next 30 days, or while they last, at these special prices:

White Sections, 1 1/4 x 1 1/4.
 25,000 7-to-ft. at these low prices—1,000 for \$1.75; 2,000 for \$3.00; 5,000 for \$7.00

TRIANGULAR=TOP FRAMES.

We also have a stock of Triangular Top Langstroth Frames at these Special prices:

100 for \$1.00; 300, \$2.70; 500, \$4.00; 1000, \$7.00.

On all freight orders of \$5 or less, at this Branch, please add 25c. for cartage. Catalogue Free.

The A. I. ROOT CO., 118 Michigan St., CHICAGO, ILL.

Geo. W. York, Mgr. Please mention the American Bee Journal.

MUTH'S HONEY EXTRACTOR
 PERFECTION
Cold-Blast Smokers,
Square Glass Honey Jars, Etc.

For Circulars, apply to CHAS. F. MUTH & SON, Cor. Freeman & Central Aves., Cincinnati, O. Send 10c for Practical Hints to Bee-Keepers.

A Bargain—EARLY QUEENS.

119 Colonies Italian Bees in Chaff Hives: two acres land; good house; excellent well.
Early Queens—Tested, \$1.50; Untested, 75c.
E. L. CARRINGTON,
 11A4t PETTUS, Bee Co., TEX.

General Items.

A Good Colorado Report.

I traded a hog for two colonies of bees in February, 1893. I never had any use for bees prior to that time. That summer I received from one hive 96 pounds of comb honey; from the other 6 pounds, and no swarms. The spring of 1894 I had them transferred to new 8-frame hives, and they cast 7 swarms. Then I went into those two hives and cut 9 queen-cells, leaving a queen in each hive. I got 300 pounds of comb honey that season.

Last year the 9 colonies ran up to 28, when I again went "queen-hunting," and got—well, I never stopped to count them, but I had all our glasses, teacups, etc., full of queens, and then some left over. I sold 20 colonies for \$160 to one man, one colony to another for \$7.00, and sold 350 pounds of honey from the 7 colonies left. As it rained a great deal last summer, it cut our honey crop short. My bees are in fine condition now, and with the assistance of the American Bee Journal I hope to do some good work in the near future in the bee-business.
 A. O. KOUNS.

Rocky Ford, Colo., Feb. 22.

The Enemies of Bees.

Harris, in his work, "The Honey-Bee," says, "Although the Greeks credited the swallow with being a robber of apiaries, we have no reason to charge our swallows with the same crime." No, not our pretty little friend that builds under the eaves; but in many parts of the world there is a far larger species of swallow, known here as the "wind swallow," and probably existing in California, and generally in warm latitudes. The way they go for bees is a caution! Two or three times a day a flock of them comes to my apiary for a meal. They are very daring, and most difficult to shoot, for they dart over the hives with the rapidity of lightning, and the loud and frequent snap! snap! as the poor bees are caught in their beaks, drives the helpless bee-keeper almost to distraction. At much cost of time and powder I have managed lately to bring down three of these audacious rascals, and have found as many as 20 bees in the stomach of one! Nor does shooting scare them away; they will swoop backwards and forwards over the hills till they have had their fill.

The swallow—or at least the larger species of this bird—is about the bee-keeper's biggest enemy! Let apiarists in warm latitudes (where all of the swallow tribe may hitherto have been regarded as harmless) make a note of this, and when found make a note, if he can, of the swallow, too.

I am about to get up a shooting party, of which each member will pay, say a dollar, into the pool, the slayer of the greatest number to take the same. The flock visiting my apiary consume at least 1,000 bees a day, and probably vastly more!

Another enemy of the bee is the Bee! "Bee's cruelty to bee, makes countless thousands kick." But I am happy to say that since I have adopted the paint cure, robbing in my yard is a thing of the past. I open and expose hives and combs with impunity whether honey be coming in or not; but accompanying me in my rounds is the indispensable paint-pot; as soon as the work is done, and the hive closed, the brush (not too wet) is drawn two or three times over the flight board, and just above the flight hole, and no robbers trouble after that—even let them have begun an attack and be crowded about the entrance as thick—well, "as thick as thieves," a dab of the paint-brush at once sends them off about their business, nor do they return. I find this a simple and most efficacious remedy for robbers, and worth many times my annual subscription to the American Bee Journal, in which a year or two ago I happened to see it mentioned.

Another enemy of the bee—in his own

BUY "DIRECT FROM FACTORY," BEST MIXED PAINTS

At WHOLESALE PRICES, Delivered FREE For Houses, Barns, Roofs, all colors, and SAVE Dealers profits. To use 5-4 years. Endorsed by Grange & Farmers' Alliance. Low prices will surprise you. Write for Samples. O. W. INGERSOLL, 289 Plymouth St., Brooklyn, N. Y.

12A13 Mention the American Bee Journal.

MURDERED

We have killed high prices. Give me a trial order and be convinced that good Queens can be reared for 50 cts. each. Untested, 50 cts.; Tested, 75 cts. Golden Italians, 3-Banded Italians, and Silver-Gray Carniolans, all the same price. Best of References given.

C. B. BANKSTON.

13Atf CHRISMAN, Burleson Co., TEX.

Mention the American Bee Journal.

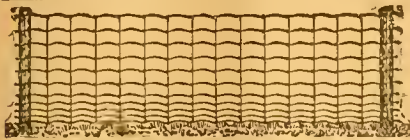

About All The Fun There Is

in farming nowadays is preparing for the future. Permanent fences should be built of Page Woven Wire, and when good times come, be ready to give your whole attention to business.

PAGE WOVEN WIRE FENCE CO., Adrian, Mich.

WHEN ANSWERING THIS ADVERTISEMENT, MENTION THIS JOURNAL.

Better than 10% Discount!

By comparing the following with the customary prices of Foundation they will be found to be better than a 10% discount. Prices are f. o. b., cut to any size.

COMB FOUNDATION.

	1lb	5lb	10lb	25lb
Heavy or Medium.....	45c	42c	40c	38c
Light.....	45c	44c	42c	40c
Thin.....	50c	49c	47c	45c
Extra Thin.....	55c	54c	52c	50c

Samples Free. Watch this advertisement for changes. Better buy now, before prices advance. BRESWAX—30c cash, 32c trade, delivered. HIVES, SECTIONS, SMOKERS, ETC., always in stock. PRICES are right. Order before the rush. W. J. FINCH, Jr., 11Atf SPRINGFIELD, ILLS.

Mention the American Bee Journal.

SUCCESSFUL INCUBATOR
Our magnificent new catalogue giving full information regarding artificial Hatching & Brooding and treatise on poultry raising sent for 4c stamps. Circular free.

Write now, Des Moines Incubator Co., Box 73 Des Moines, Ia.

11A9t Mention the American Bee Journal.

California

If you care to know of its Fruits, Flowers Climate or Resources, send for a Sample Copy of California's Favorite Paper—

The Pacific Rural Press

The leading Horticultural and Agricultural paper of the Pacific Coast. Published weekly, handsomely illustrated, \$2.00 per annum. Sample Copy Free.

PACIFIC RURAL PRESS,

220 Market St., SAN FRANCISCO, CAL.

TEXAS QUEENS.

If you are in need of Queens, let me have your order. Price-List Free.

8A26t J. D. GIVENS, Lisbon, Tex.

Mention the American Bee Journal.

camp—is that abominable beast—the *laying worker*. We are taught that once they are established there is hardly any means of getting rid of them, for they will accept neither queen-cells, virgin, nor fertilized queens. Well, I rather think I have found out a method of overcoming these senseless objectors to accept a proper Head of the State. All I do is this:

I open the hive, powder them well with a dredger (a tin canister like a biggish pepper-box) containing flour scented with a few drops of the essence of peppermint, then dredge a fertile queen and pop her in, and all's well! Dredging with scented flour, whether for the above purpose or for uniting colonies, beats wet spraying all to fits, and the dredger is always ready and handy—no plan to equal it for introducing queens.

I don't know what I should do without the American Bee Journal, though it is hard to say what bee-keepers in this part of the world can do *with* it, unless it should happily some day contain directions for securing a regularity in the rainfall. Indeed, it is three years since there has been any rainfall worth terming such—there is a sort of a honey-flow on just now, or there would be if the strong winds (which begin regularly at sunrise and stop blowing at sundown) would only cease; and as our white population is not much over half a million, there's not much of a market when we do manage to get a little honey. Bee-keeping is an interesting occupation, and that's about all—in many parts of the globe; though there may be parts where there's money in it. "Oh, where oh where, is that happy land?" Not here, not *here*, my child!

S. A. DEACON.

Mossel Bay, South Africa, Jan. 22.

Colorado Bee-Keeping.

Stopping a couple of days at this place (Pueblo), I have accidentally run across a copy of the American Bee Journal containing a letter from Mr. F. L. Thompson, of Arvada, Colo., in which he speaks of his average yield, and further remarks on the yield of some one at Rocky Ford, Colo., as being an average of 150 pounds. I had reason to make inquiry last fall as to where I could get comb honey, and found the average of the *best* apiarists in that region to be about 60 pounds, while from that it went to nothing. It sounds to me as if Mr. Thompson's informant must have caught a piece of a Kansas cyclone in his mouth.

The average in Mr. Thompson's neighborhood was not even 25 pounds per colony, and much sold as comb was cut out of brood-frames, and I *guess* Mr. Thompson extracted quite a bit from the same source.

Mr. Thompson ought to know that there were yards near him that yielded almost nothing. One gentleman I heard of, from 400 colonies, between Denver and Littleton, got some 2,000 pounds, and would need to feed 4,000 pounds to winter.

My observation leads me to think that there are many parts of Colorado with all the bee-keepers they need, and that they will in many places crowd each other soon. Prime swarms are often sold in Jefferson county at 50 cents each, put into hives, so you may judge for yourself as to the profits. Durango, Colo. JOHN SETON.

Section Supers—Mountain Laurel.

On page 715, W. L. asks Dr. Miller for advice in regard to frames with top-bars for holding sections. I have some with hinged bottom-bars, in use the past season, and am very favorably impressed with them. The first cost of making is a little more, but that is more than offset by the convenience and saving in time of scraping and cleaning sections, for they will come off as white and clean as when put on the hive.

I also have had a pattern-slat super in use the past two seasons, and unless further experience changes my mind very materially, I would not discard either, if I could have the old T super given to me. Some might object to the bars or slats on

Honey-Clovers & Buckwheat SEED FOR SALE.

We have made arrangements so that we can furnish seed of several of the Clovers



Sweet Clover—the Great Honey-Plant.

and Japanese Buckwheat, by freight or express, at the following prices, cash with order:

	5lb	10lb	25lb	50lb
Alsike Clover.....	\$.80	\$1.35	\$3.50	\$ 6.25
Sweet Clover.....	1.10	1.80	4.25	8.00
White Clover.....	1.50	2.40	6.00	11.00
Alfalfa Clover....	.75	1.20	3.00	5.25
Crimson Clover....	.65	1.00	2.50	4.00
Jap. Buckwheat...	.30	.45	1.00	1.50

Prices subject to market changes.

The above prices include a good, new 25-cent two-bushel bag with each order. Add 25 cents to your order, for cartage, if wanted by freight.

Your orders are solicited.

GEORGE W. YORK & CO., CHICAGO, ILLS.

WIND... MILLS
Tanks Shellers Pumps Cutters Horse Powers

Many sizes, all from best material, best workmanship. Stay where you put them.

Practically storm proof. Write us. CHALLENGE WIND MILL & FEED MILL CO., No. 18 River Street, BATAVIA, ILLS.

14E4t Mention the American Bee Journal.

FIRST-CLASS BEE-SUPPLIES

at ROCK-BOTTOM PRICES. Send for Catalog to W. J. STAHLMANN, 14A4t WEAVER, MINN.

ORIGINAL BINGHAM SMOKERS

Wonderful Record!

HAVE LASTED 17 YEARS.

BEST ON EARTH.

Always Give Perfect Satisfaction.

My cool Wire Handle and Bent Nose were patented 1892, are the original, my best invention since my open or direct draft Patent, 1878, that revolutionized Bee-Smokers. My Handle and Nose Patent bent all the other smoker noses. None but Bingham Smokers have all the best improvements. If you buy genuine Bingham Smokers and Honey-Knives you will never regret it. The "Doctor," 1/2-inch larger than any other smoker on the market—3 1/2-inch stove, by mail, \$1.50

Couqueror, 3 "	"	1.10
Large, 2 1/2-in. "	"	1.00
Plain, 2-in. "	"	.70
Little Wonder, 2-in., wt. 10 oz.		.60

Bingham & Hetherington Honey-Knives, 80 cents.

T. F. BINGHAM, Farwell, Mich.
7Atf Mention the Bee Journal.

Promptness Is What Counts!

Honey-Jars, Shipping-Cases, and everything that bee-keepers use. **Root's Goods at Root's Prices**, and the best shipping point in the country. Dealer in Honey and Beeswax. Catalogue Free.

Walter S. Ponder
162 Mass. Ave.
INDIANAPOLIS, IND.
Mention the American Bee Journal.

The Patent Wood-Veneer Foundation.

Bee-keepers should give it a test, and my All-Wax Foundation. I will guarantee there is no better made. Now is the time to send wax to be worked up. Send for Samples and Catalogue with low prices. Wax wanted at 30c cash.

AUG. WEISS, Hortonville, Wis.
12A13t Please mention the Bee Journal.
Mention the American Bee Journal.

PATENT WIRED COMB FOUNDATION

Has No Sag in Brood-Frames

Thin Flat-Bottom Foundation

Has No Fishbone in the Surplus Honey.

Being the cleanest is usually worked the quickest of any Foundation made

J. VAN DEUSEN & SONS,
Sole Manufacturers,
Sprout Brook Mootokomery Co., N. Y.
Mention the American Bee Journal.

BEGINNERS.

Beginners should have a copy of the Amateur Bee-Keeper, a 70-page book by Prof. J. W. Rouse. Price 25 cents; if sent by mail, 28c. The little book and the Progressive Bee-Keeper (a live, progressive 28-page monthly journal) one year, 65c. Address any first-class dealer, or

LEAHY MFG. CO., Higginsville, Mo.
Mention the American Bee Journal.

SPRAYING

Will Produce **PERFECT FRUIT**

We tell you all about spraying and care of fruit in our 32-pg. illustrated book—free. Our Pumps and Nozzles via highest honors in every test

The Deming Co., Salem, O.
W. Agts., Henion & Hubbell, Chicago

Mention the American Bee Journal.

account of removing the bees so much farther from the brood, but with a hive full of bees, and plenty of honey in the fields to gather, I do not think they are particular about going 1/4 or 3/8 of an inch farther to store their honey, and without the above conditions I fail to get much work done in the supers.

MOUNTAIN LAUREL.—I have seen a great deal of late in the bee-papers about mountain laurel and poisonous honey. I don't know that I can say anything that will throw any light upon the subject, but we have plenty of laurel here; the leaves are very poisonous—it answers to the description of the plant given by Novice, on page 146, with the exception of its growing on wet ground. It grows here exclusively on dry ridges, and quite plentifully within 50 or 60 rods of my apiary. When in full bloom it is very beautiful. People come quite a distance to gather the flowers, but I have never heard of any one being injured by eating honey in this vicinity. In fact, I do not remember having ever seen a honey-bee working on laurel. I have often wondered if they ever did work on it. Now my attention has been more particularly drawn to it, I will take a little more notice the coming season, and see what I can learn.

But is it possible for a bee to gather and store a poisonous article, without its being injured by it? I think not, and I shall always believe, until more positive proof has been brought forward, that those people were made sick from some other cause than eating honey. I think we can safely trust to the instinct of the bee without fear of being poisoned by eating honey which they have gathered. Animal instinct is very acute in discriminating between the wholesome and unwholesome plants.

We have had cattle running among it for several years, and during the past dry seasons, when everything was parched to the earth, and every other bush and shrub was browsed down, the green leaves of the laurel were passed by untouched by them. In a very few extreme cases, when the ground had for a long time been covered with snow, and their desire for something green got the better of their judgment, I have known sheep to be injured by browsing the leaves.

A. D. WATSON.
Mansfield, Pa., March 9.

Winter Problem Solved.

I have been experimenting with alfalfa, white and Alsike clover, and buckwheat, on an extensive scale for the last 15 years. I have solved the wintering problem and the pollen-theory humbug to my own satisfaction. I have also succeeded in rearing a queen in December, and had her fertilized. I am sorry to state that my bees, that are on the summer stands, are as full of brood as they ought to be by the middle of April or first of May.

I. C. NIEMOLLER.
Tarnov, Neb., Feb. 25.

From a Maryland Bee-Man.

The more I read every page of the grand old American Bee Journal, the worse bee-fever I get. I would have it if it cost me \$2.50. I talk it up to every one who has a few bees.

I had 12 colonies and bought 16 about one month ago, and have them not at home. I am three miles from the mountain, and one mile from the Potomac river, where there are lots of blue thistle.

I noticed in the Bee Journal that farmers could not keep bees and make them a success. No kid-glove farmer can grow wheat or corn, or raise stock if he doesn't give them proper attention, and he will say farming doesn't pay. I can say farming does pay. It pays me about 10 per cent. If you don't attend to bees properly, like stock, they won't pay.

I saw in last week's Bee Journal that a Chicago bee-keeper has bees in a log that he got on the World's Fair grounds, and he values it very highly because it was cut on

WHITE-FACED BLACK-BREASTED POULTRY

40 Standard Breeds Illustrated & fully described in my new Poultry Book. Reliable information for poultrymen & intending buyers. Good stock Ducks & Geese; also Shetland Ponies. Send 6c in stamps

E. H. COOK, Box 27, Huntley, Ill.

Mention the American Bee Journal. 4A13t

IF YOU WANT THE BEE-BOOK

That covers the whole Apicultural Field more completely than any other published, send \$1.25 to Prof. A. J. Cook, Claremont, Calif., for his

Bee-Keeper's Guide.

Liberal Discounts to the Trade.

NEW MAMMOTH POULTRY

GUIDE showing colored plate of chickens in natural colors. Finest book ever published. Almost 100 pages. Tells all about Poultry for Profit or Pleasure. Price only 15c.

JOHN BAUSCHER, JR., Box 94 Freeport, Illa.
12A7t Mention the American Bee Journal.

Kansas Bee - Keepers!

SAVE FREIGHT

A Car-load of "Higginsville Bee-Supplies" just received. GET MY CATALOGUE.

HENRY L. MILLER,
355 Shawnee Ave. TOPEKA, KAN.
1A1St Mention the American Bee Journal.

COMB FOUNDATION!

Wax always wanted for Cash or in Exchange for Fdn. or other Supplies. My trade is established on **Low Prices** and the merit of my **Foundation. Orders filled promptly.**

WORKING WAX INTO FDN. BY THE LB. A SPECIALTY. Wholesale prices to dealers and large consumers. Send for Prices and Samples to—**GUS DITTMER, AUGUSTA, WIS.** Reference—Augusta Bank. 1Atf

Mention the American Bee Journal.

DO YOU LOVE YOUR WIFE

Then save her strength, save her health, save her beauty and make her happy by buying her a **FAULTLESS QUAKER DISH WASHER.**

It is a marvel of simplicity and a wonder for utility. Washes, rinses, dries & polishes in two minutes. Lasts a lifetime. It sells quickly.

Everybody wants it when they once see it. Agents make money rapidly. Write today for terms etc

The Quaker Novelty Co. Salem, Ohio.

13A4t Please mention the Bee Journal.

HONEY We have a large amount of Pure No. 1 Alfalfa we will sell cheap.

SEED Of those great honey-producing plants—Alfalfa and Cleome or Rocky Mountain Honey-Plant. Alfalfa seed at 7 cts. a lb.

Boss bee-escape Warranted the best, simplest and quickest Escape on the market. Sent postpaid to any address for 50 cts. It can be returned at our expense if it is not as represented, or we will send the Escape on trial to any bee-keeper wishing to test it in good faith. We are agents for the **Ferguson Patent Hive** with double-case and Wicket-Gate Honey-Board, with the Escape. It is the easiest, quickest hive to handle for the production of comb honey. Address,

E. S. LOVESY & CO.,
355 6th East St., SALT LAKE CITY, UTAH.
Mention the American Bee Journal. 9Atf

The Bee-Keepers' Guide:

Or Manual of the Apiary,

BY PROF. A. J. COOK.

This 15th and latest edition of Prof. Cook's magnificent book of 460 pages, in neat and substantial cloth binding, we propose to give away to our present subscribers, for the work of getting new subscribers for the American Bee Journal.

A description of the book here is quite unnecessary—it is simply the most complete scientific and practical bee-book published to-day. Fully illustrated, and all written in the most fascinating style. The author is also too well-known to the whole bee-world to require any introduction. No bee-keeper is fully equipped, or his library complete, without "THE BEE-KEEPER'S GUIDE."

For Two New Subscribers and Your Own Renewal.

Send us Two New Subscribers to the Bee Journal and your own renewal (with \$3.00), and we will mail you a copy of Prof. Cook's book FREE as a premium, and also a copy of the 160-page "Bees and Honey" to each New Subscriber. Prof. Cook's book alone is \$1.25, and we club it with the Bee Journal for a year—both together for only \$1.75. But surely anybody can get only 2 new subscribers to the Bee Journal for a year, and thus get the book as a premium. Let everybody try for it. Will you have one?

GEORGE W. YORK & CO.,
CHICAGO, ILLS

historic grounds. I have one that was cut Dec. 5, 1895, on the battle-field of Antietam, with the bees still in it. It had about 40 pounds of honey. I am going to transfer the bees the last of this month, or first of April.

The outlook at present is very good for another big crop of peaches, so next summer it will be "honey and peaches."
Keedysville, Md. L. A. HAMMOND.

A "High-Minded" Testimony.

I hope it will not be out of place right here to mention what a great help the American Bee Journal has been to me—an experienced "tenderfoot." I have referred to different articles contained therein many times, any one being worth more than twice the price of subscription. Just to-day I have received information on "a heap" of subjects that will no doubt save me trouble and expense later on.

I am a pretty "high-minded" fellow, hibernating 9,000 feet above sea-level. Fruit-trees stop growing nearly a mile lower down, but wild flowers are abundant way above "timber-line."

"Yes—the bee sings here—I confess it—
Sweet as honey—Heaven bless it;
Yet she'd be a sweeter slinger
If she didn't have no stinger."

LESLIE ALEXANDER.

Silver Cliff, Colo.

He's "Agin" the Amalgamation.

The "old reliable" American Bee Journal is always a welcome visitor.

In reference to the amalgamation of the National Bee-Keepers' Union and North American Bee-Keepers' Association, as a member of the former I have this to say:

I am most emphatically opposed to the uniting of the two organizations, for the following reasons: As it has already been understood, the object of the two organizations are altogether different, the North American Bee-Keepers' Association being more for pleasure, while the National Bee-Keepers' Union is an organization, strictly speaking, for business only, and, in my humble opinion, should so remain, for I think it will be conceded that business and pleasure cannot be successfully carried on together—one or the other is bound to suffer, and that is sure to be the business part of the organization.

Dr. C. C. Miller cites us (on page 3) to the fact that the German societies combine business with pleasure. I think his citation is not well taken. In the first place, the influences in the United States (or rather in North America) that govern these things are not quite the same as they are across the "big pond," in Germany. Over there, as I understand it, everything of a business nature (at least) is controlled by the government. If a bee-keeper over there, or any one else, is found adulterating his honey, or some human hyena attempts to persecute a bee-keeper or fellow tradesman, or any one else for that matter, he is punished in short order, while over here hell-hounds can do these things (or attempt to, at least) and escape punishment. Consequently, we need just such an organization as the National Bee-Keepers' Union, devoted to nothing else but strictly business.

It strikes me that when we go to giving a premium, or some inducement to join the North American Bee-Keepers' Union (as some have proposed since this discussion started), we fail to fully appreciate the object for which the National Bee-Keepers' Union was inaugurated, and puts the organization on a par with some little children's affair, where it is necessary to make some kind of a present in order to induce the children to join, and stay joined. The way I see these things is this:

If the National Bee-Keepers' Union isn't worth belonging to strictly for business, and for the protection each and every member is entitled to, and is bound to receive, without any other attachments of any

WOVEN WIRE FENCE

Over 50 Styles The best on Earth. Horse high, Bull strong, Pig and Chicken tight. You can make from 40 to 60 rods per day for from 14 to 22c. a Rod. Illustrated Catalogue Free. KITSELMAN BROS. Ridgeville, - Indiana.

48 Etf Mention the American Bee Journal.

DO NOT ORDER UNTIL YOU HAVE WRITTEN US FOR PRICES ON

The "Boss" One-Piece Section



Also D. T. Hives, Shipping-Crates and Other Supplies.

We have completed a large addition to our Factory, which doubles our floor room; we are therefore in better shape than ever to fill orders on short notice. Send for Price-List

J. FORNCROOK,

WATERTOWN, Jeff. Co., Wis., Jan. 21, 1896.

Mention the American Bee Journal.

Barnes' Foot-Power Machinery.

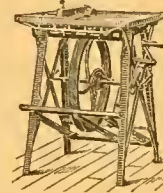

Read what J. I. PARENT, of CHARLTON, N. Y., says—"We cut with one of your Combined Machines, last winter 50 chaff hives with 7-in. cap, 100 honey-racks, 500 broad frames, 2,000 honey-boxes and a great deal of other work. This winter we have double the amount of beehives, etc., to make and we expect to do it with this saw. It will do all you say it will. Catalogue and Price-List

Free. Address, W. F. & JOHN BARNES, No. 995 Ruby St., Rockford, Ill.

Mention the American Bee Journal.

The RURAL CALIFORNIAN

Tells all about Bees in California.

The Yields and Price of Honey; the Pasturage and Nectar-Producing Plants; the Bee-Ranches and how they are conducted. In fact the entire field is fully covered by and expert bee-man. Besides this, the paper also tells you all about California Agriculture and Horticulture. \$1.50 per Year; Six Months, 75 cents. Sample Free.

THE RURAL CALIFORNIAN, 218 N. Main St., LOS ANGELES, CALIF.

Mention the American Bee Journal.

\$3.00 Worth for \$2.00!

Until further notice, we propose to give you a chance to get some good reading-matter for the long winter evenings, at half price.

Send us \$2.00, and we will mail you your choice of \$2.00 worth of the following booklets, and also credit your subscription to the American Bee Journal for one year:

- Poultry for Market and Profit..... 25c
- Our Poultry Doctor..... 30c
- Turkeys for Market and Profit..... 25c
- Capons and Caponizing..... 30c
- Rural Life..... 25c
- Preparation of Honey for the Market..... 10c
- Bee-Pasturage a Necessity..... 10c
- Hive I Use, by Doolittle..... 5c
- Foul Brood, by Dr. Howard..... 25c
- Foul Brood, by Kohnke..... 25c
- Foul Brood, by Cheshire..... 10c
- Bee-Keeping for Profit, by Dr. Tinker..... 25c
- Kendall's Horse-Book—Eng. or German..... 25c
- Silo and Silage, by Prof. Cook..... 25c
- Hand-Book of Health, by Dr. Foote..... 25c
- Maple Sugar and the Sugar Bush..... 35c
- Potato Culture, by Terry..... 40c
- Carp Culture, by Root & Finney..... 40c
- Strawberry Culture, by Terry & Root..... 40c
- Biennen Kultur, by Newman [German]..... 40c
- Winter Problem in Bee-Keeping [Piece]..... 50c
- Bee-Keepers' Directory, by Henry Alley..... 50c
- Advance Bee-Culture, by Hutchinson..... 50c
- 5 Honey as Food and Medicine..... 25c

GEORGE W. YORK & CO.,
CHICAGO, ILLS.

HATCH Chickens BY STEAM— With the MODEL EXCELSIOR Incubator
Simple, Perfect, Self-Regulating. Thousands in successful operation. Lowest priced Best-class Hatcher made. GEO. H. STAHL, 114 to 122 S. 6th St., Quincy, Ill.
Send 5c. for Illus. Catalogue.

Mention the American Bee Journal.

1896 SAVE MONEY 1896

If you want first-class **ITALIAN QUEENS** FOR BUSINESS, Foundation at Wholesale Prices, Hives, suited for the South, or **SUPPLIES**, send for Price-List—to

J. P. H. BROWN, AUGUSTA, GA.

INCUBATORS
Our 160 page, finely illustrated Combined Poultry Guide and Catalogue will tell you what you wish to know about **PROFITS IN POULTRY**

We manufacture a complete line of Incubators, Brooders and Poultry Appliances. Guide and Catalogue 10c. (stamps or silver) Worth one Dollar. Reliable Incubator & Brooder Co., Quincy, Ills.

38E15t Please mention this Journal.

Cheap for Cash—ITALIAN BEES

In 10-frame [size 9½x17½] hive, \$4. Italian Queens, \$1.50. Address,

OTTO KLEINOW,

122 Military Avenue, DETROIT, MICH.

12E3t Please mention the Bee Journal.



Bee Supplies

Largest Stock and Greatest Variety in the West. **BEST** Goods at **LOWEST** prices. Cat. of 80 pages FREE.

E. KRETZMER, RED OAK, IOWA.

Mention the American Bee Journal. 12E8t

Bees, Queens, Nuclei—We will sell, the coming season, 500 Two-Frame Nuclei, with a Choice Warranted Queen, at \$2.50 each. Special prices on large orders furnished. **LEININGER BROS.** 6Etf FT. JENNINGS, OHIO.

WHEN ANSWERING THIS ADVERTISEMENT, MENTION THIS JOURNAL.

That Queen-Clipping Device Free!

PLEASE READ THE FOLLOWING OFFER:

We have arranged with the inventor of the new Queen-Clipping Device (Mr. Monette), to offer it to our present subscribers as a Premium for getting new subscribers.

Send us just *one new name* for the American Bee Journal a year (with \$1.00), and we will mail you the Queen-Clipping Device FREE; and will also send a copy of Newman's 160-page book—"Bees and Honey"—to the new subscriber. Or, the Queen-Clipping Device will be sent postpaid for 50 cts. But why not get it as a Premium by the above offer? You can't earn 50 cts. any easier. Almost every bee-keeper will want this Device. See page 130 (Feb. 27) for full description of it. Complete directions accompany each one sent out. It is a most ingenious and useful article. Address,

GEORGE W. YORK & CO., 118 Michigan St., Chicago, Ill.

No. 1 4 1/4 x 4 1/4 Snow-White Sections \$2.00 per 1,000.



For the purpose of introducing our One-Piece Section to the bee-keepers generally, we have concluded to make the price \$2.00 per 1,000 for the month of April. Now is the time to get your Sections cheap. We have a choice lot of Section Lumber, gotten out of young timber, and we can furnish you the nicest Section to be had. Write for Sample Section Free.

THE MARSHFIELD MFG. CO.,

MARSHFIELD, Wood Co., WIS.

March 23rd, 1896.

14 Ctf

Mention the American Bee Journal.

kind whatsoever, then it is not worth belonging to.

Now, the National Bee-Keepers' Union has been, and is yet, a *grand success*, and if something else is not hitched onto it, why, it is bound to *continue a grand success*. Again, if the North American Bee-Keepers' Association has been such a successful and delightful organization (Dr. C. C. Miller, page 3), why do the members of it want to join an organization which is devoted strictly to the dry routine of business?

If I were a member of the North American Bee-Keepers' Association, and was tired of it (no matter from what cause), the easiest way for me to get out of the matter would be to simply drop out, and then join anything else I chose to.

Again, I can't see where the members of the North American, who live outside the United States, are going to derive any benefit from membership in the National Bee-Keepers' Union. If they will, I should be glad to have some one tell me through the columns of the American Bee Journal just how it is going to be done.

These, Mr. Editor, are a few hasty thoughts I have attempted to place before the readers of the American Bee Journal. Denver, Colo. WM. L. BACKENSTO.

Gathering Honey and Pollen.

Bees have been gathering some honey and pollen since Feb. 4.

SIGEL BRANTIGAM.

Cliff, New Mex., March 9.

Changeable Weather.

We are having winter to-day, the snow being 6 inches deep, and still snowing. On March 10 the bees were carrying pollen nicely; to-day they are covered with snow. Sutton, Tenn., March 12. WM. WEBB.

Poor Prospect for a Crop.

The prospect for a honey crop is somewhere else this year. It won't be as bad as 1894, but the bees will have to rustle in this neighborhood to gather enough for themselves. AMATEUR.

Miramar, Calif., March 16.

Likes His Own Hive Best.

After trying various kinds and shapes, I now use a hive of my own make, and find I succeed best with it. It has 9 frames, 12 3/4 inches wide by 13 3/4, inside measurement; 12 inches deep, with the Hoffman frame. In cold weather the bees cluster in the center of the hive, as all bee-men know, and when more honey is wanted by the cluster, they move upwards, and do not spread out side-

wise; so the hive is deeper, and the bees fill it fuller, and take the honey in the entire hive as they progress upward. I used to use the Langstroth hive, which is a good hive, only in my judgment it is too long and shallow; the bees will cluster in the center and starve after eating honey from the center, and have plenty of honey in each end; that is, where they are wintered on the summer stands. I winter mine on the summer stands, in my hives, and have never lost a colony from starvation, or from any other cause, in this hive. I have strong colonies, and moth-proof. Here in "drouthy Kansas" my bees yielded me, last season, \$10 per colony, aside from the increase. My hives supports a super holding 21 4 1/4 x 4 1/4 sections. I tier up two and three supers high.

Now you have my experience of several years in the bee-business, and to my notion I have the best hive except one, and that is the Hubbard hive. E. A. WILSON.
Eatonville, Kans., Feb. 22.

Always Something to Learn.

I have taken the American Bee Journal I think for over 25 years, and always found it interesting and beneficial to one interested in bee-keeping. I am of the opinion that one never gets too old to learn, or gets perfect in any great science. I often tell those who come to me for information in bee-work, that they will find that the more they learn the less they will know. That is, the more they learn the more they will find to learn.

The bee-business in this part of Iowa (the central part) for the past three or four years has been very poor, owing to our extreme dry weather, especially that of 1894. I lost the majority of my apiary by the great Iowa drouth of 1894. Still, I am not discouraged, and hope to make a good showing for 1896, as our white clover has again got a good start. Of course, the coming summer will again decide the question. Our bees, I think, owing to the good fall bloom, went into winter in good condition. A part will require some feeding early in the spring. So I say to all bee-keepers, look out for this part of your duty.

J. W. SANDERS.

LeGrand, Iowa, Feb. 22.

Heavy Winter Losses, Etc.

The loss of bees has been very heavy here this winter and spring, so far, on account of their poor condition. Last fall was the worst on bees of any since I have been keeping bees. Some of my neighbors have lost from 50 to 75 per cent. I have lost 9 colonies out of 63, but if I had not fed I would have lost like the rest, so it pays to take care of the bees.

Bees are working on the maple-bloom to

Honey & Beeswax Market Quotations.

CHICAGO, ILL., Mar. 20.—White clover and basswood comb is sought after in preference to any other, and commands a better price and now sells at 15c. for clover and 13@14c. for basswood. Other white comb honey sells at 11@12c.; dark, 8@9c. amber, 9@10c. and very slow of sale. Extracted is unusually dull, with large amounts on sale. White clover and linden, 6@7c.; dark and amber grades, 4 1/2@5c.

Beeswax, 28@30c.

R. A. E. & Co.

KANSAS CITY, Mo., Mar. 18.—The demand for comb and extracted is fair. We quote: No. 1 white, 1-lbs., 13@14c.; No. 2, 10@11c.; No. 1 amber, 11@12c.; No. 2, 8@10c. Extracted, white, 5 1/2@6c.; amber, 5@5 1/2c.

Beeswax, 20@22c.

C. C. C. & Co.

CINCINNATI, O., Mar. 19.—Demand is fair for best white comb honey, at 12@14c. in a jobbing way. Extracted is fair at 4@7c. Supplies of both are fair.

Beeswax is in good demand at 25@30c. for good to choice yellow. Arrivals are not adequate to the demand. C. F. M. & S.

PHILADELPHIA, Pa., Mar. 6.—Honey has been selling freely, there being considerable call for comb honey, and the war in Cuba has made extracted honey sell to the baking trade who previously used Cuba honey. We quote: Fancy comb, 15c.; fair to good, 11@13.; fair, 9c. Extracted, 4 1/2@5 1/2c.; pure white clover, 10c. Beeswax, 30c. W. A. S.

NEW YORK, N. Y., Mar. 23.—There is a fair demand for white comb honey, and the market is well cleaned up. We have another car now in transit from California. We quote same: 12@14c. Plenty of buckwheat comb is on the market, and same is moving off slowly at 8c. Extracted, all grades, dull, at unchanged prices.

Beeswax firm at 30@31c.

H. B. & S.

List of Honey and Beeswax Dealers.

Most of whom Quote In this Journal.

Chicago, Ills.

R. A. BURNETT & Co., 163 South Water Street.

New York, N. Y.

HILDRETH BROS. & SEOLKEN,
120 & 122 West Broadway.
CHAS. ISRAEL & BROS., 486 Canal St.

Kansas City, Mo.

C. C. CLEMOMS & Co., 423 Walnut St.

Buffalo, N. Y.

BATTERSON & Co., 167 & 169 Scott St.

Hamilton, Ills.

CHAS. DADANT & SON.

Philadelphia, Pa.

WM. A. SELSER, 10 Vine St.

Cincinnati, Ohio.

C. F. MUTH & SON, cor. Freeman & Central avs.

Convention Notices.

UTAH.—The Utah Bee-Keepers' Association will hold their semi-annual meeting in Room 54, City and County Building, Salt Lake City, Apr. 6, 1896, at 10 a.m. All are invited. "In union is strength. By industry we thrive." Come, and bring your friends, and enjoy a good time. A full program in the interest of the industry will be presented. The Association needs your aid; then let every one do his full duty for our own interest and self-preservation. GEO. E. DUDLEY, Sec.

Provo, Utah.

WANTED to Exchange—St. Bernard Pups, fine ones, for something useful. Address with stamp—SCOTT BRILLHART,
Millwood, Knox Co., Ohio.

J. W. TAYLOR

—HAS THE BEST—

Italian Queens for Sale

Untested, ready now, 75c. apiece; 6 for \$4.25, or 12 for \$8.00. Tested, \$1.25. Select Tested, best, \$2.00. Pay for Queens on arrival. I guarantee safe arrival and satisfaction.
14 A 9t OZAN, ARK.

Bottom Prices

**BRING US BIG TRADE.
GOOD GOODS KEEP IT.**

If you want the best supplies that can be made at a little less cost than you can buy the same goods for elsewhere, write to us for low prices. 1896 Catalogue now ready—ask for it and a free copy of **The American Bee-Keeper** (36 pages).

Address,
**THE W. T. FALCONER MFG. CO.,
JAMESTOWN, N. Y.**
Mention the American Bee Journal.

ROOTS Prices Reduced on Dovetail Hives and Sections. A full line of Apian Supplies in stock to fill orders promptly at lowest prices for Best Goods. 36-page Catalogue Free.
JNO. NEBEL & SON, High Hill, Mo.
Mention the American Bee Journal. 4A26t

I ARISE



TO SAY to the readers of the **BEE JOURNAL** that **DOOLITTLE**

has concluded to sell **BEES and QUEENS**—in their season, during 1896, at the following prices:

One Colony of Italians on 9 Gallip frames, in light shipping-box \$8 00
Five Colonies... x. 25 00
Ten Colonies... 45 00
1 untested queen. 1 00
6 " queens 5 50
12 " " 10 00
1 tested Queen... \$1 50
3 " Queens. 3 50
1 select tested queen 2 00
3 " Queens 4 00

Select tested queen, previous season's rearing . 4 00
Extra Selected for breeding, THE VERY BEST. 5 00
About a Pound of BEES in a Two-frame Nucleus, with any Queen, \$2.00 extra.

☞ Circular free, giving full particulars regarding the Bees and such class of Queens.
Address

G. M. DOOLITTLE,
12A25t BORODINO, Onon. Co., N. Y.

BEES QUEENS
Smokers, Sections, Comb Foundation, and all Apian Supplies cheap. Send for FREE catalogue. E. T. FLANAGAN, Belleville, Ill.
6A26t Please mention the Bee Journal.

TAKE NOTICE!

BEFORE placing your orders for SUPPLIES, write for prices on 1-Piece Basswood Sections, Bee-Hives, Shipping-Crates, Frames, Foundation, Smokers, etc.

PAGE & LYON MFG. CO.
NEW LONDON, WIS.

WHEN ANSWERING THIS ADVERTISEMENT, MENTION THIS JOURNAL.

CARLOADS



Of Bee-Hives, Sections, Shipping-Cases, Comb Foundation, and **Everything** used in the Bee-Industry.

I want the name and address of every Bee-Keeper in America. No reason why you cannot do business with me. I have Cheap Lumber and Experienced Workmen; a good Water-Power Factory and know how to run it. I am supplying Dealers as well as consumers. Why not you? Send for Catalogues, Quotations, etc. **W. H. PUTNAM,** RIVER FALLS, Pierce Co., Wis.
1E
Mention the American Bee Journal.

28c Cash Paid for Beeswax!

For all the **good, pure yellow BEESWAX** delivered to our office till further notice, we will pay 28 cents per pound, cash; or 32 cents for whatever part is exchanged for the Bee Journal, Honey, Books or Seed, that we offer. If you want **cash promptly** for wax, send it on at once. Dark or impure wax not taken at any price. Address plainly,

George W. York & Co., 118 Michigan St., Chicago, Ill.

SECTIONS, BEE-HIVES, SHIPPING-CASES

We make a Specialty of these Goods, and defy Competition in

QUALITY, WORKMANSHIP AND PRICES.

☞ Write for Free Illustrated Catalogue and Price-List.

G. B. LEWIS COMPANY, Watertown, Wis.

☞ Be sure to mention the American Bee Journal when you write. 1E

19th Year Dadant's Foundation 19th Year

Is still in the lead, for we use all the latest improvements, including the NEW PROCESS, and still make the best goods. Remember that we do not use any acid to purify our beeswax, and that is why our Foundation preserves the smell of the honey and is more acceptable to the bees, than any other. It is kept for sale by

T. H. Strickler, Solomon City, Kansas.
G. K. Hubbard, Fort Wayne, Ind.
L. Hanssen, Davenport, Iowa.
C. Theilmann, Theilmanton, Minn.
E. C. Eaglesfield, Berlin, Wis.
E. T. Abbott, St. Joseph, Mo.
J. M. Jenkins, Wetumpka, Alabama
John Rey, East Saginaw, Mich.
Vickery Bros., Evansville, Ind.

The Jennie Atchley Company, Beeville, Texas.
C. F. Muth & Son, Cincinnati, Ohio
E. Kretzmer, Red Oak, Iowa.
Jos. Nysawander, Des Moines, Iowa.
G. B. Lewis Co., Watertown, Wis.
James Reynolds' Elevator Co., Poughkeepsie, N. Y.
Louisiana Bee-Keepers' Supply Manufactory, Donaldsonville, La.
Page & Lyon, New London, Wis.

and many other Dealers. All agree in saying that no goods are better than ours.

Those of our customers who formerly bought through Thos. G. Newman can get our Foundation in **Chicago, Ill.**, by addressing us at **118 Michigan Street**. We keep no other goods there.

We make a specialty of **Veils and Veil Stuffs** of best quality, cotton and silk.

Langstroth on the Honey-Bee, Revised.

Bee-Keepers' Supplies, Smokers, Sections, Tin Pails, etc.

Samples of Foundation and Tulle FREE with Circular. Instructions to beginners with Circular. **BEESWAX WANTED.** Send us your address.

CHAS. DADANT & SON,

Mention the American Bee Journal.

HAMILTON, Hancock Co., ILL.

PLANTS All the leading varieties of choice plants and trees. **Koonce Pear** (frost proof) and other valuable sorts at popular prices. Send for descriptive Catalogue FREE. **TREES**
PLEASANT VALLEY NURSERIES -- ARTHUR J. COLLINS, Moorestown, N. J.

BEAUTIFUL
Transparent
TOUGH

and yet
PLIABLE.

REDUCED
PRICES

NEW - PROCESS WEED FOUNDATION
—DELIGHTS ALL—

RECENT COMPARATIVE TESTS IN FLORIDA
show that the old-process dipped wax will sag or stretch in the hive nearly five times as much as that by the new Weed process.

Our New Sanded and Polished Sections
and Bee-Hive Material are the Finest Product
that money and machinery can turn out. **CATALOG FREE.**

THE A. I. ROOT CO., MEDINA, OHIO.

118 Michigan St., Chicago, Ill.

Syracuse, N. Y.

1024 Mississippi St., St. Paul, Minn.

AMERICAN BEE JOURNAL

DEVOTED EXCLUSIVELY TO THE INTERESTS OF HONEY-PRODUCERS

ESTABLISHED 1861
THE OLDEST BEE-PAPER IN AMERICA

Published Weekly, at \$1.00 per annum.

Sample Copy sent on Application.

36th Year.

CHICAGO, ILL., APRIL 9, 1896.

No. 15.



Swarming—Its Cause and Prevention.

BY GEO. F. ROBBINS.

I notice by the report of the Chicago meeting of the Illinois State Bee-Keepers' Association (page 103), that the "swarming-fever" struck the convention. I wish I had been there to doctor them. I could have cured them. In other words, I know why bees swarm. There are a great many things about bee-keeping that I do not know, many that I am uncertain about, many things I think, but this one thing I know. And knowing the causes, I practically know to just what extent swarming can be prevented, and how to do it.

Now if you will all give me your attention, I will tell you what I know, and add a little, perhaps, that I do not know, but I will tell you when I come to that. And when you have read what I have written, if it is too hard for you to remember, file away this number of the American Bee Journal, or cut out this article and paste it in your scrap-book. Then if ever this matter begins to exercise you again, just look this up, read it, and set your questionings at rest.

It is not enough to say that it is the nature of bees to swarm, therefore, swarming cannot be prevented. Indeed, the premise is not exactly true. It is not enough to say it is the nature of corn to grow, therefore it will grow. In order to reproduce and propagate the species, Nature has implanted in the grain of corn a germ, which, if fed and nursed accord-



House-Apiary of E. Goulding, Wellesley, Mass.—Winter View.

ing to Nature's laws, will grow and become a sprout, then a stalk—otherwise it will remain a latent germ or perish entirely.

The bent to swarm is not primarily the nature of bees—it is not itself the germ. It is only a form or outgrowth of the instinct to reproduce and propagate the race, which is im-

planted in the bee as in all other species of the animal world. That instinct is the organic principle—the germ which, if properly fed and nursed, develops into the disposition to swarm. Now, the question is, Can this want of their nature be supplied some other way? If it can, and we can discover the "how," the problem of the prevention of swarming is solved.

Obviously the first thing to do in order to arrive at an answer to this question is to ascertain, if we can, the more direct causes of the swarming-impulse. Now is the time for me to tell you why bees swarm. Notice:

There are two sets of conditions that conspire to this end.

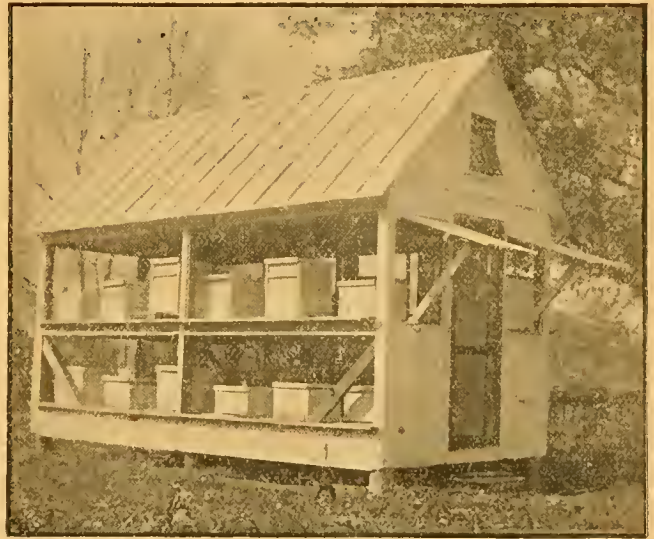

Summer View of the Goulding House-Apiary—See page 232.

The first set ministers chiefly to the instinct for procreation. They are these:

First—As conditions wax and wane, they have the effect to correspondingly stimulate and depress the energies of bees and queen alike. I would tell you why this is so, but it is too large a subject to enter into now. The same circumstances may be present in the same degree in May and September—in June and August. Yet in the former two months life and enthusiasm are thriving, while in the latter they are dying out.

Second—Anything that rouses bees to action incites to brood-rearing. I have known a warm spell in November, with some disturbance of the brood-chamber in preparing bees for winter, to start the queen to laying.

Third—The favorable stimulating conditions we find present in the earliest part of the season are:

1st. The weather grows warmer and more settled. 2nd. Honey and pollen begin to come in. How a little smell of nectar will excite bees is one of the familiar sights of the apiary. 3rd. The bees that are hatching out in ever-increasing numbers can nurse still greater quantities of brood. That is, one young bee can feed and care for more than one egg and larva. 4th. There are an ever-increasing number of house-bees that really want something to do.

Fourth—In no respect is the stimulating effect of these things more potent than upon the queen. A flow of nectar hardly rouses the bees themselves more than its ingathering, and the hatching of young bees as well, does the one bee whose strongest instinct and only duty is to lay eggs,

Fifth—This, the climax of the series, consists in the fact that in the month of June all these conditions are present in the highest degree. Throughout the season thus far there has been an almost uninterrupted boom. Now the boom has reached its height. The weather is the most propitious, more honey is coming in than ever before, there is more brood in the hive, more bees hatching, more house as well as field bees with nervous powers stimulated to the utmost, and as a result of all these things, the queen will lay more eggs than at any time in the season.

It may be you knew all these things before. If you did not, you know them now. But I want to note particularly how these conditions, in their effects, forces upon the instinct for procreation, that same ponderous thought I gave you awhile ago. All incited to brood-rearing, and upon that one thing centers all the activities of the hive. The propensity to store honey itself is subsidiary to this, even though upon it the bees may for a time expend the greater share of their energies.

Right at this juncture the other set of conditions arises. Honey is now coming in so rapidly that there is not sufficient room in the hive—now pretty well filled—in which to store it. Bees will not go into empty chambers and build comb in which to store honey so long as there is any empty comb in which to put it. It is much the simplest and quickest way to run it into the receptacles already constructed. When they are finally driven into surplus apartments, the process of secreting wax and building comb is slow. Hence, every empty cell in the brood-chamber, and often perhaps those in which eggs have been laid, are speedily filled with honey. As fast as the brood in the outer circle of the brood-nest hatches, the comb is filled and sealed, while all through the nest are cells filled temporarily, especially in the latter part of the day. Often there is scarcely a cell left in which the queen can lay an egg. As a result, we have now the following set of conditions:

First—At the very time the queen wants to lay the most eggs, she is most hampered for room.

Second—At the very time the nurse-bees are prepared to feed the most brood, there is least of it—unsealed—in the hive.

Third—At the very time the nervous powers of the house-bees are most excited, they must, to secrete wax, be most quiet. This is an item that alone would be insignificant, but along with the other causes it helps to swell the aggregate.

Fourth—The blood of the queen acquires an enriched character owing to the check in egg-production. It is Hasty that says this, but it meets my indorsement.

Fifth—The vessels in the bee-anatomy in which are stored the supplies for future brood-rearing become "turgid" (Hasty again)—simply gorged for want of brood to which to give the food.

It is easy to see that we have here a state of things that makes queen and bees alike uneasy and discontented. Now it is that, according to Nature's law, the instinct to reproduce their kind, which cannot be satisfied in the hive under existing circumstances, develops into the impulse to swarm.

If what I have written is true—and it is—the way to prevent swarming is briefly this: Allow unrestricted room for brood-rearing. Simply have a large brood-chamber, then to keep the bees from filling it with honey, have plenty of available storage-room above—that means empty combs. Notice what Mr. Draper said at the convention (page 103). He uses a large Quinby hive, keeps plenty of combs in the upper story, and runs for extracted honey. In that way he keeps down swarming. Of course, I could have told you so. I knew swarming could be prevented that way, before he said so.

But how to prevent swarming when running for comb honey, and not at the same time seriously interfere with honey-storing, is the problem. Four methods have been tested, and some success claimed with each, viz.:

1st. Remove the queen, or cage her in the hive for about ten days.

2nd. Replace queens with young ones before swarming season arrives.

3rd. Remove the brood a short time before the swarm is likely to issue—perhaps a week, more or less.

4th. Practice shifting the bees back and forth from one hive to another. Only one of these methods exactly meets the conditions laid down. This is the third one. It is easy to see why the first method succeeds. I do not know what to say about the second one. If the fourth one is successful it is because—

1st. Any considerable derangement of the internal affairs

of the hive tends to disturb and divert the bees from their purpose for a time.

2nd. It takes some time to get queen-cells started in the hive that catches the bees.

3rd. It meets in part the conditions that cause swarming.

It takes some time for the boom in the colony that has for awhile been so depleted of bees, and to some extent of honey, to again reach its height. By this means swarming can be delayed until the sum of conditions that cause it begin to stagnate and decline. I think I kept two colonies, sitting side by side, from swarming, by this method in 1893, when a regular swarming mania had struck my apiary. I simply set one hive off the stand about a foot, turning the entrance at right angles (or less) to the other, and in four or five days put it back, and set off the other one. Of course, I shifted the supers with the bees. About four shifts did the work. For two years I have had no chance to test the plan, as the seasons have been so poor that there has been no swarming at all. If it is a success, the Langdon non-swarming device, or something like it, is just the thing. I hope I shall have occasion to try this method the coming season, then it may be I will tell what I have learned.

I have frequently prevented a colony from swarming entirely by taking away the brood. Sometimes I have replaced with empty combs, but if I want to get a good crop of comb honey, I remove every comb, putting the queen and older bees into an empty brood-chamber contracted to five or six frames, the latter containing only starters of comb foundation. This, of course, is practically artificial swarming.

There are some other points upon which I would like to touch, such as requeening *a la* Hutchinson, and the possibility of breeding out the disposition to swarm, but as this is already one of the longest articles I have ever written, I forbear.

Mechanicsburg, Ill.



Peppermint as a Honey-Plant.

BY CARSON VAN BLARICUM.

Peppermint is a stranger to the readers in general, as a honey-plant, but known as an oil-product, although quite frequently found growing by roadsides, in pools of water, and waste-places. Its greatest value is supposed to be that of its relation to our medical fraternity. It is not produced as universally as wheat or corn, and for this reason it is not familiarly known to a large number of our inhabitants. Only a small area is given up to its culture, nor is this the only reason why the industry is not becoming larger. Only certain acclimated localities will produce oil, and to produce a valuable crop of oil it must blossom. Bees cannot gather nectar from hay or corn stover, but must visit numberless multitudes of most fragrant blossoms; likewise, if peppermint does not bloom in a locality in profusion, its value does not become apparent to the oil-producer or bee-keeper.

Peppermint is generally harvested before it attains the required age to give a very large flow, and seems to secrete nectar in larger quantities the older it gets. You go to your nearest wild mint plat; gather the roots—take them home and plant on your lowest ground, in rows 33 inches apart, and place two or three long roots side by side, or so as to make them as continuous as possible. These plants will give you the required flowers, but no oil. You can plant on high or low ground, but with better success on low land or muck marsh.

The plant is a perennial, smooth stem, decumbent, four-angled; leaves opposite, ovate, acute at end, serrate, thin, flowers in dense, axillary clusters, small, pink or light purple, labiate, very slender petioles.

The oil is volatile, and belongs to the genus mentha (menthol for catarrh is made by a special process from the oil, which contains from 30 to 50 per cent. of its specific gravity, of menthol). For cholera plague it is used in large quantities, both in home and foreign climes. For rheumatism it has no superior in immediately relieving the most acute attack of this much-dreaded disease, when mixed one-half ounce pure oil with one-half ounce of either chloroform or laudanum; agitate briskly, and apply externally, but under no consideration apply near the heart.

Peppermint is planted in continuous rows and cultivated like corn or potatoes, or a vegetable garden. Although it seeds freely, it is propagated from the roots only. Planted in March or April it attains in five months (at maturity) from three to five feet in height. It begins to blossom in August and September, and for its profusion of flowers is likened unto a clover or buckwheat field. When in full bloom it entirely covers from view the dark green foliage of the mint plants,

until there is only a grand, a sublime tint of crimson. In the morning the gentle breeze sways the whole field with a majesty seldom seen or brought to mortal eyes, and the mellow rays of a rising sun reflects itself in splendor on the dewy sparkling mass with tints of purple crimson which holds the viewer in ecstasy and delight. What a contrast is presented to my gaze as I write, which is only a dreary waste at present, but soon to be one mass of blazing glory.

Bees work on peppermint from morn till night, and if the condition of the weather permits, or with very heavy dews a bountiful flow is secured. On mornings, after a heavy dew, the happy hum of rejoicing of the industrious bees is plainly heard, which are always heavily laden. Their appearance, when tolling on peppermint, is much like that of basswood—you will find them scattered around about the hives in all states of fatigue.

The honey has a consistency a little thicker than that of water, being real light in color for a fall flow of nectar.

Next season I shall endeavor to save specimens of honey, if the plants blossom in sufficient numbers so bees can gather it in quantities for examination.

Last year the peppermint did not bloom much, and the bees did not store any surplus, yet they worked on the bloom wherever a blossom was found, showing that the plant is one of our honey-plants, and should be added to our nectar-bearing flora, and being in a decided drouth where the plants barely retained vitality to nourish their existence.

Ellis, Mich.



The Importation of Apis Dorsata.

BY PROF. A. J. COOK.

The movement made by our apiarian friends of New York, to secure the importation of *Apis dorsata*, is, I believe, a movement in the right direction. I think that our friends are to be congratulated on the energy and method which they are devoting to this subject.

A few years ago the late Dr. C. V. Riley came to see me at the Michigan Agricultural College, where I was then laboring, to discuss bee-keeping and the ways and means by which its interests could be promoted. My first reply to his question was that it seemed to me that there was nothing in which the Government could lend its aid with more assurance of success than to make an effort to import races or species of bees which were as yet untested by apiarists of intelligence. I suggested to him that it seemed to me from the information which we had already received through Mr. Benton, that there was great hope of a decided improvement in bee-culture could we once introduce *Apis dorsata* into the apiaries of the United States. I stated at that time that Mr. Benton had proved that *Apis dorsata* could be made to work in the ordinary hive, and that with reasonable caution was perfectly tractable. The fact of the size of the bee and its immense combs, and large production of honey in India and Ceylon, its native clime, gave us reason to hope that it would be a decided acquisition in our country, both in the production of honey and of wax. It seemed to me then—it seems to me now—that there is altogether too much of possibility, not to say probability, of important gain with this bee in our apiaries for the trial not to be made. It is also too great an undertaking to be left with private individuals or even to our societies or the stronger Bee-Keepers' Union. It is one of the enterprises which demands the strong arm of the Government for its successful prosecution.

I suggested to Dr. Riley at that time, that as Mr. Benton had already been to the native home of *Apis dorsata*, and had only been prevented by accident from successfully introducing it into his apiary in Ceylon, and from thence to our own country, that he was the person of all persons to act as the agent of the Government in this important undertaking. Mr. Riley signified to me on that occasion that he agreed with me entirely, and would at once do all in his power to secure this important action on the part of the Government. I have no doubt but it was this interview that led to the employment of Mr. Benton in the Department of Agriculture, where he has been at work ever since the time of my interview with Dr. Riley.

Dr. Riley wrote afterward, that through some technicality—some red-tape obstacle in the way of a law or act preventing the spending of money in other countries—he was unable to carry out this project. Later, Assistant Secretary Willets, of the Department of Agriculture, informed me of this hindrance in the way of all such enterprises which required the spending of money in foreign countries. I presume that the same law, act or ruling is still in the way of action; yet we have the man

in Government employ who should be secured to do this work. It goes without saying that Mr. Benton is just this man.

It is further evident that the Departments at Washington, and also Congress, are very susceptible to influence if the people are only wide enough awake in regard to any such matter. I feel very sure that if every State, county, town and neighborhood of the United States, where bee-keeping is an important industry, would send in petitions to the Department of Agriculture and Congress, urging the importation of *Apis dorsata*, the enterprise might be carried to successful execution. I very heartily commend, then, the enterprise and work of our brother bee-keepers of New York State, who have gone to work so wisely to secure this important action. I hope that every one of our bee-keeping journals, as well as all of our societies, not to speak of individual bee-keepers, may give this matter hearty support.

Of course we do not know that *Apis dorsata* will thrive at all under the conditions of our climate and productions. Of course we can never know that any such undertaking will prove a success; but where there is so much of hope and prospect, there is going to be with enterprising people an earnest desire that something should be done. This desire will often be so strong that private individuals ought never to be asked to do. This is another reason why the Government should take this measure in hand, and why all bee-keepers of our country should urge the enterprise upon Congress and the Department of Agriculture.

I would suggest that the Manager of the Bee-Keepers' Union, who is supposed to have ex-officio his keen eye upon the interests of apiculture all over our country, should at once correspond with the Department of Agriculture, and learn what obstacles are in the way of sending Mr. Benton to India or Ceylon in pursuit of *Apis dorsata*. After this information is gained, through the bee-journals, the bee-keepers of the country can be informed just what they are to ask for, and just how they are to proceed to secure prompt and successful action. Then I would urge that our societies and individual bee-keepers take hold of this matter with the energy which would insure success. It seems to me that the good sense of our people will not be slow in pushing this matter to the utmost. It is certainly true that the Government never yet has done very much in aid of this important industry. Surely, if the matter is put before the officers of Government in its true light, we may expect prompt and successful action. I hope there will be a general expression through the bee-papers in regard to this matter.

Claremont, Calif.

[We'd like to suggest that before Mr. Benton is sent after *Apis dorsata*, Prof. Cook get him to do as he agreed at the Toronto Convention, viz: To turn over the balance of the St. Joseph Convention report, for which he received pay a year and a half ago. Until Mr. Benton does this duty, we can't conscientiously endorse him for anything. And neither should any one else.—EDITOR.]



The Blooming of Sweet Clover.

BY PETER J. SCHATZ.

On page 33, M. M. Baldrige says I must have made a mistake when I said that sweet clover blooms here the forepart of June. I do not mean that sweet clover always blooms the forepart of June. It all depends upon the kind of winter and spring we have. In the year 1894 sweet clover did not bloom until the latter part of June, because the month of May was very cold; we planted corn on the 23rd with our overcoats on. But the month of May, 1895, was warmer, excepting three or four frosts, which did not affect sweet clover at all; it grew right along, and the first blossoms I noticed were on June 8.

Sweet clover has grown here ever since I can remember, and they call it an obnoxious weed. There is about two acres in sweet clover, 30 rods from the apiary, which is never cut (excepting the way I described in my former article), and yet it does not die out. Farmers cut it all along the roadway, sometimes cutting it four or five times in a year; it grows eight or ten feet in height, and seriously interferes with traffic, when teams pass each other, and still it keeps growing and blooming, which goes to show that the roots do not die very easily, and the consequences are that the bee-keeper gets the benefit.

In my article on page 807 (1895), I wrote concerning the cutting of sweet clover. By cutting it the middle of August, it will send forth new sprouts and blossom, and at the same time you have the seed sowed for the next season; but if you

harvest the seed, of course that is another thing. Our honey crop would be cut mighty short the latter part of July if it were not for sweet clover, and I have yet to see the second cutting fail to yield honey.

On page 3, Dr. Miller says: "For the sake of those who say that if sweet clover is cut for fodder it must be cut while young, and that spoils the chance of the bee-keeper," etc. Now, you do not need to cut it while young to make it sprout vigorously; it will sprout vigorously without cutting it while young, at least it will here, unless sown on a solid stone pavement. It sometimes grows so dense that it is almost impossible to wade through it.

Again, Dr. M. says: "In this part of the country I think I'd much rather have it cut while young, for then it blooms a little later, and where white clover yields well, the early blooming of sweet clover is not so desirable as that which comes after white clover is gone." Yes, if white clover yields well—that's it. How many bee-keepers last season claimed that white clover was a failure. Had it been sweet clover, there would have been no reason to complain. Bee-keepers that have to depend upon their bees for their bread and butter could not run such a great risk by cutting down sweet clover, while white clover might be a failure, and consequently would not be of any benefit whatever.

Why not give sweet clover another clip while basswood blooms, and that would make it a little after basswood got through? White clover has been a failure here—bees would not touch it. I would rather have a profusion of bloom than to have nix, and I think that most bee-keepers are of the same opinion, for then you are assured of some surplus honey.

Lemont, Ill.



Commission Men and Bee-Keepers.

BY L. M. WILLIS.

(Read at the Wisconsin State Convention.)

Commission men would appear, at first glance, to be a subject somewhat foreign to the interest of a bee-keepers' convention, and yet, commission men are so closely connected with our business, that they are oftentimes the means through which our profits are increased, or the labor of an entire season lost.

The commission business, as a business, is just as legitimate as any other calling, and in the past, commission men, have, to a large extent, been regarded almost in the light of a necessity. There is no question regarding their value to the producers of farm and garden crops, and, I believe that they have very often made dollars for those who entrusted the sale of their goods to them.

I do not say, that the best means for the disposal of our products, is through the commission men, because I know that there are plenty of men—producers themselves—who are fully qualified to handle and sell our surplus. And these men, as a natural consequence, would take more interest in our well-doing, than those whose only work is to sell the product of others' labor, for the fee obtained in the making of such sale.

At the present time, the honey-producers, as a class, are almost completely at the mercy of commission men; and, as a general thing, meekly submit to whatever treatment the men in the commission business may see fit to bestow upon them. What reason can we give for this—I ought to say, criminal—neglect of our interests? Is it indifference to the value of money? Is it laziness? or, is it because we are laboring under the impression that what is *must* be? These are questions that must needs be answered, and we are the ones to whom they are put.

Of course, we all know that there are extenuating circumstances which somewhat relieve the commission men of the burden that we sometimes feel justified in placing upon them. They certainly have difficulties to overcome, and without doubt it is sometimes almost impossible for them to live up to their promises. But they can be, and ought to be, honest men.

It has been said that a man could not be honest in the commission business. Well, if he cannot, then the sooner he changes his business, the better it will be for him, because it is only a question of time with him when exposure will come. This fact is evidenced already, with one commission firm in Chicago. The case of C. R. Horrie & Co. is familiar to the readers of the American Bee Journal. This case is simply the shadow of coming events, and now, right here, I wish to say, (and I believe that I voice the sentiments of honey-producers generally), that we are heartily sick and tired of being gulled and robbed by sharpers, three-card monte men, and all other men, who, under the guise of a respectable business concern, are permitted to use the results of our labor as a means of enriching themselves. And the time has come to order a halt.

We demand a square deal. It is our due, and they will have to give what is right.

I know that some of you will smile, and slyly remark that "the fools are not all dead." And you may be right, too, but there are some few who may be able to teach the fools. And, when we have done that, somebody, and somebody's business, will be "in the soup." See?

I presume that some of you will think that I am bearing a little too hard on this subject, but when a man has been enchured out of some 30 hard-earned and much-needed dollars, and at the same time lost about 50 per cent. of his faith in human nature, he *will* say a few things that do not tend to the credit of the one who caused his loss. This is not a new thing, although it is my first experience. I hope, however, that it will be the last.

And now, I want to say just a few words to those who are fortunate enough to have honey to sell in the future. We want honest treatment—let us, then, be honest ourselves, and thereby be entitled to it. Let us put our goods up in the very best manner possible. Don't put the best sections in the front of the shipping-case—that is not honest. Send strictly pure goods to market. If you can't do this, don't ship any. Let the best rule that ever was made, be your guide—"As ye would that others should do to you, do ye even so to them."

In closing, I want to say, that in view of the interest that the editor of the American Bee Journal has taken in the cases brought to notice regarding the losses of bee-keepers through one of his advertisers, he deserves our heartiest support. It is impossible to always detect the black sheep, especially if they wear a white fleece, but we can discountenance them when found out, and help to expose them. And this, George W. York has done to the best of his ability, spending his time without compensation. I am sure that the bee-keepers of this country fully appreciate this action on his part, which, as Dr. C. C. Miller on page 3, truthfully says, is a breaking away from the established usage of hushing up such affairs. Editor York has given us a good example. Let us be fearless and honest, and stand firmly for our rights. Loyal, Wis.

[An essay was also read at the Wisconsin convention (from one of the largest honey commission firms in Chicago) from which we take the following suggestions:—Ed.]

The most important points for bee-keepers, from our experience and study of markets, are:

- 1st—Market your honey early.
 - 2nd—Put your honey in as neat a package as possible. The 24-section cases our trade prefers.
 - 3rd—Grade your honey very carefully, and mark the grade on the end of the case. Always bear in mind that white honey will sell, while dark honey takes its chances for a customer.
 - 4th—Place the gross, tare and net on every package.
- These remarks refer to extracted as well, whether it is placed in cans or barrels. We have no preference as to package for the extracted.



Sweet Clover—Swarming vs. Non-Swarming.

BY E. S. LOVESY.

Dr. Miller asks if I can give any reason why that great honey-plant—sweet clover—gave out in some parts of Utah last year. I have investigated somewhat, and I note that we had a very heavy rain the forepart of July, soon after the sweet clover came into bloom, and the nectar, or saccharine matter, was thus washed out. This is my view of it. But our lucern was grand last year, and when it is all right, I prefer it to the sweet clover, because the honey is better. While there may be more honey on a given amount of ground, or plants, in the sweet clover (whether this is so or not), while we have considerable sweet clover we have 30 acres of lucern to one of clover in most places, so that when our lucern is all right our bees will fill up their hives.

On page 45, Paul Whitebread says that the swarming bees are ahead. He says that he bought two colonies of bees, and in the spring he prevented one from swarming by putting on 48 sections; the other he sold to a neighbor who let them do as they pleased, and he got two swarms and 80 pounds of honey, while he himself got no swarms and only 74 pounds of section honey. But what possible figure can this cut on the question? Mr. Whitebread simply sold the wroog colony.

We all have one or more colonies every season that do wonders, and it often happens that one or more will do nothing. The past season, on June 29, I made the sixth new

swarm from one colony, and on the same day another colony that I had helped with bees and brood twice, but they would do nothing, so I caught and cut the head of the queen and introduced a cell ready to hatch, from the other prolific queen, and in from five to six weeks the hive was full of bees and honey.

While there are exceptions to all rules, as a general thing, with proper management, any bee-keeper can do much better than with a haphazard, go-as-you-please plan, whether it be the swarming or non-swarming method. I have tried both methods for eleven years, and the non-swarming system has always paid me the best.

Much has been written about a non-swarming strain of bees. While I do not believe there is such a thing, I do believe that we can have our bees swarm or not swarm, as we please, simply by the method of management. Under certain conditions they will swarm, but under other conditions they will not. We might run forever for extracted honey without swarming, but we cannot always succeed in running for section honey exclusively. Salt Lake City, Utah.

CONVENTION PROCEEDINGS

The Colorado State Bee-Keepers' Convention.

REPORTED BY F. L. THOMPSON.

(Continued from page 214.)

Pres. Aikin then read an essay on

REARING QUEENS,

of which the most essential parts follow:

Since practicing the unqueening system I frequently use cells started under the swarming impulse. Such cells are much the safest, especially for the inexperienced. Two classes of cells are almost invariably good—those built for swarming, and those for superseding. In either case they are started from the egg, and if for swarming are well cared for, and from vigorous colonies, when feed is plenty. Supersedure cells are counted by Doolittle to be the very best. I think that such are as good as any in most cases. The swarming cells are always built under favorable circumstances, while there are times that a very weak colony may be compelled to supersede when no nectar is coming in, and so may not properly feed the larva. But if superseding is done during the flow, and when the colony is not weak, such cells ought to be good. When superseding there are usually only two to four cells built, hence better cared for. When swarming, they may have 20 to 30, though usually about 10 to 15 cells.

If you wish to get cells aside from the above, you can do so by making a colony queenless; but this method requires much more care to get good queens. They will force cells by using larvæ as much as six and sometimes seven days from the laying of the egg, which cannot give so well-fed and vigorous queens. While the swarming colony usually has but 10 or 15 cells, the forced colony will have often 15 to 30, and if this be at a time when no nectar is coming in, there will be a lot of starved queens. If we rear from forced cells, the colony should be fed until they are in much the same condition as during a honey-flow; and unless you have a great lot of bees it will be all right to give them no brood at all except some fresh-laid eggs, and then you know there will be no building from old or advanced larvæ, and all will be well fed the whole time of their growth. After the cells are sealed, they can be put in any nucleus that has sufficient bees to keep them properly warm. If the weather is warm, less bees will do, but if cold, give more bees. A queen may be injured by being too cold while developing.

In transferring cells they should be handled very carefully, not shaken or turned over and about, or exposed to extremes of temperature. Just after the larva has spun its cocoon and passed to the form of a bee, a very little shaking will often destroy the embryo wings, and while you will most likely have a perfect queen in other respects, her deformed wings will prevent her mating. This I learned from experience.

The use of cell-cups and transferring eggs or larvæ I have

never tried; but I have no doubt they will be all right in the hands of experts. The average apiarist will seldom find any use for these new methods. R. C. AIKIN.

N. C. Alford—I think that when queens are reared by forcing, the bees will eventually run out. Last year I lost one-third of my colonies in unqueening, even after putting an extra cell in each hive. One apiary lost one-half. The loss was greater than ever before. Some years the loss is not over 15 or 20 per cent. So much queenlessness causes trouble from laying workers. I have found that combs which have been used by laying workers are injured. The cells are swelled, and the queen will not lay in them.

H. Rauchfuss—The loss is light when virgin queens are reared and introduced. We reared our virgin queens in upper stories, by the Doolittle method. The cells were put in nursery cages.

Mr. Alford—That is a good deal of work.

Pres. Aikin—Loss of queens depends largely upon the way an apiary is marked by trees, etc. In one apiary, which was well marked, I lost only 4 out of 50 or 60. In another, which was not well marked, I lost one-third. But there is a considerable per cent. of loss from chilling, or knocking about too much. I found lots of queens with deformed wings.

W. L. Porter—Isn't there danger in leaving queen-cells on the bottoms of combs from drafts of air from the entrance?

Pres. Aikin—In warm weather, and with strong colonies, cells at the bottom are all right; otherwise not.

H. Rauchfuss—Cells should not be cut out until they are ripe. They are ripe when the bees begin to gnaw off the end. Or, in using the Doolittle plan, we can distinguish the color of the queen through the cell, by holding it up to the light. The darker the queen, the closer the maturity of the cell. Sometimes the motions of the queen can be thus seen.

R. Patterson—Are queens reared artificially as good as those reared naturally?

S. M. Carlzen—I got some queen-cells from Rauchfuss Bros. The queens were good, and their progeny developed into strong colonies.

Pres. Aikin—If bees commence with the egg, or with the just-hatched larvæ, and they are fed well, the queens are just as good.

Mr. Alford—In forcing, how can you tell between good and poor cells?

Pres. Aikin—You can't tell except by results.

H. Rauchfuss—Forcing ought not to be practiced. Even swarming-cells are sometimes inferior. Even if the bees only have eggs to start with, some of the queens will be poor, because some cells are started six days after the egg, and they cannot be distinguished, because they hatch at the same time. Our bought queens never lived more than two years; most of them only through one summer. It was not from mailing, because the queens we reared from them were not good, either. But our imported queens, from Italy or Carniola, were always good.

Mr. Alford, who had been put down for the subject,

FALL, WINTER AND SPRING MANAGEMENT,

had not prepared an essay, but gave a short talk on the subject. The following were his chief points:

I have gone to a good deal of trouble to pack my bees well in straw, with plenty of chaff above, but my neighbors' bees in single-walled hives, without special care, always wintered as well as mine, and were as strong in bees on the 1st of April. Colorado wintering does not require packing. But after the 1st of April, the case is different. Spring management is everything in this climate, on account of the sudden changes of weather. From the 1st of April to the 15th of June is the whole secret. The bees should be stimulated and kept warm.

N. C. ALFORD.

E. Milleson—Look out for mice in packing. This climate is hard on lumber. The hives should be thoroughly seasoned, with no cracks. The first thing to remember is to keep the bees dry. Don't let the quilt stick out from under the cover. The moisture from rain and snow will soak in.

D. L. Tracy—Is it altogether the moisture from outside which is seen in hives?

Mr. Milleson—In extremely cold weather, there is internal moisture under an oilcloth or a propolized and water-tight quilt.

W. L. Porter—That kind of moisture is also caused by the kind of hive. That is why I do not like the flat cover of the dovetailed hive. In cold weather it is moist every time. I prefer to make a little ventilation by putting strips under, above the quilt, rather than have them too tight.

Rev. F. O. Blair, of Trinidad, and Mrs. Shute, Secretary

of the Horticultural Association, were elected honorary life-members. Mrs. Shute invited all bee-keepers to meet with the Horticultural Society at its next session.

The following resolution by V. Deviny was adopted:

Resolved, That the Executive Committee of the State Bee-Keepers' Association be authorized to confer with the State Board of Horticulture to secure if possible a more intimate co-operation in carrying out the purposes and interests of the society, and if possible to change the dates of the meetings so that the members of each society may attend the meetings of the other, and if possible secure a publication of the bee-keepers' association's transactions with the Horticultural Report.

The Secretary reported that the yield of three precincts in Delta county was 14, 10 and 13 tons of honey, respectively.

Mr. W. L. Porter, President of the Denver Bee-Keepers' Association, called attention to their next meeting in the Horticultural Rooms of the State Capitol on the second Wednesday in February. (It has been the custom of this local association to meet on the second Wednesday of every month, in winter and spring.)

A Committee on Resolutions was appointed, consisting of L. Booth, D. L. Tracy and R. H. Rhodes.

Officers for the ensuing year were elected as follows:

President, R. C. Aikin, Loveland; Vice-President, W. L. Porter, Denver; Secretary, Frank Rauchfuss, Duff; Treasurer, Mrs. R. H. Rhodes, Arvada. Member of Executive Committee, R. H. Rhodes, Arvada.

Vice-Presidents from some of the 22 bee-keeping counties were appointed as follows:

C. W. Cain, Fruita, Mesa Co.; J. E. Reynolds, Husted, El Paso Co.; Oliver Foster, Las Animas, Bent Co.; W. S. Simpson, Fort Morgan, Morgan Co.; J. B. Adams, Longmont, Weld Co.; Levi Booth, Denver, Arapahoe Co.; D. L. Tracy, Denver (appointed for Jefferson Co.); F. L. Thompson, Arvada, Jefferson Co.; S. M. Carlzen, Montclair, Arapahoe Co.; Rev. F. O. Blair, Trinidad, Las Animas Co. More are to be appointed by the Secretary.

During the session the convention adjourned to the reception room, where Gov. McIntire was introduced to them, and made a short address.

THIRD DAY.

The Committee on Resolutions made their report. The resolution on marketing will no doubt be more fully developed at the spring meeting. It was adopted as follows, after considerable discussion:

MARKETING THE HONEY CROP.

Resolved, That our Executive Committee be instructed to correspond with different responsible dealers in honey in various parts of the country, and to obtain prices from them, together with the quantity they will purchase, and in case that they shall obtain fair prices in sufficient quantity to justify, they shall immediately notify all members of this Association of the price offered and the amount of honey required, and of the place of shipment, whereupon all members of this society having honey to dispose of, at the figures offered, shall immediately inform said committee of the amount which he can furnish, and if a sufficient quantity of the required quality be shipped, then said Executive Committee shall direct the members to deliver the same on board the cars at a point designated by the committee, and at least one of said committee shall be present to see to the shipment, and to see that the honey is properly packed and of the required quality, or appoint some suitable person for such work.

Before it was adopted, the following were the chief points of the discussion:

H. Rauchfuss—What is to be done if the honey brought is not of the proper quality? Prices should be adjusted to the quality.

L. Booth—There is only one grade to ship. This does not provide for the home market. Outsiders want the first quality.

R. Patterson—The large producers will have the advantage in this way.

J. B. Adams—There is plenty of market. The small producers won't be crowded.

Pres. Aikin—The scheme is in its infancy. We may not be able to dispense justice at first as we would like to.

Mr. Patterson—Is there any commission in this arrangement?

Mr. Booth—No.

The following discussion took place at another part of the day, but comes in most appropriately here:

USE OF SEPARATORS AND HONEY-BOARDS.

Mr. Carlzen—The Association should recommend the use of separators.

Mr. Adams—There will be a heavy loss by not using separators. They pay much more than their cost.

H. Rauchfuss—Separators and honey-boards are very necessary. The latter we might get along without; but separators are indispensable. Their use has spread greatly during the last few years, as the result of experience. We must have them to produce honey fit for shipping.

Pres. Aikin—I formerly recommended separators only between the alternate rows. But now I think they are necessary between every row.

Mr. Porter—All supers have room enough to get separators in.

A. W. Croff—Bee-literature shows that separators are becoming out-of-date in the East. I have never used them.

Mrs. Booth—I have produced good honey without separators.

Pres. Aikin—A Chicago commission firm wrote me that they wanted honey that was produced with separators, between every row.

Mr. Patterson—I have had separators stuck to the combs. Mr. Croff—Bees can be bred to build straight combs without separators.

Mrs. Hartman—I want separators, and I want honey-boards even more. They keep the sections much cleaner.

Mr. Porter—I had not used separators until last year, and then produced better honey than I ever did before. I think we should use them.

By a nearly unanimous vote the Association recommended the use of separators.

STATISTICS OF BEE-KEEPING.

A resolution on statistics was adopted as follows:

Resolved, That every member of this Association be required to report to the Secretary on April 1, Aug. 1, and Sept. 1, of each and every year, the following facts, to-wit:

1st. The condition and the number of colonies in his apiary.

2nd. The amount of first-class comb and extracted honey which he has for sale, and such other information as may be considered of benefit for the Executive Committee to know.

Mr. Porter made the following remarks on this subject:

Statistics are necessary if we want to get down to business. I think the Secretary should print appropriate circulars, and make every member a committee to gather statistics of bee-culture in his neighborhood, the names and addresses of bee-keepers, the number of their colonies, the number of pounds of comb and extracted honey, the presence or absence of foul brood, etc. The county vice-presidents and the foul brood inspectors especially could furnish information. These reports could be sent in and tabulated.

The Association voted also to adopt Mr. Porter's plan.

PURCHASING BEE-SUPPLIES.

The following resolution on buying supplies was adopted after much discussion:

Resolved, That our Executive Committee be instructed and empowered to contract with one of the different bee-supplyhouses to furnish the members of this Association with all of their supplies at the least possible cash rates, and that each and every member of this Association shall furnish, as soon as possible, to said committee, the kind and amount of supplies which they require, and that each and every member of this Association hereby agrees to stand by the contract so made as aforesaid by our Executive Committee, if not against his personal interest, and said contract shall be kept secret among its members; and that said committee shall, as soon as the aforesaid contract shall have been made, furnish every member of this Association, in a circular letter, a list of the prices agreed upon by them, and the name of the house, or houses, with whom the contract shall have been made.

The following were the main points of the discussion:

Pres. Aikin—This resolution is not so important as that on marketing. There is not so much to be saved after all in buying supplies. I object to the clause which requires secrecy. Plain, straightforward, open business doesn't hurt anybody.

H. Rauchfuss—We should not publish figures. There should be an advantage in being a member.

Mrs. Booth—We are helping outsiders by publishing our figures. Those outside who would be so helped are the same ones that undersell us.

Mr. Porter—A local association of this State, in this way

succeeded in buying their sections at a reduced figure of a certain house. Injudicious members let it out, whereupon a rival house lowered the price of their sections 20 cents per thousand below those reduced rates. The result was that outsiders got their sections cheaper than did the members of the Association, who were in honor bound to stand by the house they had chosen.

R. H. Rhodes—Secrecy is a benefit to those who make our low prices.

Mr. Booth—A neighbor of mine refuses to join the Association just on that account. He says, "You will go down there and pay your fee, and I will pay nothing, and get my supplies cheaper than you, after all."

Mr. Porter—This is a matter of business. Honey-producers, as a rule, are not business men. They must be educated.

Pres. Aikin—I think I am misunderstood. I don't advocate telling our business. But the idea of secrecy is the beginning of organizing for selfishness. Then, irresponsible members may leave goods on the hands of the committee, who may have to pay for them. Let us have no credit business.

Mr. Adams—The Northern Colorado Association took orders in this way. The members were to pay cash when they got the goods. Some of the goods were left on the hands of the committee. Some members wanted to pay for them in honey and wax, making us work for them in both ways, buying and selling. There is quite a little left on our hands now.

Mr. Booth—The Executive Committee does not contract for the exact amount, but somewhere near it. If some do not pay, that is between the house and them. Members are not responsible for orders sent in. None are sent in. They become orders only when the certificates of membership are presented.

Mr. Croff—If supplies are shipped to Denver and reshipped, local freights may be greater than the rebate.

Mr. Porter—I have been in the supply business. Often the only profit to supply dealers is the difference between car lots and local freight. Even when car lots are brought here first and then distributed, I think there would be a gain.

The clause "if not against his personal interest," was inserted to meet Mr. Croff's objection.

The Association adopted the following resolution by Mr. Aikin:

Resolved, That the chair appoint a Legislative Committee of three to revise our foul brood law, or to draft a new law to be placed before the next General Assembly for passage; that the report of this committee shall be submitted to the Executive Committee for their concurrence before going before the assembly; and after being concurred in by the Executive Committee, said Legislative Committee shall, when the Assembly convenes, place the bill before them and use all proper means to secure its passage; further, that said committee may work in the same manner to recommend such legislation as may be thought advisable.

J. B. Adams, H. Rauffuss, and F. L. Thompson were appointed as the legislative committee.

A letter from E. S. Jenkins, of Las Animas, was read, in which he said that apiculture has had its day in this part of the Arkansas valley. The sheep craze has struck the people, and alfalfa seed is low.

The request of the Committee on Resolutions, to be permitted to furnish the Secretary with a copy of the memoir of the Rev. L. L. Langstroth for publication, was granted.

R. Patterson asked whether the self-hiver was a success. J. B. Adams replied that it had been tried in the northern counties, and was not.

The convention adjourned to meet at the call of the Executive Committee, which will be some time in the spring months.

F. L. THOMPSON,

Arvada, Colo.

Assistant Secretary.

A New Binder for holding a year's numbers of the American Bee Journal, we propose to mail, postpaid, to every subscriber who sends us 15 cents. It is called "The Wood Binder," is patented, and is an entirely new and very simple arrangement. Full printed directions accompany each Binder. Every reader should get it, and preserve the copies of the Bee Journal as fast as they are received. They are invaluable for reference, and at the low price of the Binder you can afford to get it yearly.

If any one desires two of the Binders—one for 1895 and one for 1896—send 25 cents, and they will be mailed to you.



Age of Brood-Combs.

I have combs in my hives which have been in constant use in the brood-chamber for 20 years; and, while the cells do appear small in looking at them, yet, so far as I can see, it makes no difference in the size of the bees hatching from these cells. A neighbor tells of combs being in use for 40 years and yet no perceptible difference in the looks of the bees coming from these combs.

All bees, when first emerged from the cells, look small; but wait till they are 36 to 48 hours old, and it will be seen that they look altogether different, especially during a honey-flow. Some seem to think that bees do not grow any after they cut out of the cells, but I think a little observation will satisfy any one that the young bee "plumps out" considerably after it emerges from the cell. Several times during past years I have compelled the bees to rear workers in drone-cells, and, so far as I could discover, using the closest scrutiny, said bees were not a whit larger three days after hatching than were those of the same age hatched from combs from 10 to 20 years old. It is true, that each emerging bee leaves a slight cocoon or lining in the cell; but as this cocoon is much thicker at the base of the cell than at the sides, and so thin at any spot that it is hardly perceptible, no bad results seem to arise therefrom. It is always safe to use combs as long as they are in good condition, and old combs have the advantage of being better for the bees during winter than new; consequently I have no thoughts of throwing away these 20-year-old combs at present.—G. M. DOOLITTLE, in *Gleanings*.

Bleaching Beeswax.

While beeswax may be bleached by means of chemicals, the results are inferior to sun bleaching, and the latter process is, I believe, the only commercially successful one. To bleach wax by this method, it is first cleaned by the sulphuric acid process which, if properly done, will restore the blackest and dirtiest wax to its original color. To cleanse wax by this method, take a whiskey or alcohol barrel and put about 6 inches of water in it, adding to the water a small quantity of sulphuric acid, the quantity varying with the amount of dirt in the wax. Two pounds of acid to one hundred of wax would generally be sufficient. Then fill the barrel about two-thirds full of wax. Next turn a jet of steam into the bottom of the barrel, slowly at first, until the wax is all melted. Do not be afraid of getting the wax too hot, but keep the steam on until a froth rises to the top of the melted wax. Now watch the froth carefully, for this is the critical point of the operation. If you stop the steam too soon, you will not have cleaned the wax. If the steam is on too long, you will make a soapy mess of the whole thing. The time to shut off the steam is when the bubbles in the froth begin to grow large—say about one-fourth of an inch in diameter. Having shut off the steam, wrap a carpet, or anything else that will keep the heat in around the barrel, and let the wax settle until it is nearly cold, when it may be dipped out and all the dirt will be at bottom.

To prepare the wax for running, a little machinery is required. This consists of a tank to hold beeswax, having near the bottom a row of holes about two inches apart. This tank stands over a trough of cold water, some 10 or 15 feet long. Revolving in one end of the trough, and about two-thirds submerged, is a roller covered with felt, the tank of wax being directly over it. The melted wax flows from the holes in the tank upon the wet felt and is instantly chilled into the shape of ribbons about one-eighth of an inch thick, the revolution of the roller at the same time moving the wax forward into the tank of water, thus making as many continuous strips of wax as there are holes in the bottom of the tank. From the tank the wax is taken to the bleaching-ground and spread upon frames covered with white cloth. Here it is exposed to the action of the sun and air until the outside of the strips are bleached, when it is re-melted and again run into strips and sunned, the operation being repeated until satisfactory results are reached.

It should be said that not all wax is suitable for bleaching, wax from Southern countries, with a reddish tinge, generally proving very difficult to whiten.—E. B. WEED, in *Canadian Bee Journal*.

OLDEST BEE PAPER IN AMERICA ESTABLISHED IN 1861

THE AMERICAN BEE JOURNAL

PUBLISHED WEEKLY BY

GEORGE W. YORK & COMPANY,

118 Michigan St., CHICAGO, ILL.

REGULAR CONTRIBUTORS:

G. M. Doolittle, of New York. Prof. A. J. Cook, of California.
 Dr. C. C. Miller, of Illinois. Dr. J. P. H. Brown, of Georgia.
 J. H. Martin, of California. Rev. E. T. Abbott, of Missouri.
 Chas. Dadant & Son, of Illinois.
 B. Taylor, of Minnesota.

\$1.00 a Year—Sample Copy Sent Free.

[Entered at the Post-Office at Chicago as Second-Class Mail-Matter.]

Vol. XXXVI. CHICAGO, ILL., APR. 9, 1896. No. 15.



Early Bee-Supply Orders are the ones that are apt to receive the most prompt attention on the part of dealers. Better make out your order and get them to your supply dealer before the busy time comes on. It will be very annoying to be compelled to wait for goods when you need them at once. Consult our advertising columns for prompt and reliable dealers. Get one of their catalogues, and then mail your order in time to get the goods you want before you will actually need to use them.

The Next North American Meeting.—Just as we were mailing the last number of the Bee Journal, we received this letter from Mr. E. Whitcomb, of Friend, Nebr., dated March 30:

DEAR MR. YORK:—I am not a little surprised that you are advocating the removal of the North American Bee-Keepers' Convention to Minneapolis, Minn. Do you not think that this would be a serious mistake? The convention at St. Joseph practically promised to come to Lincoln, and at this time it occurs to me that they should not think of anything else. It occurs to me that as cheap railroad rates can be secured to Lincoln as to any other point, and a marked advantage in entertainment. The fact that the American Bee Journal is advocating the removal to another point, must in all events tend to keep a great many away from Lincoln who otherwise would be in attendance.

We had been in hopes to be able to treat our visitors, next fall, to a real specimen of true Nebraska hospitality, to have a good meeting, and that all would return home feeling that all Nebraska, and especially Lincoln, had for a time, at least, been theirs.

I sincerely hope that you will not farther advocate this move, but that you will, as much as is possible, endeavor to undo what injustice has already been done.

Your friend, E. WHITCOMB.

As we are not running the North American, a very short reply from us, to Mr. Whitcomb's letter, will suffice.

If Mr. W. will *guarantee* a 1½ railroad rate to Lincoln for those attending the bee-keepers' convention, we will pitch right in and "whoop her up" for the Nebraska city. But we cannot, as in former years, urge bee-keepers to attend, expecting to get the lower rate on the return trip, and then be disappointed. Some \$300 was lost to bee-keepers at Toronto

last September, where we fully expected there would be over the necessary number to secure the reduced rate.

If the Executive Committee (who were given the deciding power at Toronto) say that the convention shall be held in Lincoln, all well and good. The Bee Journal will help to have a good meeting, no matter where it will be. But it does seem to us that our Nebraska friends should be willing to sacrifice a little in order that the rest of the country may be enabled to take advantage of the *assured* low rate of *one cent a mile* (which the G. A. R. has already been granted for their meeting the first week in September, at St. Paul, Minn.), unless they can guarantee at least the 1½ rate.

The "Nehoiden House-Apiary" is shown by two pictures on our first page this week. It seems quite a number of bee-keepers use this means of caring for their bees. It certainly has its advantages, and we shouldn't be surprised if more apiarists would use house-apiaries in the future. The one illustrated in this issue of the Bee Journal, belongs to Mr. E. Goulding, of Wellesley, Mass., and he tells us about it in the following communication:

As I have been very much interested, the past year, in the house-apiaries that have been shown in the American Bee Journal, I will send pictures of mine—"The Nehoiden Apiary."

No. 2 is the house open for summer. Around the house the loam was taken out 8 feet wide and 6 inches deep, and filled in with sawdust, which keeps the weeds down and makes a clean place for the bees, if they happen to alight on the ground. The sides are all made in doors, and hung with steel hinges. By filing off the head on one side, I can pull the rivet out with my fingers, and take them off very easily. By being buttoned on to the bottom I can swing them up, as the north end ones are.

The inside of the house has a floor made in three parts, so I can walk in and not jar the bees at all. The bees are set up 5 inches from the floor.

The house is 8 feet wide and 16 feet long, and holds 28 colonies, with the 2 in the gable end. The side shelves are 2½ feet wide on each side, and a 3-foot walk in the center. Each side of the walk there are sliding screens that will slide all to either end. I can open the hives just as I can out-of-doors.

No. 1 is the house closed for winter. The "little houses" seen on the outside are covered in front, and the entrance is on the south side. In the spring and fall the front comes off. There is an entrance to the little house from the hive 6 inches long and ¾ wide, and from the little house out 3 inches long by 5 wide. The hives are all packed with leaves or fine hay, 6 inches on all sides.

E. GOULDING.

California Bee-Notes.—Prof. Cook, of Claremont, kindly sends the following:

BEE-KEEPERS' EXCHANGE.—The California Bee-Keepers' Exchange is moving on in a manner very satisfactory to its friends. There is a hearty co-operation, just as was expected, and it looks now as though almost every bee-keeper of Southern California would give hearty co-operation. It is fully believed that with all our bee-keepers as members of this organization we shall have made a stride in apicultural advancement which has seldom been equalled in this or any other industry.

SCANT RAINFALL.—The bee-keepers of Southern California are somewhat anxious regarding the scant rainfall of the present winter. Of course there is time for heavy rains even yet; but some of our friends feel that with heavy rains during the last of this month (March) and next month, we cannot expect a first-class season. They say that observation in the past has shown, that, in order to secure a heavy honey-flow, there must be early rains as well as a heavy rainfall. The needed rainfall is usually put at 15 inches. As yet we only have about half that amount.

PURE-MATING OF QUEENS.—It will be remembered that Mr. D. A. Jones, some years since, established breeding apiaries on the islands in Georgian Bay, in the hope of securing pure mating. Because of the heavy winds and severe cold

Mr. Jones was unable to succeed as he wished, and after one or two seasons gave up the project.

California is likely to follow in the wake of Mr. Jones with more hope of success. Mr. A. D. D. Wood, so long and favorably known as a bee-keeper, dealer in bee-keeping supplies, and queen-breeder, in Michigan, has come to California and proposes to engage solely in the breeding of queens. Mr. Wood is negotiating for the privilege of locating two apiaries on Catalina Island, one in which he will breed only Italian and the other where he will rear only Carniolan queens. It is hoped that the flora of this island will be such as to warrant the success of this effort. There is little doubt but that the mountains will so break the sea-breezes that there will be no hindrance from winds. Any one who has enjoyed the delightful summer weather of Catalina will know that there will be no objection because of too great cold.

It is to be hoped that the island is large enough so that two apiaries—one at each end—can be conducted, and yet there be no intermixture of blood. This is certainly a matter of general interest to bee-keepers, not only in California, but throughout our whole country.

We are sure that Mr. Wood's undertaking will be watched with interest by bee-keepers all over the country. The bee-keepers, especially of California, are to be congratulated that so able and straightforward a man as Mr. Wood has interested himself in this project. A. J. Cook.

Grading Honey.—In the last Review, Editor Hutchinson wrote thus in referring to this subject and to the "Miller grading":

Grading honey is spoken of in Gleanings for March 15. Mr. Thos. Elliott, of Harvard, Ill., uses a grading suggested by Dr. Miller. This was a compromise between the Chicago grading and that proposed at Albany in 1891. In 1892 the North American, in its meeting at Washington, still further "revised" this grading and adopted it. Since then the Review has kept this grading at the head of its market column, and it is printed on the blanks sent out to dealers for their use in giving quotations, and quotations are given in conformity with that grading. The editor of Gleanings suggests that we take up the Miller grading and use it, and says that Gleanings stands ready to co-operate with any of its cotemporaries. Good! But why adopt the grading of a private individual (unless it is better) when that adopted by the leading bee-keepers' society of this country has been in use three years by one journal, and during that time not one criticism has been made by dealers or shippers? If that adopted by the North American has any faults, let them be pointed out and have them corrected at its next meeting; but don't encourage the use of different sets of rules for grading, and thereby bring in "confusion worse confounded."

Editor Root, in Gleanings for April 1, copies the above, and comments thus upon it:

Since Mr. Hutchinson has called my attention to it, I have carefully compared the two gradings side by side; and I must confess that the one he uses, adopted by the Washington North American, has the advantage in point of brevity. It also has another important advantage—that it has been tried, as Mr. Hutchinson says, three years, and "during that time, not one criticism has been made by dealers or shippers." This is a big point in its favor. In order that our readers may more easily compare the two, I reproduce both the Miller grading and the Washington North American:

MILLER.

FANCY.—Combs straight, white, well filled, firmly fastened to wood on all four sides; all cells sealed; no pollen, propolis, nor travel-stain.

No. 1.—Wood well scraped, or entirely free from propolis; one side of the section sealed with white cappings, free from pollen, and having all cells sealed except the line of cells next the wood; the other side white, or but slightly discolored, with not more than two cells of pollen, and not more than ten cells unsealed beside the line of cells touching the wood; comb fastened to the wood on four sides.

No. 2.—Three-fourths of the total surface must be filled and sealed; wood well scraped of propolis.

No. 3.—Must weigh at least half as much as a full-weight section. For the Classes of honey I would suggest the four already in use, sufficiently understood from the names alone; namely, LIGHT, AMBER, DARK, MIXED.

WASHINGTON.

FANCY.—All sections to be well filled; combs straight, of even thickness, and firmly attached to all four sides; both wood and comb unsoiled by travel-stain, or otherwise; all the cells sealed except the row of cells next the wood.

No. 1.—All sections well filled, but combs uneven or crooked, detached at the bottom, or with but few cells unsealed; both wood and comb unsoiled by travel-stain or otherwise.

In addition to this the honey is to be classified according to color, using the terms white, amber, and dark. That is, there will be "fancy white," "No. 1 dark," etc.

The reader will readily see that the Washington is briefer, and really covers all the Miller grading does, with the exception that it allows for no No. 2. The editors of the bee-journals could easily hitch on such a number if such should be necessary.

Now, then, it does not seem to me that we need very much discussion. What we need now is *action* on the part of bee-journals. If a majority of the others agree, I am willing to commence with the Washington North American grading, and put it at the head of our Honey Column, the same as Mr. Hutchinson has been doing. Why do I select the Washington? Because it has been tested three years, and the other has not been tested at all; and because it really covers all that is set forth in the Miller grading. I believe that most of the commission men who have furnished us quotations, have also furnished them for the Review. That being the case, they could easily adapt themselves to the grading used in the Review, in Gleanings.

If all the editors fall into line, the system will be practically universal; and thereafter shipper and buyer can designate their honey by this grading. No doubt it will save a good many jangles, and a good deal of descriptive matter regarding honey that now is necessary. What say you, brother editors?

The American Bee Journal will gladly co-operate with Gleanings and the Review in this matter. If begun at once, it will be helpful during the approaching season.

Questions AND Answers

CONDUCTED BY

DR. C. C. MILLER, MARENGO, ILL.

[Questions may be mailed to the Bee Journal, or to Dr. Miller direct.]

A Colony that Starved.

Last spring we started with one colony of bees which swarmed three times. The first swarm got away after being hived twice, and the remaining two we saved. Not wishing for honey, but increase, this spring found the last swarm dead from starvation. On examining the hive there was no brood or queen to be found; there was about one quart of bees. I looked very carefully over them, but found no trace of the queen or a queen-cell. It seems they neither gathered honey nor reared brood. What was the matter that they had no queen or queen-cell? It seems that they did nothing but build comb, of which there was plenty. There were small clusters of bees woven together with a kind of web, and in this web there were some small red eggs. Do you think there was some insect that fastened the bees together, preventing them from working? NOVICE.

Portland, Oreg.

ANSWER.—When bees starve to death the queen is very small, and you might easily miss her. If the bees built worker-comb, there was pretty certainly a queen present. The web that you found present, was the work of the wax-worm probably, and the small red eggs were those of some insect that happened to be present, but probably had nothing to do with the destruction of the colony.

Robbing Among Bees—Robber-Traps.

Some one wrote me lately that he finds he can't get much surplus if his hives are all together, *i. e.*, in one yard—"the bees rob from each other so." I had never noticed this among my own bees; but since the idea has been put into my head, I have been carefully watching, and find now, with a flow just ceasing, that a good deal of what appears to be quiet, sneaking robbing seems to be going on—not much fighting with it, either, hardly any—still one-half seems to be quickly robbing from the other half. Is this usual, in your apiaries? It is not the result of carelessness, as many of the hives which appear to be visited by robbers have not been opened for some time.

My informant also happened to mention that if you find

three or four colonies of wild bees close to each other in the woods, the chances are that only one nest is full of honey, and the others almost storeless. Now is it in the nature of bees for stronger colonies thus—unmolested by man—to deliberately rob out weaker ones? How often it happens that in one yard there may be found one or two colonies which have secured an enormous surplus, while the majority of the others have produced very little. This is explained on the ground of superior working-qualities of the former, and queens are consequently bred from them. May it not often be that they are not superior field-workers, but superior robbers, accumulating an immense surplus at the expense of their neighbors? Of course, this is not always the explanation, but may not such great difference in amount of stores accumulated be sometimes, and more often than we imagine, accounted for thus?

What are "robber-traps," of which I recently saw mention? How are they constructed? AFRICA.

ANSWER.—I don't believe bees are much more likely to rob from each other in the same apiary than when scattered a good many rods apart. I don't believe there's any quiet robbing going on among my bees—that is, a strong colony taking away honey from a weaker, with a good queen. When a case of robbing occurs, and is allowed its own course, the rule is that the robbed colony gives up the ghost. And if you'll pardon me for saying so, I don't believe that sort of robbing that leaves the robbed colony still in existence is a common thing in Africa.

I don't know what robber-traps are referred to, but it may be some kind of cone escape that allows entrance but not exit.

Paper Separators—Shallow Extracting-Frames—Double Hives, Etc.

1. What do you think of the brown building-paper for separators?

2. What do you think of shallow frames for extracting? Are they better than the Langstroth?

3. What do you think of Editor E. R. Root's plan of putting two S-frame hives on top of each other for comb honey? I think it all right for extracted honey, but not for comb.

4. What do you think of the wood-base foundation for brood-frames?

5. Why is it that some foundation when melted over in the solar wax-extractor, turns a dark color? I had some last summer which did that very thing. F. C. C.

ANSWERS.—1. Bees would be likely to tear it, but if properly prepared by means of varnish or something of the kind it may make good separators. I think it has been so used, but I cannot now say by whom.

2. Taken all in all, I suppose they are better. The Dandant's prefer them after long years of trial.

3. I don't know whether any one has tried it thoroughly enough to speak with authority on the matter. But I hardly see why bees might not store honey in sections over 16 frames in two stories about as well as they would over the same number of frames in one story.

4. Very few have reported as to this, and I've had no experience.

5. I don't know. I don't see how the color should change unless it should be burnt, or there was dirt in the extractor.

Using Empty Brood-Combs—A Swarm's Actions.

My bees I think are doing better this spring on the summer stands packed with leaves; those in the cellar the entrances are getting daubed.

I have some empty brood-combs left from queenless colonies—some left by doubling up in the fall. How can I best use them to advantage to hive new swarms on—either to give a full set of combs or to divide them two or more to each swarm and the rest of the frames to be filled out with foundation, full sheets or stories? When a swarm issues, transfer all supers and sections to the new hive on the old stand using the S-frame dovetail hive. Our season here in Vermont is short for light honey. All is dark honey after raspberry and basswood bloom. Bees work very little on white clover when the others are in bloom. Basswood was a failure here last year, but we detected no honey-dew as the year before.

I do not think that noise has any effect on bees, in the cellar, if they are so placed that they do not come in contact with any pillar or partition. I have kept them under a room used, and part unused, and could see no difference.

I would like to mention the actions of a swarm that I did

not quite understand. I used Alley's queen and drone trap at the time it issued—leaving the queen in the trap. It alighted some 20 rods distant, up 20 feet on a large limb. This swarm did not return to the parent hive after a week's bleaching, of sunshine and rain, and remained on the limb though they were one-half diminished during this time. To remove them finally they were burnt down with a torch on the end of a pole. Were they lost, or were they afraid to return? F. S. C.

ANSWER.—It doesn't make a great deal of difference how you use the combs. You can fill the hives with them as far as they go, or you can put two or more in each hive and then fill out with frames filled with foundation. But if you mix the two in the same hive, let the combs be all at one side and then fill out with foundation. If you alternate them the bees sometimes prolong the cells of the old combs and make the new cells on the foundation very shallow.

In rare cases a swarm will hang in the way yours did until they all disappear, and I don't know any reason for it unless it be stupidity or pure cussedness.

Bees Are Animals—Taxing Them.

1. In all dictionaries bees are classed as insects. In what way can they be called animals, as they are called in all law decisions?

2. Also tell in what States bees are taxable property, and explain in what way they can be classed as taxable property. S. T.

ANSWERS.—1. As a bee could not be admitted into the vegetable or mineral kingdom there's nothing left for it but to get into the animal kingdom. Anything that has animal life is included in the animal kingdom. An animal is thus defined in the dictionary: "A sentient living organism broadly distinguished from a plant by incapacity to convert inorganic matter; a sentient living being." That definition very plainly includes the bee, so a bee is an animal, and is so called in law.

2. Each State has its own laws, and I don't know what States tax bees. In the State in which I live, Illinois, bees are taxed, and very properly. If a man's property should be wholly or solely in bees, he would probably want the State government to protect him in his rights, and if he has the benefit of that protection he surely ought to be willing to support it by means of paying taxes.

To Prevent Increase and Get Spring and Fall Flow.

Please advise me regarding the working of the following plan, as I cannot find a way to prevent swarming that is of use to me:

The flow of white honey here is from scarlet, white, and Alsike clover, and bush honey-suckle, and closes about July 10. There is nothing for the bees from that time for about six weeks. During that vacancy I use the Boardman feeder (which has given me a great deal of comfort.) I fill the brood-nest with sugar syrup and get the buckwheat and golden-rod honey in the supers, that is, trade sugar for honey. I would do it in the spring, but our first honey is better, but where it comes from I am not able to find out.

As I have fully stated the case, I will now state the question: To prevent increase and work the bees for spring and fall flow, how will it do to hive the swarm in S-frame super of shallow frames with one-cell starters, place on the same a queen-excluding honey-board, run the bees from the old hive into the swarm for 10 or 12 days, then after the white honey unite with the old colony for the fall flow? J. C. S.

Willow Grove, Del.

ANSWER.—That's a little after the plan of John F. Gates—a plan that he has successfully followed for some time. I don't know any reason why it may not do as well with you. I suppose your idea is to leave in the old hive only as many bees as will take care of the brood, then the swarm being in limited quarters will be obliged to put in its time on the sections.

The Alsike Clover Leaflet consists of 2 pages, with illustrations, showing the value of Alsike clover, and telling how to grow it. This Leaflet is just the thing to hand to every farmer in your neighborhood. Send to the Bee Journal office for a quantity of them, and see that they are distributed where they will do the most good. Prices, postpaid, are as follows: 50 for 25 cents; 100 for 40 cents; or 200 for 70 cents.



Largest Factory in the West COMPLETE STOCK. Good Supplies and Low Prices. Our Motto.

READ THIS—Mr. Keyes says: The 100 pounds of Extra-Thin Foundation you sent us' is superior to anything he ever saw; and I think the same. R. L. TUCKER, Wewahitchka, Fla.
 Dear Sirs:—The Sections came duly to hand. Indeed, they are very nice. Yes, sir; they are as good as the best. CHARLES H. THIES, Steelville, Illinois.
 Leahy Mfg. Co.:—I have received the bill of goods. I must say they are the choicest lot of Hive-Stuff I have ever received from any place. I admire the smoothness of your work, and your close selection of lumber. Yours very truly, O. K. OLMSTEAD, Orleans, Nebr.
 Dear Sirs:—The Sections arrived in due time, and are all O. K. so far as examined. They are simply perfection. I can't see how you can furnish such goods at such low prices. I hope you may live long and do well. Yours respectfully, Z. S. WEAVER, Courtney, Tex.
 Gents:—I received the "Higginsville Smoker" all O. K. It's a dandy; please find enclosed stamps for another. Yours truly, OTTO ENDERS, Oswegatche, N. Y.
 Gentlemen:—I have bought Supplies from nearly all the large manufacturers by the carload, and I must say yours are as good as the best. Indeed, in many lines they are the best. It is a pleasure to handle them. E. T. FLANAGAN, Belleville, Illinois.
 The above unsolicited testimonials are a fair sample of hundreds we receive. Our prices are reasonable and the "Higginsville Goods" are the best.
The "Higginsville" Goods are for sale by the following parties:
 Chas. H. Thies, Steelville, Ill. E. T. Flanagan, Belleville, Ill.
 Henry L. Miller, Topeka, Kans. E. A. Seelye, Bloomer, Arkansas.
 J. W. Rouse & Co., Mexico, Mo. P. J. Thomas, Fredonia, Kans.
 Fulton & Gregg, Garcon City, Kans. W. J. Finch, Jr., Springfield, Ill.
 If you need a Carload of Supplies, or only a Bee-Smoker, write to us. Remember, we are here to serve you, and will, if you give us a chance. **A Beautiful Catalogue Free.**
 Address, **LEAHY MANUFACTURING CO., HIGGINSVILLE, MO.**
 49A *Mention the American Bee Journal.*

CHEAPER THAN EVER

Hilton's White T Supers
Chaff Polished Foundation
Hives Sections Smokers
 And everything needed in the apiary.
1896 Catalog of 36 pages free.
GEO. E. HILTON,
 13Atf FLEMONT, MICH.
Mention the American Bee Journal.

Dadant's Foundation in Chicago!

No other Goods kept here. Send for Price-List.
CHAS. DADANT & SON,
 118 Michigan St., CHICAGO, ILL.
 13Atf Please mention the Bee Journal.

MOVED TO LARGER QUARTERS!

In order to take care of the business properly at this Branch, we have moved to **118 Michigan St., [3rd Floor]**, within two blocks of the Northwestern Passenger station, where we've secured larger quarters, making ample room for a **Full Assortment**. Send along your orders, remembering that we guarantee satisfaction, and at prices as low as the best quality of Goods can be furnished for. **Special Prices** on a lot of Stock we are closing out. Send for CATALOG and a List of Goods at Special Prices.

TRIANGULAR-TOP FRAMES.

We also have a stock of Triangular Top Langstroth Frames at these **Special prices:**
 100 for \$1.00; 300, \$2.70; 500, \$4.00; 1000, \$7.00.
 On all freight orders of \$5 or less, at this Branch, please add 25c. for cartage. **Catalogue Free.**
The A. I. ROOT CO., 118 Michigan St., CHICAGO, ILL.
 Geo. W. York, Mgr. Please mention the American Bee Journal.

MUTH'S HONEY EXTRACTOR
 PERFECTION
 Cold-Blast Smokers,
 Square Glass Honey Jars, Etc.
 For Circulars, apply to CHAS. F. MUTH & SON,
 Cor. Freeman & Central Aves., Cincinnati, O.
 Send 10c for Practical Hints to Bee-Keepers.

ONE MAN WITH THE UNION COMBINATION SAW
 Can do the work of four men using hand tools, in Rippling, Cutting-off, Mitring, Rabbeting, Grooving, Gaining, Dadoing, Edging-up, Jointing Stuff, etc. Full Line of Foot and Hand Power Machinery Sold on Trial. Catalogue Free.
SENECA FALLS MFG. CO.,
 46 Water St., SENECA FALLS, N. Y.
 1A1y *Mention the American Bee Journal.*

SECTIONS

\$1.50 a M. 3 M, \$4.25.
 These ARE NOT Seconds, but perfect Sections. As they are not up to our present high standard, we wish to close them out. Sample free. Widths—7-to-foot, 1 15-16 in., and 2 in.
Catalog of Bees & Supplies FREE.
I. J. STRINGHAM,
 105 Park Place. NEW YORK, N. Y.

Question-Box.

In the multitude of counsellors there is safety.—Prov. 11-14.

Best Honey-Plants in the Order of their Value.

Query 8.—What honey-producing plants would you recommend bee-keepers to endeavor to spread? Please name them in the order of their value, as you believe.—PA.

- Prof. A. J. Cook—Sweet clover.
- B. Taylor—Alsike clover first; sweet clover next.
- Mrs. J. N. Heater—White clover, melilot (or sweet) clover, alfalfa clover.
- J. M. Hambach—In the East, sweet clover, linden trees, and Alsike clover.
- Chas. Dadant & Son—White clover, alfalfa, Alsike clover, melilot (sweet clover).
- R. L. Taylor—Such as are profitable for other purposes. Alsike and crimson clovers, and alfalfa.
- Jas. A. Stone—Alfalfa, if suited to your climate; sweet clover, Alsike clover, and white clover.
- H. D. Cutting—A wild "honey-producing plant" in one section may be of no account in another.
- W. R. Graham—Sweet clover. The season has more to do with the producing of honey than the flowers.
- Eugene Secor—1. Linden (basswood). 2. White and Alsike clover. 3. Buckwheat. 4. Sweet clover (mellilotus alba).
- Dr. J. P. H. Brown—Soil and climate call for different honey-flora. Study the best in your location, then plant accordingly.
- Allen Pringle—Basswood, Alsike clover, buckwheat, crimson clover, white clover, sweet clover, raspberry, motherwort, etc.
- Dr. C. C. Miller—Depends upon place and various circumstances. In this locality, perhaps sweet clover, crimson, and Alsike.
- G. M. Doolittle—I do not think it pays bee-keepers to plant anything that is of no value save for honey. Fruit trees, the clovers, basswood, and buckwheat are the things to "tie to."
- W. G. Larrabee—1. White clover. 2. Basswood. 3. Alsike clover. 4. Buckwheat. 5. Sweet clover. 6. Raspberry. Perhaps alfalfa would come in among the first, if I knew more about it.
- Rev. M. Mabin—Crimson and Alsike clovers. I know of no others that can be cultivated with advantage in this region. Rape might, but I do not know. White clover does not need to be spread. It spreads itself.
- E. France—In this latitude sweet clover, Alsike clover, catnip, etc. But I never could sow anything that did any good. Our State has put sweet clover on the foul-weed list. The farmers about here fight it, and the stock feed it to death.
- G. W. Demaree—After trying to help my honey-resources by scattering seeds of divers varieties as honey-plants, I now have mighty little faith in it. Alsike clover would be a great source of honey-supply to me if the plant was a success as a forage crop here, but it has

proven a failure. It is a biennial plant here; you sow it, say this spring, and it makes a good crop next year, and dies, root and branch. If it would make two or more good crops like red clover, from the one seeding, there would be some chance for its introduction, but it won't.

C. H. Dibbern—Anything that will grow in your locality, and furnish nectar for your bees. Sweet clover is the only plant that I know of, that can be depended upon to hold its own against all the world, and is one of the best honey-plants we have.

Mrs. L. Harrison—Sweet clover, in all waste places, gravelly knolls, and roadsides. The more it is down-trodden, the better it thrives. Encourage the sowing of crimson clover, Alfalfa in localities where it will thrive. Alsike clover first, last, and all the time.

J. E. Pond—In my own locality I do not think it pays to spread plants, with a view to a gain of honey. Buckwheat seems to me to come nearest to the point, and that sometimes fails to give a honey crop. The ordinary, natural products are the best for the purpose, in my judgment.

P. H. Elwood—Alsike clover, crimson clover (where it succeeds), white clover, and buckwheat. I do not advise nor have ever practiced, spreading weeds, but dandelion and sweet clover are good honey-plants. Dr. Miller may pull my hair for calling the last a "weed," but it is not used for forage about here.

Jas. A. Green—Sweet clover and Alsike are about the only plants which I could recommend very highly, unless the linden would come under this head. There are many more which are more or less useful, but I have had no experience with any others that will pay very well for the labor or expense of spreading them.

Emerson T. Abbott—The value of a honey-plant depends upon its adaptability to the locality, soil, climate, etc. It will not pay to plant anything for honey alone, and here in the West it is not necessary. With this locality in mind, I would name: Alfalfa, Alsike clover, crimson clover, sweet clover, buckwheat, mammoth clover, and all of the cultivated berries and fruit-trees. These are not all plants, strictly speaking, but they all have a value aside from the honey they produce. I do not think there can be any question of alfalfa being the prince of honey-plants in any locality where it will thrive, and I am not so sure but sweet clover comes next. The Government Report says, "Alfalfa has been grown with more or less success in every State and Territory in the Union."



Promptness Is What Counts!

Honey-Jars, Shipping-Cases, and everything that bee-keepers use. **Root's Goods at Root's Prices**, and the best shipping point in the country. Dealer in Honey and Beeswax. Catalogue Free.

162 Miss. Ave. **Walter S. Ponder**
INDIANAPOLIS, IND.

Mention the American Bee Journal.

HATCH Chickens BY STEAM—With the **MODEL**.
EXCELSIOR Incubator
Simple, Perfect, Self-Regulating. Thousands in successful operation. **Lowest priced** first-class Hatcher made.
4-EO, H. STABLE, 114 to 122 S. 6th St. Quincy, Ill.

Mention the American Bee Journal.

ORIGINAL BINGHAM SMOKERS
Wonderful Record!
HAVE LASTED 17 YEARS.
—BEST ON EARTH.
Always Give Perfect Satisfaction.

My cool Wire Handle and Bent Nose were patented 1892, are the original, my best invention since my open or direct draft Patent, 1878, that revolutionized Bee-Smokers. My Handle and Nose Patent bent all the other smoker noses. None but Bingham Smokers have all the best improvements. If you buy **genuine Bingham Smokers and Honey-Knives** you will never regret it. The "Doctor," 1/2-inch larger than any other smoker on the market—3 1/4-inch stove, by mail, \$1.50

Conqueror, 3"	1.10
Large, 2 1/2-in. "	1.00
Plain, 2-in. "	.70
Little Wonder, 2-in., wt. 10 oz.	.60

Bingham & Hetherington Honey-Knives, 80 cents.

T. F. BINGHAM, Farwell, Mich.
7Atf Mention the Bee Journal.

PATENT WIRED COMB FOUNDATION

Has No Sag In Brood-Frames

Thin Flat-Bottom Foundation



Has No Fishbone in the Surplus Honey.

Being the cleanest is usually worked the quickest of any Foundation made

J. VAN DEUSEN & SONS,

Sole Manufacturers
Sprout Brook Montgomery Co., N. Y.

BEGINNERS.

Beginners should have a copy of the Amateur Bee-Keeper, a 70-page book by Prof. J. W. Rouse. Price 25 cents; if sent by mail, 28c. The little book and the Progressive Bee-Keeper (a live, progressive 28-page monthly journal) one year, 65c. Address any first-class dealer, or

LEAHY MFG. CO., Higginsville, Mo.

PERFECT FRUIT BY SPRAYING.
Our 32-page Illustrated Spray Pump Catalogue tells **How and When to Spray**—mailed Free. **THE DEMINC CO.**
Gen'l Western Ag'ts., Henton & Hubbell, Chicago. Salem, Ohio.

Mention the American Bee Journal.

J. W. TAYLOR
—HAS THE BEST—
Italian Queens for Sale

Untested, ready now, 75c. apiece; 6 for \$4.25, or 12 for \$8.00. Tested, \$1.25. Select Tested, best, \$2.00. Pay for Queens on arrival. I guarantee safe arrival and satisfaction.
14A9t **OZAN, ARK.**

Sweet Clover & Canada.

At the following prices:

5 lbs.	10 lbs.	25 lbs.	50 lbs.
\$1.00	\$1.60	\$3.75	\$7.25.

Also a quantity of Motherwort and Catnip seed. Prices on application.

EGGS for Hatching. Buff Leghorns, Indian Games, & Light Brahmas. Choice Birds. A breeder for 30 years. Prices on application

JOHN McARTHUR,
881 Yonge Street, TORONTO, ONT.
15Atf Mention the American Bee Journal.

General Items.

Wintered in Good Condition.

Our bees passed through the winter in very good condition—lost only about 3 per cent. Their stores are somewhat light, but we are feeding them when the weather will permit. I have three sisters, and we all assist in caring for the bees in the busy season. Myself and one sister aid in removing the surplus from the hives, and the others take care of it when brought from the apiary. In this manner we can take care of a great amount of honey in a short time.

Dr. Peiro, on page 191, says he has just passed through a severe cold. My father is in a great deal worse condition than that. For the last two years he has been afflicted with diabetes, and has not so much as dared to taste the honey from our apiary. When he would be busy with the bees, and get honey on his hands, he felt very much like licking it off, but dared not do it. Not only is he forbidden to taste honey, but all kinds of sugar and starch.

FANNIE SHAFNIT.

Brighton, Iowa, March 3.

[We are glad to get the above from Miss Shafnit. We only wish more women bee-keepers would send in reports. We would like every lady reader of the American Bee Journal take this as a personal invitation from us, to send in a report within the next two weeks. Now, you can't say we never gave the women a chance to exercise their inalienable rights.—EDITOR.]

The Only Bee-Keeper Left.

The bees in this section are all dead except mine. I have 22 colonies in good condition.

JOS. BARGENR.

Webster, Pa., March 17.

Wire-Cloth for a Bee-Veil.

I have seen several plans for a bee-veil, but none so good as a small piece of wire-cloth to go over the eyes, as it interferes with the eye-sight scarcely any at all. Any kind of thin cloth will do for the balance of the veil.

J. W. HAYMOND.

Asheville, N. C.

Clipping Queens—Selling Honey.

A great deal is said about clipping queens, and how it ought to be done so as not to injure the queen. Some recommend a knife, some a spring cage and a plunger. I have clipped queens for 15 years and over, and never injured or touched one. My method is as follows:

I take a small pair of round-pointed scissors, such as come in a surgeon's small pocket-case; take the frame with the queen on it, and rest it on the hive; with the left hand put the point of the scissors under the wing and clip. It is done in a second after one has done a few.

If the scent is so important, after one or two queens are clipped in the device described on page 130, Feb. 27, I cannot see why the scent would not be imparted to the cage.

Mr. R. C. Aikin, on page 131, hits the nail, about people having good sense in general use and none in regard to honey. These are not his words, but it is the English of it. To give an illustration:

A neighbor came over to my place. I was extracting honey. He bought some. I drew it from the extractor into some jars he brought with him. This was in October. A week ago he came over, and wanted to know what kind of stuff I sold him for honey. The jar he brought over was as white as marble. I explained to him the best I could the cause, but still he thought

BUY "DIRECT FROM FACTORY," BEST MIXED PAINTS

At **WHOLESALE PRICES**, Delivered **FREE** For Houses, Barns, Roofs, all colors, and **SAVE** Dealers profits. In use 54 years. Endorsed by Grange & Farmers' Alliance. Low prices will surprise you. Write for Samples. O. W. INGERSOLL, 289 Plymouth St., Brooklyn, N. Y.

12A13 Mention the American Bee Journal.

MURDERED

We have killed high prices. Give me a trial order and be convinced that good Queens can be reared for 50 cts. each. Untested, 50 cts.; Tested, 75 cts. Golden Italians, 3-Banded Italians, and Silver-Gray Carniolans, all the same price. Best of References given.

C. B. BANKSTON,

13Atf CHRIESMAN, Burlison Co., TEX.

Mention the American Bee Journal.

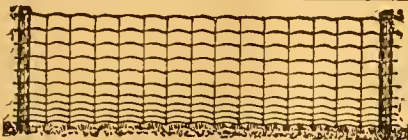

WE DIVIDE THE WORLD

into three classes. Those who will have the best. Those who want the best, and those who don't care so it's cheap. The first always buy Page fence, the second most always, and the third buy one of the many substitutes.

PAGE WOVEN WIRE FENCE CO., Adrian, Mich.

WHEN ANSWERING THIS ADVERTISEMENT, MENTION THIS JOURNAL.

Comb Foundation

Made by Automatic Machinery, Lowest in Price.

Falcon Polished SECTIONS. Finest Made.

Otherwise in stock a full line of

Higginsville SUPPLIES. Cheapest Sold

Seven R. R.'s and 4 Express Co.'s to ship over. Catalogue and Samples Free.

W. J. FINCH, Jr., SPRINGFIELD ILLS.

Mention the American Bee Journal.



SUCCESSFUL INCUBATOR

Our magnificent new catalogue giving full information regarding articles of Hatching & Brooding and treatise on poultry raising sent for 4c stamps. Circular free.

Write now. Des Moines Incubator Co. Box 78 Des Moines, Ia

11A9t Mention the American Bee Journal.

California

If you care to know of its Fruits, Flowers Climate or Resources, send for a Sample Copy of California's Favorite Paper—

The Pacific Rural Press

The leading Horticultural and Agricultural paper of the Pacific Coast. Published weekly, handsomely illustrated, \$2.00 per annum. Sample Copy Free.

PACIFIC RURAL PRESS,

220 Market St., - SAN FRANCISCO, CAL.

New England Supply Depot !

You can get the most complete Bee-Hive, also other Supplies, at—**H. ALLEY'S,** Room 5, 82 Water St., - BOSTON, MASS.

13DtF Mention the American Bee Journal.

he was cheated. I had some comb honey I had had so long it was candied (and it was solid). I gave him a pound section, asking him to try it, and let me know about it. I saw him in a few days, and he said it was as hard as a stone, and he would like to know how I made the confounded stuff and got it into the comb. He was going to get a colony of bees to get some pure honey to eat!

Now, what are you going to do with such ignorance? **GEO. L. VINAL,** Charlton, Mass.

A Smoking Fact.

It is very considerable of the ladies and educators to stir up public interest against the evil of cigarette smoking, but I venture to say that if the daddies of the boys addicted to the evil habit were to set their youngsters the example of abstinence in the use of tobacco, far greater good would result than present prospects indicate. What the boys need is moral suasion, with the occasional help of a springy rattan, to promote right conclusions regarding the filthy and dangerous habit of smoking.

No use in the old deacon lecturing upon the terrible vice, when his breath reeks with the fumes of an old pipe, and his patriarchal beard is streaked with coloring from tobacco chewing. Boys soon learn to despise hypocrites. **DR. PEIRO,** 100 State St., Chicago.

Bubby Has His Say.

Wunst pa found a swarm ov bees Buzzin' 'mongst the apple-trees Way down in the orchard; an' He ist beat on a dishpan Till they settled on a lim; Nen he took a saw an' clim Up the tree, an' let 'em down So thay peart neart touched the groun'.

I stood fur off when pa kum Frum the tree an' got a gum Fer them bees; nen he ist took Down the lim an' shook an' shook, Shook an' shook, till all the bees Flied back in the apple-trees; Nen they chawed the rag—got mean 'Cause they couldn't find their queen.

'Bout a bushel ov 'em lit On pa's head, an' thay ist bit Him rite on the eyes an' nose— Their sharp teeth stuck in his clothes Tight as burrs—an' the fur flew! Bet yer boots the air wuz blue 'Round thare; 'cause pa ripped an' tore 'Bout the orchard, nen he swore!

Ma, she kum an' pulled up three Kinds ov weeds fer pa; an' she Took an' beat 'em with a rock— Plantain, jimson, yeller rock— Till thay mellered; nen she fixed Up salt, soda, camfire, mixed With them weeds—an' that ere stuff Stopped the hurtin', shure anuff!

Pa don't like bees, no-sir-ee!— Took an' sulfured every bee On the diggin's; an' said he Hadn't enny further use Fer sich stock—an' nen cut loose On 'em!—Hawey won't indooce Him to keep bees; no, not one— Hundred-ninety-forty-ton! **Alexander, Ind. ELLERY KRUM.**

That New Constitution.

There is one clause in it which would surely cut me off from ever becoming a member of the new organization, as proposed on page 757 of the Bee Journal for 1895. That is the clause which makes an "assessment" possible. It is a theory of mine that every man is entitled to know the price of a thing before he buys it, and no man can know the cost of membership in a society where an assessment can be made. I, for one, do not care to belong to any



POULTRY

40 Standard Breeds Illustrated & fully described in my new Poultry Book. Reliable information for poultrymen & intending buyers. Good stock Ducks & Geese; also Shetland Ponies. Send 6c in stamps **E. H. COOK, Box 27, Huntley, Ill.**

Mention the American Bee Journal. 4A13t

IF YOU WANT THE BEE-BOOK

That covers the whole Apicultural Field more completely than any other published, send \$1.25 to Prof. A. J. Cook, Claremont, Calif., for his

Bee-Keeper's Guide.

Liberal Discounts to the Trade.



NEW MAMMOTH POULTRY GUIDE showing colored plate of chickens in natural colors. Finest book ever published. Almost 100 pages. Tells all about Poultry for Profit or Pleasure. Price only 15c. **JOHN BAUSCHER, JR.,** Box 94 Fresno, Illa.

12A7t Mention the American Bee Journal.

Kansas Bee - Keepers !

—SAVE FREIGHT—

A Car-load of "Higginsville Bee-Supplies" just received. GET MY CATALOGUE.

HENRY L. MILLER,

355 Shawnee Ave., TOPEKA, KAN.

1A18t Mention the American Bee Journal.

COMB FOUNDATION !

Wax always wanted for Cash or in Exchange for Fdn. or other Supplies. My trade is established on **Low Prices** and the **merit of my Foundation. Orders filled promptly.** WORKING WAX INTO FDN. BY THE LB. A SPECIALTY. Wholesale prices to dealers and large consumers. Send for Prices and Samples to—**GUS DITTMER, AUGUSTA, WIS.** Reference—Augusta Bank. 1Atf

Mention the American Bee Journal.

DO YOU LOVE YOUR WIFE

Then save her strength, save her health, save her beauty and make her happy by buying her a **FAULTLESS QUAKER DISH WASHER.**

It is a marvel of simplicity and a wonder for utility. Washes, rinses, dries & polishes in two minutes. Lasts a lifetime. It sells quickly. Everybody wants it when they once see it. Agents make money rapidly. Write today for terms etc. **The Quaker Novelty Co. Salem, Ohio.**

13A4t Please mention the Bee Journal.

HONEY We have a large amount of Pure No. 1 Alfalfa we will sell cheap.

SEED Of those great honey-producing plants —Alfalfa and Cleome or Rocky Mountain Honey-Plant. Alfalfa seed at 7 cts. a lb.

Boss bee-escape Warranted the best, simplest and quickest Escape on the market. Sent postpaid to any address for 50 cts. It can be returned at our expense if it is not as represented, or we will send the Escape on trial to any bee-keeper wishing to test it in good faith. We are agents for the **Ferguson Patent Hive** with double-case Super and Wicket-Gate Honey-Board, with the Escape. It is the easiest, quickest hive to handle for the production of comb honey. Address,

E. S. LOVENS & CO.,

355 6th East St., SALT LAKE CITY, UTAH.

Mention the American Bee Journal. 9Atf

Say, That The Please Practical The Bother Beautiful BEE Jumbo for Copy of Jocose Paper, JOURNAL.

BEE-KEEPING IN

CALIFORNIA, OREGON, WASHINGTON, NEVADA, IDAHO, UTAH, ARIZONA, COLORADO.

All Easterners should keep in "touch" on the "LAND OF SUNSHINE"—the COMING BEE-LAND.

Address, PACIFIC BEE-JOURNAL, 365 East Second Street, LOS ANGELES, CALIF.

That Queen-Clipping Device Free!

PLEASE READ THE FOLLOWING OFFER:

We have arranged with the inventor of the new Queen-Clipping Device (Mr. Monette), to offer it to our present subscribers as a Premium for getting new subscribers.

Send us just one new name for the American Bee Journal a year (with \$1.00), and we will mail you the Queen-Clipping Device FREE; and will also send a copy of Newman's 160-page book—"Bees and Honey"—to the new subscriber. Or, the Queen-Clipping Device will be sent postpaid for 50 cts. But why not get it as a Premium by the above offer? You can't earn 50 cts. any easier. Almost every bee-keeper will want this Device. See page 130 (Feb. 27) for full description of it. Complete directions accompany each one sent out. It is a most ingenious and useful article. Address,

GEORGE W. YORK & CO., 118 Michigan St., Chicago, Ill.

organization which has the power at any time to increase the cost of my membership in the same, let the "assessment" be made by the society as a whole or through its Board of Managers. The manner of making the "assessment" is of but little concern to me, but I do most earnestly protest against any provision of that kind being made a part of the new constitution. I hope others may offer a similar protest, and that this clause may be left out. Make the annual membership fee large enough to cover all necessary expenses, and then every member will know just what is expected of him or her, and can "count the cost" before joining.

St. Joseph, Mo. EMERSON T. ABBOTT.

Under Consumption.

Emphatically, under-consumption, Mr. Doolittle, in answer to your question on page 164.

Arcadia, Mich. W. HARMER.

Bees All Alive.

My bees are all alive so far, and look well. It will be about three weeks before I can take them out of the cellar.

W. J. STEVENSON. Guelph, Ont., March 25.

Bees in Fine Condition.

My bees have come through in fine condition on the summer stands, although they had all the cider they could store from a mill in the neighborhood. I expected some loss.

R. S. RUSSELL. Zionville, Ind., March 24.

Report for 1895.

My crop of honey for 1895 was 1,032 pounds of extracted and 45 pounds of comb honey, from 19 colonies, spring count. I put 39 colonies in the cellar last fall, and took them out March 25, 1896. I have found 3 colonies dead, so far.

GEO. A. FORGERSON. Rosemount, Minn., March 27.

Bees in Fair Condition.

My bees are in fair condition up to date. I started in the winter with 13 colonies, one of the number being a nucleus I used for queen-rearing, and it was weak, but I thought I would save the queen for spring, but it does not pay. But I find since I was a novice that some things do pay, and one is, that the less I open my hives until May 20, the better and stronger the colonies are.

Burns, Mich., March 20. FRED CARD.

Good Honey-Producing Region.

In the early 40's my father was the principal, and I do not know but the only, bee-keeper in all the region of Columbiana, Mahoning and Stark counties, O., where my earliest recollection is that of the long rows of boxes (hives) and bee-gums around the border of the garden and through the orchard, and I remember watching him prepare the gums by sawing off sections from a hollow sycamore log, and nailing boards on the ends. I think he kept bees quite extensively for those times, for I remember being told that he had at one time more than a hundred colonies.

I have kept bees in Michigan, but only a few colonies, but since coming to Colorado I have decided to indulge my (inherited) inclinations, and have at least as many colonies as my father had. We (my wife and myself) now have 54 colonies, snugly packed on the summer stands, and so far every one is in fine condition. How the next two months will serve them, I cannot tell. The weather has been so warm for the past two months that breeding is going on at quite a rate, with some of them, if

\$1

Buys a "ST. JOE" hive during April only, made up, Sections and Starters, no paint. One only, to new customers, to show you the best hive made.

Satisfaction guaranteed. Say how to ship, and send on your \$1

Golden Wyandotte Eggs for hatching, only \$1.00 for 13.

EMERSON T. ABBOTT, ST. JOSEPH, MO.

Fruit - Plants Free!

ALL CHOICE VARIETIES.

- No. 1—Eight Snyder Blackberry Plants, \$1.00
No. 2—50 Asparagus Roots, 1.00
No. 3—6 Fay Prolific Currants, 1.00
No. 4—3 Snyder Blackberry, 20 Asparagus Roots and 3 Fay Prolific Currants, 1.00
No. 5—3 Blackcap Gregg Raspberries, 3 Choice Red Raspberries, 12 10'a Beauty Strawberries and 2 Fay Pro. Cur., 1.00
No. 6—4 Snyder Blackberry, 4 Golden Queen Raspberry, 12 Asparagus R'ts and 10 Erie Blackb'ry Root Cuttings, 1.00
No. 7—75 Blackberry Root Cuttings, 1.00

Special Offer — Your choice of any ONE of the above 7 Numbers for sending us one new subscriber to the Bee Journal for a year at \$1.00, and 15 cts. to pay Postage on the Plants.

GEORGE W. YORK & CO., CHICAGO, ILLS.

BEES & QUEENS.

Strong, full Colonies of Italian-Hybrid Bees, in Langstroth 9-frame hives, at \$5.00 per colony; 5 to 10 colonies, \$4.75 each. Special low price on larger orders. Bees are in good condition, and are fine honey-gatherers

Italian Queens—after May 15—Tested, \$1 each; 6 for \$5.00; 12 for \$9.00. Safe arrival and satisfaction guaranteed. Reference—George W. York & Co. Address,

F. GRABBE, LIBERTYVILLE, ILL.

32 ml. northwest of Chicago, on C. M. & St. P. Mention the American Bee Journal.

FIRST-CLASS BEE-SUPPLIES

at ROCK-BOTTOM PRICES. Send for Catalog to W. J. STAHLMANN, 14A4t WEAVER, MINN. Mention the American Bee Journal.

The Patent Wood-Veneer Foundation.

Bee-keepers should give it a test, and my All-Wax Foundation. I will guarantee there is no better made, as six years ago I discarded the old way of dipping for wax sheets, and a new invention of my own was discovered, which enables me to make the toughest kind of Foundation; also, no acid used to purify the Beeswax, and it preserves the smell of honey, which is more acceptable to the bees. Now is the time to send wax and have it worked up at low prices. Send for Samples and Catalog with low prices. Wax wanted at 31c cash, or 33c trade, delivered.

AUG. WEISS, Hortonville, Wis. 12A13t Please mention the Bee Journal. Mention the American Bee Journal.

For Sale 50 Colonies of Bees, in Langstroth 10-frame hives. Will deliver on cars here, at \$3.50 each. J. W. HOWELL, 15A7t KENTON, TENN. Mention the American Bee Journal.

Honey-Clovers & Buckwheat SEED FOR SALE.

We have made arrangements so that we can furnish seed of several of the Clovers and Japanese Buckwheat, by freight or express, at the following prices, cash with order:

Table with 4 columns: Seed Name, 5lb, 10lb, 25lb, 50lb. Rows include Alsike Clover, Sweet Clover, White Clover, Alfalfa Clover, Crimson Clover, and Jap. Buckwheat.

Prices subject to market changes. The above prices include a good, new 25-cent two-bushel bag with each order. Add 25 cents to your order, for cartage, if wanted by freight.

Your orders are solicited. GEORGE W. YORK & CO., CHICAGO, ILLS.

not all, and a long and severe cold spell now may prove disastrous.

This valley of the Cache La Poudre is a wonderful honey-producing region, as well as for other things. There are hundreds of thousands of acres of alfalfa growing; the banks of the irrigating ditches are lined with sweet clover, and the profusion of wild flowers, where the land is not cultivated—asters, cleome, and other honey-producing plants—would drive an Eastern bee-keeper wild with delight. The principal forage plant is, of course, the alfalfa, and if our ranchmen can only be convinced that the hay is as good, or better, if cut when fully in blossom, bee-keepers will be happy, for then we will seldom miss a crop of honey.

D. A. McLEAN.
Fort Collins, Colo., March 3.

Bees Wintering Well.

My 160 colonies of bees in the home apiary have pulled through all right. We have had a very cold, steady winter. Bees are very busy now working on peach, plum, and box-elder. I saw a few drones flying. I opened some of the hives to-day for the first time, and found brood in as many as four and five frames.

Send my Bee Journal along, for I can't keep house without it, when such men as Doolittle, Dr. Miller, the Dadants, and many others, contribute to it.

J. H. SIPLE.

Gunnison, Miss., March 24.

Uniting Colonies of Bees.

In the late numbers of the American Bee Journal I notice one or more methods of uniting colonies. Having had a little experience in that line myself, and my method differing from those I have seen described, I will here give it.

In the first place, my hives have loose bottom-boards. I wait till the sun sets, and then go to the colony I wish to unite with, give them a little smoke, and trim off the burr-combs, if any, and scrape off everything clean preparatory to setting the other colony right on top.

I then go to the other colony, give them a little smoke at the entrance, then lift the box right off the bottom-board, and set it over on the other box to be united with. I take my smoker and again give them some smoke at the entrance below.

I find this method very simple, and have not had any trouble yet in uniting colonies. As to the queens: I unite the inferior colony with the better, and I find, as far as my experience has been, that the strange queen to that colony is the one that is killed. If I am wrong in this, the queen not wanted can be destroyed before uniting.

GEO. TOURNAT.

San Antonio, Tex.

Three Comments.

POISONOUS HONEY.—"Novice," on page 146, agitates a subject of great interest to bee-keepers. Though I kept bees in Pennsylvania for years within range of "mountain laurel," as exactly described by him, I have never known any ill-effects to consumers of honey from my apiary. I am, however, from a limited experience with jessamine, prone to credit the prevalent theory regarding its properties fatal to bees.—[We will have a short symposium on this subject very soon.—EDITOR.]

FOUNDATION FASTENING.—Referring to the editorial foot-note, on page 148, regarding the Daisy foundation fastener, permit me to present my corroborative experience. I have tugged at a Parker for weeks, daubed with hot wax and glue; in fact, employed all kinds of methods that one would resort to who has put foundation in sections by the tens of thousands, but now, like Rambler, with the bread and butter, I say, "Blessed is the man that invented the Daisy." A slight alteration which I find of value, is a larger block, which serves as a

gauge for the foundation, and by which each section is squared as it is placed in position. The "Daisy" is all the name implies; it is easy to operate, clean, durable, rapid and efficient.

A FELLOW-FEELING.—Rambler's inimitable "experiences," etc., on page 147, vividly recall to my mind when, in that same picturesque valley, an occasional mountain zephyr, or the howl of the "cyote," only broke the nocturnal stillness, as "I stood alone at midnight," in that same six-ton honey-tank with spade and rubber boots, equipped to remove its contents, which consisted of several hundred pounds of granulated honey, several bushels of dead bees, and a large, half-rotten rodent, which had entered through the more liberal openings of those days.

H. E. HILL.

Spruce Bluff, Fla., March 12.

Honey & Beeswax Market Quotations.

CHICAGO, ILL., April 4.—White clover and basswood comb is sought after in preference to any other, and commands a better price and now sells at 15c. for clover and 13@14c. for basswood. Other white comb honey sells at 11@12c.; dark, 8@9c. amber, 9@10c., and very slow of sale. Extracted is unusually dull, with large amounts on sale. White clover and Linden, 6@7c.; dark and amber grades, 4½@5c.

Beeswax, 28@30c.

R. A. B. & Co.

KANSAS CITY, Mo., Mar. 18.—The demand for comb and extracted is fair. We quote: No. 1 white, 1-lbs. 13@14c.; No. 2, 10@11c.; No. 1 amber, 11@12c.; No. 2, 8@10c. Extracted, white, 5½@6c.; amber, 5@5½c.

Beeswax, 20@22c.

C. C. C. & Co.

CINCINNATI, O., Mar. 19.—Demand is fair for best white comb honey, at 12@14c. in a jobbing way. Extracted is fair at 4@7c. Supplies of both are fair.

Beeswax is in good demand at 25@30c. for good to choice yellow. Arrivals are not adequate to the demand.

C. F. M. & S.

PHILADELPHIA, Pa., April 4.—The demand is falling off very rapidly for comb honey, and prices are decidedly lower. Extracted seems to be shipped in from all quarters. We quote: Fancy comb, 11c.; fair to good, 7½@9c. Extracted, 4@5c.

Beeswax, 30c.

W. A. S.

NEW YORK, N. Y., Mar. 23.—There is a fair demand for white comb honey, and the market is well cleaned up. We have another car now in transit from California. We quote same: 12@14c. Plenty of buckwheat comb is on the market, and same is moving off slowly at 8c. Extracted, all grades, dull, at unchanged prices.

Beeswax firm at 30@31c.

H. B. & S.

List of Honey and Beeswax Dealers.

Most of whom Quote in this Journal.

Chicago, Ills.

R. A. BURNETT & Co., 163 South Water Street.

New York, N. Y.

HILDRETH BROS. & SOELKEN,
120 & 122 West Broadway.

CHAS. ISRAEL & BROS., 486 Canal St.

Kansas City, Mo.

C. C. CLEMOMS & Co., 423 Walnut St.

Buffalo, N. Y.

BATTERSON & Co., 167 & 169 Scott St.

Hamilton, Ills.

CHAS. DADANT & SON.

Philadelphia, Pa.

WM. A. SELSER, 10 Vine St.

Cincinnati, Ohio.

C. F. MUTH & SON, cor. Freeman & Central ave.

ILLINOIS.—The spring meeting of the Northern Illinois Bee-Keepers' Association will be held at the home of Mr. O. J. Cummings, in Guilford, on May 19, 1896. Come, and bring your wives and friends interested in bees.

New Milford, Ills.

B. KENNEDY, Sec.

PERSONAL MENTION.

Mr. E. B. WEED—the New-Process combination man—called on us last Thursday on his way back to The A. I. Root Co., from Chas. Dadant & Son, where he had been nearly a month putting in a machine for making the New Process foundation. Mr. Weed is a hustler. He will spend the season at Medina, experimenting in various lines in the Root apiaries.

Mr. & Mrs. DAVID STICE, of Swan Creek, Ill., have 8 or 10 colonies of bees, which they think pay them well for the little work they do on them. They are too humane to ever rob them, and the result is, they are seldom without honey for their table, which is not a very small quantity, as they generally have several hired hands to help run their large and beautiful farm, besides much company, and also have some honey to sell nearly every year.

"THE INIMITABLE HASTY" is kept pretty busy these days fishing out the good things from the other bee-papers in order to "View" them for the Review. In his March contribution he had only reached page 18 of the Bee Journal for this year. Over 200 pages behind! He'll have to move more "Hastily," or he'll get so far behind as to be quite "out of sight." But it's a hard matter to condense so many good things into so limited a space as is at his command.

MR. W. D. FRENCH, from Foster, Calif., writes thus, March 24:

FRIEND YORK:—Sunday, March 22, a young lady came to my house in San Diego, declaring her intentions to remain and become a bee-keeper. She weighs 10 pounds, and all are doing nicely.

"Now, Mr. Hilton, you can't go me one better."

We extend our heartiest congratulations to the parents of that "little French girl."

MR. & MRS. WILLIAM DAVENPORT, of Roseville, Ill., have some 18 colonies of bees in a hive that is very successful in wintering; it holds 16 frames, double-walled, with a dead air space. In the winter they lay a sack of chaff on top of the frames, and in summer they remove it and set in a super holding sections. The hive has so many frames that they seldom have to feed. The size of the frame is 10½ inches deep and 11½ wide, inside measure. Mrs. Davenport does much of the work herself. She remarked one day that she dearly loved to work among her bees. She and her husband are so good-natured it is no wonder their bees do fairly well for them.

"And their bees improve all shining hours
When there is honey in the flowers.
She oft among her bees is seen,
While they store rich cakes of nectar,
Fit to grace the table of a queen."

Fine Catalogue for Poultrymen.—If our readers have not availed themselves of the privilege offered by the Reliable Incubator & Brooder Co., of Quincy, Ills., of getting a first-class poultry catalogue and incubator book free, they are missing a great deal. All they ask is enough to pay postage—4 cents. Better send at once, before they are all gone. This firm is rightly named—"Reliable."

Toronto Convention Report has been issued in pamphlet form, and will be mailed from the Bee Journal office for 25 cents. Better have a copy, if you have not read it. Only a limited number of copies were bound.

Bottom Prices

**BRING US BIG TRADE.
GOOD GOODS KEEP IT.**

If you want the best supplies that can be made at a little less cost than you can buy the same goods for elsewhere, write to us for low prices. 1896 Catalogue now ready—ask for it and a free copy of **The American Bee-Keeper** (36 pages).

Address,
**THE W. T. FALCONER MFG. CO.,
JAMESTOWN, N. Y.**
Mention the American Bee Journal.

ROOTS Prices Reduced on Dovetail Hives and Sections. A full line of Apiarlan Supplies in stock to fill orders promptly at lowest prices for Best Goods. 36-page Catalogue Free.
JNO. NEBEL & SON, High Hill, Mo.
Mention the American Bee Journal. 4A26t

I ARISE



TO SAY to the readers of the **BEE JOURNAL** that **DOOLITTLE**

has concluded to sell—**BEEES and QUEENS**—in their season, during 1896, at the following prices:

- One Colony of Italians on 9 Gallup frames, in light shipping-box \$6.00
- Five Colonies..... 25.00
- Ten Colonies..... 45.00
- 1 untested queen. 1.00
- 6 " queens 5.50
- 12 " " 10.00
- 1 tested Queen... \$1.50
- 3 " Queens. 3.50
- 1 select tested queen 2.00
- 3 " " Queens 4.00

Select tested queen, previous season's rearing . 4.00
Extra Selected for breeding, **THE VERY BEST**. 5.00
About a Pound of **BEEES** in a Two-frame Nucleus, with any Queen, \$2.00 extra.

☞ Circular free, giving full particulars regarding the Bees and each class of Queens.
Address

G. M. DOOLITTLE,
12A25t **BORODINO, Onon. Co., N. Y.**

BEEES Smokers, Sections, Comb Foundation, and All Apiarlan Supplies cheap. Send for FREE catalogue. E. T. FLANAGAN, Belleville, Ill.
6A26t Please mention the Bee Journal.

TAKE NOTICE!

BEFORE placing your orders for **SUPPLIES**, write for prices on 1-Piece Basswood Sections, Bee-Hives, Shipping-Cratee, Frames, Foundation, Smokers, etc.

PAGE & LYON MFG. CO.
NEW LONDON, WIS.

WHEN ANSWERING THIS ADVERTISEMENT, MENTION THIS JOURNAL.

CARLOADS



Of Bee-Hives, Sections, Shipping-Cases, Comb Foundation, and **Everything** used in the Bee-Industry.

I want the name and address of every Bee-Keeper in **America**. No reason why you cannot do business with me. I have Cheap Lumber and Experienced Workmen; a good Water-Power Factory and know how to run it. I am supplying Dealers as well as consumers. Why not you? Send for Catalogues, Quotations, etc. **W. H. PUTNAM,**
RIVER FALLS, Pierce Co., Wis.

Mention the American Bee Journal.

26c Cash Paid for Beeswax!

For all the **good, pure yellow BEESWAX** delivered to our office till further notice, we will pay 26 cents per pound, cash; or 30 cents for whatever part is exchanged for the Bee Journal, Honey, Books or Seed, that we offer. If you want **cash promptly** for wax, send it on at once. Dark or impure wax not taken at any price. Address plainly,

George W. York & Co., 118 Michigan St., Chicago, Ill.

SECTIONS, BEE-HIVES, SHIPPING-CASES

We make a Specialty of these Goods, and defy Competition in

QUALITY, WORKMANSHIP AND PRICES.

☞ Write for Free Illustrated Catalogue and Price-List.

G. B. LEWIS COMPANY, Watertown, Wis.

☞ Be sure to mention the American Bee Journal when you write. ☞

19th Year Dadant's Foundation 19th Year

Is still in the lead, for we use all the latest improvements, including the **NEW PROCESS**, and still make the best goods. Remember that we do not use any acid to purify our beeswax, and that is why our Foundation preserves the smell of the honey and is more acceptable to the bees, than any other. It is kept for sale by

- T. H. Strickler, Solomon City, Kansas.
- G. K. Hubbard, Fort Wayne, Ind.
- L. Hansen, Davenport, Iowa.
- C. Theilmann, Theilmanton, Minn.
- E. C. Eaglesfield, Berlin, Wis.
- E. T. Abbott, St. Joseph, Mo.
- J. M. Jenkins, Wetumpka, Alabama
- John Key, East Saginaw, Mich.
- Vickery Bros., Evansville, Ind.

- The Jennie Atchley Company, Beeville, Texas.
- C. F. Muth & Son, Cincinnati, Ohio
- E. Kretzmer, Red Oak, Iowa.
- Jos. Nysewander, Des Moines, Iowa.
- G. B. Lewis Co., Watertown, Wis.
- James Reynolds Elevator Co., Ponghkeepsie, N. Y.
- Louisiana Bee-Keepers' Supply Manufactory, Donaldsonville, La.
- Page & Lyon, New London, Wis.

and many other Dealers. All agree in saying that no goods are better than ours.

Those of our customers who formerly bought through Thos. G. Newman can get our Foundation in **Chicago, Ill.**, by addressing us at **118 Michigan Street**. We keep no other goods there.

We make a specialty of **Veils and Veil Stuffs** of best quality, cotton and silk.

Langstroth on the Honey-Bee, Revised.

Bee-Keepers' Supplies, Smokers, Sections, Tin Pails, etc.

Samples of Foundation and Tulle FREE with Circular. Instructions to beginners with Circular. Send us your address.

CHAS. DADANT & SON,

HAMILTON, Hancock Co., ILL.

Mention the American Bee Journal.

—LEADS THEM ALL 8 to 24% %—

See reports of experiments with Comb Foundation at the government station, Lapeer, Mich. **FREE**—large Illustrated Catalog of everything needed in the apiary. Full of information. **M. H. Hunt, Bell Branch, Mich.**

5Dt Please mention this Journal.

READERS Of this Journal who write to any of our advertisers, either in ordering, or asking about the Goods offered, will please state that they saw the Advertisement in this paper.

BEAUTIFUL
Transparent
TOUGH

and yet
PLIABLE.

REDUCED
PRICES

NEW - PROCESS WOOD FOUNDATION

—DELIGHTS ALL—

RECENT COMPARATIVE TESTS IN FLORIDA show that the old-process dipped wax will sag or stretch in the hive nearly five times as much as that by the new Wood process.

Our New Sanded and Polished Sections and Bee-Hive Material are the Finest Product that money and machinery can turn out. **CATALOG FREE.**

THE A. I. ROOT CO., MEDINA, OHIO.

118 Michigan St., Chicago, Ill.

Syracuse, N. Y.

1024 Mississippi St., St. Paul, Minn.

AMERICAN BEE JOURNAL

ESTABLISHED 1861
THE OLDEST BEE-PAPER IN AMERICA

DEVOTED EXCLUSIVELY
TO THE INTERESTS
OF HONEY
PRODUCERS

Published Weekly, at \$1.00 per annum.

Sample Copy sent on Application.

36th Year.

CHICAGO, ILL., APRIL 16, 1896.

No. 16.



No. 2.—Producing Comb Honey in Michigan.

BY W. Z. HUTCHINSON.

(Continued from page 211.)

As the honey season comes on, every available cell will be filled with brood, pollen or honey, and little spurs of white comb will appear here and there along the top-bars, or in any space or inequality into which they can be crowded. The cells along next the top-bars will be whitened by the plastering on of little bits of new wax. Some of the stronger colonies may begin "hanging out," as nothing will crowd bees out of the hives quicker than a honey-flow. All these things show that the time is at hand for putting on the sections.

If the flow should open very suddenly, or, at least, become very profuse soon after it opens, sheets of foundation in the sections may be as good as drawn combs, but when it comes on gradually, drawn combs, or, at least, a few sections of such in each super as "bait," as it is called, are a decided advantage. If I could have my choice, however, I would be glad to have all of the sections in the first super filled with drawn, or partly-drawn, combs. I have seen seasons in which I was well satisfied that a case of partly-drawn sections of comb to give a colony at first meant *just one more case of finished honey*. A colony given a case of combs would have those combs filled and be commenced upon a second case of sections by the time that a colony given simply foundation had made a start. This difference is more noticeable with Italians than with blacks. The Italians cling to the brood-nest until actually forced out of it. If a bee hatches and the queen doesn't stand ready to put in an egg, it is quite likely to be filled with honey. Give such a colony a case of sections filled with partly-drawn combs, and the bees will store honey in the combs just about as readily as in the combs below—a long time before they will draw out foundation in the sections. Combs in the sections relieve the pressure upon the brood-nest. More brood is the result. Yes, and it starts the bees to storing above the brood-nest, and having made a start they are sure to continue it. Considering the value of drawn combs for this purpose, I should not try, to any great extent, to restrict the number of unfinished sections at the end of the season.

In this connection there is another point worth considering, viz.: that the bees will store more honey in the supers if they are not crowded too much. The sections may not be filled so plumply and solidly as when there is some crowding, but there will be more honey in the aggregate. Probably as much *finished* honey as though crowding were resorted to, while the number of unfinished sections will be augmented.

Two courses are open by which these unfinished sections may be used to advantage. One is that of "feeding back" extracted honey to secure their completion, and the other that of using them in the spring as just now indicated. In the latter case they must be extracted in the fall and the bees

allowed to clean them up. After this they must be kept away from the dirt and dust. I prefer to "feed back" and secure the completion of all sections that are at least one-half completed. Those less than one-half finished I would extract and keep over to use in the spring. When combs that are nearly completed are kept over and used again, they will not have the smooth, new look of those just built, or of those that were not more than half completed the previous season. The remedy is to use the comb-leveler invented by B. Taylor. This very quickly and satisfactorily reduces the length of the cells to the required depth, which results in a smooth surface when the comb is finished.

The tiering-up method, by means of which a whole case of sections can be handled at once, is the only one suitable to the requirements of modern bee-culture. Handling sections, putting them on and taking them off one at a time, or first putting them at the side of the brood-nest, and then later "histing" them on top, is too much work. I would not leave on a case of sections until every section was finished, but until *most* of them were, then when a lot of such cases have been stacked up in the honey-house, sort over the sections and use the one or two unfinished sections that may be found in each corner of the case in making up a few new cases of sections that will be nearly finished. These are given back to the bees to be completed.

All of course, understand "tiering up." When the first case of sections is one-half or two-thirds completed, it is raised up and another case placed between that and the hive. When the case last added has reached the same stage as the first had reached when raised up, both are raised and another placed next the hive. By the time that a third case should be added the top case is usually ready to come off. If it is not, and it seems necessary to add another case, I would take off the upper case, bees and all, and give it to some colony having not more than two cases. I have never found it profitable to tier cases more than three high. The bees seem disinclined to work so far from the brood-nest.

While shade may be dispensed with when the hives are painted white, and stand in an airy location, I think it better to have shade. The bees will not be driven out of the supers on hot days if shade is used, and the inclination to swarm is lessened. A board two by three feet in size, one edge placed even with the north side of the hive, makes the best shade with which I am acquainted. Shade-boards may be made very cheaply from cull shingles, by nailing the thick ends to the side of a piece of board four inches wide and two feet long. Some use stones or bricks to keep these boards in place. This may be all right for an out-apiary, but at the home-apiary that is almost constantly in sight, I would prefer to pick up the boards and put them back the few times that they may blow off during the season, to lifting stone twice every time a hive is opened.

In the earlier days of bee-keeping we often heard the expression: "With a swarm goes all hope of surplus." The swarm was hived in a full-sized hive and set off on a new stand, and the result was that the harvest was over by the time the hive was full and the bees ready to enter the supers. Only from an early swarm could surplus be expected. The old colony swarmed at least once or twice more, and, of course, stored no more surplus. Now a swarm is hived upon the old stand, and in some instances the brood-nest is contracted to such an extent as to force the bees into the sections which are set over from the old to the new hive. I would contract the brood-nest when hiving swarms that are expected to

work in the sections, and this is the only time that I would contract the brood-nest, unless it might be in trying to force a rather weak colony to begin work in the sections. By placing the swarm upon the old stand it will be seen that the field-bees are thrown into the swarm, which would not be the case if it were hived upon a new stand.

Many go still further in augmenting the force in the newly-hived swarm. This is by practicing what is termed the "Heddon method" of preventing after-swarming. The old hive is set to one side of the new one, with the entrance turned to one side at an angle of nearly 45°. Each day the entrance of the old hive is slightly turned towards the new hive. At the end of a week the two hives will stand side by side. The old hive is now moved to a new stand. This throws another "dose" of bees into the new hive, and robs the old hive just at a time when the young queens are hatching. Losing so many bees just at this critical time usually causes the old colony to give up swarming. As a rule, no surplus is obtained from the old colony, but it has a young queen, plenty of stores, all of its combs, and builds up into a splendid colony for wintering.

As a rule, the swarm is not in the best condition for wintering. It has an old queen, its workers have "used themselves up" in storing honey, and the contraction of the brood-nest has restricted the production of brood. There is also a lack of stores for winter. A good plan is to unite such colonies as soon as possible after the supers are off. Don't wait until fall, as bees need some little time to get their stores and things in shape for winter. Decide, if you can, which of two queens is less desirable, and destroy her. About two days later the queenless colony may be united with the one having the better queen. Simply set the queenless colony over the one having the queen, and in a day or two the best combs may be set together in one hive.

In my next I will have something to say of the use and non-use of comb foundation. Flint, Mich.



Is the "Union" on the "Down Grade"?

BY THOMAS G. NEWMAN.

In the Bee Journal for April 2, I notice that Dr. Miller (on page 211) does not appreciate "unkind flings," and yet in the same article, which is only of about one-half a column in length, he speaks of the National Bee-Keepers' Union thus:

"I was one of the first members of the Union, and have always been loyal to it. I want to see it continue and increase. As matters stand, at present, the prospect is that it will go out of existence. There's no use blinking the fact that it is now on the down-grade, as to members."

While Dr. Miller may not have intended this as an "unkind fling," it will certainly be so taken by many who read it. It is a fact that the Union is not increasing in membership, but who could expect it to increase when bee-keepers have had four or five failures in the honey crop, year after year, which has had the effect of discouraging thousands, driving out of the business all who could see their way clear to improve their condition, by abandoning it and embarking in something else promising more lucrative returns. Ask the publishers of the different bee-periodicals whether they have increased their circulation lately; nay, more, ask them if they have not *lost* from 20 to 30 per cent. of their subscribers during the past few years, and I think, without doubt, the answer will be that they have done so, and that it has been consequent upon the cause I have just mentioned. Yet the National Bee-Keepers' Union has kept its membership far beyond my most sanguine expectations under these untoward conditions.—[No, we do not *think* that any of the best bee-papers have lost even 10 per cent. of their subscribers the past four years. At least the Bee Journal has not.—Ed.]

Last year its decrease was only 20 per cent., which I think is *less* than the percentage of loss in the best bee-periodical in existence!

In addition to the failures in the honey crop, the business of the country, during the past four or five years, has been paralyzed, and money has been almost impossible to get; all kinds of business in every locality in the United States has suffered in consequence. When these circumstances are also taken into account as factors in the career of the Union, it is indeed surprising that it has *retained* so many of its members.

Still another cause for loss of membership is the fact that during the past few years when the bees have gathered only a partial crop of honey, envious neighbors have not been sufficiently wrought upon by jealousy to prosecute, and hence there have been fewer lawsuits, and less trouble generally in communities where bees have been kept; as a result, many

bee-keepers have become apathetic, and it is *wonderful* that the Union should not have lost more members than it has, if the latter is taken into account.

Dr. Miller wrote his item, evidently, without sufficient thought, but no one will say it was with "malice aforethought." The Doctor is too good a man for that, but his language is misleading and unreasonable, when he says: "There's no use blinking the fact that it is now on the down-grade as to members." The Union is no more on the "down-grade" than are multitudes of other institutions that are *not now* prosperous, all over the whole country. She has held her own better—much better—than her most sanguine friends could have hoped for or expected.

If "amalgamation" is to be effected, its friends must present the strongest arguments in favor of its accomplishment, showing the benefits to be obtained, rather than to disparage either of the institutions sought to be united. I believe in building up—not tearing down!

Let our zeal be "according to knowledge," not tempered with suspicion, envy or jealousy. We should commend the good work and efficiency of both institutions.

Chicago, Ill., April 2.



Sweet Clover—Harvesting It for the Seed.

BY JOHN M'ARTHUR.

In the March 26th number of the American Bee Journal I read an appeal from the editor, asking for more information about sweet clover. When one begins to write about this—the queen of honey-plants—he scarcely knows where to begin or where to end. I have always written favorably of it as a forage and honey-plant, having had 15 years' experience in cultivating, harvesting and marketing the seed. If my experience will be any benefit, it will be given freely.

Before going into details, allow me to say a few words about an editorial that appeared in the Canadian Bee Journal for Jan. 18, 1896, page 699. The editor said: "Some put great stock in 'sweet clover.' It may be a matter of locality, but we think it is sometimes a matter of careful observation;" and winds up by saying, "It is an injury, making the bees restless, and consume more stores than they gather." This has never been my experience. Perhaps he will wait till some one more enthusiastic than himself does the seeding, and he share the benefit. I would advise the use of a little more seed. It can be bad handy, and at reasonable figures; by doing so he would be helping himself, also his neighbors, and that is our mission here, I believe.

Mr. Wm. Stolley gave us a grand description of sweet clover in the Bee Journal of Dec. 19, 1895. Then we had another view of it in the Bee Journal of Jan. 30, 1896, discussed by the Illinois State Bee-Keepers' convention, and a really practical reading by that veteran—Mr. M. M. Baldrige, of St. Charles, Ill. Just look up those back journals and read them over and over, until you master the facts. Then get some seed, and commence the good work, and help yourself. If you do that, you will help your neighbors, and be none the poorer. You will aid the sportsman, because it is a fine cover for game. Several declared to me when harvesting, that rabbits and other game had become very numerous in the past few years, attributing it to the amount of sweet clover growing in this locality, being food and cover for them.

Another very important point not touched upon, is sweet clover from an ornithological point of view. While harvesting, we were very much surprised at the unusual amount of bird's-nests found among its many branches, and singularly reminded one of the parable of the mustard seed—Matthew xiii, 31 and 32. The season was too far gone to find eggs to identify the species; however, I brought the matter before our Natural History Society, and it will be looked into next season. This certainly is a very valuable addition to its other good qualities. Since our forests have disappeared birds have disappeared also. If we commence to cover those barren hill-sides, rough and inaccessible places, that have been denuded of its timber, we can have a growth of sweet clover in two years that will bring back, and very much increase, our insectivorous friends, which will be very much appreciated by orchardists, fruit-growers and farmers, in fact, all will be benefited. All who love Nature should gain in helping forward the wood work. Seed is cheap, and may be procured anywhere.

The question of harvesting will now be considered. The method adopted by the writer may not be the right way, but has been found the most convenient, although entailing considerable labor. As to whether the first or second crop should be taken for seed depends upon whether you are merely grow-

ing it for seed, or for hay and seed. For some time I have cut a portion for hay, and used the second crop for seed. This answers well, because the second crop is finer in the straw, producing as much seed as the first crop, and is easier managed, which, I think, answers the best from an agricultural point of view. The second growth is much finer, and after threshing it, it can be used to good advantage for litter, producing as much seed as the first crop, with this advantage, it can be handled much easier, being from two to three feet in height, while the first crop will sometimes reach from three feet to 11 $\frac{1}{2}$ —I have a sample that height in my possession, this being the exception, not the rule. It was grown in a very favorable locality.

My advice to the farmer who grows sweet clover for its food value is this: Cut in June, or at all events before it blooms, or you will have a job on your hands, and you will sweat for it, and deserve to. Mr. Stolley is right in saying so. It is very succulent, and care has to be exercised in curing it. Don't cure it too much—just have it nicely killed. If overdone, the leaves will drop off, which would be a great loss. When putting it in the mow use plenty of salt.

The acreage grown here is pretty extensive, and the seed procured is from the first crop, which is generally ripe in August, and should be cut before the second blossom appears, which is sure to be the case if we have much rain in the latter part of July, or the beginning of August. If the atmosphere is sultry and showery, nectar will be collected liberally from the second blossom.

I employ two or three men for a month, at \$1.25 per day, and accompany them to the field of operation. Each is equipped with a scythe, a sickle, and whetstone. We have a sling made from the top of an old boot, with a cord attached; this is put around our waist. The sling, or pouch, hangs from the middle of the back downwards, and contains the whetstone and sickle. It is out of the way, and always at hand when required. When reaping, we often find places the scythe cannot be worked to advantage, when the sickle is at hand and applied. The ordinary scythe is too light for the first crop, requiring what we term here the "bull-dog," a short, strong blade, generally used in cutting down weeds. The sickle, I believe, is the more profitable implement of the two. The cutting is more gently done. The clover is laid down in bundles, can be picked up gently and quickly, which means a great saving of seed. The scythe strikes hard, and out flies the seed, and, in gathering, it is a tangled mass in the swath, and much seed is lost in unravelling it.

The first few days we cut without interruption; as the seed becomes riper we cut only in the mornings, devoting the heat of the day for threshing, which is done as follows:

About 9 or 10 o'clock we select a level piece of ground with as few stubbles as possible, which are cut close to the ground, throwing on some mould to level up and make it smooth. We then spread out an old sail or canvas about 20 feet square, and gather up all clover around the threshing floor, piling it up several feet high with the heads to the center. Two then get on top with flails, or dung-forks or pitch-forks, striking with all the might. In the heat of the day the seed will fairly rush out. Towards evening you will find it more difficult to get it off the straw, showing how easily it becomes affected by moisture.

When fairly in the swing of the work, you will find it necessary to make a second threshing-floor, because of the long distance to carry. Proceed as at first, leaving the two threshers to clean up the first floor. By shaking off the straw, the bottom will be found a mat of seed and pens, and will make you sweat to shake it out. When as clean as the hands will make it, put it through a riddle, $\frac{3}{8}$ mesh. If you want it cleaner, put it through another a little finer. Bag it up, and store it away in dry, comfortable quarters. If it should be the least damp, spread it out on a floor and turn it occasionally. Should it become heated the seed is spoiled. This is one reason why we find so much poor seed.

With two carrying, and two threshing, a great amount can soon be got out of the way. The straw can be used in some cases if not too strong, for bedding. Last season I burned all except a few loads of the fine.

Don't carry it a long distance; handle carefully, and handle only once. It must be threshed on the ground. By the time you would get it into the mow, there would be no seed upon it. I have tried the reaper, and unless cut in a damp condition, or in a green state, the loss of seed is too great to warrant its application.

Select a very dry or freezing time to hull. If prepared in the above manner, the clover-huller will hull a hundred bushels in a day.

The above is the manner of procedure with the writer. Of course, we are a slow people here, in most things, and would

be glad to hear of a less expensive method of procuring the seed. By the price offered for the seed by some firms, we are inclined to think there must be a less expensive method, or else men work gratis. Ontario, Canada.

[In order that all our readers may have a chance to try sweet clover, we will send 2 pounds, postpaid, for 50 cents; or 5 pounds, by express, for 75 cents (one-cent stamps taken). Send your order at once to the Bee Journal office, and get the seed by return mail or express.—EDITOR.]



Reasons for Favoring Unpainted Hives.

BY C. THEILMANN.

On page 746 (1895) Mr. Thomas gives us some very valuable hints on painting, on which Dr. Miller remarks (page 774) that some of us believe that bees are better off in unpainted hives, but covers should be painted, etc. To this Mr. Thomas, on page 114, gives us more explanations on the wood of which most bee-hives are made, and their lasting qualities, and says: "White pine, however, does not stand exposure to the weather unless thoroughly protected by paint." Now, I wonder if Mr. Thomas has really knowledge of *this* by actual experiments, or is it only his theory, because white pine is very soft wood. If he be correct, then there must be a big difference, in some way, between Minnesota and North Carolina concerning bee-hives made of white pine.

I am not able to tell how long my unpainted white pine bee-hives will last hereafter, but some of them have been in constant use for 25 years, and they are still in good condition; not one of them, so far, is injured enough by the weather to render it useless.

Twenty-four years ago I had 12 hives made and painted with linseed oil and white lead. For the hives I paid in cash \$48. They were made of clear, white pine lumber, one inch thick, after it was planed. At the same time I had 12 hives, same size, made of rough lumber, not painted, for which I paid \$24, and to-day one lot is about as good as the other. Now, just count the difference between \$24 and \$48, and compound interest for 24 years, and see what a nice little sum of money I would have saved with all unpainted hives.

Outside of the 12 painted hives I have since used nothing but unpainted hives, and thereby saved many hundreds of dollars on hives alone. But I consider this only a small part compared with the comfort of the bees and general success of my bee-keeping. I am in line with Dr. Miller when he says (on page 774, 1895): "So far as the bees are concerned, it will be an unpainted hive." I am not keeping bees for pleasure, but for the pay I get for my labor.

The most important point is not mentioned by either the Doctor or Mr. Thomas, namely, that the unpainted hives should not be planed on the outside, but only planed on the inside. This roughness on the outside not only helps to preserve the wood from the weather, warping and cracking, but creates very little reflection from the sun in hot weather, which all the veterans in bee-culture know unpainted hives do. Of late years this hive (the Minnesota Langstroth) is getting very popular in Minnesota, as bees winter better in unpainted hives, and it has many other advantages over painted hives. Theilmanton, Minn.



The Sun Wax-Extractor—How to Make It.

BY G. M. DOOLITTLE.

And old bee-friend of years ago writes me as follows: "I hear through Friend W. that you have thrown away the Swiss wax-extractor you used when at your place in the early eighties, and now use a sun wax-extractor. I suppose you like the latter better than the former; and if so, and you think the sun wax-extractor a really good thing, I wish you would tell us in the American Bee Journal how to make one, for from days of yore I know that you can tell us so plainly that any of us can make one. Please do this and oblige."

Yes, I now use a sun or solar wax-extractor, altogether, and find it one of the nicest things about the apiary. The Swiss was good for its capacity, and the time as to apicultural advancement, when it made its advent, but it was no comparison to a good solar wax-extractor, as to ease of manipulation, cleanliness of use or capacity of work. As to the "how" of making, I will, in order to make it plain, give the size and number of pieces contained in the extractor, by numbers, and then tell you how to put them together, as I find it in an old

diary of the time when I made the one I have been using ever since :

Number.	Pieces.	Length in inches.	Width in inches.	Thickness
1	2	30	10	$\frac{7}{8}$
2	2	14	10	$\frac{7}{8}$
3	3	15 $\frac{3}{4}$	10	$\frac{7}{8}$
4	2	30		$\frac{7}{8}$
5	2	17 $\frac{1}{2}$		$\frac{7}{8}$
6	2	32	4	$\frac{7}{8}$
7	2	16	4	$\frac{7}{8}$
8	3	34		$\frac{7}{8}$
9	2	18		$\frac{7}{8}$
10	1	34	19 $\frac{3}{4}$	$\frac{1}{2}$
11	2 straps	10	1	
12	1 sheet American stove-pipe iron	30	18	
13	2 glass	30 $\frac{3}{4}$	16 $\frac{3}{4}$	

Having these pieces cut to the dimensions above given, take No. 1, which is for the sides of the body of the extractor, and nail to the ends of No. 2. Next nail No. 3 on to one side for a bottom. No. 3 should be made from matched lumber, and all joints put together with white lead, so no loss of heat will occur from its escaping through the cracks or joints where the extractor is put together. Nail No. 4 to the outside of the extractor, at the sides, $\frac{1}{2}$ inch from the top, for the glass frame to rest on, and then nail No. 5 to the ends of No. 4 and the extractor. Now nail No. 6 to the ends of No. 7, for the glass frame, putting the glass, No. 13, into the grooves which have been previously cut for them, before nailing. These grooves should be $\frac{3}{8}$ deep, the upper one being $\frac{3}{8}$ from the top, and the next one $\frac{3}{8}$ below the first, so as to make a dead air space between the glass. Perhaps it would be better to put this glass frame together with screws, for in this way there is less danger of breaking the glass.

If you cannot handily get glass as large as stated, any number of glass 16 $\frac{1}{2}$ inches long and of the right width so that a certain number when placed side by side will make 30 $\frac{3}{4}$ inches, will do, if you have the upper and lower glass so arranged that they will break joints; still, the whole glass are better where they can be readily obtained.

The frame for these glass is to be put together with white lead, the same as the body was; but there is no lead put in the grooves, as we could not get the glass out should it ever be broken, as mine has been twice. I find that air passes very slowly where it has to go around anything in the way it does these glass.

Next nail No. 11 to the center of this glass frame at each end, nailing them in such a way that they will form loops or handles, for the frame is to be handled by these, slid off and on, when putting in bits of wax, or when manipulating in time of scarcity of honey, when robbers would bother getting in, were the sash to be lifted off bodily, instead of sliding it.

Now nail No. 8 to the ends of No. 9, nailing No. 10 to the side of the frame made by nailing Nos. 8 and 9 together, for a cover to go over the glass frame when the extractor is not in use. This cover will keep the glass from being broken by hail-storms, or from any other cause. It is not necessary to have No. 10 all of one piece, as narrower stuff with the cracks battened, will do very well.

Now take No. 12 and spring the middle down till the edges come even with the top of the body of the extractor, and snugly against what is to be the back of this body, when it is to be nailed along each side to the side of the extractor. This will give you a hollowing trough on which to put the material which is to be rendered into wax, and the black surface to the iron will so absorb the rays of the sun that it will become very hot in a short time after the cover is taken from over the glass. Fit a piece of half-inch stuff under No. 12, a little back, say 5 inches, from the front or open end, so as to keep the hot air from going under the iron, and it will help very much about keeping the wax melted in the dish into which it runs while being extracted. This keeping the wax melted in the dish helps much about securing our wax cakes in nice form.

Having all in readiness, set the extractor in or near the apiary, in some handy place, and as often as you have any bits of comb or scraps of wax, slide the cover a little forward and drop them in. When any amount has accumulated, remove the cover and in an hour or two the sun will have reduced all to a nice lot of clean wax in your dish. Of course you will prop the extractor up at the back side so it will face the sun at the right angle, and, if, in the fall of the year the inclination is so great that the refuse slides down into the wax dish, you can remedy it by fixing a piece of wire-cloth at the lower end of the iron bottom, so that the melted wax may run through, but the refuse be held back. After a little you will find many kinks about its use not given here.

Borodino, N. Y.

Preservation of Comb and Rendering of Wax.

BY HON. R. L. TAYLOR,

Superintendent of the Michigan Experiment Apiary.

While the production of wax is not made a special object by bee-keepers, at least, not in Northern latitudes, yet, in every apiary, considerable wax may be obtained from burr- and brace combs trimmed from frames, honey-boards, etc., and from drone-comb and broken bits of other comb, if one is careful to preserve them for that purpose. Often, too, a considerable portion of the bees of an apiary perish during the winter and spring, especially where little or no care has been taken to secure their comfort during those seasons, and sometimes combs become affected by the germs of the contagious disease known as foul brood. In this latter case the destruction of the combs is absolutely necessary in order to prevent the spread of the disease, and in the former, in such apiaries, there will be many combs from crookedness, or because they are made up largely of drone-cells, that are of little value as such, and in many such cases it will not be deemed desirable to undertake the preservation of first-class combs, from the prospect that the moths or the mice may destroy them before they can be put to use among the bees. In all such cases it is important that the wax the comb contains should be secured by rendering.

However, the value of choice comb is so great that its destruction should not be entered upon hastily, nor until it is fully settled, after a careful canvass of all the circumstances, that to its owner the wax it contains is all there is of value. To determine its value as comb, consider that experienced bee-keepers think it very profitable to purchase comb foundation at the rate of 10 cents for enough to fill a Langstroth frame, besides the cost of transporting it and the labor of putting it into the frame—say 12 $\frac{1}{2}$ cents in all. The comb is certainly as such, worth no less, and for some purposes very much more, but the wax that can be got from it, *i. e.*, from the comb of a Langstroth frame, is not worth more than five or six cents, which must still be heavily discounted on account of the labor involved in rendering the wax. So the least that can be said for good combs is, that they are worth at least 50 cents more per eight-frame hive for use as combs than for purposes as wax.

It is very evident, then, if one has comb that cannot presently be made use of by the bees, that it is worth while to know how to keep them in a good state of preservation. The moths and the mice are the enemies that work the most rapid destruction, but light and moisture in connection with beebread and other foreign matter cause a gradual deterioration. I have experimented largely both during the past year as well as during prior years, with different methods of preserving combs, and it has not been altogether from choice, but rather a case of necessity, for I have had on hand, not in use, for several years, from 1,000 to 2,000 combs. There are four methods which I have found to have merit, as follows :

1. Placing them in hives, over strong colonies of bees so that the bees can have free access to them. To good colonies from one to half a dozen hives of empty combs may be given, care only need be taken that no more be given than the bees will visit somewhat freely. Where it can be used this is the safest and best method, for the bees not only protect them completely, but clean them to a considerable extent, so that they are put in better condition for preservation by other methods, still it has its disadvantages; the combs must be handled two to four times a season, and during the honey season if comb honey is produced they must be removed, and this is the time when they especially need protection from moths.

2. I have had excellent success in keeping them in close hives in the shop by laying two thicknesses of newspaper upon a level place on the floor, setting a hive of them upon the paper, covering the hive with two thicknesses of the paper, putting another hive covered with paper on that, and so continue the operation until the pile is of the desired height, when the top-most hive is to be protected with paper and a close-fitting cover. As the combs are thus so tightly inclosed, they must be reasonably dry and put away only in a dry place. It is all-important, too, that they be put away early, at least before the millers have an opportunity to deposit their eggs in them. By this method I have kept combs the season through without the sign of a moth, while combs put up in the same room, in the same way, except that the paper was not used, required constant care to preserve them from destruction. The miller that produces the egg from which the moth emerges is furnished with a long ovipositor which she can insert in a small opening, such as she is almost sure to find somewhere between almost any two hives set one upon another. No doubt the openings are present only in a less degree where the paper is

used, but for some reason they appear not to invite the miller; it may be because there is something repulsive to her in paper, or, possibly, because the paper, extending outward from the hives all around an inch or so does not allow her to take the position she desires when she uses her ovipositor. There is one function which it seems reasonable to suppose the paper would perform, though, as yet, I have had nothing to test it, that is, in case the moths should obtain a lodgment in one hive, to impede their spread to the others. Tar paper unquestionably would be much more effective in this respect, and quite likely fully as repulsive to the egg-laying miller. It is worthy of a trial. The method here described, when the combs are reasonably clean, has proved with me on the whole the most satisfactory.

3. Another way that is entirely effective against the moths is to hang the combs up to the light and air with a space of at least one inch between each comb and its neighbors. This answers well enough for a season or two, or even longer, when the combs have become toughened by the cocoons of many generations of brood; but if the combs are new, the light seems to have a deteriorating effect upon the wax composing them, causing it to readily crumble; besides, combs so disposed, gather dust and the webs of other insects than the moths. For convenience in practicing this plan, when I built my shop I placed the joists overhead so as to freely admit the top-bar of a Langstroth frame crosswise, then by nailing half-inch strips near the lower edge of neighboring joists, each space is made to conveniently accommodate a tier of combs, their arms resting upon the half-inch strips.

4. The other method I have to mention is the placing of the combs in hives in the bee-cellar. It appears that a somewhat high temperature is necessary for the propagation of the wax-moth, at least, I have never known them to breed in combs placed in the cellar, so I think I may safely say that any good, cool cellar would be a sure protection against the moths. Unfortunately my cellar is damp, on account of which there is a liability to mold, unless the combs are free from filth and bee-bread, and it is worse still if they contain any honey, since, by attracting the moisture, it begins to run and thereby disfigures both the combs and hives.

Mice are particularly fond of bees and bee-bread, as well as a hive of combs as a place for building their nests, consequently, if they can possibly reach the combs they are liable to do much damage in a short time. The only security against them is to put the combs away in such a manner that they can by no possibility get them.—Review.

(Concluded next week.)



POISONOUS HONEY—DO BEES GATHER IT?

POISONOUS HONEY SIMPLY THEORY.

I was greatly pleased to read Novice's article on page 146, in regard to poisonous honey. He wrote me quite a long letter about the time the report was heralded abroad, that his bees had been poisoned by the honey from the yellow jessamine, giving a detailed account of the surrounding bees kept in his vicinity, which had access to the same pasturage, and yet no fatality was observed. Consequently, he was justified in denouncing the theory, that his bees suffered from that source. In fact, his experience was a practical observation, and not theoretical, and ought to go a good ways in breaking down wrong conclusions from a theoretical stand-point, that if a plant contained poisonous elements, the nectar it contained was poisonous also.

Upon the same theory we will say that honey would be poisonous stored from nectar gathered from the buckeye, that grows in such abundance in this State, and which yields bountifully both nectar and pollen every season, but such is not the case. If stock eat of either its foliage or fruit to any extent, it causes the same symptoms of poison as the so-called mountain laurel, and usually results in death. However, it is claimed generally, I believe, that one can eat heartily of the fruit without injury, so long as the heart, or germ, of the nut is not eaten, which is said to contain the poisonous elements. I distinctly remember, when but a small boy, being instructed never to eat the heart of a buckeye because the squirrel would not eat that portion of the nut, as it was poisonous.

Again, conclusions of some of our good, honest, and most worthy bee-keepers, from the same stand-point (theoretical), have said that pollen gathered from the flowers of plants that contained poison would cause destruction to bees that fed upon such pollen. Then if that theory is founded upon a practical experience, how does it come that in our and other localities where the most deadly poisonous plant grows by the

acre, and the bees revel for its pollen, are not annihilated, in all of those districts in which this plant grows in profusion—the wild parsnip?

Undoubtedly such reports as are referred to by Novice, heralded broadcast, will greatly damage the pursuit of bee-keeping in the various localities in which bees gather nectar from the sources mentioned. Besides, I am like Novice, skeptical on the subject; indeed, I cannot be persuaded that the great Creator of all things, animate and inanimate, would instill into plant-life a poisonous substance, and cause it to be accessible to any of His creatures through any natural source in which created. It is an unjust criticism. At the same time, through the art of man, plants and flowers may be sprayed with poisonous fluids, and bees may and do gather, and to which all cases of poisoning rightfully belong, so far as it relates to honey being poisonous gathered from natural sources.

I am glad that Novice has called this subject up. I hope to read such an array of testimony, from every section of this country, in defense of unpoisonous nectar, that will forever put to rest the theory that bees gather either pollen or nectar of a poisonous nature.

J. A. GOLDEN.
Reinersville, Ohio.

MOUNTAIN LAUREL 60 YEARS AGO.

I have noticed in the Bee Journal an item in regard to laurel being a poisonous plant. My experience is quite limited as to its poisonous nature, but 60 years ago, when a boy, I lived about 17 miles southeast of Lancaster, Pa., and we had laurel on all sides of us, within a mile or so of our apiary. My father used the box-hive, and in the fall after the first frost, the poor bees were brimstoned, and we ate honey strained through a thin cloth, in the comb, and every way. I never heard of poisonous honey, and it seems strange that it was never discovered until of late, although the laurel is poisonous. We turned our cattle out in early spring on the commons to pasture, and as the laurel is an evergreen, the cattle would seldom touch it, but when through mistake they got it, it would kill them. I have helped to skin them. We would open them and find it in them. Generally the flower is of a pink color, and sends out a delicious perfume.

Ionia, Mich.

JACOB MOORE.

KALMIA, MOUNTAIN LAUREL, OR IVY.

On page 146, "Novice" asks for satisfactory proof of the bees storing honey that was poisonous.

In the spring of 1894 there was a very hard frost late in the spring that destroyed all the fruit-bloom and killed the leaves on a great many trees. There was nothing for the bees to get honey from until the kalmia, mountain laurel, or ivy, bloomed. The plant is known by all these names. The bees had used all the honey in the hives rearing brood. In this part of North Carolina, where there was plenty of kalmia, the bees stored some honey in the sections from the kalmia. The other flowers that generally bloom at that time in the year the frost had killed, so that the kalmia was the only flower the bees could get honey from. This honey was bitter, and a number of people were very sick after eating it. The symptoms were alike in all cases, but some were worse than others.

A Mr. Ledbetter, who has about 30 colonies of bees, ate quite heartily at dinner, of the kalmia honey, and fell down in the harvest field unconscious. It was very hard work to restore him, and there were a number of cases where the people who ate the bitter honey came near dying. Mr. Ledbetter has kept bees for a number of years, and is a close and accurate observer of them. He knows just what flower the bees are working on at any time in the year, and he told me the honey came from the "ivy," "because from the freeze, you know, there wasn't anything but the ivy to get honey from—all the rest were killed, you know."

Dr. Weaver, of Asheville, N. C. said that the symptoms were those of poisoning from the poison of the "ivy."

In the spring of 1895 Mr. Ledbetter told me he had a great deal of the bitter honey, and asked if it would hurt the bees if he fed it to them. I told him to "go slow, try a little and watch the results." He took the honey from a number of sections and put it on top of the frames in two hives. It killed every bee in both hives.

The summer of 1894 was very dry, and after the sourwood bloomed there was almost nothing for the bees. The only flower I could find the bees working on was the nightshade. In a short time there were thousands of young bees lying dead in front of the hives. They were apparently the nurse-bees. Upon examination, there was plenty of sealed sourwood honey in the hives, and the brood looked all right,

but young bees kept dying until the fall honey-flow from the golden-rod and asters came, when there were no more dead bees. I am convinced it was the poison from the nightshade that killed the young bees.

In this part of North Carolina there are so many other flowers blooming at the same time as the kalmia that the bees prefer, that they do not get much honey from the kalmia. For instance, the "redroot"—*Ceanothus Americanus*—when that is in bloom, the air around my apiary is filled at night with the odor of the blossom.

I do not believe that the bees will work on the poisonous plants like kalmia or nightshade unless they are forced to by there being nothing else. I think that "Novice" will find, if he observes his bees carefully, that they are getting the honey, while the kalmias are in bloom, from some other flower. He may find a few bees on the kalmia blossoms, but I do not think much of his honey comes from that flower. It is well understood among the mountains of Polk county, N. C., when there is a great deal of "ivy," that bitter honey is poisonous, and that it comes from the "ivy." W. A. THOMPSON.

Buena Vista, N. C.

MOUNTAIN LAUREL HONEY, ETC.

I have been interested in the communications with reference to laurel honey. The experiences of those who have recently written in the American Bee Journal on that subject coincide with mine. It is now 27 years since I began keeping bees, and my bees have always had access to hundreds of acres of mountain laurel, and I have never heard or known of any one being sick from eating honey gathered therefrom. The truth is, I don't believe that bees ever gather poisonous honey from that source. Laurels are great bloomers, and in favorable seasons produce great quantities of nectar, and if it is poisonous, surely, in these long years, with my surroundings, at least one case of poisoning from its use would have come under my observation.

From the few communications published in the Bee Journal from East Tennessee, one would almost suppose that our people are lagging in bee-culture, but such is not the case. The year 1895 was not a favorable year with us, but the industry paid expenses, and left a surplus for a rainy day. Owing to the dry weather in the fall the asters and golden-rod did not produce as usual, and many bees went into the winter with a scarcity of stores, and many will doubtless fail to respond to roll-call this spring; but still we are not discouraged. I fed my bees in the fall sufficiently to secure them against starving, and so far their fatality has been less than usual. The winter here has been a mild one, and the indications are favorable for a good honey season, and it is important that our bee-keepers should be ready for it. H. F. COLEMAN.

Sneedville, Tenn., March 6.

Questions AND Answers

CONDUCTED BY

DR. C. C. MILLER, MARENGO, ILL.

[Questions may be mailed to the Bee Journal, or to Dr. Miller direct.]

Cutting Out Drone-Comb—Feeding Rye-Flour.

1. When cutting drone-comb from the frames of colonies of bees in the spring, do you first smoke them, that is, puff smoke in at the entrance? Do you shake the bees from the comb, or leave them on while cutting the drone-comb out?

2. Why do my bees refuse to go near several pans of rye-flour that I put out for them? I placed the pans about 15 feet from the hives.

S. K. L.
Olneyville, R. I.

ANSWERS.—1. Yes, you will do well to puff some smoke lightly into the entrance before opening the hive, and then give them a little on top as you open the cover. If they run down from the top, then they may not need any more, but if they show fight you must smoke till they retreat. You might cut out the drone-comb with all the bees on, but it will be easier and much pleasanter to handle the combs without any

bees on them. You can shake off most of the bees, but you will do well to brush the combs clean, using a Coggsball bee-brush if you have one. This brush is made of broom-corn, only the brush is very thin, and you would have a brush something like it if you should take a common corn-broom and cut out half or more of the brush, and then cut off all but six inches of the handle. A bunch of grass or weeds tied together makes a good brush. Asparagus is good. Remember that you'll do no good to cut out the drone-comb unless you fill in its place with patches of worker-comb, for the bees will be pretty certain to fill up the holes with drone-comb.

2. Like as not your bees don't care for the rye-flour because they can get something better. Watch when they are flying and return to the hives, and see if they are not carrying in loads of natural pollen on their legs. If they can get natural pollen you can't get them to touch the substitute. Sometimes, however, they are slow about working on the rye-flour simply because they haven't yet found it, and in that case you can bait them to it by using a little honey or other sweet.

No Bees for Sale.

I wish to inquire if you have Italian bees for sale, and if so what price, prepared ready for a long journey by express?
Furks, Wyo. A. D. B.

ANSWER.—Haven't a bee to sell. I don't do anything in the supply business. I've only two things to sell: honey—that is, when I get any—and the sort of stuff I write for these columns and the editor pays me for.

Amount and Position of Honey for Wintering.

1. Is it generally admitted that it takes 25 to 30 pounds of honey to winter a colony of bees?

2. Does it make any difference where the honey is left in the hive?

3. Should the center combs be full of honey? J. M. Ionia, Mich.

ANSWERS.—1. If you mean will bees eat 25 to 30 pounds of honey from the time they are put in the cellar till they are taken out, the answer is no, they are not likely to eat anything like that amount—many will do with a third of it. If you mean is it best to have 25 to 30 pounds of honey in the hive at the beginning of winter, yes. They'll not have much of it left by the time they can gather in the spring, and in some cases it will all be gone.

2. and 3. Yes, it's probably best to have it somewhat after the plan the bees themselves follow, having a space toward the center of the hive for the brood-nest and the honey stored above and at the sides.

Swarming and Transferring.

I am a boy, and also a beginner. I have a few colonies of bees, and I would like to know how to prevent some of them from swarming, as they did nothing else last year but swarm. I use an 8-frame hive.

I think my bees are in good condition, from all appearance. They seem to be rolling something in awfully fast; I don't know what it is. I have one colony I want to transfer. Is it the time of year to commence such work? R. W.

Coalgate, Ind. Ter.

ANSWER.—Probably what you want to know is how to prevent excessive swarming, and not to prevent swarming altogether. Most bee-keepers want at least some swarms, so as to make up for winter losses, even if they don't care to have a larger number. It is a very difficult thing to prevent all swarming, but not so very difficult to prevent each colony from swarming more than once.

When a colony swarms, if left to itself it is likely to send out a second swarm in a week or ten days, perhaps another a day or two later, and some colonies keep this up until they have sent out four, five or six swarms. The desirable thing is to know how to prevent all "after-swarms," as those swarms are called which issue after the prime or first swarm. The way some do is to catch all after-swarms and put them back where they came from. If this is continued a few times, that will be the end of the matter, for each time a swarm is returned one of the young queens is killed, and when only one young queen is left there will be no more swarming. In one respect that is a good plan, for it leaves the mother colony

good and strong, and in localities where there is a good fall flow it will be in good condition to store surplus.

But in many cases it is better to expect nothing in the way of surplus from the mother colony, merely allowing it to build up in good condition for winter, and making the swarm as strong as possible so as to store a good amount of surplus from the light honey harvest. So perhaps the better plan for you, as well as less trouble, is this: Set the hive with the swarm in the place of the old colony, having previously set the old colony on a new stand a rod or two distant. For the next day or two all the bees that go to the fields from the old hive will, on their return, go to the old spot, and will unite with the swarm. That will make the swarm strong for surplus work, and of course the old colony will be just so much weaker, and that weakening will discourage them from further swarming. You may make the matter surer—for by the plan mentioned some have failed—you may make surer by setting the old hive close by the side of the hive containing the swarm, and then in six or seven days from the time of swarming moving the old hive off to its permanent location.

The usual time for transferring is when fruit-trees are in bloom.

Young Bees Flying in the Early Spring.

How early in the spring will young bees hatch, ready to frolic? One of the bee-keepers here claims to have young bees (this year's) flying out, and I contradicted him. (His bees are 5-banded, and mine are Carniolan.) Remember this spring has been cold. The bees have had two flights—Feb. 2 and March 9, then the one we disputed, on March 25. We want you as referee. E. C. C.

Tarentum, Pa.

ANSWER.—Now you're trying to get me into trouble. I think I'll say I don't know whether young bees of this year's rearing were flying March 25 or not, and I doubt whether your neighbor could tell by looking at them whether the bees were two weeks or four or five months old. I'm pretty sure I couldn't tell for certain. Tell your neighbor that it isn't best to be sure about such things, and that he's altogether too positive. Say it to him in a very stern manner, so as to make him ashamed of himself. Then when he's feeling very penitent, you may as well say a few more things to him. Say to him that in a strong colony the queen commences to lay a few eggs very early in the season, often in February. Tell him that when the bees had a flight Feb. 2, it would be nothing strange for the queen to lay at that time, and that would make bees ready to fly March 25. Perhaps you can think of other things to say without my suggesting them.

Starters in Wired Frames—Transferring and Uniting.

1. If I use only a starter, and wire the frames, will the combs be built nicely over the wire?

2. I have several weak colonies in box-hives that I wish to transfer, as soon as practicable, onto some full sheets of foundation, and some starters, and will arrange the frames alternately—full sheet first, then starter—will this work this way?

3. If I unite by April 15, by the Heddon method, will the bees of the second driving unite well with the first driving without fighting?

4. In using comb foundation, should the sheet touch the frames at the ends? C. S. R.

Lamar, Ark., March 30.

ANSWERS.—1. Maybe, and maybe not. More likely not. The bees will build down the comb just as they would if no wires were present, and if the wire happens to be just where they want the middle wall of the comb, it will be all right, but it's just as likely to come in the wrong place.

2. You may do better to have the full sheets by themselves, for if they are alternated the combs may not be so evenly built. If the full sheets are first built out, there may be danger that the others built between will be too thin. But if all are filled with brood, there will be no trouble.

3. Yes, unless there should be a dearth of forage.

4. Usually a space of $\frac{1}{4}$ inch is left, but I have had good success in wired frames with the foundation touching the entire length of the end-bars.

Every Present Subscriber of the Bee Journal should be an agent for it, and get all others possible to subscribe for it.



Amalgamation Protested.

Several articles have appeared in the various bee-journals, and more will appear in our columns, strongly protesting against amalgamating the Bee-keepers' Union with the N. A. B.-K. A. While I have advocated this step, I shall do so no more, if, in the judgment of our wisest bee-keepers, it is not best. So far as I am concerned, I don't care what is done, only so the Union or something shall take hold of this adulteration business and fight it to the end. We need more fighting and legislation.—Editorial in Gleanings.

Sweet Clover.

E. F. T. writes: "How deep do you plow sweet-clover seed in? Would it grow on sandy soil? In what month do you generally sow it?"

Without paying any attention to the order of answering, I may say that I don't generally sow it at all, but let it sow itself. My brother-in-law, who is a much better farmer than I, insists that it is best to have nothing else sown with it. The piece that I spoke of being plowed in was plowed in last spring about 6 inches deep in May, seed having fallen on the ground the year before. I don't think it would make much difference what time the seed was put in from November till the first of June, providing it was put in fairly deep, or the ground well firmed if put in shallow. I've seen it grow well on sandy soil and on very stiff clay. I don't think it would grow on a bare rock, and it would probably not make a good growth in clear sand.—DR. MILLER, in Gleanings.

The Dietetic Value of Honey.

Probably most people consider honey as the equal in value for food of any sweet sauce—no better, no worse. All should know that it possesses one great superiority—ease of digestion. The nectar of flowers is almost wholly cane-sugar. The secretions added by the bees change this to grape-sugar, and so prepare it that it is almost ready for assimilation without any effort on the part of the stomach; in fact Prof. A. J. Cook once styled honey "digested nectar." It will be readily seen that honey is a very desirable food for those with weakened digestive powers. If a person is very tired, "too exhausted to eat," it is astonishing how a few tastes of honey will act like magic. Almost no effort is required to make it ready for assimilation. Persons suffering from some forms of kidney trouble will find that honey is a much more beneficial food for them than is cane-sugar.

In eating comb-honey, many strive to reject every particle of wax, fearing that, as wax is indigestible, nightmare and other troublesome consequences will follow an indulgence in warm biscuit and honey. It is true that bread is more easily digested than warm biscuit, as the latter is inclined to "pack" in chewing, but it many surprise some to know that comb-honey is really an aid to the digestion of hot bread or biscuit. The philosophy of the matter is that the flakes of wax prevent the "packing," while the honey readily dissolves out, leaving passages for the gastric juice to enter the mass of food. * The flakes of wax are indigestible, that is true, but when warmed are perfectly smooth and soft and will not injure the most delicate membrane; in fact, they act as a gentle stimulant, and are beneficial in some forms of alimentary difficulties.

The unpleasant symptoms from which some suffer after eating honey may often be removed by drinking a little milk.—W. Z. HUTCHINSON, in Country Gentleman.

An "Infallible" Method of Introducing Queens.

Do you want an *infallible* method of introducing queens? Well, according to the November issue of the *Leipziger Bienenzeitung*, Dr. Metelli, that well-known Italian bee-master, pretends to know and practice one. First he prepares the colony which is to receive the queen. If they have neither queen nor brood, the bees are contracted in the brood-nest on as few combs as possible, the upper story is emptied of its honey-frames, and the two stories are separated by a bee-tight wire (Continued on page 249.)

THE AMERICAN BEE JOURNAL

PUBLISHED WEEKLY BY
GEORGE W. YORK & COMPANY,
118 Michigan St., CHICAGO, ILL.

REGULAR CONTRIBUTORS :

- G. M. Doolittle, of New York.
- Dr. C. C. Miller, of Illinois.
- J. H. Martin, of California.
- Barnett Taylor, of Minnesota.
- Chas. Dadant & Son, of Illinois.
- Prof. A. J. Cook, of California.
- Dr. J. P. H. Brown, of Georgia.
- Rev. E. T. Abbott, of Missouri.
- Mrs. L. C. Axtell, of Illinois.

\$1.00 a Year—Sample Copy Sent Free.

[Entered at the Post-Office at Chicago as Second-Class Mail-Matter.]

Vol. XXXVI. CHICAGO, ILL., APR. 16, 1896. No. 16.



Alfalfa Comb Honey Candyng.—Some time ago we mentioned it was claimed that alfalfa comb honey would candy sooner than most other honeys. Mr. Geo. E. Dudley, of Utah, who has had some experience in the matter, wrote us as follows, on March 28 :

Alfalfa honey in the comb has been kept here so far without candyng, in several instances ; in others it candied the last of January. I do not think it is going to candy soon enough to make an argument against its selling qualities. A Denver honey-dealer, who has come nearer supplying the trade of that city than any other man, said that by keeping his honey in a room where it was slightly warmer, was all that was necessary to do to keep it till spring.

Utah has had a lovely March—no snow or rain—and bees have been out for a week, gathering pollen.

GEO. E. DUDLEY.

Next Meeting of the North American.—In response to our request on page 216, Mr. L. D. Stilson, of York, Nebr., has this to say :

MR. EDITOR:—I notice you ask as to what Messrs. Stilson, Whitcomb and others think of the meeting of the North American being held at same time and place as the G. A. R. encampment this year. So far as Stilson is concerned, I will say, I don't think it possible to hold a successful meeting of bee-keepers in connection, or within sound, of a G. A. R. reunion. Our feet would not keep still as the martial music recalled scenes of army life, and the old soldiers would hunt up brothers with whom we touched elbows in war, and it would be a visit ; the younger people would stay by to see that they had a good time. The larger attraction of the encampment and reunion would entirely overshadow and absorb the bee-keepers.

In regard to coming to Lincoln, I would say it was in good faith that we invited the North American to meet at our State capital, and as Mr. Abbott intimates, we are making arrangements to fully carry out our part of the contract implied in the invitation and acceptance to come to Lincoln.

So far we have heard of but one reason for not coming to Lincoln ; there, however, may be another, which, for fear of hurting our sensitive natures, is not talked out loud.

In regard to the reduced railroad fare, I will say that if we are permitted to set the time of your visit, that arrangements will be such that a one rate plus \$2 or \$4 will be given, whether there be 50 or 500 present.

Regarding the second reason for not coming to Nebraska, I may say : Eleven years ago, in connection with others, we

worked up an excursion to attend the G. A. R. encampment at Portland, Maine. Our Nebraska people left Lincoln with 30 cars running in two sections going to Chicago, where the party divided, some going one route, some another, and meeting at Niagara Falls, then again at Portland. As we left Chicago, some wag of an operator wired to Portland that "500 jayhawkers (Kansans) and 700 Nebraska cowboys had just left that city, and that Portland had better look out for them." Now, if the Eastern people are afraid to come as far west as Nebraska, I will say we do not use bowie-knives for tooth-picks any more ; and when they will stop to consider that the majority of our people came from homes in the Middle and Eastern States, they will then know that we are not all barbarians, and I think the members of the North American will be as safe in visiting Lincoln as to have a body-guard of the G. A. R.

As a member of the North American, I say, keep faith with the Nebraska people, and come to Lincoln. As a Nebraskan, I say to the officers and members of the North American, come to Lincoln for your meeting this year.

Respectfully, L. D. STILSON.

All will please understand that the only reason we favor going with the G. A. R. is on account of the assured low rates. If that objection can be overcome, let's go to Lincoln, by all means. Perhaps there has been enough said now in the Bee Journal, regarding the matter. If any others wish to speak on the subject they can do so by writing to the Secretary of the North American—a member of the Executive Committee—Dr. A. B. Mason, Station B, Toledo, Ohio. That committee has the deciding to do, as to where the next meeting of the North American will be held. We having nothing further to offer, but will work for a good meeting wherever it is finally decided to go.

Wood-Base Foundation.—Mr. E. B. Weed, who has had considerable experience with wood-base comb foundation, gives the following opinion concerning it :

MR. EDITOR:—Noting your request in a late number of the Bee Journal, for the experience of those who have experimented with wood-base foundation, I will give mine.

I have tested wood-base foundation very thoroughly, and although it is readily accepted by the bees, I have found it open to two very serious objections. One is, that when the wood becomes moistened by the honey, it swells and warps. The other objection is the treatment the bees give it, as soon as the honey-flow ceases. At such times they are very likely to attack it and gnaw the comb down to the wood.

In case the combs were used only for extracting, and were removed from the hive as soon as the honey-flow ceased, they could very likely be used to advantage. E. B. WEED.

A National Bee-Keepers' Organization.—Mr. Geo. W. Brodbeck, who wrote on this subject on page 195, also contributed an article to Gleanings in regard to it. His concluding paragraphs read thus :

As a closing suggestion we urge immediate consideration and action ; and to further this project we would outline the following :

First, the selection of two delegates by each State association, or assembly of bee-keepers where no State organization exists. After due time for selection of delegates, the persons selected organize, and proceed to formulate plans for a national bee-keepers' association. The work of this preliminary organization can all be conducted by correspondence, and then submitted to the various State associations for ratification and the selection of delegates to the first assembly, the place of meeting being central and permanent.

We trust now that every bee-keeper who resides in the United States will in some way give expression to his views on the subject presented. We feel assured that, if we thus show a willingness to present our cause, it will result in a double assurance to our usually wide-awake bee-editors that they are working for "the greatest good to the greatest number."

In a foot-note to Mr. Brodbeck's article, Editor Root comments as follows :

If I understand Mr. Brodbeck correctly, he and the other California bee-keepers would not object to the amalgamation of the two societies [the North American and the Bee-Keepers' Union] providing that the North American were distinctly

national; that he thinks the present National Bee-Keepers' Union should not be enlarged in its scope so as to cover Canada. There may be something in this. When the North American was incorporated, it will be remembered that some of our Canadian brethren raised a vigorous protest. If the North American Bee-Keepers' Union, as is proposed, should become a fact, it, of course, would have to be incorporated, either in the United States or in Canada, in order to carry on the work of defense, to prosecute and be prosecuted—in fact, to act as a responsible person or firm. Obviously the Union, when amalgamated with the other association, should be incorporated in the United States.

I do not know that this point has ever been raised before; but possibly our Canadian bee-friends who objected the first time would object again. But whatever is done, I am most emphatically in favor of having the Union so modified that it shall have annual meetings or conventions, to discuss the all-absorbing problems that come before us, no matter whether they relate to defense against unjust legislation, prosecution of glucose-mixers, or whether they concern some of the problems as to how to manage bees. In other words, I am most heartily in favor of having the social annual-meeting feature hitched on to the Union in some way; and if it is not wise to have it international, let it be distinctly national.

In the event that the Bee-Keepers' Union should be changed as I have suggested, those Canadians who have welcomed the proposed change in the North American could hitch on a union to their Ontario Bee-Keepers' Association. In that case the old North American could be disbanded, and the two national associations could have joint meetings at stated or occasional intervals to discuss common interests, as was done so well in the old North American, and thus Canadian and American bee-keepers would be united in one common brotherhood as before. Then the work of defense, and prosecuting adulterators, could be carried on by each distinct national association in its own country.

Now, please understand that what I have said is meant in the way of *suggestion*, and not as a *recommendation*.

We may say in reference to this matter, that we agree exactly with what Mr. Root says. We not only favor a national bee-keepers' association, but we also believe that such organization should "hitch on" the union feature, if no amalgamation takes place, for it must be admitted that such an arrangement would serve as a strong inducement to permanent membership—the very thing that has been needed to make the old North American what it should have been.

But we do not see why this cannot all be done with one stroke—simply unite the present National Bee-Keepers' Union and the North American Bee-Keepers' Association under the name, *United States Bee-Keepers' Union*. That would do the thing easily and quickly.

There is really no need of an annual North American or Inter-National meeting, but such could be held say triennially, if deemed best. Of course, the National (Canadian and United States) associations would meet annually, and a general union meeting could take place somewhere along the border of the two countries at less frequent intervals.

It does seem to us that our country ought to be able to organize and maintain the largest and most efficient bee-keepers' association in the world. We have the bee-keepers, and plenty of splendid material for successful leadership. Now, what's to hinder carrying out, finally, all the plans before enumerated, at the next meeting of the North American, after a vote has been taken on the amalgamation question, which will be sure to carry when it is understood that the new organization will be national instead of inter-national?

We have thought out what we believe would be a splendid plan for securing a thoroughly representative organization, but we will not take the space to even outline it just now. There will be ample opportunity to do this after the initiative steps have been taken, as indicated above.

We should be glad to hear what our readers think of having a National bee-keepers' association, organized upon the lines suggested by Mr. Brodbeck, Editor Root and ourselves.

Plant Trees.—Mr. Allen Pringle, of Selby, Ont., prepared a fine essay on "Bees," which was read at the Amherst Island Farmers' Institute in February. It was printed in full in the Napanee Express for March 6, a copy of which came into our hands. In the main it treated of the primary principles of bees and bee-keeping—just what the usual farmers' institute people need—but here is one paragraph on planting trees that is well worth reading by expert as well as novice:

That bee-culture has become a science and an art is hardly to be wondered at in these days of the marvelous progress of all the arts and sciences. But, unfortunately, just as apiculture has developed into this status a most serious obstacle threatened its existence as a specialty. This obstacle is the disappearance of the nectar-yielding flora. Over the whole civilized face of North America the great forests have been for half a century rapidly disappearing. With them have gone some of the chief sources of our choicest honey—the basswood, the maple, the willow, etc. The vast areas which used to yield vegetable flora and wild flowers in abundance are turned into cultivated fields by modern machinery. Moreover, with the disappearance of the forests have come the severe and prolonged drouths which militate against every branch of agriculture—apiculture included. And right here allow me to urge upon farmers the desirability of planting trees and preserving their woods, and the scattering trees over their farms, except where they actually interfere with cultivation. This rapid destruction of trees and forests over the whole country is a most serious matter. The farmer is, of course, mainly responsible, and he will be the chief sufferer. I say to the farmers and others, **PLANT TREES**—plant wherever and whenever practicable. For myself, I practice my own preaching, and have done my share in this matter—having planted during the last 10 or 12 years about 1,000 trees—basswood, maple, etc. Our governments, local and general, ought to encourage tree-planting much more than they do; and they ought to take proper steps for the preservation of what we have left as far as possible, consistent, of course, with the rights and liberties of the subject.

AMONG THE BEE-PAPERS.

[Continued from page 247.]

net, such as can be removed without difficulty. If they have any brood (even *unripe* queen-cells) it is not removed, but they are likewise contracted in the brood-nest. If they have a queen, the same is taken away, and care had lest another laying or virgin queen be present; then contraction as above takes place. Second: Now two or three brood-combs, with the queen and all the adhering bees—the more the better—are removed from another colony and hung in the upper story, with the addition of two empty combs (containing, if needs be, a little pollen and honey), one on either side of them.

After 48 hours, the wire net is removed. After 48 hours the frames from the upper story are hung down in the brood-nest, the queen having descended quite often ere this. The upper brood-frames, without the queen, of course, may afterward be returned to their former hive. If the colony is a drone-laying one, more care is required. *All the combs* must be removed so that no eggs can be laid, and the colony be put in "swarming condition." Then when the queen, etc., are put in the upper story, the lower colony clings to the wire net in the shape of a swarm. After 48 hours the net is removed, and, after two days more, the frames are taken down to the brood-room. In all of these cases the queen is never hindered in laying. Has she been sent from abroad, a nucleus has to be formed, and, after it has accepted the queen, management is the same as above. Dr. Metelli, of course, knows the other modes of introduction too, but this one, you understand, is the *infallible* one.—[We have been taught, and rightly, that nothing will work infallibly with bees; that they do nothing invariably under all circumstances. The plan, however, looks as if it might work almost infallibly.—ED.]—CHARLES NORMAN, in Gleanings.

Causes of Swarming.

As an influence in swarming, I do not know what difference there would be as between old and young bees, for I have not observed on this point. I do know that heat bears no little influence. For the whole of my apicultural life, it has been my custom to discourage swarming. Before the flow and when they are not making a living, if I can keep them with just

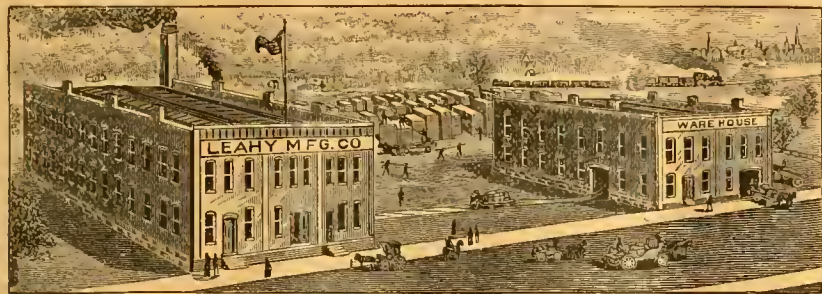

Largest Factory in the West **COMPLETE STOCK.**
Good Supplies and Low Prices
Our Motto.

READ THIS—Mr. Keyes says: The 100 pounds of Extra-Tuin Foundation you sent us is superior to anything he ever saw; and I think the same. R. L. TUCKER, Wewahitchka, Fla.
 Dear Sirs:—The Sections came duly to hand. Indeed, they are very nice. Yes, sir; they are as good as the best. CHARLES H. THIES, Steelville, Illinois.
 Leahy Mfg. Co.:—I have received the bill of goods. I must say they are the choicest lot of Hive-Stuff I have ever received from any place. I admire the smoothness of your work, and your close selection of lumber. Yours very truly, O. K. OLMSTEAD, Orleans, Nebr.
 Dear Sirs:—The Sections arrived in due time, and are all O. K. so far as examined. They are simply perfect. I can't see how you can furnish such goods at such low prices. I hope you may live long and do well. Yours respectfully, Z. S. WEAVER, Courtney, Tex.
 Gents:—I received the "Higginsville Smoker" all O. K. It's a dandy; please find enclosed stamps for another. Yours truly, OTTO ENDERS, Oswegatche, N. Y.
 Gentlemen:—I have bought Supplies from nearly all the large manufacturers by the carload, and I must say yours are as good as the best. Indeed, in many lines they are the best. It is a pleasure to handle them. E. T. FLANAGAN, Belleville, Illinois.
 The above unsolicited testimonials are a fair sample of hundreds we receive. Our prices are reasonable and the "Higginsville Goods" are the best.
The "Higginsville" Goods are for sale by the following parties:
 Chas. H. Thies, Steelville, Ill. E. T. Flanagan, Belleville, Ill.
 Henry L. Miller, Topeka, Kans. E. A. Seeley, Bloomer, Arkansas.
 J. W. Rouse & Co., Mexico, Mo. P. J. Thomas, Fredouia, Kans.
 Fulton & Gregg, Garden City, Kans. W. J. Fiuch, Jr., Springfield, Ill.
 If you need a Carload of Supplies, or only a Bee-Smoker, write to us. Remember, we are here to serve you, and will, if you give us a chance. **A Beautiful Catalogue Free.**
 Address, **LEAHY MANUFACTURING CO., HIGGINSVILLE, MO.**
 49A *Mention the American Bee Journal.*

CHEAPER THAN EVER

Hilton's White T Supers
Chaff Polished Sections Foundation
Hives Smokers
 And everything needed in the apiary.
1896 Catalog of 36 pages free.
GEO. E. HILTON,
 13Atf **FREMONT, MICH.**
Mention the American Bee Journal.

Dadant's Foundation
in Chicago!

No other Goods kept here. Send for Price-List.
CHAS. DADANT & SON,
 118 Michigan St., **CHICAGO, ILL.**
 13Atf Please mention the Bee Journal.

ONE MAN WITH THE UNION COMBINATION SAW
 Can do the work of four men using hand tools, in Rippling, Cutting-off, Mitring, Rabbering, Grooving, Gaining, Dadoing, Edging-up, Jointing Stuff, etc. Full Line of Foot and Hand Power Machinery Sold on Trial. Catalogue Free.
SENECA FALLS MFG. CO.,
 46 Water St., **SENECA FALLS, N. Y.**
 1A1y *Mention the American Bee Journal.*

SECTIONS

\$1.50 a M. 3 M, \$4.25.
 These ARE NOT Seconds, but perfect Sections. As they are not up to our present high standard, we wish to close them out. Sample free. Widths—7 to foot, 15-16 in., and 2 in.
Catalog of Bees & Supplies FREE.
I. J. STRINGHAM,
 105 Park Place. **NEW YORK, N. Y.**

MOVED TO LARGER QUARTERS!

In order to take care of the business properly at this Branch, we have moved to 118 Michigan St., [3rd Floor], within two blocks of the Northwestern Passenger station, where we've secured larger quarters, making ample room for a **Full Assortment**. Send along your orders, remembering that we guarantee satisfaction, and at prices as low as the best quality of Goods can be furnished for. **Special Prices** on a lot of Stock we are closing out. Send for CATALOG and a List of Goods at Special Prices.

TRIANGULAR=TOP FRAMES.
 We also have a stock of Triangular Top Langstroth Frames at these **Special prices**:
 100 for \$1.00; 300, \$2.70; 500, \$4.00; 1000, \$7.00.
 On all freight orders of \$5 or less, at this Branch, please add 25c. for cartage. **Catalogue Free.**
The A. I. ROOT CO., 118 Michigan St., CHICAGO, ILL.
Geo. W. York, Mgr. *Please mention the American Bee Journal.*

MUTH'S HONEY EXTRACTOR
PERFECTION Cold-Blast Smokers,
Square Glass Honey Jars, Etc.
 For Circulars, apply to **CHAS. F. MUTH & SON,**
 Cor. Freeman & Central Aves., Cincinnati, O.
 Send 10c for Practical Hints to Bee-Keepers.

TEXAS QUEENS.
 If you are in need of Queens, let me have your order. **Price-List Free.**
 8A26t **J. D. GIVENS, Lisbon, Tex.**
Mention the American Bee Journal.

Question-Box.

In the multitude of counsellors there is safety.—Prov. 11-14.

Fertilization of Queens.

Query 9.—1. In the appendix to Mr. Doolittle's work on queen-rearing, he expresses some doubt about always being able to get queens fertilized from upper stories by the methods he therein suggests. Have you tried these methods? If so, with what success?
 2. At what period in the life of a virgin queen does she become too old to be fertilized?—IOWA.

- W. R. Graham—1. I never tried it. 2. I don't know.
- B. Taylor—1. I have had no experience. 2. I do not know.
- E. France—1. I have never tried Doolittle's plan. 2. I don't know.
- W. G. Larrabee—1. I have never tried these methods. 2. I don't know.
- Mrs. L. Harrison—1. I never experimented along that line. 2. I don't know.
- G. M. Doolittle—1. Varying success. 2. I had one fertilized 28 days old, once.
- Jas. A. Stone—1. No. 2. I do not know, but I think it would not occur after one week.

- Emerson T. Abbott—1. No. 2. This is an open question. The unexpected happens sometimes.
- C. H. Dibbern—1. As I have never tried it, I must say I don't know. 2. I could only guess, and you can do that as well as I.
- Eugene Secor—1. I have never tried it. 2. It is my opinion that a young queen ought to be fertilized before she is 10 days old, for best results.
- Prof. A. J. Cook—1. I have not. 2. I think no one knows. It is very likely variable. It is a difficult problem to settle, in the nature of the case.

- Allen Pringle—I have not tried. 2. After having passed a winter in this climate. The chances, however, rapidly diminish after the age of 3 or 4 weeks.
- Dr. J. P. H. Brown—1. I have not tried them. 2. According to my experience and observation, all virgin queens that are fertilized after 17 days old are worthless.

R. L. Taylor—1. Yes, in a small way, with very poor success. 2. Probably queens vary in that respect. If I made no mistake, I had one fertilized when she was 40 days old.

J. E. Pond—1. I have never tried the plan. 2. I don't know that the question has been positively settled. Consensus of opinion gives six to eight weeks old, or thereabouts.

Dr. C. C. Miller—1. I think I was the first one to publish a case of the kind. I suspect if we could know exactly the right conditions we might always succeed. I have generally succeeded. 2. I believe some have been fertilized as old as four weeks.

G. W. Demaree—1. Yes, I have tested the plan carefully, and find that it requires the best of conditions to succeed uniformly. In fact, and indeed, so much depends upon the condition of the bees, honey-flow, etc., that the plan is imprac-

able. 2. In my experiments along this line, I have concluded that the virgin queen to be normal in usefulness, must be mated by the time she is 12 days old. I have retarded mating, by artificial means, till the 18th day, resulting in poor queens.

P. H. Elwood—1. I have not thoroughly tried the upper story for queen-rearing. 2. I remember to have had a virgin queen forgotten for two weeks in a queen-cage, that afterward became fertile, but I think this must be an exception. Ask the queen-breeders.

Rev. M. Mabin—1. I have never tried Mr. Doolittle's plan, nor seen it tried, and can express no opinion. 2. I have no experience that will enable me to speak with authority. After a virgin queen begins to lay, she cannot, or will not, be fertilized. The age will vary many days.

\$3.10 FOR THE BEST

BRASS BUCKET SPRAY PUMP on the market. It is fully described in our **SPRAY PUMP CATALOGUE**. Another valuable work is our handsome **ILLUSTRATED BOOK ON CIDER PRESSES AND FRUIT MACHINERY**. Both will be sent **FREE**.
DAVIS-JOHNSON CO.
 41 W. Randolph St. CHICAGO, ILL.

16A4t Mention the American Bee Journal

The La. Bee-Keepers' Supply & Wood Work Mfy.

WANTED—Some one to run my business on shares. Address, Box 54, Donaldsonville, La.
 Mention the American Bee Journal. 16A2t

I have one of the choicest flocks of BROWN LEGHORNS IN THE STATE

Keep no other kind. Eggs, 75c. per 15; \$1.25 per 30. **H. G. SCOTHAN,** OTISVILLE, MICH.
 16E1f
 Mention the American Bee Journal

STAND UP

 in the very worst storms, these wind mills of ours, that is because they are constructed of the very best of steel and because our four cornered steel tower is braced in every direction. All galvanized after it is put together. Tanks, Shellers, Pumps, Cutters, &c. Write. Challenge Wind Mill & Feed Mill Co., No. 18 River Street, Batavia Illinois.
 Mention the American Bee Journal.

PURE BARRED PLYMOUTH ROCK

Eggs, \$1.25 per 14. Our P. Rocks are very large, with fine plumage. Also.

BLACK MINORCA EGGS,
 a non-sitting and great laying breed. Both kinds raised upon our farm. Minorca Cockrels, \$1.00 each. **Mrs. L. C. AXTELL,** 16A4f ROSEVILLE, Warren Co., ILL.
 Mention the American Bee Journal

1896 SAVE MONEY 1896

If you want first-class **ITALIAN QUEENS** FOR BUSINESS, Foundation at Wholesale Prices, Hives, suited for the South, or SUPPLIES, send for Price-List—to
J. P. H. BROWN, AUGUSTA, GA.

Toronto Convention Report has been issued in pamphlet form, and will be mailed from the Bee Journal office for 25 cents. Better have a copy, if you have not read it. Only a limited number of copies were bound.

ORIGINAL BINGHAM SMOKERS

Wonderful Record!
 HAVE LASTED 17 YEARS.
—BEST ON EARTH.
Always Give Perfect Satisfaction.
 My cool Wire Handle and Bent Nose were patented 1892, are the original, my best invention since my open or direct draft Patent, 1878, that revolutionized Bee-Smokers. My handle and Nose Patent bent a 1 the other smoker noses. None but Bingham Smokers have all the best improvements. If you buy genuine **Bingham Smokers and Honey-Knives** you will never regret it. The "Doctor," 3/4-inch larger than any other smoker on the market—3 1/4-inch stove, by mail, \$1.50
 Conqueror, 3 " " " 1.10
 Large, 2 1/2-in. " " 1.00
 Plain, 2-in. " " .70
 Little Wonder, 2-in., wt. 10 oz. .60
 Bingham & Hetherington Honey-Knives, 50 cents.
T. F. BINGHAM, Farwell, Mich.
 7A4f Mention the Bee Journal.

PATENT WIRED COMB FOUNDATION
Has No Sag in Brood-Frames
Thin Flat-Bottom Foundation

 Has No Fishbone in the Surplus Honey.
 Being the cleanest is usually worked the quickest of any Foundation made
J. VAN DEUSEN & SONS,
 Sole Manufacturers,
 Sprout Brook Montgomery Co., N. Y.

BEGINNERS.
 Beginners should have a copy of the Amateur Bee-Keeper, a 70-page book by Prof. J. W. Rouse. Price 25 cents; if sent by mail, 28c. The little book and the Progressive Bee-Keeper (a live, progressive 28-page monthly journal) one year, 65c. Address any first-class dealer, or
LEAHY MFG. CO., Higginsville, Mo.

SPRAYING WILL PRODUCE PERFECT FRUIT.
 Our illustrated catalogue tells you HOW and WHEN to spray—mailed Free to fruit Growers and Dealers. The largest and best line of Spray Pumps and Nozzles in the world.
THE DEMING CO. Mfra. Salem, Ohio.
 Western Agency: Henson & Hubbell, Chicago.
 Mention the American Bee Journal.

J. W. TAYLOR
—HAS THE BEST—
Italian Queens for Sale
 Untested, ready now, 75c. apiece; 6 for \$4.25, or 12 for \$8.00. Tested, \$1.25. Select Tested, best, \$2.00. Pay for Queens on arrival. I guarantee safe arrival and satisfaction.
 14A9t **OZAN, A.H.K.**

Sweet Clover & Canada.
 At the following prices:
 5 lbs. \$1.00 10 lbs. \$1.60 25 lbs. \$3.75 50 lbs. \$7.25
 Also a quantity of Motherwort and Catnip seed. Prices on application.
EGGS for Hatching. Buff Leghorns, Indian Games, & Light Brahmas. Choice Birds. A breeder for 30 years. Prices on application
JOHN McARTHUR,
 881 Youge Street, - TORONTO, ONT.
 15A4f Mention the American Bee Journal.

General Items.

The Tinker Hive and Management.

On page 196 Mr. Thiry says that he would like to hear of the success others are having with the Dr. Tinker hive. I have kept bees for the last 20 years and upward, commencing with the standard Langstroth. I became dissatisfied with it, and sent for the Bay State hive, which I now have in use. Three years ago I sent to Dr. Tinker for his hive, and have used that almost exclusively since that time, and I am compelled to say I like it the best of any hive I have used. My bees have wintered the best in this hive, and I have been enabled to get the most surplus honey in sections.

There is one feature, however, about the winter case that I don't like. In adding the second story, I find it exceedingly difficult to take off the second story after it is waxed down. The case is so filled up there isn't room to work. I have not used the single-walled hive that would obviate the difficulty mentioned. I follow Tinker's plan of treatment as laid down in his book.

My bees are all in the cellar, and have wintered splendidly. They are all packed in chaff and straw mixed. I leave the packing in the hive until late in June. I do this to keep up a uniform temperature.

Until I find something better I will continue the use of the Tinker hive and his method of treatment in running for comb honey.

The American Bee Journal is a most welcome guest to my home. We take 12 or 14 different papers, magazines and journals, but the Bee Journal is among the first to be read. Long may it live to bless and encourage, as well as to enlighten, the apiarists.
 L. ALLEN.

Loyal, Wis., March 27.
 [Dr. Tinker's book, referred to by Mr. Allen, can be had at this office for 25 cents; or we will club it with the Bee Journal for a year—both for \$1.10.—EDITOR.]

Hives—Foul Brood—Wintering.

Hives receive a large percentage of argument. A beginner is at variance to know which to adopt, and well may be at a loss to choose intelligently among our many very good bee-receptacles. Some say, "Choose the standard!" I say, experiment on a small scale first, and choose that which is best adapted to your locality. The best hive for a general one is the old American hive, cut down to 15 1/8 inches. This will give a hive 11 1/2 inches deep, 15 1/2 wide, and 13 long; a frame being 1 1/2 top-bar and 10-inch end-bar. Each brood-frame will contain 118.75 square inches, or whole hive 1,187.50 square inches, being 10 frames per hive. Such hives have wintered bees successfully for me, either on the summer stands or in-doors, or for cellar-wintering for the past five years. I have eight colonies outside, and the balance inside, but I can see no material difference in their present condition.

The summer of 1894 I had a colony which I concluded had every indication of foul brood, and to do a little on the experimental line, in January I withdrew all combs but four, which the bees completely covered. This hive was located on the north side of a building, partly sheltered by a Scotch pine. I raised the hive two inches from the bottom-board, and did likewise with the cover. We had very cold weather until spring, sometimes as low as 12 degrees below zero, and they were the ones that gave me the largest yield and did not swarm. They were the first to have brood. Yet the strangest of all was that I failed to discover any symptoms of foul brood the whole of the past summer. The question would naturally be asked, Did, or did not, the foul-brood germs freeze?
 The month of March has been one of the severest for many years. The ground

BUY "DIRECT FROM FACTORY," BEST MIXED PAINTS

At WHOLESALE PRICES, Delivered FREE For Houses, Barns, Roofs, all colors, and **SAVE** Dealers profits. In use 54 years. Endorsed by Grange & Farmers' Alliance. Low prices will surprise you. Write for Samples. O. W. INGERSOLL, 289 Plymouth St., Brooklyn, N. Y.

12A13 *Mention the American Bee Journal*

MURDERED

We have killed high prices. Give me a trial order and be convinced that good Queens can be reared for 50 cts. each. Untested, 50 cts.; Tested, 75 cts. Golden Italians, 3-Banded Italians, and Silver-Gray Carniolans, all the same price. Best of References given.

C. B. BANKSTON,

13A1f **CHRIESMAN, Burseson Co., TEX.**

Mention the American Bee Journal.

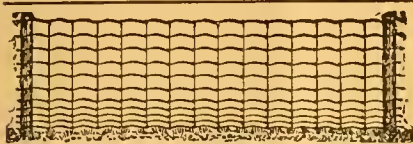

THE SURRENDER OF BUFFALO.

There are fifty eight head in Austin Corbin's great park in New Hampshire. The old bulls have always objected to separation, but as usual "the Page" won and now divides them into four herds. Result: Order for 4 1/2 miles, 9 ft. fence, close enough to hold foxes.

PAGE WOVEN WIRE FENCE CO., Adrian, Mich.

WHEN ANSWERING THIS ADVERTISEMENT, MENTION THIS JOURNAL.

We did not know that such **Good Goods** could be sold so low as the

HIGGINSVILLE SUPPLIES

just received. We did know that **Comb Foundation** could be sold cheaper, and consequently **started** the reductions, and have **just** made another. Have you seen it yet?

A 32-page Catalogue of everything you need, tells all about it.

W. J. FINCH, Jr., SPRINGFIELD ILLS.

Mention the American Bee Journal.

SUCCESSFUL INCUBATOR
Our magnificent new catalogue giving full information regarding artificial Hatching & Brooding and treatise on poultry raising sent for 4c stamps. Circular free.

Write now, Des Moines Incubator Co., Box 78 Des Moines, Ia

11A9t *Mention the American Bee Journal.*

California

If you care to know of its Fruits, Flowers Climate or Resources, send for a Sample Copy of California's Favorite Paper—

The Pacific Rural Press

The leading Horticultural and Agricultural paper of the Pacific Coast. Published weekly, handsomely illustrated, \$2.00 per annum. Sample Copy Free.

PACIFIC RURAL PRESS,

220 Market St., - SAN FRANCISCO, CAL.

Bees, Queens, Nuclei—We will sell, the coming season, 500 Two-Frame Nuclei, with a Choice Warranted Queen, at \$2.50 each. Special prices on large orders furnished. **LEININGER BROS,** 6Etf **FT. JENNINGS, OHIO.**

WHEN ANSWERING THIS ADVERTISEMENT, MENTION THIS JOURNAL.

covered with snow at this writing, with wind north. Bees are wintering in an excellent condition. We have had excellent rains, and an unusual amount of snow, which, after last summer's drouth, will no doubt give a nectar-flowing season. The farm gentry will hail a wet season with joy and delight.

I received 13 and 15 cents for my honey crop, which retails in Battle Creek (our metropolis of this county) for 18 cents per pound. Within a radius of three miles are six lakes, with Nottawa river but two miles away. Success to the American Bee Journal. Long may it live.

CARSON VAN BLARICUM.

Ellis, Mich., March 20.

Wintering Bees in Vermont.

Much has been said about wintering bees, and many methods given. My method is very much like many others. I winter them on the summer stands, in hives called the "Bristol." The hive itself is in a case, so the sun never strikes it. For wintering, I pack sawdust around the hive. I take off the top-board, and lay three or four sticks across the frames, put a cloth over them, and several thicknesses of sacking, then cover with sawdust six or seven inches. The bees can pass freely over the frames. I do not like to have the sun warm up the hives, for it often causes the bees to fly out when the atmosphere is too cold for them, and thus causes the loss of great numbers by being chilled down.

I frequently set wide boards in front of the hives in sunny days, to prevent the sun from warming them up to their destruction. When the general temperature is high enough, is soon enough for them to fly. It often happens that the sun warms them so as to start them out when there are cold currents that they will strike in flight, and which chills them many rods away.

E. L. HOLDEN.

North Clarendon, Vt., March 20.

Vaccination.

Discussions—moderate and immoderate—have been long, loud and continuous regarding vaccination, the opposition claiming that evil results from vaccination have far out-weighed its protective influence. And this has been true under certain conditions, as, for instance, when the virus (or crust) from some vaccinated person has been used, or a stale point of vaccine-lymph has been inoculated. But it may be accepted as good theory that, beyond question, nothing has yet been found to protect against the usual ravages of small-pox as fresh, pure vaccine-virus, obtained from the healthy heifers—the animal generally used for the propagation of the virus.

It is supposed by many that the matter taken from a baby's vaccinated arm is harmless, and the best, but this is a serious mistake, as its system may be as dangerously contaminated as that of the parents.

100 State St., Chicago. **DR. PETRO.**

Calls It a "One-Sided Betrothal."

At this late hour I will make an attempt to express myself in regard to the (what seems to me) one-sided betrothal, between the North American Bee-Keepers' Association and the National Bee-Keepers' Union.

It seems that the latter has had a most successful existence now for 11 years, and to-day, under excellent management, stands "cock o' the roost." And to think of it, according to the list before me (the Annual Report for 1895) the total membership is 242! And a total balance on hand of \$771.29.

The only complaint that I have to make is, that the compensation (so exceeding small, and out of proportion to the benefits derived) to our able Manager has not been greater. I suggest to the members (since reading the last Report) that all dues for 1896 be forwarded to our Manager, and pre-

POULTRY

40 Standard Breeds Illustrated & fully described in my new Poultry Book. Reliable information for poultrymen & intending buyers. Good stock Ducks & Geese; also Shetland Ponies. Send 6c in stamps

E. H. COOK, Box 27, Huntley, Ill.

Mention the American Bee Journal. 4A13t

IF YOU WANT THE BEE-BOOK

That covers the whole Apicultural Field more completely than any other published, send \$1.25 to Prof. A. J. Cook, Claremont, Calif., for hls

Bee-Keeper's Guide.

Liberal Discounts to the Trade.

NEW MAMMOTH POULTRY GUIDE

showing colored plate of chickens in natural colors. Finest book ever published. Almost 100 pages. Tells all about Poultry for Profit or Pleasure. Price only 15c.

JOHN BAUSCHER, JR., Box 94 Freeport, Ills.

12A7t *Mention the American Bee Journal.*

Kansas Bee - Keepers !

—SAVE FREIGHT—

A Car-load of "Higginsville Bee-Supplies" just received. GET MY CATALOGUE.

HENRY L. MILLER,

355 Shawnee Ave., **TOPEKA, KAN.**
1A1St *Mention the American Bee Journal.*

COMB FOUNDATION !

Wax always wanted for Cash or in Exchange for Fdn. or other Supplies. My trade is established on **Low Prices** and the **merit** of my **Foundation**. Orders filled promptly.

WORKING WAX INTO FDN. BY THE LB. A SPECIALTY. Wholesale prices to dealers and large consumers. Send for Prices and Samples to—**GUS DITTMER, AUGUSTA, WIS.** Reference—Augusta Bank. 1Atf

Mention the American Bee Journal.

DO YOU LOVE YOUR WIFE

Then save her strength, save her health, save her beauty and make her happy by buying her a **FAULTLESS QUAKER DISH WASHER.**

It is a marvel of simplicity and a wonder for utility. Washes, rinses, dries & polishes in two minutes. Lasts a lifetime. It sells quickly.

Everybody wants it when they once see it. Agents make money rapidly. Write today for terms etc.

The Quaker Novelty Co. Salem, Ohio.

13A4t Please mention the Bee Journal.

HONEY We have a large amount of Pure No. 1 Alfalfa we will sell cheap.

SEED Of those great honey-producing plants —Alfalfa and Cleome or Rocky Mountain Honey-Plant. Alfalfa seed at 7 cts. a lb.

Boss bee-escape Warranted the best, simplest and quickest Escape on the market. Sent postpaid to any address for 50 cts. It can be returned at our expense if it is not as represented, or we will send the Escape on trial to any bee-keeper wishing to test it in good faith. We are agents for the

Ferguson Patent Hive with double-case Super and Wicket-Gate Honey-board, with the Escape. It is the easiest, quickest hive to handle for the production of comb honey. Address,

E. S. LOVES, & CO.,

355 6th East St. **SALT LAKE CITY, UTAH.**
Mention the American Bee Journal. 9Atf

YOUNG QUEENS BY RETURN MAIL

From the South. Bred from our *hardy strain* of GRAY CARNIOLANS and GOLDEN ITALIANS. Untested Queen, 75 cts.; Tested, \$1.50. If you want a Fine Imported or a Select Tested Breeding-Queen, or BEES BY THE POUND, Nuclei and Full Colonies, we can furnish you at *bottom prices*. We never saw Foul Brood or Bee-Paralysis. *Satisfaction guaranteed.* PRICE-LIST FREE.

F. A. LOCKHART & CO., Lake George, N. Y.

Please mention the American Bee Journal.

16Etf

\$1

Buy a "ST. JOE" hive during April only, made up, Sections and Starters, no paint. *One only, to new customers, to show you the best hive made.*

Satisfaction guaranteed. Say how to ship,

and send on your

\$1

Golden Wyandotte Eggs for hatching, only \$1.00 for 13.

EMERSON T. ABBOTT, ST. JOSEPH, MO.

That Queen-Clipping Device Free!

PLEASE READ THE FOLLOWING OFFER:

We have arranged with the inventor of the new Queen-Clipping Device (Mr. Montette), to offer it to our present subscribers as a Premium for getting NEW subscribers.

Send us *just one new name* for the American Bee Journal a year (with \$1.00), and we will mail you the Queen-Clipping Device FREE of charge. Or, the Queen-Clipping Device will be sent postpaid for 50 cts. But why not get it as a Premium by the above offer? You can't earn 50 cts. any easier. Almost every bee-keeper will want this Device. See page 130 (Feb. 27) for full description of it. Complete directions accompany each one sent out. It is a most ingenious and useful article. Address,

GEORGE W. YORK & CO., 118 Michigan St., Chicago, Ill.

Fruit - Plants Free!

ALL CHOICE VARIETIES.

- No. 1—Eight Snyder Blackberry Plants \$1.00
- No. 2—50 Asparagus Roots..... 1.00
- No. 3—6 Fay Prolific Currants..... 1.00
- No. 4—3 Snyder Blackberry, 20 Asparag's Roots and 3 Fay Prolific Currants.... 1.00
- No. 5—3 Blackcap Gregg Raspberries, 3 Choice Red Raspberries, 12 To'a Beauty Strawberries and 2 Fay Pro. Cur.. 1.00
- No. 6—4 Snyder Blackberry, 4 Golden Queen Raspberry, 12 Asparagus R'ts and 10 Erie Blackb'ry Root Cuttings. 1.00
- No. 7—75 Blackberry Root Cuttings..... 1.00

Special Offer—Your choice of any ONE of the above 7 Numbers for sending us **one new subscriber** to the Bee Journal for a year at \$1.00, and 15 cts. to pay Postage on the Plants.

GEORGE W. YORK & CO.,
CHICAGO, ILLS.

BEES & QUEENS.

Strong, full Colonies of Italian-Hybrid Bees, in Langstroth 9-frame hives, at \$5.00 per colony; 5 to 10 colonies, \$4.75 each. Special low price on larger orders. Bees are in good condition, and are fine honey-gatherers

Italian Queens—after May 15—Tested, \$1 each; 6 for \$5.00; 12 for \$9.00.

Safe arrival and satisfaction guaranteed.

Reference—George W. York & Co. Address,

F. GRABBE,

LIBERTYVILLE, ILL.

32 ml. northwest of Chicago, on C. M. & St. P.

Mention the American Bee Journal.



Promptness Is What Counts!

Honey-Jars, Shipping-Cases, and everything that bee-keepers use. **Root's Goods at Root's Prices**, and the best shipping point in the country.

Dealer in Honey and Beeswax. Catalogue Free.

162 Mass. Ave.
INDIANAPOLIS, IND.

Mention the American Bee Journal.

The Patent Wood-Veneer Foundation.

Bee-keepers should give it a test, and my All-Wax Foundation. I will guarantee there is no better made, as six years ago I discarded the old way of dipping for wax sheets, and a new invention of my own was discovered, which enables me to make the toughest kind of Foundation; also, no acid used to purify the Beeswax, and it preserves the smell of honey, which is more acceptable to the bees. Now is the time to send wax and have it worked up at low prices. Send for Samples and Catalogue with low prices. Wax wanted at 31c cash, or 33c trade, delivered.

AUG. WEISS, Hortonville, Wis.
12A13t Please mention the Bee Journal.

For Sale

50 Colonies of Bees, in Langstroth 10-frame hives. Will deliver on cars here, at \$3.50 each.

J. W. HOWELL,

15A7t

KENTON, TENN.

Mention the American Bee Journal.

Honey-Clovers & Buckwheat

SEED FOR SALE.

We have made arrangements so that we can furnish seed of several of the Clovers and Japanese Buckwheat, by freight or express, at the following prices, cash with order:

	5lb	10lb	25lb	50lb
Alsike Clover	\$.70	\$1.25	\$3.00	\$ 5.75
Sweet Clover	.75	1.40	3.25	6.00
White Clover	1.25	2.00	4.50	8.00
Alfalfa Clover	.65	1.10	2.70	5.00
Crimson Clover	.55	.90	2.00	3.50
Jap. Buckwheat	.20	.35	.90	1.25

Prices subject to market changes.

Add 25 cents to your order, for cartage, if with freight.

Your orders are solicited.

GEORGE W. YORK & CO.,

CHICAGO, ILLS.

FIRST-CLASS BEE-SUPPLIES

at ROCK-BOTTOM PRICES. Send for Catalog to
W. J. STAHMANN,
14A4t WEAVER, MINN.

Mention the American Bee Journal.

sented to him as a slight token of our appreciation of his services.

He mentioned that hard times are on us. 'Tis true. We all expected to pay our dues (and I hold a receipt for mine for 1896), and while Mr. Newman has, in his generous way, not forgotten our welfare, in his unselfishness he is entirely left out. This suggestion is not offered through a feeling of personal friendship, for Mr. N. is a stranger to me, except what I have seen in print.

Now, I am not intending any discourtesy to any member of our sister association, in regard to amalgamation, and do not wish to stand on record as an obstructionist, yet I believe I know a good thing when I see it in the National Bee-Keepers' Union, and I am decidedly in favor of "letting well enough alone;" and if any one, or any number of bee-keepers, wish to avail themselves of the benefits to be derived from membership, let them walk up and pay their \$1.00 like the rest of us, and not tack onto members who do not wish it, the expense of expensive meetings.

The Union was organized for a purpose, and has most decidedly gained its object, and there is work for it in the future.

Los Angeles, Calif.

G. A. MILLARD.

That Foul Brood Report.

It is seldom that I read an article on the subject of foul brood. Of the thousands of reports and remedies for said reported disease, I think I have not read a half dozen during the last ten years, having usually passed by such articles as unworthy of notice. But in accidentally reading what was said about this dispute between McEvoy and Rev. Clarke at the Ontario convention, that wonderful infection as reported arrested my attention. Is it possible that more than one-third of the apiaries of Canada are thus rotten and foul? Now if one-tenth of this be true, ought not Canadian bee-keepers begin to search for some underlying cause of all this infection? Is it not possible—yea, probable—that an inspector himself may spread the disease and carry the contagion on his person, from diseased apiaries to those that are healthy? This is one of the reasons I have opposed the introduction of Bills into the legislatures, providing for "foul brood inspectors."

I predict that "foul brood" will go on increasing in Ontario under the present method of eradication. Will the bee-keepers up there be patient enough to await the fulfillment of my prophecy?

Updegraff, Iowa.

W. P. FAYLOR.

The Season of 1895.

A year ago last fall I had 8 colonies, not very strong in bees, nor abundant in stores. In February there were a few nice days, and I examined them and thought they had not enough to last through the spring, so I fed each of them about 2½ pounds of granulated sugar syrup. Through March I gave them about ¼ pound per day each. On April 5 I procured from New Orleans 16 frames of brood and bees (supposed to contain 60,000 to 80,000 bees), and these I divided amongst the 8 colonies.

On May 1 the hives were full, and I estimated that I had at that time about 500,000 bees. Now, as a bee will store about one tea-spoonful of honey in a season, and as two spoonfuls make an ounce, according to the figures and measures (and they won't lie), I calculated that I would have 256,000 ounces, or 15,000 pounds of honey. But to make a sure estimate, and to allow for all contingencies, I threw off 14,000 pounds, and concluded that I would be satisfied if I got 1,000 pounds of clear, pure honey.

I will give some of the circumstances and surroundings, and the reader can judge if I was foolish in my expectations.

The spring was very favorable, and my bees had a large bed of crocus, hyacinths, and a great many willow trees to go to work on very early. They were near a 75-acre woods filled with maple, chestnut, sassafras, dogwood and wild flowers, and several orchards of fruit-trees on a 108-acre

farm, all of which, except the woods, is laid out in lawns, pastures and gardens. The lawns are filled with white, and the pastures with red clover, the fences are covered with honey-suckles. Some fields are surrounded with an old hedge (miles of it) grown up with raspberries, blackberries, sassafras trees, poison-ivy vines, catnip and thistle full of bloom. Within a mile of the bees are any amount of wild-cherry trees, thousands of locusts, and good basswood and flowering poplars; also lots of sumac, golden-rod, milkweed, wild asters, smartweed and Spanish-needle; a field of scarlet clover, and two fields of Alsike clover. All this is situated in the middle of a neck of land between the two Shrewsbury rivers in Monmouth county, N. J. This whole neck of land is covered with fine summer residences, and most of the ground given to pasture, orchards, lawns, shrubbery, gardens, and flowering plants. To all this, for two or three miles in either direction, my bees have free access, without any other bees to hinder, molest or make afraid—except one small apiary of about 25 or 30 colonies, which is one mile away. The only thing I can think of that my bees have not, is sweet clover and buckwheat.

I had thought there were tons and tons of honey or sweet nectar going to waste in this locality for the want of bees to gather it.

I bought a new honey-extractor, and the last of June I thought I would take a little honey, so that we could have some for the Fourth of July. I took about 100 pounds each of comb and extracted honey, and thought the bees would soon fill up the section-cases again. But, alas! for my 1,000 pounds—I was unable to take any more honey. I examined them time after time for more, but each time they appeared to have less than they had in June, until I was finally afraid I would have to feed to keep them alive.

Towards fall they picked up a little, and on Oct. 1 I thought they had about 10 pounds each. I fed them about 15 pounds each, of sugar syrup.

I lost no colony of bees during the year, but increased to 12; I think I could have increased to 40, but I did not desire increase. I doubled up 4 colonies, which left 10 to winter. I put on the cushions and protected them for the winter. I keep Italian bees in 8-frame Langstroth chaff hives, and winter them on the summer stands. As I live about 40 miles from my apiary, I think I shall not disturb them until about May 1.

I. N. HOAGLAND.

Brooklyn, N. Y.

An Open Letter to Dr. Miller.

DEAR DR. MILLER:—I have just been reading page 211 of the American Bee Journal (which has just come to hand), and your talk to J. H. Martin is somewhat of a surprise to me. Therefore, "I smole a quiet smile, and said to myself, "Wonder what the Doctor is up to, anyhow." Then I thought the good Doctor is always communicative, why not ask him? So, Doctor, here are a few questions I would like to have you answer, that "we" readers of the American Bee Journal may be able to understand you (and ourselves) better. Please do not say "I don't know" to these questions, lest we lose our confidence in your ability:

Why do you object to California honey coming to the Chicago market? I never heard you make such objections years ago when we were getting from 25 to 30 cents a pound for our honey. Is it because you think California honey has been the means of bringing the price of that we produce from 25 cents a pound down to 10? Or is it because you think *your* honey and that produced in the State of Illinois is of better quality, and gives the Chicagoans better health? Hey, Doctor? If neither of these, is it because you think that there is honey enough produced in the United States, outside of California, to supply *every mouth* which "waters" for honey in the Nation? If so, should those California bee-keepers go out of the honey-producing business, that

you and I can have a monopoly of the honey-trade? Then, Doctor, have not you and I been trying all these years to educate those California bee-keepers how to produce honey, through our articles, and by answering their questions? If so, what do you think Christ would say of us if we are not just as willing they should enjoy our markets as we have been that the world should enjoy and be helped by the mite we could contribute toward advanced bee-culture?

Say, Doctor, what is the reason there are so many mouths watering for honey to-day, and unable to get it, while you and I growl at the low prices we receive for our product? scarcely one-third the price we formerly obtained!

Then, again, why is it that with these one-third prices, and nearly double the population in the United States there was when honey brought 30 cents per pound, hardly as much honey is consumed to-day as there was in the early seventies?

Why are you growling over low prices of honey when a pound of your honey will buy as much wheat, buckwheat, potatoes or land as it ever would?

I have many more questions I would like to ask you along these lines, but fearing I may weary you, and knowing what a host of questions means to an over-worked bee-keeper, I will leave the rest till some other time. I am not trying to "catch" you with these questions. The proper answer to them is of VITAL importance to every apiarist in the land.

G. M. DOOLITTLE.

Borodino, N. Y.

Bees Storing Surplus Honey.

My bees are doing well, having commenced storing surplus. If the weather is good, I look for them to swarm about April 10.

M. P. SMITH.

Tobin, Calif., March 20.

Dr. Gallup a Bee-Keeper Again.

I have picked up and divided, so I now have 5 colonies of bees. I received a queen as a present March 29, from W. P. Crossman, of Texas, and who knows but Gallup will yet become a bee-keeper?

There is every prospect of a good season here. Bees began swarming March 15, and all reports are that bees are in excellent condition.

DR. E. GALLUP.

Santa Ana, Calif., March 31.

A Correction.

The latter part of the last paragraph of my contribution, on page 210, should read thus:

"Does not that show that the withdrawal of brood has increased the amount of larval food needed and decreased the supply, and therefore there is *no more surplus* to put in the construction of queen-cells."

It is needless to say that I do not mean that the larval food is used in the construction of queen-cell as material, but that the young bees construct queen-cells when they have a surplus of larval cells to dispose of.

Knoxville, Tenn.

ADRIAN GETAZ.

Birdlime for Mr. Pringle's Rats.

On page 202, Mr. Pringle asks for information to get rid of his rats.

If they are of the rodent species, let him first cover the ground with leaves or soft grass—the grass is the best; then sprinkle birdlime all over it, and wait results.

Birdlime acts as a glue; it will stick to their feet, and as they try to get it off, more gets on; and as the rat gets scared, it will either leave altogether, or will be unable to leave the floor, and can be killed.

I will guarantee this to work. If not, I will eat all that is left, providing he sends them to me, charges paid; and I am no Chinaman.

E. C. CULBERT.

Tarentum, Pa.

Honey & Beeswax Market Quotations.

CHICAGO, ILL., Apr. 11.—We quote: Fancy white comb, 15c.; ordinary white, 12@13c.; fancy amber, 10@11c.; amber and dark, 7@9c. Extracted, white, 5@7c.; amber and dark, 4@5c. Beeswax, yellow, 30c.

The season for sale of comb honey is now at a close, and only a case or so will be taken for colds, and by enthusiasts on honey as a food (of whom there are too few). R. A. B. & Co.

CINCINNATI, O., Apr. 8.—Demand is good for choice white comb honey, at 12@14c., and slow for extracted, at 4@7c. on arrival.

Beeswax is in good demand at 25@30c. for good to choice yellow. C. F. M. & S.

KANSAS CITY, Mo., Apr. 9.—The demand for comb and extracted is fair. We quote: No. 1 white, 1-lbs., 13@14c.; No. 2, 11@12c.; No. 1 amber, 10@12c.; No. 2, 8@10c. Extracted, white, 6@6½c.; amber, 5@5½c. Beeswax, 22@25c. C. C. C. & Co.

PHILADELPHIA, PA., April 4.—The demand is falling off very rapidly for comb honey, and prices are decidedly lower. Extracted seems to be shipped in from all quarters. We quote: Fancy comb, 11c.; fair to good, 7½@9c. Extracted, 4@5c. Beeswax, 30c. W. A. S.

NEW YORK, N. Y., Mar. 23.—There is a fair demand for white comb honey, and the market is well cleaned up. We have another car now in transit from California. We quote same: 12@14c. Plenty of buckwheat comb is on the market, and same is moving off slowly at 8c. Extracted, all grades, dull, at unchanged prices.

Beeswax firm at 30@31c.

H. B. & S.

List of Honey and Beeswax Dealers.

Most of whom Quote in this Journal.

Chicago, Ills.

R. A. BURNETT & Co., 163 South Water Street.

New York, N. Y.

HILDRETH BROS. & SEELKEN,
120 & 122 West Broadway.
CHAS. ISRAEL & BROS., 486 Canal St.

Kansas City, Mo.

C. C. CLEMOMS & Co., 423 Walnut St.

Buffalo, N. Y.

BATTERSON & Co., 167 & 169 Scott St.

Hamilton, Ills.

CHAS. DADANT & SON.

Philadelphia, Pa.

WM. A. SELSER, 10 Vine St.

Cincinnati, Ohio.

C. F. MUTH & SON, cor. Freeman & Central avs.

Excites Admiration.

RUTLAND CO., Vt., Feb. 6th, 1896.
MR. O. W. INGERSOLL—Dear Sir: I painted my house with your Indestructible Paint, and it excites the admiration of all who see it. Your paint is all that is claimed for it.

Yours very truly, A. S. BAKER.

See adv. Ingersoll's Liquid Rubber Paints.

Convention Notices.

ILLINOIS.—The spring meeting of the Northern Illinois Bee-Keepers' Association will be held at the home of Mr. O. J. Cummings, in Gullford, on May 19, 1896. Come, and bring your wives and friends interested in bees.
New Milford, Ills. B. KENNEDY, Sec.

CONNECTICUT.—The annual meeting of the Connecticut Bee-Keepers' Association will be held at the Capitol in Hartford, Wednesday, April 23, beginning at 10:30 a.m. Free to all.
Waterbury, Conn. MRS. W. E. RILEY, Sec.

Cheap for Cash—ITALIAN BEES

In 10-frame [size 9½x17½] hive, \$4. Italian Queens, \$1.50. Address,

OTTO KLEINOW,
122 Military Avenue, DETROIT, MICH.
12E3t Please mention the Bee Journal.

Bottom Prices

**BRING US BIG TRADE.
GOOD GOODS KEEP IT.**

If you want the best supplies that can be made at a little less cost than you can buy the same goods for elsewhere, write to us for low prices. 1896 Catalogue now ready—ask for it and a free copy of **The American Bee-Keeper** (36 pages).

Address,
**THE W. T. FALCONER MFG. CO.,
JAMESTOWN, N. Y.**
Mention the American Bee Journal.



INCUBATORS
Our 160 page, finely illustrated Combined Poultry Guide and Catalogue will tell you what you wish to know about **PROFITS IN POULTRY**
We manufacture a complete line of Incubators, Brooders and Poultry Appliances. Guide and Catalogue 10c. (stamps or silver) **Worth one Dollar.** Reliable Incubator & Brooder Co., Quincy, Ills.
38E15t Please mention this Journal.

ROOTS GOODS Prices Reduced on Dove-tail Hives and Sections. A full line of Apian Supplies in stock to all orders promptly at lowest prices for Best Goods. 36-page Catalogue Free.
JNO. NEBEL & SON, High Hill, Mo.
Mention the American Bee Journal. 4A26t

I ARISE



TO SAY to the readers of the **BEE JOURNAL** that **DOOLITTLE**

has concluded to sell—**BEE** and **QUEENS**—in their season, during 1896, at the following prices:
One Colony of Italians on 9 Gallap frames, in light shipping-box \$6.00
Five Colonies.... 25.00
Ten Colonies..... 45.00
1 untested queen. 1.00
6 " " queens 3.50
12 " " " 10.00
1 tested Queen... \$1.50
3 " " Queens. 3.50
1 select tested queen 2.00
3 " " Queens 4.00

Select tested queen, previous season's rearing, 4.00
Extra Selected for breeding, **THE VERY BEST.** 5.00
About a Pound of **BEE** in a Two-frame Nucleus, with any Queen, \$2.00 extra.

✓ Circular free, giving full particulars regarding the Bees and each class of Queens.
Address

G. M. DOOLITTLE,
12A25t **BORODINO, Onon. Co., N. Y.**

BEE **QUEENS**
Smokers, Sections, Comb Foundation, and all Apian Supplies cheap. Send for FREE catalogue. **E. T. FLANAGAN, Belleville, Ill.**
6A26t Please mention the Bee Journal.

CARLOADS



Of Bee-Hives, Sections, Shipping-Cases, Comb Foundation, and **Everything** used in the Bee-Industry.

I want the name and address of every Bee-Keeper in **America**. No reason why you cannot do business with me. I have

Cheap Lumber and Experienced Workmen; a good Water-Power Factory and know how to run it. I am supplying Dealers as well as consumers. Why not you? Send for Catalogues, Quotations, etc. **W. H. PUTNAM,**
1E **RIVER FALLS, Pierce Co., Wis.**

26c Cash Paid for Beeswax!

For all the **good, pure yellow BEESWAX** delivered to our office till further notice, we will pay 26 cents per pound, cash; or 28 cents for whatever part is exchanged for the American Bee Journal, Books or Seed, that we offer. If you want **cash promptly** for wax, send it on at once. Dark or impure wax not taken at any price. Address plainly,

George W. York & Co., 118 Michigan St., Chicago, Ill.

SECTIONS CHEAP! * * * *

In order to reduce stock we will sell
40,000 4 1/4 x 4 1/4 x 2 40,000 4 1/4 x 4 1/4 x 1 15/16 250,000 4 1/4 x 4 1/4 x 1 3/4
150,000 4 1/4 x 4 1/4 x 1 1/4 80,000 4 1/4 x 4 1/4 x 7-to-ft,
Of our No. 2. One-Piece, Open-Top Sections, at the following **Low Prices:**
1,000 for \$1.00; 3,000 for \$2.50; 5,000 for \$3.75.

These Sections are all of good quality and manufacture, and prices will be maintained for a short time only.

G. B. LEWIS CO., WATERTOWN, WIS.

✓ Be sure to mention the American Bee Journal when you write. ✓

19th Year Dadant's Foundation 19th Year

Is still in the lead, for we use all the latest improvements, including the

NEW WEED PROCESS, NEW

and still make the best goods. Remember that we do not use any acid to purify our beeswax, and that is why our Foundation preserves the smell of the honey and is more acceptable to the bees, than any other. It is kept for sale by

T. H. Strickler, Solomon City, Kansas.
G. K. Hubbard, Fort Wayne, Ind.
L. Hanssen, Davenport, Iowa.
C. Theilmann, Theilmantown, Minn.
E. C. Eaglesfield, Berlin, Wis.
E. T. Abbott, St. Joseph, Mo.
J. M. Jenkins, Wetumpka, Alabama
John Rey, East Saginaw, Mich.
Vickery Bros., Evansville, Ind.

The Jennie Atchley Company, Beville, Texas.
C. F. Muth & Son, Cincinnati, Ohio.
E. Kretschmer, Red Oak, Iowa.
Jos. Nysewander, Des Moines, Iowa.
G. B. Lewis Co., Watertown, Wis.
James Reynolds Elevator Co., Poughkeepsie, N. Y.
Louisiana Bee-Keepers' Supply Manufactory, Donaldsonville, La.
Page & Lyon, New London, Wis.

and many other Dealers. All agree in saying that no goods are better than ours.

Those of our customers who formerly bought through Thos. G. Newman can get our Foundation in **Chicago, Ill.**, by addressing us at **118 Michigan Street**. We keep no other goods there.

We make a specialty of **Veils and Veil Stuffs** of best quality, cotton and silk.

"LANGSTROTH ON THE HONEY-BEE"—Revised.

Bee-Keepers' Supplies, Smokers, Sections, Tin Pails, etc.
Samples of Foundation and Tulle FREE with Circular. Instructions to beginners with Circular. Send us your address.

CHAS. DADANT & SON,

Mention the American Bee Journal.

HAMILTON, Hancock Co., ILL.

MY BED OF STRAWBERRY PLANTS

For Spring was never better—all young Plants. Also have a **Big Stock** of Apple, Peach, Plum, Pear and other **FRUIT TREES**. Catalogue **FREE**. Write for it.
PLEASANT VALLEY NURSERIES, Arthur J. Collins, Moorestown, N. J.

BEAUTIFUL
Transparent
TOUGH

and yet
PLIABLE.

REDUCED
PRICES

NEW - PROCESS WEED FOUNDATION

—DELIGHTS ALL—

RECENT COMPARATIVE TESTS IN FLORIDA
show that the old-process dipped wax will sag or stretch in the hive nearly five times as much as that by the new Weed process.

Our New Sanded and Polished Sections
and Bee-Hive Material are the **Finest Product**
that money and machinery can turn out. **CATALOG FREE.**

THE A. I. ROOT CO., MEDINA, OHIO.

118 Michigan St., Chicago, Ill.

Syracuse, N. Y.

1024 Mississippi St., St. Paul, Minn.

AMERICAN BEE JOURNAL

DEVOTED EXCLUSIVELY TO THE INTERESTS OF HONEY-PRODUCERS

ESTABLISHED 1861
THE OLDEST BEE-PAPER IN AMERICA

Published Weekly, at \$1.00 per annum.

Sample Copy sent on Application.

36th Year.

CHICAGO, ILL., APRIL 23, 1896.

No. 17.



Continuing to Work Toward Comb Honey.

BY G. M. DOOLITTLE.

As a rule, I do not think it best to call attention to slight mistakes in any article of mine, after they get in print, whether the mistake was made by the "typo" or myself, but the one in my article, on page 193, is of such a character that it should be rectified. The sentence at the bottom of the first column reads: "The next pleasant day more are put out in the same way, and at about the same time, scattering them about as before, but paying no attention as to how near they come to those put out at the same time." The "at the same time" should have been *before*, as bees set out at the same time will mix up on their first flight after being set from the cellar, if set near each other, but if one of these colonies has been out of the cellar 24 hours or more, the bees will not mix, no matter how closely to the first set out, the second one may be placed.

With this explanation we will continue the theme of working for comb honey, beginning where we left off on page 194. After having reversed the brood-nest, as there given, we wait for about 10 days, when we take a frame of honey from the colony, if the hive contains such, or from the shop, if we have such there and not in the hive; or if we have no frames of honey anywhere about the premises, we fill combs with sugar syrup, which will answer the same purpose. We now open the hive and separate the brood-nest in the middle, when we insert this comb of honey or sugar syrup in the center of the brood-nest, after which the combs are brought up to comb-space apart all through the hive, and the hive closed. If it should be a comb of sealed honey used for this purpose, the sealing to the cells should be broken by passing a knife flatwise over the cells, bearing on sufficiently to break the cappings to the cells. Most writers tell us to use a feeder when feeding bees in the spring, but after trying all plans of feeding to stimulate brood-rearing, I have never found anything which will begin to equal this plan here given, all things taken into consideration.

By the removing of this honey and the queen immediately filling the comb with eggs as soon as the honey is removed, brood-rearing is accelerated to an extent greater than in any other way I know of, while the excitement caused by the same, causes the bees to keep up the proper temperature in the brood-nest, even should a few days of cool weather occur at this time, which is not very liable this late in the season.

The great objection to the spreading of the brood, usually placed before the bee-fraternity, is that there is danger of a cold snap occurring just after such a manipulation, which often causes the death of much brood, this being against an increase of bees in time for the honey harvest, rather than favorable to the same. No one should advise the promiscuous spreading of the brood, or an ignorant attempt of the same

by any novice, but by a careful, intelligent use of the plan as here given, the prospects of a good yield of comb honey is greatly increased, where the honey-flow we are striving to reach with our laborers commences on or before July 1st to 10th. If the honey-flow occurs later than this, most colonies, as a rule, will get strong enough in numbers to do good work in the same, if they are "left to their own sweet will."

In about 10 days more, the brood-nest is to be reversed again, when, if all has worked well, there will be brood in all but the two extreme outside combs at each side of the hive, and generally some in these; but if not, there soon will be, owing to the full sheets of brood coming next to them. This plan of spreading of the brood has often been called "fussy," and too much work is attributed to it, but from 25 years' experience with what is outlined above, I am prepared to say that no work with the bees pays as well in comb honey as a judicious use of this plan. It will be noted that no hive need be opened more than three times previous to the honey harvest, while the doing of this practically insures to us the laborers for the harvest, *just* in time for the harvest; and the having of the laborers just in time for the harvest is the one great secret of successful comb-honey production. Failing in this point—of securing the laborers in time for the harvest—the flowers will bloom in vain for us, and empty sections be the greeting we shall have after the harvest (we might have had) is over.

In all of the operations with bees in the spring of the year or early part of the summer, the top of the hive should be closed as tightly as possible, the quilt, if you use one, be tucked down as neatly as possible, so that the warm air generated by the bees shall be continually escaping from the hive through the cracks left open, for *warmth* in the hive and cluster is another of the great essentials toward securing the laborers in time for the honey harvest, for brood-rearing cannot go on to its greatest degree unless the temperature inside the cluster can be steadily maintained at from 92° to 98° above zero, as I have proven by several tests with a self-registering thermometer.

Then, each hive should be provided with a wide alighting-board, reaching from the hive-entrance to the ground, so that bees coming home heavily loaded with pollen and partially chilled on cool, windy days, when the sun is partially shaded by clouds, may not fall under the hive by missing the entrance to the hive, and die from cold when being so near home. I have seen hundreds of dead bees under hives set on stakes a little up from the ground with no suitable alighting-board, each bee having its pollen-baskets filled with pollen. Each old bee is worth, at this season of the year, 500 after the honey harvest is over, hence we should look well to all of the little things which, at this time of the year, tend toward our success in the immediate future. Borodino, N. Y.



Apiaries in Sunny, Sheltered Places.

BY GEO. J. VANDEVORD.

I read Mr. Davenport's article, on "Locating Apiaries in Sheltered Places" (page 82), with much interest, and after reading that he would like to have others give their experience along this line, I thought perhaps my own experience might be of some little interest and value to others, though it does not coincide with very much that I have read, but unless I am mistaken in the conditions prevailing in Mr. Davenport's

apiary, his experience, so far as he states it, tallies exactly with mine.

From the results described by Mr. D., I should judge that his hives were all single-walled, and also without packing at the top, for my experience has been that a sunny, sheltered place is a very poor place to attempt to "spring" bees that are housed in single-walled hives, but on the contrary, it is the place, par excellence, to locate an apiary where chaff hives or packing are used; as (in my opinion) they ought to be used in all northern localities, and in some that do not claim to be very northern, too, and even though the bees are wintered in the cellar. Such hives, in such a location, very soon make up the cost of the packing, if the honey-flow amounts to anything before basswood, though where the main flow is from basswood and fall flowers, and no increase is desired, much of the importance of a "sunny location" vanishes.

I have an apiary located on a rather steep bank of a ravine, facing the south and southwest, extra-well protected from winds from almost any direction, where a few hours' sunshine on fine days in the winter cleans away the snow in quick order, and leaves a dry footing for the bees to alight on, should they fly during the winter (I winter bees outside); and I find after trying no packing at all, packing lightly, and packing extra heavily, that the bees that are best protected from the heat of the sun's rays beating directly on their hives, winter the best, spring the best, and consume the least stores in reaching their maximum strength in the spring; and more than that, they are far in advance of the average strength of colonies in the same neighborhood that have not the combination of a sunny location and packing.

Some of my bee-keeping friends around there believe in sunshine and shelter from winds; some believe in packing, and some in neither, and I think there is pretty good ground for this apparent difference of opinion found in their different systems of management.

Is not this "sunshine and shelter theory" a tradition handed down to us from the days of box-hives, when the combs ran "criss-cross" in the hives, and gave the bees a protection from sudden changes of temperature, that the orderly method of modern movable frames does not allow? and do not many of us accept this old maxim without any modification to suit our changed conditions? Occasionally some of the observant ones have "kinder wondered" why the bees have spring-dwindled so badly in some "beautiful location," while they came through a perhaps cold and backward spring without very much loss, in another apiary near by that was considerably exposed to all kinds of weather.

I noticed that my bees seemed to have a pretty tough time of it in getting through the spring in decent condition, when I first began bee-keeping there, as I used to clear away the packing pretty early in the season "to let the sun get at them and warm them up;" but after keeping bees for a year or two, and learning more of their habits, and the detriment it was to them to be continually disturbing them, or causing them to take useless flights, it struck me that that was the very thing the sun was doing nearly every day, for a month before there was much pollen or honey to be secured; and that it was rather unreasonable to clear away the packing before there was plenty of both pollen and honey coming in, and since then I have found minor reasons why it is advisable to keep bees packed nearly if not the whole year through, the two chief of which are, the steady and more certain increase of brood (no check ever occurring from a rapid lowering of the temperature outside), and the better and cheaper work done in comb-building and capping honey right out to the corners of frames and sections.

On the other hand, if I had decided, from any reasons, that it suited my purpose to run a certain apiary in single-walled hives, I would choose a place where the wind got all around the hives; and I would put them where the sun had to raise the temperature for miles around at the same time that it warmed the hives, for then there would have to be a pretty general rise in the temperature before the bees inside the hives felt the influence of the sun to any very great extent, and thus no harm would be done like there would if these same single-walled hives were put in a place that, because of its shelter, allowed the sun to raise the temperature very rapidly on every fine day, and did not allow the wind to circulate freely over and around the sun-heated surfaces of the hives.

These frequent warmings up, and the general jubilee that always accompanies them, are a very positive detriment to the bees, causing loss of vitality, and an unnecessary consumption of stores, without any corresponding gain; so that when the hard labor of pollen and honey gathering in the spring really commences, the remaining bees are practically old and feeble,

and rapidly "dwindle" away; whereas, had they been located in a sunny, sheltered place, and protected by packing from these short periods of warm sunshine, so that when they were induced to fly the average temperature *outside* their sunny location would not be too low for them to withstand, and *inside* their shelter it is so much warmer that once the bees are aroused, the air they will at once begin to fan out of their hives is replaced by air fully as warm, which materially assists them in maintaining and increasing the heat of the contents of the hive; and where these congenial surroundings exist, bees from these hives will be found to have enough vitality and bee-sense to "make for" their sunny home at any lowering of the temperature outside the shelter. They will not as quickly commence to rear brood, but they will *hold* every cell that they do start, and will have their 8 frames chock-full of brood from a few days to a few weeks earlier than those in single-walled hives in any location, sheltered or otherwise; and if they started the season with the same amount of stores as those in single-walled hives, they will have consumed less at the commencement of the honey harvest, though they will have a larger force of more *vigorous* bees. More vigorous, because at no time in their development have they been subjected to any serious "cooling off," or any stint in food-supply because any of them happened to be left outside the cluster on a cold night.

This so far is not theory, but my experience in the apiary, and from this it will be seen why I think we cannot afford to do without packing, and how I think we can get the benefit of the great advantage that a sunny, sheltered location may be to any apiary.

Rudyard, Mich.



Cellar-Wintering—The Apiarian Outlook.

BY MRS. L. C. AXTELL.

We put out our 83 colonies of bees (that we had in the cellar) half of them March 10, and the rest on the 26th. All were alive but one, and it seemed to have had laying-workers, from the appearance of the brood. They fly as if they were very strong and in good condition. The 40 wintered out-of-doors also fly as if in good condition. Probably when we examine them all through, we will find some that are weak, as is always the case, but now as they fly on warm days they will fill the air like they do in swarming-time.

We took up less dead bees from the cellar than usual. We try to sweep all dead bees up that fall on the bottom of the cellar, about once in two or three weeks—not longer—as we think it must be very unhealthy for us to breathe the cellar-air tainted with dead bees. I do not think all people who winter bees in the cellar are as careful as they ought to be, to remove the dead bees often. Although in the cellar, yet the cellar-air permeates the living-rooms above more than we think.

One winter we left our bees for one month shut up in the cellar while we were away on a visit. The living-rooms were not opened much while we were gone, yet we had a neighbor throw open the cellar-doors on all warm nights while we were gone. When we came home, the rooms above the cellar were very damp, the windows were frosty, clothing in a closet in the center of the house over the cellar was not fit to wear until dried, and yet the cellar was plastered overhead. We had then about 125 colonies in the cellar.

Some years ago I remember calling on a bee-keeper one spring, in April, I think. They had not yet taken their bees from the cellar. As soon as I went into the house the bad cellar-smell met me. I noticed it immediately. It struck me that it smelled like a corpse. The man and his wife were in poor health. I do not remember how about the health of the children, but the wife died in a year or so.

I do feel we ought to be careful to remove all dead bees from the cellar quite often, and then there will remain many under the hives and in places we cannot reach, so we ought to air the rooms above every day as much as possible, and some rooms ought to have a window raised night and day.

What is true of dead bees is true of all impurities in cellar or house. Decaying vegetables, dusty carpets, moldy wall-paper, etc., will tell upon the health of the family.

THE OUTLOOK FOR BEE-KEEPING.

It has been the editors of bee-papers that have kept bee-keeping from shipwreck, by gathering up everything possible pertaining to the best interest of bee-keeping, and putting it in a shape so we can learn how to make the most of our bees with the least possible labor, and, indeed, that is the secret of success *everywhere*—to get the most we can out of our labor.

I think no one should embark in bee-keeping expecting to

make a living solely from that pursuit. In years past it has paid, but seasons have changed, the ground is much drier than in former years—we know this by all farmers having to dig their wells deeper; the almost entire tile-draining of every low and swampy piece of land, and putting in some kinds of grain that bear no honey-producing flowers, and destroying the wild flowers that produced honey. (I speak of the condition of things in this neighborhood and surrounding country.)

But this condition of dry weather cannot go on much longer, or all crops, too, will be cut short. I believe as soon as we have plenty of rain, as in former years, until the ground is thoroughly soaked, we will have honey-producing flowers and good honey-flows. What we need is courage to hold on to our bees, and not let them run out or dwindle down to poor colonies, as it is less expense to take care of good colonies than it is to care for poor ones; and then if there is any honey, the good colonies will be sure to hunt it up. We need to learn how to keep bees in good condition at all times. It is not safe to weaken one colony to build up others, or to let bees swarm more than once; often, then, it is the most profitable to put the swarm back, and only take away one or two combs of brood, so as not to greatly weaken the colony, using the brood to build up other colonies that may not be in the best of condition. If we let our colonies become weakened, they so often do not become strong enough to fill their hives for winter; in that case the colony itself is too weak to winter well, and we have to resort to fall feeding, which all bee-keepers ought to dread, as it takes the poetry out of bee-keeping, and the money out of the purse, especially if we didn't have a honey-flow in the forefront of the season.

Roseville, Ill., March 23.



Some Subjects Reviewed and Commented Upon

BY DR. C. C. MILLER.

GOING INTO HIVES.—I confess to some degree of surprise on finding, by reading page 212, that Mr. Hutchinson describes exactly the kind and amount of hauling that my bees get in the spring—seeing that they have a good queen and plenty of stores, and taking brood from weaklings to strengthen others. The only modification—and perhaps he does the same thing—is that the brood taken from the weaklings is given to those that are fairly strong but not quite up to the mark, and that I see that every queen is clipped. Now if I am not mistaken he has very lately written something to the effect that it is not necessary to take the honey-boards off hives more than once in three years. Mr. Hutchinson, will you please arise and explain?

AMALGAMATION.—I'm not so set on amalgamation that all the light will go out of my life if it is not accomplished. And if a majority of the members of the Bee-Keepers' Union vote against it I shall be quite satisfied. As a member of the Union from the first, and as one of its officers, I am anxious for its continued success, and on that account in favor of amalgamation.

On page 221, Wm. L. Backensto thinks the combination of business with pleasure will not be the same here as in Germany, because government controls things there and anything against the interest of bee-keepers is promptly brought to punishment, "while over here hell-hounds can do these things [or attempt to, at least] and escape punishment." My reading has not brought me to any such view. Very much complaint is made in the German bee-journals as to adulteration of honey, and adulteration of beeswax is probably carried there to an extent that has never been dreamed of in this country. Adulterated foundation is so common that the advice is given for each one to own his own press so as to be safe from adulteration, and more than 7,000 Rietsche presses are in use. Who is troubled with adulterated foundation in this country? If there has been any punishment for it in Germany it has escaped my attention. Only lately, adulterated beeswax, under the name of "trade-wax," is boldly advertised in Germany. If these things are to be taken as deciding the matter, I see no good reason why we cannot combine business with pleasure here as well as in Germany.

I think some of those who are so afraid of the corrupt influence of the North American know very little about what its meetings are for. They have never perhaps been present at such a meeting, and have an impression apparently that the chief, if not the only object, is pleasure. I very much doubt whether any one ever attended with pleasure as the chief object. The thing that brings bee-keepers together at these meetings is profit. You couldn't get a corporal's guard together if they didn't think they would learn something.

Mr. Backensto wants to know what benefit those outside the United States would have from membership in the Union. Just the same as those inside. Mr. Backensto seems not to know that the Union is no more limited in its membership than the North American, and if he will just take the trouble to look at its list of members he will see that it takes in Canadians as well as members in the States.

Like some others, Mr. Backensto persists in looking at things the wrong way, and in thinking that the only effort made is to increase the membership of the North American. On the other hand, will it not increase the membership of the Union if for the same dollar the additional advantage of membership in the North American, whether that be little or much, can be also had?

Mr. Backensto thinks that if nothing is hitched on to the Union, "it is bound to continue a grand success." Has Mr. Backensto not noticed that the Union is decreasing in numbers? It is with the hope that additional members will be gained, and thus make the Union larger, that I advocate amalgamation. Now what harm, Mr. Backensto, will the "hitching on" do? Suppose a man is ready to pay his dollar to join the Union, and you say to him, "We can now do a little better by you than heretofore, and when you've paid your dollar you will also be a member of the North American." Please give us the name of the man who will say in reply to that, "I want to join the Union, but if that also makes me a member of the North American I won't join the Union."

SWEET CLOVER HAY.—In "Personal Mention," page 223, it is said Wm. Stolley has 200 tons of sweet clover hay. I saw the statement from which I suppose that is taken, and if you will look closely, Mr. Editor, I think you will find that he has 200 tons of hay, leaving it uncertain what proportion of it is sweet clover. I wish you'd find out just how much sweet clover hay he has.—[Will Mr. Stolley kindly help us out about this?—Ed.]

REARING QUEENS.—I've been much interested in reading the excellent report of what must have been an excellent convention—the Colorado one. I venture a few words to Mr. Aikin. On page 229, you say that if a colony has no brood at all except some fresh-laid eggs, "then you know there will be no building from old or advanced larvæ." That seems entirely reasonable, but after some considerable experience working upon that theory and some careful observation, I am inclined to say that if you want to make sure of having some queens reared from well-advanced larvæ, just leave a strong colony queenless with nothing in the line of brood, but eggs. At first I couldn't understand how it was that when I left nothing but eggs I got not only some excellent queens but a few that were very poor. Bees seem to have a tendency to start fresh cells on successive days, and a few days after starting the first queen-cells, if you will watch closely, I think you will find, as I did, that they start queen-cells later from larvæ that had been advanced as workers. I'm wondering why you think transferring larvæ is a thing only for experts. If you try it once I think you will see that a novice would have no trouble with it. But transferring eggs that you speak of, I should think would be a very different thing.

Since writing the above, I find Mr. Rauchfuss, farther on, made the same correction that I have, but it will do no harm to emphasize by repetition. Sometimes I have taken the trouble to destroy all the larvæ that were not in queen-cells three days after hatching from the egg. That makes a pretty safe thing.

THAT ASSESSMENT.—On page 237, Rev. E. T. Abbott protests earnestly against a clause in the New Constitution providing for an assessment. Right you are, Mr. Abbott, and with such a clause I'm sure you're not the only one who will simply stay out. Such a thing has never been practiced or needed in the Union in the past, and why should it be in the future?

Marengo, Ill.



An Interesting Beginning—Numbering Hives.

BY L. G. CASH.

It may be remembered that I am the crank who took the bee-fever over a year ago, while attending a Farmers' Institute where Mr. E. T. Abbott gave a bee-lecture. It may also be remembered that I rushed into bees rather stronger than Mr. Abbott thought wise, as I was a green hand at the business. Well, here's my experience:

To start with, I bought and traded for 33 colonies of black and hybrid bees in every conceivable shape except in improved hives. There were six or eight log-gums, one or two

cracker-boxes, five in *moth-proof box-hives* that were not quite as good as the gums, and the rest were a job-lot mixture. Some of the colonies were about to starve, and I fed them during warm days in December.

I got a supply of 8-frame dovetailed hives in the flat, and during the winter and early spring I put them in shape and painted them. I procured a copy of "Langstroth on the Honey-Bee," "A B C of Bee-Culture," "Bees and Honey," and "Amateur Bee-Keeper," and took the "old reliable" American Bee Journal.

When spring came I got a little impatient, and transferred one colony one warm afternoon; two days later they were gone—probably robbed. I then waited until fruit-bloom, and tried again, with better success. I transferred all of them, putting them back on the same stands. After I got my hand in, and my nerve up, I could take an old gum or box-hive from a stand, take it to the honey-house, break it open, take all brood and straight comb, fasten it in frames, drive in the bees, and have it back on the stand again, and all in 40 minutes. Out of my 33 colonies I saved 27, spring count.

I then sent South for six Italian queens. The first two were lost in introducing, the shipping-cages being the old style, and not self-introducing. I left the cages in two or three days, then opened them up and let the queens out, but the bees were mad, and made short work of them. The balance were in proper cages, but did not arrive until so late that it delayed my Italianizing, so I only got about half of them Italianized.

I had but few early swarms, and the late ones I put back into the same hive after cutting out all queen-cells. My bees gathered some honey in June, but very little at any other time. May was a little too showery, and the latter part of the summer and fall were too dry.

I got only about 500 pounds of comb honey, and had to feed about 200 pounds of sugar in the fall. One or two colonies stored about 50 pounds each in one-pound sections, and then I had to feed them in the fall.

Cider-mills, cane-mills, and fruit rotting in the orchards played hob with bees in this section of country, and they went into winter quarters very weak in numbers, and with but little honey. Had I known what I do now regarding the season, I should have taken off the supers early in August, and fed a little to stimulate breeding, regardless of the extra amount of sugar necessary for wintering.

I began the winter with 31 colonies, and hoped to come out in the spring with about the same as I started in with, spring count. They were wintered on the summer stands, with one of Mr. Abbott's sugar-loaves over each colony, that covered with cloth, and the balance of the super packed with old cloths, carpet, straw, or anything that would hold heat and absorb moisture. If we had any warm, sunny days in winter or early spring, I expected to take the covers off the hives and allow the packing in the supers to dry as much as possible, without disturbing the bees.

METHOD OF NUMBERING HIVES.

My method of numbering hives is to take the nicest, smoothest pieces of broken sections, paint them dark red, then numbers in yellow. I use patterns of the numbers cut out of oil-pasteboard. Little girls or boys make splendid painters at such work, and it keeps them out of mischief during the long winter evenings.

I fasten the numbers on front of the hives, with four small wire-nails ($\frac{1}{2}$ inch nails are about the right size), and they can be easily removed by slipping a knife blade under and prying it off.

I have a small blank book which I carry in my pocket, and keep a record of each hive on a separate page, which helps me to select queen-cells from the best colonies, etc.; also to keep a record of the amount of honey taken from each colony, which enables me to place a proper value on any colony I may sell. In fact, I keep a record of almost everything connected with the work—things needed for the future as well as what has been done in the past.

I leave the numbers on the hives. Although they get mixed up promiscuously in the yard, I can generally tell where any certain number is without hunting. Of course, if I had a large apiary I could not do so. Russellville, Mo.



The McEvoy Foul Brood Treatment is given in Dr. Howard's pamphlet on "Foul Brood; Its Natural History and Rational Treatment." It is the latest publication on the subject, and should be in the hands of every bee-keeper. Price, 25 cents; or clubbed with the Bee Journal for one year—both for \$1.10.

Preservation of Comb and Rendering of Wax.

BY HON. R. L. TAYLOR,

Superintendent of the Michigan Experiment Apiary.

(Continued from page 245.)

After the preservation of all comb that promises to be of value as such, there will remain, as intimated at the outset, comb of different descriptions that is of value only for the wax it contains, and still of far too much value for that to excuse its neglect or loss. Conveniences should always be at hand in every apiary for the collection and preservation of all bits that may be trimmed from combs, frames or honey-boards. Such pieces are especially valuable for they are composed almost entirely of wax, and the rendering of them is easy. These and all other comb to be rendered should be kept away from moisture and light until that operation can conveniently be attended to.

The rendering of brace and burr combs, and of other comb in which no brood has been reared, since they contain nothing to prevent the wax readily separating from the residue, is a comparatively simple matter, but with that of a comb full of cocoons and bee-bread the case is different, and yet, when the proper course is understood, one knows what to expect, and the operation is not a trying one. For that class of comb from which cocoons are absent, almost any method (except the one often recommended, of tying it up in a bag and then boiling it to make the wax exude from the bag) will answer tolerably well. If one is already provided with an ordinary wax-extractor or with a solar wax-extractor it may well be used, but if I were without both I should hardly be to the expense necessary to procure either. At best, the solar extractor is cumbersome, can be used only about two months in the year, and is of no practical utility in rendering comb containing cocoons. As to the ordinary wax-extractor, the best I can say for it after testing it thoroughly for 10 years or more, is that it does tolerably well what can be done much more quickly and easily with an open vessel.

In the absence of extractors, if the comb to be rendered consists entirely of that without cocoons, it may be put on the stove in almost any kind of a vessel that will stand fire, one of tin or copper being preferable to one of iron, on account of the dark color which the latter imparts to the wax, and brought to a "boil," of course, putting in plenty of water before placing the vessel over the fire. When the wax is all thoroughly melted, let it cool, either upon the stove or in as warm a place as possible off the stove. When the wax is cold it may be lifted off almost free of foreign matter, and afterwards treated by a further process described later to fit it for market.

Everyone who has anything to do with the heating of wax on a stove should be thoroughly impressed with the fact that without unflinching watchfulness the operation is attended with a good deal of danger. Boiling wax is very liable to boil over, in which case it runs at once into the fire-box, takes fire, and almost at once the stove is a mass of flames, and, of course, unless prompt preventive measures are taken, the wax boils over faster and faster, and the house itself runs an extreme risk of destruction. Only a cool, careful person should have charge of such work, and he should never be out of sight of wax boiling, or likely to boil, at least, not until he so thoroughly understands the details of the process that he knows what, within the possibilities, may happen while he is gone. Boiling wax may be kept from running over in most cases by lifting it with a dipper and pouring it back from a little height, but to meet all emergencies adequately, plenty of cold water should always be at hand, with a dipper. Boiling wax is easily controlled by adding cold water.

For the rendering of combs containing cocoons, and that without cocoons need not be excluded, I think after trying every imaginable method, except that by the use of steam from a boiler, that there is no process for the average bee-keeper equal to that which I now use. It is as follows:

I provide myself with utensils—a rendering-tank or kettle, a perforated-tin vessel, such as is used inside the ordinary wax-extractor, and a tin scoop, such as is used by grocers for the purpose of handling sugar, etc. For the first I use a circular tin vessel, 20 inches in height and 24 inches in diameter, which is as large as the top of the stove I use in my honey-house will accommodate, but neither the shape nor size is material, except so far as the amount of work to be done requires. An old wash-boiler would answer well enough for most apiaries. The utensil of perforated tin is eight inches high and ten in diameter. The scoop I use would hold about a pint, but its very important characteristic is its sharp edge at the mouth, of one thickness of unfolded tin.

When ready for the operation, I place the tank, about one-quarter full of water, on the stove in which I make a good

fire, which, of course, is to be kept up as the necessities of the case may require. More water may be put into the tank at the start if the combs have not been prepared by soaking in water, which it is better to do, as that tends to prevent the cocoons taking up and retaining the wax. I think it is an advantage, also, to crumble the combs quite finely, which may be done readily if they have been stored where the temperature is quite low. The comb is then put into the tank, which will accommodate that from about 100 Langstroth frames, or 170 Heddon frames. When the contents of the tank boil, and the wax is all thoroughly melted, it will be found that there is room in the tank for considerable more water. This is now added to the extent of about a pail full, which must be cold and handled with a dipper so that it may be done gently and somewhat gradually.

At this point the boiling has ceased and the surface of the lately boiling comb somewhat hardened, so that it retains a considerable part of the added water on the surface. Now I watch it, keeping up a moderate fire. In a few minutes the pure wax is seen oozing through the crust and floating away on the water. More water is added now in sufficient quantities to make the rising wax harden so that it may be removed with the hand. This is not a very material part of the operation, but it is utilized because in any case the water must be added. During the adding of the water, which must be to the convenient capacity of the tank, with a little care, about half the wax the comb contains may be removed in this way in an almost pure condition.

When sufficient water has at length been added, I let the whole come again to the boiling-point. Then I put the perforated vessel into the mass at the point where the wax appears to be gathering largely, turning it about and working it down until it contains a few inches in depth of the liquid, or I put a weight upon it and let it settle and stand a few minutes for the wax to gather, then, with the scoop, which must be of a size to work freely inside the perforated-tin can, I dip off the melted wax from the liquid. This is best done by settling the back end of the scoop and letting the surface wax run in over the sharp edge in front, which is depressed so as to get the wax without too much of the water, which is dark, while the wax is transparent. The perforated can is operated in this way in five or six different places more or less according to circumstances when most of the wax will have been removed. There is generally no particular object in working it too closely, for, at best, there will be a little of the wax that cannot well be removed.

I now let the mass get cold, when the crust of the "bagasse" will be found to contain the wax which remains. This is carefully removed and laid aside, to be added to the next "batch" at about the time it first comes to the boiling-point. This process is repeated until all the comb is reduced. A cover is provided for the tank and put in use whenever desirable.

After this is all accomplished comes the final process for clarifying the wax from the remaining impurities. For this purpose a smaller melting vessel is desirable. I make use of an old wash-boiler. I place the boiler, about half full of water, over the fire and add the wax, or as much thereof as I safely can, and let it melt and boil. Now, while it is very desirable not to let wax boil more than is necessary, on account of the injury done it thereby, yet some boiling is necessary in order to put the impurities in such condition that they will readily settle below the wax. The proper stage is known from the transparency of the wax which may be discovered by lifting a little from time to time in the scoop. When the wax thus raised is clear, I let the fire go down and out. In the meantime the room is made as hot as possible and kept so.

The wax is left on the stove and sometimes the vessel containing it is wrapped and covered with several thicknesses of paper. All this for the purpose of retaining the heat so that the wax may be in a liquid state as long as possible to give the impurities plenty of time to settle into the water below. On the same account I am careful not to agitate the wax in any way. If proper care has been taken the wax will remain liquid for several hours, but of course the length of time will vary according to the amount of wax, the size of the vessel and the warmth of the room.

When the temperature of the wax falls to about 155°, or, in case no thermometer is at hand, when the first signs of its beginning to harden at the edges appear, I am prepared with tin milk-pans to receive it and with the scoop to dip the wax. This is done with care, that the refuse below may not be unnecessarily disturbed, and yet, with speed, that the now rapidly falling temperature of the wax may not interfere with the completion of the work. All but from half an inch in depth of the wax may be dipped without greatly disturbing the settlements, and when it is seen that any of them adhere to the

scoop, the dipping is stopped and the rest of the wax is left to harden where it is, when it is lifted out in a cake, and what little refuse adheres to the lower side may be readily scraped off and the whole batch be in good condition for market.

In this process the skimming off of such impurities as rise to the surface just as the wax begins to boil should be attended to.

If the course indicated be familiarized and practiced, it is confidently believed that the rendering of wax will no longer be considered a difficult or a disagreeable operation.—Review. Lapeer, Mich.



Sizes and Kinds of Hives—Non-Swarming Bees

BY E. S. LOVESY.

As so much has been written on the swarming vs. non-swarming topic, and also the best kind or size of hive to insure success, I presume many bee-keepers think what few good points obtainable, that would be of material benefit, have been already threshed out, so that there is little besides chaff left. One thing is certain, if all the good points on these questions have been brought out, many of our bee-keepers have not practically utilized them. Many have tried, or practiced, a little on an improved hive, or on the non-swarming system, with a determination not to approve or believe in it unless they are compelled to do so. It is useless to expect success from any experiment unless it is followed up with thorough tests. If this is done with a determination to develop all the good points, the result will be a success, or proof that success is not obtainable. But some bee-keepers will experiment with one or two colonies of bees to try the non-swarming method, or to test some new hive, or one different from what they have been using, then if they don't succeed they jump at the conclusion that there is nothing in it, when, in fact, this would be no test at all of the merits of any hive or any system of management. Of course, we are all aware that location, or the amount of honey-flow, cuts a big figure in experiments of this kind; in fact, this is more or less correct in experiments of any kind.

Some bee-keepers here, the past season, tried what is called the Ferguson pattern of the Langstroth hive. A few bee-keepers got one or two just to try them, and when they happened to be located in the center of large lucern fields, as a rule they were a success, while others not so favorably located were not so favorably impressed.

Now, as to the merits of different hives: Having used nearly all the different styles of hives in general use for the past ten years, I have about arrived at the conclusion that the best all-purpose hive, or the one that pays me the best, is the 10-frame Langstroth. The 8-frame is all right for comb honey, because in running for comb honey the bees keep the brood-chamber pretty well filled with honey, but in running for extracted honey with a two or three story hive, the queen often fills the bottom story so full of brood that there is not enough honey to winter on, and my bees winter best in a one-story hive.

I prefer the 10-frame for an all-purpose hive, and when I get a three-story 10-frame Langstroth hive with 40,000 to 50,000 bees in it, run on the non-swarming method, then I have a colony of bees that pays. They give me greater returns for the amount of money invested than anything else would give for a like amount invested. When I went down to St. Louis and the World's Fair, three years ago, the profits from two of my best colonies paid my entire expenses for the trip.

A PHENOMENAL COLONY OF BEES.

The following is a record of my best colony the past season: They filled up their hive with bees earlier than most of the others, so I took out three frames of brood from them twice, which I put into empty hives; these I filled up with frames of honey and foundation, then I moved two other strong colonies and put the two new hives in their place; the bees returning from the field filled them. In a few days the old colony, A, was teeming over with bees again. I then took three other frames of brood as before, but I also moved the old colony A, and let them furnish the bees to make colony B, but in order not to weaken them too much, and as I owed them six frames of brood that, as I have stated, I took from them in the beginning, I gave them three frames of brood from another hive. A little later I repeated the operation, giving them back the other three frames, but this time I divided them about 11 o'clock, and got an overflow swarm; that is, I again moved the old colony A as before, and they filled the new hive C full. Of course, the bees in hive C started queen-cells, but on the fourth day I put in a queen-cell that

was about ready to hatch. The queen hatched out all right, but the bees would not let her tear down the cells that they were building, so she swarmed out, taking about half of the bees with her, thus forming swarm D.

Later I divided the old colony A, taking out enough brood and bees to make swarm E; this swarm I exhibited at our County Fair, showing the process of building queen-cells.

Still later (June 29) the old queen A had the hive full of bees and 14 frames of brood. I then took a new hive and put in it three frames of brood from swarm C; this I put on the old stand A, and I shook the old queen and all her bees into it. I then divided the 14 frames of brood belonging to the old queen, putting them into two new hives, and set them on the stands of B and D, letting those swarms furnish bees to the hatching brood, and forming colonies F and G. Now I have seven good, strong colonies of bees, and all of them built up entirely from the old colony A and her increase. I have taken a little over 500 pounds of honey from those seven hives, the old colony A furnishing more than double the amount of any of the others, and each of them gathered enough honey to winter on. Now, if any of our bee-keepers can beat this, or come near to it by natural swarming, they can do more than I can.

For the past three years I have tried a few colonies on the natural-swarming plan, with very unsatisfactory results. Some of the new swarms do very well, but some of the old colonies do very little, and they never average half as much any season as the non-swarmers.

I have practiced the non-swarming system 11 years without a single failure. I mean that the results each year have been satisfactory financially. Of course, we all have a few colonies every year that don't build up or do much. This seems to be one of the questions that we cannot account for. I generally requeen those poor ones by, or before, the last of June, with good results, as a rule.

To make a success of dividing or non-swarming, requires some practice. By the non-swarming system we can rear all our queens from the very best stock. It will be seen that in every instance I have reared all the new queens from the old queen A, besides many others for other new swarms. This old queen is three years old, and they have never built a queen-cell in the old colony. Those bees are leather-colored and 4-banded. I have many others as good as those, and none of them ever swarm, as long as they have room or empty space in the hive. I divide as early as it is practicable, then I strengthen them up and give them room.

In running for comb honey, I find the Ferguson-Langstroth hive, as a rule, easy to get the bees up into the sections before they get too crowded in the brood-chamber. When I want to get the bees into the sections, I smoke them up late in the afternoon, and close the slides from 12 to 24 hours, or until I get them working in the sections.

THE 10-FRAME LANGSTROTH HIVE.

There are some points in favor of the old standard 10-frame Langstroth hive:

First, it is a good winter hive, holding sufficient stores to last the bees through the winter, and if they are properly packed and ventilated, they will come through all right. In running for comb honey the hive is the right length, breadth and depth to hold 56 sections. I know of no hive with the boxes and frames all of the same size and shape, and that is so well adapted for comb honey as the Langstroth, and if we run out of sections, or if we wish to change and run for extracted honey, the frames and hives will fit as they may be desired; and if we have strong colonies and a good honey-flow it is the best adapted and the best paying hive to run three stories. A deeper hive would not be practicable, and if we use loose bottom-boards we can divide quickly, or have the brood and honey in any part of the hive that we may desire.

BENEFITS OF COMB FOUNDATION.

One reason why my bees always pay well, is because I use considerable foundation. I never put an empty frame into a hive. Too many of our bee-keepers do this, but to tell the truth I do not know but that a bee-keeper that never uses foundation should be called a "bee-owner" instead of a "bee-keeper." A long article could be written on the benefits of foundation to bee-keepers. It not only causes the bees to build straight combs, but by a liberal use of foundation the bees will never crowd out the queen, for she will always have room to lay eggs. If we take two colonies of equal strength, and use foundation on one and none on the other, the one having the foundation will gather more than twice as much honey as the other in the same time, as from 2,000 to 3,000 bees can work on a sheet of foundation easier than 200 can work on a bare top-bar.

Salt Lake City, Utah.

POISONOUS HONEY—DO BEES GATHER IT?

"APIS VIRUM" IN ALL HONEY.

Novice desires the readers of the Bee Journal, who keeps bees where mountain laurel grows, to speak as to the wholesomeness of honey gathered from it. He gives a very good description of mountain laurel as it grows hereabouts. It grows in great abundance on the mountains of Pennsylvania; and the bees work some on it, but not enough to get much surplus from it. I believe the honey has never been known to injure any one here, nor does it seem to have any deleterious effect on the bees. The leaves of the shrub are generally conceded to be poisonous. I never knew cows to eat it here, but sheep, left to their own resources too early in the spring, have been known to eat it, and it generally resulted in giving the owner a job of picking the wool off their dead carcasses, too. The blossoms are generally considered to be harmless. The boys, living near enough, gather and sell great quantities of them to the city folks, and I have never heard of any one being poisoned by them.

Like Novice, I, too, am somewhat skeptical about poisonous honey. I would like to see some of the so-called poisons honey sent to a chemist for a chemical analysis. I have known horses to be made very sick by being turned into a nice field of clover, and have heard of them even dying from the same cause, but that would not warrant any one in saying that green clover was poisonous. The danger was in the eating to excess of feed to which they were not accustomed.

As a matter of fact, there is more or less poison in all honey, as in nearly everything else we eat. The mite of poison that the Author of Nature has compounded with the various things we eat, is as necessary and indispensable to our well-being as any of their other properties. All honey contains more or less *Apis virum*, which, as a drug, is a powerful and deadly poison. If we consider the very small amount of this poison that is injected into the body by the sting of a bee, and note the effect on those that are not used to being stung, we may have an idea how powerful this poison really is.

When I first began keeping bees, a sting within two or three inches of the eye was sufficient to nearly close it, and the effect would last for a day or two, but now I am so inoculated with this poison that it has little or no effect. In those days, too, if I ate honey with any degree of excess, a violent pain in my stomach was sure to follow. This, too, passed gradually away on becoming used to honey. Now, if I had not been interested in bees, and had bought honey of uncertain source, and had been seized with violent cramps in the stomach shortly after eating it, I might well have been excused for saying and thinking that the honey was poisonous. It is owing to the presence of *Apis virum* in honey that so many people are benefited by its use.

The *Apis virum* makes honey really a medicine for several diseases. If more honey was used there would be less backache and kidney trouble; so says Dr. J. M. Wallace, late of Cleveland, Ohio, but now of this city, for whom I have extracted considerable *Apis virum*. He says it is one of the most potent of drugs in the treatment of kidney diseases and Bright's disease, and many others. He says that the virtue of *Apis virum* is becoming better known and appreciated by the medical fraternity, day by day, and that it will be used in much larger quantities in the future than heretofore.

I collected and sold considerable *Apis virum* last season, and have two orders standing now to be filled as soon as possible. I intend to try to work up an extensive trade in *Apis virum*. I have invented a device for extracting it from the bees without injuring them, and by which I can extract as much in one hour as a small army can do with tweezers. If the readers of the Bee Journal are interested, and want to know more about this department of bee-culture, I will describe it more fully some other time.

ED. JOLLEY.

Franklin, Pa.

[Yes, we all want to know how you manage to make the "tail" end of the bee more profitable than its tongue end. But, then, why shouldn't the "business end" be all that its name implies?—ED.]

POISONOUS HONEY FROM IVY.

In reference to the article on page 146, about poisonous honey, I can't agree with Novice. Why? Because I know that bees do collect honey and store surplus from ivy. Why do I call it ivy? Because I want to make a distinction between what we call mountain laurel and ivy—the bush that bees collect poisonous honey from.

I would not have written this if it had not been called for, but bee-men ought not to sell such honey in any form what-

ever, because it is as sure to make a man sick as he eats it. The honey in its purity is as clear as spring water, but its taste, when examined closely, will tell a man there is something wrong. It has a strong, bitter taste, which makes it disagreeable.

The symptoms of the poisoning are a sickness in the stomach, a coldness in the top of the head, with cold and hot flashes in the face, and a general stupor; the sight becomes dim, the skin on the hands, by rubbing, seems to be dead, with a tingling sensation. I want to say right here that this poisoning is not dangerous in the least—it makes a man vomit well and freely, and when that is said all is said. This sickness doesn't last longer than an hour.

The plant is well described in Novice's article, but we mountain people don't call it "laurel." We have laurel, but it is entirely different in its blooming from ivy, as laurel forms balls one year for its blooming the next, and ivy blooms on the new growth each year. I have never seen honey-bees working on laurel bloom.

The ivy doesn't secrete nectar every year, nor does it every other year, but say once in ten years, and you will be close onto it. We don't have ivy here limited to 40 acres, but have it by the 1,000 acres.

I am not writing this to get up a controversy, but if any reader disputes this, I will send him a sample in the comb, if he will send me the cost of something to ship it in, and then pay the express charges; and if he will eat it, and it doesn't make him think he is trying throw up his sock-heels, I will pay back all charges.

My bees are all wintering on this poisonous honey now. We had a general flow of it last year. I extracted some 300 or 400 pounds of it, and just quit, knowing I did not want it, and knew that the bees would need it this winter.

Mr. A. I. Root, in his "A B C of Bee-Culture," is correct. If he had come out plain, and said it was a fact, he would have been correct.

Novice, in his second paragraph, seems to be solid in his opinion, and it may be true that ivy, in his place, doesn't secrete nectar, but I know it does here along the mountains of East Tennessee, but not often.

In his third paragraph he says he doesn't know whether there are two varieties or not, and that cows will eat the leaves. That is correct, and it will poison them, too. I will say at a venture, there are two varieties, but we call your mountain laurel, "ivy," and have a "laurel" which is entirely different, only they are both evergreens.

I don't want any one to believe a lie, and if any one doubts my statements, I will refer to Sam Wilson and R. A. Shultz, both of Crosby, Tenn. I will also send samples of honey as above stated. Wm. Webb.

Sutton, Tenn., March 12.

PARTICULARS OF THE CASE OF HONEY-POISONING.

On page 825 (1895), under the heading of "Honey from Mountain Laurel," appears an item that I have anxiously hoped would be thoroughly discussed by some of our bright lights in bee-lore, as I think it one of vital importance to the honey-producer, especially in this section where the case occurred. It makes no difference to me at present, as I am only "in it" to have something to draw my mind from the cares and worries of office work, but in my dozen or more of hives I find a real enjoyment, that I can get nowhere else, and which I find very beneficial. But I could not let go unnoticed the harsh and unreasonable things said by the ignorant about the bees and their product. But I fear it has had a bad effect on the honey-business in this locality, almost every one being afraid to use it unless they know it to be all right.

I am personally acquainted with Mr. Chambers, and I can assure you that the case is not overdrawn by the imagination of any one, as you will see from the enclosed letter from Dr. Elmer, the attending physician, which gives a clear statement of the case. I also send a clipping from the daily paper containing the report of Dr. Wormley, who analyzed a portion of the box of honey used, and if you can get any satisfaction as to just what kind of poison he found, I cannot; he claims to have found it in the solid part. Now that means the comb. Have we any record of the bees making poisonous comb? He found none in the honey proper; then how could it come from "mountain laurel?"

The honey came from Prof. A. J. Rider's cranberry farm—perhaps he could tell of some treatment the comb had been put to, to preserve it from the previous season. Strange to say, this is the only case. I tried to get a sample, but none would they let go. A dollar a box would get none. Had I obtained a sample, I should have forwarded it to Prof. Cook.

I may be wrong, but I do not "go much" on that analysis

as made by Dr. Wormley. I do not think him practical enough to analyze honey so as to do justice to the bees. Do any of our bee-keepers know of similar cases? If so, let us have it talked over; it will be of far more benefit than to know whether there will be non-swarmling bees, or some other things that are sometimes discussed in our papers.

Trenton, N. J.

GEO. B. HURLEY.

[The letter from Dr. Elmer, referred to by Mr. Hurley in the foregoing, reads as follows:—Ed.]

MR. GEO. B. HURLEY—*My Dear Sir:*—In reply to your request for the symptoms of the poisoning by honey in the cases of Mr. and Mrs. John S. Chambers, as alluded to in the American Bee Journal of Dec. 26, 1895, I would make the following statement:

They were the only two persons who partook of the honey. All the rest of the family, and the servants, ate of each of the other articles served at breakfast, and were not in the least affected. Mr. and Mrs. Chambers took but a small quantity, yet each noticed a peculiar, pungent taste in the comb as soon as it passed their lips. In 15 or 20 minutes afterward, Mrs. C. was taken with nausea, abdominal pain and vomiting, soon followed by loss of consciousness, coldness of extremities, feebly acting heart, and complete collapse. While ministering to her, Mr. Chambers, who had also experienced the initiatory symptoms of pain and nausea, suddenly exclaimed, "I cannot see!" and soon sank in a state of syncope to the floor.

In each case the symptoms were then similar. Retching, vomiting, purging, acute gastric and abdominal pains and cramps continued for some hours, with surface coldness, deadly pallor, delirium, and the general symptoms of collapse. No pulse could be detected at Mr. C.'s wrists for two hours, and the heart-sounds were extremely feeble and irregular—as they were also in Mrs. C., though her pulse was not entirely lost, yet for an hour or more was scarcely discernible.

By the aid of restoratives, consciousness returned to Mrs. C. in about three hours, but the husband was not fully himself for 19 hours—until 4 o'clock the next morning—and had no recollection of anything that transpired in the interim, although he had at times conversed with the nurse and myself during the afternoon and night.

The treatment consisted of brandy and hot drinks, swabisms, and external applications of heat, hypodermatic injections of morphia for pain—and of digitaline, until reaction was assured; then rest, quiet, and a general supporting plan was adopted.

Recovery took place gradually, and without any eventful symptoms, though the restoration to strength was very slow.

An analysis of the remaining honey was made by Theo. G. Wormley—Professor of Chemistry in the University of Pennsylvania—who states:

"Several experiments upon dogs, made in connection with Prof. Reichert, have shown that the honey contains a most prompt and potent poison, producing within a few minutes violent vomiting, followed by purgung, great prostration, convulsions, coma and death within a few hours. It would appear that the poison is present chiefly in the solid portions of the honey.

"The symptoms showed in your cases very strongly resembled those observed in several reported cases of honey poisoning, in which the poisoning was attributed to honey collected from the *Kalmia latifolia* or Mountain laurel, which, I understand, is very abundant in your State. Although the plant has long been known to possess poisonous properties, yet repeated examinations, by different chemists, have thus far failed to separate the poisonous principle, or determine its chemical properties.

"It may be some relief to the family to know that the poison was a substance inherent in the honey, and not to a substance added thereto maliciously or by accident. From my personal interest in the matter, I will continue the examination of the honey, and make every endeavor to separate the poisonous principle."

Trusting that this brief account may be of some service to you, I remain,

Trenton, N. J., Jan. 15, 1896.

Yours very truly,

W. ELMER.

[We wish to thank Mr. Hurley, and also Dr. Elmer, for their excellent letters. They are particularly interesting, as they come direct from the place where the honey-poisoning occurred, that has stirred up all the discussion on the subject which has appeared lately in the Bee Journal. We hardly think that the instances of poisoning from eating honey are sufficiently numerous, or serve to cause any great uneasiness among producers or consumers of this delicious sweet. At any rate, if the supposed poison was found only in the honey-comb, it will cause more extracted honey to be eaten.—Ed.]

OLDEST BEE PAPER IN AMERICA ESTABLISHED IN 1861

THE AMERICAN BEE JOURNAL

PUBLISHED WEEKLY BY
GEORGE W. YORK & COMPANY,

118 Michigan St., CHICAGO, ILL.

REGULAR CONTRIBUTORS:

G. M. Doolittle, of New York. Prof. A. J. Cook, of California.
Dr. C. C. Miller, of Illinois. Dr. J. P. H. Brown, of Georgia.
J. H. Martin, of California. Rev. E. T. Abbott, of Missouri.
Barnett Taylor, of Minnesota. Mrs. L. C. Axtell, of Illinois.
Chas. Dadant & Son, of Illinois.

\$1.00 a Year—Sample Copy Sent Free.

[Entered at the Post-Office at Chicago as Second-Class Mail-Matter.]

Vol. XXXVI. CHICAGO, ILL., APR. 23, 1896. No. 17.



Time to Advertise.—We have often been surprised that more of those who have bees, queens and bee-supplies to sell, do not patronize the advertising columns of the bee-papers. The next two or three months is just the time to let bee-keepers know what you have to offer them. Better get your advertisement going at once, and thus capture your share of the trade. The dealers who do the business, always advertise. If you would do likewise, be sure to let bee-keepers know what you have to sell, and where they can get it. We can make room for a few more reliable dealers in our advertising columns. Give it a trial now.

The Michigan State Convention.—We received the following notice too late to appear in last week's Bee Journal, and though it may not do much good to give it now, we do so for it may be in time for some to go the second day of the meeting:

The illness of the President, and of the Secretary's daughter, has caused the holding of the Michigan State Bee-Keepers' Convention to be postponed. It has now been decided to hold it April 23 and 24, in Lansing, at the Van Dyne House, 411 South Washington Ave. Rates only \$1.00 per day. Street cars pass the door. The first session will be held on the evening of April 23.

The Hon. R. L. Taylor will talk about "Lessons in Wintering." James Heddon, who is just home from Florida, has been asked to tell us about bee-keeping in that "land of flowers." L. A. Aspinwall, of Jackson, will have an essay on "The Requisites of Success in Bee-Keeping." The Hon. Geo. E. Hilton has chosen for his subject, "The Crisis in Michigan Bee-Keeping." Dr. L. C. Whiting, of Saginaw, will have an essay showing that "Bee-Keepers Must Follow the Wild Flowers." Mr. T. F. Bingham will also have an essay on "Horizontal Prices." W. Z. HUTCHINSON, Sec.
Flint, Mich.

We understand that there is no saloon in connection with the hotel where the convention is to be held. That's good. We believe in patronizing that kind of a place whenever possible. The idea that a hotel must have a saloon attachment is the sheerest nonsense; and is no credit to those who demand it; for the saloon would not be there were it not patronized. We are glad to believe that bee-keepers above all others have no use for the saloon—that modern abomination that does

more to destroy the home and all that is pure and good in manhood and womanhood than all the other curses known to this world. But the verdict has been given—*The saloon must go!*

Commission Charges.—In the April Progressive Bee-Keeper, Mr. W. H. Pridgen, of Creek, N. C., has a criticism entitled, "Exorbitant Charges," in which he rather "goes for" almost all kinds of dealers, and also refers to our statement, made some time ago, when we said that we thought it all right for commission men to charge 10 per cent. for handling a small lot of honey (under \$100), and a less per cent. (say 5) for selling over \$100 worth. Mr. Pridgen thinks the commission should be the same, whether small or large lots, say 5 per cent. At least he says:

"I know enough about the commission business to know that the commission should be the same per cent. regardless of amount, while freight and cartage is a different thing."

Of course there's no law against Mr. Pridgen *thinking* he is correct, but if he should do business in Chicago awhile, we think he would change his opinion. Commission men have told us that often it is more work to dispose of a small lot of honey than a whole carload. One reason is, that there is seldom any uniformity in quality of honey or style of package among a number of small lots of honey, and so perhaps such must await a purchaser who wants but a little honey, or one who is not particular as to what he buys. Think of a commission man who pays \$100 a month for rent alone, fooling away his time on a 5 per cent. commission of a \$10 lot of honey that has had to take its chances in finding a purchaser! Life is too short, and it costs too much to live in any city, to do business in that way.

To Illinois Bee-Keepers Only.—The Secretary of the Illinois State Bee-Keepers' Association has sent us the following notice, which he wishes all bee-keepers in this State to read:

At the annual meeting of the Illinois State Bee-Keepers' Association, held in the State House at Springfield, Nov. 19-20, 1895, it was resolved to make an earnest effort to increase the membership and extend the influence of the organization.

In order to enlist the co-operation of bee-keepers, it was arranged to present each member with a year's subscription to the American Bee Journal, which was adopted as the Official Organ of the Association.

In addition to said annual subscription, members will be furnished with a copy of the Second Annual Report of the Illinois State Bee-Keepers' Association, which is a large and attractive volume containing a vast amount of useful information to bee-keepers.

The Illinois State Bee-Keepers' Association is composed of able and experienced apiarists, second to none in their general information in all matters pertaining to bee-keeping, and said parties have resolved to keep the Association in the front rank among similar organizations in other States.

On the receipt of \$1.00, by the Secretary, he will take great pleasure in enrolling your name as a member of the Association for one year, and will see that the Bee Journal and Report referred to above, are sent you, with any other matter of general interest that may be sent out by the Association.

If already a subscriber to American Bee Journal, one year will be added, from date of expiration of your subscription.

Yours truly,
JAS. A. STONE, Sec.
Bradfordton, Ill.

We hope that not only those who are now subscribers to the Bee Journal in this State will respond to the foregoing notice, but that they will tell their neighbor bee-keepers about it, and try to have them also become members of our State Association. There is now no reason why Illinois should not lead in the matter of membership, at least. Encourage our good Secretary Stone, by complying with his generous request.

See "Bee-Keeper's Guide" offer on page 271.

Spring Feeding of Bees.—In Gleanings for April 1, we find the following on "Spring feeding *a la* Boardman; how to get all the honey of the fields into surplus:"

In the first place, the syrup should be made by mixing sugar and water in equal proportions. You can use heat to dissolve the sugar if you prefer, but I do not think it is necessary. Pour the sugar and water, equal parts, into an extractor-can, and turn vigorously for a few minutes. (If you haven't an extractor, use a tub and a stick.) In half an hour or so you will find a clear limpid syrup ready to draw off from the honey-gate of the extractor into those glass jars of the Boardman feeder.

I believe it is unnecessary to explain this feeder, which I believe is the best adapted for this kind of feeding. It permits of the syrup being fed a little at a time, and when the feeders are empty they can be seen at a glance, without opening the hive or disturbing the bees. In almost a minute's time it is possible to tell what feeders are empty in an apiary of 75 or 100 colonies, just by glancing down the rows, and walking rapidly across one end of the yard. For spring feeding, at least, an entrance feeder, especially Boardman's, is altogether the best.

A great many ask if it is necessary to feed, providing the hive is fairly well supplied with stores. Not so necessary; but if you wish to carry out the Boardman idea as I understand it, it would be advisable to feed all the colonies. Those that have a good supply already will be stimulated by the feeding, and,

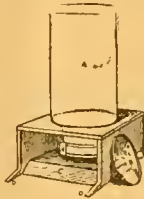

The Boardman Entrance Feeder.

as a consequence, commence rearing a lot of brood; and that means a host of young bees and a lot of honey later on in the season, if there is any to be had. Even if the bees are fairly well supplied with stores, they won't rear brood anything as they do when a fresh supply is coming in every day. Of course, the colonies that are well supplied do not require as much syrup as the others that are running short. But suppose the combs are stored and the brood-nest will permit no more. Such combs of sealed stores taken out and set aside will come in play for winter.

Perhaps you may argue, "What is the use of buying syrup to feed bees in the spring, when they have already enough to carry them through till the honey-flow?"

"Enough"—there's the point! If they have just barely enough, the bees will scrimp and economize in some way, to make their stores last; and the only way for *them* to economize is to cut down brood-rearing—very poor economy for *you*, certainly.

"But" you say, "if I feed the bees a little every day, the hives will be crammed full of syrup, and I shall be out of pocket to the extent of several barrels of sugar."

What of it? You will be a gainer in the end by having a large force of bees to gather the honey if it *does* come; and then when that time arrives, it will be shoved right into the supers, because there will be no room for it in the brood-nest. The honey from the fields will bring a higher price, and you have made a first-class trade—sugar for honey. More than all, your brood-combs will be filled with the very best of winter stores, and much cheaper. And suppose you *are* out of pocket several barrels of sugar. Suppose you have fed 1,000 lbs. of sugar syrup, costing you, say, 4 cts. per lb. (when ripened,) and suppose you get in exchange 1,000 lbs. of honey. The latter ought to bring, if clover or basswood, from 8 to 9 cts. Clearly, then, you have made a profit of at least 4 cts. per lb. on the syrup, or an aggregate of \$40.00 on the trade, because the honey would have taken the place of the sugar syrup in the brood-nest.

As Mr. Boardman well says, the farmer thinks nothing of feeding his stock, expecting to get returns. He who would say he could not afford to feed his hogs well because the grain that he would feed them would cost money, would be considered a fool indeed.

In view of the poor honey-years of late, and in view of the further fact that what little honey has come in has just about filled the brood-nest and no more, leaving little if any surplus, it would look as if Mr. Boardman's idea of substituting syrup

for honey, and *pocketing the big difference* in price between the syrup and honey, was simply utilizing good business sense.

One year when I called on Mr. Boardman, he had quite a crop of honey. He had been feeding, as I have explained. His neighbors round about him did not feed, and did not get any surplus honey. I firmly believe that many of our bee-keeping friends can just as well be getting a little surplus, and a little money for it, as to be going ahead on the old plan of getting no surplus, and nothing but bees in fair condition for winter. But suppose a big honey-flow *does* come, and you have followed Mr. Boardman's method of feeding; your hives filled full of sugar stores, and capped over, are just fairly boiling over with bees. It is perfectly evident you are going to get a big crop of honey that year, and *all of that honey will be surplus*.

One of my warm friends in Canada has written me, earnestly protesting against feeding the bees as Mr. Boardman does, clear up to the time when honey is coming in. He insists that, as soon as bees begin to gather from natural sources, they will crowd some of the sugar syrup from the brood-nest up into the sections or surplus combs. I have talked with Mr. Boardman on this very point, and he is very certain that, as he practices feeding, it is not done. I have also talked with other prominent bee-keepers, and written for the private opinion of others. All seem to feel that there is but little danger to be apprehended from that source. But we will suppose that my Canadian friend's point is well taken. To be on the safe side, then, stop feeding within a week or two of the expected honey-flow. If the stores in the brood-nest are capped over, there certainly can be no danger of the syrup's being carried above.

Taking the matter all in all, Mr. Boardman's idea of feeding offers the best solution of the problem as to what we are going to do with short honey seasons—in short, what will enable us to get *all* the honey there is in the field into *surplus* without wasting any of it in brood-rearing. E. R. Root.

Questions AND Answers

CONDUCTED BY

DR. C. C. MILLER, MARENGO, ILL.

[Questions may be mailed to the Bee Journal, or to Dr. Miller direct.]

Moving Bees a Short Distance.

I have a colony of bees that I wish to move, perhaps $\frac{1}{4}$ mile, about May 1. There is another colony in the same yard that will remain. My colony is in a double 8-frame brood-chamber. Can I move them all right so short a distance by simply closing the entrance with wire-cloth, and carry them on a wheelbarrow?

Lombard, Ill.

BEE GINER.

ANSWER.—Yes, you can wheel them that distance without much trouble, providing you have muscle enough and are careful not to tip over your load. Of course you will give them a little smoke before shutting them up. Then within a day or two after moving them you will find that all the field-bees have gone back to the old place, and you will have left in your hive nothing but the young or nurse-bees. So that will leave your colony in much the same condition as though a swarm had issued.

The bumping they get on the wheelbarrow will make some difference, for some of them will mark the new location that would not do so if they were set down very quietly in their new place. But most of the field-bees will go back to the old place, and after trying to find their hive there, will do the next best thing and join the colony that is left there.

If you put up a board before the entrance for them to bump against when they fly out, that will help some, for it will confuse them to some extent, and make some of them mark the new location. But do the best you can, there will be a large number go back to the old place.

So you may as well make up your mind the bees are going back, and act accordingly. Instead of moving the whole business all at once, take only one story, having in it all the bees you can get, the queen, and nearly all the brood. You will

leave on the old stand the one story with a little brood in it, say one frame, and then the returning bees will take up with that as their home. Or, instead of leaving one story, move both, and leave on the old stand another hive in which you put a frame of brood and a few bees. If the day is fine so that bees will fly well, there is no need to leave enough bees to take care of the brood, for enough returning bees will enter to take care of it.

Two to four days after moving, you can take the bees that are on the old stand and add them to those first moved, with the hope that a much larger number will remain where they are put. Being queenless they are inclined to stay better wherever they are put, and especially if given to a laying queen. If you care to follow the matter up, you can again leave a frame of brood in a hive on the old stand to catch remaining stragglers.

Don't forget to make it as troublesome as you can for the bees to fly out of their hive, by putting something in front of the entrance.

Backward Breeding—Granulated Stores.

We had a poor season last year, so the bees had to be fed on sugar syrup in the fall. I winter my bees on the summer stands. The last of March, on a warm, nice morning, I looked them over. Out of 17 colonies one died, 16 were all right in bees, very few brood in 11, and in the other 5 I found the queen but not any brood. The most stores was candied. I did not see any pollen-gathering yet, and working on flowers like other springs.

1. What can be the reason that the bees are breeding so slow this season? Is it the candied stores that cannot be used for brood-rearing?

2. Why did the stores candy more last winter than the years before, when the bees were fed the same way?

3. Will I do right to feed my bees sugar syrup for brood-rearing now? G. R.

Bennet, Nebr.

ANSWERS.—1. Hard to tell. Difference in season may have something to do with it. Granulated honey might be somewhat to blame. In rare cases bees fail to breed for lack of pollen in the hive.

2. Another hard question. Some kinds of honey granulate sooner than others. Some years are worse than others. Some times honey is granulated before the weather is cold, sometimes hardly in all winter. These facts are known, but I'm not sure that any one pretends to tell why. One general principle is that severe cold favors granulation. Stirring or shaking the honey also favors granulation. I've seen it stated that honey was slow to granulate because of a wet season, the idea being that the thinner the honey the less inclined to granulate. I'm inclined to think that the reverse is the truth, for I've seen a crock of honey water on top and solid below, and I have seen it thick and stringy with nut granule.

If you mean that the sugar syrup fed to the bees granulated, then the reason might be the difference in the lateness of feeding, difference in rapidity, or difference in thickness of syrup. If the food is given early, slowly, or quite thin, then it is less likely to granulate.

Questions About Transferring, Etc.

1. I am just starting in the bee-business, having purchased 4 colonies of black bees last month, moved them home on a sleigh two miles, giving them a good shaking up. I bought bees, honey and comb for \$2 per colony; three of them are in "farmer" made 10-frame Langstroth hives, and one in an 8-frame Armstrong. They are very strong colonies, and I should judge that they have 25 pounds of honey to the hive. I don't care for the honey this year as much as for increase. I have bought ten 8-frame dovetailed hives, and I am going to try the Heddon short method of transferring. Is that what you would do if you were in my place?

2. My bees are black. When I transfer, would you advise me to kill the black queens and introduce eight Italian queens.

3. I live in the Sacandaga valley, which is 5 miles wide and 15 long. There are no bees kept here to amount to anything. One man to the east 4 miles, keeps 40 colonies. Do you think I have pasturage for 100 colonies? Basswood grows on the mountains on each side of the valley, also plenty of buckwheat. I am going to run for comb honey only. I expect to winter my bees in a cellar. I have a good one, 40x40-x8 feet.

4. Would May 1 be a good time to transfer?

5. Suppose I move the old hive to a new stand, put a new one in its place, and transfer by Heddon's way, will not the balance of the bees in the old hive desert the brood and go to the new hive which is on the old stand before the 21 days are up? or will they know enough to return to the brood after going out for a flight?

6. Will there be enough brood to be advisable to transfer May 1? I examined my bees to-day, and they are doing finely. They cover both sides of four combs to each hive. The bottom-boards are on the hives, and no cloth over the brood-frames, only a top-story set on, the same as when I got them. P. O.

Northampton, N. Y.

ANSWERS.—1. I hardly know whether I'd transfer them all. If the hives they are in are in good condition, it's possible you might do as well to leave at least part of them right where they are. The swarms would go into new hives, of course, and after a year's experience you would be in better condition to know what to do about transferring them another year.

2. That depends a little upon whether you think more of fun or money. You can have more fun, or more experience, by changing all the queens early in the season. But if the matter of economy is to be considered, it is hardly advisable to change queens till later. The queens themselves will cost less later in the season. There will be less danger of loss in introducing, and if a queen is lost in introducing early in the season, the damage done by having a colony left queenless for some time is much greater than in the time of harvest. At this later time queen-cells are generally plenty, or you can have a supply of young queens on hand. If you Italianize one of them early, then you will have a chance to rear queens for the others. Still, the expense of four queens will not be so very heavy, and if you don't mind the expense you will the sooner have all black blood worked out.

3. I can only guess, but I should think 100 colonies might be well supported at your place.

4. Don't go by the almanac in the matter of transferring. Go by the season, and take the time of fruit-bloom.

5. Of course, you musn't "drive" too close, for if every last bee is taken from the hive there's nothing left for the brood to do but to die. All the field-bees that are left in the old hive will go back to the old stand, but the young bees—that is, the nurse-bees—those under 16 days old, will all stay where they are put, and at this time there are lots of young bees and more emerging every day.

6. Most likely. It isn't a question of how much brood they have so much as a question of the amount of bees. Still, the two go together generally, and if there isn't a good lot of brood it isn't likely there are many bees in fruit-bloom.

Closed-End Standing Frame Hives, Etc.

1. I wish you would give your unbiased opinion about the closed-end standing-frame hive, especially about its merits over the other kinds.

2. Please inform me, if you think favorably, how to fix such a hive to fit under patten slat honey-boxes, *a la* the Root dovetail super. I think a 9-frame, standing-frame hive should fit nicely a 7-frame section super. L. D.

ANSWERS.—1. I have had no personal experience with closed-end standing-frame hives. They have been in use for a long time, and are used by some of the leading bee-keepers in New York State. The one feature that seems to be most in their favor is that the closed ends make the hive more like a box-hive as to warmth, there being no open space for the air to circulate all around the ends of the frames. There's much in being used to a thing, and those who have always used them will prefer them, but taken all in all, I don't believe I should want them.

2. I don't know what "patten slat honey-boxes" are, but I suppose the point you are after is to know how to adjust a super to a hive when super and hive are not of the same size. If the super is shorter than the hive—and some of them are half an inch or so shorter—nail a cleat or cleats on the end of the super to make the super cover the hive. The discrepancy is more likely to be in the width, and I have had hives with supers some three inches narrower. All I had to do was to put the super on the hive, and use a strip of wood to cover the part of the hive left uncovered. No need to fasten it on, just lay it on, and I never knew any harm from rain entering between the strip and the super.

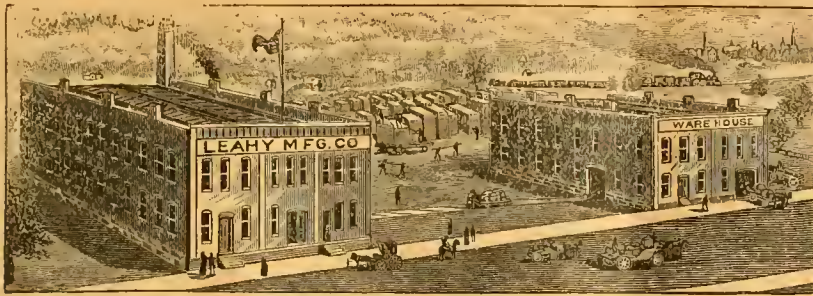

Largest Factory in the West **COMPLETE STOCK.**
 Good Supplies and Low Prices
 —Our Motto.—

READ THIS—Mr. Keyes says: The 100 pounds of Extra-Thin Foundation you sent us! is superior to anything he ever saw; and I think the same. R. L. TUCKER, Wewahitchka, Fla.
 Dear Sirs:—The Sections came duly to hand. Indeed, they are very nice. Yes, sir; they are as good as the best. CHARLES H. THIES, Steelville, Illinois.
 Leahy Mfg. Co.:—I have received the bill of goods. I must say they are the choicest lot of Hive-Stuff I have ever received from any place. I admire the smoothness of your work, and your close selection of lumber. Yours very truly, O. K. OLMSTEAD, Orleans, Nebr.
 Dear Sirs:—The Sections arrived in due time, and are all O. K. so far as examined. They are simply perfection. I can't see how you can furnish such goods at such low prices. I hope you may live long and do well. Yours respectfully, Z. S. WEAVER, Courtney, Tex.
 Gents:—I received the "Higginsville Smoker" all O. K. It's a dandy; please find enclosed stamps for another. Yours truly, OTTO ENDBERS, Oswegatche, N. Y.
 Gentlemen:—I have bought Supplies from nearly all the large manufacturers by the car-load, and I must say yours are as good as the best. Indeed, in many lines they are the best. It is a pleasure to handle them. E. T. FLANAGAN, Belleville, Illinois.
 The above unsolicited testimonials are a fair sample of hundreds we receive. Our prices are reasonable and the "Higginsville Goods" are the best.
The "Higginsville" Goods are for sale by the following parties:
 Chas. H. Thies, Steelville, Ill. E. T. Flanagan, Belleville, Ill.
 Henry L. Miller, Topeka, Kans. E. A. Seeley, Bloomer, Arkansas.
 J. W. Rouse & Co., Mexico, Mo. P. J. Thomas, Fredonia, Kans.
 Fulton & Gregg, Garden City, Kans. W. J. Finch, Jr., Springfield, Ill.
 If you need a Carload of Supplies, or only a Bee-Smoker, write to us. Remember, we are here to serve you, and will, if you give us a chance. **A Beautiful Catalogue Free.**
 Address, **LEAHY MANUFACTURING CO., HIGGINSVILLE, MO.**
 49A *Mention the American Bee Journal.*

General Items.

Successful Wintering.

On Nov. 11 and 12, 1895, I put 118 colonies of bees into my wintering-house, and today I have removed the last of them to the summer stands, not having lost a single colony of the number. I have two house-apiaries away from home, that have wintered nearly as well. The brood-chambers in my home-apiary are 12 by 13 inches, inside measure, and 10 inches high.
 W. J. DAVIS, 1st.
 Youngsville, Pa., March 28.

An Experience with Bees.

This is the third season that I have kept bees. I caught my first and second swarms in nail-kegs and transferred to frame hives, and wintered them on the summer stands. My frames are 13 1/2 x 11 inches, 10 to a hive, and as yet I have no reason to change. Last winter I packed my six colonies on the summer stands with leaves—about 3 inches on the sides, and about 7 or 8 inches on top of the cover, and they are all alive now. From my two colonies, spring count, I extracted 53 pounds of honey, and have about 40 nice extracting-frames with comb in them. My bees are blacks, hybrids, and I have one colony of Italians.
 S. K. LUTHER.
 Olneyville, R. I., March 30.

Bees in Louisiana.

My bees are doing finely. I have only 5 colonies left; two came out of winter quarters overflowing with bees, and the others are very poor, but I expect to make them tip-top this spring. White clover is in abundance here; the peach and plum have bloomed. Bees gathered lots of nectar from the peach. Honey locust is in bloom now. The South is in bloom with spring flowers of all kinds. Bees are working on everything. One thing we have here all the year around is—the infernal bee-moth. Indications show that we will have a good fall crop of golden-rod. Dewberry seems to be the favorite flower of the bees just now, as it furnishes both pollen and nectar. Willow and elm are in bloom also. I expect to get lots of honey this year. I did not get much last year.
 New Orleans, La. JAMES B. DRURY.

CHEAPER THAN EVER

Hilton's White T Supers
Chaff Polished Foundation
Hives Sections Smokers
 And everything needed in the apiary.
 1896 Catalog of 36 pages free.
GEO. E. HILTON,
 13Atf FRENONT, MICH.
Mention the American Bee Journal.



ONE MAN WITH THE UNION COMBINATION SAW
 Can do the work of four men using hand tools, in Rippling, Cutting-off, Mitring, Rabbing, Grooving, Gaining, Dadoing, Edging-up, Jointing Stuff, etc. Full Line of Foot and Hand Power Machinery Sold on Trial. Catalogue Free.
SENECA FALLS MFG. CO.,
 46 Water St., SENECA FALLS, N. Y.
 1A1y *Mention the American Bee Journal.*

Dadant's Foundation in Chicago!

No other Goods kept here.
 Send for Price-List,
CHAS. DADANT & SON,
 118 Michigan St., CHICAGO, ILL.
 13Atf Please mention the Bee Journal.

SECTIONS

\$1.50 a M. 3 M, \$4.25.
 These ARE NOT Seconds, but perfect Sections. As they are not up to our present high standard, we wish to close them out. Sample free. Widths—7-to-foot, 1 15-16 in., and 2 in.
Catalog of Bees & Supplies FREE.

I. J. STRINGHAM,
 105 Park Place. NEW YORK, N. Y.

MOVED TO LARGER QUARTERS!

In order to take care of the business properly at this Branch, we have moved to 118 Michigan St., [3rd Floor], within two blocks of the Northwestern Passenger station, where we've secured larger quarters, making ample room for a Full Assortment. Send along your orders, remembering that we guarantee satisfaction, and at prices as low as the best quality of Goods can be furnished for. **Special Prices** on a lot of Stock we are closing out. Send for CATALOG and a List of Goods at Special Prices.

TRIANGULAR-TOP FRAMES.

We also have a stock of Triangular Top Langstroth Frames at these **Special prices:**
 100 for \$1.00; 300, \$2.70; 500, \$4.00; 1000, \$7.00.
 On all freight orders of \$5 or less, at this Branch, please add 25c. for cartage. **Catalogue Free.**
The A. I. ROOT CO., 118 Michigan St., CHICAGO, ILL.
 Geo. W. York, Mgr. *Please mention the American Bee Journal.*

Down with Adulteration.

MR. EDITOR:—I have just read J. H. Martin's article, entitled, "The Honey Competition Fallacy." It is right to the point. Are we not going to do something about it? Have we any laws about it? If not, are the difficulties so great in the way of getting some effective laws, such as some States, and Canada, have? We want laws compelling all producers or manufacturers of articles of food to label truly the constituents of everything offered for sale, with heavy penalties for violations. Let our "big guns" boom the alarm, and do so in such a way as to wake everybody up to their senses.

You will remember I sent you a sample of honey, for your opinion on it. A man calling himself J. C. Hogarth, of California, has been on the line of the Rock Island railroad selling so-called California honey in 50-pound cans, at whatever price he can get. An Ottawa firm, that had bought 100 pounds from him, found that their customers, who were used to my honey, would not buy it; they had to dispose of it the best they could, and return to mine. It is some of that honey I sent you. Now, who is J. C. Hogarth? Can somebody vouch for him? Some of our leaders, or would-be leaders, have advised us to keep still on the subject. I think it bad advice. We should never keep still until we have stilled the adulterators, or at least until we have

MUTH'S HONEY EXTRACTOR
 PERFECTION
 Cold-Blast Smokers,

Square Glass Honey Jars, Etc.
 For Circulars, apply to CHAS. F. MUTH & SON, Cor. Freeman & Central Aves., Cincinnati, O. Send 10c for Practical Hints to Bee-Keepers.

TEXAS QUEENS.

If you are in need of Queens, let me have your order. Price-List Free.
 8A26t **J. D. GIVENS, Lisbon, Tex.**
Mention the American Bee Journal.

BUY "DIRECT FROM FACTORY," BEST MIXED PAINTS

At **WHOLESALE PRICES**, Delivered **FREE** For Houses, Bars, Roofs, all colors, and **SAVE** Dealers profits. In use 54 years. Endorsed by Grange & Farmers' Alliance. Low prices will surprise you. Write for Samples. **O. W. INGERSOLL**, 289 Plymouth St., Brooklyn, N. Y.
12A13 *Mention the American Bee Journal.*

MURDERED

We have killed high prices. Give me a trial order and be convinced that good Queens can be reared for 50 cts. each. Untested, 50 cts.; Tested, 75 cts. Golden Italians, 3-Banded Italians, and Silver-Gray Carniolana, all the same price. Best of References given.

C. B. BANKSTON,

13Atf **CHRIESMAN**, Burleson Co., TEX.
Mention the American Bee Journal.

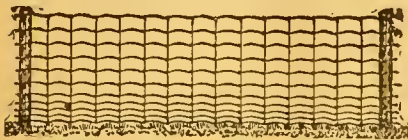

WHEN THE SPRING-TIME COMES.

Behold the springless wire fence; how sprung! Alas! for the hopes of the unhappy owner, what a Fall. Now let the Winter of his discontent be made glorious Summer through the continuous Spring of our famous coil. Ponder these seasonable hints.

PAGE WOVEN WIRE FENCE CO., Adrian, Mich.
WHEN ANSWERING THIS ADVERTISEMENT, MENTION THIS JOURNAL

We did not know that such **Good Goods** could be sold so low as the

HIGGINSVILLE SUPPLIES

just received. We did know that **Comb Foundation** could be sold cheaper, and consequently **started** the reductions, and have **just** made another. Have you seen it yet?

A 32-page Catalogue of everything you need, tells all about it.

W. J. FINCH, Jr., SPRINGFIELD ILLS.
Mention the American Bee Journal.

SUCCESSFUL INCUBATOR
Our magnificent new catalogue giving full information regarding artificial Hatching & Brooding and treatise on poultry raising sent for 4c stamps. Circular free.

Write now. **Dea Moines Incubator Co.** Box 75 Des Moines, Ia.

11A9t *Mention the American Bee Journal.*

California ❄️❄️

If you care to know of its Fruits, Flowers, Climate or Resources, send for a Sample Copy of California's Favorite Paper—

The Pacific Rural Press

The leading Horticultural and Agricultural paper of the Pacific Coast. Published weekly, handsomely illustrated, \$2.00 per annum. Sample Copy Free.

PACIFIC RURAL PRESS,

220 Market St., - SAN FRANCISCO, CAL.

New England Supply Depot !

You can get the most complete Bee-Hive, also other Supplies, at—**H. ALLEY'S**, Room 5, 82 Water St., - BOSTON, MASS.

13Dt *Mention the American Bee Journal.*

obtained laws compelling adulterators to call their stuff what it really is.

What is the use to work faithfully for years to create a home market for honest home product, and at last be undermined and undersold by a mixture of half glucose or more, sold for honey, to unsuspecting purchasers?

I am not jealous of honest competitors, and honest, straight goods—if such can undersell me, well, I say, good for the consumers, we all must live, and the buyers are in the majority; but fraudulent competition is what *riles* me.

Let us awake and do something!
Utica, Ill. A. MOTTAZ.

[Yes, the sample of so-called "honey" which Mr. Mottaz sent us was pretty vile stuff. We pronounced it glucosed, at once. What a pity that we have no good laws that would help put the villainous adulterators where they belong. With the best glucose at one cent a pound, what won't the criminally inclined do when they have a chance? Bee-keepers *must* arouse, united, and then push for anti-adulteration laws. Once having them (the laws), we'll soon start the adulterators on the run.—Ed.]

"Sure Remedy" for Rats.

Mr. Allen Pringle seems to be troubled with rats. The following is a sure remedy for rats, pocket-gophers and chicken lice:

Rats burrow under ground, consequently they have generally a back door and front door to their mansion. Close up one of the doors, and saturate a piece of cotton, or any other soft material, with Fuma-Carbon-Bisulphide, and poke into their hole, or holes, and then close them up tight, and there will be no more trouble with rats.

I would recommend Mr. Pringle to write to Edward R. Taylor, Chemical Manufacturer, Cleveland, Ohio, for his pamphlet on the various uses of Fuma-Carbon-Bisulphide, which also gives prices of same.

Champlin, Minn. VINCENT REEVES.

Working on Soft Maple and Elm.

My bees are in splendid condition, and working on soft maple and elm. I put 12 colonies and one nucleus into the cellar last fall, and took out 11 colonies, good and strong, and one weak colony, and lost the nucleus. The weak colony was one of the so-called goldens. I sent to Texas and got three warranted golden queens in 1894, but I am not satisfied, as they are not the bees for this country, for they can't stand the winters here; and they are not prolific enough, as there was none of the three queens that had over four frames of brood at one time. So give me the leather-colored bees for all purposes.

One of my neighbors has three colonies of bees that I will transfer this spring. They are in boxes 36x18, and 14 inches deep. "Boxes" is what I call them, but there was some fellow that sold them as "patent hives." JNO. H. RUPP.
Washington, Kans., March 29.

Bulletin No. 1—"The Honey-Bee."

In regard to the Bulletin No. 1 on "The Honey-Bee," issued by the Agricultural Department, I wish to say there is no reason why all bee-keepers should not receive the same consideration from their congressmen that we do from ours (Lucien Baker). It is only a matter of writing to them. Or why not have a list of bee-keepers and others interested in the pursuit forwarded by the different State societies? This is a chance in a thousand, to bring our industry before the Congress (and the world), then why not increase the demand for this Bulletin to such an extent that another edition will be necessary? When such an edition is asked for, it will be necessary to

ORIGINAL BINGHAM SMOKERS
Wonderful Record!
HAVE LASTED 17 YEARS.
—BEST ON EARTH.
Always Give Perfect Satisfaction.

My cool Wire Handle and Bent Nose were patented 1892, are the original, my best invention since my open or direct draft Patent, 1878, that revolutionized Bee-Smokers. My Handle and Nose Patent bent all the other smoker noses. None but Bingham Smokers have all the best improvements. If you buy genuine **Bingham Smokers and Honey-Knives** you will never regret it. The "Doctor," 1/2-inch larger than any other smoker on the market—3/4-inch stove, by mail, \$1.50
Conqueror, 3 " " 1.10
Large, 2 1/2-in. " " 1.00
Plain, 2-in. " " .70
Little Wonder, 2-in. wt. 10 oz. .60
Bingham & Netherington Honey-Knives, 80 cents.

T. F. BINGHAM, Farwell, Mich.
7Atf *Mention the Bee Journal.*

PATENT WIRED COMB FOUNDATION
Has No Sag in Brood-Frames
Thin Flat-Bottom Foundation
Has No Fishbone in the Surplis Honey.
Being the cleanest is usually worked the quickest of any Foundation made
J. VAN DEUSEN & SONS,
Sole Manufacturers,
Sprout Brook Montgomery Co., N. Y.

BEGINNERS.
Beginners should have a copy of the Amateur Bee-Keeper, a 70-page book by Prof. J. W. Rouse. Price 25 cents; if sent by mail, 28c. The little book and the Progressive Bee-Keeper (a live, progressive 28-page monthly journal) one year, 65c. Address any first-class dealer, or
LEAHY MFG. CO., Higginsville, Mo.

SUCCESSFUL FRUIT CROWERS
SPRAY THEIR TREES.
THE DEMING SPRAY PUMPS ARE THE "WORLD'S BEST"
Send for complete catalogue and treatise on spraying, mailed FREE. **The DEMING CO.**
Hemion & Hubbell, Western Agts., Chicago, Ill. Salem, Ohio.
Mention the American Bee Journal.

J. W. TAYLOR
—HAS THE BEST—
Italian Queens for Sale
Untested, ready now, 75c. apiece; 6 for \$4.25, or 12 for \$8.00. Tested, \$1.25. Select Tested, best, \$2.00. Pay for Queens on arrival. I guarantee safe arrival and satisfaction.
14A9t **OZAN, ARK.**

Sweet Clover Canada.
At the following prices:
5 lbs. 10 lbs. 25 lbs. 50 lbs.
\$1.00 \$1.60 \$3.75 \$7.25.
Also a quantity of Motherwort and Catnip seed. Prices on application.
EGGS for Hatching. Buff Leghorns, Indian Games, & Light Brahmans. Choice Birds. A breeder for 30 years. Prices on application
JOHN McARTHUR,
881 Yonge Street, - TORONTO, ONT.
15Atf *Mention the American Bee Journal.*

Say, Please Bother Jumbo for Copy of
That Practical Beautiful Jocose Paper,
The PACIFIC BEE JOURNAL.

BEE-KEEPING IN

CALIFORNIA, OREGON, WASHINGTON, NEVADA,
IDAHO, UTAH, ARIZONA, COLORADO.

All Easterners should keep in "touch" on the "LAND OF SUNSHINE"—the **COMING BEE-LAND.**

Address, **PACIFIC BEE-JOURNAL.**
365 East Second Street, LOS ANGELES, CALIF.

\$1 Buys a "ST. JOE" hive during April only, made up, Sections and Starters, no paint. *One only, to new customers, to show you the best hive made.* Satisfaction guaranteed. Say how to ship, and send on your **\$1**

Golden Wyandotte Eggs for hatching, only \$1.00 for 13.

EMERSON T. ABBOTT, ST. JOSEPH, MO.

That Queen-Clipping Device Free!

PLEASE READ THE FOLLOWING OFFER:

We have arranged with the inventor of the new Queen-Clipping Device (Mr. Montette), to offer it to our present subscribers as a Premium for getting new subscribers.

Send us just one new name for the American Bee Journal a year (with \$1.00), and we will mail you the Queen-Clipping Device FREE of charge. Or, the Queen-Clipping Device will be sent postpaid for 50 cts. But why not get it as a Premium by the above offer? You can't earn 50 cts. any easier. Almost every bee-keeper will want this Device. See page 130 (Feb. 27) for full description of it. Complete directions accompany each one sent out. It is a most ingenious and useful article. Address,

GEORGE W. YORK & CO., 118 Michigan St., Chicago, Ill.

The Patent Wood-Veneer Foundation.

Bee-keepers should give it a test, and my All-Wax Foundation. I will guarantee there is no better made, as six years ago I discarded the old way of dipping for wax sheets, and a new invention of my own was discovered, which enables me to make the toughest kind of Foundation; also, no acid used to purify the Beeswax, and it preserves the smell of honey, which is more acceptable to the bees. Now is the time to send wax and have it worked up at low prices. Send for Samples and Catalog with low prices. Wax wanted at 31c cash, or 33c trade, delivered.

AUG. WEISS, Hortonville, Wis.
12A13t Please mention the Bee Journal.

For Sale 50 Colonies of Bees, in Langstroth 10-frame hives. Will deliver on cars here, at \$3.50 each. **J. W. HOWELL,**
15A7t **KENTON, TENN.**

Honey-Clovers & Buckwheat SEED FOR SALE.

We have made arrangements so that we can furnish seed of several of the Clovers and Japanese Buckwheat, by freight or express, at the following prices, cash with order:

	5lb	10lb	25lb	50lb
Alsike Clover	\$.70	\$1.25	\$3.00	\$ 5.75
Sweet Clover75	1.40	3.25	6.00
White Clover	1.25	2.00	4.50	8.00
Alfalfa Clover.65	1.10	2.70	5.00
Crimson Clover....	.55	.90	2.00	3.50
Jap. Buckwheat...	.20	.35	.90	1.25

Prices subject to market changes.

Add 25 cents to your order, for cartage, if wanted by freight.

Your orders are solicited.

GEORGE W. YORK & CO.,
CHICAGO, ILLS.

FIRST-CLASS BEE-SUPPLIES

at ROCK-BOTTOM PRICES. Send for Catalog to **W. J. STAHMANN,**
14A4t **WEAVER, MINN.**

Extracted Honey for Sale!!

The beautiful, white Willow-Herb Honey, in 60-lb. cans, f. o. b. Chicago, at 8 cents per

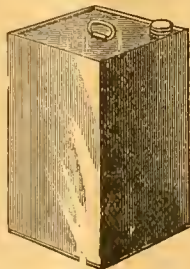

pound, 2 cans (120 lbs.) in a box. Single can, 8½ cts. per pound.

Sample of the honey mailed on receipt of 10 cts. This honey will give entire satisfaction, and is guaranteed strictly pure Michigan Willow-Herb honey. Better order at once, and begu to work up a trade before the new crop comes on. Address,

GEORGE W. YORK & CO.,
CHICAGO, ILLS

W. H. BRIGHT'S

CIRCULAR FOR 1896, describes everything needed in the apary. Bees, Queens, Hives, Sections, Spraying Pumps, and Bright's Comb Foundation, sold at bottom prices. Send for one free.

Wm. H. BRIGHT,
17D4t **MAZEPPA, MINN.**

—LEADS THEM ALL 8 to 24% %—

See reports of experiments with Comb Foundation at the government station, Lapeer, Mich. FREE—large Illustrated Catalog of everything needed in the apary. Full of information. **M. H. Hunt, Bell Branch, Mich.**
5Dtf Please mention this Journal.

explain why, and what has become of the previous edition. Thirty-five thousand families is what is represented by the previous edition, and congressmen will naturally ask:

"Where are these people located, and who are they? Will it pay me, and serve my interests, to countenance, or can I afford to lose their support by ignoring their rights and wishes?"

There is a difference of 70,000 in having and not having this support. Can we as bee-keepers then ignore the chance open before us? There never has been as favorable an opportunity as now to put ourselves in position to ask for future favors. I am one of those who believe in getting all I can, and keeping all I get. I am not in position to apply for a pension, and I do not wish to go to the penitentiary, so the only thing I can get is good laws for my protection and the protection of my business; and to get this favor I will not ask others to do what I am not doing.

Come, bee-keepers, and show your hand. Don't let the chance slip?
Herrington, Kans. **F. W. CAMPBELL.**

Bees in Good Condition.

I have 10 colonies of bees in good condition. I like the Bee Journal very much—could not get along without it.
Hennepiu, Ill., April 6. **F. P. HAM.**

Bees Doing Finely.

Bees are doing finely here now. I have had two swarms already—March 28th and 30th.
ERNEST W. HALSTEAD.
Ocean Springs, Miss., April 4.

Failed to Breed Up Last Fall.

My loss is 5 out of 11 colonies, for want of breeding up last fall. No surplus last year; too dry.
EZRA SMITH, M. D.
Judd's Coruers, Mich., April 1.

Bees in Good Condition.

Bees were carrying in pollen on March 31—two weeks later than last spring. White and Alsike clovers are looking fine. I have 42 colonies of bees in good condition in 10-frame hives.
JACOB WIRTH.
Rickel, Ill., April 4.

Bees Wintered Well.

Bees have wintered well, and the prospect for a honey crop is flattering. My average per colony, spring count, was 42 pounds for last year. I have 12 colonies in very good condition. I would not be without the Bee Journal for twice its cost.

W. E. WHITTINGTON.
Benton, Ill., April 3.

Early Swarming.

My one colony sent out a fine swarm today. Who can beat that? As I wasn't "prepared," I had to house them in a box. I think I have a fine place for bees, as there is an abundance of flora of various kinds—prairie flowers, shrubs and trees. There has been a profusion of bloom for six weeks.
Mrs. M. M. DUNNEGAN.

Mathias, Tex., March 31.

Thought All Would Die.

I have been keeping from 10 to 20 colonies of bees for eight years, but last year was such a poor honey year that my bees barely made a living, and as I was not able to feed them in the fall, I expected they would all die, but a few have come through the hard winter, and I cannot find it in my heart to let them die now, though I am hardly able to fuss with them.
Miss M. I. MILLAR.
Lewistou, N. Y., March 27.

Question-Box.

In the multitude of counsellors there is safety.—Prov. 11-14.

Sections, Supers and Separators.

Query 10.—1. What width sections do you prefer?

2. Two or four slots?
3. How do you fix sections in supers—by use of "section holders," T rests, or how?

4. Would you use "7-to-the-foot" sections without separators?—AFRICA.

Chas. Dadant & Son—1. 1½. 2. Three slots. 3. Pattern slats or T tins.

G. M. Doolittle—1. 1½ inches. 2. Two. 3. Wide frames. 4. No, nor any other.

Dr. J. P. H. Brown—1. 1½. 2. Two slots. 3. By a support similar to the T. 4. I would.

W. R. Graham—1. 1½. 2. Two slots. 3. In crates or section-holders. 4. I don't use separators.

C. H. Dibbern—1. 1½ inches wide. 2. Two slots. 3. On the principle of section-holders. 4. No.

E. France—1. Two inch. 2. Two slots. 3. I use a super with slat bottoms. 4. I always use separators.

Allen Pringle—1. About 1½ or 1¾ at corners. 2. Four. 3. Section "holders." 4. I use separators mostly.

Dr. C. C. Miller—1. I don't know. Certainly not more than 1¾, and less might be better. 2. Two. 3. T rests. 4. No.

Emerson T. Abbott—1. 1½ inches. 2. Four. 3. By use of pattern-slats and follower-boards. 4. I would not use separators with any sections.

Prof. A. J. Cook—1. I have generally used 7-to-the-foot. 3. Wide frames and T supers. 4. Yes, unless I always used separators, which I think is wise.

B. Taylor—1. 1½ inches. 2. I never tried 4 slots. 3. T rests. 4. I do with flat separators. A 7-to-the foot section filled will weigh but ¾ of a pound.

R. L. Taylor—1. 7-to-the-foot. 2. I am satisfied with two. 3. Single-tier wide-frames with separators, or in the Heddon-case without separators. 4. Yes.

Jas. A. Stone—1. 2 inches, or very little less, say 1 13/16. 2. Four slots. 3. By use of section-holders. 4. No. I would have separators between alternate sections.

H. D. Cutting—1. 1½ and 1¾. 2. Two, yet four works nicely with thick separators. 3. T rests, and I want them loose. 4. I never use sections without separators.

P. H. Elwood—1. 1½. 2. Two. 3. Mostly "how"—which means resting on slats in bottom of supers. 4. No, nor any other number to the foot without separators.

J. E. Pond—1. 1½ to 1¾ inches. 2. Two slots. 3. Section-holders or so-called broad-frames. 4. Yes. I think they would work fairly well, if care was taken in putting in the foundation.

G. W. Demaree—1. I prefer sections 1½ inches in width. 2. Two, all the time and decidedly. 3. Adjust them in T section-cases. 4. No need of just 7-to-the-foot. There cannot be any such thing practically, as 7-to-the-foot of soft

wood sections that swell and shrink as the weather affects them. I produce comb honey with and without separators, and I have hardly decided—I prefer both ways.

Eugene Secor—1. 7-to-the-foot and 2 inch, with separators. 2. Two—top and bottom. 3. T rests, section-holders and wide frames. 4. I prefer not to, if I want cratable honey.

J. M. Hambaugh—1. 1¾ or 1½. 2. I have never used four slots. 3. I prefer the Miller T super. 4. The use of separators is preferable, when producing honey for the market.

W. G. Larrabee—1½ inches. 2. Two. 3. I use a slatted-bottom super with separators that amounts to about the same as "section-holders," but I consider them handier. 4. No, I would always use separators.

Mrs. L. Harrison—1. I am using 1¾ inch at present, and rather prefer it. 2. Four slots. 3. I use the Heddon-case. 4. I used 7-to-the-foot sections, in the Heddon-case formerly without separators, and they gave very good satisfaction.

Rev. M. Mahin—1. If separators are used, 2 inches; without separators, 1½. 2. Two. 3. The bottom of my section-case is made of slats 1½ inches wide, with slots similar to those in the sections. The ends of the sections rest on strips resting on the bottom of the case. I have no trouble with burr-combs.

M. FULLERTON,

18 Gansevoort St., New York, N. Y.,
Wholesale dealer in

Honey, Beeswax, Maple Sugar & Syrup

Strictly Fresh Eggs a Specialty.

My trade being direct and only with the retail Grocers and Hotels, gives me a regular outlet at the very best prices obtainable.

Mention the American Bee Journal.



Promptness is What Counts!

Honey-Jars, Shipping-Cases, and everything that bee-keepers use. **Root's Goods at Root's Prices**, and the best shipping point in the country. Dealer in Honey and Beeswax. Catalogue Free.

Walter S. Ponder

162 Mass. Ave.
INDIANAPOLIS, IND.

Mention the American Bee Journal.

BEEES & QUEENS.

Strong, full Colonies of Italian-Hybrid Bees, in Langstroth 9-frame hives, at \$5.00 per colony; 5 to 10 colonies, \$4.75 each. Special low price on larger orders. Bees are in good condition, and are fine honey-gatherers.

Italian Queens—after May 15—Untested, \$1.00 each; 6 for \$5.00; 12 for \$9.00. Safe arrival and satisfaction guaranteed. Reference—George W. York & Co. Address,

F. GRABBE,

LIBERTYVILLE, ILL.,

32 ml. northwest of Chicago, on C. M. & St. P.
Mention the American Bee Journal.

Bee-Keepers' Photograph.—We have now on hand a limited number of excellent photographs of prominent bee-keepers—a number of pictures on one card. The likeness of 49 of them are shown on one of the photographs, and 121 on the other. We will send them, postpaid, for 50 cents each, mailing from the 121 kind first; then after they are all gone, we will send the 49 kind. So those who order first will get the most "faces" for their money. Send orders to the Bee Journal office.

Honey & Beeswax Market Quotations.

CHICAGO, ILL., Apr. 11.—We quote: Fancy white comb, 15c.; ordinary white, 12@13c.; fancy amber, 10@11c.; amber and dark, 7@9c. Extracted, white, 5@7c.; amber and dark, 4@5c. Beeswax, yellow, 30c.

The season for sale of comb honey is now at a close, and only a case or so will be taken for colds, and by enthusiasts on honey as a food (of whom there are too few). R. A. B. & Co.

CINCINNATI, O., Apr. 8.—Demand is good for choice white comb honey, at 12@14c., and slow for extracted, at 4@7c. on arrival.

Beeswax is in good demand at 25@30c. for good to choice yellow. C. F. M. & S.

KANSAS CITY, Mo., Apr. 9.—The demand for comb and extracted is fair. We quote: No. 1 white, 1-lbs., 13@14c.; No. 2, 11@12c.; No. 1 amber, 10@12c.; No. 2, 8@10c. Extracted, white, 6@6½c.; amber, 5@5½c. Beeswax, 22@25c. C. C. C. & Co.

PHILADELPHIA, PA., April 4.—The demand is falling off very rapidly for comb honey, and prices are decidedly lower. Extracted seems to be shipped in from all quarters. We quote: Fancy comb, 11c.; fair to good, 7½@9c. Extracted, 4@5c. Beeswax, 30c. W. A. S.

NEW YORK, N. Y., Mar. 23.—There is a fair demand for white comb honey, and the market is well cleaned up. We have another car now in transit from California. We quote same: 12@14c. Plenty of buckwheat comb is on the market, and same is moving off slowly at 8c. Extracted, all grades, dull, at unchanged prices. Beeswax firm at 30@31c. H. B. & S.

List of Honey and Beeswax Dealers.

Most of whom Quote in this Journal.

Chicago, Ills.

R. A. BURNETT & Co., 163 South Water Street.

New York, N. Y.

HILDRETH BROS. & SEELKEN,
120 & 122 West Broadway.

CHAS. ISRAEL & BROS., 486 Canal St.

Kansas City, Mo.

C. C. CLEMOMS & Co., 423 Walnut St.

Buffalo, N. Y.

BATTERSON & Co., 167 & 169 Scott St.

Hamilton, Ills.

CHAS. DADANT & SON.

Philadelphia, Pa.

WM. A. SELSER, 10 Vine St.

Cincinnati, Ohio.

C. F. MUTH & SON, cor. Freeman & Central avs.

Convention Notices.

ILLINOIS.—The spring meeting of the Northern Illinois Bee-Keepers' Association will be held at the home of Mr. O. J. Cummings, in Guilford, on May 19, 1896. Come, and bring your wives and friends interested in bees. New Milford, Ills. B. KENNEDY, Sec.

CONNECTICUT.—The annual meeting of the Connecticut Bee-Keepers' Association will be held at the Capitol in Hartford, Wednesday, April 29, beginning at 10:30 a.m. Free to all. Mrs. W. E. RILEY, Sec.
Waterbury, Conn.

Catalogs for 1896.—We have received the following Catalogs, Price-Lists, etc., a copy of which may be obtained upon application, always being careful to say you saw their advertisement in the American Bee Journal:

E. T. Flanagan, Belleville, Ill.—Bee-Keepers' Supplies, Bees and Queens.

D. Hill, Dundee, Ill.—Evergreen Specialist.

The Deming Co., Salem, Ohio.—Spray Pumps and Nozzles.

E. Kretschmer, Red Oak, Iowa.—Bee-Keepers' Supplies, Italian Bees, etc.

W. J. Stahmann, Weaver, Minn.—Bee-Supplies, Bees, etc.

W. J. Finch, Jr., Springfield, Ill.—Bee-Keepers' Supplies, Italian Bees and Queens.

Bottom Prices

**BRING US BIG TRADE.
GOOD GOODS KEEP IT.**

If you want the best supplies that can be made at a little less cost than you can buy the same goods for elsewhere, write to us for low prices. 1896 Catalogue now ready—ask for it and a free copy of **The American Bee-Keeper** (36 pages).

Address,
THE W. T. FALCONER MFG. CO.,
JAMESTOWN, N. Y.
Mention the American Bee Journal.

COMB FOUNDATION!

Wax always wanted for Cash or in Exchange for Fdn. or other Supplies. My trade is established on **Low Prices** and the merit of my **Foundation. Orders filled promptly.** WORKING WAX INTO FDN. BY THE LB. A SPECIALTY. Wholesale prices to dealers and large consumers. Send for Prices and Samples to—**GUS DITTMER, AUGUSTA, WIS.** Reference—Augusta Bank. 1Atf
Mention the American Bee Journal.

ROOTS GOODS Prices Reduced on Dovetail Hives and Sections. A full line of Apiarian Supplies in stock to fill orders promptly at lowest prices for Best Goods. 36-page Catalogue Free.
JNO. NEBEL & SON, High Hill, Mo.
Mention the American Bee Journal. 4A26t

I ARISE



TO SAY to the readers of the **BEE JOURNAL** that **DOOLITTLE**

has concluded to sell—**BEES and QUEENS**—in their season, during 1896, at the following prices:
One Colony of Italians on 9 Gallip frames, in light shipping-box \$6.00
Five Colonies..... 25.00
Ten Colonies..... 45.00
1 untested queen. 1.00
6 " queens 5.50
12 " " 10.00
1 tested Queen... \$1.50
3 " Queens. 3.50
1 select tested queen 2.00
5 " Queens 4.00

Select tested queen, previous season's rearing.. 4.00
Extra Selected for breeding, THE VERY BEST.. 5.00
About a Pound of BEES in a Two-frame Nuclean, with any Queen, \$2.00 extra.

☞ Circular free, giving full particulars regarding the Bees and each class of Queens.
Address

G. M. DOOLITTLE,
12A25t BORODINO, Onon. Co., N. Y.

BEES QUEENS Smokers, Sections, Comb Foundation, And all Apiarian Supplies cheap. Send for FREE catalogue. E. T. FLANAGAN, Belleville, Ill.
6A26t Please mention the Bee Journal.

CARLOADS



Of Bee-Hives, Sections, Shipping-Cases, Comb Foundation, and **Everything** used in the Bee-Industry.
I want the name and address of every Bee-Keeper in **America**. No reason why you cannot do business with me. I have Cheap Lumber and Experienced Workmen; a good Water-Power Factory and know how to run it. I am supplying Dealers as well as consumers. Why not you? Send for Catalogues, Quotations, etc. **W. H. PUTNAM,**
1B RIVER FALLS, Pierce Co., Wis.

26c Cash Paid for Beeswax!

For all the **good, pure yellow BEESWAX** delivered to our office till further notice, we will pay 26 cents per pound, cash; or 30 cents for whatever part is exchanged for the American Bee Journal, Books or Seed, that we offer. If you want **cash promptly** for wax, send it on at once. Dark or impure wax not taken at any price. Address plainly,

George W. York & Co., 118 Michigan St., Chicago, Ill.

SECTIONS CHEAP! * * * *

In order to reduce stock we will sell
40,000 4 1/4 x 4 1/4 x 2 40,000 4 1/4 x 4 1/4 x 1 15/16 250,000 4 1/4 x 4 1/4 x 1 1/2
150,000 4 1/4 x 4 1/4 x 1 1/4 80,000 4 1/4 x 4 1/4 x 7-to-ft,
Of our No. 2. One-Piece, Open-Top Sections, at the following **Low Prices:**
1,000 for \$1.00; 3,000 for \$2.50; 5,000 for \$3.75.

These Sections are all of good quality and manufacture, and prices will be maintained for a short time only.

G. B. LEWIS CO., WATERTOWN, WIS.

☞ Be sure to mention the American Bee Journal when you write. ☞

19th Year Dadant's Foundation 19th Year

Is still in the lead, for we use all the latest improvements, including the

NEW WEED PROCESS,

and still make the best goods. Remember that we do not use any acid to purify our beeswax, and that is why our Foundation preserves the smell of the honey and is more acceptable to the bees, than any other. It is kept for sale by

T. H. Strickler, Solomon City, Kansas.
G. K. Hubbard, Fort Wayne, Ind.
L. Hansen, Davenport, Iowa.
C. Theilmann, Theilmann, Minn.
E. C. Eaglesfield, Berlin, Wis.
E. T. Abbot, St. Joseph, Mo.
J. M. Jenkins, Wetumpka, Alabama
John Rey, East Saginaw, Mich.
Vickery Bros., Evansville, Ind.

The Jennie Atchley Company, Beaville, Texas.
C. F. Muth & Son, Cincinnati, Ohio
E. Kretschmer, Red Oak, Iowa.
Joe Nysewander, Des Moines, Iowa.
G. B. Lewis Co., Watertown, Wis.
Jamea Reynolds Elevator Co., Poughkeepsie, N. Y.
Louisiana Bee-Keepers' Supply Manufactory, Donaldsonville, La.
Page & Lyon, New London, Wis.

and many other Dealers. All agree in saying that no goods are better than ours.

Those of our customers who formerly bought through Thos. G. Newman can get our Foundation in **Chicago, Ill.**, by addressing us at **118 Michigan Street**. We keep no other goods there.

We make a specialty of **Veils and Veil Stiffs** of best quality, cotton and silk.

"LANGSTROTH ON THE HONEY-BEE"—Revised.

Bee-Keepers' Supplies, Smokers, Sections, Tin Pails, etc.
Samples of Foundation and Tulle FREE with Circular. Instructions to beginners with Circular. Send us your address.

CHAS. DADANT & SON,

Mention the American Bee Journal.

HAMILTON, Hancock Co., ILL.

Toronto Convention Report has been issued in pamphlet form, and will be mailed from the Bee Journal office for 25 cents. Better have a copy, if you have not read it. Only a limited number of copies were bound.

READERS Of this Journal who write to any of our advertisers, either in ordering, or asking about the Goods offered, will please state that they saw the Advertisement in this paper.

**BEAUTIFUL
Transparent
TOUGH**

and yet
PLIABLE.

**REDUCED
PRICES**

NEW - PROCESS WEED FOUNDATION

—DELIGHTS ALL—

RECENT COMPARATIVE TESTS IN FLORIDA

show that the old-process dipped wax will sag or stretch in the hive nearly five times as much as that by the new Weed process.

Our New Sanded and Polished Sections

and Bee-Hive Material are the Finest Product

that money and machinery can turn out. CATALOG FREE.

THE A. I. ROOT CO., MEDINA, OHIO.

118 Michigan St., Chicago, Ill.

Syracuse, N. Y.

1024 Mississippi St., St. Paul, Minn.

AMERICAN BEE JOURNAL

DEVOTED EXCLUSIVELY TO THE INTERESTS OF HONEY PRODUCERS

ESTABLISHED 1861
THE OLDEST BEE-PAPER IN AMERICA

Published Weekly, at \$1.00 per annum.

Sample Copy sent on Application.

36th Year.

CHICAGO, ILL., APRIL 30, 1896.

No. 18.



How Honey-Producers Can Help Themselves.

BY EMERSON T. ABBOTT.

Honey-producers, falling in with the general drift of things in these times, seem to have gotten the idea that there is only one road to success, and that is by having the Government or some combination of men do for them what they confess by their theories they are not able to do for themselves—namely, make life a success in their chosen calling.

I believe in organization, in unity of action, but I also believe in individuality, in personal effort, and liberty. We are drifting very close to the danger-line, in this matter of organization, it seems to me, when we begin to talk of combining to "compel men" to do what we want done. It is a favorite saying of mine that all I want is health and to be let alone. The man who enjoys the privilege of these two God-given blessings, should be able to at least hold his own, and keep his head above water. If he is not, it will only be an application of the doctrine of the "survival of the fittest" to let him go under. Crutches and Government help should be reserved for invalids, cripples, and the constitutionally weak. A man who enjoys a fair degree of health, and has all the opportunities earth offers to obtain a livelihood, should hesitate a long time before he asks aid from any source. But this is not what I started to write about.

I was impressed by a little incident which I read the other day, from the pen of Mr. Terry, under the head of "How to Increase Consumption." He and a friend sat down to dinner at a hotel. They found little dishes of very nice-looking butter beside their plates, but when they put their knives into it, it was not fit to eat. They also discovered that they had made a mistake and gone to the wrong hotel. They left the butter on the dishes, and left the hotel as soon as they got up from the table. Mr. Terry said that they would have eaten all of the butter on the dishes and called for more, had it been of the best quality, and this would have made a market for more butter; but as it was, the butter was left to glut an overstocked market—overstocked, I presume, with that kind of butter. All the laws and help in the kingdom could not create a demand for goods of that quality. Probably the man who sold it went home complaining that the price of butter had gone down below the cost of production. Perhaps it had, but there is no possibility of building up a market with any such a product.

Cannot the honey-producer learn something from this little incident?

I saw an advertisement in one of our city papers stating that two pounds of comb honey could be had for 25 cents at a certain store. I stepped in to investigate, and when I saw the honey I said, "Is that the stuff you sell two pounds for a quarter?" Turning to another lot, I asked, "What for this?" "Two pounds for 35 cents," was the answer. "This?"

"20 cents per pound. That is first-class. That came from the man in Colorado who knows how to put up honey. We got all he had. No trouble to sell that."

Investigation proved that honey was not so cheap, after all, for the first lot was not fit to put on any market. You say that such honey is put on the market by farmer bee-keepers who do not know anything about the business. Not always: I remember ordering honey once from a leading producer, who has set himself up for a specialist for years, and it was such a poor quality of extracted honey when it came that I had not the face to offer it to my regular customers. I sold it



Mr. J. M. Marvin—See page 277.

to a man down in the country who was looking for some cheap honey. It did not bring very much, but I should have called it dear at any price.

Now, for the other side: I ordered some extracted honey for my own use the other day from the alfalfa regions of Colorado, and I took occasion to say to the party to whom I sent, that the last honey I got of him was very fine, and I wanted some more of the same kind. He wrote back thanking me for the good words I had said for his honey, as I had taken pains to recommend it to others, and then he wrote a sentence which I commend to all extracted honey-producers, viz.:

"I have no trouble now in selling all the honey I can produce, without any advertising."

The italics are mine, but I do not want the reader to fail to get the force of this statement. It is refreshing in these

days when every other man you meet is complaining about how hard it is to sell anything. If the reader could eat some of this man's honey, he would soon understand why he was able to write such a cheerful account of his honey-trade. I know times are close, and people are forced to economize, but I am quite sure that Mr. Terry was not entirely wrong when he said that a good way to increase consumption was to produce only a first-class article.

I am reminded of a remark made by a little fellow when his mother had placed upon the table some bread of the kind of which he was very fond, and had eaten an unusually large quantity: "It pays to make this kind of bread!" There may have been some doubt in his mother's mind as to just how she was to apply his statement, but there could be none, if she had been placing bread on the market for sale, and all who ate it had been of the same opinion as her son.

It pays to make good goods, and when such goods are produced, the first place they should be offered is in the home market. No one should think of going elsewhere until he has worked this all it will possibly bear. The reader may think this advice is becoming an old story, but there are very few home markets that will not stand a little more pushing, if the goods are of the *very best quality*. If one has not done his utmost in this line, I am inclined to think that he will be a little surprised at the results, if he will go to work and push the sale of first-class honey in his own community. By all means do not waste any valuable time waiting for the coming of some great Honey Exchange to do for you what you may be able to do for yourself. There is entirely too much waiting for others to do the work these times. The Exchange may never come to you. If it does, it may not prove the ideal of perfection for which you have been looking. Most men are human, whether they belong to an Exchange or not.

Another thing which many may do to advantage, is to write and talk up the honey-business in their own locality. Here is a field which is bound to yield a bountiful crop, if properly cultivated. I do not mean by this that every beekeeper should aspire to become a professional writer, and in due time attach "Prof." to his name. Such titles are very cheap. Every negro barber is a "Prof.," after the style of some would-be professors. There is a great opportunity, however, for those who are willing to work, not for empty notoriety, but for the real enlightenment of the masses as to the great value of honey as a food product. Such work, if honestly and persistently done, is sure to bring good returns to the honey-producer. As productive employment always brings contentment, perhaps we may hear less complaint of close times, if the majority of producers can be prevailed upon to try these methods of helping themselves.

I trust no one will misunderstand me. I believe in mutual help, but I take a deal of satisfaction in helping myself and asserting my individuality, especially when I come to a really hard pull; and I think others will do the same, if they try it.

St. Joseph, Mo.



Sports of Character in Bees—Longevity.

BY F. L. THOMPSON.

On page 67, Dr. Miller doubts whether honey-bees carry off lilac leaves into their hives. An instance was reported in the *Bienen-Vater* last year in which bees were observed carrying the sticky scales of horse-chestnut buds into their hives, holding them in their mandibles. Another case was reported in the *Leipziger Bienenzeitung*, in which the scales of horse-chestnut buds were seen in the inside of hives, serving to plaster up the cracks made by manipulations in spring. Query: Are not lilac leaves sticky?

Speaking of bees carrying things in their mandibles, I have observed bees carrying dry sugar out of the hives by means of their mandibles. But from Italy comes a report that some bees were observed trying to pack grains of granulated honey (which was outside) on their legs, after they had sucked out and carried away the liquid part. Of course they did not succeed, but they kept up the attempt day after day.

The foregoing are not practical points, but to me they are interesting. Bees and ants, from an evolutionary point of view, have sometimes been referred to as possessing a Chinese sort of civilization—elaborate, but inelastic, with its development all in the past. But such things show that bees at least are still capable of a "sport," and tend to establish the fact that evolution is continuing, which is difficult to realize in our short lives and epochs. Dr. Gallup's observations, on page 824 (1895) may also have a bearing on this point. Perhaps not every colony would act as did the two he referred to.

Perhaps, too, this thought has a practical bearing. The

idiosyncrasies of different colonies in preparing themselves for winter may explain why otherwise similar colonies eventuate differently. One of my colonies builds very thin combs; its sections do not average more than three-fourths of a pound. The strip of honey which it leaves above the brood, besides being thin, is also narrow. Last June I discovered, just in the nick of time, that it was entirely out of stores, though its hive has a 10-Langstroth-frame capacity. Otherwise it is one of the best in the yard, having given me 78 completed sections in the past poor season. Such points should be watched in breeding.

Colonies of bees differ just as other animals do, and as persons do. Why may they not differ in their methods of work? Some people rush about in a nervous, flustered way, but do not seem to get much done, after all. Others get a good deal done without making much fuss about it. It seems to me quite possible that the bees of an excellent but non-prolific colony may not live any longer than others, and yet do a good deal more work.

Again, field-bees may have many other differences of character besides that of a greater or less inclination to sport around the hive, so that I feel like saying that not only is it a difficult question to decide why some colonies are better than others, but that it cannot be decided at all, because behavior in the field may have as much, or more, to do with it than behavior around the hives. This theory cannot be proved—but it cannot be disproved, either.

About the best thing we can do in breeding, besides noting comb-building and other points which are visible, is, I think, to judge by results in surplus. There are too many chances of error in attempting to apply these unproved principles, though in most cases I think it all right to theorize. It is enough that we know a good queen chiefly by the proportion between the surplus honey of her colony and the amount of its brood. That is one good point that the discussion on longevity has emphasized, even though it should turn out that longevity may not account for all cases.

I do not understand why a large size of thorax should make any difference. The big man is not necessarily the best fighter or the best runner. The main requirement is that he be well-proportioned. But we don't know enough about bee-gymnastics to judge when a queen is well proportioned, unless in exceptional cases. Lots of good queens have been only medium in size.

Arvada, Colo.



The Care of Comb Honey—Fumigation.

BY C. DAVENPORT.

In producing comb honey in order to have it stored in the sections in such a way that they can be readily handled and crated without injury, separators are with me a necessity, but I believe bees will work more readily and store a little more honey in the supers if no separators are used, but with me there is always so many of the combs bulged and built out so far that it is impossible to handle and crate them without breaking a good many of the combs, unless the sections are placed in the cases in the same order and exact position they occupied in the supers, and in handling a large amount this is not practicable. But if I was producing only a small amount of section honey, I would not use separators, for where only a small amount is produced such combs as cannot be readily crated can be used at home, or sold to neighbors.

I remove the supers from the hives as soon as the combs in the sections are capped, and use supers to keep it stored in until ready to crate it for market. It is much less work to handle and keep it in supers than it is to take the sections out and set them on shelves, or to put them in boxes, etc. Mine is stored in a warm, dry room, and two pieces of lath are put between each super in order to let the air circulate between them.

If at the time the supers are removed from the hives we do not have time to scrape and grade the sections, we at least take the wedges out and loosen the sections so that they can be easily taken out of a super at any time, for moths are generally very bad here for awhile during warm weather, and comb honey has to be watched pretty closely to keep it from being damaged by them; but it is only necessary to remove three or four sections from a super to find out whether it is or not.

I used to sulphur honey in the room in which it was stored, by burning the sulphur in a kettle, and letting the fumes pervade the whole room, but there would always be some honey that on account of being removed later, or some other cause, did not need sulphuring, so I would have to carry this out-doors or remove it somewhere, for I do not care to

sulphur it any more than is necessary; so I made a box as wide as the widest super I use, and about 10 inches high. A piece of sheet-iron is nailed over the entire top of this box—I think tin would answer as well—and a small door is cut out on one side. Then I have other boxes about 6 inches high without top or bottom, the size of the different supers I use, to set over the first box. A hole is cut out of each side of the top box, and a piece of glass fastened in.

When I wish to sulphur honey I set this iron-covered box right in the honey-room, put some sulphur on the center of the iron top, then take one of the top boxes, the size of the supers in which the honey is, and set it on top of this sheet-iron, then set the supers on this, and tier them up ten or more high, as the case may be, and put a cover on. A small lighted lamp is put through the door in the side of the lower box, so that it will be right under the sulphur, and for awhile through the glass in the upper box one can see how the sulphur burns, and regulate the heat as needed. This is much the easiest and most effective way to sulphur honey that I have ever tried. By leaving the windows of the room open it will not affect the rest of the honey, and no one need be afraid but what they can kill the moths by this plan, even if the supers and cover do not fit very closely; but it takes much less time and sulphur by this plan, and one has to be *very* careful not to use too much sulphur, or to leave the supers on too long, for if they do the honey will be colored.

Last summer we got but very little white honey here, and while I was away from home an inexperienced hand undertook to sulphur some honey by this plan. He took 11 supers of choice white honey and colored the combs and also the wood of the sections nearly as green as grass. I did not know what to do with them, but I thought perhaps soaking them in water might remove the stain, so I took the gearing out of one of the extractors, then set as many of the sections in the can as I could, and then filled it up with cold water in the evening. The gate was opened, and this water allowed to run out. It was then filled up with fresh water, and in the morning every particle of the coloring was gone from the combs and wood also, but the water caused the wood to swell, and a good many of the combs were nearly detached from the sections. These were placed on the hives again, and the bees soon fastened them all right. But if any have to be returned to the bees to be fastened in this way, I found out that if it is at a time when no honey is coming in, one has to use care and select colonies that have the brood-nest well filled, or else some of the honey in the sections will be carried below. If I had been careful about this, I would have saved all those sections without much loss.

With one of those boxes that I have just described, it is very easy to kill moths in brood-combs. All one has to do is to put some sulphur on the iron top, then pile on the hives and light the lamp, and no matter how big the worms, or how many there are, they can be killed in a very short time.

If one prefers, such a box can be set out-doors while the sulphuring is being done, and if there is not much wind, there is no need to put anything around the cracks between the hives, even if they do not fit very tight.

A NEW KIND OF TRAP FOR SWARMS.

In my next I will describe a new kind of trap to be used at swarming-time, which differs somewhat from those in general use, for while this trap when attached to a hive catches and confines a queen when a swarm issues, whether she is a laying queen or a virgin, it does not prevent the drones from leaving or re-entering the hive, for to do so neither they nor the workers have to pass through zinc. It appears that this trap will also allow a virgin queen to go out to mate, and then re-enter the hive. The trap is very simple in construction, and anybody can make it. Southern Minnesota.



The House-Apiary—Eastern Shore Notes.

BY "MORTON'S BROTHER-IN-LAW."

Mr. J. H. Andre, on page 806 (1895) asks if the house-*apiary* isn't more objectionable than the chaff hive, because the sun's heat cannot penetrate the house and two inches of shavings besides the single wall of the hive. I cannot see why there should be any difference. But why does Mr. Andre desire the sun's heat to affect the temperature of the interior of a hive? Isn't that one of the main causes of spring-dwinding? It causes the bees to come out and fly when it is too cold to safely do so, and many never get home again.

In this connection, an incident came under my notice last spring in northern Pennsylvania (I am something of a "Rambler" myself), which will bear telling.

In visiting an apiary of about 25 colonies, I found the bees all fastened tightly in their hives by a cigar-box nailed over the entrance, with wire-cloth over one side of it. It was well along into warm weather, too, and the bees had been flying freely on several occasions previous to my visit. The proprietor explained that he had noticed bees come out too early and died in the snow, so he "fixed 'em last fall that-a-way, and they are all snug and safe yet." That was a new way to me, and I urged him to release them right away, and give them a chance for life. To my surprise their long confinement had not injured them, as far as I could discover, and two weeks later those bees were working as well as you could ask them to—and he only lost two colonies, one of which was queenless.

To the bee-crank, this "Eastern Shore" (as they call that part of Maryland lying east of the Chesapeake Bay) possesses some interesting features. Oysters is their main industry, and honey cuts a very little figure. In Easton (the county seat of Talbot county) I found three sections of white clover honey which the grocer informed me had been plenty of stock for his trade for a month (two for a quarter)—and no other man kept honey at all! The town has about 5,000 inhabitants, and is a wealthy, stylish place surrounded by a fine country, where the majority of farms are on a water front, so Mr. Farmer can raise oysters, crabs, fish, terrapins, wild ducks, etc., as well as corn and wheat.

There are a few up-to-date bee-keepers in this county, but lower down the peninsula, in Dorchester and Wicomico counties, the great majority of bees are in "gums"—12x12x36—(that's standard!) and they "rob" once or twice a year—that is, by taking off the top of the hive and digging out combs as far down as they wish.

The wintering problem doesn't seem to bother any one down there. If that big bee-man from York State—who uses a 3-inch rim, a chaff hive, and a cellar just 45° for 160 days—could see how bees will "paddle their own canoe," and come through the winter in fine condition—with perforated zinc for a cover (upward ventilation, you see), or the end of the hive so rotted out that it fell away, exposing combs and bees to the naked eye, and yet do well the following season—he might decide to emigrate to "de Eesten Sho'."

Moths are the anxiety—not wintering—in this "neck of the woods." Mr. Radcliffe thinks his chickens have a checking influence with this pest. Morton seems to have a similar notion, for he turns his flock of Golden Wyandottes into his bee-yard every evening, and it is short on moths—very!

I was informed that there was "right smart o' bees" on "Hungry Neck," and went there to investigate. The first party interviewed had "right smart," but did not know exactly how many "gums" he did have, but "reckoned" less than 20.

No. 2 was a woman; also had "right smart"—couldn't say how many.

Mr. R. had seven or eight behind the house, and 10 or 12 over by the barn. He did not know just the number. My companion told me that it was considered unlucky to count the "gums," or to sell any. To buy bees on "Hungry Neck," you must make arrangements for the owner to go away from home; then you can go and take them, and leave the pay where it can be found.

Another strange notion was to tell the bees (*in a whisper*) when a death occurred in the owner's family, or the bees would die, too!

One bee-keeper told me that he thought a cross between bees and fireflies would result in a critter that would work night and day. That is "seeing" the *Apis dorsata* man, and going him "one better." St. Michaels, Talbot Co., Md.



Comb Honey vs. Extracted, and Wintering.

BY CHAS. DADANT & SON.

We have received the following letter, desiring our experience on the subject:

TRINIDAD, COLO.

TO CHAS. DADANT & SON:—At the meeting of the Colorado Bee Keepers' Association, held in Denver, in January, one of the prominent honey-producers in the State advocated earnestly the production of comb honey instead of extracted, and asserted, as an objection to working for extracted honey, that the bees become so eager to store honey in the upper story that they neglected to provide themselves with sufficient stores in the brood-chamber to last them over winter. I have not had much experience in producing extracted honey, while you have been working for it for years, so I ask that you will be kind enough to inform me, if you have such trouble, whether you have to feed the colonies from which you have extracted honey, every winter. If not too much trouble, please give me the benefit of your experience. F. O. BLAIR.

This is another instance of the inferiority of the shallow frames over the deeper style. A colony, which is located on 8 or 10 ordinary Langstroth frames, finds itself crowded for breeding-room in the brood-chamber, and when supplied with a large amount of empty combs, in the upper story, the bees naturally are quite prone to take advantage of the space thus furnished, by placing all of the honey in those upper combs. This leaves more breeding-room for the queen, as she remains in possession of all the space below; but the result is that, for the winter, the brood-combs contain too little honey, unless the cooler weather, or the lessening of the yield, in a gradual manner, warns them sufficiently of the approach of cold weather to induce them to place the honey in close proximity to the brood. The Italian bees are more careful in this particular than either the blacks or the hybrids, and are less likely to be caught unawares; but with the shallow hives, in many cases, if only the lower story is left for winter, it will be found that, when extracted honey has been produced, in combs already built, and consequently of easy access, the bees have not enough honey to last them even through the cold weather. As a matter of course, in comb honey production, this happens less often, for combs in sections are considered by them as too remote from the brood, and of uneasy access to the swarm, owing to the numerous partitions between the sections. Then, also, they have to build the combs; and in the fall, as we all know, they build only as much as is absolutely needed on the spur of the moment, and it is filled as fast as built.

When we consider the actions of the bees, in the comparison between comb honey production and the production of extracted honey, we must take one fact into consideration, to which the attention of the bee-keepers was first called by Oliver Foster. It is, that bees dislike to place their surplus in any part of the hive which is not of direct and easy access. In a state of nature, the bees harvest honey for themselves only, and they wish it where they can reach it, not a few at a time, but in a mass. They want this honey above the brood, and where they can at any time, in very cold weather, have it within the cluster, without having to move the cluster in other than an imperceptible motion upwards. The sections are not at all suited for this purpose—they are man's device, for his own convenience, but if the bees could talk they would surely give us to understand that they dislike these small cases which divide the colony, if they must go into them, into fractions that could not withstand the cold. Being unable to speak, they make it plain to us, by their reluctance in working in sections. That is why they are so much more eager to use extracting-combs that seem to them only a continuation of their brood-combs upwards.

There is, however, we think, a method by which one may produce extracted honey over shallow brood-chambers without fearing to have too small a quantity placed in the brood-combs. This consists in crowding the bees, towards the close of the honey crop, so as to compel them to reduce their breeding, and place the honey in all available cells. A knowledge of the climate and of the probable duration of the honey crop in the locality is necessary, of course. It is necessary in every case, if one expects to make the business a success.

In an ordinary season, where the crop diminishes steadily, as the cold weather approaches, there is no necessity to give the bees any warning, for they, of their own accord, usually then crowd the queen out of her breeding-room; neither is it likely to induce natural swarming, for at that time her fertility is lessened, and the need of laying does not impose itself upon her as it does in the beginning. She is also evidently tired of it herself, and does not resent the difficulties which she finds in the way, as she would in the beginning of the season.

With the deeper frames that we use, we have found no difficulty on this score—except in two or three extraordinary seasons, when the crop was cut off all of a sudden by a cold spell, early in the fall. Usually there is a full supply of honey in the upper portion of the brood-combs, when there is a crop at all. The combs that we use, being about two inches deeper than the regular Langstroth frames, this difference, it will be readily understood, is sufficient to make room for a plentiful supply. But we think it always advisable, in the fall, not to give the bees more room in the upper stories than they are likely to fill readily. In the Italian bees, the propensity is very much in the opposite extreme, and it is often the case that they crowd the honey so in their brood-combs that there is not enough room left to secure brood enough for a good winter population.

Hamilton, Ill.



Every Present Subscriber of the Bee Journal should be an agent for it, and get all others possible to subscribe for it.

No. 3.—Producing Comb Honey in Michigan.

BY W. Z. HUTCHINSON.

(Continued from page 242.)

In the production of comb honey the use and non-use of comb foundation is an important feature. When bees are handling honey, as they are in the working season, there is more or less of what might be called involuntary wax-secretion. Unless there is an opportunity to use this it is wasted. When honey comes in slowly it is quite likely that sufficient wax is secreted, and that there is abundant time in which to make it into comb, to furnish storage for the honey that is gathered. As the flow increases, honey must be consumed expressly for wax-secretion. Whether such consumption is profitable I am not able to say. The amount of honey consumed under favorable conditions in producing a pound of wax, is a difficult point to decide definitely, but there is no doubt that it is much less than many people suppose. Just how much of the honey consumed goes to support the life of the bees, and just how much is made into wax, is hard to find out. The old estimate of 20 pounds of honey producing one pound of wax is decidedly an error. Later estimates, that place it at five to seven pounds for one pound of wax, are probably much nearer the truth, and show that the consumption of honey even for wax-secretion is not so very expensive. As the flow of honey increases, a point is finally reached where wax cannot be secreted and combs built with sufficient rapidity to furnish storage for the honey. When this point is reached—possibly before—comb foundation can be used with profit.

As a rule, I have never found it profitable to allow the bees to build their own combs in the sections. In a locality where there was only a slight flow, but one that lasted a long time, such a course *might* be followed with profit, but, as a rule, the honey harvest of this locality is short but copious. The only place in which I have found it profitable to allow the bees to build their combs unaided is in the brood-nest of a newly-hived swarm. The profit here does not come so much from the saving in comb foundation, although that is quite an item, as it does from the conditions brought about whereby the bees are induced to store their honey in the supers instead of in the brood-nest. I would give away drawn combs before I would hive a swarm upon them when working for comb honey. The bees will do but little work in the sections until the combs in the brood-nest are filled, and sometimes they won't then. The combs are so full of honey that there is little room for brood. Newly-built comb is always ready for brood-rearing, but the cells of old comb must be cleaned and polished before the queen will lay in them. No such polishing is needed for storage purposes, and, if the yield is good, a large share of the brood-combs will be filled with honey before the queen fairly commences laying.

When there are no combs in the brood-nest, simply starters of foundation, no honey can be stored in it until combs are built, and the honey must from necessity be stored in the sections (set over from the old hive) until comb is built in the brood-nest. Just as soon as a few cells are completed, the queen, being kept out of the supers by an excluder, is ready with her eggs, and continues to follow up the comb-builders. The result is that nearly all of the honey goes into the sections, while the combs in the brood-nest become almost solid with brood. The hiving of the swarm upon the old stand, the contraction of the brood-nest, the Heddon method of preventing after-swarming, compelling the bees to build their own combs in the brood-nest—all these combined throw a great mass of *willing* workers into the sections. These bees have swarmed. The fever is over and passed, and their whole energies are now bent to the gathering and storing of honey. The foundation in the sections gives them an opportunity to store the honey as fast as they can gather it, the tiering-up of the supers allows them plenty of time in which to ripen and seal it, the building of comb in the brood-nest gratifies their natural desire for comb-building, and all goes as merry as the marriage bell. I am satisfied that for this locality no other system of management will give so large yields of surplus comb honey.

Very excellent results may be secured by hiving swarms upon full sheets of foundation; far superior to what may be secured by using drawn combs, but not equalling those that come when only starters are used in the brood-nest. There is more difference in this respect between combs and foundation than there is between foundation and starters only. Of course, the foundation can be drawn out into combs in two or three days, but during even that short time the bees have begun storing their honey in the supers, and, having made a beginning, they are inclined to continue the practice.

To this plan of management there is just one objection,

viz.: that perfect combs are not always built in the brood-nest. They may be crooked, or bulged, or drone-comb may be built. The last is the greatest difficulty. When using the Langstroth hive and contracting to only five frames, I never had any difficulty in getting straight combs. The brood-nest was so narrow at the top that all of the combs were commenced at once, grew at the same time, and were brought down to completion as straight as so many boards. With the new Heddon hive the top of the brood-nest is wider, and the center combs are more likely to be commenced some little in advance of the outer combs, and bulging is sometimes the result.

Drone-comb is the result of either an old queen that cannot keep pace with the comb-builders, or that the bees are thinking, perhaps, of superseding, or of using a brood-nest so large that the bees hatch from the first-laid eggs in the center of the brood-nest, and the queen returns to re-fill the cells so emptied before the brood-nest is filled with comb, and when comb is built for store-comb (which would be the case if the queen were not at hand to fill it with eggs), it is quite likely to be drone-comb if honey is being brought in quite rapidly.

As before mentioned, this system of management does not leave the swarm in the best condition for winter. If there is a fall flow, this condition can be easily remedied, simply by adding more combs and allowing the bees to breed and store honey to their heart's content. The same result can be obtained by feeding, and in those localities where natural stores do not always prove wholesome for winter, this lack of stores is really an advantage, as there is no extracting to be done—simply the feeding of sugar. To find bees short of stores in the fall simply because the white honey has been stored in the sections, is not objectionable, as the lack of honey can be supplied with sugar syrup costing only about one-third as much as the honey will sell for. What course to pursue after the white harvest is past will depend upon circumstances, such as whether there is a fall flow, whether it is suitable for winter stores, whether an increase of colonies is desirable, etc. I favor uniting the light colonies soon after the sections are off, as this gives an opportunity for discarding imperfect combs and poor queens, furnishes abundant combs and bees, and lessens the amount of feeding that must be done.

In the next article, "feeding back" will be explained.
Flint, Mich.

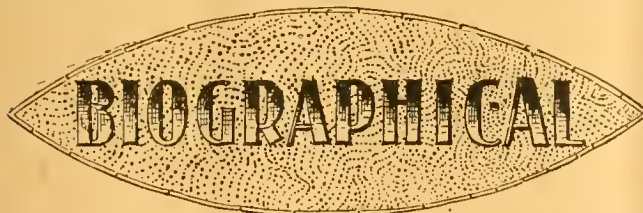

MR. J. M. MARVIN.

James Monroe Marvin, the subject of this sketch, and whose photograph appears on the first pages of this issue of the American Bee Journal, was born at De Ruyter, Madison county, N. Y., July 4, 1830. In 1844 he, with his parents, moved from New York to St. Charles, Ill., and he has lived in or near this city from that time up to a recent date. In his early life Mr. M. followed the business of painting, but during that period he became greatly interested in both bees and flowers.

During his earth-life few men enjoyed a wider or better circle of warm personal friends. In business matters he was highly respected for his sterling integrity. He was of a bright, cheerful and sunny disposition, and was always ready and willing to do anything in his power for the happiness or advancement of his friends and acquaintances. He would strip the blossoms from his choicest plants for the friends of the departed, and without a thought of a pecuniary remuneration; and, when necessary, would cheerfully divide the contents of his purse with the living. He was seldom known to speak an unkind word of any person, and, if treated ill, would simply say, and with a smile: "He couldn't help it!" During the entire period of his life it is not known that he had an enemy.

As a practical, progressive bee-keeper he attained a very high position among the fraternity, and for many years his opinions on bee-culture were highly respected by all who knew him. Just before and during our Civil War Mr. Marvin was without doubt the most extensive bee-keeper in Illinois. At

one time his home apiary contained nearly 600 colonies of bees. Up to 1862 all of his bees were natives, and in box-hives. In 1862 he adopted the Langstroth hive and the Italian bee. In the course of two or three years his large apiary had undergone a radical change. For several years thereafter he secured each year many tons of comb honey. In 1868 he purchased a honey-extractor, and then for a number of years confined himself mainly to the production of extracted honey. Tons and tons of honey were thus secured each year. Finally *foul brood* made his apiary a visit, and as no attempt was made to fight the disease, his colonies began to disappear rapidly, and soon all were destroyed. For the past few years Mr. M. had taken but little interest in bees, but instead he gave special attention to the growing of small fruits and the production of new varieties of seedling grapes. His vineyard at the present time contains a number of very promising seedlings, but what will now become of them is one of the unsolved problems.

For many years Mr. Marvin was firm in the belief that this earth-life is simply a preparatory state to a better and an unending existence, and he tried to live accordingly. He often said he was ready at a moment's notice to bid adieu to earth-life, and that when the time came for him to depart he was in hopes that he would not be afflicted with a long and painful illness. His desire in that respect was gratified, for he departed this life very suddenly on Friday, March 5, 1896. While eating supper, and apparently in his usual health, he was taken with severe stomach pains, and in less than an hour thereafter he was in spirit-life.

Mr. Marvin left no family—he being a bachelor—but he left one sister and three brothers, besides a multitude of friends and other relatives to mourn his unexpected exit to the mysterious beyond.

M. M. BALDRIDGE.

St. Charles, Ill.

Questions AND Answers

CONDUCTED BY

DR. C. C. MILLER, MARENGO, ILL.

[Questions may be mailed to the Bee Journal, or to Dr. Miller direct.]

To Those Who Desire Answers by Mail.

Notwithstanding I have more than once said in print that I cannot make answer by mail, I still get a good many requests of that kind, and there seems to be a feeling that a stamp enclosed puts one under obligation to send a written answer. A little thought ought to show the unreasonableness of this. If I answer one by mail there's no good reason why I should not answer another, and as in most cases it would be a little more desirable to have an answer by mail sooner than it could be had in print, very few would wait answers in print, and a large part of my time would be taken up writing letters. I'm glad to answer as well as I can in print, for in that case I'm paid for it, and many others have the benefit of the answer, so when you ask for an answer please always say in what place you want the answer, and don't expect an exception to be made in your case.

I know it often seems as if a man must be very unaccommodating who will not answer a question by mail that requires only a few words, but sometimes an answer of three words may require an hour of looking up the matter, and, even if it didn't, there's no reason why you should be treated any different from others.

C. C. MILLER.

Large Hives and Swarming.

I am troubled by my bees swarming too much every season. I am using the 8-frame hives as recommended by so many, and find by putting two together (making a 16-frame

hive) that my queens fill 12 to 14 frames solid with brood. Now will using this 16-frame (two-story) hive prevent swarming? and will I get as much comb honey per hive? What do you think of a 16-frame 2-story hive for a brood-chamber, if they average 13 frames solid brood to the hive?

J. B. G.

ANSWER.—You have struck on one of the unsettled questions. Some will tell you that with 16 frames and 13 frames of brood you'll find the bees will not work much in supers. Others say they will. I haven't had a chance to settle the matter from my own experience, as there has been no crop here for the past two years, but if you keep 13 frames well filled with brood I'd at least let them have the chance to try what they'd do in supers with 16 brood-combs. The Dadants claim that with their large hives they don't have five colonies swarm in a hundred, and the probability is that you'll have very much less swarming with 14 or 16 frames than with 8. If you have your swarms in a single story they'll give you more surplus from the early harvest, but whether hiving on two stories may not be more profitable in the long run is a question. Possibly you might do well to try a few cases of reducing to one story after the early harvest had fairly begun, and then restoring the second story at the close of the early harvest. But you would likely have more swarming by that.

What Hive to Use.

What kind of hive do you use, or would you recommend?
J. B. W.

ANSWER.—I'm trying to find out what hive I want myself, and have some 11-frame hives in use, besides the 8-frame hives I've had for a good while, but most of the new hives I've got lately are the 8-frame dovetail, and I'm in hopes they may be satisfactory by running them part or the whole of the year in two stories.

The Lizard a Bee-Enemy in Brazil.

I am now settled in Olinda, in Brazil, 8° south of the equator. My bees have much to suffer from the lizards that hide themselves under and near the hives, and snap the harmless pets when striking near the ground to enter their homes. What is to be done to remove that enemy?
M. E.

Olinda, Brazil, March 1, 1896.

ANSWER.—I've looked over all the answers I have now in stock, and the only one that seems to fit the case is, "I don't know." Possibly setting the hives up on stakes a foot high, with a good, wide entrance-board for the bees to alight on. Perhaps some one of successful experience will be kind enough to offer something to help out.

Number of Bees in a Quart.

How many pints or quarts of bees will it require to make 4 pounds? There is a man that wants some 2-frame nuclei, and 4 pounds of bees. I have no way to weigh them, only by guess or measure. I want to give him plenty, and would rather give him ½ pound too much than not enough.

J. H. S.

ANSWER.—It isn't an easy thing to be sure about bees either by weight or measure. A good deal has been said and written as to the number of bees in a pound, but I don't believe any man living can tell how many bees are in a pound weighed out before him. It may vary all the way from 3,000 to 10,000. In the first place, there's a difference in the different kinds of bees. Cheshire found that 7 Carniolan workers weighed as much as 10 Cyprians. So take the smallest and bring them down to the starving point, and you may have 10,000 in a pound, while the largest well crammed with honey may go only 3,000 to the pound. For ordinary purposes, it is quite common to consider 5,000 a pound, when bees are not well filled. Less attention has been given to the number in a quart, and I don't believe you will find anything on record that will give any very satisfactory answer. When you come to actual practice, it's doubtful whether you'll want to know anything about the number of bees in a quart, or how much a given number of pounds will measure when measured in a quart measure. The variation would probably be such as to make your measure very unreliable. Get the exact weight of a quart of bees, and in five minutes later it may weigh differently. If the bees are cold and quiet when first weighed, they will be closely packed together, and there will

be a large number in a quart. Then as they become excited and warm up your quart will swell.

As already said, you probably will find it a very difficult thing to get bees to stay in a quart measure long enough to be measured. After you try it I think you'll be glad to turn to the weighing. If you have no convenience for weighing, go to the nearest store and have them weigh whatever you intend to put the bees in. Then when you have your bees fastened in, have them weighed again. Then charge in proportion to the weight, or else fill in a few more if the weight is short. But every bee-keeper who sells honey would do well to have something with which he can weigh.

Probably a Wild Bee.

I send you an insect, of which I found hundreds in my bee-hives this spring. Please tell me what they are, their use, name, etc.
L. C.

ANSWER.—The specimen sent, as nearly as I can judge from its dried and crushed condition, is one of the small wild bees. I'm not entomologist enough to give you its correct name, if indeed I'm right as to its being a bee at all. If it's a bee, it probably came to get some chance at the sweets it smelt in the hive.

Hunting Wild Bees.

1. What is the best bait to be used in summer time when flowers are abundant, in luring or tracing wild bees to their home?
2. What is the best method of hunting wild bees in summer?
E. S. G.

ANSWERS.—1. I don't suppose there's anything better than honey, and if I should venture a guess as to the kind of honey, I should say that with the strongest odor. Making a smudge by burning old comb is practiced by some to get the first attention of the bees.

2. I've no personal experience in hunting bees, except going with A. I. Root a short time one day, and I suspect he wished I was out of the way, but I suppose the orthodox way is to line and cross line. Establish a line by watching which way the bees fly after fairly at work, then go some distance in the same line and try another spot, and so on until you come upon the place. Or, after having one line established, start the bees to work at another spot outside your first line, and then try to find the place where the two lines cross.

You'll probably find it a very difficult thing to get bees to work on bait when flowers are abundant.

Using Old Combs—Cutting Out Queen-Cells.

1. There is a man in this place who had six colonies die for want of food. The boxes or hives are full of empty comb from one end to the other. Would any of this comb do to use? It seems to be all right.

2. Mr. Newman tells in his book how to prevent bees from swarming, by cutting out the queen-cells. I don't understand it rightly. I don't know what time in the spring to do this, nor how often.

It is very windy here, and everything is fresh and green, but bees are working right along, rain or shine. We have had hardly any winter.
R. W.

Coal Gate, I. T., April 11.

ANSWERS.—1. The old combs are all right to use again, and are valuable. Even if they're not entirely clean and nice, the bees will make a nice job cleaning them up, only if they're very bad don't give too many of them at a time to the bees.

2. Cutting out queen-cells will not usually prevent first swarms, although it may sometimes. But second swarms may be prevented by cutting out all the cells but one. Lift out the frames about 6 or 7 days after the swarm issues, and break off or cut out all the queen-cells but one, saving one of the largest and best looking. But you can generally prevent the issuing of second swarms in a way that has been many times given. When the swarm issues, hive it on the old stand, and set the old hive close beside it. In six or seven days move the old hive to a new place a rod or so away, and a large number of the field-bees will join the swarm, and this will weaken the old colony so much that it will in all probability give up all thought of swarming. You will make the matter more sure if you move the hive at the time of day when the bees of the old hive are out for a play spell, just before the young bees begin to return to the hive.

Question-Box.

In the multitude of counsellors there is safety.—Prov. 11-14.

Winter "Honey"-Production—Will Old-Time Honey-Seasons Return?

Query 11.—1. Could bees produce honey in January, if they were kept in a warm building and fed bountifully on sugar syrup? I am told it is being done here in Ohio, and the honey sold for one-fifth the price of genuine comb honey.

2. Do you think the time will ever come again when bees will do as well as they did 10 or 12 years ago? I mean in the locality of Ohio.—COLUMBUS.

G. M. Doolittle—1. This is a "fake." 2. Possibly, if the same conditions exist.

R. L. Taylor—1. I guess not. One-fifth the price! Poppycock. 2. Yes, surely.

W. R. Graham—1. Bees cannot make honey out of sugar. 2. I see no reason why they should not.

Prof. A. J. Cook—1. Not long. The bees would soon go where the wildwood twineth. 2. I do not. Man destroys more bloom than he adds.

Rev. M. Mahin—1. No. 2. I do not know how it may be in Ohio, but I do not expect them ever to do as well in Indiana as they did in earlier years.

B. Taylor—1. I don't believe they could. 2. I do not know. Here in Southern Minnesota I have but little hope of again reaping old-time honey-crops.

Mrs. L. Harrison—1. No! Honey is the product of flowers. The Creator never intended bees to be fed like pigs. 2. Solomon says, "What has been will be again."

W. G. Larrabee—1. I don't know. I am afraid there is some mistake about this, for the sugar can't be bought for one-fifth the price of comb honey. 2. I don't know, but I am afraid not.

J. M. Hambaugh—1. No. It would simply be sugar syrup, and should receive the condemnation of all honey-producers. 2. In some localities, yes; others, no. Generally speaking, I fear not.

E. France—1. No. Bees do not make honey if you feed sugar syrup. The bees will store it the same as you give them. 2. No. The timber is cut off, the fields are cultivated, the old-time bee-pastures are destroyed.

H. D. Cutting—1. If you know just "a little bit" about bees, does it look reasonable to you? Don't believe it for a moment. 2. I will not venture an opinion, but I would like to see two wet seasons in succession.

C. H. Dibbern—1. I see no reason why "honey" could not be produced as suggested in January, but I am sure it would not be profitable at double the usual price. 2. Yes, the good years will surely come again.

G. W. Demaree—1. Certainly not. It would be out of "season" in the month of January for bees to build combs if the thing was possible at all. It is evident

that that scientific "sugar-honey" idea—bees "making honey" out of sugar—will "bear fruit" for some time to come. 2. It will depend much upon the peculiar turn agriculture may take. I don't know about Ohio. But here in blue-grass Kentucky the tobacco crop is destroying bee-forage.

Dr. J. P. H. Brown—1. No. Sugar syrup would still be sugar syrup, though deposited in the comb. 2. I don't see why they shouldn't do as well if the same conditions could be restored. Here is a big field for bee-savants to explore.

Dr. C. C. Miller—1. I don't believe it. Even if I believed any one could get the honey produced they wouldn't be such fools as to sell for 3 cents a pound. Wouldn't need to, and would lose big money by it. 2. I don't know any reason why it may not come again.

Emerson T. Abbott—1. Bees cannot produce honey out of sugar syrup in January, nor at any other time. We hear a great many things in these days that are not so. A vast deal of the "honey" made out of sugar syrup is the result of an over-fertile imagination. 2. I do not know anything about the possibilities of honey in Ohio.

Allen Pringle—1. No. Neither in January nor in any other month can bees produce honey from sugar syrup. Don't try to do it, or advise anybody else to try. 2. The Ohio men must answer this question. I do not think bees will ever do as well again in any locality where the forests have disappeared, without special planting and sowing.

P. H. Elwood—1. This is as bad as the artificial comb and glucose filling. The capacity of the average man for being humbugged is great, or such stories could never circulate. 2. Not if your forage has been destroyed. If not, old crops will return. However, we are apt to remember the large crops longer than the small ones or the failures. Not all sunshine years ago.

Eugene Secor—1. I advise you to try that yourself on one colony; and when you have produced the first 10 pounds of honey, you will know that you can't believe all you hear or read. If it does not cost you 5 times the price of honey, I'll miss my guess.

"Behold, we know not anything;
I can but trust that good shall fall
At last—far off—at last, to all—
And every winter change to spring."
—TENNISON.

J. E. Pond—1. I don't think it would be practicable to do so. At any rate they can't produce honey from sugar syrup. 2. I do not know of any reason why they will not. Bee-keepers owe all the trouble there is in the matter to themselves. When they learn wisdom from sad experience, times will improve. It is just such matters as are involved in Part 1 of this question, that causes much of the trouble that now exists.

James A. Stone—1. I would not think the colony would be strong enough to gather any surplus syrup at that time. As to honey, they never can gather or produce it from sugar syrup. Keep your ears open and you can hear anything. But if a bee-keeper is doing what "Columbus" is told is being done, he ought to, and will be, boycotted. 2. Yes. When bee-keepers learn that their bees must have pasturage the same as their animals.

PERSONAL MENTION.

Mr. L. D. STILSON, editor of the Nebraska Bee-Keeper, reported, April 17, that "Bees are doing finely this spring." That's the general report up to this time—April 18. Hope it will continue.

DR. C. C. MILLER, of Marengo, Ill., has been appointed a commissioner to the Presbyterian General Assembly which meets for about 10 days at Saratoga, N. Y., May 21. It is the highest honor conferred on a layman in the Presbyterian church. And the Doctor well deserves it.

MR. ALLEN PRINGLE, of Selby, Ont., in the April Review, lets the daylight in upon the doings of the Ontario Bee-keepers' Association. Some things will hardly bear the light of day, and we'll be glad to see how the Ontario stands it. Mr. Pringle usually knows his ground before he stands upon it.

EDITOR HUTCHINSON, of the Review, expects to attend the meeting of the Philadelphia Bee-keepers' Association, May 16, and read an essay on "The Production of Comb and Extracted Honey." Every bee-keeper within 100 miles of the "City of Brotherly Love," ought to be present to meet and hear Mr. Hutchinson.

MRS. J. M. NULL, of Miami, Mo., we regret to learn, has been sick all the past winter, and under the doctor's tender care. Mrs. Null is one of Missouri's best bee-keepers, and could tell quite an experience if she were so inclined. We hope she may speedily recover, and be equal to her former self, when we had the pleasure of meeting her—at the World's Fair and St. Joseph conventions of the North American.

MR. HASTY, in Review, asks us what we would advise him to do, seeing he is over 200 pages in arrears in reviewing the American Bee Journal. We would advise him to do just as he pleases, and we will promise to be satisfied. So now he can't go wrong. But if Mr. Hasty attempts to recapitulate all the good things some people say they find in the Bee Journal, he'll not run out of material for his Review department very soon.

MRS. J. N. HEATER, of Columbus, Nebr., spent the winter in the South with Mr. Heater, returning home about April 15. She found her bees in fine condition, not a single colony lost in wintering. Mrs. H. is probably the most prominent lady bee-keeper in Nebraska. Our readers know her by her replies in the "Question-Box" for several years past. We had the pleasure of meeting both Mrs. and Mr. Heater at the World's Fair convention. They are a jolly couple.

MR. THOMAS G. NEWMAN and wife, with their daughter (Mrs. F. H. Chenoweth) and her two children, all started for California last Thursday, April 23. They left the Union Depot at 2:40 p.m., where we went to "see them off," and say good-bye. A number of their friends and relatives went to the station to see that Mr. Newman and family had safely begun their long journey toward the "Land of Sunshine." They expected to reach Los Angeles on Tuesday, April 28, where they were to spend a day or two, and then continue on their way to San Diego, where they will make their home. Mr. Newman's many bee-keeping friends will be glad to welcome him to California, and Chicago will hardly again seem the same to us without him. Our best wishes go with Mr. Newman and family, for many years of good health and happiness in their new home in the "Sunset State."

THE AMERICAN BEE JOURNAL

ESTABLISHED IN 1881

THE OLDEST BEE PAPER IN AMERICA

PUBLISHED WEEKLY BY
GEORGE W. YORK & COMPANY,

118 Michigan St., CHICAGO, ILL.

REGULAR CONTRIBUTORS:

G. M. Doolittle, of New York. Prof. A. J. Cook, of California.
Dr. C. C. Miller, of Illinois. Dr. J. P. H. Brown, of Georgia.
J. H. Martin, of California. Rev. E. T. Abbott, of Missouri.
Barnett Taylor, of Minnesota. Mrs. L. C. Axtell, of Illinois.
Chas. Dadant & Son, of Illinois.

\$1.00 a Year—Sample Copy Sent Free.

[Entered at the Post-Office at Chicago as Second-Class Mail-Matter.]

Vol. XXXVI. CHICAGO, ILL., APR. 30, 1896. No. 18.



The Annual Report of the convention of the Nebraska State Bee-Keepers' Association for 1895 is received. The meeting was held at Omaha, Sept. 17, 18 and 19. The Report contains 30 pages. Mr. E. Whitcomb, of Friend, and Mr. L. D. Stilson, of York, Nebr., are respectively President and Secretary of the Association. Nebraska is one of the very few States that issue a pamphlet report of the annual bee-convention.

A Report in one of our late bee-exchanges reads as follows:

"My bees were taken out of the cellar in fine shape March 20. Only 2 dead out of 157; but a lot more may die before June."

We should presume that if the "shape" of the bees was all right last fall, when put into the cellar, their "shape" shouldn't change much during the winter. He probably meant their "condition" was fine.

Then he lost "only 2 out of 157" bees. Just think of it—only 2 bees lost! But then, he says he put in only 157 bees! He most likely meant that 2 colonies died out of 157. Why don't people say what they mean? We "don't know."

North Carolina Experiment Station.—Some months ago we received the following letter from Mr. W. H. Pridden, of Creek, N. C., but in some way it was mislaid, and "turned up" only a week or so ago:

MR. EDITOR:—Inclosed find a clipping which explains itself. It is a step in the right direction, and I hope will be the means of educating the people of North Carolina in bee-keeping, that others who are now ignorant of the pleasure and profit in the pursuit, may learn to enjoy the sweets that go to waste.

W. H. PRIDDEN.

The clipping referred to in the foregoing letter reads thus:

BEE-CULTURE AT THE EXPERIMENT STATION.

The North Carolina Experiment Station has recently completed arrangements for carrying on some work in bee-culture, both to disseminate information as to the best methods to follow in bee-keeping, as well as to conduct tests to determine what plans should be adopted in North Carolina to make this particular industry as profitable as possible. In many sec-

tions of the State bee-culture now yields handsome returns when carefully managed. With proper use of the improved methods of late years this result might be largely increased. It will be the purpose of the Station to endeavor to aid in the extension of the industry, and with the possible improvement of the culture where it has now found a foothold. For this purpose the co-operation of two experienced bee-keepers has been secured—Dr. J. W. Hunter and Mr. W. H. Hall, both of Forsyth county. It is expected that results interesting to bee-keepers will be reached during the coming season. In the meantime, items of timely interest will be distributed upon the various phases of the subject.

As the Station desires to enter into correspondence with every bee-keeper now in North Carolina, each one is cordially requested to send his name and address to Dr. H. B. Battle, Director, Raleigh, N. C. Any items as to the colonies, hives, etc., on hand, and the success or failure heretofore met with, will be gladly received. Doubtless the correspondence will be mutually helpful.

We believe this is the first Southern State to recognize bee-culture in this way. We hope that much good may result, and that other States will imitate the good example set by North Carolina. We should be pleased to publish some of the apian reports issued by this Station.

Prof. Cook, in the Rural Californian for March, gives these three "Bits of Nectar," among others:

BEE'S NOT A NUISANCE.—Aud now comes news of a suit in Europe to show that bees are a nuisance, and not to be tolerated in certain precincts. The decision was with the bees; that it is too late in the world's history to make, much more to enforce, such a claim. God has given us bees for a great purpose. There can be no greater folly than an attempt at their banishment. Auy such an attempt must prove as foolish as it is vain.

BEE-STING REMEDIES.—Ammonia has long been recognized as one of the best antidotes for bee-sting poison. There is reason in this. The poison is acid, and the ammonia in neutralizing the acid, seems to neutralize the poison as well. In a late number of Nature it is suggested that an ammonia extract of quinine is even more effective than ammonia alone. Bee-keepers who are much troubled with stings may well try this new remedy.

KEEP COOL WITH BEES.—There is a prevailing opinion that bees are especially cross to some people. As a teacher of apiculture, who has often had very large classes, numbering at times from 30 to 50, I have had good opportunities to test this theory, but never found any reasons for adopting it. If one is more susceptible to attack and stings than another, it is only because he is nervous and quick in his work and movements. Harsh behavior the bees resent, and usually attempt to punish.

Importation of Apis Dorsata.—On page 217 we requested all who answer in the "Question-Box" department, to let us know their opinion as to the advisability of going to the expense of importing Apis dorsata. So far only three out of 25 have responded, and their replies follow:

I am thoroughly convinced that a great deal more is being made out of the importation of Apis dorsata than the circumstances warrant. It will cost but little to secure a few of these bees to test their merits, and I do not think that the Government should be asked to go to large expense in order to make any experiments along this line. There are other things of more importance to bee-keepers than the importation of these bees, which should have attention first.

This agitation seems to be mostly in the interest of one man, who seems to want the job of going after Apis dorsata. It would be better, it seems to me, to wait until he has shown a disposition to deal fairly and honestly with his fellow bee-keepers as to some matters he now has in hand before he receives any new commissions.

I for one do not think that under the circumstances these bees would prove to be a very valuable addition to the wealth of the bee-keepers of the United States.

EMERSON T. ABBOTT.

I must say I think it a little premature for a local society to attempt a thing of this kind. It should come before the North American at its next meeting, and it would have more influence than a dozen local societies.

The petition says it is the wish of the majority of progress-

sive bee-keepers of this country. I have my doubts about it, as I don't think the majority know one thing about it at the present time. Now, if the *Apis dorsata* is what we want, and it will be a benefit to this country, then I hold up both hands for it. But do we want the *Apis dorsata*?

The Australians wanted the rabbits, but they don't want them now. We wanted the sparrows, but we don't want them now. We have the imported currant-worm, but we don't want it any more. We have the Cyprian bees, but how many want them now? We have many imported insects, birds, quadrupeds and bipeds that we wish we did not have. So I will suggest that all parties go slow, and know just what they are doing with them in their native home. If the drones from *Apis dorsata* only fly after sundown, how are we to use them for any benefit to our queens, if any benefit it will be?

I would like to hear from our good friend D. A. Jones, who spent thousands of dollars investigating the different varieties of foreign bees. Mr. Jones did a great work, and we should always hold him in grateful remembrance.

H. D. CUTTING.

I hardly know how to reply to the request as to the matter of importing the big Indian bee. Two men who have seen it in its native place are hopeful that it might be successfully and profitably introduced. Gravenhorst thinks there is no reason why it might not cross with the smaller bees. Others think differently. I think it is Baldensperger who says it is impossible to domesticate it, and the only attempts in that line that I ever read about were utter failure. Cheshire thinks its introduction would not be valuable, and says: "Fortunately, it is in the very nature of things impracticable to 'hybridize' our bees with *dorsata*." If it is thought advisable to make any effort with regard to it, it would be a good deal cheaper, I should think, to have the experiment made near or on its own ground. If it cannot be kept in a hive there, or if it cannot be crossed with other bees, it is not worth while to bring it here.

The wording of the petition given on page 217, would have to be changed to get the signatures of well-informed bee-keepers. The statement, "It is believed that these bees would be of great advantage," etc., is probably the reverse of the truth, if the general belief is meant; and it is equally far from correct to say that in desiring the introduction of *dorsata*, "we represent the sentiment of a majority of the progressive bee-keepers of the country."

Probably the strongest argument in favor of *dorsata*, providing it could be successfully introduced, is that on account of its size it could work on red clover. If we want the Government to help toward securing honey from red clover, why not work in a more certain direction? For a tithe of the expense, we could get from France bees whose size has been increased until the length of tongue is much beyond the average. Dr. J. P. Murdock has bees of such size that they are said to work freely on red clover. As to these bees, I know for certain that they build worker-comb very nearly as large as drone-comb, their drone-comb being proportionately increased in size.

On the whole, would it not be better to spend money in getting what is less problematical, or in first finding out whether *dorsata* is worth anything if it should be introduced?

C. C. MILLER.

Comment from us on this subject is hardly necessary, even were we competent to speak on the subject. Prof. Cook has referred to the matter favorably, on page 227, so that makes four out of 25 who were asked to express their opinion. Three practically against the importation of *Apis dorsata*, and one for it—so far as heard from. Well, if that is any indication of the minds of the "progressive bee-keepers of the country," it would seem that they are not yet tumbling over each other in their rush to have the "big Indian bee" brought to our shores.

The Mesquite Tree.—Among the trees whose blossoms yield nectar may be named the mesquite, which grows in certain parts of the United States. In the Pacific Rural Press we find the following paragraphs concerning mesquite and its uses:

As is well known to those familiar with this tree, it is useful in many ways to the people of Mexico and the southwestern part of the United States. Its roots and wood are excellent for fuel; the gum is used for dyeing, and also as a medicine; the leaves and pods, or beans, as they are usually

called, are valuable forage for stock, and are also prized by Mexicans and Indians as food. These "beans" consist of an outer husk or pod, and of hard kernels. The pods are agreeable to the taste, and very nutritious. Their food-value largely depends upon the sugar contained, as high as 24 per cent. having been found in them. The kernels are exceedingly hard, and are not digestible by animals when swallowed. Analyses, however, show them to be very nutritious, and if a way could be found to utilize them the value of the "beans" for stock would be much increased.

The flowers of the mesquite yield an excellent honey, and in this way the tree is of commercial importance to the beekeepers of the regions where it grows.

These many uses make it desirable to avoid needless destruction of this tree, and although it is a slow grower, it would probably in the long run be of advantage to plant it, since it is especially adapted to arid surroundings, and will thrive in situations where most trees will perish.

This tree and its products have been undergoing careful examination at the hands of Prof. Forbes, Chemist of the Agricultural Experiment Station at the University of Arizona.

A Foul (Brood) Joke.—In the Canadian Bee Journal for April we find that at the last Ontario convention a certain member raised this question, in all seriousness: "Should not the public be made acquainted with the fact that a *person* has foul brood." (Italics ours.) The idea of a "person" having foul brood! Whenever that happens, no doubt the public will not need to be specially informed—they'll find it out soon enough. Of course the question had reference to a person's *bees*, though it was not so printed.

Big Bees of Cochin China.

In looking over an old volume of the American Bee Journal, I came across the following under the title—

A CHINESE BEE.

"The Apicultural Section of the Entomological Society at its annual meeting in Paris, in August, 1874, made many interesting statements. M. Durand Saint Armand, a government officer in Cochin China, states that the country possesses a bee twice the size of ours, which, consequently, ought to extract the honey from red clover which is known to be very abundant. This bee is found in great numbers all along the coast, in a wild state, in hollow trees, and the natives hunt them for their wax. The extensive forests of this country are leased for the product of wax which is to be sold to the Chinese."

Here then would appear to be our bee twice the size of *Apis mellifica* and living like them in hollow trees. Can not our bee-keeping friends in France give us more information in regard to these bees? I believe a large portion, if not all, of Cochin China is now in the hands of France. I should not now have thought so much of this statement had I not in conversation with a returned missionary learned of the same or a similar bee, under domestication by the Chinese in western China. As he was a young man, a native of this town, brought up on a farm, I felt that his statements were worthy of entire confidence. He said the bees of Western China were in size midway between our hive-bees and the bumble-bee, and were, like our domestic bees, kept in hives; and must be of gentle disposition as he had seen a colony clustered in a crowded street yet no one seemed afraid of them. I had hoped before this to have secured specimens of them, but owing perhaps to the unsettled condition of the country I have not as yet received them. I supposed when he first told me of them that they were the *Apis dorsata* which the Chinese had domesticated, but I now think they must belong to another species.—J. E. CRANE, in Review.

Honey as Food and Medicine.—A new and revised edition of this 32-page pamphlet is now issued. It has 5 blank pages on which to write or paste recipes taken from other sources. It is just what its name indicates, and should be liberally distributed among the people everywhere to create a demand for honey. It contains a number of recipes on the use of honey as food and as medicine, besides much other interesting and valuable information. Prices, postpaid, are: Single copy, 5 cts.; 10 copies 30 cts.; 50 for \$1.00; 100 for \$1.75. Better give them a trial. Send all orders to the Bee Journal office.

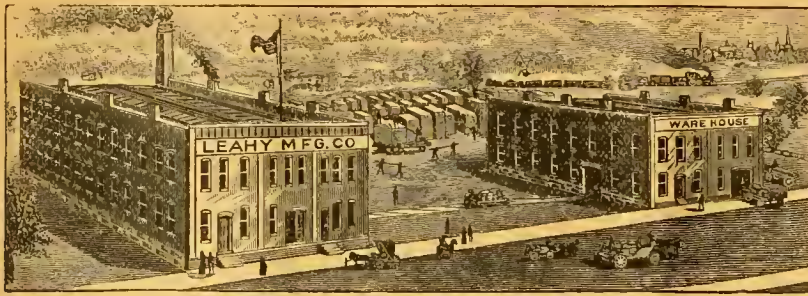

Largest Factory in the West **COMPLETE STOCK.**
 Good Supplies and Low Prices
 Our Motto.

READ THIS—Mr. Keyes says: The 100 pounds of Extra-Thin Foundation you sent us is superior to anything he ever saw; and I think the same. R. L. TUCKER, Wewahitchka, Fla.
 Dear Sirs:—The Sections came duly to hand. Indeed, they are very nice. Yes, sir; they are as good as the best. CHARLES H. THIES, Steelville, Illinois.
 Leahy Mfg. Co.:—I have received the bill of goods. I must say they are the choicest lot of Hive-Stuff I have ever received from any place. I admire the smoothness of your work, and your close selection of lumber. Yours very truly, O. K. OLMSTEAD, Orleans, Nebr.
 Dear Sirs:—The Sections arrived in due time, and are all O. K. so far as examined. They are simply perfection. I can't see how you can furnish such goods at such low prices. I hope you may live long and do well. Yours respectfully, Z. S. WEAVER, Courtney, Tex.
 Gents:—I received the "Higginsville Smoker" all O. K. It's a dandy; please find enclosed stamps for another. Yours truly, OTTO ENDERS, Oswegathe, N. Y.
 Gentlemen:—I have bought Supplies from nearly all the large manufacturers by the carload, and I must say yours are as good as the best. Indeed, in many lines they are the best. It is a pleasure to handle them. E. T. FLANAGAN, Belleville, Illinois.
 The above unsolicited testimonials are a fair sample of hundreds we receive. Our prices are reasonable and the "Higginsville Goods" are the best.
The "Higginsville" Goods are for sale by the following parties:
 Chas. H. Thies, Steelville, Ill. E. T. Flanagan, Belleville, Ill.
 Henry L. Miller, Topeka, Kans. E. A. Seely, Bloomer, Arkansas.
 J. W. Rouse & Co., Mexico, Mo. P. J. Thomas, Fredonia, Kans.
 Fulton & Gregg, Garden City, Kans. W. J. Finch, Jr., Springfield, Ill.
 If you need a Carload of Supplies, or only a Bee-Smoker, write to us. Remember, we are here to serve you, and will, if you give us a chance. **A Beautiful Catalogue Free.**
 Address, **LEAHY MANUFACTURING CO., HIGGINSVILLE, MO.**
 49A *Mention the American Bee Journal.*

CHEAPER THAN EVER
Hilton's White T Supers
Chaff Polished Sections Foundation
Hives Smokers
 And everything needed in the apiary.
 1896 Catalog of 36 pages free.
GEO. E. HILTON,
 13Atf FREMONT, MICH.
Mention the American Bee Journal.

Dadant's Foundation
in Chicago!
 No other Goods kept here. Send for Price-List.
CHAS. DADANT & SON,
 118 Michigan St., CHICAGO, ILL.
 13Atf Please mention the Bee Journal.

YOUNG QUEENS BY RETURN MAIL
 From the South. Bred from our *hardy strain* of GRAY CARNIOLANS and GOLDEN ITALIANS. Untested Queen, 75 cts.; Tested, \$1.50. If you want a Fine Imported or a Select Tested Breeding-Queen, or BEES BY THE POUND, Nuclei and Full Colonies, we can furnish you at *bottom prices*. We never saw Foul Brood or Bee-Paralysis. *Satisfaction guaranteed.* PRICE-LIST FREE.
F. A. LOCKHART & CO., Lake George, N. Y.
 Please mention the American Bee Journal. 16Et

That Queen-Clipping Device Free!
 PLEASE READ THE FOLLOWING OFFER:
 We have arranged with the inventor of the new Queen-Clipping Device (Mr. Montette), to offer it to our present subscribers as a Premium for getting NEW subscribers.
 Send us *just one new name* for the American Bee Journal a year (with \$1.00), and we will mail you the Queen-Clipping Device FREE of charge. Or, the Queen-Clipping Device will be sent postpaid for 50 cts. But why not get it as a Premium by the above offer? You can't earn 50 cts. any easier. Almost every bee-keeper will want this Device. See page 130 (Feb. 27) for full description of it. Complete directions accompany each one sent out. It is a most ingenious and useful article. Address,
GEORGE W. YORK & CO., 118 Michigan St., Chicago, Ill.

General Items.

Bees in Fine Condition.
 Bees in this locality are in fine condition, but later than usual about swarming. They are beginning to store some surplus honey.
 I am well pleased with the improvement in the American Bee Journal, and think it better this year than it has ever been before. J. B. GRIFFIN.
 Cat Creek, Ga., April 14.

Wintered Fairly Well.
 My bees have wintered fairly well, especially those that I wintered in the cellar. I left three of my best colonies out-doors, and lost two of them, and the queen out of the other one, and with one or two like experiences, I have come to the conclusion that out-doors is no place for me to winter bees. C. W. GERRISH.
 Rochester, N. H., April 15.

Bees Eating in Winter.
 On page 190, Mr. Cotton again requests me to forward at least part of the premium which was offered by me in my first article on the above question. But he has failed to reply to my last article. Now, if the circumstances which I drew his attention to, in my last, and which I asked him to explain, were so insignificant that he saw fit to ignore them entirely, I will treat his last with the same consideration, withhold the premium, and holler "Nuf," until he does. D. W. HEISE.
 Bethesda, Ont.

Gelsemium for Rats.
 In answer to Mr. Pringle's inquiry, since cats are barred, tell him to take the flowers of the yellow jessamine (Gelsemium), and put them where rats can have easy access. They will be eaten greedily, and the result will be sudden death, without any other bait being needed.
 This may interest my friends in the Southern States more than Mr. Pringle, as I don't think the Gelsemium grows so far north. ENGLISH B. MANN.
 Wewahitchka, Fla.

ONE MAN WITH THE UNION COMBINATION SAW
 Can do the work of four men using hand tools, in Rippling, Cutting-off, Mitring, Rabbeting, Grooving, Gaining, Dadoing, Edging-up, Jointing Stuff, etc. Full Line of Foot and Hand Power Machinery Sold on Trial. Catalogue Free.
SENECA FALLS MFG. CO.,
 46 Water St., SENECA FALLS, N. Y.
 1Aly *Mention the American Bee Journal.*

SECTIONS
 \$1.50 a M. 3 M, \$4.25.
 These ARE NOT Seconds, but perfect Sections. As they are not up to our present high standard, we wish to close them out. Sample free. Widths—7-to-100t, 1 15-16 in. and 2 in.
Catalog of Bees & Supplies FREE.
I. J. STRINGHAM,
 105 Park Place, NEW YORK, N. Y.

Stray Thoughts by "Bro. Ben."
 *HONEY OF FARMER BEE-KEEPERS.—I hardly think that speech of F. Rauchfuss, on page 181, is complimentary either to specialists or farmer bee-keepers. If the honey of the latter is poor, why need it injure the prices of the former? As a matter of fact, so far as my observation goes, the farmers' honey is superior to that of some specialists. This is owing to the fact that they allow the bees to ripen and cap the honey before it is extracted, thereby insuring a better flavor. Having used this kind of honey some 20 years in preference to that of others, I do not speak unadvisedly.

THE AMALGAMATION.—If there is any thoughts among bee-keepers of wishing to influence legislation by the Union, there should be no foreigners in it. What business would American bee-keepers have in Canada, trying to influence lawmakers, or vice versa? Have strictly a United States Union, and make it also an Exchange, and the number of members will, I believe, be greatly increased.
 Let this Exchange buy up that cheap farmers' honey; get all the pure honey produced, and they can then set a fair living price, and at the same time make it impossible for the adulterator to get in his deadly work, as he cannot get honey to flavor with. I verily believe a Union of this kind would commend itself to a vast majority of bee-keepers wherever located. As it is now, the benefit derived from the

A HANDY TOOL-HOLDER!

Sent by Express, for \$1.50; or with the Bee Journal one year—both for \$2.00.

Every Manufacturer, Miller, Carpenter, Cabinet Maker, Machinist, Wheelwright and Quarryman, Farmer, or any one using a grindstone, should have one of these Tool-Holders. One boy can do the work of two persons, and grind much faster, easier and with perfect accuracy. Will hold any kind of tool, from the smallest chisel to a draw shave or ax. Extra attachment for sharpening scythe blades included in the above price. The work is done without wetting the hands or soiling the clothes, as the water flows from the operator. It can be attached to any size stout for hand or steam power, is always ready for use, nothing to get out of order, and is absolutely worth 100 times its cost.

No farm is well-equipped unless it has a Tool-Holder. Pays for itself in a short time.

How to Use the Holder.

DIRECTIONS.—The Tool is fastened securely in the Holder by a set-screw and can be ground to any desired bevel by inserting the arm of the Holder into a higher or lower notch of the standard. While turning the crank with the right hand, the left rests on an steady the Holder & the Tool is moved to the right or left across the stone, or examined while grinding, as readily and in the same way as if held in the hands.

For grinding **Round-Edge Tools**, the holes in the standard are used instead of the notches.

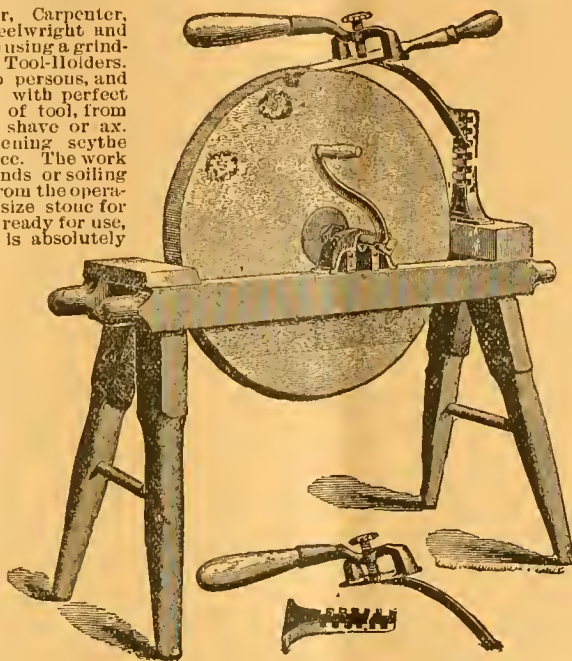

Address, **GEORGE W. YORK & CO.,**

CHICAGO, ILL.

SECTIONS CHEAP! * * * *

In order to reduce stock we will sell
 40,000 4 1/4 x 4 1/4 x 2 40,000 4 1/4 x 4 1/4 x 1 15/16 250,000 4 1/4 x 4 1/4 x 1 1/2
 150,000 4 1/4 x 4 1/4 x 1 1/4 80,000 4 1/4 x 4 1/4 x 7-to-ft,

Of our No. 2. One-Piece, Open-Top Sections, at the following **Low Prices:**
 1,000 for \$1.00; 3,000 for \$2.50; 5,000 for \$3.75.

These Sections are all of good quality and manufacture, and prices will be maintained for a short time only.

G. B. LEWIS CO., WATERTOWN, WIS.

Be sure to mention the American Bee Journal when you write.

WOVEN WIRE FENCE
 Over 50 Styles. The best on Earth. Horse high, Bull strong, Pig and Chicken tight. You can make from 40 to 60 rods per day for from 14 to 22c. a Rod. Illustrated Catalogue Free. **KITSELMAN BROS.** Ridgeville, - Indiana.

48Etf Mention the American Bee Journal.

Bees, Queens, Nuclei—We will sell, the coming season, 500 Two-Frame Nuclei, with a Choice Warranted Queen, at \$2.50 each. Special prices on large orders furnished. **LEININGER BROS.** 6Etf Mt. Jennings, Ohio.

WHEN ANSWERING THIS ADVERTISEMENT, MENTION THIS JOURNAL.

I have one of the choicest flocks of BROWN LEGHORNS IN THE STATE

Keep no other kind. Eggs, 75c. per 15; \$1.25 per 30. **B. G. SCOTHAN,** 16Etf OTISVILLE, MICH.

Mention the American Bee Journal.



Bee Supplies
 Largest Stock and Greatest Variety in the West. **BEST** Goods at Lowest prices. Cat. of 80 pages FREE.

E. KRETCHMER, RED OAK, IOWA.
 Mention the American Bee Journal. 12E8t

Fruit-Plants Free!

ALL CHOICE VARIETIES.

- No. 1—Eight Snyder Blackberry Plants. \$1.00
- No. 2—50 Asparagus Roots. 1.00
- No. 3—6 Fay Prolific Currants. 1.00
- No. 4—3 Snyder Blackberry, 20 Asparag's Roots and 3 Fay Prolific Currants. 1.00
- No. 5—3 Blackcap Gregg Raspberries, 3 Choice Red Raspberries, 12 to a Beauty Strawberries and 2 Fay Pro. Curr. 1.00
- No. 6—4 Snyder Blackberry, 4 Golden Queen Raspberry, 12 Asparagus R'ts and 10 Eric Blackb'ry Root Cuttings. 1.00
- No. 7—75 Blackberry Root Cuttings. 1.00

Special Offer—Your choice of any ONE of the above 7 Numbers for sending us one new subscriber to the Bee Journal for a year at \$1.00, and 15 cts. to pay Postage on the Plants.

GEORGE W. YORK & CO.,
 - CHICAGO, ILLS.

Sweet Clover & Canada.

At the following prices:

5 lbs.	10 lbs.	25 lbs.	50 lbs.
\$1.00	\$1.60	\$3.75	\$7.25.

Also a quantity of Motherwort and Catnip seed. Prices on application.

EGGS for Hatching. Buff Leghorns, Indian Games, & Light Brahmans. Choice Birds. A breeder for 30 years. Prices on application

JOHN MCARTHUR,
 881 Yonge Street, - TORONTO, ONT.
 15Atf Mention the American Bee Journal.

Union is mostly to those who get into some kind of litigation, and to those who by their nearness to place of meeting can attend the conventions.

Let a Union and Exchange be formed in one, so that it will benefit all members, and I would not long hesitate to pay the necessary \$10 to become a life member, and help create the necessary funds to buy that farmers' cheap honey. **BRO. BEN.**
 Mapleton, Iowa.

[We might say for the benefit of those who have been mailing various things to "Bro. Ben," that he simply uses that title as a non-de-plume. So whatever is mailed to "Bro. Ben" never reaches him or any one else.—Ed.]

Bees Wintered Well.

My bees have wintered well so far. Some have to be fed shortly if we do not get warm weather and fruit blooming soon.

The American Bee Journal is a welcome visitor every week. **PETER BLUNIER.**
 Roanoke, Ill., April 8.

Bees Appear in Good Condition.

We had no honey last year. I have 55 colonies of bees in the cellar yet. They appear to be very quiet, and I think they are in good condition. **H. PEARSON.**
 Natural Dam, N. Y., April 11.

The Season of 1895.

My report for 1895 is as follows: Six hundred pounds of comb honey, and 200 pounds of extracted, from 8 colonies. Spring count, and increased to 15. **P. J. KLEIN.**
 Greenwood, Wis., April 11.

A Good Report for 1895.

Last year I bought one colony of bees, and got 300 one-pound boxes full of honey, and 8 swarms of bees, which, with the one I bought, made 9 colonies. I put them into the bee-cellar, and they are all right.

I want to say to Mr. Snow, of Osakis, that the above is a true count, and I can get plenty to swear to it. I will say for Mr. J. Z. Rhodes, that his report is not correct. I asked him why he didn't put it in correctly, and he replied that he was afraid people would think he was lying. Now, Mr. Snow, if Mr. Rhodes doesn't make out a correct statement, and swear to it, I will have him fined! **MERRITT OSBORN.**
 Verndale, Minn.

A Northern Bee-Man in Virginia.

At the age of 50, and after about 40 years of honest toil and industry, and by practicing economy, without indulging in vice, rum or tobacco, we found ourselves, with God's blessing, with what we considered enough of this world's goods to see our (that is, wife and I) way through to the end of life's journey. Therefore, I retired from business, and sought a winter's home in this place, to avoid the cold blasts and long winters of the North, which, to us, it seemed were threatening our physical existence. And now, after nine winters' trial, we feel well repaid and pleased with the change. I think this climate has been a sort of strength restorer to us, and would not swap it for any squad of doctors, and drug-store nostrums by the ton, for persons in like condition of health.

I have kept from 40 to 60 colonies of bees for the last 30 years. I left over 50 up at my Northern home (Middletown, N. Y.) last fall, and have 17 here. I think there are about 100 colonies kept within a radius of two miles from us. We bought the stock we have here, and it appears to be a mixture of Italian, black, and perhaps some Cyprian blood, as the bees are prone to use

BUY "DIRECT FROM FACTORY," BEST MIXED PAINTS

At **WHOLESALE PRICES**, Delivered **FREE** For Houses, Barns, Roofs, all colors, and **SAVE** Dealers' profits. In use 54 years. Endorsed by Grange & Farmers' Alliance. Low prices will surprise you. Write for Samples. **O. W. INGERSOLL**, 289 Plymouth St., Brooklyn, N. Y.
12A13 Mention the American Bee Journal

MURDERED

We have killed high prices. Give me a trial order and be convinced that good Queens can be reared for 50 cts. each. Untested, 50 cts.; Tested, 75 cts. Golden Italians, 3-Banded Italians, and Silver-Gray Carniolans, all the same price. Best of References given.

C. B. BANKSTON,
13A1f **CHRIESMAN**, Burlison Co., TEX.
Mention the American Bee Journal.

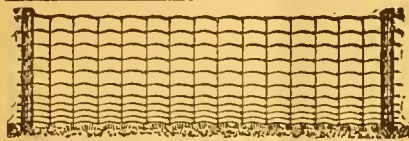

IT WILL DO TO TIE TO.

This phrase expresses the frontiersman's idea of security, and experience has taught him that a yielding limb or sapling makes a safer "hitch" than a solid rock. Some wire fences will safely hold even a pulling horse, hitched to the middle of a panel. The owner of that fence will tell you it was made by **PAGE WOVEN WIRE FENCE CO.**, Adrian, Mich.
WHEN ANSWERING THIS ADVERTISEMENT, MENTION THIS JOURNAL.

Comb Foundation

Made by Automatic Machinery, Lowest in Price.

Falcon Polished SECTIONS. Finest Made.

Otherwise in stock a full line of **Higginsville SUPPLIES. Cheapest Sold**
Seven R. R.'s and 4 Express Co.'s to ship over. Catalogue and Samples Free.

W. J. FINCH, Jr., **SPRINGFIELD ILLS.**
Mention the American Bee Journal.

SUCCESSFUL INCUBATOR
Our magnificent new catalogue giving full information regarding artificial hatching & brooding and treatise on poultry raising sent for 4c stamps. Circular free.

Write now, **Dee Moinea Incubator Co.**, Box 78 Des Moines, Ia.

11A9t Mention the American Bee Journal.

California

If you care to know of its Fruits, Flowers Climate or Resources, send for a Sample Copy of California's Favorite Paper—

The Pacific Rural Press

The leading Horticultural and Agricultural paper of the Pacific Coast. Published weekly, handsomely illustrated, \$2.00 per annum. Sample Copy Free.

PACIFIC RURAL PRESS,
220 Market St., - SAN FRANCISCO, CAL.

TEXAS QUEENS.

If you are in need of Queens, let me have your order. Price-List Free.

8A26t **J. D. GIVENS**, Lisbon, Tex.

their business-end quite freely, and also are great swarmers.

Last spring I left them in April, gave every hive two sets of Langstroth frames, one above the other, except a few that had a set of frames six inches deep on top, but many of them swarmed, so the people said, and decamped, as there was no one to look after them that understood the business, and the man that I expected to assist was sick. Now, some claim that bees will swarm here anyway you fix them, but I think not, and believe the same bee here, with like treatment and conditions as at the North, will perform the same, every time. At the North, 20 years ago, we were troubled beyond endurance with over-swarming, but after we got the Italian bee, and supplied different conditions, our trouble was at an end, and now we have to force our swarms if we get enough natural ones to supply or make up our usual winter losses.

Bees winter here with but little loss, except from lack of stores. Last November I introduced 11 pure Italian queens. Some I divided into three colonies, and it is wonderful how these little colonies have pulled through. I now expect to ship some of these colonies North this spring, to reinforce the weak ones up there. Still, this will be useless unless we have a better season up there than we did last year, for bees here gathered a surplus, while up there I had to feed to get them in a condition for winter. **CHESTER BELDING**,
Claremont, Va., March 24.

Clipping the Queens' Wings.

There is a time to feed bees, and a time not to feed; a time to contract the brood-nest, and a time, again, to enlarge it; a time to put on section-cases, and a time to take them off; a time when bees will swarm, and I know there is a time when they will sting.

There was a good deal said about clipping and non-clipping of the queens' wings, but I do not remember seeing anything as to the proper or best time to clip them—except not to do so before the queen is fertilized. It is very nice and pleasant when a colony swarms, to go in front of the hive and pick up the clipped queen, place her in an empty hive, and let the bees do the rest while you wait. Last summer I found a clipped queen 10 feet from her hive, in the grass. They had swarmed two days before. The bees had balled her, and she had been out in the open air for two days and nights. Some man may say he would rather not have his queens clipped, for they are too liable to come out and get lost in the grass. Well, I would rather the queen would get lost, than to have the queen and whole colony come out and fly away, which they are liable to do if you are not on hand at the time. You may lose the clipped queen, but the colony of bees will return if the queen is unable to go along.

It has been my custom, whenever I found the queen (after she was fertilized), to clip her wings, but my experience from slight observation is, that if you have a colony that is doing well, and the queen is laying nicely, you had better let her alone, for fear the clipping of her wings will make her stop laying for a time. Will not some one with more experience tell me if this is not true, if there is not a proper time to clip the queens' wings, and just when that is? **Brooklyn, N. Y.** **I. N. HOAGLAND**.

How He Began Bee-Keeping.

Thank you, Mr. Ball, for what you have to say on page 202. Your remarks are short and to the point, and come from my own State. If you will take notice, the most of the big honey and bee stories come from some far-away State or country, which seems strange, as I know of quite a number of bee-keepers in this State, there being no less than six within three miles of me. Now, is this State a poor pasture for bees, or don't we feel at liberty to tell what we know about bee-keeping, honey crops,

ORIGINAL BINGHAM SMOKERS
Wonderful Record!
HAVE LASTED 17 YEARS.
BEST ON EARTH.
Always Give Perfect Satisfaction.

My cool Wire Handle and Bent Nose were patented 1892, are the original, my best invention since my open or direct draft Patent, 1878, that revolutionized Bee-Smokers. My Handle and Nose Patent bent all the other smoker noses. None but Bingham Smokers have all the best improvements. If you buy genuine Bingham Smokers and Honey-Knives you will never regret it. The "Doctor," 1/2-inch larger than any other smoker on the market—3/4-inch stove, by mail, \$1.50
Conqueror, 3 " " " 1.10
Large, 2 1/2-in. " " 1.00
Plain, 2-in. " " .70
Little Wonder, 2-in., wt. 10 oz. .60
Bingham & Hetherington Honey-Knives, 80 cents.

T. F. BINGHAM, Farwell, Mich.
7A1f Mention the Bee Journal.

PATENT WIRED COMB FOUNDATION
Has No Sag in Brood-Frames
Thin Flat-Bottom Foundation
Has No Fishbone in the Surplus Honey.
Being the cleanest is usually worked the quickest of any Foundation made
J. VAN DEUSEN & SONS,
Sole Manufacturers,
Sprout Brook Montgomery Co., N. Y.

BEGINNERS.
Beginners should have a copy of the Amateur Bee-Keeper, a 70-page book by Prof. J. W. Rouse. Price 25 cents; if sent by mail, 28c. The little book and the Progressive Bee-Keeper (a live, progressive 28-page monthly journal) one year, 65c. Address any first-class dealer, or
LEAHY MFG. CO., Higginsville, Mo.

MILLIONS OF DOLLARS
ANNUALLY by
SAVED FRUIT GROWERS using
Deming SPRAYING Outfits
Recommended by leading Horticulturists.
See para-illustrated catalogue and treatise **FREE**
The Deming Co., Mfgs., Salem, Ohio.
Benion & Hubbell, Gen'l West. Ar'ts., Chicago.
Mention the American Bee Journal.

J. W. TAYLOR
—HAS THE BEST—
Italian Queens for Sale
Untested, ready now, 75c. apiece; 6 for \$4.25, or 12 for \$8.00. Tested, \$1.25. Select Tested, best, \$2.00. Pay for Queens on arrival. I guarantee safe arrival and satisfaction.
14A9t **OZAN, AUK.**

Bee-Keepers' Photograph.—We have now on hand a limited number of excellent photographs of prominent bee-keepers—a number of pictures on one card. The likeness of 49 of them are shown on one of the photographs, and 121 on the other. We will send them, postpaid, for 50 cents each, mailing from the 121 kind first; then after they are all gone, we will send the 49 kind. So those who order first will get the most "faces" for their money. Send orders to the Bee Journal office.

\$3.10 FOR THE BEST
 BRASS BUCKET SPRAY PUMP
 on the market. It is fully described in
 our SPRAY PUMP CATALOGUE. Another
 valuable work is our handsome ILLUSTRATED
 BOOK ON CIDER PRESSES AND FRUIT
 MACHINERY. Both will be sent FREE.
 DAVIS-JOHNSON CO.
 41 W. Randolph St. CHICAGO, ILL.

16A4t Mention the American Bee Journal

PURE BARRED PLYMOUTH ROCK

Eggs, \$1.25 per 14. Our P. Rocks are very
 large, with fine plumage. Also.

BLACK MINORCA EGGS,

a non-sitting and great laying breed. Both
 kinds raised up our farm. Minorca Cock-
 erels, \$1.00 each. Mrs. L. C. ANTELL.
 16A4t ROSEVILLE, Warren Co., ILL.

1896 SAVE MONEY 1896

If you want first-class **ITALIAN QUEENS**
FOR BUSINESS, **Foundation at Wholesale Prices, Hives,**
 suited for the South, or **SUPPLIES**, send for
 Price-List—to

J. P. H. BROWN, AUGUSTA, GA.

IF YOU WANT THE

BEE-BOOK

That covers the whole Apicultural Field more
 completely than any other published, send
 \$1.25 to Prof. A. J. Cook, Claremont, Calif.,
 for his

Bee-Keeper's Guide.

Liberal Discounts to the Trade.

Kansas Bee - Keepers !

—SAVE FREIGHT—

A Car-load of "Higginsville Bee-Supplies"
 just received. GET MY CATALOGUE.

HENRY L. MILLER,
 355 Shawnee Ave. TOPEKA, KAN.
 WHEN ANSWERING THIS ADVERTISEMENT, MENTION THIS JOURNAL.

HONEY We have a large amount of Pure
 No. 1 Alfalfa we will sell cheap.

Wax Wanted.

Boss bee-escape Warranted the best, sim-
 plest and quickest Escape on
 the market. Sent postpaid to any address
 for 30 cts. It can be returned at our expense
 if it is not as represented, or we will send the
 Escape on trial to any bee-keeper wishing to
 test it in good faith. We are agents for the
Ferguson Patent Hive with double-case
 Super and Wicket-Gate Honey-Board, with the Escape. It is the
 easiest, quickest hive to handle for the pro-
 duction of comb honey. Address,

E. S. LOVESY & CO.,
 355 6th East St., SALT LAKE CITY, UTAH.
 Mention the American Bee Journal. 9A4t

A Good Apiary for Sale.

150 Colonies (more or less) of Italian and Hy-
 brid Bees in Langstroth hives, mostly double-
 story for extracting, with the extra Combs as
 well; nearly 100 Empty Hives, complete ;
 good Honey-House, Extractor, Honey-Tanks,
 and all Fixtures. In a location where there
 has been a good surplus crop every year for
 the past 20 years, from Spanish-needle, clo-
 ver, etc. Will sell for part cash, and balance
 in extracted honey in September, at 6 cents
 per pound at the apiary. Price reasonable.
 Address, G. F., care Am. Bee Journal,
 118 Michigan Street, CHICAGO, ILL.

Duvall's Queens Have become
 popular for their superior
 qualities and the price is way down now.
Be sure to send for Circular.
C. D. DUVAL, Satsuma Heights, Fla.
 18E4t Please mention this Journal.



BEE JOURNAL
 PUBLISHED WEEKLY BY
GEORGE W. YORK & CO.,

56 Fifth Avenue, CHICAGO, ILLS.

Postage to all Countries in the Postal Union
 is 50 cents extra. To all others, \$1.00
 more than the subscription price.

Hebblewhite & Co., 369 George Street,
 Sydney, New South Wales, Australia, are our
 authorized agents. Subscription price, 6 shil-
 lings per annum, postpaid

Important to All Subscribers.

The American Bee Journal is
 sent to subscribers until an order is received
 by the publishers for its discontinuance,
 and all arrearages are paid.

Always State the Post-Office to which
 your paper is addressed, when writing to us.

A Sample Copy of the Bee Journal
 will be sent FREE upon application.

How to Send Money.—Remit by
 Express, Post-Office Money Order, or Bank
 Draft on New York or Chicago. If none of
 these can be had, Register your Letter,
 affixing Stamps both for postage and regis-
 try, and take a receipt for it. Money sent
 thus, IS AT OUR RISK; otherwise it is
 not. Do not send Checks on Local Banks—
 we have to pay 25 cents each, to get them
 cashed.

Never Send Silver in letters. It will
 wear holes in the envelope, or may be stolen.

Money Orders.—Make all Money Or-
 ders payable at Chicago, Ill.—not at any
 sub-station of Chicago.

Postage Stamps of any denomina-
 tion may be sent for any fraction of a dol-
 lar; or where Money Orders cannot be
 obtained, stamps for any amount may be
 sent.

Subscription Credits.—The receipt
 for money sent us will be given on the
 address-label of every paper. The subscrip-
 tion is paid to the end of the month
 indicated.

Do not Write anything for publica-
 tion on the same sheet of paper with busi-
 ness matters, unless it can be torn apart
 without interfering with either part of the
 letter.

Lost Numbers.—We carefully mail
 the Bee Journal to every subscriber, but
 should any be lost in the mails, we will re-
 place them if notified before all the edition
 is exhausted. Please don't wait a month
 or two, for then it may be too late to get
 another copy.

Emerson Binders, made especially
 for the American Bee Journal, are conven-
 ient for preserving each weekly Number, as
 fast as received. They will be sent, post-
 paid, for 75 cents, or clubbed with the Am-
 erican Bee Journal for one year—both to-
 gether for \$1.60. They cannot be sent by
 mail to Canada.

MUTH'S HONEY EXTRACTOR
 PERFECTION
 Cold-Blast Smokers,

Square Glass Honey Jars, Etc.

For Circulars, apply to CHAS. F. MUTH & SON,
 Cor. Freeman & Central Aves., Cincinnati, O.
 Send 10c for Practical Hints to Bee-Keepers.

Mention the American Bee Journal

WANTED to exchange—Watch and 22-cal.
 Rifle, for Queens, at once.
 B. W. HOPPER, Garden City, Kan.

The Patent Wood-Veneer Foundation.

Bee-keepers should give it a test, and my All-
 Wax Foundation. I will guarantee there is no
 better made, as six years ago I discarded the
 old way of dipping for wax sheets, and a new
 invention of my own was discovered, which
 enables me to make the toughest kind of
 Foundation; also, no acid used to purify the
 Beeswax, and it preserves the smell of honey,
 which is more acceptable to the bees. Now is
 the the time to send wax and have it worked
 up at low prices. Send for Samples and Cata-
 logue with low prices. Wax wanted at 31c cash,
 or 33c trade, delivered.

AUG. WEISS, Hortonville, Wis.
 12A13t Please mention the Bee Journal.



Promptness Is What Counts !

Honey-Jars, Shipping-Cases, and every-
 thing that bee-keepers use, **Root's**
Goods at Root's Prices, and the
 best shipping point in the country.
 Dealer in Honey and Beeswax. Cata-
 logue Free.

Walter S. Ponder
 162 Mass. Ave. INDIANAPOLIS, IND.

Mention the American Bee Journal.

Extracted Honey for Sale !!

The beautiful, white Willow-Herb Honey,
 in 60-lb. cans, f. o. b. Chicago, at 8 cents per

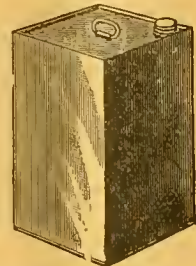

pound, 2 cans (120 lbs.) in a box. Single can,
 8½ cts. per pound.

Fine Basswood honey at same prices.

Sample of the honey mailed on receipt of
 10 cts. This honey will give entire satisfac-
 tion, is guaranteed strictly pure Basswood and
 Willow-Herb honey. Better order at once,
 and begin to work up a trade before the new
 crop comes on. Address,

GEORGE W. YORK & CO.,
 CHICAGO, ILLS

List of Honey and Beeswax Dealers.

Most of whom Quote In this Journal.

- Chicago, Ills.**
- R. A. BURNETT & Co., 163 South Water Street.
- New York, N. Y.**
- HILDRETH BROS. & SEGELKEN,
 120 & 122 West Broadway.
- CHAS. ISRAEL & BROS., 486 Canal St.
- Kansas City, Mo.**
- C. C. CLEMOMS & Co., 423 Walnut St.
- Buffalo, N. Y.**
- BATTERSON & Co., 167 & 169 Scott St.
- Hamilton, Ills.**
- CHAS. DADANT & SON.
- Philadelphia, Pa.**
- WM. A. SELSER, 10 Vine St.
- Cincinnati, Ohio.**
- C. F. MUTH & SON, cor. Freeman & Central avs.

Convention Notices.

ILLINOIS.—The spring meeting of the Nor-
 thern Illinois Bee-Keepers' Association will
 be held at the home of Mr. O. J. Cummings, in
 Guilford, on May 19, 1896. Come, and bring
 your wives and friends interested in bees.
 New Milford, Ills. B. KENNEDY, Sec.

Bee-Keeper's Guide—see page 285.

BEE-BOOKS

SENT POSTPAID BY

George W. York & Co.,
Chicago, Ills.

Bees and Honey, or Management of an Apiary for Pleasure and Profit, by Thomas G. Newman.—This edition has been largely re-written, thoroughly revised, and is "fully up with the times" in all the improvements and inventions in this rapidly-developing pursuit, and presents the apiarist with everything that can aid in the successful management of an apiary, and at the same time produce the most honey in an attractive condition. It contains 250 pages, and 245 illustrations—is beautifully printed in the highest style of the art, and bound in cloth, gold-lettered. Price, \$1.00.

Langstroth on the Honey-Bee, revised by Dadant.—This classic in bee-culture, has been entirely re-written, and is fully illustrated. It treats of everything relating to bees and bee-keeping. No apiarist library is complete without this standard work by Rev. L. L. Langstroth—the Father of American Bee-Culture. It has 520 pages; bound in cloth. Price, \$1.25.

Price, postpaid, \$1.25.

Bee-Keepers' Guide, or Manual of the Apiary, by Prof. A. J. Cook, of the Michigan Agricultural College.—This book is not only instructive and helpful as a guide in bee-keeping, but is interesting and thoroughly practical and scientific. It contains a full delineation of the anatomy and physiology of bees. 460 pages; bound in cloth and fully illustrated.

Price, postpaid, \$1.25.

Scientific Queen-Rearing, as Practically Applied, by G. M. Doolittle.—A method by which the very best of Queen-Bees are reared in perfect accord with Nature's way. 17 pages, bound in cloth, and illustrated. Price, \$1.00.

A B C of Bee-Culture, by A. I. Root.—A cyclopaedia of 400 pages, describing everything pertaining to the care of the honey-bees. It contains 300 engravings. It was written especially for beginners. Bound in cloth. Price, \$1.25.

Advanced Bee-Culture, Its Methods and Management, by W. Z. Hutchinson.—The author of this work is too well known to need further description of his book. He is a practical and entertaining writer. You should read his book. 90 pages, bound in paper, and illustrated. Price, 50 cts.

Rational Bee-Keeping, by Dr. John Dzierzon.—This is a translation of his latest German book on bee-culture. It has 350 pages; bound in cloth, \$1.25; in paper covers, \$1.00.

Bienen-Kultur, by Thomas G. Newman.—This is a German translation of the principal portion of the book called BEES OF HONEY. 103 page pamphlet. Price, 40 cents.

Convention Hand-Book, for Bee-Keepers, by Thomas G. Newman.—It contains the parliamentary law and rules of order for Bee-Conventions; also Constitution and By-Laws, with subjects for discussion, etc. Cloth, gold-lettered. Price, 25 cts.

Amerikanische Bienenzucht, by Hans Buschbauer.—Printed in German. A hand-book on bee-keeping, giving the methods in use by the best American and German apiarists. Illustrated; 133 pages. Price, \$1.00.

Thirty Years Among the Bees, by Henry Alley.—Gives the results of over a quarter-century's experience in rearing queen-bees. Very latest work of the kind. Nearly 100 pages. Price, 50c.

Why Eat Honey?—This Leaflet is intended for FREE distribution, to create a Local Market. 100 copies, by mail, 40 cts.; 500 for \$1.50; 1000, \$2.50. If 500 or more are ordered at one time, your name and address will be printed on them FREE.

How to Keep Honey and preserve its richness and flavor. Price same as Why Eat Honey.

Apiary Register, by Thos. G. Newman.—Devotes two pages to a colony. Leather binding. Price, for 50 colonies, \$1.00; for 100 colonies, \$1.25.

Preparation of Honey for the Market, including the production and care of comb and extracted honey. A chapter from BEES AND HONEY. Price, 10 cents.

Bee-Pasturage a Necessity.—This book suggests what and how to plan. It is a chapter from BEES AND HONEY. Price, 10 cents.

The Hive I Use, by G. M. Doolittle. It details his management of bees, and methods of producing comb honey. Price, 5 cents.

Dr. Howard's Book on Foul Brood.—Gives the McEvoy Treatment and reviews the experiments of others. Price, 25 cts.

Dictionary of Apiculture, by Prof. John Phil. Gives the correct meaning of nearly 500 apicultural terms. Price, 50 cts.

Winter Problem in Bee-Keeping, by G. R. Pierce. Result of 25 years' experience. 50 cts.

Handling Bees, by Chas. Dadant & Son.—A Chapter from Langstroth Revised. Price, 8 cts.

Bee-Keepers' Directory, by H. Alley.—Latest methods in Queen-Rearing, etc. Price, 50c.

Foul Brood Treatment, by Prof. F. R. Cheshire.—Its Cause and Prevention. Price, 10 cts.

Foul Brood, by A. R. Kohnke.—Origin, Development and Cure. Price, 25 cts.

History of Bee-Associations, and Brief Reports of the first 20 conventions. Price, 15 cts.

Honey as Food and Medicine, by T. G. Newman.—A 32-page pamphlet; just the thing to create a demand for honey at home. Should be scattered freely. Contains recipes for Honey-Cakes, Cookies, Puddings, Foam, Wines, and uses of honey for medicine.

Prices, prepaid—Single copy, 5 cts.; 10 copies, 35 cts.; 50 for \$1.50; 100 for \$2.50; 250 for \$5.50; 500 for \$10.00; or 1000 for \$15.00.

When 250 or more are ordered, we will print the bee-keeper's card (free of cost) on the front cover page.

Bee-Keeping for Profit, by Dr. G. L. Tinker.—Revised and enlarged. It details the author's "new system, or how to get the largest yields of comb or extracted honey." 80 p.; illustrated. 25c.

Emerson Binders, made especially for the BEE JOURNAL, are convenient for preserving each number as fast as received. Not suitable to Canada. Price, 75 cts.

Commercial Calculator, by C. Ropp.—A ready Calculator, Business Arithmetic and Account-Book combined in one. Every farmer and business man should have it. No. 1, bound in water proof leatherette, calf finish. Price, 40 cts. No. 2 in fine artificial leather, with pocket, silicate slate, and account-book. Price, 60 cts.

Green's Four Books, by Chas. A. Green.—Devoted to, 1st, How We Made the Old Farm Pay; 2nd, Peach Culture; 3rd, How to Propagate Fruit-Plants, Vines and Trees; 4th, General Fruit Instructor. Nearly 120 pages. Fully illustrated. 25 cts.

Green's Six Books on Fruit-Culture, by Chas. A. Green.—Devoted 1st, to Apple and Pear Culture; 2nd, Plum and Cherry Culture; 3rd, Raspberry and Blackberry Culture; 4th, Grape Culture; 5th, Strawberry Culture. 129 pp.; illustrated. 25 cts.

Garden and Orchard, by Chas. A. Green.—Gives full instructions in Thinning and Marketing Fruits; Pruning, Planting and Cultivating; Spraying, Evaporation, Cold Storage, Etc. 94 pages, illustrated. Price, 25 cts.

Kendall's Horse-Book.—35 pictures, showing positions of sick horses, and treats on all their diseases. English or German. Price, 25 cts.

Silo and Silage, by Prof. A. J. Cook.—It gives the method in operation at the Michigan Agricultural College. Price, 25 cts.

Lumber and Log-Book.—Gives measurements of lumber, logs, planks; wages, etc. 25c.

Maple Sugar and the Sugar Bush, by Prof. A. J. Cook.—Full instructions. Price, 35 cts.

Grain Tables, for casting up the price of grain, produce, hay, etc. Price, 25 cts.

Capons and Caponizing, by Dr. Sawyer, Fanny Field, and others.—Illustrated. All about caponizing fowls, and thus how to make the most money in poultry-raising. 64 pages. Price, 30 cts.

Our Poultry Doctor, or Health to the Poultry Yard and How to Cure Sick Fowls, by Fanny Field.—Everything about Poultry Diseases and their Cure. 64 pages. Price, 30 cts.

Poultry for Market and Poultry for Profit, by Fanny Field.—Tells everything about the Poultry Business. 64 pages. Price, 25 cts.

Turkeys for Market and Turkeys for Profit, by Fanny Field.—All about Turkey-Raising. 64 pages. Price, 25 cts.

Rural Life.—Bees, Poultry, Fruits, Vegetables, and Household Matters, 100 pages. 25 cts.

Strawberry Culture, by T. B. Terry and A. I. Root. For beginners. Price, 40 cts.

Potato Culture, by T. B. Terry.—It tells how to grow them profitably. Price, 40 cts.

Carp Culture, by A. I. Root and Geo. Finley.—Full directions. 70 pages. Price, 40 cts.

Hand-Book of Health, by Dr. Footo.—Hints about eating, drinking, etc. Price, 25 cts.

Alsike Clover Leaflet.—Full directions for growing. 50 for 25 cts.; 100 for 40 cts.; 200, 70c.

Book Clubbing Offers.

(Read Carefully.)

The following clubbing prices include the American Bee Journal one year with each book named. Remember, that only ONE book can be taken in each case with the Bee Jour-

nal a year at the prices named. If more books are wanted, see postpaid prices given with the description of the books on this page. Following is the clubbing-list:

1. Langstroth on the Honey-Bee.....	\$2.00
2. A B C of Bee-Culture.....	2.00
3. Bee-Keeper's Guide.....	1.75
4. Bees and Honey [Cloth bound].....	1.65
5. Scientific Queen-Rearing.....	1.75
6. Dr. Howard's Foul Brood Book.....	1.10
7. Advanced Bee-Culture.....	1.30
8. Amerikanische Bienenzucht [Germ.].....	1.75
9. Bienen-Kultur [German].....	1.25
10. Rational Bee-Keeping [Cloth bound].....	2.00
11. Rational Bee-Keeping [Paper bound].....	1.75
12. Thirty Years Among the Bees.....	1.30
13. Bee-Keeping for Profit.....	1.15
14. Convention Hand-Book.....	1.15
15. Poultry for Market and Profit.....	1.10
16. Turkeys for Market and Profit.....	1.10
17. Capons and Caponizing.....	1.10
18. Our Poultry Doctor.....	1.10
19. Green's Four Books.....	1.15
20. Green's Six Books on Fruit-Culture.....	1.15
21. Garden and Orchard.....	1.15
22. Rural Life.....	1.10
23. Emerson Binder for the Bee Journal.....	1.60
24. Commercial Calculator, No. 1.....	1.25
25. Commercial Calculator, No. 2.....	1.40
26. Kendall's Horse-Book.....	1.10
27. Strawberry Culture.....	1.20
28. Potato Culture.....	1.20
31. Carp Culture.....	1.20
32. Hand-Book of Health.....	1.10
33. Dictionary of Apiculture.....	1.35
34. Maple Sugar and the Sugar Bush.....	1.20
35. Silo and Silage.....	1.10
36. Winter Problem in Bee-Keeping.....	1.30
37. Apiary Register (for 50 colonies).....	1.75
38. Apiary Register (for 100 colonies).....	2.00
39. Bee-Keepers' Directory.....	1.30

Honey & Beeswax Market Quotations.

The following rules for grading honey were adopted by the North American Bee-Keepers' Association, and, so far as possible, quotations, are made according to these rules:

FANCY.—All sections to be well filled; combs straight, of even thickness, and firmly attached to all four sides; both wood and comb unsoiled by travel-stain, or otherwise; all the cells sealed except the row of cells next the Wood.

NO. 1.—All sections well filled, but combs uneven or crooked, detached at the bottom, or with but few cells unsealed; both wood and comb unsoiled by travel-stain or otherwise.

In addition to this the honey is to be classified according to color, using the terms white, amber and dark. That is, there will be "fancy white," "No. 1 dark," etc.

CHICAGO, ILL., Apr. 23.—We quote: Fancy white, 15c.; No. 1 white, 12@13c.; fancy amber, 9@10c.; No. 1 amber, 7@8c.; fancy dark, 8@9c.; No. 1 dark, 7c. Extracted, white, 5@7c.; amber, 4@5c.; dark, 4@4½c. Beeswax, 30c. The number of sales are few, and prices are really nominal. The only activity shown is in a little fancy comb and beeswax.

R. A. B. & Co.

PHILADELPHIA, PA., Apr. 22.—We quote: No. 1 white, 9@10c.; fancy amber, 8@9c.; fancy dark, 7@8c. Extracted, white clover, 10c.; amber, 5@5½c.; dark, 4@4½c. Beeswax, 25@26c. Comb honey is dull. Extracted in fair demand. Beeswax lower. W. A. S.

KANSAS CITY, Mo., Apr. 18.—We quote: No. 1 white, 13@14c.; No. 1 amber, 11@12c.; No. 1 dark, 8@10c. Extracted, white, 5@6c.; amber, 4½@5c.; dark, 4@4½c. Beeswax, 25c. C. C. C. & Co.

BUFFALO, N. Y., Apr. 20.—We quote: Fancy white, 15@16c.; No. 1 white, 13@14c.; fancy dark, 8@9c.; No. 1 dark, 7@7½c. Beeswax, 25@28c. Trade very dull and honey not moving, except a few fancy lots; anything dark is hard to sell. B. & Co.

NEW YORK, N. Y., Apr. 20.—We quote: Fancy white, 14c.; No. 1 white, 12c.; No. 1 amber, 11c.; No. 1 dark, 8c. Extracted, white, 5½@6c. Beeswax, 29@30c. Market is quiet. Some demand for white comb, but buckwheat not wanted. White is selling at from 11@14c. and buckwheat at 8c. The market on extracted is unusually quiet, with large supplies of California. Beeswax steady at quotation. H. B. & S.

CINCINNATI, O., Apr. 22.—There is no fancy white comb honey on our market. Best white sells at 12@14c. in a jobbing way, with a fair demand. Demand is good for extracted at 4@7c., according to quality.

Beeswax is in good demand at 25@30c. for good to choice yellow. C. F. M. & S.

Bottom Prices

**BRING US BIG TRADE.
GOOD GOODS KEEP IT.**

If you want the best supplies that can be made at a little less cost than you can buy the same goods for elsewhere, write to us for low prices. 1896 Catalogue now ready—ask for it and a free copy of **The American Bee-Keeper** (36 pages).

Address,
**THE W. T. FALCONER MFG. CO.,
JAMESTOWN, N. Y.**
Mention the American Bee Journal.

COMB FOUNDATION!

Wax always wanted for Cash or in Exchange for Fdn. or other Supplies. My trade is established on **Low Prices** and the merit of my **Foundation. Orders filled promptly.**
WORKING WAX INTO FDN. BY THE LB. A SPECIALTY. Wholesale prices to dealers and large consumers. Send for Prices and Samples to—**GUS DITTMER, AUGUSTA, WIS.**
Reference—Augusta Bank. 1Atf
Mention the American Bee Journal.

ROOTS GOODS Prices Reduced on Dovetail Hives and Sections. A full line of Apian Supplies in stock to fill orders promptly at lowest prices for Best Goods. 36-page Catalogue Free.
JNO. NEBEL & SON, High Hill, Mo.
Mention the American Bee Journal. 4A26t

I ARISE



TO SAY to the readers of the **BEE JOURNAL** that **DOOLITTLE**

has concluded to sell **—BEES and QUEENS—** in their season, during 1896, at the following prices:

- One Colony of Italians on 9 Gallap frames, in light shipping-box \$3 00
- Five Colonies..... 25 00
- Ten Colonies..... 45 00
- 1 notested queen. 1 00
- 6 " queens 5 50
- 12 " " 10 00
- 1 tested Queen... \$1 50
- 5 " Queens. 3 50
- 1 select tested queen 2 00
- 5 " " Queens 4 00

Select tested queen, previous season's rearing . 4 00
Extra Selected for breeding, THE VERY BEST.. 5 00
About a Pound of BEES in a Two-frame Nucleus, with any Queen, \$2.00 extra.

☞ Circular free, giving full particulars regarding the Bees and each class of Queens.
Address

G. M. DOOLITTLE,
12A25t **BORODINO, Onond. Co., N. Y.**
Mention the American Bee Journal.

BEES QUEENS
Smokers, Sections, Comb Foundation, And all Apian Supplies cheap. Send for FREE catalogue. **E. T. FLANAGAN, Bellefonte, Pa.**
6A26t Please mention the Bee Journal.

HANGIT ON

the top of one of our four cornered, double braced, steel towers and it will stay there. They have done that through worst storms of recent years. Many sizes and all from best material. Full line of Tanks, Shelters, Cutters, Pumps, Horse Powers, &c. Write us. Challenge Wind Mill & Feed Mill Co., No. 18 River Street, Batavia Illinois.



Mention the American Bee Journal.

19th Year Dadant's Foundation 19th Year

Is still in the lead, for we use all the latest improvements, including the

NEW WEED PROCESS,

and still make the best goods. Remember that we do not use any acid to purify our beeswax, and that is why our Foundation preserves the smell of the honey and is more acceptable to the bees, than any other. It is kept for sale by

T. H. Strickler, Solomon City, Kansas.
G. K. Hubbard, Fort Wayne, Ind.
L. Haussen, Davenport, Iowa.
C. Theilmann, Theilmanton, Minn.
E. C. Eaglesfield, Berlin, Wis.
E. T. Abbott, St. Joseph, Mo.
J. M. Jenkins, Wetumpka, Alabama
John Rey, East Saginaw, Mich.
Vickery Bros., Evansville, Ind.

The Jennie Atchley Company, Beeville, Texas.
C. F. Muth & Son, Cincinnati, Ohio
E. Kretzmer, Red Oak, Iowa.
G. B. Lewis Co., Watertown, Wis.
James Reynolds Elevator Co., Ponghkeepse, N. Y.
Louisiana Bee-Keeper's Supply Manufactory, Donaldsonville, La.
Page & Lyon, New London, Wis.

and many other Dealers. All agree in saying that no goods are better than ours.

Those of our customers who formerly bought through Thos. G. Newman can get our Foundation in **Chicago, Ill.**, by addressing us at **118 Michigan Street**. We keep no other goods there.

We make a specialty of **Veils and Veil Stuffs** of best quality, cotton and silk.

"LANGSTROTH ON THE HONEY-BEE"—Revised.

Bee-Keeper's Supplies, Smokers, Sections, Tin Pails, etc.
Samples of Foundation and Tulle FREE with Circular. Instructions to beginners with Circular. Send us your address.

CHAS. DADANT & SON,

Mention the American Bee Journal.

HAMILTON, Hancock Co., ILL.

26c Cash Paid for Beeswax!

For all the **good, pure yellow BEESWAX** delivered to our office till further notice, we will pay 26 cents per pound, cash; or 30 cents for whatever part is exchanged for the American Bee Journal, Books or Seed, that we offer. If you want **cash promptly** for wax, send it on at once. Dark or impure wax not taken at any price. Address plainly,

George W. York & Co., 118 Michigan St., Chicago, Ill.

Lower Prices on Sections & Foundation

Improved facilities, increased output, and competition, together with hard times, tend to lower prices.

Root's No. 1 White Extra-Polished Sections

are superlative in quality, and are now offered for a short time at the following special prices for 4 1/4 x 4 1/4 any stock width: **1000, \$2.50; 2000, \$4.50; 3000, \$6.45; 5000, \$10.00.**

Cream Sections of such widths as we have in stock at 25c per 1000 less than the white.

The New Weed Process Comb Foundation

is superior to all others in every way, showing, from recent tests in Florida, five times greater resistance to sagging, making it possible to use a lighter grade with more feet to the pound, with greater safety than with the old process. Owing to decline in wax we reduce price of Foundation **3 cts.** a pound. Prices now are:

	Price per lb. in lots of 1 lb.	10 lbs.	25 lbs.	50 lbs.
Heavy or Medium Brood Foundation.....	44c	43c	42c	40c
Light Brood.....	47c	46c	45c	43c
Thin Surplus.....	54c	53c	52c	50c
Extra-Thin Surplus.....	59c	58c	57c	55c

Lower prices on 100-lb. lots, and dealers supplied at special prices.

These wholesale dealers who handle Root's Goods in carload lots unite with us in above prices:

**Walter S. Poudet, Indianapolis, Ind.; John Nebel & Son, High Hill, Mo.
Joseph Nysewander, Des Moines, Iowa; Wm. A. Selser, Philadelphia, Pa.
M. H. Hunt, Bell Branch, Wayne Co., Mich.; Geo. E. Hilton, Fremont, Mich.**

THE A. I. ROOT CO., MEDINA, OHIO.

**118 Michigan St., Chicago, Ill.
1024 Mississippi St., St. Paul, Minn.**

**Syracuse, N. Y.
Mechanic's Falls, Maine.**

AMERICAN BEE JOURNAL

DEVOTED EXCLUSIVELY TO THE INTERESTS OF HONEY-PRODUCERS

ESTABLISHED IN 1861
THE OLDEST BEE-PAPER IN AMERICA

Published Weekly, at \$1.00 per annum.

Sample Copy sent on Application.

36th Year.

CHICAGO, ILL., MAY 7, 1896.

No. 19.



Hints on Spring Management of Bees.

BY MRS. J. N. HEATER.

As so much of the season's success depends upon the work done or undone at this time of the year, too much care cannot be exercised to avoid expensive blunders. Every colony should be put in such condition as to strength that it will have a large and effective force of foragers ready to take advantage of the first honey-yield. Every apiarist should, and is supposed to, know when to expect the first yield of nectar, and of course will act accordingly.

Stimulative feeding should be practiced with prudence and judgment, if at all, and only diluted syrup or honey should be used. If the bees are stimulated beyond their strength, the intervention of two or three cold days and nights may chill the brood thus reared, owing to the colonies not being strong enough to cover it. Not only is the loss of the brood sustained, but there has been a heavy tax on the vital forces of the nurses which cannot be regained.

As a rule, it is better for beginners to see that food enough is supplied for the wants of both bees and brood, cut off upward ventilation by laying a board or enameled cloth over the frames, and let them alone. If some of the colonies are light in bees, they may be strengthened by occasionally giving a frame of hatching brood from some strong colony which will suffer no injury from the loss of it. But this, even, must be done cautiously, and no old bees carried from one hive to another, as that is one of the easiest ways in the world to start robbing.

The spreading of brood, like stimulative feeding, is more often a harm than a help; although an experienced apiarist might be able to practice either to advantage, knowing to a nicety, as he does, just how and when to make such manipulations.

While it is not advisable to bate the bees out too early, when the weather is unsettled, and there is danger of loss from cold winds, yet when the time comes that they will persist in searching for natural pollen, it is economy to furnish them with rye flour in convenient places sheltered from the wind. Little troughs of water in sunny locations complete their bill of fare, and they are content to take care of themselves.

Columbus, Nebr.

Some Bee-Notes from California.

BY PROF. A. J. COOK.

THE BEE-KEEPERS' EXCHANGE.—It is unfortunate for the California Bee-Keepers' Exchange that the present season is so unpromising for a honey crop. As yet, we have received only about nine inches of rain, while, according to all reports, 15 inches is necessary for a good honey crop. True, we may get more, but bee-keepers or ranchmen do not expect much rain after this date. Thus, it looks very much at present as though the honey product of Southern California, the present season, would be like that of two years ago—nothing. Yet I do not believe the bee-keepers will be discouraged, or will give up the new organization. Those in the regions of orchards and alfalfa fields will doubtless get something of a crop; and others have already reaped advantage in the lower prices which they have had to pay for supplies. I very much mistake the temper and spirit of our bee-keepers if they let the



Mrs. J. N. Heater, Columbus, Nebr.

discouraging prospect discourage them. We will hang to The Bee-Keepers' Exchange, and be ready with the next harvest to secure a price that shall pay us for our labor in securing the crop.

I quite agree with a recent writer in Gleanings, that every State in the country ought to follow the example of California, then we should have full control of the honey, and could de-

mand remunerative prices. I believe this is a matter that should be talked up in all the associations, State and National, and we should not "cry quits" until the whole country was organized. This consummation will surely be realized in the not very distant future; whether we shall reap the advantages depends upon whether we are ready to act with energy and effect.

FOUL BROOD.—The subject of foul brood is a very practical one in many of our bee-keeping regions. I know a bee-keeper not very far from Claremont in whose apiary a year ago there were five or six colonies diseased with foul brood. At my suggestion, that those colonies should be treated, and certainly better be destroyed than to be left to spread the disease, he remarked that he thought his bees had had it before, and they got well. He now reports very sadly that every colony in his apiary has the disease. He feels very badly, and has double reason for his condition.

It seems to me that every bee-keeper in the country should be thoroughly informed regarding this malady, and that we should have such laws and inspection as would protect bee-keepers against this evil. Ontario, Canada, has given us a very wise example in this direction.

BUCKTHORN AS A HONEY-PLANT.—One of the most common group of plants in California is the buckthorn. There are many species of these shrubs, and all are very prolific of flowers. One, the California lilac, resembles quite closely the lilac of the East, and is very beautiful. Most of them, however, are white, and as we go through the brush-wood, we are constantly running upon these plants. I am happy to say that they are very attractive to the bees. I find the shrubs alive with these little insects, bearing away their heavy load of pollen and honey. As they bloom in late March and early April, before the sage and buckwheat are in blossom, they are quite valuable as early bee-forage. This is especially true in out-apiaries away from the orchards. The genus of the buckthorn is *Ceanothus*, of which genus there are a large number of species. Like nearly all of the bee-plants of California, these buckthorns are a long time in bloom, and are thus far more valuable as honey-plants than they would otherwise be.

ORANGE-BLOOM AND BEES.—During the last few days the hum of the bees has been very constant and very loud in all the region about Claremont. The orange orchards are in full bloom, and the odor is not only very perceptible in the streets near by the orchards, but is borne by the winds to regions far distant, even to apiaries miles away; thus swarms of bees are passing from the apiaries to the orange orchards in quest of the nectar.

Appropos to the above, I would say that I know of no honey more delicious than that from the orange-bloom. As we might expect, the flavor reminds one decidedly of the odor. I have often secured enough fruit-blossom honey in Michigan, so that I could test its quality. I always found it very delicious. There was a delicate reminder of fruit preserve which was altogether agreeable. Thus I was not surprised to learn how exquisite this orange-blossom honey is.

BEE-MARTIN OR KINGBIRD.—It is a fact beyond question that the bee-bird, or bee-martin, or kingbird, *Tyrannus tyrannus*, destroys bees, both drones and workers, in the Eastern States, often to quite an extent. We also have a bird said to destroy bees here in California. It belongs to the same genus as the one already mentioned. These birds sit on a perch, and as the bee comes towards the hive, darts after it, catches it in its bill and flies back to its perch. It is then seen to go through certain motions, after which the bee is swallowed, and it is ready to repeat the operation. I am very curious to know what becomes of the bee's stinger. From what we know, we should expect that the bird would certainly get

stung in the throat as it swallows the bee. I have seen toads swallow bees, and, upon dissection, I found just as many stings in the toad's throat as there had been bees swallowed. In this case, of course, the toad is either callous against the stings, or else not sensitive to the poison. Is it possible that in the case of the kingbird the sting is extracted before the bee is swallowed? True, this would require no little intelligence: but I think many of our lower animals are brighter than we give them credit for being. We should suppose that an animal as highly organized as a bird, and especially as these fly-catchers, would be injured if stung so much in the throat, mouth, oesophagus or stomach. I wish those who have opportunity to observe this matter would kill and dissect a bird and find what is the truth in the matter. If, as is probable, the bees are found without their stingers, then the latter should be looked for in the anterior part of the alimentary canal of the bird. Years ago I dissected kingbirds and found worker-bees in their stomachs, but I regret to say that I never thought of the stingers, and so made no observations in reference to this point.

Claremont, Calif., April 21.



United States Association of Bee-Keepers' Societies.

BY W. F. MARKS.

Heartily approving Mr. Brodbeck's suggestion on page 195, to organize a National Bee-Keepers' Association, I should like to submit a few thoughts in connection with that subject.

We have had in this State, for some time, an organization known as the New York State Association of County Agricultural Societies. Its object was "to secure by association and co-operation greater efficiency in the operation of the various county societies." It was a power that could dictate Legislation and other matters, but about two years ago the town-agricultural societies organized an association that has proved more formidable and of greater influence than the association of county societies. I mention this to show the importance and necessity of local organizations, however small, and the power they command when combined.

"Little drops of water, little grains of sand,
Make the mighty ocean, and the pleasant land."

This is the correct way to organize and maintain a National Bee-Keepers' Association. Let all the bee-keepers' societies in the United States combine and organize the *United States Association of Bee-Keepers' Societies*. This can be easily and satisfactorily accomplished by the selection and assembling of an equal number of delegates elected for that purpose from each society. By this method you will have an organization that is representative, and will command the confidence and respect of all. In this case the small or local societies are the very roots of the organization—not the branches, as was the case under the old auxiliary or affiliated system. And there would be an object in organizing and maintaining bee-keepers' societies in localities where at present none exist.

There should be such a society in nearly every county, and we should insist upon having at least one in every congressional district.

I sincerely believe that the plan suggested will be an inducement for the bee-keepers of every locality to form societies that collectively will result in an organization of the bee-keepers of this country worthy of the name; they will feel that their local society, however small, is an important link in a well-organized and successful National Association, where all members and all localities have an equal voice.

Chapinville, N. Y.



See "Bee-Keeper's Guide" offer on page 301.

Bee-Keepers' Union—Honey Competition and Prices.

BY DR. C. C. MULLER.

Referring to page 242, I think Mr. Newman is not warranted in characterizing as an "unkind fling" what was a plain statement of fact, and I am sure it was given with no malice forethought. He thinks my language misleading and unreasonable when I say, "There's no use blinking the fact that it is now on the down-grade as to members." He says it is no more on the down-grade than other institutions, but that has nothing to do with the case. I wasn't saying whether it was more or less successful than other institutions. I was only saying it was on the down-grade as to numbers. He says, "Last year its decrease was only 20 per cent.;" and whenever I can see that a falling off of 20 per cent. isn't being on the down-grade as to numbers, I'll gladly retract.

For I'm sure I want to see the Union on the up-grade, and I'm sorry to see so many misunderstandings concerning its union with the North American. Witness the absurdity of the idea that amalgamation would oust the present Manager, and that amalgamation could not be effected because then it would be international, while the Union has always been international, and a Canadian had 16 votes at the last election.

The latest is from G. A. Millard, on page 254. Like a good many others, he seems to think that the advocacy of amalgamation comes mainly from members of the North American who are not members of the Union. I wish he would take the trouble to look the matter up and give us the names of those who have advocated amalgamation who are not members of the Union. He wants the advocates of amalgamation to "walk up and pay their \$1.00 like the rest of us." Give us the names of those who haven't paid their \$1.00.

But there's nothing new about that error. The new part comes when he wants them not to "tack onto members who do not wish it, the expense of expensive meetings." Who ever dreamed of such a thing? Each person has always paid his own expenses, and I don't know that any one has thought of anything different. It is just possible that Mr. Millard might mean the incidental expenses of the meeting, but hardly that, for he would hardly call an expensive meeting one whose expenses didn't reach a hundred dollars.

REPLY TO G. M. DOOLITTLE.

Mr. Doolittle, I don't—that is, I'm not entirely sure I can answer all your questions, but I'll make some effort in that direction, and as you refer to matters in preceding numbers, it's a pleasure to know that all the numbers of the "Old Reliable" for this year are before me, safely anchored in a wood binder. If you haven't tried one of those binders, I'm pretty sure you ought to, for I think you would be pleased therewith.

The first question (on page 255) is, "Why do you object to California honey coming to the Chicago market?" Before I can answer that, I must ask you to show me the place or time when I made such objection. I don't quite dare to say I never said anything of the kind, for you're such a hand to remember and refer to what has been said, that I don't want to run any risks. But I'll only go so far, just now, as to say that I have no present recollection of having objected to California honey coming to Chicago. And as all the rest of the questions in the same paragraph are on the same basis, I must ask to postpone the answers till I know what I said against California competition.

Your next question wants to know why so many mouths are watering for honey while you and I are growling at low prices. Say, Doolittle, between you and me don't you think it's a mean trick of you to take advantage of a fellow the way you do by barring him out from the use of the only available answer he has on hand by saying in advance, "Please do not

say, 'I don't know?'" Whatever other reasons there may be why so many people don't eat honey, I think one of the reasons is that they are ignorant and imagine that honey is a luxury they can't afford, when in reality it is a better and cheaper food than they suppose. I don't suppose many people know that children will be better satisfied and nourished with a pound of honey than with a pound of butter.

You next ask why hardly as much honey is consumed now as when there were only half as many people and honey three times as high. I didn't know that was so, but supposed there was more used now. If there's hardly as much used now, isn't the principal reason that it isn't produced? For I have some doubt whether there would be such a wonderful sight more produced if the price was higher. Don't most bee-keepers produce all they can, and all they would if prices were higher? I'm not sure that I'd produce a pound more if prices were doubled. Would you? Then again I think, as I have already said, that more honey would be used if people knew its intrinsic value. Mr. Martin may be right, that people prefer glucosed honey at a lower price, but that's again just the same ignorance on the part of the people. They don't know how much better the pure article is.

You want to know why I'm growling over low prices when a pound of honey will buy just as much wheat, potatoes or land as ever. Well, maybe I've growled more than I ought to, and at first blush it looks as though I had no reasonable excuse for growling if relative values kept all the same, the honey of this year buying just as much as the honey of other years. But right there's the trouble. In spite of the way you've put it, the honey of last year wouldn't begin to buy as much as the honey of former years. At least it wouldn't with me. Very true, a pound of it might, but a crop of it wouldn't, and when a day's labor brings more wheat than formerly, and a day's labor brings less honey than formerly, you can hardly expect me to feel satisfied with as much wheat as I used to get for a pound of honey. See? If I could get the same crop of honey now for the same labor as formerly, then I ought not to complain at swapping for the same amount of wheat as formerly, but if I can only get one pound where I used to get two, then I don't feel that the price of honey ought to keep step with that of wheat and other things in their downward march.

Now I'll not feel the least hurt if you'll fit a better answer to these questions, and while you're at it I'll give you another question to answer lest you fire it at me: Why is it that there's so little difference in the price of honey whether the crop is large or small?
Marengo, Ill.



Bees and Fruit—That Horticultural Fable.

BY W. S. FULTZ.

MR. EDITOR:—On page 184, under the head of "A Horticultural Fable," you publish and then comment on an article from Meehan's Monthly for December, in which you say that a bee cannot puncture a grape in any part.

Now, Mr. Editor, I have been a fruit-grower for 22 years, and I also have been a bee-keeper for over 40 years, and I do know that bees can and do puncture grapes and other fruit, and knowing it to be a positive certainty, I feel just like the writer of that article, that is, that bee-keepers must have some sinister motive in endeavoring to educate the public that bees cannot destroy fruit.

I have had hundreds of boxes of berries destroyed by bees in a single season. I have seen bees work so thickly on raspberries and strawberries that from three to five bees were on every ripe berry in the patch. I have known bees to attack berry-patches with a fury that was irresistible, and drove the pickers entirely away. On such occasions I have looked in vain for the birds, wasps, and hornets, that bee-keepers and

bee-editors tell us puncture the skin so that the bees can suck the juice.

I have also had bees to work on my grapes to such an extent that the damage was serious, and at such times I never could see the birds, wasps, and hornets, that so obligingly came and punctured the skin for them. I also have watched the bees at such times, and have seen them alight on a whole grape, whose skin was unpunctured, and when the bee left the grape the puncture was visible.

Now, Mr. Editor, you knew better than to make the assertion that a bee could not puncture the skin of a grape—for if such is the case, will you please tell us how they sometimes enlarge the entrances to their hives when too small? Do they hire their second cousins—the wasps and hornets—or do they get the birds to peck the wood away?

A few years ago, if I remember rightly, Dr. C. C. Miller and Mrs. L. Harrison had quite a controversy on this matter, of how the bees managed to enlarge the entrances to their hives when necessary. Dr. Miller said they had a biter and bit the wood away; and Mrs. Harrison just as earnestly asserted that they did not have a biter, but that they had a picker, and picked the wood away. Now, I am not quarreling with the Doctor or the lady, but both are good authority among bee-keepers, and it doesn't make any difference whether the bees have a biter or a picker, the same instrument that enables them to cut away the hard wood of a hive will enable them to puncture the soft skin of a grape or other fruit.

In the fall of 1865, I purchased a copy of "Langstroth on the Honey-Bee," and studied it during the winter, and the next spring I transferred some of my bees from their box-hives into Langstroth hives, and, as recommended in the book, I tied the combs with cord, and the bees cut the cord to pieces, and carried it out before they had properly fastened the combs, and I had a sorry mess on my hands. I don't know whether the bees used a biter or a picker to tear that cord to pieces, but I firmly believe that they did not hire any wasps or hornets to do the work for them, and that the same instrument that enabled them to cut that cord to pieces could be used to cut the skin of any kind of fruit.

Along about the summer of 1870, before sections came into use, we used 5-pound boxes in which our bees stored their surplus honey. It was an extraordinarily good season for honey, and I ran short of 5-pound boxes, and made boxes of thin lumber; these boxes were 5 inches wide and 16 inches long, with a pasteboard bottom, in which were cut holes to fit the holes in the honey-boards on the hives. There were some 30 of those boxes, and the bees cut the pasteboard bottoms to pieces and carried them out of the hives, and I don't believe that they hired the wasps and hornets to help them do it, but that they did it with their biter or picker, and the same biter or picker that enabled them to tear that pasteboard to pieces, would enable them to tear open the soft skin of a grape, or any other fruit.

Of later years, we have been using sections in the surplus arrangements on our hives, and we cover some of them with enameled cloth, placing the smooth side down, and we have had several of those covers eaten through by the bees, and I firmly believe that it would not be any more of a task for bees to eat through the smooth skin of a grape than for them to eat through the cloth.

There are other points in that comment that I would like to notice, but it would require too much time and space, but I want to say that it is not to be wondered at that horticulturists are getting disgusted at the patronizing manner in which bee-keepers seek to teach them about their own business, and insinuate that they (the horticulturists) lack the brains necessary to know their own business.

[See page 296.—Ed.]

Muscatine, Iowa.

Working Weak Colonies for Comb Honey.

BY G. M. DOOLITTLE.

Soon after writing my last article for the American Bee Journal, I received a letter from a correspondent telling how glad he was that I was to write a few articles on working bees so as to secure comb honey, and desiring that I would give an article on how he could best work weak colonies so as to secure comb honey from them, as many of his colonies were coming out weak this year. After reading this letter I came to the conclusion that I had best give an article on this subject, although I had not intended so to do.

In going over the apiary for the first time in the spring, as spoken of on page 194, I do so by beginning on one side of the yard and opening the first hive on the first row, and thus continuing, taking row by row, so that there may be system to the work, and should I not get over the yard in one day, or be called away from some cause, I may know just where I left off, etc. If the bees have not wintered well (as evidently our correspondent's bees have not, else they would not be weak), I may find this first colony has brood in only two frames, and only small patches at that, while the little honey there is in the frames is scattered throughout the hive. To best fix them, I take the two frames having the brood in and set them close to one side of the hive, and then take all the other combs (after brushing the bees off which may be straggling on them) to the shop. After getting a comb well filled with honey from the shop, which was left over from the previous season, I return and place it close beside the other two combs having the brood, after which a division-board is nicely adjusted to suit the requirements of the little colony, when the quilts are carefully tucked about them on top and down the side of the division-board, and the entrance to the hive is now regulated so but one or two bees can pass at a time, and is so fixed that it comes beyond the division-board, thus shutting off the cool outside air from coming directly upon the bees.

I now place a small stone in such a position on the cover that it tells me in the future at a glance that this is a weak colony and how it is fixed, when I pass on to the next.

This colony proves a good one, and needs no fixing save as I have already given in the articles before this.

The next one proves to be hardly a fair colony, and has brood in only three or four combs, hence should be treated similarly to the first, except that a frame of honey is placed on either side of the brood, for such colonies are often apt to get short of stores, as they have few bees to gather from the early flowers, and are feeding much brood in proportion to the number of old bees in the hive.

In going over the yard the second time, I commence at the same place I did when first looking the bees over, and upon opening the hive I look for the queen to see if her wings are clipped. This clipping part I forgot to speak of in the previous articles. In working for comb honey we are quite apt to have swarms, and if the queen has her wings in perfect condition she may go off with the swarm to the woods, or we be bothered with swarms uniting, or climbing high trees after swarms, etc. I know some do not favor queens with clipped wings, but after an experience with them both ways, I still adhere to the practice, and believe, *all things considered*, that it is one of the things which pays in the apiary.

If I find the queen has not been clipped, I now cut her wing, which, being done, I observe the brood in the two frames, and if I find it near one end of the frames, I change ends with one of the frames, which causes the bees to fill the other ends with brood. If there is still plenty of honey the hive is closed, the stone put on another part of the cover to the hive to tell what was done there last, and a mark made to show that the queen has her wing clipped.

How the next or full colony is treated, I told you about in my last article.

The colony having brood in three or four combs is now looked after, the queen's wing clipped, if not already so, and the amount of brood noted, as well as the amount of honey. If they do not have honey enough, a frame of honey is set over beyond the division-board so they can run under and get as they want, for our object now is to keep this colony on the five frames they already have till they are literally full of brood. In this way we keep the strongest of the weak colonies till they have five frames of brood, when one frame is taken, which has the most mature brood in it, and given to some colony not quite as strong which has only four combs of brood. The next time over these weak colonies, a frame of as nearly mature brood as possible is taken from each of the colonies now having five frames of brood, while each time a frame of brood is thus taken from any colony a frame of honey is put in the place of it, the same as we did in the strong colony to stimulate brood-rearing.

The next time frames are taken from each of the colonies having five frames of brood and given to those having only two frames, for by this time it has become warm weather, so there is no danger from chilling brood with the weakest we had at the beginning.

Thus I keep working till all that are weak colonies in the spring contain five frames of brood, which should occur about June 20, in an average season in this locality.

I now go to hive No. 1 and open it, looking the frames over till I find the one the queen is on, when it is set outside of the hive and the four remaining frames, with all the adhering bees, and taken to No. 2. I next spread apart the frames in No. 2, so as to set the four frames brought from No. 1 in each alternate space made by spreading the frames in No. 2, when the hive is closed. In a few days this colony will be equal to the very best in the yard, and if it does not store as much comb honey as any of the best colonies you had in the spring, it will turn out differently with you than it does with me.

In this way I get as much comb honey from two weak colonies in the spring as I do from one of the very best, and make a good nucleus out of the frame which had the queen on it, besides. I might tell what I do with this nucleus during the season, but it would make this article too long, and, besides, it is foreign to the production of comb honey.

Borodino, N. Y.



Timely Articles—Other Suggestions.

BY WM. S. BARCLAY.

I can conceive scarcely anything in the course of our labors which affords such a treat as a well-written article descriptive of some implement, or some particular manner of work, which will lead us to success, and at the same time save labor in the apiary and the workshop; and to receive the instructions therein contained at a time when we can put them at once to a practical test, is still a greater pleasure. That we cannot have such a pleasure at all times is certainly our misfortune, but that such is the case, we all well know, as, for instance, it almost always happens that at the swarming and honey-gathering season, many things happen which we would be glad to make known to our fellow bee-keepers, but by reason of weariness from work, and being pressed for time, we are deprived of giving the pleasure we are all so anxious to receive.

HEATING HONEY.—Such an article as above referred to, was the one on page 36, on "Experiments in Heating Honey," by Hon. R. L. Taylor. At the time it came to hand, I was engaged in liquifying candied honey, and it may be imagined I perused it with much satisfaction, and although I have been using much the same process heretofore in restoring honey to its original state, there were implements described and sug-

gestions thrown out as regards temperature, etc., which I shall hasten to put to practical use, and I cheerfully embrace the present occasion to heartily thank Mr. Taylor for his valuable suggestions.

BEES SPORTING.—I observed on page 34, that Dr. Miller (who with Doolittle is the first I look for when I get the Bee Journal) does not like my idea "that old, as well as young, bees sport before their hives." Well, I fear I cannot resist the conclusion I advanced when stating the above opinion, neither do I think the Doctor will if he observes carefully. It is certainly easy to distinguish between a young, fuzzy Italian and a smooth, aged one—the difference in color of both of these on the wing is plainly visible. Now keep your eyes on the darker ones (old bees) until they alight on the entrance-board, and you will soon learn whether the old bees engage in "sporting." If you do not reach the same opinion as myself, I must think that you are breeding a different strain of Italians from those I have propagated with the greatest care since 1861, when I got my first Langstroth queen (Italian).

SMOKER-FUEL.—But what will our neat, cleanly lady bee-keepers say to the Doctor for his apparent endorsement of a smoker-fuel (on page 33), by his answer to a question on this point? While on this subject, let me say that probably the cleanest and most lasting smoker-fuel is fine chips from sugar-tree or maple. As a cheap fuel, I find to take old newspapers (thick carpet paper is better), put them in loose rolls about two inches in diameter, and soak them in pretty strong salt-petre water, and then thoroughly dry them. I find nothing cheaper or more convenient.

Beaver, Pa.

Questions AND Answers

CONDUCTED BY

DR. C. C. MILLER, MARENGO, ILL.

[Questions may be mailed to the Bee Journal, or to Dr. Miller direct.]

Honey or Sugar for Spring Feeding.

Which is the cheaper for spring feeding of bees, dark extracted honey at 4 cents a pound, or granulated sugar at 6 cents a pound?

H. L.

ANSWER.—Now, look here, you can figure that as well as I can, and I'm just a little afraid you're trying to show how much I don't know. But let's figure it up together, and you watch whether the figuring is all right. About 2 pounds of water to 5 pounds of sugar will make, if I am not mistaken, a syrup about equivalent to honey in consistency. The 5 pounds of sugar cost 30 cents, and as the water is free, that makes 7 pounds of syrup at 30 cents, or 4 2/7 cents per pound. So the 4-cent honey is the cheaper of the two, providing figures don't lie, which they sometimes do. But it's possible that bees will consume more of the honey than of the sugar—R. L. Taylor found they used more honey than sugar in winter—and that might turn the scale to make the sugar cheaper. On the other hand, 5 pounds of sugar and 2 of water don't make 7 pounds of syrup, for there's some evaporation, so that brings up the cost of the sugar again. Guess you'll spend less money to buy honey at 4 cents than sugar at 6 cents.

Now I want to ask another question I'd like to have you answer. With honey at 4 cents and sugar at 6 cents, which had I better use for spring feeding? For it may be that

what's cheapest isn't always best. Supposing the cost figures out exactly the same, and you have the honey on hand, I'll give some reasons why I'd prefer the honey. I have something of an idea that while sugar may be just as good for fuel, it may not be quite so good as honey to rear strong young bees. The honey is on hand, all ready to use, unless it be adding some water, and using the honey avoids the trouble of making the exchange. If you use the honey, no prying neighbor will say you fed sugar to make honey, and there's more danger of harm from that kind of thing in spring than in fall. Using the honey is just so much help to the honey market. Now, what do you say?

Sections with Comb Built by Foul-Broody Colonies.

Is there any danger in using sections that have been built full of combs by foul-broody colonies? Would there be any danger of starting foul brood? They would be fine "baits," as they are white, and no honey in them. SUBSCRIBER.

ANSWER.—Very certainly. Don't think for a minute of using them. Melt up the wax and burn up the wood. If any honey is left by the melting, you can eat it yourself, but be very sure no bees can get hold of it. It's hard to be too careful about the dread disease.

Bee-Diarrhea Prevention.

I am looking for an article on bee-diarrhea or bee-paralysis. I have lost 40 colonies with it, mostly. Is there anything that can be done after it commences in a colony?
Tuttle's, N. Y. A. P.

ANSWER.—By this time, without doubt, a perfect cure has been accomplished, for no better cure exists than a good flight. Indeed, it is somewhat doubtful whether there is any other cure, although some think that heating up the cellar in which bees are kept goes a long way toward a cure. At any rate, cases have been reported in which a temperature of 60° to 80° maintained for a short time seemed to leave the bees in much better condition. In general, attention must be given to prevention of diarrhea rather than to cure. This must be done in fall, by seeing that they have proper stores in good season, and by taking all care as to ventilation and protection.

Transferring—Finding Black Queens, Etc.

1. I have four colonies of bees, two in dovetailed hives and two in odd-sized movable-frame hives. I desire to get the latter two into standard hives. I consulted "A B C of Bee-Culture," and about four weeks ago I put a new hive with frames filled with foundation on top of one of these old hives. The book says that after the queen has begun to lay in the new hive, the old hive can be removed, and the bees will be in the new hive. My bees have filled the new combs nearly full of honey, and left no room for the queen to lay in the new hive. Now, if I put on a super, will the bees carry the honey into the sections, and make room for the queen to lay, or what would you advise?

2. The past week has been cold, windy weather, and I notice one of my hives has a large number of dead bees on the ground around it. Does this denote anything serious?

3. My bees are common black ones. I would like to get Italians, but I am afraid if I should get new queens I would not be able to find the old queens to remove them. I have looked over my bees several times, and have never seen a queen but once. Can you give any good rules for finding a queen?

4. After receiving a queen by mail, how long can she be kept before introducing?
California. C. E. D.

ANSWERS.—1. Yes, you can put on a super and the bees will empty out cells for the queen, but you should uncap the cells in the central part where the queen is likely to lay. You can slice off the cappings with a knife, or scratch over the

cappings with a three-tined fork having its tines wired together so they will measure about $\frac{3}{8}$ of an inch across, or perhaps you will like still better a wire hair-brush to pound over the cappings.

2. Very likely it's all right.

3. There are no sure rules for finding a queen. It's somewhat a matter of patience and practice. And yet attention to some things will help very much. Go at it as quietly as possible, using very little smoke, as smoke and rough handling will alarm the bees and set them to running, and then you might as well give up the job till another time.

If you anticipate trouble in finding a queen, try this plan: Have an empty hive at your side. Lift out the first frame nearest you, and after looking somewhat carefully for the queen, put it in the empty hive on the side next to you, but at a distance of an inch or so from the side of the hive. After looking over the next frame, put it close up to the one you took out first. Put the third one an inch distant from the second, and the fourth one close up to the third. Put the fifth one an inch from the fourth, and the sixth close to the fifth. Then put the seventh about an inch from the side of the hive in the same hive where it was, and the eighth close up to it. Then the ninth an inch or so distant, and the tenth close to the ninth. Now you have the combs in pairs, three pairs in the empty hive, and two pairs in their own hive. The tendency of the queen is to get in out of sight, and so where she happens to be she will get in the middle between the two combs that form the pair. Commence then in the extra hive, lifting out the comb next to the one that is farthest from you. As you lift it out, glance over the surface of its mate to see whether the queen is there, then examine the one in your hand, place it *beyond* its mate, and after examining the mate put it farthest from you, but close up to its mate. In this way go over all the pairs. Take a look at the bees clinging to the sides of the hive. If by that time you don't find her, better give it up till half an hour later, or still better until next day. For some reason it does not seem to be of much use to keep on looking if you don't find the queen after looking over two or three times, but by waiting an hour or so you may find her first thing.

Here's another way: Shake the bees off two or three frames and put them in an empty hive. Put a queen-excluding honey-board over this hive, and over this another hive, making all close between the two hives. Now take the combs one after another and shake or brush off all the bees into this upper hive, keeping a watch for the queen. The bees will run down through the excluder—if they don't go down to suit you, use a little smoke to hurry them—and the queen not being able to get through the excluder, will be seen.

4. They have been kept three weeks or more, I think, but they must be supplied with food and water.

Using Combs of Candied Honey.

I have about 40 brood-combs, and the honey in them is candied solid. Are they of any use to bees in the shape they are? What would you do with such combs?
C. C. C.

ANSWER.—Of course the combs can be melted up and the honey then used for feeding the bees, but I think I'd rather save the combs whole. If you give them to the bees they will clean out the candied honey, but it will be a waste. You may, however, save it in this way: Set a hive filled with candied combs on the stand where a colony now is, and on top of the hive containing the colony. Close the entrance at the bottom of the lower hive, and the bees in emptying the cells will let the candied honey fall to the bottom, then you can collect it and melt it to feed. They may carry out some of the grains of honey, but nothing like as much as they would if the entrance was open at the bottom. Of course the entrance must

be open to the upper hive. It will help matters if you will moisten the combs, unless they have been kept in a damp place.

If no other bees are about, you can have the work done more rapidly by setting the hives filled with the combs a few rods away from the bees, having them properly arranged to catch the granules thrown out from the cells. Better clean out every evening after the bees stop flying.

What Ails the Bees?

There are lots of bees in the hive, but they don't work much, if any. They have lots of honey. I have been trying to feed them syrup made of granulated sugar and a little maple syrup. I put it inside the hive, and then outside, and they would hardly touch it. A colony by the side of it would take it fast enough. Once in a while a bee goes in with a load of pollen, while the colony beside it brings in lots. The combs are built from one frame to the other, so I can't take them out. C. C.

Belleville, Mich.

ANSWER.—Hard to tell what the trouble is. Maybe they're lazy bees, and maybe they're queenless. Unless the combs are too badly crossed, it would be a good plan to straighten them up, cutting loose the attachments, and getting them so they are movable.



"Oil-Can Frauds" in California.

On page 220 of Gleanings for March 15 I find an item entitled "Coal-Oil Can Frauds," copied from the American Bee Journal, which strikes me very forcibly, and so I should like to ask a few questions for information.

1. What do new cans cost in the East?
2. Is the American Bee Journal interested in a can-factory?
3. Is not a good, bright coal-oil can as good as any if thoroughly cleaned and deodorized?

I think we must use coil-oil cans in this part of California, as long as we can get them, while new cans cost 29½ cents apiece. The strongest argument in favor of new cans is that they do not have to be cleaned. Some men are slovenly about anything they do, while others don't care so long as they can get their goods off their hands. This class should suffer, and not those who do their work thoroughly. In this warm climate it is an easy matter to make a coal-oil can as sweet as a rose. Perhaps you will not believe this unless I give the recipe for cleaning the can and removing the odor. It is this:

Keep the cans prepared some two or three weeks ahead of the time they will be needed. To clean, first take off the oil-faucet; punch a small hole in one corner of the can; drain out all the oil that will run; expose in the sun for a few days the cans thus drained, then use hot water and gold-dust washing-powder thoroughly. Follow this by rinsing till clean, and again place in the hot sun. In a few days it will be impossible to perceive the scent of oil in them. Cans must be left open while taking their sun-bath, and the open end up, to give the evaporating water a chance to escape.

We need some cheaper method than we now have for putting up our extracted honey; but what shall it be? We have no honey-barrels on this coast—not to my knowledge, at least; and even if we had, they would not hold honey in this climate.

[Mr. York is in no way interested in the sale of square cans; in fact, I do not believe he even knows what the cans can be bought for. It is true that second-hand oil-cans may be bought cheaply; but when we come to figure the fuss of cleaning them up, and the risk of not getting them clean, I am very much of the opinion that they will not be found any cheaper than new cans, especially when bought in car lots by

bee-keepers clubbing together. But now since the Exchange has come into existence, every member of it can buy at car-load rates. But there is one thing that you evidently do not count on; and that is, that dealers here are prejudiced against any California honey put up in *old oil-cans*, or old cans of any sort. I have no doubt that you can make the cans clean and sweet; but I am a little afraid that some bee-keepers will make a bungle of it. Let a few cans of this oily honey get in with a lot of good honey, and the whole will be condemned. Dealers will, on the slightest pretext, knock the price down, and California bee-keepers cannot afford to take any chances.—Ed.]—Gleanings.

The Low Prices of Honey.

I happen to know that, within less than 100 miles of San Francisco, amber extracted sold last summer at 15 cents per pound, or two pounds for a quarter, and comb honey is unknown save at the holidays, when it brings from 20 to 25 cents. The grocers in Los Angeles *to-day, February, 1896*, charge their customers from 8 to 10 cents per pound for honey that the producer receives only from 4 to 4½ cents for.

Is the consumer benefited by the low prices the producer has to take? Certainly not. I believe a part of those profits belongs to the producer and a part to the consumer. The question is, How are we to obtain what justly belongs to us? It is possible that, in order to help ourselves, we may have to first help the consumer.

I contend that the real remedy for low prices with us is an enlarged demand. It goes without saying, that a demand far in excess of the present supply can be created by placing honey before the consumer at a price that he can afford to pay. The consumer is the poor man; the masses are poor, and the masses must have cheap food. It is said, that for every ill there is a remedy. I believe we have our remedy within our grasp. Let us establish, through our Exchange, selling-agencies for our honey in every town and city we can reach. Let the honey be packed by the Exchange to suit any market; let it be covered by the Exchange guaranty, and be sold at *Exchange prices*. Make those prices such as will afford a fair price to the producer, a fair compensation to the agent, and it surely will be a much lower price than he now pays, to the consumer. When an agent tampers with Exchange goods or Exchange prices, bounce him. Sell no honey under any circumstances to wholesalers to be repacked—glucosed. If they want honey in small packages we will pack it for them, and put our seal upon every package.—C. H. CLAYTON, in Gleanings.

An Object Lesson.

I made up my mind that the people wanted educating, and I proposed to give them an object-lesson. I had some cards printed, saying that, if it was warm and pleasant Saturday, I would give a free exhibition on the public square at 2:30. The next Saturday was a fine, warm day, and at the appointed time I drove up with a large farm-wagon, having on it an observatory hive, a three-frame nucleus, one large hive without bees, an extractor, oil-stove, tin pails to heat water in, uncapping-knife and box, ten supers with uncapped combs, water-pail, and the same old "barrel of molasses."

Mounting the deck seat of the wagon, and taking an old fish-horn, I gave them a fish-horn and bell solo (it was not so low but that the whole village could hear it). Collecting my audience, I gave them a talk on bees and honey with a great deal of truth and information, and some nonsense mixed in, showing them the bees in the observatory hive, taking a frame from the nucleus and then from the supers, explaining the mode of uncapping and throwing it from the combs. I got a boy in the crowd to turn the crank of the extractor, letting it run into the pail; and when it was about half full I turned it into the barrel. Some of the combs I ran through the extractor five or six times, and it worked just as well.

The result was I sold my barrel of honey and all I had in the combs, and could have sold more if I had had it, and convinced the public that honey could be in barrels and not be molasses.

When I got home and counted up my cash, I found I had \$79.75 for about 2½ hours' work. As nearly as I could judge, I got about 20 cents per pound for the honey.

A week after, I went to a town of about 7,000 inhabitants, about six miles from here. I had the same show, and two barrels of honey. The police saw that no one disturbed me. I sold all my honey, took \$165 in cash, and never moved my wagon. Another community was educated. I go there now and supply the grocers, and have no trouble.—Geo. L. VINAL, in Gleanings.

THE OLDEST BEE PAPER IN AMERICA ESTABLISHED IN 1861

THE AMERICAN BEE JOURNAL

PUBLISHED WEEKLY BY
GEORGE W. YORK & COMPANY,

115 Michigan St., CHICAGO, ILL.

REGULAR CONTRIBUTORS:

G. M. Doolittle, of New York. Prof. A. J. Cook, of California.
Dr. C. C. Miller, of Illinois. Dr. J. P. H. Brown, of Georgia.
J. H. Martin, of California. Rev. E. T. Abbott, of Missouri.
Barnett Taylor, of Minnesota. Mrs. L. C. Axtell, of Illinois.
Chas. Dadant & Son, of Illinois.

\$1.00 a Year—Sample Copy Sent Free.

[Entered at the Post-Office at Chicago as Second-Class Mail-Matter.]

Vol. XXXVI. CHICAGO, ILL., MAY 7, 1896. No. 19.



The Michigan Convention was held according to notice, April 23 and 24, but the attendance was not large, as it was a little out of season, and spring work had commenced with the farmers. But a pleasant time was had. The report of the proceedings will appear in the Bee Journal shortly.

Contributions by Women.—We had hoped, in this number of the Bee Journal, to have all the "Contributed Articles" written by women, but we failed to get a sufficient number to respond to our invitation, so we must content ourselves with publishing the articles of those who did approve of our idea. Mrs. Heater's is the first (see first page), which will be followed by others in due time.

'Tis a pity that the majority of the few women bee-keepers are so modest, and backward in coming forward. But probably they can't help it, so we must be satisfied with what they feel inclined to do.

Longevity in Bees.—The April Review contained some articles on this subject taken from the columns of the American Bee Journal of 1893, by Mr. J. R. Bellamy and Dr. C. C. Miller. In a foot-note, Editor Hutchinson says:

I think that this subject of longevity among bees is a point that needs careful experiment. It would, perhaps, explain why one colony does so much better work than another that is no more populous. Just notice if the colonies that do not have so very large quantities of brood, yet store the most honey, have queens that live to an unusual age. If they do, here is a starting point anyway, to breed from the queens of such colonies. Perhaps we will soon have queens offered for sale that are bred from "queens that are five years old."

Here is a chance for the bee-experiment stations to try their hand. If Hon. R. L. Taylor "tackles" it, there's bound to be something found out.

Crimson Clover was thus written about by Mr. A. I. Root, in Gleanings for April 1:

At this date (March 27) our crimson clover has stood the winter, and especially the intense hard freezing and alternate thawing of March, almost without injury. The piece that was put in with buckwheat in July is almost a perfect stand. It

is the greenest and prettiest piece of clover I ever saw in my life at this time of the year. That sown among the early corn at the last time of cultivating, about the first of August, looks almost as well, but the stand is not as good, and so on clear up to that which was sown up into September. The earlier it was put into the ground, the better is the stand. All that we sowed during the month of August will probably make a fair crop; but where it was sown as late as September it will hardly be worth bothering with. Of course, our extremely dry weather in the fall may have had something to do with it. We may rejoice in this: Crimson clover will stand the average winter of northern Ohio when the seed is sown in July or early in August.

When our patch gets to its best we propose to plow it under so as to get a place for our Thoroughbred potatoes. With the present high price of hay, it seems almost wicked to plow under such a crop of green feed. Of course, the great point is that you have a heavy stand of clover on your ground in nine or ten months after the seed was put in.

We shall be glad to hear other reports about crimson clover, for it is also a fine honey-plant, and, when better known, will likely be grown more extensively wherever it will stand the climate.

The California Honey Outlook for 1896 is not at all encouraging for our friends on the Western Coast. One of the prominent bee-keepers, and an officer of the Exchange, wrote us on April 22:

"The present outlook for a honey crop is very poor, and at our Director's meeting to-day the opinion was freely expressed that there would be no production of honey this year in Southern California."

Well, what may be California's loss may be a gain to other States that have a crop. Everything in this region, so far, points to a good honey crop. We'd like to see it once—just for a change. One or two good honey years would send the circulation of the American Bee Journal away ahead, we think. It might help the editor's circulation, also.

Bees and Grapes.—On page 291 will be found a contribution from W. S. Fultz, one of the veterans in bee-keeping, whose views are entitled to respect on that account. Plainly he does not believe in the innocence of the bee as related to fruit-tasting. The American Bee Journal has no desire that anything but the truth should come uppermost, however strong the desire that the truth might run one way or another. If there is clear evidence that bees puncture grapes, by all means let us not insist that they never do so. At the same time, it is well to be careful that no mistake is made, and we have faith enough in bee-keepers to believe that they are not altogether blinded by prejudice. The late discussion as to bees fertilizing strawberries shows that pretty clearly, for a number of them were not slow to assert that they had had fair opportunity for observation without ever seeing a bee working on strawberries. Certainly, it would be to their interest, as bee-keepers, to keep quiet on that score.

Neither have there been waiting those who insisted that their bees did injure fruit, among them those who would not be silenced if they believed they were right. If Mr. Fultz has good evidence that bees perforate grapes, he is right in making known his belief. He cites Dr. Miller as agreeing with him, and it is true that the Doctor stoutly insisted that he believed bees did pierce grapes, but he had no reply to make to C. P. Dadant, when the latter asked him whether he could stand up before a wall and bite into its flat surface. Mr. Dadant's argument was that the jaws of the bee could no more grasp anything on the surface of the grape than the Doctor's teeth could on the surface of the wall. Later on, Dr. Miller admitted that when he found his grapes worked on by the bees, he found the berries were first pierced with a hole in the shape of a dumb-bell—a hole that would readily be made by the bill of a bird at one stroke. But a still stronger proof that his bees did not make the initial attack on the

grapes occurred in a subsequent year, when the bees were idle for want of pasturage, but the grapes were left entirely untouched, just because, for some reason, the birds were not on hand to prepare the way for the bees.

Now, is it not possible that Mr. Fultz, like Dr. Miller, has been mistaken? In each case there is circumstantial evidence, but no one has yet said that he has seen a bee pierce a grape. Strong inducements have been offered the bees to do so—tempting grapes have been placed before them, and they have been seen to run all over them apparently looking for a weak point of attack, but they were either too modest to pierce the skin of a grape while under the fire of observing eyes, or else they were unable to do so. After a hole is made in the grape, the bees have no trouble in sucking out the juice, and probably they could grasp and pull the torn skin just as they can grasp the splinter of wood.

If bees pierce grapes, some one ought to be able to see them *in the act*. Mr. Fultz saw a bee alight upon a sound grape, and when the bee left the grape it was pierced. But he did not see the bee pierce the grape. That leaves room for the doubt that there may have been a hole unnoticed before the arrival of the bee. If bees actually pierce grapes, some ought to be able to say: "I saw a bee in the act of piercing a grape." Is any one ready to say this?

Prof. Cook's Many Friends will be pained to hear of the death of Mrs. Cook, April 16. She was a great sufferer, and death was a welcome release. It is probably safe to say that the sympathies of the larger part of the Bee Journal family go out to the good man in his great bereavement. When informing us of Mrs. Cook's death, the Professor wrote thus tenderly:

CLAREMONT, Calif., April 20, 1896.

DEAR MR. YORK:—It is with a great burden of sorrow that I have to report that on last Thursday evening Mrs. Cook went to her long home. This was not a surprise, for we had

know for a long time that it must be; and as the last hours of her life were filled with very severe suffering, we were almost rejoiced when the release came, sad and unbearable as it seems to feel that we shall never again have her with us. She had a fixed and abiding trust in Him who doeth all things well; and we are all sure that what is our loss is her eternal gain, for now she is in the arms of Eternal Love. She went with no fear, but only sorrowed that she had to leave us behind to mourn her loss.

A. J. Cook.

The Season in Minnesota.—In the Farm, Stock and Home for May 1, we find the following paragraph from the pen of the editor of the bee-department, Mr. B. Taylor, of Forestville, Minn.:

We are having much rain here this spring, and the white clover is showing in every pasture and waste place; this is also basswood year here, and we expect a big honey crop in 1896, and shall leave no task undone to be ready for it. Now is the time to not only give colonies needed attention, but have hives, sections, foundation and other needed supplies ready before the main honey-flow and swarming-time come. In good years much honey is nearly always lost by the average bee-keeper by not being ready. To succeed in honey-production the necessary work must not only be done at the right time, but also in the right way, and the best way can be learned only by much study, and bringing mind as well as muscle into active play.

A Honey-Leaflet is being considered by Editor Hutchinson, of the Bee-Keepers' Review. He is looking the field over carefully, and then expects to prepare one himself. We shall await with interest the result, for Mr. H. is sure to get up a good leaflet when he starts on it.

The Pacific Northwest is getting to be quite a honey country. An exchange says: "The honey product of the entire Pacific Northwest last year was near the value of \$75,000. The industry will increase very fast the coming season, markets for the product being very abundant."

PERSONAL MENTION.

MR. E. N. DRAPER, of Atchison, Kans., is in deep sorrow, caused by the drowning of his son, 14 years old, in the Missouri river. The Bee Journal extends its sympathy in our friend's bereavement.

PROF. A. J. COOK, of Claremont, Calif., at the late meeting of the British Bee-Keepers' Association, was made an honorary member in place of the Rev. L. L. Langstroth, who died last October.

MR. ERNEST W. HALSTEAD, of Mississippi, says: "The American Bee Journal is the queen of the colony of bee-papers. I could not do without it for a great deal more than it costs." We would like ten thousand more subscribers just like Mr. Halstead.

MR. J. H. MARTIN has been elected Secretary of the California Bee-Keepers' Exchange, the former Secretary, Mr. Youngken, having other business requiring his undivided attention, was forced to resign. Mr. Martin needs no introduction or commendation, as all know him as "The Rambler." Success to him and the new Exchange.

MR. C. F. MUTH, of Cincinnati, in a recent number of Gleanings, gave "the other side" of the honey commission business; that is, his side. He tells how some honey-producers impose upon dealers when shipping. Verily, there are at least two sides to the question. No, bee-keepers are not all, and altogether, perfect just yet. Wings have not begun to sprout on them—neither upon some of the honey commission men.

MRS. H. STILES, of the State of Washington, wrote when renewing her subscription: "I have taken the American Bee Journal two years, and am much pleased with it. I find something in it every week that is worth the price of the journal to me."

MR. B. S. K. BENNETT, of the Pacific Bee Journal, has made quite an improvement in the second quarterly number of his little paper. He says Editor Hutchinson "is just the nicest editor" he knows. Too bad he doesn't know all the editors. At least half of them are "the nicest" folks on earth; the rest are—well, we're all trying hard to keep up with the others.

MR. A. I. ROOT is, and has been for a good many years, a good deal of a preacher, if we may judge from his sermonettes in Gleanings. If he practices all he preaches—that is, takes all of his own medicine—he must be a very busy man, and ought to be pretty healthy spiritually. Between good potatoes and better sermons, the readers of Gleanings ought to be well-kept in both body and soul.

MR. F. H. JEWHRST, of Richmond, Va., some time ago, sent Gleanings a sample of crimson clover honey that Editor Root called "fully equal in every respect to any clover honey he ever saw." We think that is the first honey of the kind we have ever heard of. If it equals sweet clover honey, it surely is fine. The more we eat of the sweet clover honey the better we like it. Shouldn't wonder if we'd soon say it's the best of all honeys. It is the best we ever have eaten, and we've sampled quite a number of kinds, considering our youthfulness!

Bee-Keeper's Guide—see page 301.

Queens and Queen-Rearing.—

If you want to know how to have queens fertilized in upper stories while the old queen is still laying below; how you may safely introduce any queen, at any time of the year when bees can fly; all about the different races of bees; all about shipping queens, queen-cages, candy for queen-cages, etc.; all about forming nuclei, multiplying or uniting bees, or weak colonies, etc.; or, in fact, everything about the queen-business which you may want to know—send for Doolittle's "Scientific Queen-Rearing"—a book of over 170 pages, which is as interesting as a story. Here are some good offers of this book:

Bound in cloth, postpaid, \$1.00; or clubbed with the BEE JOURNAL for one year—both for only \$1.75; or given free as a premium for sending us three new subscribers to the BEE JOURNAL for a year at \$1.00 each.

"Facts and Figures" is the title of a little book which deals with the live stock and kindred statistics of the country in general and Chicago in particular. It is full of interesting records of great value to those interested in the live-stock industry. It is issued by Wood Brothers, of Chicago, Ill., and South Omaha, Nebr. They send it free to live-stock men who write for it.

Please Send Us the Names of your neighbors who keep bees, and we will send them sample copies of the BEE JOURNAL. Then please call upon them and get them to subscribe with you, and secure some of the premiums we offer.



Largest Factory in the West **COMPLETE STOCK.**
Good Supplies and Low Prices
Our Motto.

READ THIS—Mr. Keyes says: The 100 pounds of Extra-Twin Foundation you sent us is superior to anything he ever saw; and I think the same. R. L. TUCKER, Wewahitchka, Fla.
 Dear Sirs:—The Sections came duly to hand. Indeed, they are very nice. Yes, sir; they are as good as the best. CHARLES H. THIES, Steelville, Illinois.
 Leahy Mfg. Co.:—I have received the bill of goods. I must say they are the choicest lot of Hive-Stuff I have ever received from any place. I admire the smoothness of your work, and your close selection of lumber. Yours very truly, O. K. OLMSTEAD, Orleans, Nebr.
 Dear Sirs:—The Sections arrived in due time, and are all O. K. so far as examined. They are simply perfection. I can't see how you can furnish such goods at such low prices. I hope you may live long and do well. Yours respectfully, Z. S. WEAVER, Courtney, Tex.
 Gents:—I received the "Higginsville Smoker" all O. K. It's a dandy; please find enclosed stamps for another. Yours truly, OTTO ENDERS, Oswegatche, N. Y.
 Gentlemen:—I have bought Supplies from nearly all the large manufacturers by the carload, and I must say yours are as good as the best. Indeed, in many lines they are the best. It is a pleasure to handle them. E. T. FLANAGAN, Belleville, Illinois.
 The above unsolicited testimonials are a fair sample of hundreds we receive. Our prices are reasonable and the "Higginsville Goods" are the best.
The "Higginsville" Goods are for sale by the following parties:
 Chas. H. Thies, Steelville, Ill. E. T. Flanagan, Belleville, Ill.
 Henry L. Miller, Topeka, Kans. E. A. Seeley, Bloomer, Arkansas.
 J. W. Rouse & Co., Mexico, Mo. P. J. Thomas, Fredonia, Kans.
 Fulton & Gregg, Garden City, Kans. W. J. Finch, Jr., Springfield, Ill.
 If you need a Carload of Supplies, or only a Bee-Smoker, write to us. Remember, we are here to serve you, and will, if you give us a chance. **A Beautiful Catalogue Free.**
 Address, **LEAHY MANUFACTURING CO., HIGGINSVILLE, MO.**
 49A *Mention the American Bee Journal.*

General Items.

Wintered Well.

Bees have wintered well around here. I have not heard of any losses at all.
 N. RICHARDSON.
 Blooming Prairie, Minn., April 20.

Fine Weather for Bees.

We are having fine weather for bees now, and I never knew them to get more honey from the fruit-bloom than they are now.
 EMERSON T. ABBOTT.
 St. Joseph, Mo., April 23.

Nailing Hoffman Frames.

I notice in April 1 of Gleanings what Mr. C. Davenport says about nailing the Hoffman frames. I had some of the trouble which he describes when I first began to use them. If one would avoid this difficulty, he should commence nailing by slipping the first end-bar onto the top-bar with the square edge of the end-bar towards the body. Then change ends with the top-bar, and that will bring the square edge of the second end-bar in the same direction.

By following this order of nailing, or reversing it, one will have no trouble so far as his own apiary is concerned. But if he should ever have occasion to get frames from some one who started nailing differently from him, he would have trouble. If one should nail with the square edges in the direction of the person, and another should nail with the V edges in the same direction, the V edges would not come against the square edges unless half of the frame were turned upside down, and the larger part of the frame held above the top of the hive. Bee-keepers should agree on which way they will nail, and then all nail alike.
 EDWIN BEVINS.
 Leon, Iowa.

CHEAPER THAN EVER

Hilton's White T Supers
 Chaff Polished Foundation
 Hives Sections Smokers

And everything needed in the apiary.
 1896 Catalog of 36 pages free.

GEO. E. HILTON,
 13Atf FREMONT, MICH.
Mention the American Bee Journal.



ONE MAN WITH THE UNION COMBINATION SAW

Can do the work of four men using hand tools, in Rippling, Cutting-off, Mitering, Rabbeting, Grooving, Gaining, Dadoing, Edging-up, Jointing Stuff, etc. Full Line of Foot and Hand Power Machinery Sold on Trial. Catalogue Free.

SENECA FALLS MFG. CO.,
 46 Water St., SENECA FALLS, N. Y.
 1Aly *Mention the American Bee Journal.*

Dadant's Foundation in Chicago!

No other Goods kept here.
 Send for Price-List.
CHAS. DADANT & SON,
 118 Michigan St., CHICAGO, ILL.
 13Atf Please mention the Bee Journal.

SECTIONS

\$1.50 a M. 3 M, \$4.25.
 These ARE NOT Seconds, but perfect Sections. As they are not up to our present high standard, we wish to close them out. Sample free. Widths—7-to-toot, 1 15-16 in., and 2 in.
Catalog of Bees & Supplies FREE.

I. J. STRINGHAM,
 105 Park Place. NEW YORK, N. Y.

No. 1 4x4 Snow-white Sections \$2.00 per 1,000.



For the purpose of introducing our One-Piece Section to the bee-keepers generally, we have concluded to make the price \$2.00 per 1,000 for the month of April. Now is the time to get your Sections cheap. We have a choice lot of Section Lumber, gotten out of young timber, and we can furnish you the nicest Section to be had. Write for Sample Section Free.

THE MARSHFIELD MFG. CO.,
 MARSHFIELD, Wood Co., WIS.
 May 1st, 1896. 14Ctf *Mention the American Bee Journal.*

That Queen-Clipping Device Free!

PLEASE READ THE FOLLOWING OFFER:

We have arranged with the inventor of the new Queen-Clipping Device (Mr. Monette), to offer it to our present subscribers as a Premium for getting NEW subscribers.

Send us just one new name for the American Bee Journal a year (with \$1.00), and we will mail you the Queen-Clipping Device FREE of charge. Or, the Queen-Clipping Device will be sent postpaid for 50 cts. But why not get it as a Premium by the above offer? You can't earn 50 cts. any easier. Almost every bee-keeper will want this Device. See page 130 (Feb. 27) for full description of it. Complete directions accompany each one sent out. It is a most ingenious and useful article. Address,

GEORGE W. YORK & CO., 118 Michigan St., Chicago, Ill.

Extracted vs. Comb Honey.

Occasionally I see something in the Bee Journal that is quite at variance with my ideas and experience. I noticed the discussion at the meeting of the Colorado State Bee-Keepers' Association, about the advisability of doing away with the honey-extractor. Bee-keepers have always been told that it would pay them to have an extractor, if they possessed only a few colonies of bees. If I am not mistaken some of those who took part in the discussion used to manufacture and sell extractors; however, I am not sure of this. But what I started out to do, was to give some of my experience in selling honey.

Although I have not been a large honey-producer, I have always sold my entire surplus crop direct to the consumer—peddled it from a wagon. My experience dates back to 1872, when I commenced with five colonies, and have produced since that time from 300 or 400 pounds up to 5,000 or 6,000 in a season. I have always had the prejudice to contend with against extracted honey, but now I am going to tell those Colorado comb-honey men something that they don't seem to know, and that is, that there is almost as strong a prejudice against their nice Colorado comb honey as against extracted. There is

A HANDY TOOL-HOLDER!

Sent by Express, for \$1.50; or with the Bee Journal one year—both for \$2.00.

Every Manufacturer, Miller, Carpenter, Cabinet Maker, Machinist, Wheelwright and Quarryman, Farmer, or any one using a grindstone, should have one of these Tool-Holders. One boy can do the work of two persons, and grind much faster, easier and with perfect accuracy. Will hold any kind of tool, from the smallest chisel to a draw shave or ax. Extra attachment for sharpening scythe blades included in the above price. The work is done without wetting the hands or soiling the clothes, as the water flows from the operator. It can be attached to any size stone for hand or steam power, is always ready for use, nothing to get out of order, and is absolutely worth 100 times its cost.

No farm is well-equipped unless it has a Tool-Holder. Pays for itself in a short time.

How to Use the Holder.

DIRECTIONS.—The Tool is fastened securely in the Holder by a set-screw and can be ground to any desired bevel by inserting the arm of the Holder into a higher or lower notch of the standard. While turning the crank with the right hand, the left rests on an steady the Holder; the Tool is moved to the right or left across the stone, or examined while grinding, as readily and in the same way as if held in the hands.

For grinding Round-Edge Tools, the holes in the standard are used instead of the notches.

Address, **GEORGE W. YORK & CO.,**

CHICAGO, ILL.

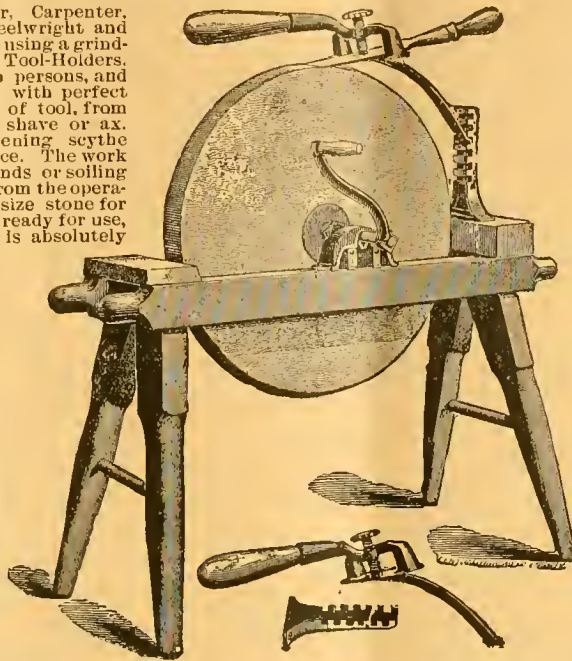

SECTIONS CHEAP! * * * *

In order to reduce stock we will sell

- 40,000 4 1/4 x 4 1/4 x 2
- 150,000 4 1/4 x 4 1/4 x 1 1/2
- 40,000 4 1/4 x 4 1/4 x 1 5/16
- 80,000 4 1/4 x 4 1/4 x 7-to-ft,
- 250,000 4 1/4 x 4 1/4 x 1 1/2

Of our No. 2. One-Piece, Open-Top Sections, at the following Low Prices:

1,000 for \$1.00; 3,000 for \$2.50; 5,000 for \$3.75.

These Sections are all of good quality and manufacture, and prices will be maintained for a short time only.

G. B. LEWIS CO., WATERTOWN, WIS.

Be sure to mention the American Bee Journal when you write.

Fruit-Plants Free!

ALL CHOICE VARIETIES.

- No. 1—Eight Snyder Blackberry Plants. \$1.00
- No. 2—50 Asparagus Roots. 1.00
- No. 3—6 Fay Prolific Currants. 1.00
- No. 4—3 Snyder Blackberry, 20 Asparag's Roots and 3 Fay Prolific Currants. 1.00
- No. 5—3 Blackcap Gregg Raspberries, 3 Choice Red Raspberries, 12 to a Beauty Strawberries and 2 Fay Pro. Curr. 1.00
- No. 6—4 Snyder Blackberry, 4 Golden Queen Raspberry, 12 Asparagus R'ts and 10 Eric Blackb'ry Root Cuttings. 1.00
- No. 7—75 Blackberry Root Cuttings. 1.00

Special Offer—Your choice of any ONE of the above 7 Numbers for sending us one new subscriber to the Bee Journal for a year at \$1.00, and 15 cts. to pay Postage on the Plants.

GEORGE W. YORK & CO., CHICAGO, ILLS.

Sweet Clover & Canada.

At the following prices:

- 5 lbs. \$1.00
- 10 lbs. \$1.60
- 25 lbs. \$3.75
- 50 lbs. \$7.25.

Also a quantity of Motherwort and Catnip seed. Prices on application.

EGGS for Hatching. Buff Leghorns, Indian Games, & Light Brahmans. Choice Birds. A breeder for 30 years. Prices on application

JOHN McARTHUR, 881 Yonge Street. TORONTO, ONT.
15Atf Mention the American Bee Journal.

For Sale HOME, APIARY, QUEENS.

1/2 Block of ground, some fruit, GOOD 6-room dwelling, shop, stable, honey-house and poultry-house (over 3,000 square feet of floor), 100 colonies of bees in chaff hives and fully equipped for comb honey, all in town of 1000 population and good alfalfa range and good water. Price, \$3,000. If unsold June 15th, will unqueen, and offer 2 year clipped queens at 25c.; 1 year, unclipped, at 50c. each. July 15th and after, young queens at 60c. each—all Italian and safe arrival guaranteed. This is a rare bargain, but I must get my wife to a lower altitude. Book your orders at once if you want these queens.
19Atf **R. C. ATKIN, Loveland, Colo.**



Promptness Is What Counts!

Honey-Jars, Shipping-Cases, and everything that bee-keepers use. **Root's Goods at Root's Prices,** and the best shipping point in the country. Dealer in Honey and Beeswax. Catalogue Free.

Walter S. Ponder
162 MASS. AVE. INDIANAPOLIS, IND.

Mention the American Bee Journal

J. W. TAYLOR

—HAS THE BEST—

Italian Queens for Sale

Untested, ready now, 75c. apiece; 6 for \$4.25, or 12 for \$8.00. Tested \$1.25. Select Tested, best, \$2.00. Pay for Queens on arrival. I guarantee safe arrival and satisfaction.
14A9t **OZAN, ARK.**

one class that will tell you that the comb is manufactured and filled, and sealed all complete, artificially. Another class will tell you that it is the work of the bees, but that the bees are fed on glucose and cheap syrup, or almost anything. They seem to think that the bees will store anything in the combs if it is a little sweet. I have been selling Colorado honey more or less for the last year and a half, and I know what I write from experience.

Carthage, Mo. **L. G. PURVIS.**

Not So Bad, After All.

Mr. Bargehr, on page 236, says the bees in this section are all dead except his 22 colonies. With due respect to Mr. Bargehr, I must say the facts are not so discouraging as he reports. I live within three miles of his home, and have wintered 63 colonies without a single loss. We had a mild winter here, and bee-mortality should be small where they are properly cared for. I think the gentleman has reference to some old-fogy farmers in this section, who keep bees that board themselves, or die in the attempt. I have sent sample copies of the Bee Journal to such, but they say ye editors, or city chaps, talk well on paper, but know very little about the practical part of bee-keeping; and they are prone to follow the "good old way" of their unsuccessful fathers. I think the sooner such over-cautious individuals "wind up" with empty boxes and moth-eaten combs, the better.

A. B. BAIRD.

Belle-Vernon, Pa., April 11.

Colorado and Farmer Bee-Keeping.

On page 219, Mr. John Seton questions the accuracy of that average yield of 150 pounds of comb honey. Well, when I got my information from the dealer who purchased the honey, who had been to Rocky Ford and talked with the man who ran the bees, I may be excused for lending blind credence to the tale.

He says I ought to know that there were yards near me that yielded almost nothing. (But he does not say whether those yards were run by up-to-date bee-keepers or not.) I do know it, and said nothing to imply that I didn't. But I was talking about the yards of "apiarists," as Bee-Master would say. The gentleman he refers to, who got some 2,000 pounds from 400 colonies, and would need to feed 4,000 pounds to winter, is not, I believe, a modern bee-keeper. If wrong in this matter, I will be glad to be corrected. The same remark applies to those others who obtained "almost nothing"—one of them only half a mile from me. Mr. Seton himself refers to the "best apiarists" in the Rocky Ford region. How's this?

I have heard, too, of prime swarms being sold for 50 cents (though I never ran across them); but the same remark applies to them, too, or rather their owners. The man who would sell a first swarm right in the honey-flow for less than a good round sum, knows nothing about modern bee-keeping. What he does, doesn't count.

I would like to know a little more about that "much sold as comb which was cut out of brood-frames." That is the first I heard about it. About how many bee-keepers are engaged in that

BUY "DIRECT FROM FACTORY," BEST MIXED PAINTS

At WHOLESALE PRICES, Delivered FREE For Houses, Baros, Roofs, all colors, and SAVY. Dealers profits. In use 54 years. Endorsed by Grange & Farmers' Alliance. Low prices will surprise you. Write for Samples. O. W. INGERSOLL, 289 Plymouth St., Brooklyn, N. V.

12A13 Mention the American Bee Journal

MURDERED

We have killed high prices. Give me a trial order and be convinced that good Queens can be reared for 50 cts. each. Untested, 50 cts.; Tested, 75 cts. Golden Italians, 3-Banded Italians, and Silver-Gray Carniolans, all the same price. Best of References given.

C. B. BANKSTON,

13A1f CHRIESMAN, Burlington Co., TEX.

Mention the American Bee Journal.

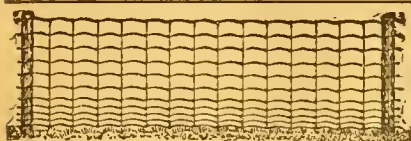

AN IRISHMAN'S REASON.

A group of Kentucky farmers were discussing fences. One only, defended a ratchet device, all the others preferred "the Page." Each in turn gave his reasons, a son of the "ould sod" last. "Begorra!" said he, "I'd rayther hev a cow that'll coom up herself than be goin' after her twice a day."

PAGE WOVEN WIRE FENCE CO., Adrian, Mich.

WHEN ANSWERING THIS ADVERTISEMENT, MENTION THIS JOURNAL

A New Method

of refining wax without acid.

Result Better

Comb Foundation.

My prices are also the lowest.

A Job-Lot of No. 2

Polished Sections

Equal in finish to any No. 1's. 1 M. \$1.75; 2 M. \$3.40; 3 M. \$4.80; 5 M. \$7.50. Or I can furnish a cheaper quality. Also, a full line of

HIGGINSVILLE SUPPLIES.

See my List with prices.

W. J. FINCH, Jr., SPRINGFIELD ILLS.

Mention the American Bee Journal.



SUCCESSFUL INCUBATOR

Our magnificent new catalogue giving full information regarding artificial Hatching & Brooding and treatise on poultry raising sent for 4c stamps. Circular free.

Write now. Des Moines Incubator Co. Box 73 Des Moines, Ia

11A9t Mention the American Bee Journal.

California

If you care to know of its Fruits, Flowers Climate or Resources, send for a Sample Copy of California's Favorite Paper—

The Pacific Rural Press

The leading Horticultural and Agricultural paper of the Pacific Coast. Published weekly, handsomely illustrated, \$2.00 per annum. Sample Copy Free.

PACIFIC RURAL PRESS,

220 Market St., - SAN FRANCISCO, CAL.

TEXAS QUEENS.

If you are in need of Queens, let me have your order. Price-List Free.

8A26t J. D. GIVENS, Lisbon, Tex.

practice; and about how much was the "much?"

I don't know what Mr. Seton means when he says "I guess Mr. Thompson extracted quite a bit from the same source." My reported yield was 24 pounds of comb honey. Two of my colonies gave three supers apiece of comb honey, and several of them yielded two apiece. I produced about as much extracted as comb, I believe, but did not allow that to influence my estimate, which was on a strictly comb-honey basis. Moreover, I did not extract from the brood-chamber, but from regular extracting-supers. I know of two bee-keepers, or apiarists, one near Morrison and one near Littleton, who did well last summer. I regret that I cannot give their averages.

What Mr. Seton has said, if properly interpreted, furnishes a pretty good commentary on the idea that general farmers should keep bees. I agree with him in saying, "There are many parts of Colorado with all the bee-keepers they need." See page 213, first few lines, for more confirmation.

The argument that Mr. Hammond gives on page 220 for bee-keeping by farmers misses the point entirely. To illustrate: My neighbor, half a mile away, who got almost nothing from his bees, is no "kid-glove" farmer. He is one of the kind who gets up at 4 o'clock the year round, and works hard until late at night. There is nothing lazy about him. But why didn't he get as much from his bees as I did last summer? That's what I'd like to know. And whatever the reason is, I am pretty safe in saying that the great majority of farmers are just like him. What ought to be, is very different from what is.

I did not make the broad statement that "farmers could not keep bees and make them a success." Whatever farmers are really competent to do so, by all means let them keep bees. The average farmer is the man we are talking about. We have had a good deal of indefinite, goody-goody talk, that the farmer ought to do this, and ought to do that, but nobody seems to care about what he actually does, and will keep on doing.

Arvada, Colo. F. L. THOMPSON.

Sweet Clover for Honey.

Sweet clover (*Melilotus*) is one of the chief honey-producing plants here. It grows abundantly along the roadsides, in gravel pits and poor soil. It attains a height of three to five feet, and when in full bloom the air is filled with its fragrance.

This common plant was introduced into this neighborhood by a Mr. Hintz, a bee-keeper, about eight years ago. Its flowers appear early in July, and continue until destroyed by frost. During a dry spell it dried up last year and shed its leaves, and again after a heavy rain its foliage put in its appearance once more, in full bloom, with the bees busily working on it all day long. I have not known it to be killed by winter.

To this plant I must credit my share of honey procured, since without sweet clover my crop would have been a failure. One colony produced 110 pounds of honey—all nice, white, clear honey, with a fine flavor.

I do not favor growing it for hay, since the stems are too thick. Every bee-keeper should sow at least a few pounds

ORIGINAL BINGHAM SMOKERS

Wonderful Record!

HAVE LASTED 17 YEARS.

BEST ON EARTH.

Always Give Perfect Satisfaction.

My cool Wire Handle and Bent Nose were patented 1892, are the original, my best invention since my open or direct draft Patent, 1878, that revolutionized Bee-Smokers. My Handle and Nose Patent bent all the other smoker noses. None but Bingham Smokers have all the best improvements. If you buy genuine Bingham Smokers and Honey-Knives you will never regret it. The "Doctor," 1/4-inch larger than any other smoker on the market—3 1/4-inch stove, by mail, \$1.50

Conqueror, 3 "	1.10
Large, 2 1/4-in. "	1.00
Plain, 2-in. "	.70
Little Wonder, 2-in., wt. 10 oz.	.60

Bingham & Hetherington Honey-Knives, 80 cents.

T. F. BINGHAM, Farwell, Mich.

7A1f Mention the Bee Journal.

PATENT WIRED COMB FOUNDATION

Has No Sag in Brood-Frames

Thin Flat-Bottom Foundation

Has No Fishbone in the Surplus Honey.

Being the cleanest is usually worked the quickest of any Foundation made

J. VAN DEUSEN & SONS,
Sole Manufacturers,
Sprout Brook Montgomery Co., N. Y.

BEGINNERS.

Beginners should have a copy of the Amateur Bee-Keeper, a 70-page book by Prof. J. W. Rouse. Price 25 cents; if sent by mail, 28c. The little book and the Progressive Bee-Keeper (a live, progressive 28-page monthly journal) one year, 65c. Address any first-class dealer, or

LEAHY MFG. CO., Higginsville, Mo.

SPRAYING

Will Produce **PERFECT FRUIT**

We tell you all about spraying and care of fruit in our 32-pg. illustrated book—free. Our Pumps and Nozzles win highest honors in every test. **The Dering Co., Salem, O.** W. Arts, Hemion & Hubbell, Chicago

The Patent Wood-Veneer Foundation.

Bee-keepers should give it a test, and my All-Wax Foundation. I will guarantee there is no better made, as six years ago I discarded the old way of dipping for wax sheets, and a new invention of my own was discovered, which enables me to make the toughest kind of Foundation; also, no acid used to purify the Beeswax, and it preserves the smell of honey, which is more acceptable to the bees. Now is the time to send wax and have it worked up at low prices. Send for Samples and Catalog with low prices. Wax wanted at 31c trade, or 33c trade, delivered.

AUG. WEISS, Hortonville, Wis.

12A13t Please mention the Bee Journal.

Canada Up-to-date Bee-Supplies

at rock-bottom prices. Send for my annual Circular. A 12-inch Root Pdn. Mill in good order, 2nd hand, at a bargain for either Wax or Cash. Address,

W. A. CHRYSLER, Chatham, Ont.

19A1t Mention the American Bee Journal.

Abbott's Space.

Sections as low as the lowest for good goods. Send for Circular and say what you want. Special Agent for G. B. Lewis Co.'s goods. Write for prices. E. T. Abbott, St. Joseph, Mo.

The "St. Joe" stands at the TOP. Dovetailed Hives VERY CHEAP. Dadant's New Process Foundation at Dadant's prices, WHOLESALE and RETAIL.

BEES & QUEENS.

Strong, full Colonies of Italian-Hybrid Bees, in Langstroth 9-frame hives, at \$5.00 per colony; 5 to 10 colonies, \$4.75 each. Special low price on larger orders. Bees are in good condition, and are fine honey-gatherers.

Italian Queens—after May 15—Untested, \$1.00 each; 6 for \$5.00; 12 for \$9.00.

Safe arrival and satisfaction guaranteed. Reference—George W. York & Co. Address, F. GRABBE,

LIBERTYVILLE, ILL.

32 ml. northwest of Chicago, on C. M. & St. P. Mention the American Bee Journal.

Honey-Clovers & Buckwheat SEED FOR SALE.

We have made arrangements so that we can furnish seed of several of the Clovers and Japanese Buckwheat, by freight or express, at the following prices, cash or order:

	5lb	10lb	25lb	50lb
Alsike Clover	\$.70	\$1.25	\$3.00	\$ 5.75
Sweet Clover	.75	1.40	3.25	6.00
White Clover	1.25	2.00	4.50	8.00
Alfalfa Clover	.65	1.10	2.70	5.00
Crimson Clover	.55	.90	2.00	3.50
Jap. Buckwheat	.20	.35	.90	1.25

Prices subject to market changes.

Add 25 cents to your order, for cartage, if wanted by freight. Your orders are solicited.

GEORGE W. YORK & CO., CHICAGO, ILLS.

For Sale ITALIAN QUEENS and BEEES.

1 Frame Nucleus, with Queen	\$1.75
2 " "	2.25
Queens, 50c each; 1/2 doz. \$2.75; 1 doz. 5.00	

Safe arrival and satisfaction guaranteed.

References—Young & Hamilton, Bankers, Classa Park, Ills.; W. Kaufman, Banker, and Lewis Wolf, P. M., Claytonville.

F. J. GUNZEL, Claytonville, Ills.

Mention the American Bee Journal.

The Bee-Keepers' Guide:

Or Manual of the Apiary,

By PROF. A. J. COOK.

This 15th and latest edition of Prof. Cook's magnificent book of 460 pages, in neat and substantial cloth binding, we propose to give away to our present subscribers, for the work of getting new subscribers for the American Bee Journal.

A description of the book here is quite unnecessary—it is simply the most complete scientific and practical bee-book published today. Fully illustrated, and all written in the most fascinating style. The author is also too well-known to the whole bee-world to require any introduction. No bee-keeper is fully equipped, or his library complete, without "THE BEE-KEEPER'S GUIDE."

Given For 2 New Subscribers.

The following offer is made to PRESENT subscribers only, and no premium is also given to the two new subscribers—simply the Bee Journal for one year:

Send us Two New Subscribers to the Bee Journal (with \$2.00), and we will mail you a copy of Prof. Cook's book FREE as a premium. Prof. Cook's book alone sent for \$1.25, or we club it with the Bee Journal for a year—both together for only \$1.75. But surely anybody can get only 2 new subscribers to the Bee Journal for a year, and thus get the book as a premium. Let everybody try for it. Will you have one?

GEORGE W. YORK & CO., CHICAGO, ILLS.

Extracted Honey for Sale!!

The beautiful, white Willow-Herb Honey, in 60-lb. cans, f. o. b. Chicago, at 8 cents per

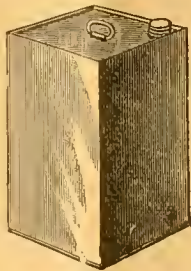

pound, 2 cans (120 lbs.) in a box. Single can, 8 1/2 cts. per pound.

Fine Basswood honey at same prices. Sample of the honey mailed on receipt of 10 cts. This honey will give entire satisfaction, is guaranteed strictly pure Basswood and Willow-Herb honey. Better order at once, and begin to work up a trade before the new crop comes on. Address,

GEORGE W. YORK & CO., CHICAGO, ILLS.

A Bargain—EARLY QUEENS.

119 Colonies Italian Bees in Chaff Hives: two acres land; good house; excellent well.

Early Queens—Tested, \$1.50; Untested, 75c. E. L. CARRINGTON,

16Atf PETTUS, Bee Co., TEX. Reference—1st National Bank of Beeville.

Mention the American Bee Journal.

CARLOADS



Of Bee-Hives, Sections, Shipping-Cases, Comb Foundation, and Everything used in the Bee-Industry.

I want the name and address of every Bee-keeper in America. No reason why you cannot do business with me. I have Cheap Lumber and Experienced Workmen; a good Water-Power Factory and know how to run it. I am supplying Dealers as well as consumers. Why not you? Send for Catalogues, Quotations, etc. W. H. PUTNAM, 1E RIVER FALLS, Pierce Co., WIS.

Mention the American Bee Journal.

MUTH'S HONEY EXTRACTOR PERFECTION Cold-Blast Smokers,

Square Glass Honey Jars, Etc.

For Circulars, apply to CHAS. F. MUTH & SON, Cor. Freeman & Central Aves., Cincinnati, O. Send 10c for Practical Hints to Bee-Keepers.

Mention the American Bee Journal.

HONEY We have a large amount of Pure No. 1 Alfalfa we will sell cheap.

Wax Wanted.

Boss bee-escape Warranted the best, simplest and quickest Escape on the market. Sent postpaid to any address for 30 cts. It can be returned at our expense if it is not as represented, or we will send the Escape on trial to any bee-keeper wishing to test it in good faith. We are agents for the Ferguson Patent Hive with double-case Super and Wicket-Gate Honey-Board, with the Escape. It is the easiest, quickest hive to handle for the production of comb honey. Address,

E. S. LOVESY & CO.,

355 6th East St., SALT LAKE CITY, UTAH. Mention the American Bee Journal. 9Atf

of sweet clover seed, along the roads. It will pay him more than any other honey-producing plant. It will grow year in and year out without any care, and will continually spread itself. I have not seen it grow in meadows, only occasionally a stalk or so is seen here and there.

The only objection I have to sweet clover is, that it does not bloom annually; instead, its flowers appear every two years.

The American Bee Journal is instructive and satisfactorily reliable, and I heartily recommend it to all who would be successful bee-keepers.

JOHN BODENSCHATZ.

Willow Springs, Ill., March 29.

Wind and Feed Mills.—There are not many of our readers who appreciate the amount of agricultural implement business done with foreign countries. At the present time there are large shipments of wind-mills being made. The Challenge Wind-Mill and Feed-Mill Co., of Batavia, Ill., writes us that they are making some very heavy shipments to foreign countries, are just now getting ready a carload for South America, and also have on the floor at the same time two shipments for Scotland and one for South Africa. This concern is doing a remarkably good business. They are patrons of our advertising columns, and they have our endorsement as a thoroughly reliable business firm, and in their manufacture every means is used to produce the very best machinery. Write them for a catalogue, mentioning this journal.

Convention Notices.

ILLINOIS.—The spring meeting of the Northern Illinois Bee-Keepers' Association will be held at the home of Mr. O. J. Cummings, in Guilford, on May 19, 1896. Come, and bring your wives and friends interested in bees. New Milford, Ills. B. KENNEDY, Sec.

Toronto Convention Report has been issued in pamphlet form, and will be mailed from the Bee Journal office for 25 cents. Better have a copy, if you have not read it. Only a limited number of copies were bound.

Catalogs for 1896.—We have received the following Catalogs, Price-Lists, etc., a copy of which may be obtained upon application, always being careful to say you saw their advertisement in the American Bee Journal:

Mrs. A. A. Simpson, Swarts, Pa.—Queens, Bees and Poultry.

Wm. H. Bright, Mazeppa, Minn.—Bee-Keepers' Supplies.

H. G. Quirin, Bellevue, O.—Queen-Bees.

List of Honey and Beeswax Dealers.

Most of whom Quote in this Journal,

Chicago, Ills.

R. A. BURNETT & Co., 163 South Water Street.

New York, N. Y.

HILDRETH BROS. & SEGLKEN, 120 & 122 West Broadway.

CHAS. ISRAEL & BROS., 486 Canal St.

Kansas City, Mo.

C. C. CLEMOMS & Co., 423 Walnut St.

Buffalo, N. Y.

BATTERSON & Co., 167 & 169 Scott St.

Hamilton, Ills.

CHAS. DADANT & SON.

Philadelphia, Pa.

WM. A. SELSER, 10 Vine St.

Cincinnati, Ohio.

C. F. MUTH & SON, cor. Freeman & Central avs.

DO NOT ORDER UNTIL YOU HAVE WRITTEN IS FOR PRICES ON

The "Boss" One-Piece Section



Also D. T. Hives, Shipping-Crates and Other Supplies.

We have completed a large addition to our Factory, which doubles our floor room; we are therefore in better shape than ever to fill orders on short notice. Send for Price-List

J. FORNCROOK,

WATERTOWN, Jeff. Co., Wis., Jan. 1st, 1896.

Mention the American Bee Journal.

Barnes' Foot-Power Machinery.



Read what J. I. PARENT, of CHARLTON, N. Y., says—'We cut with one of your Combined Machines, last winter 50 chaff hives with 7-in. cap, 100 honey-racks, 500 brood frames, 2,000 honey-boxes and a great deal of other work. This winter we have double the amount of bee-hives, etc., to make and we expect to do it with this Saw. It will do all you say it will. Catalogue and Price-List

Free. Address, W. F. & JOHN BARNES, 45Ct No. 995 Ruby St., Rockford, Ill.

Mention the American Bee Journal.

The RURAL CALIFORNIAN

Tells all about Bees in California.

The Yields and Price of Honey; the Pasture and Nectar-Producing Plants; the Bee-Ranches and how they are conducted. In fact the entire field is fully covered by and expert bee-man. Besides this, the paper also tells you all about California Agriculture and Horticulture. \$1.50 per Year; Six Months, 75 cents. Sample Free.

THE RURAL CALIFORNIAN,

218 N. Main St., LOS ANGELES, CALIF.

Mention the American Bee Journal.

W. H. BRIGHT'S

CIRCULAR FOR 1896, describes everything needed in the apary. Bees, Queens, Hives, Sections, Spraying Pumps, and Bright's Comb Foundation, sold at bottom prices. Send for one free.

Wm. H. BRIGHT,

17D4t MAZEPPA, MINN.

Page & Lyon Mfg. Co.,

NEW LONDON, WIS., operates two saw-mills that cut, annually, eight million feet of lumber, thus securing the best lumber at the lowest price for the manufacture of bee-keepers' supplies. They have also just completed one of

The Largest Factories,

and have the latest and most improved machinery for the manufacture of Bee-Hives, Sections, etc., that there is in the State. The material is cut from patterns, by machinery, and is absolutely accurate. For Sections, the clearest and

The Whitest Basswood

is used, and they are polished on both sides. Nearness to pine and basswood forests, and possession of mills and factory equipped with best machinery, all combine to enable this firm to furnish the best goods at

The Lowest Prices. ♡

For instance, it has a job lot of 500,000 No. 2 Sections that will be sold at 50 cts. per 1,000; or 2,000 Snow-White Sections will be sold for \$4.00, and larger quantities at still lower prices. Send for Circular and see the prices on a full line of supplies. 16Att

Mention the American Bee Journal.

Question-Box.

In the multitude of counsellors there is safety.—Prov. 11-14.

Hives Painted on the Inside.

Query 12.—Are hives which have been painted with white lead and oil, on the inside, acceptable to the bees? I saw in Gleanings that Mr. Taylor recommends painting hives on the inside, but I am afraid the bees will not approve it?—COLO.

Dr. J. P. H. Brown—They are acceptable.

Prof. A. J. Cook—The bees will make no objection.

R. L. Taylor—I doubt it, and I shouldn't like if they did.

G. M. Doolittle—If paint gets dry and hard it is all right for bees.

E. France—The bees won't object to the paint, where frames are used.

Chas. Dadant & Son—Yes. No use to paint them inside. The bees do it.

P. H. Elwood—I have never tried them. Let those who have, answer.

B. Taylor—Yes. I have used them for years, and know whereof I speak.

Dr. C. C. Miller—I don't believe they'd object to it after the paint is well dried.

W. G. Larrabee—I have never painted any, but I think I would prefer them not painted.

H. D. Cutting—Inside painted hives are all right if you give time for the odor to pass off.

J. M. Hambaugh—The smell of paint is very objectionable to bees. I would be afraid to try it.

Emerson T. Abbott—I would not paint hives on the inside. I do not think there is any need for so doing.

W. R. Graham—I think inside painting, as far as the bees are concerned, is all right, but not necessary.

Rev. M. Mahin—I think that newly-painted hives would be objectionable. Bees would not care for old and well-set paint.

Allen Pringle—When the paint is thoroughly dry it does not appear to be offensive to the bees, but I would not paint my hives on the inside.

Mrs. L. Harrison—Which Taylor—the Michigander or the Minnesotan? I would not be afraid to follow either, if I could keep up with them.

J. E. Pond—Yes. At least I find no trouble with bees accepting them on that account. I should prefer not to paint them inside, though, for other reasons.

James A. Stone—I have never tried it, but I see no use in doing so, unless to save the bees doing it, as they coat it over with wax till it must be water-proof.

C. H. Dibbern—Yes, the bees will not object to the paint if dried hard; but as the bees will themselves do the painting with propolis, I think it a waste of time and material.

G. W. Demaree—If the paint is thoroughly dry and hard before bees are put in painted hives, they do not appear to object to the paint. But there is no use in painting hives on the inside.

Eugene Secor—Yes. I have hived swarms in newly-painted hives. Bees will accept almost anything—when they feel in the humor for it. But hives painted on the inside are all right if you winter in a good cellar. If not—well, I don't know.

\$3.10 FOR THE BEST
BRASS BUCKET SPRAY PUMP on the market. It is fully described in our SPRAY PUMP CATALOGUE. Another valuable work is our handsome ILLUSTRATED BOOK ON CIDER PRESSES AND FRUIT MACHINERY. Both will be sent FREE. DAVIS-JOHNSON CO. 41 W. Randolph St. CHICAGO, ILL.

16A4t Mention the American Bee Journal

PURE BARRED PLYMOUTH ROCK

Eggs, \$1.25 per 14. Our P. Rocks are very large, with fine plumage. Also,

BLACK MINORCA EGGS,

a non-sitting and great laying breed. Both kinds raised upon our farm. Minorca Cock-ereels, \$1.00 each. Mrs. L. C. AXTELL, 16Att ROSEVILLE, Warren Co., ILL.

Sections & Foundation Reduced.

I am now selling Root's best polished SECTIONS at \$2.50 per 1,000; 2,000 for \$4.50; 3,000, \$6.45; 5,000, \$10.00. The New Weed Process Comb Foundation reduced 3c. per pound. See prices on page 14 of our Catalogue, or The A. I. Root Co.'s.

M. H. HUNT,

19D4t BELL BRANCH, MICH.

New England Supply Depot!

You can get the most complete Bee-Hive, also other Supplies, at—H. ALLEY'S, Room 5, 82 Water St., BOSTON, MASS. 13D4t Mention the American Bee Journal.

1896 SAVE MONEY 1896

If you want first-class ITALIAN QUEENS FOR BUSINESS, at Wholesale Prices, Hives, Foundation at Wholesale Prices, Hives, suited for the South, or SUPPLIES, send for Price-List—to

J. P. H. BROWN, AUGUSTA, GA.

IF YOU WANT THE BEE-BOOK

That covers the whole Apicultural Field more completely than any other published, send \$1.25 to Prof. A. J. Cook, Claremont, Calif., for his

Bee-Keeper's Guide.

Liberal Discounts to the Trade.

\$3.00 Worth for \$2.00!

Until further notice, we propose to give you a chance to get some good reading-matter for the long winter evenings, at half price.

Send us \$2.00, and we will mail you your choice of \$2.00 worth of the following book-lets, and also credit your subscription to the American Bee Journal for one year:

Poultry for Market and Profit.....	25c
Our Poultry Doctor.....	30c
Turkeys for Market and Profit.....	25c
Capons and Caponizing.....	30c
Rural Life.....	25c
Preparation of Honey for the Market.....	10c
Bee-Pasturage a Necessity.....	10c
Hive 1 Use, by Doolittle.....	5c
Foul Brood, by Dr. Howard.....	25c
Foul Brood, by Kohneke.....	25c
Foul Brood, by Cheshire.....	10c
Bee-Keeping for Profit, by Dr. Tinker.....	25c
Kendall's Horse-Book—Eng. or German.....	25c
Silo and Silage, by Prof. Cook.....	25c
Hand-Book of Health, by Dr. Foote.....	25c
Maple Sugar and the Sugar Bush.....	35c
Potato Culture, by Terry.....	40c
Carp Culture, by Root & Finney.....	40c
Strawberry Culture, by Terry & Root.....	40c
Blepen Kultur, by Newman [German].....	40c
Winter Problem in Bee-Keeping [Pierce].....	50c
Bee-Keepers' Directory, by Henry Alley.....	50c
Advanced Bee-Culture, by Hutchinsonson.....	50c
5 Honey as Food and Medicine.....	25c

GEORGE W. YORK & CO., CHICAGO, ILLS.

BEE-BOOKS

SENT POSTPAID BY

George W. York & Co.,
Chicago, Ills.

Bees and Honey, or Management of an Aplyary for Pleasure and Profit., by Thomas G. Newman.—This edition has been largely re-written, thoroughly revised, and is "fully up with the times" in all the improvements and inventions in this rapidly-developing pursuit, and presents the apiarist with everything that can aid in the successful management of an aplyary, and at the same time produce the most honey in an attractive condition. It contains 250 pages, and 245 illustrations—is beautifully printed in the highest style of the art, and bound in cloth, gold-lettered. Price, \$1.00.

Langstroth on the Honey-Bee, revised by Dadant.—This classic in bee-culture, has been entirely re-written, and is fully illustrated. It treats of everything relating to bees and bee-keeping. No apiarist library is complete without this standard work by Rev. L. L. Langstroth—the Father of American Bee-Culture. It has 520 pages; bound in cloth.

Price, postpaid, \$1.25.

Bee-Keepers' Guide, or Manual of the Aplyary, by Prof. A. J. Cook, of the Michigan Agricultural College.—This book is not only instructive, and helpful as a guide in bee-keeping, but is interesting and thoroughly practical and scientific. It contains a full delineation of the anatomy and physiology of bees. 460 pages; bound in cloth and fully illustrated.

Price, postpaid, \$1.25.

Scientific Queen-Rearing, as Practically Applied, by G. M. Doolittle.—A method by which the very best of Queen-Bees are reared in perfect accord with Nature's way. 176 pages, bound in cloth, and illustrated. Price, \$1.00.

A B C of Bee-Culture, by A. I. Root.—A cyclopaedia of 400 pages, describing everything pertaining to the care of the honey-bees. It contains 300 engravings. It was written especially for beginners. Bound in cloth. Price, \$1.25.

Advanced Bee-Culture, Its Methods and Management, by W. Z. Hutchinson.—The author of this work is too well known to need further description of his book. He is a practical and entertaining writer. You should read his book. 80 pages, bound in paper, and illustrated. Price, 50 cts.

Rational Bee-Keeping, by Dr. John Dzierzon.—This is a translation of his latest German book on bee-culture. It has 350 pages; bound in cloth, \$1.25; in paper covers, \$1.00.

Bienen-Kultur, by Thomas G. Newman.—This is a German translation of the principle portion of the book called BEES OF HONEY. 10 page pamphlet. Price, 40 cents.

Convention Hand-Book, for Bee-Keepers. Thomas G. Newman.—It contains the parliamentary law and rules of order for Bee-Conventions—also Constitution and By-Laws, with subjects for discussion, etc. Cloth, gold-lettered. Price, 25 cts.

Amerikanische Bienenzucht, by Hans Buschbacher.—Printed in German. A hand-book of bee-keeping, giving the methods in use by the best American and German apiarists. Illustrated; 138 pages. Price, \$1.00.

Thirty Years Among the Bees, by Henry Alley.—Gives the results of over a quarter-century's experience in rearing queen-bees. Very latest work of the kind. Nearly 100 pages. Price, 50c.

Why Eat Honey?—This Leaflet is intended for FREE distribution, to create a Local Market. 100 copies, by mail, 40 cts.; 500 for \$1.50; 1000, \$2.50. If 500 or more are ordered at one time, your name and address will be printed on them FREE.

How to Keep Honey and preserve its richness and flavor. Price same as Why Eat Honey.

Aplyary Register, by Thos. G. Newman.—Devotes two pages to a colony. Leather binding. Price, for 50 colonies, \$1.00; for 100 colonies, \$1.25.

Preparation of Honey for the Market, including the production and cure of comb and extracted honey. A chapter from BEES AND HONEY. Price, 10 cents.

Bee-Pasturage a Necessity.—This book suggests what and how to plan. It is a chapter from BEES AND HONEY. Price, 10 cents.

The Hive I Use, by G. M. Doolittle. It details his management of bees, and methods of producing comb honey. Price, 5 cents.

Dr. Howard's Book on Foul Brood.—Gives the McEvoy Treatment and reviews the experiments of others. Price, 25 cts.

Dictionary of Apiculture, by Prof. John Phil. Gives the correct meaning of nearly 500 apicultural terms. Price, 50 cts.

Winter Problem in Bee-Keeping, by G. R. Pierce. Result of 25 years' experience. 50 cts.

Handling Bees, by Chas. Dadant & Son.—A Chapter from Langstroth Revised. Price, 8 cts.

Bee-Keepers' Directory, by H. Alley.—Latest methods in Queen-Rearing, etc. Price, 50c.

Foul Brood Treatment, by Prof. F. R. Cheshire.—Its Cause and Prevention. Price, 10 cts.

Foul Brood, by A. R. Kohnke.—Origin, Development and Cure. Price, 25 cts.

History of Bee-Associations, and Brief Reports of the first 20 conventions. Price, 15 cts.

Honey as Food and Medicine, by T. G. Newman.—A 32-page pamphlet; just the thing to create a demand for honey at home. Should be scattered freely. Contains recipes for Honey-Cakes, Cookies, Puddings, Foam, Wines, and uses of honey for medicine.

Prices, prepaid—Single copy, 5 cts.; 10 copies, 35 cts.; 50 for \$1.50; 100 for \$2.50; 250 for \$5.50; 500 for \$10.00; or 1000 for \$15.00. When 250 or more are ordered, we will print the bee-keeper's card (free of cost) on the front cover page.

Bee-Keeping for Profit, by Dr. G. L. Tinker.—Revised and enlarged. It details the author's "new system, or how to get the largest yields of comb or extracted honey." 80 p.; illustrated. 25c.

Emerson Binders, made especially for the BEE JOURNAL, are convenient for preserving each number as fast as received. Not mailable to Canada. Price, 75 cts.

Commercial Calculator, by C. Ropp.—A ready Calculator, Business Arithmetic and Account-Book combined in one. Every farmer and business man should have it. No. 1, bound in water proof leatherette, calf finish. Price, 40 cts. No. 2, in fine artificial leather, with pocket, silicate slate, and account-book. Price, 60 cts.

Green's Four Books, by Chas. A. Green.—Devoted to, 1st, How We Made the Old Farm Pay; 2nd, Peach Culture; 3rd, How to Propagate Fruit-Plants, Vines and Trees; 4th, General Fruit Instructor. Nearly 120 pages. Fully illustrated. 25 cts.

Green's Six Books on Fruit-Culture, by Chas. A. Green.—Devoted 1st, to Apple and Pear Culture; 2nd, Plum and Cherry Culture; 3rd, Raspberry and Blackberry Culture; 4th, Grape Culture; 5th, Strawberry Culture. 129 pp.; illustrated. 25 cts.

Garden and Orchard, by Chas. A. Green.—Gives full instructions in Thinning and Marketing Fruits; Pruning, Planting and Cultivating; Spraying, Evaporation, Cold Storage, Etc. 94 pages, illustrated. Price, 25 cts.

Kendall's Horse-Book.—35 pictures, showing positions of sick horses, and treats on all their diseases. English or German. Price, 25 cts.

Silo and Silage, by Prof. A. J. Cook.—It gives the method in operation at the Michigan Agricultural College. Price, 25 cts.

Lumber and Log-Book.—Gives measurements of lumber, logs, planks, wages, etc. 25c.

Maple Sugar and the Sugar Bush, by Prof. A. J. Cook.—Full instructions. Price, 35 cts.

Grain Tables, for casting up the price of grain, produce, hay, etc. Price, 25 cts.

Capons and Caponizing, by Dr. Sawyer, Fanny Field, and others.—Illustrated. All about caponizing fowls, and thus how to make the most money in poultry-raising. 64 pages. Price, 30 cts.

Our Poultry Doctor, or Health in the Poultry Yard and How to Cure Sick Fowls, by Fanny Field.—Everything about Poultry Diseases and their Cure. 64 pages. Price, 30 cts.

Poultry for Market and Poultry for Profit, by Fanny Field.—Tells everything about the Poultry Business. 64 pages. Price, 25 cts.

Turkeys for Market and Turkeys for Profit, by Fanny Field.—All about Turkey-Raising. 64 pages. Price, 25 cts.

Rural Life.—Bees, Poultry, Fruits, Vegetables, and Household Matters. 100 pages. 25 cts.

Strawberry Culture, by T. B. Terry and A. I. Root. For beginners. Price, 40 cts.

Potato Culture, by T. B. Terry.—It tells how to grow them profitably. Price, 40 cts.

Carp Culture, by A. I. Root and Geo. Finley.—Full directions. 70 pages. Price, 40 cts.

Hand-Book of Health, by Dr. Foote.—Hints about eating, drinking, etc. Price, 25 cts.

Alsike Clover Leaflet.—Full directions for growing. 50 for 25 cts.; 100 for 40 cts.; 200, 70c.

Book Clubbing Offers.

(Read Carefully.)

The following clubbing prices include the American Bee Journal one year with each book named. Remember, that only ONE book can be taken in each case with the Bee Jour-

nal a year at the prices named. If more books are wanted, see postpaid prices given with the description of the books on this page. Following is the clubbing-list:

1. Langstroth on the Honey-Bee.....	\$2.00
2. A B C of Bee-Culture.....	2.00
3. Bee-Keepers' Guide.....	1.75
4. Bees and Honey [Cloth bound].....	1.65
5. Scientific Queen-Rearing.....	1.75
6. Dr. Howard's Foul Brood Book.....	1.10
7. Advanced Bee-Culture.....	1.30
8. Amerikanische Bienenzucht [Germ.].....	1.75
9. Bienen-Kultur [German].....	1.25
10. Rational Bee-Keeping [Cloth bound].....	2.00
11. Rational Bee-Keeping [Paper bound].....	1.75
12. Thirty Years Among the Bees.....	1.30
13. Bee-Keeping for Profit.....	1.15
14. Convention Hand-Book.....	1.15
15. Poultry for Market and Profit.....	1.10
16. Turkeys for Market and Profit.....	1.10
17. Capons and Caponizing.....	1.10
18. Our Poultry Doctor.....	1.10
19. Green's Four Books.....	1.15
20. Green's Six Books on Fruit-Culture.....	1.15
21. Garden and Orchard.....	1.15
22. Rural Life.....	1.10
23. Emerson Binder for the Bee Journal.....	1.60
24. Commercial Calculator, No. 1.....	1.25
25. Commercial Calculator, No. 2.....	1.40
26. Keadull's Horse-Book.....	1.10
27. Strawberry Culture.....	1.20
28. Potato Culture.....	1.20
29. Carp Culture.....	1.20
30. Hand-Book of Health.....	1.10
31. Dictionary of Apiculture.....	1.35
32. Maple Sugar and the Sugar Bush.....	1.20
33. Silo and Silage.....	1.10
34. Winter Problem in Bee-Keeping.....	1.30
35. Aplyary Register (for 50 colonies).....	1.75
36. Aplyary Register (for 100 colonies).....	2.00
37. Bee-Keepers' Directory.....	1.30

Honey & Beeswax Market Quotations.

The following rules for grading honey were adopted by the North American Bee-Keepers' Association, and, so far as possible, quotations are made according to these rules:

FANCY.—All sections to be well filled; combs straight, of even thickness, and firmly attached to all four sides; both wood and comb unsoiled by travel-stain, or otherwise; all the cells sealed except the row of cells next the wood.

No. 1.—All sections well filled, but combs uneven or crooked, detached at the bottom, or with but few cells unsealed; both wood and comb unsoiled by travel-stain or otherwise.

In addition to this the honey is to be classified according to color, using the terms white, amber and dark. That is, there will be "fancy white," "No. 1 dark," etc.

CHICAGO, ILL., Apr. 23.—We quote: Fancy white, 15c.; No. 1 white, 12@13c.; fancy amber, 9@10c.; No. 1 amber, 7@8c.; fancy dark, 8@9c.; No. 1 dark, 7c. Extracted, white, 5@7c.; amber, 4@5c.; dark, 4@4½c. Beeswax, 30c. The number of sales are few, and prices are really nominal. The only activity shown is in a little fancy comb and beeswax.

R. A. B. & Co.

PHILADELPHIA, PA., Apr. 22.—We quote: No. 1 white, 9@10c.; fancy amber, 8@9c.; fancy dark, 7@8c. Extracted, white clover, 10c.; amber, 5@5½c.; dark, 4@4½c. Beeswax, 25@26c. Comb honey is dull. Extracted in fair demand. Beeswax lower. W. A. S.

KANSAS CITY, Mo., Apr. 18.—We quote: No. 1 white, 13@14c.; No. 1 amber, 11@12c.; No. 1 dark, 8@10c. Extracted, white, 5@6c.; amber, 4½@5c.; dark, 4@4½c. Beeswax, 25c. C. C. C. & Co.

BUFFALO, N. Y., Apr. 20.—We quote: Fancy white, 15@16c.; No. 1 white, 13@14c.; fancy dark, 8@9c.; No. 1 dark, 7@7½c. Beeswax, 25@28c. Trade very dull and honey not moving, except a few fancy lots; anything dark is hard to sell. B. & Co.

NEW YORK, N. Y., Apr. 20.—We quote: Fancy white, 14c.; No. 1 white, 12c.; No. 1 amber, 11c.; No. 1 dark, 8c. Extracted, white, 5½@6c. Beeswax, 29@30c. Market is quiet. Some demand for white comb, but buckwheat not wanted. White is selling at from 11@14c. and buckwheat at 8c. The market on extracted is unusually quiet, with large supplies of California. Beeswax steady at quotation. H. B. & S.

CINCINNATI, O., Apr. 22.—There is no fancy white comb honey on our market. Best white sells at 12@14c. in a jobbing way, with a fair demand. Demand is good for extracted at 4@7c., according to quality.

Beeswax is in good demand at 25@30c. for good to choice yellow. C. F. M. & S.

Bottom Prices

**BRING US BIG TRADE.
GOOD GOODS KEEP IT.**

If you want the best supplies that can be made at a little less cost than you can buy the same goods for elsewhere, write to us for low prices. 1896 Catalogue now ready—ask for it and a free copy of *The American Bee-Keeper* (36 pages).

Address,
**THE W. T. FALCONER MFG. CO.,
JAMESTOWN, N. Y.**
Mention the American Bee Journal.

COMB FOUNDATION!

Wax always wanted for Cash or in Exchange for Fdn. or other Supplies. My trade is established on **Low Prices and the merit of my Foundation. Orders filled promptly.**
WORKING WAX INTO FDN. BY THE LB. A SPECIALTY. Wholesale prices to dealers and large consumers. Send for Prices and Samples to—**GUS DITTMER, AUGUSTA, WIS.**
Reference—Augusta Bank. 1A1f
Mention the American Bee Journal.

ROOTS GOODS Prices Reduced on Dovetail Hives and Sections. A full line of Apiarian Supplies in stock to fill orders promptly at lowest prices for Best Goods. 36-page Catalogue Free.
JNO. NEBEL & SON, High Hill, Mo.
Mention the American Bee Journal. 4A26t

I ARISE



TO SAY to the readers of the **BEE JOURNAL** that **DOOLITTLE**

has concluded to sell **BEES and QUEENS**—In their season, during 1896, at the following prices:

- One Colony of Italians on 9 Gallup frames, in light shipping-box \$6.00
- Five Colonies..... 25.00
- Ten Colonies..... 45.00
- 1 untested queen. 1.00
- 8 " queens 5.50
- 12 " " 10.00
- 1 tested Queen... \$1.50
- 3 " Queens. 3.50
- 1 select tested queen 2.00
- 3 " " Queens 4.00

Select tested queen, previous season's rearing. 4.00
Extra Selected for breeding, THE VERY BEST. 5.00
About a Pound of BEES in a Two-frame Nucleus, with any Queen, \$2.00 extra.

☞ Circular free, giving full particulars regarding the Bees and each class of Queens.
Address

G. M. DOOLITTLE,
12A25t **BORODINO, Onon. Co., N. Y.**
Mention the American Bee Journal.

BEES QUEENS
Smokers, Sections, Comb Foundation, and all Apiarian Supplies cheap. Send for FREE catalogue. **E. T. FLANAGAN, Bellefonte, Ill.**
6A26t Please mention the Bee Journal.

AWAY UP IN

the air the current is strong and powerful. We have the mill that will utilize it to best advantage, and our four cornered double braced steel tower will hold it there. Perfectly galvanized. Many sizes. Only one quality—**THE BEST.** Tanks, Shellers, Cutters, Pumps, Horse Powers, &c. Write for illustrated catalogue. **FREE CHALLENGE WIND MILL & FEED MILL CO., BATAVIA, ILLINOIS, No. 18 River Street.**



Mention the American Bee Journal.

19th Year Dadant's Foundation 19th Year

Is still in the lead, for we use all the latest improvements, including the

NEW WEED PROCESS,

and still make the best goods. Remember that we do not use any acid to purify our beeswax, and that is why our Foundation preserves the smell of the honey and is more acceptable to the bees, than any other. It is kept for sale by

T. H. Strickler, Solomon City, Kansas.
G. K. Hubbard, Fort Wayne, Ind.
L. Hanssen, Davenport, Iowa.
C. Theilmann, Theilmanton, Minn.
E. C. Eaglesfield, Berlin, Wis.
E. T. Abbott, St. Joseph, Mo.
J. M. Jenkins, Wetumpka, Alabama
John Rey, East Saginaw, Mich.
Vickery Bros., Evansville, Ind.

The Jennie Atchley Company, Beeville, Texas.
C. F. Muth & Son, Cincinnati, Ohio
E. Kretchmer, Red Oak, Iowa.
G. B. Lewis Co., Watertown, Wis.
James Reynolds Elevator Co., Poughkeepsie, N. Y.
Louisiana Bee-Keepers' Supply Manufactory, Donaldsonville, La.
Page & Lyon, New London, Wis.

and many other Dealers. All agree in saying that no goods are better than ours.

Those of our customers who formerly bought through Thos. G. Newman can get our Foundation in **Chicago, Ill.**, by addressing us at **118 Michigan Street.** We keep no other goods there.

We make a specialty of **Veils and Veil Stuffs** of best quality, cotton and silk.

"LANGSTROTH ON THE HONEY-BEE"—Revised.

Bee-Keepers' Supplies, Smokers, Sections, Tin Pails, etc.
Samples of Foundation and Tulle FREE with Circular. Instructions to beginners with Circular. Send us your address.

CHAS. DADANT & SON,
Mention the American Bee Journal. **HAMILTON, Hancock Co., ILL.**

26c Cash Paid for Beeswax!

For all the good, pure yellow **BEESWAX** delivered to our office till further notice, we will pay 26 cents per pound, cash; or 30 cents for whatever part is exchanged for the *American Bee Journal*, Books or Seed, that we offer. If you want **cash promptly** for wax, send it on at once. Dark or impure wax not taken at any price. Address plainly,

George W. York & Co., 118 Michigan St., Chicago, Ill.

Lower Prices on Sections & Foundation

Improved facilities, increased output, and competition, together with hard times, tend to lower prices.

Root's No. 1 White Extra-Polished Sections

are superlative in quality, and are now offered for a short time at the following special prices for 4 1/4 x 4 1/4 any stock width: **1000, \$2.50; 2000, \$4.50; 3000, \$6.45; 5000, \$10.00.**

Cream Sections of such widths as we have in stock at 25c per 1000 less than the white.

The New Weed Process Comb Foundation

is superior to all others in every way, showing, from recent tests in Florida, five times greater resistance to sagging, making it possible to use a lighter grade with more feet to the pound, with greater safety than with the old process. Owing to decline in wax we reduce price of Foundation **3 cts.** a pound. Prices now are:

	Price per lb. in lots of 1 lb.	10 lbs.	25 lbs.	50 lbs.
Heavy or Medium Brood Foundation.....	44c	43c	42c	40c
Light Brood.....	47c	46c	45c	43c
Thin Surplus.....	54c	53c	52c	50c
Extra-Thin Surplus.....	59c	58c	57c	55c

Lower prices on 100-lb. lots, and dealers supplied at special prices.

These wholesale dealers who handle Root's Goods in carload lots unite with us in above prices:

Walter S. Poudet, Indianapolis, Ind.; John Nebel & Son, High Hill, Mo.
Joseph Nysewander, Des Moines, Iowa; Wm. A. Selser, Philadelphia, Pa.
M. H. Hunt, Bell Branch, Wayne Co., Mich.; Geo. E. Hilton, Fremont, Mich.

THE A. I. ROOT CO., MEDINA, OHIO.

118 Michigan St., Chicago, Ill. **Syracuse, N. Y.**
1024 Mississippi St., St. Paul, Minn. **Mechanic's Falls, Maine.**

AMERICAN BEE JOURNAL

DEVOTED EXCLUSIVELY TO THE INTERESTS OF HONEY-PRODUCERS

ESTABLISHED 1861
THE OLDEST BEE-PAPER IN AMERICA

Published Weekly, at \$1.00 per annum.

Sample Copy sent on Application.

36th Year.

CHICAGO, ILL., MAY 14, 1896.

No. 20.



The Price of Honey—Some Good Advice.

BY MRS. L. HARRISON.

There is one thing that has been puzzling my brain a long time, and that is the price of honey. When the "trusts" that control the manufacture of whisky, glucose, oil, etc., see that there is enough to supply the trade, they issue the order to shut down; control the supply and demand. Overstock the market, and the price will go below the price of production. The bee, in her wisdom, controls the number of her offspring in ratio with her income, and four years ago she was compelled to shut down in the production of honey.

Has this cutting down in the production of honey increased the price? This shortage ought to increase the price to one dollar per pound; has it done so? We would be laughed at if we demanded one quarter of that.

In the market report of the American Bee Journal for April 2, white clover honey is quoted in Chicago and Philadelphia at 15 cents per pound; in New York, Cincinnati and Kansas City at 14 cents. Who is too blame in this matter? Let each one ask the question, "Is it I?" What are we going to do about it?

It is true we've been very benevolent. Who is there among us that has not hived swarms, transferred bees, introduced queens, and given freely all the information possible? We felt well paid if our instructions were followed. With our conventions, and by pen and voice, we have increased the number of bee-keepers, and has this reduced the price of honey? I think not, for it is yet scarce.

From Illinois to Florida there is a wail, which is echoed back, "I can't sell my honey!" Is it true that a crop of honey cannot be disposed of as readily as corn, wheat or oats and butter? This state of affairs, of the low price of honey, and want of a market, is due in a great measure to the producers. A bee-keeper is puffed up with pride when he can ship off to a large city, honey by the carload. These large markets are glutted, and prices rule low, governing the price elsewhere. Offer a groceryman honey, and he will turn to a price-list and see what it is in Chicago or New York, and want to deduct from the price of your honey the transportation, commission, etc., for taking your honey there.

I've seen extracted honey selling at St. Andrews Bay,

Fla., at retail for 10 cents per pound, that was shipped from Chicago, more than 800 miles distant, in a tin can; while local bee-keepers were complaining, "Can't sell honey!" If producers would supply their own neighborhood, and all near towns, at a price a little in advance of what they can realize in a city market, and sell at home all bulged, discolored and unsightly sections, there would soon be a change for the better in the honey market. If you need a load of coal, drive to a coal-bank with honey enough to pay for it; take your blacksmith some. It need not be the choicest you have, for they will not look for an uncapped cell, or one with bee-bread.

When a customer calls at you home for honey, show what you have for sale. If he prefers a fancy article, all right; but let him pay a fancy price. If you have honey fallen from the sections, or marred in some way, tell him that it is just as good, but not being in good marketable shape, you will sell it much lower. Many persons prefer to buy dark sections, if it is cheaper. I once saw at a first-class grocery a case of sections with white honey next the glass, and the inside ones very dark. The buyer said that he had been deceived, and



Mrs. L. Harrison, Peoria, Ill.

he could not sell his dark honey to his class of customers, and he wanted me to buy it to feed my bees.

Honey-producers, let one and all try to improve the honey market by selling at home every pound possible at a fair price, and shipping only cases of honey whose every section showing through the glass is a fair sample of those in the center.

Effects of Bee-Stings on the Human System.

Read before the Central Iowa Bee-Keeper's Convention,

BY HON. EUGENE SECOR.

I am not a doctor. I can't read the human body like a book—especially if the book is easy to understand. I am not skilled in pathology or therapeutics. But if I may be allowed to express a humble opinion based on unprofessional observation, I will say that *one* effect of bee-stings on the human system is in the nature of a stimulant. The virus introduced through the cuticle by the bee herself is exceedingly stimulating, if not exhilarating. It beats tobacco or any narcotic. It is way ahead of intoxicants.

I am led to this conclusion by effects produced on one of my visitors after one application of the medicine, hypodermically administered. It doesn't seem to make much difference on what part of the anatomy the fluid is injected. It works just as effectually in one spot as another, and operates instantaneously. If the patient would prefer the scar in his back hair, hidden from vulgar observation and irreverent remark, he will feel its effects, and respond to its influence with alacrity. Whether administered behind the right ear, or on the ornamental appendage which sometimes obtrudes itself into other people's business, or "below the belt" under the trousers, it "gets there" just the same. The laziest man in America will get a hustle on him instant after one dose. He can run through a troop and leap over a wall like a trained athlete. A ten-wire fence barbed to stop swine is no obstruction to him when he gets under motion. He feels as if he could outrun a tornado or swim Lake Erie. He doesn't wonder that Samson twisted the jaw of the young lion or slew a regiment of Philistines. He could do it himself with another application of this formic acid preparation, administered from the "business end" of a lively bee.

It is a little strange that any one should resist the application of an agent promising such wonderful results. But I suppose it is only another evidence of our depraved condition. I never knew a man, no matter what his profession might be, that wouldn't be willing to let the hired man experiment with the stuff rather than take it himself.

Another effect produced on *some* human systems by the toxic action of this concentrated essence of *Apis mellifica*, is the respect for the eighth commandment—especially when the thing coveted happens to be honey, and the said honey happens to be policed by a select company of trained and fearless guards, equipped for such service.

An instance may be cited to show the respect for moral and statute law, which one application of our favorite remedy produced:

One bright, moonlight night in the early part of September, Anno Domini Eighteen-hundred and some odd years, a convivial company of young men thought to round out the festivities of the evening by a visit to a neighbor's bee-ranch for the purpose of appropriating the tempting morsels of forbidden sweets—all the more sweet, as some think, because the moral code says, "Thou shalt not steal."

One young man was posted to watch. One—more self-assured than the others—volunteered to go after the honey. Two timid ones waited in the edge of a sheltering corn-field to share the spoils. Young man No. 2 proceeded to his self-assigned task. Of course, he wasn't afraid! He had robbed bumble-bees' nests, killed rattle-snakes, fought flying ants, and had swum in the pond where bloodsuckers scented a boy afar off. He went to a hive that happened to be the home of a colony of real healthy hybrids, but he didn't know it. He rapped on the hive to see whether it was "empty," or whether there was a prospect of plunder. Having satisfied himself they were all right, he attempted to remove the cover. It was glued fast with propolis. He couldn't budge it. As he hadn't any jack-knife to pry it off with, he picked up a stick and

tried to loosen it. Finally, with a sudden jerk, the cover came off with a snap, and the enraged bees covered the young man as the locusts covered the land of Egypt in Pharaoh's time. He ran. Half a thousand bees kept him company. The other young men expressed their sympathy by trying to help him. Result: They beat a mad retreat covered with bees if not with glory. The next morning they were wiser, if not handsomer. They gave it out that they had been to a "wake." From that time to this they have never appropriated their neighbor's pancake sweetener without permission.

Forest City, Iowa.



The Swarming Mania—Remedy Therefor.

BY G. M. DOOLITTLE.

A correspondent writes thus: "Will you please tell us in the American Bee Journal what causes excessive swarming, and how it can be prevented? Last year my bees swarmed and swarmed till I became nearly disgusted with them, they doing little else during the season but swarm."

From years of experience I believe that excessive swarming in any locality comes only with certain conditions, and when these conditions are present we find excessive swarming is the result; when not present, there is no more than the usual amount of swarming. The conditions requisite to excessive swarming are a warm, favorable spring, with a warm, wet summer, thus giving just enough honey to keep brood-rearing at its best, and still not enough so the bees store any great quantity, so as to diminish the brood.

The conditions which tend to keep swarming in check, are a copious yield of honey early in the season, or a season so adverse that the bees are compelled to retrench brood-rearing, in order to keep alive. With the first comes moderate swarming; with the last, very few if any swarms. With such a very poor season as that last mentioned, I have found that the Italian and Cyprian bees will get more honey, and swarm more, than the hybrids or blacks, while in an extra-good season they swarm less. When the season is favorable to excessive swarming, the different races of bees are affected very nearly alike, though the Carniolan seem to have a greater tendency to swarm than any other race of bees with which I am acquainted. With this exception, all of my experience goes to prove that no particular strain or variety of bees is given to a predisposition to swarm, more than any others, when viewing the matter as a whole, and covering a period of a quarter of a century.

For instance, I find by referring to my diary, in 1871 and 1872, I had a certain strain that gave many swarms each of these two years; and as I was anxious at that time for increase, I was pleased with this strain of bees, and bred largely from them; but during the next two years this strain of bees swarmed very little, and my increase was solely from my hybrid colonies, as 1873 and 1874 were good honey-years as compared with 1871 and 1872.

Again, in 1876, I was something like our correspondent—nearly disgusted with swarming—having nearly 350 swarms from 67 or 68 colonies in the spring. Everything swarmed and re-swarmed, till I was glad to have the season come to a close. Prime swarms sent out three or more swarms; second swarms divided up, 3-frame nuclei swarmed, and some nuclei swarmed without a queen, so that from five to ten swarms, all in one batch, was no uncommon thing; while the record says that one day I had only 11 clustered in a hedge fence all together, much to my annoyance. But with 1877, *with the very same strain of bees*, and nearly the same number of colonies, I had *very few* swarms, and secured the large yield of upwards of 11,000 pounds of honey, nearly all of which was comb honey.

Since 1876 I have not had excessive swarming in my

apiary, yet I have very largely the same strain of bees which I then had. Will those who call excessive swarming an "inherited mania," tell me why the excessive swarming of 1876 has not been kept up?

Once more: A few years ago I had one queen which led out three prime swarms, completely filling her hive with bees and brood each time before they swarmed (a thing which never happened with me except in this one instance), and from the reasoning of those who claim such swarming an inherited mania, they should have swarmed excessively the next year and since then, yet such has not been the case, for the next year not a single swarm issued from either of the five hives containing the original queen or the four young ones reared from her.

The success or failure of all things pertaining to bee-culture depends largely upon the season and surrounding influences; and the sooner we realize this fact the sooner we shall have greater charity for those who do not agree with us, and have a broader view of the possibilities of apiculture.

Again, to form a correct conclusion we need an experience covering a term of years, for no two years are alike. What will work well one year, and in one locality, will not hold good in another, and I find more and more, each year, that I need a broader charity, so that I shall do no injustice to others who differ from me. It is said that the bee-doctors disagree the most of anybody, and more than in any other profession or calling in life; but I mistrust that if any two of these disagreeing ones were to work in the same apiary during the same year, they would see "eye to eye."

The only remedy I know of for swarming, excessive or otherwise, is the free use of the extractor during the swarming season, and they who expect to work for comb honey without any extra manipulation, and not have swarms, will sooner or later be disappointed.

In swarming, the bees but carry out the instinct implanted in them by Him who said, "Multiply and replenish the earth;" and very many of our best bee-keepers believe that a judicious increase by natural swarming will secure the best results in comb honey.

All non-swarming colonies, and all non-swarming strains of bees have, during the past, sooner or later become a disappointment to those who placed their affections upon them.

In the above I have simply given my views, based upon practical experience, and if any disagree, I accord to all the rights which I enjoy.

Borodino, N. Y.



Straight Worker-Comb Without Foundation.

BY I. W. BECKWITH.

G. M. Doolittle's method, as given on page 113, is a modification of the way I practiced 25 years ago. He considers that it is the strength of the colony that gives the bees a desire to build drone-comb, which I think is a mistake, or partly so.

I observed that a colony composed almost entirely of old field-bees were not inclined to swarm or rear drones, no matter how strong in numbers. So I took two straight combs, containing but little capped brood, with the queen and adhering bees, from a strong colony and put them into an empty hive, moving the old hive a considerable distance, and put the new one in its place, so as to catch the old workers from the old hive. If this did not make the new colony strong enough, I moved it a little every day till I had it by the side of a strong colony, which I moved and put the new one in its place. I put an empty frame between the two combs, and when this was nearly filled, I spread them and put in more empty frames. If the colony was strong enough to justify, I put in more combs and frames at first.

I removed nearly all the brood as fast as capped, so that

but few bees would hatch in the hive; but kept up the required strength by putting it in the place of strong colonies as above.

If I did not wish an increase of colonies, I divided the old (now queenless) colony among such as needed their strength.

In the high altitude of this State, where it is always cool during nights and cloudy weather, Mr. D. would find it difficult to get those weak colonies to build comb of any kind; but with the plan described above, I got an abundance of worker-comb and no drone, unless I allowed too many young bees in the hive.

The reader will notice that as long as Mr. Doolittle allowed but few bees to hatch in the hive he got worker-comb all right, and only got drone when the conditions which he described would give the colony an abundance of young bees.

It may be said that swarms built drone-comb before they have hatched much brood. Very true; but when in a normal condition they do not swarm till they have young bees to go with them.

Since coming to this State I have been troubled a good deal by those combs not wired sagging, allowing the bees to rear drones near the top where the cells are now larger than first built. But this difficulty may be overcome by leaving the bottom-bar off till the frame is filled, when it will be found that the comb has been built low enough to be supported by the bottom-bar.

If the combs between which the empty frames are put are not entirely filled with brood at the top, the bees are liable to attach the new comb to the old, making crooked, bad work, so I find a comb-guide a necessity. I prefer a wax guide $\frac{1}{8}$ to $\frac{1}{2}$ inch wide, with a thin, feathery edge to a two inch foundation starter, and I will tell you how I make it. I got a valuable hint from Mr. C. E. Mead, on page 178, of Vol. XXXIII:

Have a board as long as the inside length of the frame, about two inches wide and a little thinner than $\frac{1}{2}$ the width of the top-bar for a guide-stick. Take an old rifle cartridge shell, and make a $\frac{1}{8}$ -inch hole near the lower or head end, and stick two bits of solder on the opposite sides at the upper end. On the table in front of you have a board a little larger than the frame. Near the back edge drive two nails about a foot apart, letting them project an inch or more. Raise the back edge of the board a little, lay the frame on the board with the top-bar toward you, and the bottom-bar over the projecting nails. Have the guide-stick well soaked, wipe it with a wet cloth, and lay it in the frame against the top-bar, and hold it in place with the left hand. Take the cartridge shell between two fingers of the right hand, just under the solder ears, dip it in the melted wax and put the thumb over the mouth to prevent the wax running out while you carry it to the work. Let the bottom rest on the guide-stick, with the hole next the top-bar, and pour a little stream the whole length of the bar.

I use two table-boards and two guide-sticks, so as to give wax more time to cool.

After using the stick two or three times, the wax may stick a little, then turn it over and use till it sticks; then change ends and use two sides; then scrape off all sticking wax, dip it in cold water and wipe again.

The wax should not be much hotter than melting, or it will stick worse to the guide-stick. If you get a line of wax $1/16$ -inch wide it is enough. If the dipper holds too much, have less wax in the dish, or put a stick in the shell so it will hold less.

By using a light wax-guide in sections you will avoid the objectionable "fish-bone" that foundation produces.

Grover, Colo.



Now is the Time to work for new subscribers. Why not take advantage of the offer made on page 312?

Production and Marketing of Comb Honey.

Read at the Wisconsin Bee-Keepers' Convention

BY F. L. MURRAY.

The greatest essentials, according to my idea, are these:

1ST, THE APIARIST.—Without a good, practical man or woman to see to the proper manipulation of the bee-yard in general, and to see to all the minor details, and have the tub right side up before the honey-flow begins, I think there is a small chance of getting a paying crop at present prices.

2ND, THE LOCATION.—If we do not have a good location, and thoroughly understand its flora, our bees and knowledge would not count for much as a money-making industry, and I do not think there are many of us that keep bees for pleasure alone, although I can get more pleasure out of my bee-yard than any other occupation I ever tried, but I want a little profit also.

3RD, BEES AND APPLIANCES.—With the two former provided, we can next get our bees. It does not make much difference what kind they are (although I prefer Italians), so long as they are of a good working strain, and with the modern improved appliances. There are so many different kinds of good hives and surplus arrangements, I will not try to enumerate them, but I think anybody ought to use his own judgment according to his own tastes and surroundings.

We are now ready to get a crop of honey *if there is any to get.*

I use the 8-frame dovetailed hive, and winter my bees in a cellar made purposely for them. It is made in the side of a hill, so I don't have to go down any steps in carrying bees in and out of the cellar. It is 8 feet high, 10 feet wide, and 16 feet long, and was made to accommodate 100 colonies.

I take the bees out of the cellar about April 1 to 10, and examine them the first warm day to ascertain the strength of colony and amount of stores. Weak colonies I contract to about four frames, and those in need of stores I provide with sugar syrup food, or combs of honey if I have them. I then put on a quilt of burlap over the frames, then a super, and fill the super with chaff, and leave them. This is all the spring packing I ever use. It acts as an absorbing cushion over the cluster, and if they can be kept dry they will not be much hurt after being put out.

They are thus left until about May 10; the chaff-filled super is then removed, and colonies looked over again to see in what condition they are. All last year's queens are clipped at this time, and an extra hive-body filled with drawn combs is put over each *strong colony*; that will give ample room for the queen when she gets crowded for room below. The weak colonies that were put on four frames are now given the other four empty frames. They are then left until just before the honey harvest, which begins here about June 10, from white clover.

All the extra hive-bodies that were put on all strong colonies are now removed, and the hive proper is filled up with brood from the top story, and if there is more brood than will fill the lower story, I use it to strengthen weak colonies, or make increase. In this way I get all my bees in condition for the harvest.

I then put on the surplus arrangement, which is a pattern bottom super that will hold 24 $4\frac{1}{4} \times 4\frac{1}{4} \times 1\frac{1}{8}$ -inch sections. I practice the tiering-up plan, putting supers either under or over, according to my judgment, in regard to length of flow.

I hive the bees on full sheets of foundation, on the old stand, removing the old hive with brood to a new stand, after shaking out all young bees at the entrance of the new hive; there will always be enough young bees left to take care of the brood. The seventh day I cut out all queen-cells but one; 10 days from this time, if the honey-flow still continues, I put a super filled with full sheets of foundation on the old hive,

and have had the bees fill a super in three days after the young queen begins to lay.

I remove all comb honey as soon as it is fully capped over, to the honey house. It is then all scraped, graded and put into new basswood crates, with glass front, each crate holding 24 pounds. I make only two grades, 1st and 2nd—the 1st grade is nice, straight sections, fully capped over on both sides. The 2nd grade consists of all sections that have one side fully sealed over, the other side being full of honey, but not all sealed over. From all that do not come under these requirements the honey is extracted, the sections are put back on the hive for bees to clean up, and they are then stored away with a paper put between each super, to keep all dust out, to be used the following season.

When shipping honey I nail two 24-pound crates together, one on top of the other, with pieces of lath, leaving the glass exposed so that the trainmen can see what it is, and handle it more carefully. I load it myself in the car, and ship to some good, reliable commission house in Chicago, or any other place where there is a good market, and I have always been able to get the top market price for it, as I always put it on the market in a clean, attractive condition, and have never had any broken in transit.

I prefer this method to putting it on the home market, as I get my returns all together instead of 25-cent pieces, as is generally the way in the home market, and it is less trouble. Of course, I always supply my home market as long as it lasts, but I do not try to sell it all in the home market.

This is a synopsis of my methods. There are quite a number of things I would like to explain more fully, but I have cut it as short as possible, so as not too take up too much time.

Calamine, Wis.



Organization and Co-Operation Urged.

BY W. D. FRENCH.

We have now arrived at a period where men engaged in all branches of industry have united their respective forces, or supervisions, under one head. They have combined their various elements, and formed gigantic monopolies, in order to enhance the value of their product, and to establish a price thereon that may be scheduled throughout the United States.

Then, why should not the bee-keeping fraternity join hands, and form one grand circle, stretching forth their enclosure from ocean to ocean?

Can it be possible, at this stage of events, that the apirists of our country will continue to peacefully submit to a gang of unscrupulous beings, who have by their skill in lying, succeeded in fleecing to a finish those who have furnished the capital and stock, and then declare the incompetency of the bee-keeping fraternity to organize in their own behalf, and for their own protection?

The honey-industry of this country, consolidated and placed under the supervision of a General Manager, who should be located at Chicago, holding the reins over all the principal cities of the United States, which should also have their head-quarters for distribution, equalizing the product so as not to overstock one place, while others were destitute, would certainly place our industry in its proper position, and it would then be recognized as one of the leading pursuits of our country.

If the California Bee-Keepers' Exchange would become an auxiliary to such an organization, its usefulness would be increased beyond measure. All other States would then follow the same line, and a complete organization would be consummated.

Local organizations, acting independently and upon their own resources, are in a measure beneficial; but their inability

to establish a market price for their product in other cities cannot be disputed.

Where the product of one State is brought into direct competition with others, no organized effort of the one can adjust prices for either. Therefore, in order to accomplish the object which has hitherto been consummated by all other industries in this country, it will positively be necessary that all bee-keepers unite under one general management, which might be known as the "Bee-Keepers' Union of America."

If there are any who may infer that I am antagonistic to the California Bee-Keepers' Exchange, they are not aware of the true sense of my feelings. I am strictly "in it," and trust every bee-keeper of this State will do likewise.

Large bodies move slowly, and to interest the entire bee-keeping fraternity of the United States will take time, although we are "getting there," and "don't you forget it."

Foster, Calif.



Better Marketing of Honey—Adulteration.

BY EDWIN BEVINS.

Doubtless bee-keepers everywhere are profoundly grateful for the light they got from reading the answers to Query No. 7. They know now just how to get some more money for the crop of 1896 than they did for the crop of 1895. Of all the replies to this query, I like the first one the best. It leaves the bee-keeper at perfect liberty to market his honey in any way that his fancy or his reason may suggest. The majority of those making replies seem to think that working up the home market will do much towards getting us out of the woods. That will, doubtless, help to some extent, but there may be times and circumstances when it will cost as much to work up the home market as the difference between the price you will get in it and the price you will get when sold or consigned to the wholesale dealer.

I would like to know what Dr. Miller means when he says, "Perhaps a better quality of extracted honey." Does he mean that *all* extracted honey must be raised to a higher level? Is there not *some* extracted honey that is just as good as it can be? If he means by a better quality, unadulterated extracted honey, he would be quite right. But, unfortunately the *suspicion* of adulteration attaches to the whole extracted product. Were it not for this suspicion there is no sensible reason why pure extracted honey should not sell for as much as comb honey. If anybody wants to fill their stomachs partly full of something irritating and indigestible, they can mix their extracted honey with sawdust, and so save the bees a good deal of time and labor in comb-building.

One man says in the American Bee Journal that somebody stole his extractor ten years ago, and that he was glad of it. I would keep an extractor if only to get honey for my own use. I will not eat honey-comb when I can get the honey without the comb.

But to return to the subject of honey-adulteration. This damnable business is the greatest drawback to successful bee-keeping that the apiarist has to contend with. "But, gentlemen bee-keepers, what are you going to do about it?" An echo answers, "What?"

There was some honey on sale here last winter, put up in glass tumblers, purporting to hold a pound, and having in them a strip of honey-comb. They also had a printed label telling how to liquefy the honey if it should happen to granulate. This honey was retailed by the grocer at 10 cents a tumbler. I told the grocer that I did not believe it was pure honey. He said that he did not think it was, but that it *would sell just as readily as if it was pure*. The instructions how to liquefy were superfluous. I would warrant it not to granulate in 20 years, even if kept on ice. The outlook for any immediate advance in the price of extracted honey, or any

diminution of the supply while the glucose barrel is handy is not encouraging. Dr. Miller's answer leaves us still in the dark.

Mr. Abbott seems to think he has found a panacea for all bee-keeping ills in the exercise of push, vim, energy, and other kindred virtues. I would respectfully ask Mr. Abbott of what avail are push, vim, energy, etc., against the small-pox? But, hold on, Mr. Abbott makes a provision that he is to be let alone. But we will suppose that he is not let alone. It is more than likely that he will not be let alone. It is quite likely that he will be overtaken by the small-pox, or, in other words, that the honey-adulterator, or his agent with push, vim, energy, etc., will get around on his territory and undersell him. Mr. Abbott need not flatter himself that he is going to head off the adulterated article entirely by offering a nice article of nicely-put-up comb honey at a moderate price. I fancy that the sale of the nice honey will suffer some by the competition. Is not the price of nice comb honey diminished and its sale restricted everywhere by this competition? Mr. Abbott disclaims any need of law to aid him in the sale of his goods, and the above is written on the supposition that the other fellow has a free field for the exercise of his pluck, push, and energy.

What did the man mean who said he thought he could see some advantage to bee-keepers in a change of Administration? Possibly, in my endeavor to probe this matter to the bottom I may be found trespassing on forbidden ground, and expose myself to a vote of censure.

On this important subject—of how to get more money for the honey-product—I have no suggestions to make. Only this: I will say to comb-honey producers, that I have recently seen some section honey on sale that was very unattractive in appearance. The sections were half to three-quarters filled, and the comb looked as if the bees had traveled over it a good deal after having waded through pools of tobacco-juice. The wood of the sections was of about the hue, and looked as if it might be as old, as an Egyptian mummy. It would be an advantage, perhaps, if the bee-keeper would keep such stuff out of sight. If he is so unfortunate as to have it he would better feed it to his bees, if they will eat it.

The remedy for this state of things is obvious, and the man who applies the remedy will no doubt find some financial advantage in doing so:

Leon, Iowa.



Swarming—Its Control and Management.

BY PROF. A. J. COOK.

The control and management of swarming has been a most difficult matter—a problem which as yet, no bee-keeper has been fully able to solve. The question is specially puzzling to the comb honey producer. To secure a bountiful harvest he must have very populous colonies, but when colonies are very populous they are disposed to swarm, and thus we have Charybdis and Scylla—either too weak colonies or too much swarming. This fact led the late Mr. Quinby to offer \$50 for a queen that would produce bees void of the swarming impulse.

Eight days after a swarm issues a new queen will emerge from the cell, and quite likely a second, and possibly a third, and rarely a fourth and fifth swarm will come forth. Of course, these last swarms will be weak, and almost if not quite worthless. This is another difficulty that confronts the bee-keeper. He desires no increase, or at most only one colony from each old one, and much study has been devoted to the accomplishment of this desire with the least labor.

It has not been uncommon among bee-keepers in the past to practice artificial division—making new colonies to suit one's desires. This, however, is rarely done now-a-days, and I think I may safely say that it is the consensus of opinion among all our best bee-keepers that the best results are gained by permitting natural increase or swarming, and controlling and limiting this as far as possible without too much labor, and never permitting a colony to swarm more than once. In case we work for extracted honey it is not difficult to control

swarming almost at will. In this case we can give plenty of room, and, as Mr. Simmins, of England, has urged, bees are not likely to swarm with empty space at the front of the hive, nor are they hardly less so if plenty of room is provided for storing in the hive. Thus, by adding a second or third story to the hive, each with its quota of extracting-combs, we are likely to prevent swarming entirely.

If we work for comb honey—and I must confess there is a pleasure in taking a full harvest of the white comb in neat one-pound sections that is hardly known to him who only produces extracted honey—then this question of swarming becomes a very practical one. The first thing we can do is to put our supers on the hives at the very dawn of the harvest. This may prevent the swarming instinct in case crowded quarters have not already incited the bees to commence preparations for swarming by making queen-cells, and beginning to rear queens, and so we may not have swarms, or any attempt to provide for them on the part of the bees. This means more surplus comb honey and more profit for the bee-keeper. If when the surplus cases are put on a few sections partially filled from last year are put in the center of the case the bees will, or may be inclined to, go to work at once in them, and when once at work in the sections, swarming will rarely take place, unless young queens are already being reared. Small pieces of white drone-comb containing brood, fastened in one or two central sections, removes this comb from the brood-chamber, where it is not wanted, and still more attracts the bees to work in the sections.

If the bees swarm before the season opens, or if queen-cells are already formed and peopled when the section-cases are added so that swarming occurs, then it is best to proceed as follows:

Put the new hive, containing combs if they are to be had, or frames filled with foundation, or at least with starters of the same on the old stand, exactly where the old hive stood, and in case the sections were on the old hive, put them on the new one. Put the old hive close beside the new one, with the entrance facing the opposite way. That is, if the hive, before swarming occurred, faced east, the new hive for the swarm will face east, and the old hive will stand close beside it, but will face west. Of course, if the queen's wing is clipped, she will be caught and caged, and as the swarm comes back she will be permitted to enter with them, and with almost no trouble or work the new swarm is hived, and will go right to work, and very likely in the sections.

Soon, within a day or two, we gradually commence to turn the old hive around, and by the seventh day after the swarm left it, have the entrance east again close beside the entrance of the new hive. On the evening of the seventh day move this old hive to another part of the apiary. The next morning, as the bees go forth from this hive to work, they will nearly all return to the old place and enter the other hive, making that colony very strong, and in condition to store a great crop. The other colony will be so reduced in numbers that the bees will not be moved to swarm again, and will fall in with the first queen that hatches, and destroy all the other queens, and while this colony will not probably give much surplus, it will make a good strong colony by the close of the season, and will very likely have more honey than it will need for the winter supply. This prevents after-swarms, with no pains to destroy queen-cells, and while it will not always prevent further swarming, it will be more likely to do so than will the method of destroying all the queen-cells but one, for it is very difficult to do this last; some cell in a corner or other concealed place will be missed when the third swarm is likely to issue.

The above method was first given to the public by Mr. James Heddon, of Michigan, one of the brightest and most ingenious and progressive bee-keepers that the world has ever known. I have tried it thoroughly, and rarely failed to make it a success.

Sometimes bee-keepers remove the queen at the dawn of the honey-harvest, and in about eight days destroy all queen-cells but one. The arguments for this course are: It prevents all chance of swarming, which is true in case no queen-cell is overlooked: stops breeding, and so puts all energy towards the production of honey; and it is claimed that the season will not last so that the bees which would have been produced in case the queen was retained will be of any use for that season. This, of course, only follows in case that the season for storing lasts but four or five weeks, and that there is no later harvest. Such a course would certainly never be advocated in Southern California. Again, it is claimed that this course insures young, vigorous queens each year. This is objected to on the ground of labor—finding and removing the queen in very full, large colonies, not always an easy task—and the objection to the removal of queen and all cessation

of breeding in the very heat of the season. I think few if any of our best bee-keepers recommend or practice it.

I have known excellent bee-keepers who only produced comb honey, to practice killing all old queens when the swarms issue, and while the swarm is still out destroying all queen-cells but one. This gives only young queens to all colonies, but I am sure few of our best apiarists would think it at all wise. I think most of our bee-keepers favor swarming once, if the swarming-fever cannot be kept down, and by use of the Heddon or other method cut short all further increase.—Rural Californian. Claremont, Calif.

Questions AND Answers

CONDUCTED BY

DR. C. C. MILLER, MARENGO, ILL.

[Questions may be mailed to the Bee Journal, or to Dr. Miller direct.]

Cutting Out Drone-Comb and Replacing with Worker.

I notice in bee-literature that writers recommend removing drone-comb and placing in its stead worker brood-comb or comb foundation. Some times we find small patches of drone-comb in or near the center of frame. Now, how shall I fasten the foundation in where I remove the drone-combs? I do not like to cut away the entire strip from top to bottom of the frame, to remove the drone-comb in the center. How shall I manage it?

G. W. W.

ANSWER.—You needn't cut away any of the comb except the drone. After you have cut out the patch of drone-comb, cut away the cells on one side down to the midrib, so as to have a margin of $\frac{1}{8}$ to $\frac{1}{4}$ inch all around the hole. Now lay the piece of drone-comb that you cut out on a piece of foundation, and cut a patch of the foundation an eighth of an inch larger all round than the piece of drone-comb. Now put your patch in the hole, pressing the edge of the foundation on the midrib to which you cut down, warming the foundation if necessary.

It may be better to use pieces of worker-comb instead of foundation. In that case, cut a patch of the worker-comb just about the same size as the piece of drone-comb, laying the drone-comb on the worker to cut by, then crowd the patch of worker into the hole. Of course, with old worker-comb you needn't cut away any of the cells down to the midrib.

Using Frames of Capped and Partly Candied Honey—Keeping Bees in a Shed.

1. I lost two colonies last winter with their hives full of honey, and only a small handful of dead bees—queenlessness, I think, was the cause. I use the 10-frame Langstroth hive, with supers for comb honey only. The honey in the combs has commenced to candy; there is only about 5 or 6 inches square of brood-comb on each of only three frames of each hive, and they are partly filled with honey and bee-bread, and that seems to be dry and hard. Can I use these frames full of capped and partly candied honey to any advantage in the hives of my new swarms? Will they accept and use it? What position in the hive must I put it—outside or center? How many frames shall I put into each hive? I intend to use foundation starters for my new swarms. Must I clean the bee-bread out of the combs, or can the bees use or clean it out?

2. I have a lot 60x125 feet, and it is built up all around me. Last summer, when I began to take off the honey, the bees got very cross and would sting the children in the alley, and prevented the neighbors from hanging out their washing. (The bees are a cross between blacks and Italians.) So this spring I put them into the shed (upper story). It is 12x18 by 16 feet high in front, 12 feet in the back, with a window in each end. I put one row on the floor, and one 4 feet above, on a shelf, and cut small openings in front of each hive $\frac{3}{4}$ x5 inches, and put 6-inch alighting-boards the whole length outside, and darkened the windows. They are working very fast,

but seem to be too warm. They are very strong and heavy, and act some like swarming already. If I uncover the window the light is so much stronger than their little entrance, that they fly to them, otherwise they do not fly about in the house, and it is very nice to work about them, only a little too dark. Do you think they will do all right this way? If not, how must I fix it to make it comfortable for both the bees and myself? They are very good-natured so far. I supposed it would be cooler inside when the sun did not strike the hives, but they keep a good many bees in front buzzing for ventilation; seems to be too close and warm. C. O.

Austin, Ill.

ANSWERS.—1. You can hardly go amiss in using those combs. Perhaps as good a way as any will be to divide them equally among the swarms. Count on a smaller number of swarms than you think likely to come, and then if the swarms don't come, you'll not have some of the combs left on your hands unused. If more swarms come than you had expected, it will be no harm to have the last ones without any of the combs. It doesn't matter greatly in what part of the hive you put them, only I'd put them together.

The bees will take care of the pollen, but if any of the combs are chiefly filled with pollen, and it is dry, hard and moldy, you may save some work by soaking it up so it will be soft.

If the bees don't swarm too soon, you might do better not to wait for swarms, but give the combs to old colonies, either in a second story or by swapping for combs that are nearly empty. It will be a little strange if you do not find some of colonies that have combs that are nearly empty, and ready for a swap. There is some danger that the combs on which the bees died will become wormy—indeed, they are pretty sure to become so. Keeping them in a cool place will delay the worms, but there's nothing like having them in care of the bees. A colony in a 10-frame hive, unless weak, can take care of two stories of idle frames and be none the worse, but rather the better for it. Put the idle combs under the colony so the bees in passing in and out must travel over the empty combs. When it comes to put on sections, of course the extra stories can be taken away, but by that time they'll be in better condition for the swarms than if left unoccupied.

2. Probably your bees will do all right. Why can't you take the windows out entirely, so the air can pass through? That would make it cooler for you and the bees, and I don't know that it would do any harm if the bees should prefer to go in and out at the windows. Of course, it won't do to have windows closed with glass and allow the bees the chance to wear themselves out on the glass.

If the bees are too warm, it would be a good plan to make entrances larger. Instead of $\frac{3}{4} \times 5$ inches, you could have 3×5 , or 3×10 . Possibly the entrance of the hive itself needs enlarging. If the bees make trouble by flying around in the shed, it ought not to be a great deal of trouble to make a passage-way to each hive so the bees could not get out the wrong way.

Introducing by Transferring Frame with Queen, Bees and All.

I want to know whether it is safe to introduce (or try to) a queen by taking the frame she is on from one hive and introduce it (queen and all) into the queenless hive? If it will work, I want to follow this practice:

Colony No. 1 has a very fine, prolific queen, and as I am intending dividing this spring to a considerable extent, I want the queens to come from this queen. Now, I contemplate making colony No. 2 queenless, and then take the frame upon which the queen is situated from colony No. 1 and insert it, queen and clustering bees, into No. 2. No. 1 will then build queen-cells, which I will cut out in about a week, and insert into divided colonies, and then take the queen from No. 2, on the frame as before, and place her with frame and clustering bees again in No. 1. This process I will repeat every week, or such a matter, until I have all my colonies supplied?

What do you think of the plan? What effect will it have on the honey-producing of No. 1 and No. 2, which I will not divide? Will it not have the same effect as caging the queen, that some advocate? G. W. C. J.

Wichita, Kan.

ANSWER.—As a rule you will find a queen accepted in a queenless colony if taken with a frame of brood and bees from her own colony, especially in the honey season. But on the whole, I'm not sure you will like the contemplated plan. When you put such queen in a strong colony, and queen-cells

are present, the bees may take a notion to swarm. You may think there are no queen-cells left, but it's a very hard thing to make sure that you've missed no cells. Not so very hard to find the cells after a colony has swarmed naturally, but it's a very different thing when the queen has been taken away and the bees have constructed after-cells. They'll be hidden in all sorts of places, and sometimes you'll look right on the middle of a comb and hardly detect it, for it will project very little from the surface. And if a queen-cell is left and the bees don't swarm, there is a chance that the young queen may be allowed to kill the old one. After all, you may like the plan better than I think.

Suffering from Bee-Paralysis.

What is the matter with my bees? A strong, prime swarm from last spring, with a prolific queen this spring up to date are at war among themselves.

Why, or from what cause, do bees continually wiggle on the alighting-board? Why are some bees hatched out by the above colony, long, black and shining, abdomens slender, and no hair on them? They are young bees, and seem to be afraid of the other bees. It is good for them to be, too, because they are killed daily.

Honey is coming in fast from white clover.

Monroe, La., April 25.

H. R.

ANSWER.—From your description your bees have bee-paralysis. In the North it never seems to amount to much, but in the South it becomes very destructive. The worst of it is that there seems so far to be no cure known. True, a good many cures have been given, changing the queen, giving salt, etc., but whenever a cure is given the very next one that tries it reports it a failure. About the only comfort I can give you is the cold comfort of saying to you to wait patiently in hopes the disease will run its course in a short time.

Selling Honey Direct, Without Soliciting or Peddling.

Some years ago, when I began to produce honey by the ton, I relinquished the home market, leaving it to small producers, although I have still a considerable local demand. I have not offered a pound of honey to any one in this town of 8000 inhabitants for over 10 years, and I have never since been able to meet the demand without purchasing from others. How have I found my customers? you may ask. This is how:

I took up "Bradstreet's Report," and turned to Manitoba and the Canadian Northwest. In every city, town, and village I selected and listed the names of grocers, druggists, and fruit-dealers, taking great care to enter the names of none but those who were rated "good." To each of these I mailed a price-list (one of which I inclose, which you will notice is dated seven years ago, and is the last I needed to send out.) From that day to the present I have not had to seek a customer.—R. McKNIGHT, in Gleanings.

Poultry and Bees.

I see in an article by Mr. Ashley that he combines poultry with bees. That is just what I have been doing. In fact, I think that, without the poultry, I should give up bees. That large nursery I have told you about, with it I hatch chickens in the winter and queens in the summer; so you see it is no dead property. The chickens (or chicks, rather), when taken from the incubator, are transferred to a brooder-house 20x60, which is heated by hot-water pipes under the brooder, where the little chicks go to get warm. The temperature is kept at from 95° to 100°; and, in fact, these chicks do not get outside of the building until ready for market, which is when they weigh about 1½ to 2 pounds each, when they are shipped to Chicago, where they command a ready sale until the middle of June, when they are shipped east instead of west.—H. G. QUIRIN, in Gleanings.

Just Call It "Honey."

Many people have been led to put up their honey in bottles marked "Extracted." Now, if such would only inquire among their city friends they would find out that "strained" is what people want. The "extracted" suggests machinery. When I bought my "Cowan" I found a strainer attached to the machine. What was it for, Mr. Editor? On a close inquiry you will find that lots of people "like the good old strained honey." My advice is to put neither "strained" nor "extracted" on your packages. Sell it for honey.—W. K. MORRISON, in Gleanings.

OLDEST BEE PAPER IN AMERICA

THE AMERICAN BEE JOURNAL

ESTABLISHED IN 1861

PUBLISHED WEEKLY BY
GEORGE W. YORK & COMPANY,

118 Michigan St., CHICAGO, ILL.

REGULAR CONTRIBUTORS:

G. M. Doolittle, of New York. Prof. A. J. Cook, of California.
Dr. C. C. Miller, of Illinois. Dr. J. P. H. Brown, of Georgia.
J. H. Martin, of California. Rev. E. T. Abbott, of Missouri.
Barnett Taylor, of Minnesota. Mrs. L. C. Axtell, of Illinois.
Chas. Dadant & Son, of Illinois.

\$1.00 a Year—Sample Copy Sent Free.

[Entered at the Post-Office at Chicago as Second-Class Mail-Matter.]

Vol. XXXVI. CHICAGO, ILL., MAY 14, 1896. No. 20.



Number of Seeds to the Pound.—In the American Agriculturist we find the following honey-plants among a lot of others: Alfalfa, 225,000; melilotus alba (sweet clover), 248,000; esparcet, 24,000; Alsike clover, 723,000; crimson clover, 133,000; white clover, 750,000. These figures represent the average number of seeds to the pound of those named.

Honey for Erysipelas.—The American Homeop-
athist contains this paragraph about the use of honey in treat-
ing erysipelas:

Dr. Hayward, of Cropsey, Ill., calls attention to honey as a remedy for erysipelas. It is used locally by spreading on a suitable cloth and applying to the parts. The application is renewed every three or four hours. In all cases in which the remedy has been employed, entire relief from the pain followed immediately, and convalescence was brought about in three or four days.

This certainly is "important, if true." We wish that Mrs. Thomas G. Newman, who has been a great sufferer from erysipelas, would try the honey remedy and report results.

A Campaign of Honey-Education should be begun at once by bee-keepers everywhere, before the new crop of honey comes on the market. It will pay, and pay well, to push the work of enlightening the public upon the value of honey as an every-day food. There are actually many people who think that honey is a real luxury, and only to be afforded by bankers and millionaires, or those who live in palaces and wear silk and broadcloth for common; when the fact is, honey is the poor man's and the laboring man's food—or ought to be.

For over 25 years of our life, we presume we did not eat five pounds of honey, all told; now we feel that not a single meal of the day is complete without honey as a part of it. And why didn't we eat more honey in those 25 years? Simply because the folks that run the table where we boarded were not acquainted with the real worth of honey as an article of food. They thought it was mainly to be used as a medicine, in small doses!

Three years ago, when we first met Dr. Peiro, he told us

that he could not eat honey—it made him sick. He showed us a sample of the kind of extracted honey he had been trying to eat! No wonder it gave him pain in the region of the belt, for it was simply some of the infernally adulterated stuff that so many grocers palm off on an unsuspecting public as "honey!" We gave the Doctor a sample of our honey to take home with him, and from that day to this he can eat his share of honey, and enjoy it—not as some folks "enjoy poor health"—but really and truly eat it with a relish and pleasant after sensations.

What bee-keepers need to do, in our estimation, is to make a big effort to see that everybody has a chance to eat pure honey. Talk it up. Write it up for your local newspapers. Give the editors of such papers liberal samples of honey. After being thus "sweetened," they'll help much in the campaign of honey-education.

There are at least two men here in Chicago who are doing their share to see that grocers (and thus their customers, the people) are supplied with pure honey. Mr. Grabbe is one, and Mr. Walker the other. The former has a store here the whole year round, and the latter spends the winter months here; in fact, Mr. Walker is here yet, having come from Michigan last November. He has disposed of upwards of 50,000 pounds of mostly extracted honey in neatly-labeled tin pails. He thinks that another year he will be able to place 100,000 pounds.

How do they do it? Simply by personal work. They come here and work. They guarantee the purity of their honey; solicit grocery orders themselves; talk them into buying once, and then it is pretty much a "perpetual motion" business. Even a Chicago grocer "knows a good thing when he sees it" a few times.

Some think that Chicago is the greatest honey market in the world. Probably it is. But it will be greater. The seed sown by Messrs. Grabbe and Walker is bound to result in great good, both to the producer and the consumer of honey. They are men who stand back of their goods every time, thus insuring satisfaction, and building up a trade that is bound to be more profitable to them as the years go on.

Now, why not every city, town and hamlet be thus worked? No reason at all. There are plenty of bee-keepers wide-awake enough to "go up and possess the land"—the cities and towns, and push the honey-business, if they only thought so. It will pay to try, and try hard. What others have done, you can do. Go forth to win on this theme—Honey for the masses!

No, sir! It is not over-production. It is under consumption—the kind of "consumption" that sorely needs a radical cure, and no encouragement.

"Samantha at the World's Fair."—We want to make our present readers one of the best offers ever made. All know the excellent books written by "Samantha, Josiah Allen's Wife." Well, "Samantha at the World's Fair" is probably her best, and we are enabled to offer this book and a year's subscription to the New York "Voice" (the greatest \$1.00 weekly temperance paper published to-day), for sending us only three new subscribers to the American Bee Journal (with \$3.00), provided you are not now a subscriber to the "Voice." Think of it—a grand book and a grand weekly temperance newspaper given simply for sending us three new subscribers to the Bee Journal for a year! The Samantha book is exactly the same as the \$2.50 one, only the binding is of heavy manilla instead of cloth. It is a special 100,000-copy edition, and when they are all gone, the offer will be withdrawn by the publishers. Of course, no premium will also be given to the new subscribers—simply the American Bee Journal for one year.

We trust our readers will now go to work, get the three

new Bee Journal subscribers, send them to us with the \$3.00, and we will order the "Voice" and the book mailed to you. This is the biggest and best offer we ever were able to make. We do hope you will take hold of it, and thus help increase the circulation of the Bee Journal, and also get for yourselves some excellent reading-matter besides. Who will be the first to send us the required three new subscribers?

Exporting Honey.—Under "Subsidiary Farm Products," in a recent Report of the United States Department of Agriculture, we find the following:

HONEY.—The English honey market is supplied by the home product, from the United States, and from Chile. There is a large and steady demand, and, though sometimes exceeded by the supply, this is an unusual occurrence. The English honey harvest has been very good this year, and it is selling upon the retailer's counter at from 20 cents to 25 cents per pound. Wholesale prices at the latest date obtainable are as follows:

English—Earthenware pots, finest, per doz	\$1 45
Earthenware pots, finest, $\frac{1}{2}$ -pound, per doz	90
Flint glass jars, 17-ounce, per doz	1 70
Transparent honey, in glass jars, nickel-plated, screw top, per doz	1 57
United States—Thurber-Whyland's white sage, extracted, 1-pound jars, 2 dozen in a case, per doz	2 30
Californian, in original cans, about 56 pounds per cwt. of 112 pounds	9 60
Chilean, in original cwt. kegs, per cwt	8 75

The American white sage commands the top price. It is a delicious honey, and most attractively put up. All honeys sent to England are extracted except a nominal quantity that reaches there in the comb from California. California shipments of extracted honey are made in 56-pound tins, two tins in a case. Chilean usually comes in 60-pound kegs, but sometimes in 112-pound barrels. It is not a matter of great importance as to size of packages, etc., though it would be well to conform to the California practice. It would be ruinous to send adulterated honey to England.

Our agent in England has had several inquiries as to honey market this year, especially from Texas, and he has supplied inquirers with names of importers in England, and with information as to how to approach them, and this he will be pleased to do for all inquirers.

The Department has knowledge that some years ago a large honey-producer in California found in China a profitable market for some 20 tons of honey annually.

In this, as in every other branch of industry, only the best, most genuine products can secure a permanent, profitable trade, creditable alike to themselves and their country, and they alone deserve to.

Beginners and Bee-Literature.—Every bee-keeper—and especially every beginner—ought to have one or more of the standard works on bee-culture. If thoroughly read and studied, it would avoid the asking of many a simple question; particularly if read in connection with a colony of bees. For instance, some one asked to have answered in a bee-paper, whether a queen lays eggs in empty cells, or in those full of honey! Think of taking up space in a paper to reply to such a question, when the querist could easily have found the answer to this question by reading even the smallest book devoted to bee-keeping.

Now, the very best book on the subject costs only \$1.25, and the best bee-paper published costs only \$1.00 a year. Both the book and the paper are necessary in order to get started rightly, and then to keep going straight. And both can be had together for only \$2.00. We believe that the beginner who can't afford to invest \$2.00 in bee-literature when he starts, can't afford to fool with bees, any way, and would better let them alone altogether.

Perhaps we ought to say that we are glad to have our question departments in the Bee Journal freely patronized, but they are not intended for primary questions that are fully answered in the bee-books. The fact is, the simple, primary questions have been answered so many, many times during the past 10 or 15 years, that the older readers of the bee-

papers are heartily tired of them. And it is not fair to any subscriber to repeat over and over again what has been published, or what can so easily be found in the books.

Let every one who aspires to being a bee-keeper, have at least *one* complete book on bees in his library. *And then study it!*

PERSONAL MENTION.

Mr. H. P. JOSLIN, of Ben Avon, Pa.—a suburb of Pittsburg—made us a very pleasant call May 6. Mr. J. is somewhat of a beginner in the bee-business, and is very enthusiastic about it. He will make a success of it. Such men do.

Mr. C. B. BIGLOW, of Springfield, Mass., besides having been a subscriber to the American Bee Journal in 1861, when first started, also claims to have "introduced the first Italian queen-bee into southern Vermont, in the fall of 1860, from the Parson stock, of Flushing, L. I." He still takes an interest in the honey-bees, and says he has not forgotten what he learned about them years ago.

Mr. J. L. TERRELL, of Macon Co., Mo., called at the Bee Journal office last week. Mr. T. can report that with the exception of one year since keeping bees, he has made them pay an average profit of \$5.00 per colony. He has 45 colonies this spring, and says the prospects were never so encouraging in his locality as they are now. Mr. Terrell is an extensive young farmer, and also handles bee-supplies. He sold as high as 27 nailed hives in one day, by taking a sample and driving around to see the bee-keepers, and explaining the workings of the hive. There is nothing like personal work, no matter what the business.

Mr. W. K. MORRISON, in Gleanings, proposes that a national bee and honey show be held in Washington, D. C. next September. That's altogether too far east. A North American convention was held there some years ago, and only about twenty-five bee-keepers attended. If it weren't for our modesty, we'd suggest that the proper place for holding such a show is in Chicago, where carloads upon carloads of honey are shipped annually, and surrounding which city there are thousands of bee-keepers. Besides, everybody wants to come to Chicago, while mostly politicians and office-seekers care to go to Washington! Poor old Washington! What a tough time she must have! Better come to Chicago with that show. It can be a great success here.

CONVENTION PROCEEDINGS

Report of the Utah Convention.

BY "REPORTER."

The Utah State Bee-Keepers' Association held their regular semi-annual meeting here on April 6, with President Lovesy in the chair. The meeting was replete with interest to the bee-keepers. After receiving the reports and reception of members the election of officers was proceeded with, and the following were elected for the ensuing year:

President, E. S. Lovesy, of Salt Lake City; Vice-President-at-large, Geo. Howe, of Benjamin; Secretary and Treasurer, Geo. E. Dudley, of Provo; Assistant Secretary, J. B. Fagg, of East Mill Creek.

The following County Vice-Presidents were also elected: Weber Co., R. T. Rhees, of View; Cache Co., Henry Bullock, of Providence; Davis Co., T. B. Clark, of Farmington; Tooele Co., Geo. Craner, of Tooele; Salt Lake Co., H. W. Dudley, of Mill Creek, and Wm. Philips, of Salt Lake City; Utah Co., O. B. Huntington, of Springville, and Wm. Peay, of Provo; Wasatch Co., J. A. Smith, of Heber City; Ranab Co., J. L.

Bnnting, of Ranab; Morgan Co., T. R. G. Welch, of Morgan City; Washington Co., Mrs. Woodhry, of St. George; Jnab Co., Thos. Bilston, of Nephi.

The Executive Committee is as follows: Messrs. J. A. Smith, J. B. Fagg, and Geo. E. Dudley.

Committee on foul brood law, Messrs. J. B. Fagg, Geo. E. Dudley, Henry Bullock, T. B. Clark and E. S. Lovesy.

The President's Address.

Friends and Bee-Keepers:—We greet you once more. Another year has rolled into space. Time, like an ever-running stream, glides along, carrying us the same as so many bubbles on the surface until we reach the waterfall, or that bright shore we have heard of, but of which we know so little. Life at the best is but a brief span, then should we not improve each shining moment as it flies onward? And, above all, should we not cultivate a kind, generous, fraternal feeling towards each other?

It is a known fact to some, and it has been observed by many, that the bee-keeping pursuit is productive of a kind, soothing feeling of peace and good-will, then why not adopt those promptings, and unite for the general good? If we would do this, we must more thoroughly organize for our own interest and self-preservation, not with a view to oppress, but to try to avoid being oppressed or crushed. When we note the powerful organizations that we have to contend with, does it not more than ever behoove us to organize for our own protection?

There was a time in the history of Utah when our bee-keepers could get good prices for all that they could produce. This was when we lived within ourselves, and traded with our neighbors. But now all this is changed; the consumers of our products are more remote, and while, as a rule, the consumer pays a fair price for what he receives, it often happens that the producer does not receive a fair figure. Instances have come to my notice of late, showing that the consumers have paid three times the price received by the producer, and yet some of those blood-sucking leeches that live between the producer and the consumer, are not satisfied, for we have positive evidence that some of them have purchased pure honey at low rates, then mixed glucose with it, and then sold the stuff at a high price. They thus prevent the producers from selling their products at a living price, and as they must have all the profit, they prevent thousands of poor people from using honey.

How long will our people be fooled in this way? If they buy either honey or glucose, why should they pay those people such an enormous royalty for mixing it for them? Now, if these statements are true, would not the bee-keepers be willing to sustain our Bee-Keepers' Union if it would analyze some of this suspected honey, and thus try to protect the bee-keepers and the public?

It should be plain to all that not only should we still agitate the subject of cheaper transportation, but we should, if possible, do something to prevent the demoralization of our markets. Is it not self-evident that this glucose fraud is one reason for this depressed condition of the honey market? We do not wish it understood that we condemn all our honey-dealers, because we know of many honest, honorable people in the honey-business, but could not our reliable dealers and some of our principal bee-keepers unite on, or adopt, some plan that will make it hot for those glucose frauds? It can be readily seen that if any person buys just enough honey to season glucose, a barrel of honey will go a long way. Now, could we not try to reach the consumer direct, or try to induce them to purchase only from reliable dealers? If we can do this, and then adopt the simplest and easiest method to produce our products and put it up in the most attractive form, then if properly organized we believe success will be obtainable.

It is also evident that our national depression is partially the cause of the existing state of affairs. We might ask, What is the cause of this depression? Is it not observable to the thinking mind that those great trusts and combinations between those two great communities—the producers and the consumers—is one of the causes? If this be true, should not all classes of agriculture make a united effort for their own interest and self-preservation?

OUR FOUL BROOD LAW.

As we were not able to get an amended law to the entire satisfaction of our bee-keepers, we preferred to have nothing rather than another inoperative make-shift. Quite an interest has been stirred up by agitating the matter, and the chances are favorable for something better in the near future. A campaign of education in this matter would be a good thing. Every bee-keeper should know what foul brood is,

and the best method of treatment, and they should also study the many uses and benefits of foundation.

THE LANGSTROTH MONUMENT.

As the bee-keepers of the United States are contemplating the erection of a monument to the memory of that greatest of all bee-keepers—the Rev. L. L. Langstroth—I sincerely hope the bee-keepers of Utah will take an interest in this matter, and send in their contributions to this laudable cause. Let us hope that such a thing as failure may not be known, but that success may be the speedy result of our efforts.

E. S. LOVESY.

Mr. Fagg offered a resolution which was adopted, asking our representative to Congress to try and procure 500 copies of Mr. Benton's book on bee-culture, lately published by the Department of Agriculture. This would give a copy to about one in 20 of our bee-keepers in Utah.

The Langstroth Monument Fund was considered by the convention, many members favoring it. A resolution was passed, asking all the bee-keepers of the State to contribute to the fund, the money to be sent to Pres. E. S. Lovesy, who will forward it to the proper authorities.

Mr. J. A. Smith, of Wasatch county, gave an interesting description of his bee-house, the size of which is 10x16 feet, with 14 inch walls, packed with 12 inches of sawdust; floor 8 inches, and ceiling 12 inches of sawdust, with one 10-inch chimney. The house was dark the entire winter, with a loss of only 2 colonies out of 108. He made a fire in the house three times during the winter. He put the bees into the cellar in November, and took them out March 22. He uses the Langstroth hive, mostly the 8-frame. The altitude where Mr. S. lives is nearly 3,000 feet higher than Salt Lake City.

Mr. Schach, of Cottonwood, asked for information in regard to bees dwindling and dying out in certain localities, said to be caused by the smoke from the smelters. He said that himself and others had suffered serious loss, and this was supposed to be the cause.

Mr. Cornwell said that his bees always put up immense quantities of honey in the summer, but they nearly all died every winter, and the smelter smoke was said to be the trouble. This smelter smoke question was discussed thoroughly, and Prof. A. A. Mills, of the Agricultural College, suggested that the only method of determining the matter would be to analyze the bee or the blossoms.

The various sizes and kinds of hives were discussed at length, by many members, without any particular result other than it depended somewhat upon the locality and the size of the honey-flow.

The production of honey and the winter question received considerable attention. Interesting remarks were made, the burden of proof showing that to succeed in wintering the bees must be kept dry. Mr. E. S. Lovesy gave his method of wintering with hay packed on top of the hives.

Mr. Geo. Hone wintered his bees with a loss of only 2 per cent. on the summer stands; he produced over 13,000 pounds of comb honey last year, besides extracted honey. He said one of the secrets of successful wintering is plenty of bees, a good queen, and plenty of honey in the hive. He uses full sheets of foundation in the sections and in the brood-chamber.

Mr. J. B. Fagg gave an interesting address on the production and marketing of honey. The foul brood question was discussed at length, some of the members wanting all laws in regard to the matter repealed, but all agreed that we should have a good law passed that can be made operative, or they would prefer nothing.

Mr. E. S. Lovesy, Foul Brood Inspector for Salt Lake county, said the present law requiring the inspector to visit every colony of bees once a year was a waste of time. He said there had been many cases where foul brood had developed among the bees a few days after the inspector had made his rounds, and thus in some cases the bees have not been treated for the disease. The better way would be for all bee-keepers to carefully watch their bees, and if they find foul brood, or anything they do not understand, they should notify the inspector at once. He said that he was willing to visit any bee-keeper in the county, at any time, if they would notify him. As delay often proves fatal, the bees should be treated at once.

The convention adjourned, subject to the call of the President.



Every Present Subscriber of the Bee Journal should be an agent for it, and get all others possible to subscribe for it.

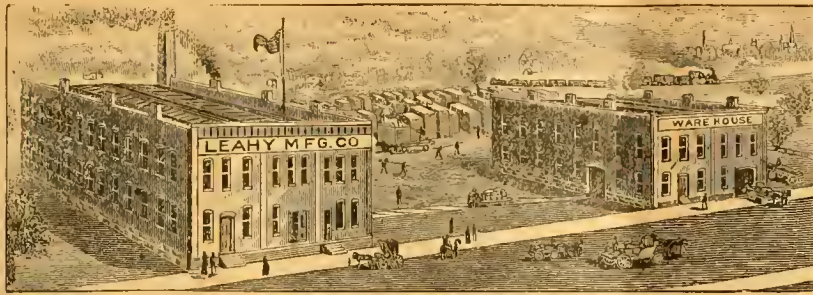

Largest Factory in the West

COMPLETE STOCK.
Good Supplies and Low Prices
—Our Motto.—

READ THIS—Mr. Keyes says: The 100 pounds of Extra-Thin Foundation you sent us is superior to anything he ever saw; and I think the same. R. L. TUCKER, Wewahitchka, Fla.

Dear Sirs:—The Sections came duly to hand. Indeed, they are very nice. Yes, sir; they are as good as the best. CHARLES H. THIES, Steelville, Illinois.

Leahy Mfg. Co.:—I have received the bill of goods. I must say they are the choicest lot of Hive-Stuff I have ever received from any place. I admire the smoothness of your work, and your close selection of lumber. Yours very truly, O. K. OLMSTEAD, Orleans, Nebr.

Dear Sirs:—The Sections arrived in due time, and are all O. K. so far as examined. They are simply perfectun. I can't see how you can furnish such goods at such low prices. I hope you may live long and do well. Yours respectfully, Z. S. WEAVER, Courtney, Tex.

Gents:—I received the "Higginsville Smoker" all O. K. It's a dandy; please find enclosed stamps for another. Yours truly, OTTO ENDERS, Oswegathe, N. Y.

Gentlemen:—I have bought Supplies from nearly all the large manufacturers by the carload, and I must say yours are as good as the best. Indeed, in many lines they are the best. It is a pleasure to handle them. E. T. FLANAGAN, Belleville, Illinois.

The above unsolicited testimonials are a fair sample of hundreds we receive. Our prices are reasonable and the "Higginsville Goods" are the best.

The "Higginsville" Goods are for sale by the following parties:
Chas. H. Thies, Steelville, Ill.
Henry L. Miller, Topeka, Kans.
J. W. Rouse & Co., Mexico, Mo.
Fulton & Gregg, Garden City, Kans.
E. T. Flanagan, Belleville, Ill.
E. A. Seeley, Bloomer, Arkansas.
P. J. Thomas, Fredonia, Kans.
W. J. Finch, Jr., Springfield, Ill.

If you need a Carload of Supplies, or only a Bee-Smoker, write to us. Remember, we are here to serve you, and will, if you give us a chance. **A Beautiful Catalogue Free.**

Address, **LEAHY MANUFACTURING CO., HIGGINSVILLE, MO.**
49A *Mention the American Bee Journal.*

CHEAPER THAN EVER

Hilton's White T Supers
Chaff Polished Sections Foundation
Hives Sections Smokers

And everything needed in the apiary.

1896 Catalog of 36 pages free.

GEO. E. HILTON,

13Atf PREMONT, MICH.

Mention the American Bee Journal.

Dadant's Foundation in Chicago!

No other Goods kept here.

Send for Price-List,

CHAS. DADANT & SON,

118 Michigan St., CHICAGO, ILL.

13Atf Please mention the Bee Journal.

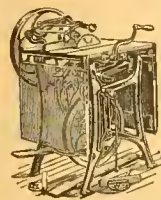

ONE MAN WITH THE UNION COMBINATION SAW

Can do the work of four men using hand tools, in Rippling, Cutting-off, Mitring, Rabbeting, Grooving, Gaining, Dadoing, Edging-up, Jointing Stuff, etc. Full Line of Foot and Hand Power Machinery Sold on Trial. Catalogue Free.

SENECA FALLS MFG. CO.,

46 Water St., SENECA FALLS, N. Y.
1A1y *Mention the American Bee Journal.*

BEES, QUEENS, and Several Carloads of APIARIAN SUPPLIES

always on hand.

Brood Found., 42c lb.; Section, 50c lb.

I. J. STRINGHAM,

105 Park Place. NEW YORK, N. Y.

General Items.

Working in the Sections.

Bees are doing finely. They have been working in the sections for 10 days.

J. H. HAIGHT.

Fruitdale, Ala., April 24.

Almost a Total Failure in 1895.

My 75 colonies of bees have wintered with a loss of about 10 per cent., and are now in fairly good condition. Last year was almost a total failure with me. I secured about 400 pounds of honey, about 16 pounds of beeswax, and increased from 73 to 75 colonies.

G. F. TUBBS.

Derrick City, Pa., April 24.

Time of Blossoming.

I have written down the dates of plants that bees work on when they are in bloom. They are in north Georgia and East Tennessee, and are as follows, for 1895: Alder, March 15; maple, March 20; willow and peach, April 1; redbud, sugar-tree, and beech, April 8; apple-tree, April 15; huckleberry, April 18; white clover, May 2; poplar, May 4 to 30; black gum, May 4; persimmon, June 1; basswood, June 15 to 30; corn, July 1; sourwood, June 24 to July 30.

B. A. ARMOR.

Doogan, Ga.

Beautiful Weather for Bees.

We have beautiful weather now, and bees are making good use of it. I began the winter with 77 colonies on the summer stands, all packed on top with chaff cushions, and 76 came through. I have lost one since, by robbing, and one is queenless, some are a little weak, but all are working nicely. The prospect now is for a heavy fruit-bloom. I hope the nice weather will continue, so that bees can use the bloom for all it is worth. Mine are about entirely caring for themselves now. I am so afflicted with rheumatism that I cannot attend to them.

A. H. SNOWBERGER.

Huntington, Ind., April 18.

An Oregon Report.

I cannot well do without the American Bee Journal, even if I have passed my 75th milestone.

I keep a few colonies to amuse myself with, and have them in a house, which, to my mind, is so much better than out-of-doors. One year ago I had six colonies of Italians; I divided them at the proper time, and had 12 to winter. A few weeks ago I noticed one colony was not flying. I examined them, and found nearly all had starved to death. I thought I had examined all in February to see if they had stores enough. About the middle of February they were rustling for pollen. Lately we have had a protracted spell of cold rain, and some snow, which is a very uncommon thing at this time of year, although some springs we have rain so as to cheat our bees out of much of the nectar from fruit-blossoms.

My hives are of the 8-frame size, and all have a pane of glass in one side and end, and the supers have a 2-inch strip

That Queen-Clipping Device Free!

Works Like a Charm.

The Monette Queen-Clipping Device WORKS LIKE A CHARM. With it I have clipped 30 queens, all in one day, when examining my bees. WM. STOLLEY, Grand Island, Nebr.

Couldn't Do Without It.

I have clipped 19 queens, and must say the Monette Queen-Clipping Device is by far the best invention ever made, and will be welcome to many bee-keepers as it was to me. I could not do without one now.

DR. GEO. LACKE, Newburgh, Ind.

PLEASE READ THE FOLLOWING OFFER:

Send us just one new name for the American Bee Journal a year (with \$1.00), and we will mail you the Queen-Clipping Device FREE of charge. Or, the Queen-Clipping Device will be sent postpaid for 50 cts. But why not get it as a Premium by the above offer? You can't earn 50 cts. any easier. Almost every bee-keeper will want this Device. See page 130 (Feb. 27) for full description of it. Complete directions accompany each one sent out. It is a most ingenious and useful article. Address,

GEORGE W. YORK & CO., 118 Michigan St., Chicago, Ill.

BUY "DIRECT FROM FACTORY," BEST MIXED PAINTS

At Wholesale Prices, Delivered FREE For Houses, Barns, Roofs, all colors, and SAVY Dealers profits. In use 54 years. Endorsed by Grange & Farmers' Alliance. Low prices will surprise you. Write for Samples. O. W. INGERSOLL, 289 Plymouth St., Brooklyn, N. Y.

12A13 Mention the American Bee Journal

MURDERED

We have killed high prices. Give me a trial order and be convinced that good Queens can be reared for 50 cts. each. Untested, 50 cts.; Tested, 75 cts. Golden Italians, 3-Banded Italians, and Silver-Gray Carniolans, all the same price. Best of References given.

C. B. BANKSTON,

13Atf CHRISMAN, Burleson Co., TEX.

Mention the American Bee Journal

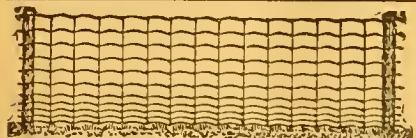

Great Freshet in N. Y. State.

When the papers reported "N. Y. Central tracks under water, miles of fences swept away," we sent two trusty men to look after the 170 miles of Page on that line. Report was true, but the Page didn't "sweep" and an order is just in for 30 miles more. See April Hustler.

PAGE WOVEN WIRE FENCE CO., Adrian, Mich.

WHEN ANSWERING THIS ADVERTISEMENT, MENTION THIS JOURNAL.

A New Method

of refining wax without acid.

Result Better

Comb Foundation.

My prices are also the lowest.

A Job-Lot of No. 2

Polished Sections

Equal in finish to any No. 1's. 1 M, \$1.75; 2 M \$3.40; 3 M, \$4.80; 5 M, \$7.50. Or I can furnish a cheaper quality. Also, a full line of

HIGGINSVILLE SUPPLIES.

See my List with prices.

W. J. FINCH, Jr., SPRINGFIELD ILLS.

Mention the American Bee Journal

IF YOU WANT THE

BEE-BOOK

That covers the whole Apicultural Field more completely than any other published, send \$1.25 to Prof. A. J. Cook, Claremont, Calif., for his

Bee-Keeper's Guide.

Liberal Discounts to the Trade.

California

If you care to know of its Fruits, Flowers Climate or Resources, send for a Sample Copy of California's Favorite Paper—

The Pacific Rural Press

The leading Horticultural and Agricultural paper of the Pacific Coast. Published weekly, handsomely illustrated, \$2.00 per annum. Sample Copy Free.

PACIFIC RURAL PRESS,

220 Market St., SAN FRANCISCO, CAL.

TEXAS QUEENS.

If you are in need of Queens, let me have your order. Price-List Free.

8A26t **J. D. GIVENS,** Lisbon, Tex.

Mention the American Bee Journal

of glass on each side. All have dark curtains. I like to see into their domestic relations without having to disturb them, and then it is a pleasure to show visitors what they are doing.

Last season some of the colonies had too many drones early in the season, and when I found them flying strong I put a drone-trap at the entrance, and would catch from 1/4 to 3/4 or more full, and drown them.

Where I live is not a good locality for bees to store much surplus honey from what they can get from white clover and other sources. Last season I had some buckwheat sowed for them, but they did not seem to work much upon it. I have had some sweet clover sowed this spring, and shall sow some Alsike clover next month, with buckwheat.

I have fed some of my bees this spring to stimulate them to brood-rearing.

N. A. W. HOWE.

Creswell, Oreg., April 15.

Poor Season in 1895.

I began to keep bees in 1895 with two colonies, and increased to four, and got only 60 pounds of comb honey. We had a poor season for honey, for we depeud mostly upon golden-rod here, and we had a week of rainy weather, so the bees could not work. I use the 8-frame hive. I like bees, and like to take care of them.

MRS. FRANK BERKEY.

Amiret, Minn.

Wintering—Selling Honey—Hives.

I finished putting my bees on the summer stands yesterday. Some were put out last week. They were wintered in the cellar under the house, which is in two parts, one I use for vegetables where the temperature is too cool for bees to do well; the other, which is much the warmest, I use for the bees. It also is the coolest when the warm days of spring come, which tend to make the bees restless and uneasy. I have wintered bees in this cellar now nearly ten years, and usually they come through in good condition. I am fully satisfied that the quality of the honey which the bees have to eat has much to do with their health. Give bees a healthy diet, and a healthy place to live, and they will do well.

I placed 76 colonies in the cellar about Nov. 15, and they have been in over five months without any interruption; 70 of them came out in apparently good condition. They seem to be in good condition with lots of bees, and they can go to work immediately, as there are in bloom soft maple, elm, poplar and moosewood, and some other small flowers.

I have almost always made a specialty of producing extracted honey, as the crop is more certain, it handles better, and is less trouble, except the selling, which is usually slower with me. At the present time I have nearly 1,000 pounds on hand, which is the most I ever had at this season of the year. The bulk of my crop is basswood and clover honey, which is very fine and light colored. Dark honey I seldom get any of. I have always succeeded in selling the best directly to the consumer. To send to city commission men generally has not paid very well. There is so much prejudice and distrust for extracted honey. If bee-keepers wish to have the

ORIGINAL BINGHAM SMOKERS

Wonderful Record!

HAVE LASTED 17 YEARS.

—BEST ON EARTH.

Always Give Perfect Satisfaction.

My cool Wire Handle and Bent Nose were patented 1892, are the original, my best invention since my open or direct draft Patent, 1878, that revolutionized Bee-Smokers. My Handle and Nose Patent bent all the other smoker noses. None but Bingham Smokers have all the best improvements. If you buy genuine Bingham Smokers and Honey-Knives you will never regret it. The "Doctor," 1/4-inch larger than any other smoker on the market—3 1/2-inch stove, by mail, \$1.50

Conqueror, 3 "	"	1.10
Large, 2 1/2-in. "	"	1.00
Plato, 2-in. "	"	.70
Little Wonder, 2-in., wt. 10 oz.	"	.60

Bingham & Hetherington Honey-Knives, 80 cents.

T. F. BINGHAM, Farwell, Mich.

7Atf Mention the Bee Journal.

PATENT WIRED COMB FOUNDATION

Has No Sag in Brood-Frames

Thin Flat-Bottom Foundation

Has No Fishbone in the Surplus Honey.

Being the cleanest is usually worked the quickest of any Foundation made

J. VAN DEUSEN & SONS,
Sole Manufacturers,
Sprout Brook Montgomery Co., N. Y.

BEGINNERS.

Beginners should have a copy of the Amateur Bee-Keeper, a 70-page book by Prof. J. W. Rouse. Price 25 cents; if sent by mail, 28c. The little book and the Progressive Bee-Keeper (a live, progressive 28-page monthly journal) one year, 65c. Address any first-class dealer, or

LEAHY MFG. CO., Higginsville, Mo.

SPRAYING

Will Produce **PERFECT FRUIT**

We tell you all about spraying and care of fruit in our 32-pg. illustrated book—free. Our Pumps and Nozzles win highest honors in every test.

The Deming Co., Salem, O.
W. Arts, Hemion & Rubbell, Chicago

The Patent Wood-Veneer Foundation.

Bee-keepers should give it a test, and my All-Wax Foundation. I will guarantee there is no better made, as six years ago I discarded the old way of dipping for wax sheets, and a new invention of my own was discovered, which enables me to make the toughest kind of Foundation; also, no acid used to purify the Beeswax, and it preserves the smell of honey, which is more acceptable to the bees. Now is the time to send wax and have it worked up at low prices. Send for Samples and Catalog with low prices. Wax wanted at 31c cash, or 33c trade, delivered.

AUG. WEISS, Hortonville, Wis.
12A13t Please mention the Bee Journal.

Canada I make a full line of **Up-to-date Bee-Supplies**

at rock-bottom prices. Send for my annual Circular. A 12-inch Root Fdu. Mill in good order, 2nd hand, at a bargain for either Wax or Cash. Address,

W. A. CHRYSLER, Chatham, Ont.
19Atf Mention the American Bee Journal.

YOUNG QUEENS BY RETURN MAIL

From the South. Bred from our *hardy strain* of GRAY CARNIOLANS and GOLDEN ITALIANS. Untested Queen, 75 cts.; Tested, \$1.50. If you want a Fine Imported or a Select Tested Breeding-Queen, or BEES by THE POUND, Nuclei and Full Colonies, we can furnish you at *bottom prices*. We never saw Foul Brood or Bee-Paralysis. *Satisfaction guaranteed.* PRICE-LIST FREE.

F. A. LOCKHART & CO., Lake George, N. Y.

Please mention the American Bee Journal.

16Etf

Abbott's Space.

The "St. Joe" stands at the TOP. Dovetailed Hives VERY CHEAP. Dadant's New Process Foundation at Dadant's prices, WHOLESALE and RETAIL.

Sections as low as the lowest for good goods. Send for Circular and say what you want. Special Agent for G. B. Lewis Co.'s goods. Write for prices. E. T. Abbott, St. Joseph, Mo.

SECTIONS CHEAP!

In order to reduce stock we will sell

40,000 4 1/4 x 4 1/4 x 2 250,000 4 1/4 x 4 1/4 x 1 1/2
150,000 4 1/4 x 4 1/4 x 1 1/4 80,000 4 1/4 x 4 1/4 x 7-to-ft,

Of our No. 2. One-Piece, Open-Top Sections, at the following **Low Prices:**
1,000 for \$1.00; 3,000 for \$2.50; 5,000 for \$3.75.

These Sections are all of good quality and manufacture, and prices will be maintained for a short time only.

G. B. LEWIS CO., WATERTOWN, WIS.

Be sure to mention the American Bee Journal when you write.

Sweet Clover ¹/_N Canada.

At the following prices:

5 lbs. 10 lbs. 25 lbs. 50 lbs.
\$1.00 \$1.60 \$3.75 \$7.25.

Also a quantity of Motherwort and Catnip seed. Prices on application.

EGGS for Hatching. Buff Leghorns, Indian Games, & Light Brahmans. Choice Birds. A breeder for 30 years. Prices on application

JOHN McARTHUR,

881 Yonge Street, TORONTO, ONT.
15 Atf *Mention the American Bee Journal.*

J. W. TAYLOR

—HAS THE BEST—

Italian Queens for Sale

Untested, ready now, 75c. apiece; 6 for \$4.25, or 12 for \$8.00. Tested, \$1.25. Select Tested, best, \$2.00. Pay for Queens on arrival. I guarantee safe arrival and satisfaction.

14A9t OZAN, ARK.
WHEN ANSWERING THIS ADVERTISEMENT, MENTION THIS JOURNAL.

Honey-Clovers & Buckwheat SEED FOR SALE.

We have made arrangements so that we can furnish seed of several of the Clovers and Japanese Buckwheat, by freight or express, at the following prices, cash with order:

	5lb	10lb	25lb	50lb
Alsike Clover	\$.70	\$1.25	\$3.00	\$ 5.75
Sweet Clover	.75	1.40	3.25	6.00
White Clover	1.25	2.00	4.50	8.00
Alfalfa Clover	.65	1.10	2.70	5.00
Crimson Clover	.55	.90	2.00	3.50
Jap. Buckwheat	.20	.35	.90	1.25

Prices subject to market changes.

Add 25 cents to your order, for cartage, if wanted by freight.
Your orders are solicited.

GEORGE W. YORK & CO.,
CHICAGO, ILLS.

For Sale ITALIAN QUEENS and BEES.

1 Frame Nucleus, with Queen,..... \$1.75
Queens, 50c each; 1/2 doz. \$2.75; 1 doz. 5.00

Safe arrival and satisfaction guaranteed.

References—Young & Hamilton, Bankers, Cissna Park, Ills.; W. Kaufman, Banker, and Lewis Wolf, P. M., Claytonville.

F. J. GUNZEL, Claytonville, Ills.
Mention the American Bee Journal.

For Sale HOME, APIARY, —QUEENS.—

1/2 Block of ground, some fruit, GOOD 6-room dwelling, shop, stable, honey-house and poultry-house (over 3,000 square feet of floor), 100 colonies of bees in chaff hives and fully equipped for comb honey, all in town of 1000 population and good alfalfa range and good water. Price, \$3,000. If unsold June 15th, will unqueen, and offer 2 year clipped queens at 25c.; 1 year, unclipped, at 50c. each. July 15th and after, YOUNG queens at 60c. each—all Italian and safe arrival guaranteed. This is a rare bargain, but I must get my wife to a lower altitude. Book your orders at once if you want these queens.

19Atf R. C. ATKIN, Loveland, Colo.



Promptness Is What Counts!

Honey-Jars, Shipping-Cases, and everything that bee-keepers use. **Root's Goods at Root's Prices,** and the best shipping point in the country.

Dealer in Honey and Beeswax. Catalogue Free.

162 Mass. Ave. WALTER S. POWDER
INDIANAPOLIS, IND.

Mention the American Bee Journal.

Queens for Sale

Italian Queens—after May 15—Untested, 75c. each; 6 for \$4.00; 12 for \$7.20.

Safe arrival and satisfaction guaranteed.

Reference—George W. York & Co. Address,

F. GRABBE,
LIBERTYVILLE, ILL.

32 ml. northwest of Chicago, on C. M. & St. P.

HONEY We have a large amount of Pure No. 1 Alfalfa we will sell cheap.

Wax Wanted.

Boss bee-escape Warranted the best, simplest and quickest Escape on the market. Sent postpaid to any address for 30 cts. It can be returned at our expense if it is not as represented, or we will send the Escape on trial to any bee-keeper wishing to test it in good faith. We are agents for the Ferguson Patent Hive with double-case Super and Wicket-Gate Honey-Board, with the Escape. It is the easiest, quickest hive to handle for the production of comb honey. Address,

E. S. LOVESY & CO.,
355 6th East St., SALT LAKE CITY, UTAH.
Mention the American Bee Journal. 9Atf

prices of extracted honey revive, they should sell it themselves directly to the consumer. My plan is this:

Put it up in suitable packages, properly labeled and guaranteed. Now, each bee-keeper has a good place to store honey, and knows how to properly take care of it, and if he will keep it there till sold, he will confer a favor on himself and the bee-keeping fraternity. *A list of customers should always be kept for future use.* The ones that buy of you once will be apt to buy again, if dealt with fairly, and that should always be the rule.

Another thing, is to so handle your honey as to have a first-class article for your customers. Some nice hand-bills circulated in the right locality at the right time will help some. Advertise all you can afford to. Honey can always be sold by peddling where people have money and a love for honey.

Much has been said and written about bee-hives, large and small. I have been using several sizes for nearly 20 years—8-frame Langstroth or Simplicity pattern, which, I am sure, is too small. The loss in wintering in these is a larger per cent.; 9 or 10 frames are better—a little. I have been using a hive with 8 combs, which bees winter in well. The size of the box is 12 inches wide by 21 long, and 11 deep, which holds enough honey to last a colony all through, and plenty to use in the spring to rear bees with (which saves lots of bother with feeding). I seem to get just as much extracted honey from these hives as any (extracting chambers being added above as necessary).

I think it poor economy to take honey away from the bees that they need, or take away the good honey and leave them the poor stuff. Bees will not do as well on poor food as they will on good, neither will your horse do as well on musty hay and oats as he will on nice, clean hay and oats. I think all God's creatures should be well taken care of, whether horse, cow, hen or bee, or other things, as it is only then that we are repaid.

I am aware that others' needs vary, in different localities. A hive that is suitable for me or the Dadant's, would not be suitable for the South or California. Each one should study the needs of his own locality, and be guided accordingly.

A. C. SANFORD.

Ono, Wis., April 23.

White Clover Looks Promising.

There are not many bees in this part—from 1 to 20 colonies. They are doing finely at present on fruit-bloom. White clover looks promising now.

M. V. TOOMBS, JR.

New Hampton, Mo., April 27.

Putting Bees Out Early.

My bees—16 colonies—were put into the cellar late in November, 1895. They were taken out Feb. 27, and then left out. The day was an ideal one for bees to fly. There was no wind, and the shade temperature out-doors, when I began to carry out the bees, was 52°. It soon rose to 60°, and stood there for several hours in the afternoon. All the colonies were alive; but one, being light in honey, starved before it was again warm enough to feed them. Another was queenless, and was broken up. The

The Bee-Keepers' Guide:

Or Manual of the Apiary,

By Prof. A. J. Cook.

This 15th and latest edition of Prof. Cook's magnificent book of 460 pages, in neat and substantial cloth binding, we propose to give away to our present subscribers, for the work of getting NEW subscribers for the American Bee Journal.

A description of the book here is quite unnecessary—it is simply the most complete scientific and practical bee-book published to-day. Fully illustrated, and all written in the most fascinating style. The author is also too well-known to the whole bee-world to require any introduction. No bee-keeper is fully equipped, or his library complete, without "THE BEE-KEEPER'S GUIDE."

Given For 2 New Subscribers.

The following offer is made to PRESENT subscribers only, and no premium is also given to the two new subscribers—simply the Bee Journal for one year:

Send us **Two New Subscribers** to the Bee Journal (with \$2.00), and we will mail you a copy of Prof. Cook's book FREE as a premium. Prof. Cook's book alone sent for \$1.25, or we club it with the Bee Journal for a year—both together for only \$1.75. But surely anybody can get only 2 new subscribers to the Bee Journal for a year, and thus get the book as a premium. Let everybody try for it. Will you have one?

GEORGE W. YORK & CO.,
CHICAGO, ILLS.

A Bargain—EARLY QUEENS.

119 Colonies Italian Bees in Chaff Hives: two acres land; good house; excellent well.

Early Queens—Tested, \$1.50; Untested, 75c.

E. L. CARRINGTON,
16Atf PETTUS, Bee Co., TEX.
Reference—1st National Bank of Beeville.

Mention the American Bee Journal.

CARLOADS



Of Bee-Hives, Sections, Shipping-Cases, Comb Foundation, and **Everything** used in the Bee-Industry.

I want the name and address of every Bee-keeper in America. No reason why you cannot do business with me. I have

Cheap Lumber and Experienced Workmen; a good Water-Power Factory and know how to run it. I am supplying Dealers as well as consumers. Why not you? Send for Catalogues, Quotations, etc. **W. H. PUTNAM,**
1E RIVER FALLS, Pierce Co., WIS.

Mention the American Bee Journal.

Page & Lyon Mfg. Co.,

NEW LONDON, Wis., operates two saw-mills that cut, annually, eight million feet of lumber, thus securing the best lumber at the lowest price for the manufacture of bee-keepers' supplies. They have also just completed one of

The Largest Factories,

and have the latest and most improved machinery for the manufacture of Bee-Hives, Sections, etc., that there is in the State. The material is cut from patterns, by machinery, and is absolutely accurate. For Sections, the clearest and

The Whitest Basswood

is used, and they are polished on both sides. Nearness to pine and basswood forests, and possession of mills and factory equipped with best machinery, all combine to enable this firm to furnish the best goods at

The Lowest Prices. ♡

For instance, it has a job lot of 200,000 No. 2 Sections that will be sold at 50 cts. per 1,000; or 2,000 Snow-White Sections will be sold for \$4.00, and larger quantities at still lower prices. Send for Circular and see the prices on a full line of supplies.
16Atf

Mention the American Bee Journal.

balance—14 colonies—are now in very good condition—all having queens and sealed brood.

I see at present no reason why I should regret the removal of the bees from the cellar at that early date. For a number of years the old-time bee-keepers on Fox river have made it a practice to put their bees out-doors early—as near the first day of March as possible, and they let them remain out. We like the practice.
M. M. BALDRIDGE.

St. Charles, Ill., April 20.

Gathering Honey and Pollen.

I have been keeping bees for only two years. I have only three colonies, and have been working with them, studying their habits, and trying to learn their natural requirements. Bees gather about 40 pounds of surplus honey per colony, in this section. Mine are gathering pollen and honey to-day from fruit bloom, and what we call redbud and spring bloom.
G. STEPHENS.

Tygart's Valley, Ky., April 18.

Report for Several Years.

The year 1892 was the poorest I had since I kept bees, and I began bee-keeping somewhere in the early 60's. That year (1892) I got neither swarms nor honey, but had to buy sugar to feed my bees, and by the spring of 1893 I lost 50 out of 80 colonies. 1893 was a better year, but I lost most of my bees, and what I had left were in poor condition. 1894 brought me a little nice linden honey and a few swarms, and last year (1895) was another poor year for me; all I got was a little dark honey in the fall, and since I took them out of the bee-cellar, I have lost 9 out of 62 colonies, most of them by bee-disease.

JOSEPH HENTRICH.

Dickeyville, Wis., April 19.

FULL COLONIES

Of Italian Bees for \$4.00. Are worth twice the money. Queens bred from fine imported mother. Langstroth frames: 10-frame hives. All combs built on foundation in wired frames and perfect. Can't possibly break down in shipment. I have been keeping bees as a specialty for many years, and wish to retire from business. A rare chance to get superior colonies cheap. No circular. Send the price and get your bees. See the following from Mr. T. C. Potter, Indianapolis, Ind.:

"April 21st, 1896, Mr. T. H. Kloer, Dear Sir:—The colony of bees came last evening. It is perfectly satisfactory. In fact, I have bought bees off and on for 15 years, and do not know that I ever have purchased a nicer colony at the time of year, or for such a moderate price. ... I found the queen readily. The bees were very gentle, not one offering to sting. So I fancy I have a gentle strain—just what I wanted. Now I thank you very much for giving me a good colony for so small a price, and for packing them so that they could be opened up so readily. ... If any one wants recommendation, refer to me."

Address, **T. H. KLOER,**
426 Willow St., TERRE HAUTE, IND.
20Atf Mention the American Bee Journal.

Bee-Keepers' Photograph.—We have now on hand a limited number of excellent photographs of prominent bee-keepers—a number of pictures on one card. The likeness of 49 of them are shown on one of the photographs, and 121 on the other. We will send them, postpaid, for 50 cents each, mailing from the 121 kind first; then after they are all gone, we will send the 49 kind. So those who order first will get the most "faces" for their money. Send orders to the Bee Journal office.

WOVEN WIRE FENCE

Over 50 Styles

The best on Earth. Horse high, Bull strong, Pig and Chicken tight. You can make from 40 to 60 rods per day for from 14 to 22c. a Rod. Illustrated Catalogue Free. **KITSELMAN BROS.,** Ridgeville, - Indiana.

48Etf Mention the American Bee Journal.

TWO APIARIES!

500 Nuclei devoted to Queen-Rearing. Prices for May will be as follows: Untested, 75c.; 1/2 doz., \$4.00; Tested, \$1.00. June—Untested, 65c.; 1/2 doz., \$3.60; Tested, 85c. All Queens promptly sent by return mail.

LEININGER BROS.,
FT. JENNINGS, OHIO.

6Etf WHEN ANSWERING THIS ADVERTISEMENT, MENTION THIS JOURNAL.

I have one of the choicest flocks of BROWN LEGHORNS IN THE STATE

Keep no other kind. Eggs, 75c. per 15; \$1.25 per 30. **B. G. SCOTTIAN,** OTISVILLE, MICH.

16Etf Mention the American Bee Journal.

Bee Supplies

Largest Stock and Greatest Variety in the West. **BEST** Good-at-Low-EST prices. Cat. of 80 pages FREE.

E. KRETCHER, RED OAK, IOWA.

Mention the American Bee Journal. 12E8t

Duvall's Queens Have become popular for their superior qualities and the price is way down now. Be sure to send for Circular.

C. D. DUVAL, Satsuma Heights, Fla.
18Etf Please mention this Journal.

ITALIAN BEES.

Untested Queens, \$1.00. Tested, \$1.25. Bees by the lb., \$1.00. Nuclei—Two frame, with Queen, \$2.50; one frame, \$2.00.

Also, Barred and White Plymouth Rock Eggs for setting; \$1.00 for 15.

Mrs. A. A. SIMPSON, SWARTS, PA.
18E7t Mention the American Bee Journal.

Up to Guarantee!

On June 1 I shall be prepared to ship Queens of my famous

ADEL STRAIN.

This strain of beautiful yellow-banded Bees is practically non-warming and non-stinging. Queens, each, \$1.00. Special prices by the dozen. Everything guaranteed. Cat'g free.

HENRY ALLEY, WENHAM, Essex Co., MASS.
18E7t

MUTH'S HONEY EXTRACTOR

PERFECTION Cold-Blast Smokers,

Square Glass Honey Jars, Etc.

For Circulars, apply to **CHAS. F. MUTH & SON,** Cor. Freeman & Central Aves., Cincinnati, O. Send 10c for Practical Hints to Bee-Keepers.

1896 SAVE MONEY 1896

If you want first-class **ITALIAN QUEENS FOR BUSINESS.** Foundation at Wholesale Prices, Hives, suited for the South, or **SUPPLIES**, send for Price-List—to

J. P. H. BROWN, AUGUSTA, GA.

Honey & Beeswax Market Quotations.

The following rules for grading honey were adopted by the North American Bee-Keepers' Association, and, so far as possible, quotations are made according to these rules:

FANCY.—All sections to be well filled; combs straight, of even thickness, and firmly attached to all four sides; both wood and comb unsoiled by travel-stain, or otherwise; all the cells sealed except the row of cells next the wood.

No. 1.—All sections well filled, but combs uneven or crooked, detached at the bottom, or with but few cells unsealed; both wood and comb unsoiled by travel-stain or otherwise.

In addition to this the honey is to be classified according to color, using the terms white, amber and dark. That is, there will be "fancy white," "No. 1 dark," etc.

CHICAGO, ILL., Apr. 23.—We quote: Fancy white, 15c.; No. 1 white, 12@13c.; fancy amber, 9@10c.; No. 1 amber, 7@8c.; fancy dark, 8@9c.; No. 1 dark, 7c. Extracted, white, 5@7c.; amber, 4@5c.; dark, 4@4½c. Beeswax, 30c. The number of sales are few, and prices are really nominal. The only activity shown is in a little fancy comb and beeswax.
R. A. B. & Co.

PHILADELPHIA, Pa., Apr. 22.—We quote: No. 1 white, 9@10c.; fancy amber, 8@9c.; fancy dark, 7@8c. Extracted, white clover, 10c.; amber, 5@5½c.; dark, 4@4½c. Beeswax, 25@26c. Comb honey is dull. Extracted in fair demand. Beeswax lower. W. A. S.

KANSAS CITY, Mo., Apr. 18.—We quote: No. 1 white, 13@14c.; No. 1 amber, 11@12c.; No. 1 dark, 8@10c. Extracted, white, 5@6c.; amber, 4½@5c.; dark, 4@4½c. Beeswax, 25c. C. C. C. & Co.

BUFFALO, N. Y., Apr. 20.—We quote: Fancy white, 15@16c.; No. 1 white, 13@14c.; fancy dark, 8@9c.; No. 1 dark, 7@7½c. Beeswax, 25@28c. Trade very dull and honey not moving, except a few fancy lots; anything dark is hard to sell. B. & Co.

NEW YORK, N. Y., Apr. 20.—We quote: Fancy white, 14c.; No. 1 white, 12c.; No. 1 amber, 11c.; No. 1 dark, 8c. Extracted, white, 5½@6c. Beeswax, 29@30c. Market is quiet. Some demand for white comb, but buckwheat not wanted. White is selling at from 11@14c. and buckwheat at 8c. The market on extracted is unusually quiet, with large supplies of California. Beeswax steady at quotation. H. B. & S.

CINCINNATI, O., Apr. 22.—There is no fancy white comb honey on our market. Best white sells at 12@14c. in a jobbing way, with a fair demand. Demand is good for extracted at 4@7c. according to quality. Beeswax is in good demand at 25@30c. for good to choice yellow. C. F. M. & S.

List of Honey and Beeswax Dealers.

Most of whom Quote in this Journal.

Chicago, Ills.

R. A. BURNETT & Co., 163 South Water Street.

New York, N. Y.

HILDRETH BROS. & SEGELKEN,
120 & 122 West Broadway.

CHAS. ISRAEL & BROS., 486 Canal St.

Kansas City, Mo.

C. C. CLEMOMS & Co., 423 Walnut St.

Buffalo, N. Y.

BATTERSON & Co., 167 & 169 Scott St.

Hamilton, Ills.

CHAS. DADANT & SON.

Philadelphia, Pa.

WM. A. SELSER, 10 Vine St.

Cincinnati, Ohio.

C. F. MUTH & SON, cor. Freeman & Central avs.

Convention Notices.

ILLINOIS.—The spring meeting of the Northern Illinois Bee-Keepers' Association will be held at the home of Mr. O. J. Cummings, in Gullford, on May 19, 1896. Come, and bring your wives and friends interested in bees.
New Milford, Ills. B. KENNEDY, Sec.

Question-Box.

In the multitude of counsellors there is safety.—Prov. 11-14.

Effect of Cold and Heat Upon Foul-Brood Germs.

Query 13.—1. Will the germs of foul brood be destroyed if the honey is in a freezing temperature during the winter?

2. To what degree of temperature will honey have to be heated to destroy the germs of foul brood?—VERMONT.

G. M. Doolittle—1. Doubtful. 2. Boil it.

P. H. Elwood—1. No. 2. Quinby says boil it.

Rev. M. Mahiu—1. I think not. 2. I do not know.

W. R. Graham—I know nothing about foul brood nor the germs.

James A. Stone—As I have never had any experience, I do not know.

W. G. Larrabee—I have never had any experience with foul brood.

J. M. Hambaugh—1 and 2. To both of these questions, I don't know.

R. L. Taylor—1. No, not at all. 2. Nothing less than the boiling point is safe.

Chas. Dadant & Son—1. I think not. 2. To the boiling point of water, or nearly.

H. D. Cutting—1. From past experience I think it will. 2. 212° for at least 60 minutes.

Dr. J. P. H. Brown—1. I should think not. 2. I do not know. Dr. Howard, of Texas, cau tell.

Mrs. L. Harrison—1. I do not think that it would. 2. I never had experience with foul brood.

Allen Pringle—1. No. You can't freeze the life out of the "varmints." 2. The boiling temperature.

B. Taylor—1. I have no experience. I never had, or saw, a colony afflicted in that way. 2. I don't know.

Eugene Secor—As I should have to answer this from the books, I respectfully refer the querist to them.

Dr. C. C. Miller—1. I think not. 2. At least 194° for three hours. 212° will not kill them unless continued 2½ hours.

C. H. Dibbern—1. I have had no experience with foul brood, but I think not. 2. I think that the boiling point will do it.

E. France—1. I would be afraid to risk it. 2. I don't know. I should not risk anything less than the boiling point for an hour.

Emerson T. Abbott—1. I do not know. Some germs are not affected by freezing. 2. I have never tested the matter. It is said that there are germs which will stand boiling.

G. W. Demaree—1. I don't know, practically, anything about foul brood, or foul brood germs. If I were to guess at it, I would guess that protracted hard freezing would destroy the germs.

J. E. Pond—1. No, most decidedly not. 2. I don't know, and should not dare, with the experience I have had, to

use either honey or comb that had once been contaminated with foul brood.

Prof. A. J. Cook—1. No. Cold does not destroy germs. 2. It ought to be boiled for some minutes. Boiling simply does not always destroy bacteria, it takes in many cases prolonged boiling.

WANTED TO EXCHANGE.—Some Fine Collie Shepherd Puppies for Bees or Honey. I also have one extra fine English Mastiff Slut, 10 months old, I will exchange.
W. S. BRILLHART, Millwood, Knox Co., Ohio.

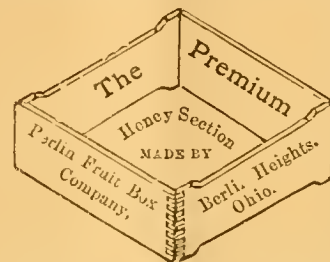

—BEE SUPPLIES—
and all kinds of Boxes, Ber-
lin-Chees, and Baskets. We
make a specialty of 1-piece
Sections & Wood Separators

Address, **BERLIN FRUIT-BOX CO.,**
28 EAST BERLIN HEIGHTS, OHIO.

Mention the American Bee Journal.

❖ MONEY SAVED IS MONEY GAINED. ❖

THE ROYAL UNION
Life Insurance Company
DES MOINES, IOWA.

The Iowa Policy

Is one that definitely promises to keep an accurate account with you; credit your premiums and interest, charge the actual expense and mortuary cost, and hold the remaining funds subject to your order.

Agents Wanted.
JOHN B. KING, GENERAL AGENT,
Suite 513 First Nat'l Bank Bld'g,
20 Atf **CHICAGO, ILL.**
Mention the American Bee Journal.

1,000 Teachers' Oxford Bibles

Were bought for spot cash by a Chicago firm from an Eastern publisher who was about to be driven to the wall for the want of ready money. More than a million of these same Bibles, in every way like the illustration, have been sold during the past few years at three times the money we ask for them.

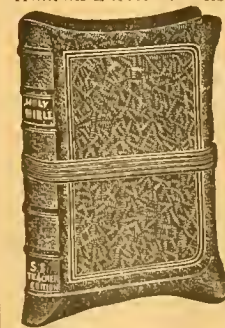

They are the genuine Teachers' Oxford Bibles, Divinity Circuit, round corners, gilt edges, complete teachers' helps, maps, 1,350 pages, bound in French seal limp, with perfectly flexible backs. Sent prepaid.

Regular price, \$4.50; our price, \$2.25. Or we club it with the Bee Journal for one year—both for only \$2.75; or we will give this fine Bible free as a premium to any one sending 4 new subscribers to the Bee Journal one year (with \$1.00). No additional premium is given the new subscribers—simply the Bee Journal one year to each of them.

GEORGE W. YORK & CO.,
— CHICAGO, ILLS.

Please Send Us the Names of your neighbors who keep bees, and we will send them sample copies of the BEE JOURNAL. Then please call upon them and get them to subscribe with you, and secure some of the premiums we offer.

Bottom Prices

**BRING US BIG TRADE.
GOOD GOODS KEEP IT.**

If you want the best supplies that can be made at a little less cost than you can buy the same goods for elsewhere, write to us for low prices. 1896 Catalogue now ready—ask for it and a free copy of **The American Bee-Keeper** (36 pages).

Address,
THE W. T. FALCONER MFG. CO.,
JAMESTOWN, N. Y.
Mention the American Bee Journal.

COMB FOUNDATION!

Wax always wanted for Cash or in Exchange for Fdn. or other Supplies. My trade is established on **Low Prices** and the merit of my **Foundation**. Orders filled promptly.
WORKING WAX INTO FDN. BY THE LB. A SPECIALTY. Wholesale prices to dealers and large consumers. Send for Prices and Samples to—**GUS DITTMER, AUGUSTA, WIS.** Reference—Augusta Bank. 1A1f
Mention the American Bee Journal.

ROOTS GOODS Prices Reduced on Doyetall Hives and Sections. A full line of Apian Supplies in stock to fill orders promptly at lowest prices for Best Goods. 36-page Catalogue Free.
JNO. NEBEL & SON, High Hill, Mo.
Mention the American Bee Journal. 4A26t

I ARISE



TO SAY to the readers of the **BEE JOURNAL** that **DOOLITTLE** has concluded to sell **BEES and QUEENS** in their season, during 1896, at the following prices:

- One Colony of Italians on 9 Gallap frames, in light shipping-box \$6.00
- Five Colonies..... 25.00
- Ten Colonies..... 45.00
- 1 untested queen. 1.00
- 6 " queens 5.50
- 12 " " 10.00
- 1 tested Queen... \$1.50
- 3 " Queens. 3.50
- 1 select tested queen 2.00
- 3 " " Queens 4.00

Select tested queen, previous season's rearing . 4.00
Extra Selected for breeding, **THE VERY BEST.** 5.00
About a Pound of **BEES** in a Two-frame Nucleus, with any Queen, \$2.00 extra.

☞ Circular free, giving full particulars regarding the Bees and each class of Queens.
Address
G. M. DOOLITTLE,
12A25t **BORODINO, Onon. Co., N. Y.**
Mention the American Bee Journal.

BEES QUEENS Smokers, Sections, Comb Foundation, And all Apian Supplies cheap. Send for FREE catalogue. **E. T. FLANAGAN, Belleville, Ill.**
6A26t Please mention the Bee Journal.

PURE BARRED PLYMOUTH ROCK Eggs, \$1.25 per 14. Our P. Rocks are very large, with fine plumage. Also,
BLACK MINORCA EGGS,
a non-sitting and great laying breed. Both kinds raised upon our farm. Minorca Cockrels, \$1.00 each. **Mrs. L. C. ANTELL,** 16A1f **ROSEVILLE, Warren Co., Ill.**
Mention the American Bee Journal.

19th Year Dadant's Foundation 19th Year

Is still in the lead, for we use all the latest improvements, including the

NEW WEED PROCESS,

and still make the best goods. Remember that we do not use any acid to purify our beeswax, and that is why our Foundation preserves the smell of the honey and is more acceptable to the bees, than any other. It is kept for sale by

T. H. Strickler, Solomon City, Kansas.
G. K. Hubbard, Fort Wayne, Ind.
L. Hansen, Davenport, Iowa.
C. Theilmann, Theilmanton, Minn.
E. C. Eaglesfield, Berlin, Wis.
E. T. Abbott, St. Joseph, Mo.
J. M. Jenkins, Wetumpka, Alabama
John Rey, East Saginaw, Mich.
Vickery Bros., Evansville, Ind.

The Jennie Atchley Company, Beeville, Texas.
C. F. Muth & Son, Cincinnati, Ohio
E. Kretschmer, Red Oak, Iowa.
G. E. Lewis Co., Watertown, Wis.
James Reynolds Elevator Co., Poughkeepsie, N. Y.
Louisiana Bee-Keepers' Supply Manufactory, Donaldsonville, La.
Page & Lyon, New London, Wis.

and many other Dealers. All agree in saying that no goods are better than ours. Those of our customers who formerly bought through Thos. G. Newman can get our Foundation in **Chicago, Ill.**, by addressing us at **118 Michigan Street**. We keep no other goods there.

We make a specialty of **Veils and Veil Stuffs** of best quality, cotton and silk.
"LANGSTROTH ON THE HONEY-BEE"—Revised.

Bee-Keepers' Supplies, Smokers, Sections, Tin Pails, etc. **Samples of Foundation and Tulle FREE** with Circular. Instructions to beginners with Circular. Send us your address.

CHAS. DADANT & SON,
Mention the American Bee Journal. **HAMILTON, Hancock Co., ILL.**

25c Cash Paid for Beeswax!

For all the **good, pure yellow BEESWAX** delivered to our office till further notice, we will pay 25 cents per pound, cash; or 28 cents for whatever part is exchanged for the American Bee Journal, Books or Seed, that we offer. If you want **cash promptly** for wax, send it on at once. Dark or impure wax not taken at any price. Address plainly,

George W. York & Co., 118 Michigan St., Chicago, Ill.

Lower Prices on Sections & Foundation

Improved facilities, increased output, and competition, together with hard times, tend to lower prices.

Root's No. 1 White Extra-Polished Sections are superlative in quality, and are now offered for a short time at the following special prices for 4 1/4 x 4 1/4 any stock width: **1000, \$2.50; 2000, \$1.50; 3000, \$6.45; 5000, \$10.00.**

Cream Sections of such widths as we have in stock at 25c per 1000 less than the white.

The New Weed Process Comb Foundation is superior to all others in every way, showing, from recent tests in Florida, five times greater resistance to sagging, making it possible to use a lighter grade with more feet to the pound, with greater safety than with the old process. Owing to decline in wax we reduce price of Foundation **3 cts.** a pound. Prices now are:

	Price per lb. in lots of 1 lb.	10 lbs.	25 lbs.	50 lbs.
Heavy or Medium Brood Foundation.....	44c	43c	42c	40c
Light Brood.....	47c	46c	45c	43c
Thin Surplus.....	54c	53c	52c	50c
Extra-Thin Surplus.....	59c	58c	57c	55c

Lower prices on 100-lb. lots, and dealers supplied at special prices.

These wholesale dealers who handle Root's Goods in carload lots unite with us in above prices:
Walter S. Pouder, Indianapolis, Ind.; John Nebel & Son, High Hill, Mo.
Joseph Nysewander, Des Moines, Iowa; Wm. A. Selser, Philadelphia, Pa.
M. H. Hunt, Bell Branch, Wayne Co., Mich.; Geo. E. Hilton, Fremont, Mich.

THE A. I. ROOT CO., MEDINA, OHIO.
118 Michigan St., Chicago, Ill. **Syracuse, N. Y.**
1024 Mississippi St., St. Paul, Minn. **Mechanic's Falls, Maine.**

BEE JOURNAL

ESTABLISHED 1861
THE OLDEST BEE-PAPER IN AMERICA

DEVOTED EXCLUSIVELY
TO THE INTERESTS
OF HONEY-PRODUCERS

Published Weekly, at \$1.00 per annum. Sample Copy sent on Application.

36th Year.

CHICAGO, ILL., MAY 21, 1896.

No. 21.



Bee-Keeping for Women.

BY MRS. L. C. AXTELL.

Women living upon a farm, or in the outskirts of a village, would find it a pleasure, and a profit, by keeping one or more colonies of bees, especially if they desire to have a few dollars all their own. Even though they may have their hands already full of other work, the little time that it takes to care for bees out-of-doors would give renewed strength and energy, so that the time taken for the bees would not be missed.

BEEES AND SUNSHINE.—In all cool and cloudy or rainy weather bees ought not be disturbed, so that we are not obliged to be out-of-doors caring for bees in weather that would be injurious to our health. When the bees fly freely, and the wind is not blowing hard, any time during the warm part of the day is a good time to work with them. I prefer not before 9 o'clock in the forenoon, or after 4 in the afternoon, as I find it a little difficult to see the interior of the hive with my bee-hat on, owing to the sun being low down in the horizon.

BEE-WORK IS NOT HARD WORK—at least I do not find it nearly so tiresome as most out-of-door work, or even common housework; washing, ironing, sweeping, mopping. I find much more tiresome. I suppose it is something as we take it; if we like to do anything, it is more easily done. Of course, if we are already tired out before we go to work with the bees, we will grow more tired, and yet not so much more tired as if we had continued at work in the house, as it is a recreation to be out-of-doors in the glorious sunshine after being shut up in the house the most of the time perhaps for days. To feel and breathe the pure air, and hear the birds sing and the busy hum of the bee, and the eye to rest upon the green grass and trees, and bright flowers, and the beautiful blue sky, is restful, even to the tired body, if not continued too long.

THE FEAR OF STINGS I think prevents many from not liking the work, and yet, when properly protected with a bee-hat or face-veil, and working only in the warm part of the day, and never when cloudy, rainy or cold, and with the use of a good smoker, one need rarely be stung, if we immediately extract the sting by scraping it off (not pinching it, as that squeezes the poison-sac, and causes more poison to enter the flesh), and then pay no attention to the pain, work all the

harder for a few minutes, most people will soon get so they do not care much if they are stung; but if we stop work and nurse the sting, and think about it, it seems almost unbearable; the mind being upon it makes it many times harder to bear.

BEEES FOR YOUNG WOMEN would be a delightful employment, it seems to me. They could then remain at home where they could be helpful to their parents, and at the same time be making something for themselves. They, nor any one, should attempt to work with them without learning how. A dollar spent for a good book on bee-culture will teach any one a great deal. Possibly bees in the old box-hive, kept after the let-alone fashion, might be profitable, but I think it pays much better to read up and find out their needs, and get the gentle Italian bees, and give them a chance to do their best, by giving them a warm, movable-frame hive where their wants can all be known and be supplied from time to time.

Women can be just as successful with bees as men, and that is one kind of work they receive just as much pay for as do men. When we take our honey to market a pound of



Mrs. L. C. Artell, Roseville, Ill.

honey that a woman gets from her bees brings just as much as her husband's or brother's honey.

HONEY ALWAYS BRINGS A PAYING PRICE, at least we have always thought so. When there has been a great deal

of honey in one year, the price gets lower, but we can afford to sell lower because we have more to sell.

There is no article of food that looks more attractive upon our table than honey in the comb, and it is always ready for immediate use—we do not have to prepare it and cook it—it is always ready.

Roseville, Ill.



Bee-Keepers' Societies—Amalgamation, Programs, Etc.

BY PROF. A. J. COOK.

Perhaps the most urgent reason given for the amalgamation of the National Bee-Keepers' Union and the North American Bee-Keepers' Association is the fact that many regard the North American as a sort of a failure. This argument does not appeal to me at all. I have never regarded the American in any such light. I have attended several meetings of this society, notably the ones at Cleveland, Chicago, Toronto, Detroit, Cincinnati, Lexington and Chicago, and I regarded them as very important factors in the progress of apiculture in our country. Of course, we cannot expect a very general attendance upon such meetings, for our country is too large, and the time and expense required in going, for instance, from California to Toronto, is quite beyond the means of most of our bee-keepers. Thus, it is that the attendance will always be in the main local, though, if I may judge by the meetings that I have attended, there will always be a good sprinkling of our best apiarists from many of the States.

There are also papers from other apiarists, men of marked ability and high standing among bee-keepers, which will be sent to the convention to be read, although the writers are unable to be present. Thus, each of these meetings becomes a matter of great interest and importance to all our bee-keepers. The best of knowledge and method that our country knows is very apt to come out at such gatherings. The discussions are apt to be of the highest order, and the social feature of the meetings will do very much to strengthen the fraternal feeling without which no industry can reach to the best attainment. The editors of the various bee-papers will always be on hand, and thus those who are so unfortunate as to be unable to attend will get through the bee-papers all that is new and important in the bee-keeping art.

It seems to me that the meetings should be migratory, and I think the past history of this society has been very fortunate in this respect, so that each State, where there is a strong desire for the meetings, should, in its turn, have the benefits accruing from the meeting of the Association in its limits. I would never have the Association go where there was not a strong invitation, and a promise that all local expenses, such as hall, local advertising, etc., should be borne by the State or town where the meeting is held. We may use sarcastic terms regarding the attendance and influence of the meetings of the past; but I feel very sure that a close study would show that the North American Bee-Keepers' Association has been a tremendous factor in the rapid development which has characterized the bee-keeping of America.

I have had a large experience in organizing and carrying out such meetings as the ones in question, and after all the study and thought that I have been able to give, I would like to suggest what is my ideal in regard to State and National associations:

In the first place, as already suggested, I would stoutly urge that all places be fairly used, that is, that the meetings be migratory, and that each section in the State or country receive its share of attention. I would, however, never go to a region where there was not sufficient interest to secure an urgent appeal for the meeting. I would also have prepared in advance a strong, meaty program, with papers from the strongest and most successful men in the State or country.

These papers should be from men whose very names would awaken interest and secure a large attendance. I would have these papers short and to the point, and, best of all, each paper from a specialist in the line of thought which the paper takes. I know that in this respect my recommendation would be criticised by some of our very brightest and wisest bee-keepers, but I still believe I am right. I do not believe any meeting can do the best work without such a program. All experience of every kind of society in the past sustains this position, and as we stop and give the matter thought, it is easy to understand why this is so. It is expensive to go off perhaps for miles, and possibly hundreds of miles, to attend the meeting, and few of us, especially in these hard times, will undertake such a journey unless we have some promise of a rich feast for our labor and pains.

A program wisely prepared is just such a promise. Let me see a program where it was announced that Messrs. Hall, McKnight and Pringle, of Ontario; Messrs. Doolittle, Hetherington and Root, of New York; Messrs. Bingham, Hutchinson, Taylor and Heddon, of Michigan; Messrs. Root, Mason and Tinker, of Ohio; Messrs. Miller, Green and Stone, of Illinois, etc., were to be present, and give papers on the subjects which they had nearest to heart, and I would almost go clear from California to Boston to be present at the meeting.

Again, few of us have the power to give extempore our views upon the subjects most familiar to us, in brief, terse form. But in the quiet of our study at home we can do just that thing, and thus we can save the time of the convention, every minute of which is precious.

After each subject is presented by the person appointed upon the program, then there is a chance for full discussion by any one present who can throw additional light upon it. If it is understood that 10 or 15 minutes is all that will be given to any speaker in introducing a subject, there need be nothing prosy or tedious because of a pre-arranged program. I undertake to say that there is very much less danger of waste of time from long-winded articles, if arranged as suggested above, than from waiting for some one to introduce a subject, or to present it briefly and pointedly where no program has been provided.

I have often thought I would like to have Dr. Miller present at some of our California Farmers' Institutes (at each of which we have a strong program arranged in advance), that he might see what could be secured at a meeting in which we have a program and carefully prepared papers, but brief ones, presented at each session. I would never have more than two or three papers at each session, and I would never have a paper to exceed 15 minutes.

We urge all to take no more than 10 minutes in the introduction of any subject brought before the meeting. The objection that this limits the subjects for discussion, and perhaps excludes topics which are most desired, is easily removed by a question-box, which is open for any question that any one may wish to ask. This question-box is opened at the beginning of each session, while people are coming in, and if it is presided over by one well qualified, it can be made so racy that there will be few tardy ones to disturb the meeting by their late entrance. We find the question-box an important aid in making our institutes in the highest degree instructive and profitable.

Claremont, Calif.



A New Binder for holding a year's numbers of the American Bee Journal, we propose to mail, postpaid, to every subscriber who sends us 15 cents. It is called "The Wood Binder," is patented, and is an entirely new and very simple arrangement. Full printed directions accompany each Binder. Every reader should get it, and preserve the copies of the Bee Journal as fast as they are received. They are invaluable for reference, and at the low price of the Binder you can afford to get it yearly.

Adulteration—More Action and Less Talk.

BY ED JOLLEY.

Editor Root says in Gleanings, that adulteration of honey seems to be on the increase, owing to the apathy and hush-up policy of bee-keepers in general. Now this is a question with two sides to it. There is doubtless a great deal of honey adulterated, and probably it is increasing, but I am very loth to attribute the cause of it to any hush-up policy on the part of the bee-keepers. I am more inclined to think that the abortive howls of a few over-zealous bee-keepers has not only called public attention to the fact that adulteration of honey is rife—and thereby placed the ban of suspicion on the genuine article—but they have shown those who are unprincipled enough to adulterate honey, how utterly helpless we are, under our present laws, to protect ourselves.

Now, I am as bitter against the adulteration of our product as any one can be, but I think this clash and clatter, before we have secured laws that will help us, is premature, and will not avail us anything; and is quite as injurious to bee-keepers as the adulteration itself. It would serve our purpose far better for the bee-keepers of each State to try to impress upon their different representatives our need of laws that will protect our industry. I have no doubt but what the united efforts of the bee-keepers would be successful. This is the same road the dairymen had to travel to secure laws against the adulteration of their product. A few years ago the oleomargarine makers were making things look pretty blue for them, but instead of rushing into print with such statements as—"half the butter on the market is oleo," and "imitation is so perfect that an expert can hardly detect it," etc.—they organized and succeeded in having the business pretty generally out-lawed. Now, if we had laws so that we could punish the adulterators, there might be some excuse for making a fuss, but, as it is, I think it would be better to talk less and act more.

Franklin, Pa.



Transferring Bees—How Not to Do It.

BY EMERSON T. ABBOTT.

As this is the season when bees are usually transferred, a few words on this subject may not be out of place. I am frequently asked by the inexperienced how to transfer bees from old box-hives to modern hives, and I now make it a point to say, "Do not do it." As this answer is not in accordance with the usual teaching on this subject, it may not be amiss for me to give my reasons for the "faith that is in me."

As I now see things, bees are always transferred at a loss, and in most cases I think the beginner makes a mistake if he undertakes it. With the little experience which he has had, he is almost sure to make a bungling job of it. Neither do I think it will pay, even though the operator is an expert. The interference with their work, and the loss of brood that is sure to follow from transferring a colony of bees at this season of the year, is sure to amount to more than the benefits to be derived from the process.

Do not understand me to mean that there are no benefits to be derived from having a colony of bees in a good, modern hive, as there can be no question about this, in my mind. The advantages to the bee-keeper of the movable-frame hive over any box-hive are very great, but the loss incurred in making the change is what has led me to devise some other method of securing the end desired. There was a time when I believed in and practiced transferring, but now, if a man should come to me and say, "I have 10 colonies of bees in old box-hives, and I want to try the modern hive, as I get nothing out of my bees as they are managed at present," I would advise him to proceed as follows:

Leave the bees where they are, but crowd them down into

the lower part of the hive and let them remain there until they swarm. In the meantime, get 10 good hanging-frame hives, and fit them up with foundation in the brood-frames, and starters in the sections. The usual charge in this country for transferring is \$1.00, and this will more than pay for the foundation. When the bees swarm, be on hand and set one of the new hives on the stand where the box-hive from which the swarm has issued stands, first having moved the old hive back a few feet, with the entrance turned the opposite way from what it has been. Hive the swarm in the new hive, and let the old hive remain where it is until the next day. Then turn it around and set it close up beside the new hive, with the entrance the same way. Leave it here about two weeks and then move it to some other part of the yard, and let all of the flying bees go to the new hive. By following out these instructions, he will soon have 10 strong colonies of bees in modern hives, and I think he will get more than twice as much honey from the 10 colonies as he would if he had gone to the trouble of transferring them, or the expense of having it done.

He can repeat this process until he has all the bees he wants in modern hives, and then he can dispose of his bees in the box-hives to some one who wants to go through the same process which he has in getting a start in bees, or he can keep them for a "nest egg" some spring after a long, hard winter when the bees all die off in the modern hives; for there is no question in my mind but what bees winter better, taking one winter with another, in the old-fashioned, tall box-hives than they do in our modern hives with shallow frames. If it were not for the other benefits which more than overbalance the chance of loss, I would not use a modern hive at all. The problem in modern bee-keeping seems to be to get the bees through the winter strong and healthy.

If one does transfer his bees, I trust he will not use thorns, wire nails, or sticks to fasten the combs in the frames, as is recommended in most bee-books, and also in the Government Bulletin No. 1, just issued. Wrapping-twine is just as good, and is preferable in some respects, and is much more easily put on and taken off. In fact, the bees will take it off themselves, if given time enough, but I prefer cutting it off with a sharp knife after a day or two.

St. Joseph, Mo.



Sweet Clover in the South—Grown as Regular Farm Crop.

BY M. M. BALDRIDGE.

The correspondence below will, I think, explain itself as the reader proceeds. As will be seen, the letters were written by a man who has had a long and extensive experience in growing sweet clover for stock and for improving the soil. Now, as this correspondence was not intended for the public eye, the reader will please excuse the omission of the writer's name and postoffice address, and be content with simply the facts presented. I will give dates, for they seem to be necessary:

———, Mississippi, Oct. 26, 1894.

I sow about 50 acres of sweet clover every spring, and any time between the 1st of February and the 15th of April. As a rule, I plow and harrow the ground before sowing the seed. I then sow about 15 pounds of unhulled seed per acre, and do not cover it at all. I have never failed to get a good stand. Some times I sow the seed upon land not plowed at all, and even then I seldom fail to secure a good "catch." It will grow on Bermuda or Johnson grass sod, and it is, in my opinion, a better plant for enriching the land than cow-pea vines or red clover.

Sweet clover must be a good honey-plant, for my fields are alive with bees when the plant is in blossom. I cannot imagine where the bees come from, for I keep none, and they seem to be very scarce in my neighborhood. They must come, so it seems to me, a distance of from 4 to 5 miles. I know but little about the habits of bees, for I never had the least

desire to handle them. I think, however, that one of their chief characteristics must be to sting, for they seldom fail to give me a dose whenever I come in contact with them.

When sweet clover is grown for honey, and a crop of blooming plants is desired every year, and from the same land, then two crops of seed, in successive years, should be planted, for, as you must be aware, the plant is biennial, and blooms only every other year. * * *

—————, Mississippi, Feb. 23, 1895.

I don't know how much sweet clover there may be within a radius of two miles of my home, but to guess at it I should say perhaps 100 acres that will bloom this season—counting what is on the banks of ditches and in waste places, of which I have about 50 acres.

I like your bulletin (No. 2) on sweet clover very much. I think it covers all the ground, judging from my experience with the plant, and that no part of it is exaggerated. * * *

—————, Mississippi, March 28, 1895.

I have grazed cows, hogs and horses for years on sweet clover, but no sheep, for I do not keep them. Sweet clover will bloat cows to some extent the second year of its growth, but I have never had any special trouble in that direction.

My present crop of sweet clover is now tall enough to graze, and it compares favorably with all my sweet clover crops in past years. * * *

—————, Mississippi, May 2, 1895.

The average weight of a bushel of sweet clover seed, where unhulled, is about 32 pounds. When it weighs 35 pounds, it must be very clean and very plump seed.

I have read your Sweet Clover Bulletin No. 1, and can indorse it fully except certain statements that I know nothing about. I presume they must be correct, or you would not have made them.

My sweet clover is now from 15 to 24 inches high, according to the fertility of the soil. I mow once and then get a big crop of seed to plant and to sell. I can, if I so wish, mow twice for hay, and then the plants will mature plenty of seed to re-seed the land. I always mow it twice for hay the first year, and often three times. The seed ripens here in August, but if it has been cut once this delays the ripening of the seed about two weeks, say about the latter part of August.

There are always a few scattering stalks of sweet clover that will bloom the first year, but they are very few indeed.

I think two crops of seed should always be sown on the same land, that is, the seed should be sown two years in succession. This insures a new growth of plants to cover the ground in the fall of the year, when the old plants have died out. This new growth of young plants always remains green all through the fall and during the first part of winter. This plan always insures a crop of blooming plants for the bees to gather honey from every year, and from the same plot of ground. * * *



Honey-Producers Helping Themselves.

BY G. M. DOOLITTLE.

It was with the greatest of interest that I read the article headed, "How Honey-Producers Can Help Themselves," by Emerson T. Abbott, on page 273; and as I feel a great desire to help myself always, where I can do so, I crave the privilege of asking Mr. Abbott a few questions, so that we as bee-keepers may the better know how to succeed.

Mr. A. tells us we should work our home market all it will possibly bear, and intimates, by his shopping story, that if we did this we might obtain as much for our product as did the storekeeper who sold the best of Colorado honey at 20 cents per pound. What I wish Mr. A. to tell us is, why it is that we should be obliged to *push* our own interests and honey-products into every home within 20 miles of us (our home market), often to the disgust and hindrance of those whose "time is money," that we may obtain the fancy price of 20 cents per pound for honey, or else go under with the "survival of the fittest," while during the seventies the whole of our product (not the best or "fancy") was sought after by buyers from abroad, at a price ranging from 25 to 30 cents per pound, free on board the cars, or at our own homes. If he

can tell us this, we can intelligently solve at least one of the problems which confronts every bee-keeper. Being told that we must economize at every point of production, and produce only a fancy article in these times of close competition, if we would survive, will make of me and mine the half fed and less clothed caricatures of humanity, when carried to its logical conclusion.

Again, Mr. Abbott tells us, "I know times are close, and people are forced to economize." Will Mr. A. tell us why times are close, and why we are forced to economize, as bee-keepers, while some of our statesmen (?) are telling us that the country was never so prosperous as now? Were these close times brought on us of God? Did not God say, "The earth is the Lords and the fullness thereof?" and did He not say, till the soil, eat, live and be happy? Has the earth become barren and unfruitful, so that the masses must economize, and thousands suffer from starvation?

Then Mr. A. tells us, "It is a favorite saying of mine that all I want is health and to be let alone." Does he mean by this that I have no privilege to share his markets for honey with him? That I must not send my fancy honey to the same market to which his fancy honey goes? As a minister of the Gospel of the Lord Jesus Christ, does he not know that the blessed Master said, "All ye are brethren?" and for him to ask me to let him alone, and give him all the markets, is not loving his neighbor as himself?

Again: Suppose that Mr. A. is right in asking that he as a bee-keeper should be let alone, does he not know that every bee-keeper who depends upon the production from his apiary for a living, is not being let alone, but is being robbed of 52 cents out of every dollar's worth of wealth which that bee-keeper produces, that a few may roll in wealth "who toil not neither do they spin?" If he knows this, should he not as a true "watchman on the towers of Zion," cry out in plain language to us humble ones, instead of preaching fancy honey and economy?

I indorse Mr. Abbott's views in the main, but cannot indorse the points hinted at in the above questions till I have further enlightenment on these points. Will Mr. A. please enlighten us?
Borodino, N. Y.



No. 4.—Producing Comb Honey in Michigan.

BY W. Z. HUTCHINSON.

(Continued from page 277.)

As the basswood harvest draws to a close all sections should be taken from the hives. Before the bees commence "snooping" around and dipping into any exposed honey, all of the honey should be off the hives. If there is any time of the year when the worst disposition of the bees shows itself it is at the close of the basswood honey harvest, and a little robbing will intensify it a hundred fold. If bee-escapes are used, and they should be, there is not so much necessity of promptness in getting off the honey, but I think it better to get the honey off as soon as possible, and then if feeding back is to be practiced to secure the completion of unfinished sections, it can be commenced while everything is in good trim—when there are no empty cells in the brood-nest to be filled with the feed.

The honey should be sorted into four grades—the finished, that is nearly all sealed, sections that are half finished, and those that are less than half completed. In putting the sections back on the hives, each grade should be kept by itself. Those nearly completed should be put in cases by themselves, and those that are half completed treated in a similar manner. If separators are not used, there is no part of feeding back that calls for the exercise of more care, patience and skill, than that of filling the cases with unfinished sections, particularly is this true of the sections that are nearly com-

pleted. If at any place the combs come so near together that a bee cannot pass between them, a bridge of wax will be made connecting the two combs, and when they are pulled apart, the comb is broken, and the honey set to running. If too wide a space is left between the combs, there is a disposition, especially if the bees are crowded, and the feeding generous, to build patches of comb right on top of the sealed comb.

When the combs are all in the supers, and ready to put on the hives, then comes the selection of the colonies that are to do the work. Bright yellow bees are simply worthless to use in feeding back. Dark Italians will often do pretty fair work. A cross between the Italians and the blacks comes next, but the bee *par excellence* for this work is the Simon-pure black bee. A good, strong colony is needed, and if the queen is of the current year, so much the better. A colony with such a queen will very seldom swarm, even under the stimulus of feeding, and she will not allow the bees to crowd the feed into the brood-nest. It is better, too, if the combs in the brood-nest could be of the current year, as old, black combs in the brood-nest sometimes cause the sections to show travel-stain if they are kept on the hives very long. It will pay to take considerable pains to have the right kind of bees, queen and combs, as success turns upon attention to all these details. The brood-nest should be contracted to at least the capacity of five Langstroth frames. Better work will be done if it is contracted to only three combs, but such severe contraction is at the expense of the welfare of the colony. If five combs are left, the feeding back is really an improvement to the colony.

Before putting the sections on the colonies that are to do the work, set them on other strong colonies, putting one case of sections on a hive. They will soon be filled with bees, when they can be carried, bees and all, to the colonies that are to do the work. There will be but little if any quarreling, and most of the bees will remain where they are carried. This gives a superabundance of bees—and that is what is needed. Put two cases of sections on a hive, the lower case being of the half-completed sections, and the upper one of those that are nearly completed.

The kind of feeder is important. It must be one in which there is no possibility of the bees getting drowned, or even daubed in the least; and it must be capable of examination and filling without coming in contact with the bees. My preference is decidedly for the Heddon. This covers the whole

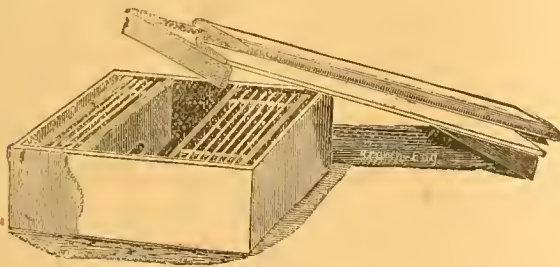

The Heddon Feeder.

top of the hive, and meets the requirements just mentioned. It is better that the first feeding be done after it is so dark that the bees cannot fly, as it excites them considerably, especially if they have been getting no honey for a few days. After the first feeding it does not matter when the feeding is done.

It is better if the honey is thinned somewhat and warmed. One quart of boiling water to 10 pounds of honey is about right. I heat 10 quarts of water until it boils, then mix it with 100 pounds of honey.

If all goes well, much depending upon the weather, some of the cases of sections will soon be ready to come off. As

during the honey harvest, I do not always wait until all of the sections in a case are sealed over. If there are only one or two in each corner, I take off the case, using the bee-escapes, and take out the unfinished sections, putting these together in another case until I get the case full, when it is, of course, returned to the bees.

As the feeding progresses I keep close watch of the characteristics of each colony. It may seem strange, but colonies that seem exactly alike in all respects often work entirely different. One will put all of the honey in the sections, seal it over quickly and smoothly, and the other will gorge the brood-nest, or plaster the honey around here and there in brace-combs, and make a regular "botch" of the whole job. As the finished sections come off, these poor workers are discarded. As a rule, there is little difficulty in getting the bees to fill the combs with honey, but to get them to seal it over quickly and smoothly is something that calls for the best of management. With only one case of sections on the hive, and continued feeding, I doubt if the sections would ever be completely sealed. So long as the honey keeps coming, the bees seem to feel that they must hold some of the cells open to receive it. They will build brace-combs, lengthen out others, build on top of sealed combs, etc. Put another case of partly-finished sections beneath the one that is nearly completed, and they will at once cap over the cells in the upper case. If a large part of the sections are all completed except capping, and a spell of hot weather comes on, better work at capping will often be done if feeding is omitted for three or four days. As the number of unfinished sections becomes less and less, and the number of colonies engaged in the work also are less in number, it may sometimes be best to use a case of the sections that are less than one-half finished, as it will be impossible to get the others all sealed over without using some others under them.

I know of only two objections to "feeding back." One is, that "fed honey" has a slightly different taste from that gathered directly from the flowers. This is not so very pronounced, but it would be noticed by one who was experienced in the matter. The other objection is that such honey will candy more quickly than that stored direct from the blossoms. When the sections are nearly completed, and feeding is resorted to simply to have them completed and capped over, the proportion of "fed honey" is so small that these objections are not very serious. If a large proportion of the honey is "fed honey," it would be well to see that it is sold in such a market that it will be consumed before the beginning of cold weather.

The advantages of feeding back can be stated in a few words. Comb honey is more salable, at a higher price, than extracted, and, if the latter can be changed into the former, at no great expense, there are quicker sales and greater profits. The greatest advantage, however, is in securing the completion of nearly finished sections. Taking one year with another, I have secured about two pounds of comb honey from the feeding of three pounds of extracted honey. With the right kind of weather and bees, I have done much better—securing four pounds for five. Flint, Mich.



Expansion of the Honey-Exchange Idea.

BY L. D. LEONARD.

In the expansion of the "exchange" idea, I believe we have a possible solution of, 1st, the overstocking of any market with the honey-product at any time; 2nd, the means of disposing of said product; 3rd, the price; 4th, adulteration.

I would have an Exchange in every State, with honey depots in every large city, under its direction. It should be the business of the Exchange to know how much honey was being produced in the State during the honey season, and also

how much the markets required for consumption. Should the supply equal the demand, then no honey would be shipped in from other Exchanges, the home product, of course, taking precedence.

The Exchange depots should be self-supporting, by regular percentage charges for all honey sold through the Exchange (made up of course by honey-producers); working through its executive officers and depot managers, it could set the price on whatever figure they wished, or thought fair and right. It could make adulteration with glucose next to impossible, for if the business was principally done through the Exchanges, suspicion would immediately attach to sales through other channels, and should adulteration be found, the Exchange should prosecute under the laws of the State; the members of the Exchange keeping a fund on hand for this purpose, the same as the Bee-Keepers' Union does in defense of its members. This would be co-operation as it is conducted to-day in other lines of business, and it seems about the only way of defense against the leeches.

I might suggest, although I am not a member of the North American Bee-Keepers' Association, that it would give that organization something practical to do if it could be made into a National Exchange, which might be simply advisory, or have a central bureau located in a central city, with an organ, perhaps, after the manner of other trades. Producers must organize in some way as a matter of self-defense, and it seems as if the "exchange" idea might be worked out with practical results.

Minneapolis, Minn.

Questions AND Answers

CONDUCTED BY

DR. C. C. MILLER, MARENGO, ILL.

[Questions may be mailed to the Bee Journal, or to Dr. Miller direct.]

Color of Brood-Combs.

Why do bees build their combs a dark brown color in the brood-chamber? I transferred a colony a few days ago from an 8-frame hive to a 10-frame one. The frames being of different size, I had to cut the comb to make it fit. Do the bees use the scraps of old comb to build combs from?

J. W. H.

ANSWER.—The reason for the dark color is that bits of the old wax are used. That is one reason given for the use of thick top-bars, the bees carrying old black wax to help seal the sections if they are too near the brood-combs.

Brimstoning Honey.

Referring to the article by C. Davenport on fumigation, on page 274, how much sulphur would be required for 100 pounds of honey in one-pound sections, sulphured after the manner he describes? One tea-spoonful level or heaping, or one table-spoonful level or heaping, or how much exactly? and how long should the lamp be left burning, how high should the flames rise of sulphur? Should the sulphur be scattered, or should it be in a heap? Would the lamp used in the Daisy foundation fastener be too large?

I am obliged to ask all these questions, as I do not wish to injure the small amount of honey I have to sulphur.

M. C. P.

ANSWER.—Referring to page 274, I confess it seems rather tantalizing to be told "one has to be very careful not to use too much sulphur, or to leave the supers on too long,

for if they do the honey will be colored," and find not a word said about the amount of sulphur, whether the size of a pea or a cocoanut, and not a word said as to whether it should be left a minute or a day. If the instruction given to your "inexperienced hand" was no more definite than that given on page 275, no wonder your honey was spoiled, Mr. Davenport, and served you right, too.

No doubt it took some experimenting to get at the right amount of sulphur and the right amount of time, and perhaps Mr. Davenport will help out by giving his practice. In the meantime, if the questioner desires to act promptly in the matter, he might try for his 100 pounds of honey half a level tea-spoonful of sulphur, letting it stay on 20 minutes after the sulphur first takes fire. That's only a guess, and it's possible it may be too much sulphur or time. If no greenish tint is seen on any part of the sections, then there's no danger of any other harm. A day or two later look and see if any worms are left alive. If any are found, give a little heavier dose of sulphur, and a little more time, and continue to increase the dose till a cure is effected. Continuing my guessing, I should say that the sulphur should be put in a heap; any lamp of the right height to fit in the box being used, and the flame kept turned up just enough to keep the sulphur burning. I should think the lamp used in the Daisy fastener would be all right.

But what under the sun do you want to brimstone your honey for? If left over from last year it hardly ought to have any worms in it. Still, no matter what it ought to do, if worms are there brimstone away.

What Ails My Bees?

I have got it, and I am now like A. E. H., of Tacoma, Wash., on page 587, of the Bee Journal for 1895. Sure enough, what ails the bees? I have the same or similar trouble with one colony of my bees. I thought at first that likely it was poisoned from some sprayed orchard bloom. I never saw anything like it in my long experience with bees. In the morning, when bees commence to fly out, there is quite a lot that can't fly, and by noon there are hundreds of them in front of the hive crawling in every direction, and trying to fly. It seems as if a great portion of them get use of their wings in the afternoon, and fly away, and those that don't or can't fly by night, are clustered on the alighting-board, or on the front of the hive, and mostly die that night, and are dragged off the next morning by the other bees. It seems A. E. H. says that they are bloated and full of that thick, yellow fluid. It seems to me like a case of constipation, as one can see many splotches where they have crawled on the grass, after which it seems as if they take their flight, and are all right. If there is any information on this line, I would like to have it.

Pollock, Mo.

A. C.

ANSWER.—If any one can offer any helpful suggestion as to the cause or cure of the trouble in this case, he will please speak out.

Closed-End Standing and Partly Closed-End Hanging Frames.

I wish you would at an early date thoroughly elucidate the respective advantages and disadvantages of the closed-end standing, and of the partly open end hanging frames—(as, for instance, Quinby, Danzenbaker, Root and Langstroth)—especially as adapted to this far Southern climate, where we have no cold in winters, and leave the hives intact out-doors all the year.

FLORIDA.

ANSWER.—It isn't an easy thing in a few words to give a full elucidation of the comparative merits of the two kinds of hives. Very likely there is much in being used to a thing, and in localities where a certain hive has been chiefly used, it might be a hard thing to convince any one that a change could be anything but a damage. One point of advantage in the closed-end frames is that there is no open space for the air to circulate around the frames as with the loose-hanging

frames. Perhaps that might not count for anything in the South, but for wintering in the North it certainly has the appearance of an advantage. Aside from that it is perhaps doubtful whether there is any difference in the two systems so far as the bees are concerned. The difference relates to the convenience of the bee-keeper, and, as already intimated, those who are used to one kind will be likely to prefer that. In handling frames, the loose-hanging frames have the advantage that one does not need to pry them apart as one does the closed-end frames.

On the other hand, there seems a growing feeling that frames should be spaced at fixed distances without stopping to adjust them to the eye. And when thus spaced, it is doubtful whether it is much more trouble to pry apart the closed-end frames than those which are partly closed, as the Hoffman. Unless some sort of spacing is used which makes the point of contact so small that the frames can be moved apart without prying, the end-bars may perhaps be as well closed their entire length.

A Question on Management for Section Honey.

I have a colony in two stories, the upper story being now solid with honey and lots of brood below. I want to get section honey from them. Shall I let them be as they are, or what shall I do? T. W. S.

ANSWER.—Very likely your colony would be better off if some of that honey had been taken away from them, for if the queen is good she would probably have been laying in some of the combs in the upper story. Possibly you may gain now by extracting some of the combs, or by taking some of them away and giving empty combs or foundation. Whether you should reduce to one story, or keep both at time of putting on sections is a question. If the combs are filled, it would seem they can hardly prevent honey going into the sections, and yet some object to having more than one story. It's a matter that needs some experimenting, and if you have more than one colony, it might be a good thing to try both ways. If you want swarms you will be more sure to get them with one story, and if you want to avoid swarming, you may be safer to keep the two stories, filling in with dummies the place occupied with empty combs, if there be any. In any case, see to it right away that there is plenty of room for the queen to lay.



The "Handy" Hive as a Large or Small Hive.

I have always used a large hive, even for comb honey, at certain periods of the season. I have used a large hive for extracting, at all times, except in winter and *early spring*. My hives hold 1000 inches of brood-combs each; and when used singly, mine is a small hive. Two of them can be put together in two seconds, and then it is a large hive. Three or more can be added in the same way, to increase the hive to any size that Mr. Dadant could possibly desire. Next season I shall run part of my colonies for extracted, and will give those colonies two hives for a brood-nest. I will put a queen-excluding honey-board on this, and then use as many hives exactly like the brood-hives, and filled with extracting-combs, as are needed to store the entire crop of honey. At the end of the white-honey season I will use an escape-board under these extracting-hives, and in one night the bees will be out of them, and there will not be a single cell of brood in them to disturb one's feelings.

Next fall, after the white honey is removed from the hives, I will put a cover on the two hives I have been using for a brood-nest, so the bees may fill it with dark honey for winter. If the fall flow is good, and more room is needed, I open the top hive and remove sealed combs of honey, and put empty ones in their place to be filled, so there will at all times be vacant room for storing all the nectar within reach of the bees. The combs of dark honey I got as above are the store from which I will draw supplies for feeding light colonies for wintering and for breeding up again next spring. In the fall, say early in October, I will take the double brood-chamber apart, and into one section of it I will put abundant stores to last the colony through the winter. The bees will be brushed from the removed hive, and that will be set in the iron curing-house, where no rats or mice can reach them to spoil the combs, for in the spring I will use them again to transform my small hive into a large one, that the system I use may be repeated again.—B. TAYLOR, in *Gleanings*.

Painted vs. Unpainted Hives.

Several years ago I had a number of box-hives, some of which were painted, while others were not. I set them out of the cellar about the first of April, in as nearly an equal condition as well could be. In the morning after every cold, frosty night, there would be water running out at the entrance of those that were painted, and on tipping them up the combs were found to be quite wet on the outside next the hive, from the condensation of moisture, while those in the unpainted hives were dry and nice, and these last increased in numbers faster and swarmed from one to two weeks earlier than did those in the painted hives. This gave a greater force of bees to work in the honey harvest, which in turn gave a larger yield of honey, and this gave more money for me to jingle in my pockets.

"But," says one, "I use ground cork, cut-straw, sawdust, forest-leaves or some other absorbent in the top of the hives to take care of the moisture, by letting any excess that may arise pass through these and out of the top of the cover." This will help much as far as the moisture is concerned, but if not done on a scientific plan it will let out much of the heat, which is so necessary for the welfare of the colony in early spring, by such a direct draft process. Even if done properly, I cannot help thinking that hives will keep bees better if unpainted. Paint is useful only so far as looks and durability are concerned, and is positively injurious as retarding the evaporation of moisture.

This is the result I have arrived at after 25 years of experience and close observation with single-walled hives, and I believe the damage to the bees is far greater than the cost of a new hive occasionally, where ordinary hives are used, say nothing of the cost of the paint or time in putting it on.—G. M. DOOLITTLE, in *American Bee-Keeper*.

"Samantha at the World's Fair."—We want to make our present readers one of the best offers ever made. All know the excellent books written by "Samantha, Josiah Allen's Wife." Well, "Samantha at the World's Fair" is probably her best, and we are enabled to offer *this book and a year's subscription to the New York "Voice"* (the greatest \$1.00 weekly temperance paper published to-day), for sending us *only three new subscribers to the American Bee Journal* (with \$3.00), provided you are *not now* a subscriber to the "Voice." Think of it—a grand book and a grand weekly temperance newspaper *given simply for sending us three new subscribers to the Bee Journal for a year!* The Samantha book is exactly the same as the \$2.50 one, only the binding is of heavy manilla instead of cloth. It is a special 100,000-copy edition, and when they are all gone, the offer will be withdrawn by the publishers. Of course, no premium will also be given to the new subscribers—*simply the American Bee Journal for one year.*

We trust our readers will now go to work, get the three new Bee Journal subscribers, send them to us with the \$3.00, and we will order the "Voice" and the book mailed to you. This is the biggest and best offer we ever were able to make.

Every Present Subscriber of the Bee Journal should be an agent for it, and get all others possible to subscribe for it.

OLDEST BEE PAPER IN AMERICA

THE AMERICAN BEE JOURNAL

ESTABLISHED IN 1861

PUBLISHED WEEKLY BY

GEORGE W. YORK & COMPANY,

118 Michigan St., - CHICAGO, ILL.

REGULAR CONTRIBUTORS :

G. M. Doolittle, of New York. Prof. A. J. Cook, of California.
 Dr. C. C. Miller, of Illinois. Dr. J. P. H. Brown, of Georgia.
 J. H. Martin, of California. Rev. E. T. Abbott, of Missouri.
 Barnett Taylor, of Minnesota. Mrs. L. C. Axtell, of Illinois.
 Chas. Dadant & Son, of Illinois.

\$1.00 a Year—Sample Copy Sent Free.

[Entered at the Post-Office at Chicago as Second-Class Mail-Matter.]

Vol. XXXVI. CHICAGO, ILL., MAY 21, 1896. No. 21.



Sweet Clover is continuing to receive kind words from various sources. Messrs. C. H. Dibbern & Son, of Milan, Ill., reported in *Gleanings* that "Farmers are beginning to find out that sweet clover is a valuable plant besides being a good honey-plant." In the same number of that paper Joseph Shaw, of Strong City, Kans., had this paragraph :

I sow early in the spring about 10 pounds of seed to the acre, with oats; but I think it is better alone. I am saving about two bushels of seed to sow in the corn at the last cultivating. I tried about four acres about the last of August, 1895, but it did not come up. Horses like it first rate when they get used to it. Bees won't work on anything else while the sweet clover is in blossom.

The "Union" and the North American.

—In *Gleanings* for May 1, both Mr. P. H. Elwood and Editor Root have something to say about the amalgamation of the North American Bee-Keepers' Association and the National Bee-Keepers' Union. In order that all may see just the line of argument used, we reproduce what they had to say. The following paragraphs are from Mr. Elwood, Starkville, N. Y.:

INACTION OF THE UNION ON THE MATTER OF ADULTERATION.

It is a pity that the Bee-Keepers' Union, while under the efficient management of Thomas G. Newman, could not have taken up the matter of adulteration. Undoubtedly it would have done so had the bee-keepers of this country thrown all their energies into one organization instead of dividing them between two. It will require a united front and some money to stop this business. At a time when the Union so much needs the cordial support of every intelligent bee-keeper of the United States, it seems unwise to refuse the admission of the North American, for this is really what this society is asking of us. The constitution advised by the amalgamation committee differs but slightly from the present constitution; and I cannot see that it will impair the usefulness of the Union, while it will bring to us a large and valuable support. The management remains the same, vested in a board of directors selected by the votes of all of the members of the Union, as at present. The popular annual meeting, if such is held, has no control over the funds of the Union—neither directs its policy nor elects any of its officers.

I can understand why the Canadians oppose the amalgamation, as they probably foresee that it will be found impracticable to make the new Union international. For several years the usefulness of the North American has been seriously

impaired, and its existence imperiled, if not shortened, by a long-continued quarrel between the Americans and the Canadians. I suggest that the present time would be a favorable opportunity to end this belligerency by each party consenting to mind its own business. By making the Union a national organization, we shall be at liberty to attend to the question of adulteration of our products, and the enactment of such laws as may be necessary to wipe it out; and if, at any future time, the board of directors conclude that the Union can assist in any way in marketing honey, there will be opportunity to do so.

It may be found practical to disseminate information as to the relative needs of different markets and different parts of the country for shipments of honey. Our weekly American Bee Journal is published at the present headquarters of the Union, and information as to the weekly receipts and further needs of the chief distributing-points could be quickly disseminated. In some such way an intelligent oversight of the markets might be had, of much service to honey-producers, with no investments, and at not a heavy expense. It would not do to use Canadian money for this purpose, nor would it be advisable for us to try to assist them in a work that they could do so much better themselves.

But more important than any exchange or possible supervision is the thorough development of a home market by every bee-keeper. The bee-keepers of this part of the country could easily sell all they produce in their home markets when such amount does not exceed a ton, and is put up in such form as to suit the demand of consumers. This would reduce the amount sent to the cities or main distributing-points, so that prices would materially improve.

Editor Root says he had this editorial written before he saw Mr. Elwood's article, and was pleased to note the harmony existing between himself and Mr. Elwood upon the subject of amalgamation :

A NEW BEE-KEEPERS' UNION.

At the risk of putting my foot in it, I am going to make another suggestion, or, more correctly, "amalgamate" the plans suggested by me before, and those suggested by Bro. York. If the amalgamation of the Bee-Keepers' Union with the North American is not wise, then don't do it. Let the North American stand just as it is. Then I would have the Bee-Keepers' Union so modified in its constitution and its plan of operation that it shall have annual meetings, elect officers, discuss problems of protection to bee-keepers, and also those that have come before the North American—in a word, take in *all* the interests that concern the honey-business.

It is evident that it is going to make trouble to try to force the amalgamation of the North American and Union. One society will have all it can do to take care of the affairs of one country, without trying to spread itself all over the continent; and a new union or society can just as well do the work formerly done by the two existing organizations.

When Mr. Hutchinson proposed the matter of amalgamation of the two societies, and the rest of us fell in with that plan, the idea, as I understood it, was not so much amalgamation as that we did not need two societies. Almost the only objection against amalgamation is the idea of making the Union international. By the plan above proposed, the Union will remain national; and yet the ultimatum that most of us desire to obtain—annual meetings, and have one society do all the work that was formerly done by the two—can be accomplished. In the meantime, the old North American can have annual meetings, or triennial meetings, as suggested by Bro. York, or disband.

We are in most hearty accord with nearly all that both Mr. Elwood and Mr. Root say. We never have seen the slightest reason for any one opposing the amalgamation of the two societies. The North American has practically said, "Take us in, and then do just as *you* please." What more could the Union want? All the opposition we have seen so far seems to have been born of misunderstandings and misconceptions of matters generally.

We might call attention to the fact that the headquarters of the Union are now in San Diego, Calif., and not, as Mr. Elwood has it, where the American Bee Journal is published—in Chicago. It was here until the General Manager (Mr. Newman) removed to California.

It does seem to us that if the benefits of amalgamation could be properly placed before the membership of the Bee-

Keepers' Union, and a vote taken thereon, it would carry with a whoop. The General Manager has favored it heartily, and we believe almost every member would, too, if each had a chance to vote upon it.

We would suggest that the Committee on Amalgamation, appointed at Toronto, get up an address setting forth some of the advantages of amalgamation, and request General Manager Newman to submit the same to the membership of the Union, accompanied by a "Yes" and "No" voting-blank. We think the thing can be settled promptly and satisfactorily very soon in this way. If the majority vote "No" on the question of amalgamation, then at the next meeting of the North American steps can be taken to re-organize on a different basis, if thought best. Surely, there is much that the Union should undertake in furthering the interests of bee-keeping, but if it adheres to its present policy of simply defending apiculturists in their rights as to keeping bees, then the North American must take up the other issues and push them to a settlement.

The Union has done a magnificent work, but we believe there are other lines that it should now advance upon. And we think that with the added benefits of amalgamation, it could go forth and win even greater victories in the future than it has in the past.

Cyprian Bees.—One of our subscribers wishes to get some pure Cyprian queens. Who knows where they can be had in this country? If any one can tell, will you please write us, and we will see that the information gets to the person desiring it.

New Subscribers to Bee-Papers.—One of our Iowa subscribers wrote us in the following strain recently, when renewing his subscription, about our endeavor to increase the number of subscribers to the Bee Journal:

MR. EDITOR:—Just a word please. If you will quit giving premiums for getting new subscribers, I will give \$1.50 a year, or \$2.00, for the American Bee Journal; or if you decrease the number of bee-keepers, and raise the price of the Bee Journal as you do so, I will pay it up to \$10. I have hurt my pocket-book badly by giving information, and even showing others how to keep bees. We have nearly ruined the business. Now I am too old to take up something new.

No, don't ask your patrons to send new subscribers, for it is their ruin. Send us a good journal, help us to keep our business paying, and make us pay you for it. *Nary more new subscribers will I ever send for a bee-paper.*

OLD SUBSCRIBER.

The foregoing letter was shown to two bee-keepers with the question, "How's that?" After reading it over, the younger said, "That is all nonsense?"

The old man looked thoughtful for a minute, and then said, "I am not so sure of that. Why is it nonsense?"

"Because," said the younger, "it won't make much difference, no matter how many new men go into the business."

"Won't it, indeed?" said the elder. "If another man sits down beside me and divides the pasturage with me when I have already as many bees as the ground will support, why isn't that a damage to me?"

"Yes, but he won't keep at it long, for the experiment will be a failure, and in a year or two he'll get out of the way."

"Very true, perhaps," said the elder, "but in the meantime I have to pay the penalty for his foolishness, and during that year or more the loss will be more to me than the cost of all the bee-journals for a lifetime." Then he went on to say:

"Bee-keepers as a rule are very liberal in their ideas, and like to give information to others, and many of them would scoff at the idea of laying a straw in the way of any one going into the business, but after all, the man who wrote that letter has only said what many a man thinks, but perhaps hasn't the courage to say. I believe in bee-journals, and believe in

increasing their circulation, but still, if their main effect is to increase the ranks of bee-keepers, I'd rather pay \$5 or \$10 a year for a good paper and have it confined strictly to those who have 25 colonies of bees or more. That is nothing more than is done in other lines of business. There is a florist's paper published right in the city of Chicago, and if you send the subscription price for the paper, your money will be promptly returned to you, unless you furnish satisfactory proof that you are a professional florist. No matter how valuable the information contained in that journal might be to you as an amateur cultivator of flowers, you can't come in. Now, if that's all right, why isn't it right for those who make their bread and butter out of their bees to try all they can to keep out those who will do little more than make a failure and spoil the markets for others?"

Evidently, like most other great questions, this one has two sides to it. With all the liberal-mindedness that bee-keepers in general possess, it is only human nature to look out for number one. But it does not necessarily follow that increase of subscribers means increase of dabblers in bee-keeping. There are thousands already in the business who take no paper on bee-keeping, and it is from this class that recruits are obtained, not one in a thousand subscribing for a bee-paper until *after* he has become a bee-keeper. Is it not a fact that more harm is done to the business by the ignorant than by the well-informed? And when a man is already in the business, is it not better that he should take a bee-paper, so as to be shifted from the ranks of the ignorant to those of the well-informed?

Admitting for the sake of argument that "Old Subscriber" has the right view in thinking that it would be better to have a limited number of subscribers at a large price, the question is how that could be brought about. The man who should start a journal with a circulation of only 1,000, at a subscription price that would afford a living, would only invite certain failure. If our friend will *guarantee* us a circulation of 1,000 at \$10 each, or 4,000 at \$2.50 each, we stand ready to make an agreement. But suppose that could be done, how much would be accomplished? For it would only make the difference of having other papers catch the new subscribers, and how much would be gained?

When our friend looks at the matter fairly, he will probably see that beginners will continue to enter the ranks, and that they enter the ranks *before* they become subscribers, and the publisher who has at heart the best interests of his readers will do all he can to increase his circulation, that he may thereby afford to give them all a better paper.

The Position of Apiculture among other pursuits is sometimes belittled by those who are not well-informed about its progress and development during the past half century. Mr. P. H. Elwood, in commenting on this subject in a recent issue of *Gleanings*, called attention to the fact that apiculture has a record and history of which no one need be ashamed. He said:

The history of apiculture is a record we need not be ashamed of. "Langstroth on the Honey-Bee," written more than a third of a century ago, was the ablest and the best written hand-book that had appeared upon any rural pursuit, and there are very few works at the present time that will bear comparison with it. The first volume of the *American Bee Journal* occupies nearly the same position among rural journals. The invention of the honey-extractor antedated by nearly a score of years the invention of the centrifugal cream-extractor; and but for the former, the latter might never have been thought of. Comb foundation, zinc excluders, the bee-escape, smokers, etc., bear favorable comparison with agricultural inventions. The discovery of parthenogenesis, by the blind Huber, followed since by the unraveling of so many of the scientific mysteries of the bee-hive, makes a record not surpassed in any branch of husbandry. In literature, in invention, in discovery, or even in practical results, we do not fear comparison with any branch of agriculture. There is no need of belittling the pursuit because a few of us are not well posted.

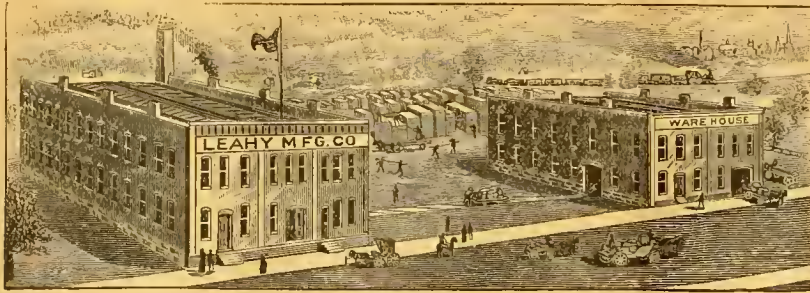

Largest Factory in the West COMPLETE STOCK. Good Supplies and Low Prices — Our Motto.

READ THIS—Mr. Keyes says: The 100 pounds of Extra-Thin Foundation you sent us is superior to anything he ever saw; and I think the same. R. L. TUCKER, Wewahitchka, Fla.
Dear Sirs:—The Sections came duly to hand. Indeed, they are very nice. Yes, sir; they are as good as the best. CHARLES H. THIES, Steeleville, Illinois.

Leahy Mfg. Co.:—I have received the bill of goods. I must say they are the choicest lot of Hive-Stuff I have ever received from any place. I admire the smoothness of your work, and your close selection of lumber. Yours very truly, O. K. OLMSTEAD, Orleans, Nebr.
Dear Sirs:—The Sections arrived in due time, and are all O. K. so far as examined. They are simply perfection. I can't see how you can furnish such goods at such low prices. I hope you may live long and do well. Yours respectfully, Z. S. WEAVER, Courtney, Tex.

Gents:—I received the "Higginsville Smoker" all O. K. It's a dandy; please find enclosed stamps for another. Yours truly, OTTO ENDERS, Oswegatche, N. Y.
Gentlemen:—I have bought Supplies from nearly all the large manufacturers by the carload, and I must say yours are as good as the best. Indeed, in many lines they are the best. It is a pleasure to handle them. E. T. FLANAGAN, Belleville, Illinois.

The above unsolicited testimonials are a fair sample of hundreds we receive. Our prices are reasonable and the "Higginsville Goods" are the best.
The "Higginsville Goods" are for sale by the following parties:
Chas. H. Thies, Steeleville, Ill. E. T. Flanagan, Belleville, Ill.
Henry L. Miller, Topeka, Kans. E. A. Seeley, Bloomer, Arkansas.
J. W. Rouse & Co., Mexico, Mo. P. J. Thomas, Fredonia, Kans.
Fulton & Gregg, Garden City, Kans. W. J. Finch, Jr., Springfield, Ill.
If you need a Carload of Supplies, or only a Bee-Smoker, write to us. Remember, we are here to serve you, and will, if you give us a chance. **A Beautiful Catalogue Free.**
Address, **LEAHY MANUFACTURING CO., HIGGINSVILLE, MO.**
49A *Mention the American Bee Journal.*

General Items.

Outlook for an Old-Time Honey-Year.

Never in all my bee-keeping experience have I seen the bees in as fine a condition as they are at this date. Hives are full of brood and young bees. Fruit-bloom has been immense. The bees have had a chance to work every day since spring commenced. I am sure I will have swarms the first week in May, and heretofore I never had a swarm before May 30. The outlook is good for an old-time honey-year.

CHAUNCEY REYNOLDS.
Fremont, Ohio, April 30.

A Beginner's Report.

I built a new bee-repository last fall, 10x10 feet, with 28 inches filled with sawdust. It is close to my shop, so the door into my repository opens into the shop on the north side. Once a month I opened the door for 15 or 30 minutes for ventilation. I took the bottom-boards off all but one hive, and raised it one inch; its colony came out the best of all, but the rest are in good condition.

On Nov. 21, 1895, I put in 14 colonies, and April 15, 1896, I took out the 14, all in good condition.

I have one colony of leather-colored Italians, five of 5-banded, three of 3-banded, and five of our own native bees. I started last year with five colonies; had two natural swarms, and divided the rest. I bought four queens, and reared four. I use the Langstroth hive.

CARL TAYLOR.
Harrowsmith, Ont., April 23.

A Robbing Experiment, Etc.

The result of an experiment I have just completed is as follows: Two weeks ago yesterday, I opened the hive of a colony of bees that I knew were very weak, and found that there were not more than enough bees to cover a space six inches square, but as they had a very nice queen and a hive full of honey, I closed them up again to see if they would not build up in numbers as soon as the weather was warm enough for them to rear brood. There were eggs, but no brood in the hive. About five hours later I found the hive in an uproar with robbers. I gave them a good smoking, and as soon as the bees stopped coming out and started in again, I closed up the hive tight, and did not open it again for two days. In a very little while they were robbing as badly as before, and when I thought the hive had as many robber-bees in it as there were likely to be at any one time, I closed it up again, and kept it closed six days, until no bees were flying about the outside of the hive, and then opened it in the morning, and those robber-bees came quietly out, and went to work bringing in pollen, guarding the hive, and so on, just as though they were hatched and reared in that hive. This morning I found sealed brood and eggs, and brood in all stages, and three or four times as many bees as when I looked it through before.

I have 23 colonies out of 28 last fall, 15 unusually strong, 5 of fair strength, and 3 weak. I wintered them by putting all the hives but three on the south side of a tight board-fence, with a can-

PATENT WIRED COMB FOUNDATION

Has No Sag in Brood-Frames

Thin Flat-Bottom Foundation

Has No Fishbone in the Surplus Honey.

Being the cleanest is usually worked the quickest of any Foundation made

J. VAN DEUSEN & SONS,
Sole Manufacturers,
Sprout Brook Montgomery Co., N. Y.

Mention the American Bee Journal

Dadant's Foundation
in Chicago!

No other Goods kept here. Send for Price-List,

CHAS. DADANT & SON,
118 Michigan St., CHICAGO, ILL.
13A tf Please mention the Bee Journal.



ONE MAN WITH THE UNION COMBINATION SAW

Can do the work of four men using hand tools, in Rippling, Cutting-off, Milling, Rabbeting, Grooving, Gaining, Dadoing, Edging-up, Jointing Stuff, etc. Full Line of Foot and Hand Power Machinery Sold on Trial. Catalogue Free.

SENECA FALLS MFG. CO.,

46 Water St., SENECA FALLS, N. Y.
1A1y *Mention the American Bee Journal.*

BEEES. QUEENS,
and Several Carloads of
APIARIAN SUPPLIES

always on hand.
Brood Found., 42c lb.; Section, 50c lb.

I. J. STRINGHAM,
105 Park Place. NEW YORK, N. Y.

That Queen-Clipping Device Free!

Works Like a Charm.

The Monette Queen-Clipping Device WORKS LIKE A CHARM. With it I have clipped 30 queens, all in one day, when examining my bees. WM. STOLLEY, Grand Island, Nebr.

Couldn't Do Without It.

I have clipped 19 queens, and must say the Monette Queen-Clipping Device is by far the best invention ever made, and will be welcome to many bee-keepers as it was to me. I could not do without one now.

DR. GEO. LACKE, Newburgh, Ind.

PLEASE READ THIS OFFER TO PRESENT SUBSCRIBERS:

Send us just one new name for the American Bee Journal a year (with \$1.00), and we will mail you the Queen-Clipping Device FREE of charge. Or, the Queen-Clipping Device will be sent postpaid for 50 cts. But why not get it as a Premium by the above offer? You can't earn 50 cts. any easier. Almost every bee-keeper will want this Device. See page 130 (Feb. 27) for full description of it. Complete directions accompany each one sent out. It is a most ingenious and useful article. Address,

GEORGE W. YORK & CO., 118 Michigan St., Chicago, Ill.

BUY "DIRECT FROM FACTORY," BEST MIXED PAINTS

At WHOLESALE PRICES, Delivered FREE For Houses, Barns, Roofs, all colors, and SAVE Dealers profits. In use 54 years. Endorsed by Grauge & Farmers' Alliance. Low prices will surprise you. Write for Samples. O. W. INGERSOLL, 289 Plymouth St., Brooklyn, N. Y.

12A13 Mention the American Bee Journal

MURDERED

We have killed high prices. Give me a trial order and be convinced that good Queens can be reared for 50 cts. each. Untested, 50 cts.; Tested, 75 cts. Golden Italians. 3-Banded Italians, and Silver-Gray Carniolans, all the same price. Best of References given.

C. B. BANKSTON,

13Atf CHRISMAN, Burlison Co., TEX.

Mention the American Bee Journal.

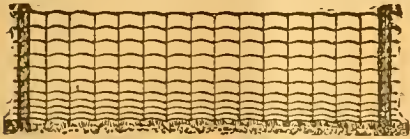

BETTER THAN IS TO I.

We are constructing 14 miles of fence for a Michigan railway. As an inducement to sell right of way, farmers were given choice of fences. All but two preferred the Page. An elastic fence supported by such solid facts is invincible.

PAGE WOVEN WIRE FENCE CO., Adrian, Mich.

WHEN ANSWERING THIS ADVERTISEMENT, MENTION THIS JOURNAL.

A New Method

of refining wax without acid.

Result Better

Comb Foundation.

My prices are also the lowest.

A Job-Lot of No. 2

Polished Sections

Equal in finish to any No. 1's. 1 M, \$1.75; 2 M \$3.40; 3 M, \$4.80; 5 M, \$7.50. Or I can furnish a cheaper quality. Also, a full line of

HIGGINSVILLE SUPPLIES.

See my List with prices.

W. J. FINCH, Jr., SPRINGFIELD ILLS.

Mention the American Bee Journal.

IF YOU WANT THE

BEE-BOOK

That covers the whole Apicultural Field more completely than any other published, send \$1.25 to Prof. A. J. Cook, Claremont, Calif., for his

Bee-Keeper's Guide.

Liberal Discounts to the Trade.

California

If you care to know of its Fruits, Flowers, Climate or Resources, send for a Sample Copy of California's Favorite Paper—

The Pacific Rural Press

The leading Horticultural and Agricultural paper of the Pacific Coast. Published weekly, handsomely illustrated, \$2.00 per annum. Sample Copy Free.

PACIFIC RURAL PRESS,

220 Market St., - SAN FRANCISCO, CAL.

TEXAS QUEENS.

If you are in need of Queens, let me have your order. Price-List Free.

8A26t J. D. GIVENS, Lisbon, Tex.

Mention the American Bee Journal.

was awning over it, as close together as they would go, and two rows deep, the lower row on the summer stand, which is two 2x4 scautings on posts 15 inches high; no packing of any sort. The hives I left out are single-walled; I made no change in them at all, and the bees in them came through as well as any. Those I lost were too weak to keep warm.

By the way, the next day after the last cold snap this spring, I brushed all the bees, including the queen (of the hive referred to at the first of this letter), off the frames on the ground, thinking they were frozen to death, and then when the sun shone on them, and they began to crawl about, I gathered them up again and put them back into their hive.

I think the bees are getting all the stores they are using, as I have had hard work to use up the frames of honey from the five hives from which the bees died, and in order to use the last two frames, I took out one frame of brood and shook all but two or three bees on each side of it off, and put it into one of the three weak colonies; they at once killed and threw out their queen. What was the matter? If I had left any bees on the frame, I should lay it to them. One of the colonies I lost was a case of foul brood; they were of medium strength. I killed their queen, put the bees into another hive with a weak colony and no brood, extracted the wax, and made a bonfire of the frames, hive, top, bottom and all. The colony I united the bees with, have sealed brood now, with no sign of foul brood, and there is not a trace of it in any of my other hives.

This spring is the most favorable for bees we have had here for at least six years.

E. L. DUNHAM.

Greeley, Colo., May 2.

A Stingless Joke.

One of as old a bee-men as we have here was with me looking at my bees, and one dabbed him on the cheek. He pulled out the sting, turned to me, and said: "That will be a drone; it lost its sting." And I could not convince him that he was not right.

Pollock, Mo.

ANDREW COTTON.

The Wintering Problem.

Having just passed my fifth experimental year in wintering bees, I will briefly rehearse my method of preparation and report results.

In the fall, about the time the brood is hatched, I examine every colony I intend to winter, taking out every frame, and making a careful estimate of the amount of honey. If any colony is short of 30 pounds, I feed sugar syrup—not percolated—until they have fully that amount. This insures them honey enough till the flow commences in the spring. My observation teaches me that colonies with plenty of stores in the hive, in the spring, will build up faster and be stronger than colonies with scanty stores, and fed to stimulate them. I know I should have better courage for labor, with my cellar and granary filled with a competence, than I should to depend on small items coming in from uncertain and unknown sources. Is it not so with bees? Living from hand to mouth is not indicative of prosperity. My bees build up well and early, always

ready for early fruit-bloom. They know nothing about spring dwindling, neither do I, except what I read in the journals.

Before feeding in the fall, I see that every colony is strong in bees. This I secure by uniting. Last fall I reduced 43 to 20 colonies, thus saving all my bees.

I winter them on the summer stands, putting an outside case over every hive, packing the enclosed space with planer-shavings, or some other dry, porous substance. Over the frames I place a dry, porous cushion. I placed a sealed cover (that is, if the bees would seal it) over a few of the colonies; I see but little difference in their condition, but would give the preference to the porous cushions. I leave the entrances open, shaded by a board leaning against the hive.

From the 12th to the 16th of this month I examined every colony, finding every one strong in bees, with ample stores, seeing either a queen or capped brood in every colony. My bees are now working finely, bringing in natural pollen.

As far as I learn, in this and adjoining towns, losses range from 25 to 100 per cent.

J. P. SMITH.

Sunapee, N. H., April 25.

Bees Have Done Well.

Bees have done well the last two weeks, but it is getting dry now. I have 32 colonies, two being stolen about a month ago. I don't think they are doing very well. I got a little over 1,000 pounds of honey last year from 30 colonies—about one-third comb honey, and the balance extracted.

L. V. MILLIKAN.

Spiceland, Ind., May 6.

Poor Season in Australia.

This season was a very poor one in Australia. The Australian Bee-Bulletin reports few bee-keepers doing first-rate. But I don't hear of anybody in Queensland having much surplus this season, even our leading bee-keeper—H. L. Jones, in Goodna—wrote that he has had terrible trouble in queen-rearing this season.

E. HANSEN.

Rockhampton, Queensland, Australia.

Sweet Clover Hay—A Correction.

Owing to pressing business, I had lately somewhat neglected reading the American Bee Journal, and thus was not aware of the request to state as to the amount of sweet clover hay I had made, it being understood by some that I had 200 tons of it, and to tell how to treat sweet clover for hay.

Dr. Miller, on page 259, has it right. I have never said that I had 200 tons of sweet clover in one year, but of hay of all kinds. The entire area I have in sweet clover is about 10 acres, of which but 6 acres were cut but once, giving me about 20 tons of hay.

I think that I fully explained in my article on sweet clover, how it should be treated when used for hay. (See page 806, for 1895.) Also Mr. John McArthur, on page 243, describes correctly how it should be treated, and those interested can read it there.

I gather all my hay with a hayloader, which is the most economic way of securing it, particularly clover. So as not to lose the leaves, the cured melilot,

Abbott's Space.

The "St. Joe" stands at the TOP.
Dovetailed Hives VERY CHEAP.
Dadant's New Process Foundation at
Dadant's prices, WHOLESALE and RETAIL.

Sections as low as the lowest for good goods.
Send for Circular and say what you want.
Special Agent for G. B. Lewis Co.'s goods. Write for prices.
E. T. Abbott, St. Joseph, Mo.

SECTIONS CHEAP!

In order to reduce stock we will sell
40,000 4¼x4¼x2 40,000 4¼x4¼x1 15/16 250,000 4¼x4¼x1½
150,000 4¼x4¼x1¾ 80,000 4¼x4¼x7-to-ft,

Of our No. 2, One-Piece, Open-Top Sections, at the following **Low Prices:**
1,000 for \$1.00; 3,000 for \$2.50; 5,000 for \$3.75.

These Sections are all of good quality and manufacture, and prices will be maintained for a short time only.

G. B. LEWIS CO., WATERTOWN, WIS.

Be sure to mention the American Bee Journal when you write.

Sweet Clover 1/4 Canada.

At the following prices:

5 lbs.	10 lbs.	25 lbs.	50 lbs.
\$1.00	\$1.60	\$3.75	\$7.25.

Also a quantity of Motherwort and Catnip seed. Prices on application.

EGGS for Hatching. Buff Leghorns, Indian Games, & Light Brahmans. Choice Birds. A breeder for 30 years. Prices on application

JOHN McARTHUR,

881 Yonge Street, TORONTO, ONT.
15 Atf *Mention the American Bee Journal.*

J. W. TAYLOR

—HAS THE BEST—

Italian Queens for Sale

Untested, ready now, 75c. apiece; 6 for \$4.25, or 12 for \$8.00. Tested, \$1.25. Select Tested, best, \$2.00. Pay for Queens on arrival. I guarantee safe arrival and satisfaction.

14A9t **OZAN, AUK.**
WHEN ANSWERING THIS ADVERTISEMENT, MENTION THIS JOURNAL.

Honey-Clovers & Buckwheat SEED FOR SALE.

We have made arrangements so that we can furnish seed of several of the Clovers and Japanese Buckwheat, by freight or express, at the following prices, cash with order:

	5lb	10lb	25lb	50lb
Alsike Clover	\$.70	\$1.25	\$3.00	\$ 5.75
Sweet Clover	.75	1.40	3.25	6.00
White Clover	1.25	2.00	4.50	8.00
Alfalfa Clover	.65	1.10	2.70	5.00
Crimson Clover	.55	.90	2.00	3.50
Jap. Buckwheat	.20	.35	.90	1.25

Prices subject to market changes.

Add 25 cents to your order, for cartage, if wanted by freight.
Your orders are solicited.

GEORGE W. YORK & CO.,
CHICAGO, ILLS.

AWAY UP IN

the air the current is strong and powerful. We have the mill that will utilize it to best advantage, and our four cornered double braced steel tower will hold it there. Perfectly galvanized. Many sizes. Only one quality—**THE BEST.** Tanks, Shellers, Cutters, Pumps, Horse Powers, etc. Write for illustrated catalogue, **FREE** CHALLENGE WIND MILL & FEED MILL CO., BATAVIA, ILLINOIS, No. 18 River Street.



Mention the American Bee Journal.

BEGINNERS.

Beginners should have a copy of the Amateur Bee-Keeper, a 70-page book by Prof. J. W. Rouse. Price 25 cents; if sent by mail, 28c. The little book and the Progressive Bee-Keeper (a live, progressive 28-page monthly journal) one year, 65c. Address any first-class dealer, or

LEAHY MFG. CO., Higginsville, Mo.

For Sale HOME, APIARY, —QUEENS.—

1/2 Block of ground, some fruit, good 6-room dwelling, shop, stable, honey-house and poultry-house (over 3,000 square feet of floor), 100 colonies of bees in chaff hives and fully equipped for comb honey, all in town of 1000 population and good alfalfa range and good water. Price, \$3,000. If unsold June 15th, will unqueen, and offer 2 year clipped queens at 25c.; 1 year, unclipped, at 50c. each. July 15th and after, young queens at 60c. each—all Italian and safe arrival guaranteed. This is a rare bargain, but I must get my wife to a lower altitude. Book your orders at once if you want these queens.

19Atf **R. C. AIKIN, Loveland, Colo.**



Promptness Is What Counts!

Honey-Jars, Shipping-Cases, and everything that bee-keepers use. **Root's Goods at Root's Prices,** and the best shipping point in the country.

Dealer in Honey and Beeswax. Catalogue Free.

Walter S. Ponder

162 Mass. Ave. INDIANAPOLIS, IND.

Mention the American Bee Journal.

Queens for Sale

Italian Queens—after May 15—Untested, 75c. each; 6 for \$4.00; 12 for \$7.20.

Safe arrival and satisfaction guaranteed.

Reference—George W. York & Co. Address,

F. GRABBE,
LIBERTYVILLE, ILL.,

Mention the American Bee Journal.

HONEY We have a large amount of Pure No. 1 Alfalfa we will sell cheap.

Wax Wanted.

Boss bee-escape Warranted the best, simplest and quickest Escape on the market. Sent postpaid to any address for 30 cts. It can be returned at our expense if it is not as represented, or we will send the Escape on trial to any bee-keeper wishing to test it in good faith. We are agents for the

Ferguson Patent Hive Super and Wicket-Gate Hooney-Board, with the Escape. It is the easiest, quickest hive to handle for the production of comb honey. Address,

E. S. LOVESY & CO.,

355 6th East St., SALT LAKE CITY, UTAH.

Mention the American Bee Journal. 9Atf

Canada Up-to-date Bee-Supplies

at rock-bottom prices. Send for my annual Circular. A 12-inch Root Fdn. Mill in good order, 2nd hand, at a bargain for either Wax or Cash. Address,

W. A. CHRYSLER, Chatham, Ont.

19A4t *Mention the American Bee Journal.*

or sweet clover hay, must not be brittle when taken, and on hot days only part of the forenoon and the latter part of the afternoon is the proper time to work it. The more freely salt is used on each layer of hay, the better it will keep, and the better stock will relish it.

We have had glorious rains thus far, fully 9 inches since March 23. I consider my bees now fully "out of the woods," and have no winter losses nor fatal spring dwindling to report. I have two extra combs with honey still in reserve for each colony, should a late frost kill fruit and other bloom. I have a considerable amount of motherwort, matrimony-vine and catnip growing, which is of great help to the bees. The hardest and most critical time for my bees comes in June, but ends as soon as alfalfa, and in particular sweet clover, begins to bloom. **WM. STOLLEY,**
Grand Island, Nebr., April 28.

Not a Flattering Prospect.

The prospect so far for a crop of honey is not flattering. The bees gathered but little honey from fruit-bloom, on account of the high winds that prevailed during the bloom, although they appear to be in a healthy condition. There is a fine prospect for white clover, and we may get some honey from that.

JAS. W. WILLIAMS,

Appleton City, Mo., May 1.

Helping the Honey Market, Etc.

The excellent and sensible article of Mr. Abbott, on page 273, needs no comment from me, but some things will bear being said over and over again. One of the ideas that many bee-keepers need to get out of their heads as soon as possible, is that "honey is honey." Honey isn't honey by a long shot in the way that is meant generally by that expression, that is, that all honey is alike, and that it makes very little difference what kind of stuff you put on the market as honey, only so you can honestly say it was stored by the bees. Particularly is this true of extracted honey. While it may be true that a large part of the public can't tell one kind of honey from another, and don't know when a poor article is palmed off upon them, yet they do know that they don't greatly relish it, and, thinking that all honey is alike, they conclude they don't care for honey, and so don't buy any good or bad. If I may be allowed to judge from what I have seen at various times, I should say that three-fourths of the extracted honey put on the market never should have been offered as an article for the table. But extracted honey thoroughly ripened and properly cared for will make a market for itself, with anything like a fair chance.

THAT REPORT.—On page 280, the editor tries to lick into shape a report that some illiterate person had succeeded in getting into print. If the editor had stopped to consider how the feelings of the budding writer might be all torn up by such editorial criticism, the said editor would have kindly taken the said writer by the hand and asked him whether he meant exactly what he said. Lest the youthful writer may be so utterly crushed by the remarks made, that he will make no attempt at reply, it may be a charitable act on my part to

The Bee-Keepers' Guide:

Or Manual of the Apiary,

By Prof. A. J. Cook.

This 15th and latest edition of Prof. Cook's magnificent book of 460 pages, in neat and substantial cloth binding, we propose to give away to our present subscribers, for the work of getting new subscribers for the American Bee Journal.

A description of the book here is quite unnecessary—it is simply the most complete scientific and practical bee-book published today. Fully illustrated, and all written in the most fascinating style. The author is also too well-known to the whole bee-world to require any introduction. No bee-keeper is fully equipped, or his library complete, without "THE BEE-KEEPER'S GUIDE."

Given For 2 New Subscribers.

The following offer is made to PRESENT subscribers only, and no premium is also given to the two new subscribers—simply the Bee Journal for one year.

Send us **Two New Subscribers** to the Bee Journal (with \$2.00), and we will mail you a copy of Prof. Cook's book FREE as a premium. Prof. Cook's book alone sent for \$1.25, or we club it with the Bee Journal for a year—both together for only \$1.75. But surely anybody can get only 2 new subscribers to the Bee Journal for a year, and thus get the book as a premium. Let everybody try for it. Will you have one?

GEORGE W. YORK & CO.,
CHICAGO, ILLS.

A Bargain—EARLY QUEENS.

119 Colonies Italian Bees in Chaff Hives: two acres land; good house; excellent well.

Early Queens—Tested. \$1.00; Untested. 50c. Sent by return mail.

E. L. CARRINGTON,
16Atf PETTUS, Bee Co., TEX.

Reference—1st National Bank of Beeville.

Mention the American Bee Journal.

CARLOADS



Of Bee-Hives, Sections, Shipping-Cases, Comb Foundation, and **Everything** used in the Bee-Industry.

I want the name and address of every Bee-keeper in **America**. No reason why you cannot do business with me. I have Cheap Lumber and Experienced Workmen; a good Water-Power Factory and know how to run it. I am supplying Dealers as well as consumers. Why not you? Send for Catalogues, Quotations, etc. **W. H. PUTNAM,**
1E RIVER FALLS, Pierce Co., WIS.

Mention the American Bee Journal.

Page & Lyon Mfg. Co.,

NEW LONDON, WIS., operates two saw-mills that cut, annually, eight million feet of lumber, thus securing the best lumber at the lowest price for the manufacture of bee-keepers' supplies. They have also just completed one of

The Largest Factories,

and have the latest and most improved machinery for the manufacture of Bee-Hives, Sections, etc., that there is in the State. The material is cut from patterns, by machinery, and is absolutely accurate. For Sections, the clearest and

The Whitest Basswood

is used, and they are polished on both sides. Nearness to pine and basswood forests, and possession of mills and factory equipped with best machinery, all combine to enable this firm to furnish the best goods at

The Lowest Prices. ♡ ♡

For instance, it has a job lot of 200,000 No. 2 Sections that will be sold at 50c. per 1,000; or 2,000 Snow-White Sections will be sold for \$4.00, and larger quantities at still lower prices. Send for Circular and see the prices on a full line of supplies. 16Atf

Mention the American Bee Journal.

make some attempt at explanation for him. Here is the item that drew the editorial fire:

"My bees were taken out of the cellar in fine shape March 20. Only 2 dead out of 157; but a lot more may die before June."

Upon this the editor remarks: "We should presume.....their 'shape' shouldn't change much during the winter." It may not be amiss to remark to the critical editor that it is well to do so promptly as possible anything that one "should" do, and if he felt any obligation to presume why didn't he at once presume without saying he should do so. "He probably meant" "We presume;" and it is possible that instead of "shouldn't change," he meant "wouldn't change." "Why don't people say what they mean?"

As to the change of shape, experience shows too often that bees undergo a very decided change of shape in the course of the winter. They go into the cellar slender in form, but if they winter poorly, they come out with abdomens of aldermanic proportions, so whether their shape "should" change or not, as a matter of fact all too often it does change.

If the statement had been made that the bee-keeper lost two out of three of his bees, the editor would probably have understood that two-thirds of his bees were dead, and in the same way he should understand that "2 out of 157" means 2/157, or that 2 out of every 157 bees died.

"But then, he says he put in only 157 bees." I think, Mr. Editor, he says nothing of the kind. Indeed, he says nothing about the number of bees he put in the cellar, whether he put them in at all, or whether they flew in of their own accord. He only says that for every 157 bees 2 died.

Now, Mr. Editor, if there is anything that isn't entirely clear to you in this statement, don't hesitate to ask any questions you like. I'm used to answering questions. It isn't necessary to enclose a stamp with questions.

Marengo, Ill. C. C. MILLER.

[Yes, there are two or three questions we'd like to ask, but we don't know whether it is entirely safe to do so. But we'll take our chances. Doctor, how does it come that you take such an interest in the feelings of the "illiterate" "budding writer" you refer to? It seems to us that any "charitable act" you may feel like doing, could be more profitably placed.

We'll not ask any more questions just now, but wait until we can "take you by the hand," and ask them, for then it will not be necessary for either of us to use stamps.

By the way, the one question we have asked, you need not answer; simply think it over, and have your answer ready to "hand" to us when we have you "by the hand."—Ed.]

Toronto Convention Report has been issued in pamphlet form, and will be mailed from the Bee Journal office for 25 cents. Better have a copy, if you have not read it. Only a limited number of copies were bound.

✦ MONEY SAVED IS MONEY GAINED. ✦

THE ROYAL UNION Life Insurance Company DES MOINES, IOWA.

The Iowa Policy

Is one that definitely promises to keep an accurate account with you; credit your premiums and interest, charge the actual expense and mortuary cost, and hold the remaining funds subject to your order.

Agents Wanted.

JOHN B. KING, GENERAL AGENT,
Suite 513 First Nat'l Bank Bld'g.

20Atf CHICAGO, ILL.

Mention the American Bee Journal.

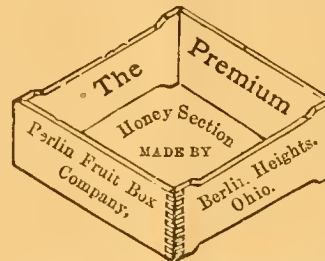

—BEE-SUPPLIES—
and all kinds of Boxes, Berry-Crates, and Baskets. We make a specialty of 1-piece Sections & Wood Separators

Address, **BERLIN FRUIT-BOX CO,**
28 EAST BERLIN HEIGHTS, OHIO.

Mention the American Bee Journal.

The Patent Wood-Veneer Foundation.

Bee-keepers should give it a test, and my All-Wax Foundation. I will guarantee there is no better made, as six years ago I discarded the old way of dipping for wax sheets, and a new invention of my own was discovered, which enables me to make the toughest kind of Foundation; also, no acid used to purify the Beeswax, and it preserves the smell of honey, which is more acceptable to the bees. Now is the time to send wax and have it worked up at low prices. Send for Samples and Catalog with low prices. Wax wanted at 31c cash, or 33c trade, delivered.

AUG. WEISS, Hortonville, Wis.
12A15t Please mention the Bee Journal.

Mention the American Bee Journal.

1,000 Teachers' Oxford Bibles

Were bought for spot cash by a Chicago firm from an Eastern publisher who was about to be driven to the wall for the want of ready money. More than a million of these same Bibles, in every way like the illustration, have been sold during the past few years at three times the money we ask for them.

They are the genuine Teachers' Oxford Bibles, Divinity Circuit, round corners, gilt edges, complete teachers' helps, maps, 1,350 pages, bound in French seal limp, with perfectly flexible backs. Sent prepaid.

Regular price, \$4.50; our price, \$2.25. Or we club it with the Bee Journal for one year—both for only \$2.75; or we will give this fine Bible free as a premium to any one sending 4 new subscribers to the Bee Journal one year (with \$1.00). No additional premium is given the new subscribers—simply the Bee Journal one year to each of them.

GEORGE W. YORK & CO.,
CHICAGO, ILLS.

Please Send Us the Names of your neighbors who keep bees, and we will send them sample copies of the BEE JOURNAL. Then please call upon them and get them to subscribe with you, and secure some of the premiums we offer.

FULL COLONIES

Of Italian Bees for \$4.00. Are worth twice the money. Queens bred from fine imported mother. Langstroth frames: 10-frame hives. All combs built on foundation in wired frames and perfect. Can't possibly break down in shipment. I have been keeping bees as a specialty for many years, and wish to retire from business. A rare chance to get superior colonies cheap. No circular. Send the price and get your bees. See the following from Mr. T. C. Potter, Indianapolis, Ind.:

"April 21st, 1896. Mr. T. H. Kloer. Dear Sir:—The colony of bees came last evening. It is perfectly satisfactory. In fact, I have bought bees off and on for 15 years, and do not know that I ever have purchased a nicer colony at the time of year, or for such a moderate price. . . . I found the queen readily. The bees were very gentle, not one offering to sting. So I fancy I have a gentle strain—just what I wanted. Now I thank you very much for giving me a good colony for so small a price, and for packing them so that they could be opened up so readily. . . . If any one wants recommendation, refer to me."

Address, **T. H. KLOER,**
426 Willow St., TERRE HAUTE, IND.
20Atf *Mention the American Bee Journal.*

Sections & Foundation Reduced.

I am now selling Root's best polished **SECTIONS** at \$2.50 per 1,000; 2,000 for \$4.50; 3,000, \$6.45; 5,000, \$10.00. **The New Weed Process Comb Foundation** reduced 3c. per pound. See prices on page 14 of our Catalogue, or The A. I. Root Co.'s

M. H. HUNT,

19D4t BELL BRANCH, MICH.
Mention the American Bee Journal.

Cheapest, 1st-Class, 60 cents

Smoker, 2-inch fire-pot, bent nose, and all the new improvements—a genuine Bingham. Has pleased every one for 15 years. Per mail, 60 cts **T. F. Bingham, Farwell, Mich.**
23Ctf *Mention the American Bee Journal.*

New England Supply Depot!

You can get the most complete Bee-Hive, also other Supplies, at—**H. ALLEX'S,**
Room 5, 82 Water St., BOSTON, MASS.
13D4t *Mention the American Bee Journal.*

W. H. BRIGHT'S

CIRCULAR FOR 1896, describes everything needed in the apiary. Bees, Queens, Hives, Sections, Spraying Pumps, and Bright's Comb Foundation, sold at bottom prices. Send for one free.

Wm. H. BRIGHT,

17D4t MAZEPPA, MINN.
Mention the American Bee Journal.

Hives & Combs For Sale.

45 10-frame Langstroth Hives, two-story, for extracting, as made and sold by T. G. Newman. These are empty—no frames—are well packed, and have been kept in the bee-house. Price, 75 cents each.

Also, 400 Brood or Extracting Combs for the above hives; they have the triangular top-bar as made by Newman. They are clean and in good condition. Price, \$15.00 per 100. I would take \$85.00 for the whole lot of Hives and Combs.

Reference—American Bee Journal.

W. C. LYMAN,

20Atf DOWNER'S GROVE, ILL.
WHEN ANSWERING THIS ADVERTISEMENT, MENTION THIS JOURNAL.

MUTH'S HONEY EXTRACTOR

PERFECTION

Cold-Blast Smokers,

Square Glass Honey Jars, Etc.

For Circulars, apply to CHAS. F. MUTH & SON, Cor. Freeman & Central Aves., Cincinnati, O. Send 10c for Practical Hints to Bee-Keepers.

Mention the American Bee Journal.

Bee-Keeper's Guide—see page 333.

PERSONAL MENTION.

MR. F. A. GEMMILL, of Stratford, Ont.—the Assistant Foul Brood Inspector—reported on May 12 the loss of only one colony of bees; and that the prospects were bright for a good crop of honey in his locality this year. We hope all his anticipations may be turned into realizations.

MR. I. J. STRINGHAM, of New York City, is one of our regular bee-supply advertisers. In a letter dated May 6, he reports having had the best trade, so far, of any year since he has been in the supply business. We are glad to hear this. To our mind, it only proves that if one expects to build up a good trade, he must keep his name and business before the public all the time.

EDITOR LEAHY, of the Progressive Bee-Keeper, said in the May number of that paper, that "The supply business has been exceedingly good. We have not shut down a day, except Christmas, since the middle of last November." This is just what we would expect a firm to say that advertises liberally and regularly. The Leahy Mfg. Co. know how to advertise profitably. Irregular, haphazard advertising never can bring permanent results.

DR. C. C. MILLER, of Marengo, Ill., called on us last week when on his way to Champaign, Ill., where he went as a delegate to the 38th annual convention of the Illinois State Sunday School Association. The Doctor was feeling tip-top, and said that without stretching the truth a bit, the past 8 or 9 months had been the most promising for bee-keeping in this part of the country in his 35 years' experience, and his 150 colonies, in three apiaries, were never in better condition. He expects a fair crop of honey this season, even should there be no more rain the next six weeks; and should the favoring showers come, he anticipates a large crop. After having had two complete failures in succession, he will be able to appreciate a good crop.

MR. THOS. G. NEWMAN AND FAMILY reached San Diego, Calif., all right, we are glad to be able to say. In a personal letter, dated May 4, Mr. Newman wrote us:

FRIEND YORK:—The climate here is delightful, flowers plentiful, and people agreeable. I was sick in bed for two days while crossing the mountains, with hard cold and neuralgia. All the rest are well as usual, except Mrs. Newman, who is accompanied by her old malady—erysipelas. We hope now for an improvement.

On the sleeper the next to me was a bee-keeper who entered into conversation soon after starting. He was en route for California, said that San Diego county is the best in the world for honey. He talked of the bee-periodicals and bee-books. Stated his preferences very emphatically, and admired the Bee-Keepers' Union and its Manager. This was too much for me. I begged him to stop, saying if he knew that he was talking to the person he was talking about, he might wish he hadn't said so much. But even then he persisted—held out his

hand and said, "Shake again; I am so glad we have met."

We had a very pleasant journey when I was able to be sitting up.

Before I got to San Diego, Mr. W. D. French, of Foster, Calif. (well known to the readers of the Bee Journal as an able and progressive bee-keeper), came to see me, but had to leave before I arrived, but left four letters of introduction to the Mayor, banker, and two business men. The people are very cordial and kind.

At Los Angeles I met many old friends. Some met us with bouquets of flowers at the station, and then got up a banquet at the American Legion of Honor Hall; and showed us the city from every point, in carriage rides.

At San Diego Dr. Peebles was waiting with two carriages at the station, and entertained us at luncheon.

We are all delighted with this land of sunshine and flowers.

Yours fraternally,

THOS. G. NEWMAN.

MR. GUS DITTMER, of Augusta, Wis., is one of the comb foundation specialists of this country. Some time ago he wrote us that he had "come to stay," and considered himself established in the business. He attributes most of his success to a small advertisement that he has kept running continuously in the American Bee Journal for nearly two years. By fair and square dealing, in connection with judicious advertising, a man in a business that is useful, can hardly help succeeding. Success, of course, in these days, comes slowly, but it does come to those who deserve it, in almost every case.

Queens and Queen-Rearing.

If you want to know how to have queens fertilized in upper stories while the old queen is still laying below; how you may safely introduce any queen, at any time of the year when bees can fly; all about the different races of bees; all about shipping queens, queen-cages, candy for queen-cages, etc.; all about forming nuclei, multiplying or uniting bees, or weak colonies, etc.; or, in fact, everything about the queen-business which you may want to know—send for Doolittle's "Scientific Queen-Rearing"—a book of over 170 pages, which is as interesting as a story. Here are some good offers of this book:

Bound in cloth, postpaid, \$1.00; or clubbed with the BEE JOURNAL for one year—both for only \$1.75; or given free as a premium for sending us three new subscribers to the BEE JOURNAL for a year at \$1.00 each.

Bee-Keepers' Photograph.

We have now on hand a limited number of excellent photographs of prominent bee-keepers—a number of pictures on one card. The likeness of 49 of them are shown on one of the photographs, and 121 on the other. We will send them, postpaid, for 50 cents each, mailing from the 121 kind first; then after they are all gone, we will send the 49 kind. So those who order first will get the most "faces" for their money. Send orders to the Bee Journal office.

Question-Box.

In the multitude of counsellors there is safety.—Prov. 11-14.

Spacing Brood-Frames — The Bee-Space.

Query 14.—1. Is 1 3/8 inches preferable to 1 1/4 for brood-frames?

2. Has 3/4 inch for bee-space superseded the old idea of 3/8?—AMATEUR.

E. France—1. No. 2. Not as I know of.

Chas. Dadant & Son—1. We prefer 1 1/4.

C. H. Dibbern—1. Yes. 2. I prefer 5/16 inch.

G. M. Doolittle—1. I prefer 1 1/8. 2. I use 5/16.

H. D. Cutting—1. Yes. 2. 5/16 is a good "bee-space."

W. G. Larrabee—1. I prefer 1 3/8 from center to center. 2. No.

James A. Stone—1. I prefer 1 1/8. 2. No, not for me (in all cases).

Mrs. L. Harrison—1. No. 2. Not with me. I prefer 3/8 scant. Say 5/16.

Emerson T. Abbott—1. I make my frames 1 1/8 inches wide. 2. It has with me.

Prof. A. J. Cook—1. I think not. 2. It should be between the two to be just right.

Dr. C. C. Miller—1. It is generally, but I don't feel entirely sure about it. 2. Yes.

J. M. Hambaugh—1. For all purposes 1 1/8 inches from center to center. 2. I don't know.

Allen Pringle—1. No. 2. I don't know what others use, but anywhere from 3/8 to 3/4 will do.

Dr. J. P. H. Brown—1. I make mine 1 7/16 inches. 2. I don't think it has. From 3/8 to 3/4 is right.

W. R. Graham—1. I prefer scant 1 1/8 inches from center to center. 2. 3/4 inch bee-space is all I want.

R. L. Taylor—1. Yes. 2. I think not. It has been known all along that 3/4 inch is the better, if it could be certainly kept at that size.

B. Taylor—1. I use 1 3/8, but I am not sure but 1 1/2 would be better, as it would give room for larger clusters of bees between the combs in winter. 2. It has with me.

J. E. Pond—1. I do not care to use brood-frames over one inch in width. 2. Space the frames "bee-space" apart; that is, so that a bee can just work easily between the frames.

P. H. Elwood—1. The majority of bee-keepers favor the 1 3/8 inch. I do not know. 2. I have never had an older idea than 3/4 inch. I think the 3/8-inch idea is the newer and (in one sense) shallower idea.

Engene Secor—1. 1 3/8 to 1 1/2 inches from center to center is near enough for practical purposes. 2. A bee-space is slightly less than 3/4, but the latter will do well enough, and unless they are crowded for room, bees will seldom build comb in a 3/8 space.

Rev. M. Mabin—1. The difference is so small as to be practically unimportant.

I find that when bees build comb in box-hives that they do not space them as accurately. Some are 1 1/8 inches apart, some a little less, and some a little more. 2. I aim to have the bee-space 3/4 inch. I do not know what others do.

G. W. Demaree—1. I infer you ask about proper spacing of brood-frames. I have worked a good many hives with the frames spaced 1 1/8 from center to center, and a great many more 1 3/8 from center to center of the frames. I prefer the 1 3/8 spacing. 2. I prefer 5/16 for the "bee-space."

\$3.00 Worth for \$2.00!

Until further notice, we propose to give you a chance to get some good reading-matter for the long winter evenings, at half price.

Send us \$2.00, and we will mail you your choice of \$2.00 worth of the following booklets, and also credit your subscription to the American Bee Journal for one year:

Poultry for Market and Profit.....	25c
Our Poultry Doctor.....	30c
Turkeys for Market and Profit.....	25c
Capons and Caponizing.....	30c
Rural Life.....	25c
Preparation of Honey for the Market.....	10c
Bee-Pasturage a Necessity.....	10c
Hive 1 Use, by Doolittle.....	5c
Foul Brood, by Dr. Howard.....	25c
Foul Brood, by Kohake.....	25c
Foul Brood, by Cheshire.....	10c
Bee-Keeping for Profit, by Dr. Tinker.....	25c
Kendall's Horse-Book—Eng. or German.....	25c
Silo and Silage, by Prof. Cook.....	25c
Hand-Book of Health, by Dr. Foote.....	25c
Maple Sugar and the Sugar Bush.....	35c
Potato Culture, by Terry.....	40c
Carp Culture, by Root & Finney.....	40c
Strawberry Culture, by Terry & Root.....	40c
Bienen Kultur, by Newman [German].....	40c
Winter Problem in Bee-Keeping [Pierce].....	50c
Bee-Keepers' Directory, by Henry Alley.....	50c
Advanced Bee-Culture, by Hutchinson.....	50c
5 Honey as Food and Medicine.....	25c

GEORGE W. YORK & CO., CHICAGO, ILLS.

Book Clubbing Offers.

(Read Carefully.)

The following clubbing prices include the American Bee Journal one year with each book named. Remember, that only ONE book can be taken in each case with the Bee Journal a year at the prices named. If more books are wanted, see postpaid prices given with the description of the books on page 303 Following is the clubbing-list:

1. Langstroth on the Honey-Bee.....	\$2.00
2. A B C of Bee-Culture.....	2.00
3. Bee-Keeper's Guide.....	1.75
4. Bees and Honey [Cloth bound].....	1.65
5. Scientific Queen-Rearing.....	1.75
6. Dr. Howard's Foul Brood Book.....	1.10
7. Advanced Bee-Culture.....	1.30
8. Amerikanische Bienenzucht [Germ.].....	1.75
9. Bienen-Kultur [German].....	1.25
10. Rational Bee-Keeping [Cloth bound].....	2.00
11. Rational Bee-Keeping [Paper bound].....	1.75
12. Thirty Years Among the Bees.....	1.30
13. Bee-Keeping for Profit.....	1.15
14. Convention Hand-Book.....	1.15
15. Poultry for Market and Profit.....	1.10
16. Turkeys for Market and Profit.....	1.10
17. Capons and Caponizing.....	1.10
18. Our Poultry Doctor.....	1.10
19. Green's Four Books.....	1.15
20. Green's Six Books on Fruit-Culture.....	1.15
21. Garden and Orchard.....	1.15
22. Rural Life.....	1.10
23. Emerson Binder for the Bee Journal.....	1.60
24. Commercial Calculator, No. 1.....	1.25
25. Commercial Calculator, No. 2.....	1.40
26. Kendall's Horse-Book.....	1.10
27. Strawberry Culture.....	1.20
30. Potato Culture.....	1.20
31. Carp Culture.....	1.20
32. Hand-Book of Health.....	1.10
33. Dictionary of Apiculture.....	1.35
34. Maple Sugar and the Sugar Bush.....	1.20
35. Silo and Silage.....	1.10
36. Winter Problem in Bee-Keeping.....	1.30
37. Apary Register (for 50 colonies).....	1.75
38. Apary Register (for 100 colonies).....	2.00
39. Bee-Keepers' Directory.....	1.30

Honey & Beeswax Market Quotations.

The following rules for grading honey were adopted by the North American Bee-Keepers' Association, and, so far as possible, quotations, are made according to these rules:

FANCY.—All sections to be well filled; combs straight, of even thickness, and firmly attached to all four sides; both wood and comb unsoiled by travel-stain, or otherwise; all the cells sealed except the row of cells next the wood.

No. 1.—All sections well filled, but combs uneven or crooked, detached at the bottom, or with but few cells unsealed; both wood and comb unsoiled by travel-stain or otherwise.

In addition to this the honey is to be classified according to color, using the terms white, amber and dark. That is, there will be "fancy white," "No. 1 dark," etc.

CHICAGO, ILL., May 16.—We quote: Fancy white, 15c.; No. 1 white, 12@13c.; fancy amber, 9@10c.; No. 1 amber, 7@8c.; fancy dark, 8@9c.; No. 1 dark, 7c. Extracted, white, 5@7c.; amber, 4@5c.; dark, 4@4 1/2c. Beeswax, 30c. The number of sales are few, and prices are really nominal. The only activity shown is in a little fancy comb and beeswax.
R. A. B. & Co.

PHILADELPHIA, PA., Apr. 22.—We quote: No. 1 white, 9@10c.; fancy amber, 8@9c.; fancy dark, 7@8c. Extracted, white clover, 10c.; amber, 5@5 1/2c.; dark, 4@4 1/2c. Beeswax, 25@26c. Comb honey is dull. Extracted in fair demand. Beeswax lower. W. A. S.

BUFFALO, N. Y., Apr. 20.—We quote: Fancy white, 15@16c.; No. 1 white, 13@14c.; fancy dark, 8@9c.; No. 1 dark, 7@7 1/2c. Beeswax, 25@28c. Trade very dull and honey not moving, except a few fancy lots; anything dark is hard to sell.
B. & Co.

CINCINNATI, O., Apr. 22.—There is no fancy white comb honey on our market. Best white sells at 12@14c. in a jobbing way, with a fair demand. Demand is good for extracted at 4@7c., according to quality. Beeswax is in good demand at 25@30c. for good to choice yellow.
C. F. M. & S.

KANSAS CITY, MO., May 9.—We quote: No. 1 white, 13c.; No. 1 amber, 11c.; No. 1 dark, 8c. Extracted, white, 6c.; amber, 3c.; dark, 4c. Beeswax, 25c.
C. C. C. & Co.

NEW YORK, N. Y., May 9.—There is some demand for white comb honey at unchanged prices. No market for buckwheat. Extracted remains quiet. New Southern is now arriving and selling at 5@6c. for fine grades and 50@55c. a gallon for fair to common. Beeswax easy at 28@29c.
H. B. & S.

List of Honey and Beeswax Dealers.

Most of whom Quote in this Journal.

Chicago, Ills.

R. A. BURNETT & Co., 163 South Water Street.

New York, N. Y.

HILDRETH BROS. & SEGELKEN,
120 & 122 West Broadway.

CHAS. ISRAEL & BROS., 486 Canal St.

Kansas City, Mo.

C. C. CLEMOMS & Co., 423 Walnut St.

Buffalo, N. Y.

BATTERSON & Co., 167 & 169 Scott St.

Hamilton, Ills.

CHAS. DADANT & SON.

Philadelphia, Pa.

WM. A. SELSER, 10 Vine St.

Cincinnati, Ohio.

C. F. MUTH & SON, cor. Freeman & Central avs.

1896 SAVE MONEY 1896

If you want first-class **ITALIAN QUEENS FOR BUSINESS**, Foundation at Wholesale Prices, Hives, suited for the South, or **SUPPLIES**, send for Price-List—to

J. P. H. BROWN, AUGUSTA, GA.

Bottom Prices

**BRING US BIG TRADE.
GOOD GOODS KEEP IT.**

If you want the best supplies that can be made at a little less cost than you can buy the same goods for elsewhere, write to us for low prices. 1896 Catalogue now ready—ask for it and a free copy of **The American Bee-Keeper** (36 pages).

Address,
THE W. T. FALCONER MFG. CO.,
JAMESTOWN, N. Y.
Mention the American Bee Journal.

COMB FOUNDATION!

Wax always wanted for Cash or in Exchange for Fdn. or other Supplies. My trade is established on **Low Prices** and the merit of my **Foundation**. Orders filled promptly.
WORKING WAX INTO FDN. BY THE LB. A SPECIALTY. Wholesale prices to dealers and large consumers. Send for Prices and Samples to—**GUS DITTMER, AUGUSTA, WIS.**
Reference—Augusta Bank. 1Atf
Mention the American Bee Journal.

ROOTS GOODS Prices Reduced on Dovetail Hives and Sections. A full line of Apathran Supplies in stock to fill orders promptly at lowest prices for Best Goods. 36-page Catalogue Free.
JNO. NEBEL & SON, High Hill, Mo.
Mention the American Bee Journal. 4A26t

I ARISE



TO SAY to the readers of the **BEE JOURNAL** that **DOOLITTLE**

has concluded to sell—**BEEES and QUEENS**—in their season, during 1896, at the following prices:
One Colony of Italians on 9 Gallip frames, in light shipping-box \$6.00
Five Colonies..... 25.00
Ten Colonies..... 45.00
1 untested queen. 1.00
6 " queens 5.50
12 " " 10.00
1 tested Queen... \$1.50
3 " Queens... 3.50
1 select tested queen 2.00
3 " Queens 4.00

Select tested queen, previous season's rearing . 4.00
Extra Selected for breeding, the VERY BEST. 5.00
About a Pound of **BEEES** in a Two-frame Nucleus, with any Queen, \$2.00 extra.

☞ Circular free, giving full particulars regarding the Bees and each class of Queens.
Address

G. M. DOOLITTLE,
12A25t BORODINO, Onon. Co., N. Y.
Mention the American Bee Journal.

BEEES QUEENS
Smokers, Sections, Comb Foundation, and all Apathran Supplies cheap. Send for FREE catalogue. **E. T. FLANAGAN, Belleville, Ill.**
6A26t Please mention the Bee Journal.

PURE BARRED PLYMOUTH ROCK
Eggs, \$1.25 per 14. Our P. Rocks are very large, with fine plumage. Also.

BLACK MINORCA EGGS,
a non-sitting and great laying breed. Both kinds raised upon our farm. Minorca Cockers, \$1.00 each. **Mrs. L. C. AXTELL,**
16Atf ROSEVILLE, Warren Co., ILL.
Mention the American Bee Journal.

19th Year Dadant's Foundation 19th Year

Is still in the lead, for we use all the latest improvements, including the

NEW WEED PROCESS,

and still make the best goods. Remember that we do not use any acid to purify our beeswax, and that is why our Foundation preserves the smell of the honey and is more acceptable to the bees, than any other. It is kept for sale by

T. H. Strickler, Solomon City, Kansas.
G. K. Hubbard, Fort Wayne, Ind.
L. Hanssen, Davenport, Iowa.
C. Theilmann, Theilmanton, Minn.
E. C. Eaglesfield, Berlin, Wis.
E. T. Abbott, St. Joseph, Mo.
J. M. Jenkins, Wetumpka, Alabama
John Rey, East Saginaw, Mich.
Vickery Bros., Evansville, Ind.

The Jennie Atchley Company, Beeville, Texas.
C. F. Muth & Son, Cincinnati, Ohio.
E. Kretzmer, Red Oak, Iowa.
G. B. Lewis Co., Watertown, Wis.
James Reynolds Elevator Co., Poughkeepsie, N. Y.
Louisiana Bee-Keepers' Supply Manufactory, Donaldsonville, La.
Page & Lyon, New London, Wis.
John Nebel & Son, High Hill, Mo.

and many other Dealers. All agree in saying that no goods are better than ours.

Those of our customers who formerly bought through Thos. G. Newman can get our Foundation in **Chicago, Ill.**, by addressing us at **118 Michigan Street**. We keep no other goods there.

We make a specialty of **Veils and Veil Stuffs** of best quality, cotton and silk.

"LANGSTROTH ON THE HONEY-BEE"—Revised.

Bee-Keepers' Supplies, Smokers, Sections, Tin Pails, etc.
Samples of Foundation and Tulle FREE with Circular. Instructions to beginners with Circular. Send us your address.

CHAS. DADANT & SON,
Mention the American Bee Journal. **HAMILTON, Hancock Co., ILL.**

25c Cash Paid for Beeswax!

For all the good, pure yellow **BEEESWAX** delivered to our office till further notice, we will pay 25 cents per pound, cash; or 28 cents for whatever part is exchanged for the American Bee Journal, Books or Seed, that we offer. If you want **cash promptly** for wax, send it on at once. Dark or impure wax not taken at any price. Address plainly,

George W. York & Co., 118 Michigan St., Chicago, Ill.

Lower Prices on Sections & Foundation

Improved facilities, increased output, and competition, together with hard times, tend to lower prices.

Root's No. 1 White Extra-Polished Sections

are superlative in quality, and are now offered for a short time at the following special prices for 4 1/4 x 4 1/4 any stock width: **1000, \$2.50; 2000, \$1.50; 3000, \$6.45; 5000, \$10.00.**

Cream Sections of such widths as we have in stock at 25c per 1000 less than the white.

The New Weed Process Comb Foundation

is superior to all others in every way, showing, from recent tests in Florida, five times greater resistance to sagging, making it possible to use a lighter grade with more feet to the pound, with greater safety than with the old process. Owing to decline in wax we reduce price of Foundation **3 cts.** a pound. Prices now are:

	Price per lb. in lots of	1 lb.	10 lbs.	25 lbs.	50 lbs.
Heavy or Medium Brood Foundation.....		44c	43c	42c	40c
Light Brood.....		47c	46c	45c	43c
Thin Surplus.....		54c	53c	52c	50c
Extra-Thin Surplus.....		59c	58c	57c	55c

Lower prices on 100-lb. lots, and dealers supplied at special prices.

These wholesale dealers who handle Root's Goods in carload lots unite with us in above prices:

Walter S. Pouder, Indianapolis, Ind.; John Nebel & Son, High Hill, Mo.
Joseph Nysewander, Des Moines, Iowa; Wm. A. Selser, Philadelphia, Pa.
M. H. Hunt, Bell Branch, Wayne Co., Mich.; Geo. E. Hilton, Fremont, Mich.

THE A. I. ROOT CO., MEDINA, OHIO.

118 Michigan St., Chicago, Ill. **Syracuse, N. Y.**
1024 Mississippi St., St. Paul, Minn. **Mechanic's Falls, Maine.**

THE AMERICAN BEE JOURNAL

DEVOTED EXCLUSIVELY TO THE INTERESTS OF HONEY-PRODUCERS

ESTABLISHED 1861
THE OLDEST BEE-PAPER IN AMERICA

Published Weekly, at \$1.00 per annum.

Sample Copy sent on Application.

36th Year.

CHICAGO, ILL., MAY 28, 1896.

No. 22.



Cutting Foundation for Sections.

BY F. L. THOMPSON.

Recently, at the apiary of Rauchfuss Bros., I learned the following plan, by which I cut 500 full sheets and as many starters as soon as I got home, and think it the best of any I have heard or read of. If any one has a better plan, trot it out.

A board *T*, of $\frac{3}{8}$ or $\frac{1}{2}$ inch lumber, is nailed on the edges of two similar pieces, *s s*. The resulting space between *s* and *s* should be of such a width that the block *B* just fits it, and the width of this block should be the same as the width of the foundation. The length of the boards and block should not be less than the length of the foundation. Before nailing, lines are drawn across the top board, square with its edges, at intervals equal to the depth of foundation wanted. The figure shows what would be necessary to cut a sheet into five equal parts. These lines are a guide to the proper position for the nails, as shown in the figure.



After nailing, saw-cuts are made where the lines are, through the top board and part way down the side boards. The distance down to be sawed is determined by the number of sheets one finds by trial that he can cut through at once. Care should be taken to make the cuts in the side boards at right angles with the level of the top.

To use, a number of sheets (*F*) are laid on the block *B*, and over them is put the box *s s T*, which might be called a mitre-box. The left hand presses down the box on the foundation, holding it immovable, while the right hand draws a thin, sharp knife, lubricated with honey, or honey and water, quickly through each of the saw-cuts, employing a single stroke for each cut.

One may have, if he wishes, two sets of saw-cuts in the same mitre-box, one set for one depth of sheet, and one for another; or he may make the cuts closer together, for starters.

The advantages are the great rapidity with which the work is done; the cleanness of the cuts, the edges never being torn and ragged; and the squareness of the sheets or starters.

Arvada, Colo.



Interesting Experiences in Marketing Honey.

BY MRS. BRITANIA J. LIVINGSTON.

What I know about marketing honey? "That powder has been shot." It made quite a noise, too. My report in *Farm, Stock and Home*, of finding the whole honey-trade of a large retail store blocked by a few unsightly sections was quoted quite extensively.

"I can't sell honey," said the merchant plaintively pointing to the article that had ornamented (?) his window for months. There were crushed bees still imbedded in the propolis that freely stuck to the cholera-spotted sections. The honey itself was of fair quality—the untidy wood surrounding it was repelling. After showing a sample of honey put up on scientific principles, I offered to take his honey off his hands at half price, in exchange for mine. He gladly accepted my offer, and is one of my best customers to-day, being especially partial to honey of a fancy grade.

My sales are mostly made to merchants in the little towns within 20 miles. It does not always bring cash, but we never have trouble in exchanging it for family supplies.

Many are very successful in traveling with a sample case, and taking orders to be delivered on a certain date, but I think few lady bee-keepers have time for that. The most of us have many other duties, which compel us to market our honey in the most expeditious manner.

There is none of us so far from market as they who have nothing to sell. With the most of us there must be months of planning, of sewing, canning and home-making, in order to have the time to give to the bees just when it will tell the best, for honey to market.

First, get your honey. Heard something like that before, haven't you? After you get you honey, then get acquainted with the store-keepers, or rather, make them acquainted with your honey. I can't see where any difficulty should arise against working up a fine home trade. At least I have never found any trouble except from one cause. One year I had several hundred pounds of dark honey. It was in fine shape, in white, clean sections, and sold on sight at all the stores. But I had not then kept bees long enough to know anything about a black-strap sort of honey. I never saw anything like

it until large flax fields were grown here. So we call it "flax-honey." If I am wrong, I beg Flax's pardon. It took two years to outgrow the result of putting that poor stuff on the market.

I give this experience to put newcomers on guard, that they may not take this step backward.

Another mistake I made was in sending away a sled load of cases, that were just as they came off the hive. The man who settles my bills, when the honey fails—in return for which I settle many of his when it don't—he offered to take a load to W. city to see what he could do with it. We carefully chose full supers of white, even sections, and both believed that they would carry better in the sleigh if we left them just as the bees had fastened them. One merchant took \$50 worth, half store pay, the balance to be cash, paid as soon as he had sold \$25 worth. The merchant wished them left in the supers, as they "took up less room." So the sections were sold by count after he had examined them carefully.

Afterward, when pay day came, this gentleman claimed that some of the sections were unfinished—"a few had nothing in them." Now, as you cannot afford to quarrel with the the country merchants, or have them dissatisfied in any way with your dealings, never trust a super out of your hands until it is repacked, cleaned, and the honey graded. These are all stumbling-blocks.

If you have your honey well in hand I cannot imagine a pleasanter duty than soliciting orders at retail stores or business houses. No matter what my need may be, from a wheelbarrow to a set of store teeth, I have been able to obtain it with honey, and the other party always acts as if he was getting the favor.

I seldom meet with unpleasantness in my sales. I remember one case where I offended a merchant, and he let his displeasure make itself manifest. I had tried to sell him some fine section honey for 15 cents a pound. I had sold several cases readily at that price in other parts of town. He offered me 10 cents a pound. When I refused, he triumphantly brought around a large platter with an immense piece of honey that had been taken from the largest frame I ever saw—or perhaps broken from a barrel. "There," said he, "I can get all the honey I want as nice as that for 10 cents!"

It was nice looking honey, sealed over with white cappings. While he was talking, customers gathered around, and one man said, "I'll take 25 cents worth of that." I waited, for I wanted to see the comb under the cappings. As I expected, when the light honey run out, the comb was old brood-comb.

"What makes the comb so dark?" said the customer. "Oh, I don't know; honey is 'most always like that," said the salesman.

"Beg pardon," said I, "section-honey is not."

The customer asked me why section-honey did not have black comb. "Because the bees never use it to hatch young bees in," said I. I pointed to the broken comb on the platter, and proved it by bee-bread and pollen in some of the cells. I said, "There have been several generations of bees hatched in that comb. I am very fond of eggs, but I never eat a hen's nest. Neither do I fancy bees' nest."

An old gentleman, who stood near the plate of honey, began to laugh and joke the merchant about his purchase of bees' nest, while I went to make some purchases in another part of the store, but that merchant has not forgiven me yet.

A farm paper, long ago, advised farmers to have a post in a conspicuous place on the road near the house on which to advertise anything they have to sell. We long ago adopted that plan, and "HONEY TO SELL" leads all the rest. This method brings cash, and has but one objection. It has to be taken in over Sunday, as this country is getting to be quite a

famous summer resort, and people "resort" more Sunday than all the rest of the week. And my kind of bees don't gather honey to sell on the Sabbath day.

Centre Chain, Minn.



Under-Consumption of Honey, Not Over-Production.

BY S. B. SMITH.

I was very much interested in the communication on page 163, from G. M. Doolittle, entitled, "The Past and Present of Bee-Keeping." Mr. Doolittle has evidently given an honest opinion as he views the situation or condition of the honey market from his stand-point, but we in the West, having a different stand-point, view things quite differently. Mr. Doolittle's mind seems to be burdened with the over-production theory, that has been so much written upon for the last few years. Let us look at this subject candidly, and with all fairness, and see if over-production is the true cause of the low price of honey. I claim that the word "over-production" is a misnomer. A better word would be "under-consumption." Let us look at some of the other products of the soil and see if I am wrong in that opinion.

A few years ago, about the beginning of what is called the "hard times," our Minnesota wheat dropped in price below the cost of raising it. We were told that the cause of the low price was over-production. At the same time there were not only thousands, but hundreds of thousands, in the United States that were so near starvation that they were fed from soup-houses and bread-counters. A large portion of these destitute people were willing to work for something to eat, but could find no employment. Over-production with hundreds of thousands of people nearly starving—bosh!

Last year, Minnesota had a large crop of wheat, and the price was the lowest that has ever been known in the State. Over-production was again the cry, as the cause of the low price; at the same time the world's crop of wheat was over 100,000,000 bushels short. Was over-production the cause of the low price? Nay, verily.

The price of cotton has declined steadily for some years, but there has been no over-production to cause the depreciation in value. Over-production is not the cause of the low price of the products of the soil, including honey, but the scarcity of money in circulation. The farmer is not paid for anything he produces a sufficient amount to pay the cost of producing it. A majority of tradesmen are paid starvation wages; they do not receive sufficient pay to purchase the necessaries of life. Put more money into circulation, so the farmer can receive for his products what it costs to produce them, and pay the laborer a fair compensation for his labor, and this over-production theory will disappear like dew before the sun.

Mr. Doolittle says he commenced bee-keeping 27 years ago, and compares prices then and now. I commenced bee-keeping more than 40 years ago, and sold many hundred pounds of honey in those 5-pound boxes that Mr. D. speaks of, at 25 cents per pound, and now honey put up in much better shape will hardly sell for half of that amount; but over-production is not the cause of the decline of price, but under-consumption.

Early in life I lived in New Hampshire, and I remember the time when a barrel of flour would last a family one year, and now a family of the same number will consume six or eight barrels. If the laboring class were receiving a fair compensation for their labor the consumption of honey would increase in the same ratio. Bread is something a man *must* have; honey is something he *can* do without. Honey has not depreciated in value any more than all other products of the soil.

If there is one thing needed in this country more than another it is a greater degree of brotherhood. Each one of us ought to try to elevate our fellowmen, to raise him to a higher standard. We ought to try to better his condition. Let us discard that over-production theory, and fill the American Bee Journal with the sweetness of honey from the honey-comb.

Keeville, Minn.



Perfection in Wintering Bees.

BY C. E. MEAD.

I have written on this subject several times before.

One man in Minnesota took a colony of bees out of a black-oak root three feet below the ground. A wash-out had exposed and killed that portion in the gully which had rotted off, and the bees had entered the root in the gully, and were a month in advance of bees in hives, their condition always above freezing, and they could fly when the weather would admit.

Another man found a colony in a woodchuck or skunk hole. The condition is equally good.

Now, these two colonies had all the advantages of cellar wintering and wintering on the summer stands above freezing, and a flight when the weather permitted.

I induced a friend, Mr. Crego, of Cook county, Illinois, to make a 3-foot bottom-board with strips extending from the front to the rear. The bees have an exit under the cellar-window, and the hive (which was a 4-frame nucleus) is in the cellar. The strips between the hive and the window are covered with a board 14 inches long, so there is a short tunnel for them to travel to the exit. A drawer under the hive showed when they began to breed, also the amount of dead bees. Mr. Crego says that they began to breed in February, as he found brood-cell cappings at that time. Not a teacupful of dead bees were found during the whole winter. On April 15 there were more bees and honey than in the fall; on May 15, bees and honey in 18 Langstroth frames, and so much honey that it ought to have been extracted.

Now, paste this in your hat: *Winter your bees in the cellar or under ground, well packed, with an out-door exit.*

My packed colonies did not use 5 pounds of honey till brood-rearing began, but they have consumed much since then.

HOW DO YOU PREVENT SWARMING?

Rear, or buy, young queens, as many as you wish to increase. With two-story 8 and 10 frame hives, and 4 or 5 cases of sections on top, hives open all around at the bottom, and $\frac{3}{4}$ -inch thick blocks under each corner, and well shaded, they do not often wish to swarm. But if I think they do, I remove the old hive and place an empty hive with frames full of foundation. Into this one-story brood-hive I run all but about two quarts of bees from the two-story old hive, including the old queen. Cut out all queen-cells, and if you have a nucleus with your young queen, in 24 hours take out frames of honey and put her and her bees in, after first breaking the cappings on two or three frames, so the bees will be compelled to fill themselves. Smoke them a little, and place all the section-cases on the new hive. Your swarming is done for the season. Your young queen will fill every empty cell, and an immense amount of young bees will soon fill the hive, and as they have no place to store honey, they will fill two or three cases of sections in a sweet-clover range.

If you wish to increase fast, divide your two-story colony and introduce a young queen to each, giving cases of sections to each. This practice succeeds because of the known fact—*a young queen seldom swarms the first year.* You gain just 20 days in brood and bees. Ten days is the average time of a queen emerging; ten more before she lays. Now your young laying queen in the other case is laying eggs at the rate of

2,000 per day—a difference of 38,000 bees in favor of division and a laying queen.

Now, if you are running single-story 8 or 10 frame hives, and wish to increase double, take the same plan. If but one-half, put two brood-bodies on top of each other, and put in a young queen. If but one-third increase is wanted, place the three brood-bodies on top of each other. If one-fourth increase, tier up the four brood-bodies.

I clip all of my queens' wings, on one side only, about one-half of the two wings.

GETTING BEES INTO THE SECTIONS EARLY.

To get your bees into the section-cases early, I find nothing like wide frames holding 8 sections $4\frac{1}{4} \times 4\frac{1}{4}$. I take out three brood-frames of honey, and place the wide frames one on each outside next to the hive sides. Then place a frame next to them of capped brood and capped honey. As soon as the sections are nicely started, I put them in a case above, and replace the 16 sections with fresh ones. I get two cases started thus on each hive, and then I give them back three frames of heavy worker-foundation in the center of the hive, in place of the wide frames taken out. All the sections will be filled that you can get the bees started on by basswood bloom, and often more, if you have a sweet clover range.

Chicago, Ill.



The Hive Discussion and Other Matters.

BY W. P. FAYLOR.

A subject of so much importance as the hive, or home of the honey-bee, cannot be too thoroughly investigated. If the flowers from which bees gather the most delicious sweets—Nature's secretion—and a hundred and one other items pertaining to bee-keeping are worthy of recognition, even so is the house in which bees must dwell. Much of the time of summer days, and all the days of winter—yes, and every night of the entire year—the hive is the abiding place of man's favorite insect pet—the honey-bee. We build suitable apartments for other stock—horses, cows and pigs. How for the bee? Shall the hive be constructed altogether for the keeper's special benefit, and the bees have no share or part in the adaptability of its constructed house? If bees reason, I wonder what they think sometimes of their surroundings. Wouldn't be surprised to occasionally find a swarm seeking a new location; but oh, me! when they exchange a nice house for a split and twisted old rotten tree, then where the judgment comes in I'd like to know. But, say, if the bees knew what I know, they would know that their masters do some very foolish things, too, at times.

Early after the honey harvest, a commission merchant of Minneapolis, who had sold my honey to good advantage last year, wrote me that there was not a bit of extracted honey on his market, and thought it would bring 9 cents, and perhaps 10 cents, a pound. So I shipped him six 60-pound cans immediately. After two months I received a check for the fine basswood and white clover honey sent as a sample. Did I get 9 cents a pound? Why, just think of it! He sold it for 4 cents a pound, and after deducting 10 per cent. commission, and the freight charges, sent me the balance. Had I sent a pound can as a sample instead of what I did send, it might be an argument in favor of man reasoning. As I could have gotten 8 cents for it at home, I wonder now where the man's judgment came in. Whether bees reason or not, perhaps one bee-keeper will next time.

I learned recently that my nearest city of note—Dubuque—is practically without any honey—a city of 45,000 inhabitants. A paper sent me from Danville, Ill., recently quoted honey at 17 to 19 cents a pound. Why should we continue to break down the large city market, and let cities of from 20,000 to 40,000 population go empty handed? Perhaps

there will be some improvement on marketing honey some sweet day.

LARGE HIVES.—I am strongly in favor, and will vote for, the large hive, every time. We usually see the motto in bee-books: "Keep all colonies strong." This is a good motto, and to do this I find it necessary to use good-sized hives. I run mostly for extracted honey, and use 10 frames, $14\frac{1}{4}$ inches square, making the body of the hive 15 inches, in the form of a cube. I practice the Demaree method in securing honey. By this method I can double the amount over the shallow-frame-tiering-up method. I had my extractor changed so that the frames may hang in the comb basket the same as in the hive. I can handle one large frame much quicker than I can two shallow ones. Then it is always annoying to put frames into the extractor lengthwise, as the ends of the top-bar are apt to catch when we handle them rapidly. Colonies in large hives give me hardier and more prolific queens, and longer-lived bees.

A blacksmith near me has a colony of bees in a salt barrel, and the barrel is full from top to bottom. There is a big crack or opening about an inch wide from top to bottom, and yet a colony has wintered in that shell of a thing for four or five years without any protection. A small colony in a shallow hive would perish there the first month of winter.

I have a few colonies in 8-frame Simplicity hives that I run for comb honey. They need a great deal of attention, and must frequently be fed to keep from starving. The middle frames are often found without a drop of honey.

Even where we use shallow frames the 10-frame hive has this one great advantage: There is usually honey left in every frame—if not above, there will be some at the ends. With plenty of honey in the ends of the frames, the bees are kept more nearly like they would be in a square brood-chamber. It is generally believed that bees do not move lengthwise in the winter, but that is a mistake. Bees usually move toward the warmer part of the hive. If the sun shines on one side of the hive in cool or cold weather, how quickly the cluster makes for that side of the hive. I have often had colonies eat out all the honey in one end of the hive, and leave the other end full.

I used to go to a neighbor to recruit my weak bees in 8-frame hives in the spring. His were in hives ranging from 10 to 14 Langstroth frames. He had powerful colonies, but he thought the bees in hives with more than 11 frames did not do as well as those in the 10 and 11-frame hives.

I wonder why some factories do not make a 10-frame hive with frames about $10\frac{1}{4}$ inches deep, to accommodate those who want large hives for comb honey. Then, either shorten the frames or enlarge the sections, so that four sections will fill out a section-case without a useless amount of wood to fill up vacant space; or, in other words, the section-case should be the same in length and width as the brood-chamber, doing away with an outer case over the sections. The $4\frac{1}{2} \times 4\frac{1}{4}$ sections are not large enough to hold a pound of honey. Usually 14 ounces is the minimum weight, yet thousands of them are sold for one-pound sections, and bee-keepers usually speak of them as "one-pound sections." Why not have a one-pound section?

Updegraff, Iowa.



Working for Comb Honey—Putting on Sections.

BY G. M. DOOLITTLE.

If we have been successful in working our bees for brood, so as to obtain a multitude of bees in the right time for the honey harvest, as I have told should be done, would we secure the best results from them, often repeating this in the columns of the different bee-papers, to emphasize the great importance of this matter, by the time this appears before the readers of the American Bee Journal, spring will have given place to

summer, and we are ready for the next step in working for comb honey. This will be putting on the section-boxes, or a part of them, for I contend that it is poor policy to give any colony (unless it is in the case of two prime swarms being hived together), all of the surplus room on the start, as such tends to discourage them, as they do not as yet have a sufficient amount of bees to take possession of so large amount of room.

I generally give surplus room amounting to from 25 to 30 pounds at the start, giving as much more room when the bees have fully taken possession of that first given, and finally the full capacity of the hive (about 90 pounds), when the force of bees increases so as to need it. However, as a rule, the swarming season arrives before all of the sections are put on, when no more sections are added until the old colony has a laying queen.

Always, in managing bees, the apiarist should have an eye on the future as regards his honey harvest, until the harvest arrives, and when it arrives, then bend his every energy for the time which is present.

For instance, my main honey harvest comes from bass-wood, which blooms from the 5th to the 25th of July, so all my operations previous to this time must be in reference to this harvest, or all my efforts will result only in failure. Now the time of the bees swarming has a very important bearing on what I secure as cash out of the apiary. If they swarm too early they defeat my plans, and if too late it is nearly as bad. The thing is to have them all swarm at the right time, which is brought about as nearly as may be, by keeping back the strongest and building up the weakest. This is done by drawing bees and brood from the strong and giving to those which are weaker, until all are brought to a uniform strength at the desired time of swarming.

"But," says one, "when is the proper time for increase?" To which I reply, about 15 to 20 days before the main honey harvest. Why? Because this gives time for the young queens in the old colonies to become fertilized, and not enough time to the new swarm to get so strong as to desire to swarm again. Remember, I am talking exclusively of producing section honey, for the production of extracted honey requires a somewhat different mode of procedure, in my opinion, and I have extracted as high as 566 pounds from a single colony in one season. Nothing can detract more from our crop of comb honey than to have our bees contract the swarming fever during the honey harvest, unless it is, the having them so weak at the time that they are of little or no value.

About the first of June, one year, I was accosted by a neighbor, saying, "Have your bees swarmed yet?" "No," I said, "nor do I expect them to generally for the next two or three weeks."

"Well," said he, "I guess you won't get much from them, for Mr. S. is having lots of swarms."

"All right," said I, "I shall be glad to have Mr. S. secure a good crop of honey."

Well, the result was, during the height of the honey harvest Mr. S. was having lots of swarms, which he was putting back, cutting out queen-cells, etc., in the vain hope to get them to go to work, while only now and then a swarm was issuing in my apiary, with the sections being filled as if by magic.

I have often said the securing of the bees in the right time for the honey harvest counts more toward cash and fun in the apiary than anything else, which is true, but next to this is the managing of those bees, so they will be only bent on storing honey during the honey harvest; for the lack of either gives the apiarist only small return for his labor among the bees.

After doing all in my power to secure all swarms between the 15th to the 25th of June, if the season is an early one,

or from the 25th of June to the 4th of July, should it be late, I frequently get a few from five to eight days earlier, and also a few, that number of days later; but the great bulk come about as I have given.

The date of swarming is put on each hive, thus: "N. S. 6—21" being put on the swarm, and "Sw'd, 6—21" on the old hive, if that is the date. On the evening of the eighth day I listen for a moment or two at the side of the old hive, and if swarming has been done "according to rule," I hear the young queen piping, when I know a young queen has hatched, and an after-swarm will be the result if it is not stopped. If no piping is heard, I do not listen again until the evening of the 13th day, for the next rule is that the colony swarmed upon an egg or small larva being in the queen-cell, which allows the queen to hatch from the 12th to the 16th day after swarming. If no piping is heard by the evening of the 17th day, no swarm need be expected. When it is heard, which will be in nine cases out of ten, on the eighth day, I go early in the morning and take every frame out of the hive, shaking the bees off of each (in front) as I take them out and return them again, so I shall be sure and not miss a queen-cell, but cut all off, for we know that a queen has hatched. This is a sure plan, while I have found by experience that none of the other plans given are sure of the prevention of after-swarms.

The colony is now "boxed" to its full capacity, and if the queen gets to laying all right it will produce a larger amount of comb honey than the swarm will. In 21 days from the time the swarm is hived, young bees will begin to hatch so as to reinforce that colony, so on the 23rd to the 25th day after hiving, I give the full capacity of surplus room to this also, if I think it requires it, which tends to keep them from having a desire to swarm again.

In this way the very best results are secured, the same being what I have practiced successfully for the past 25 years.

Borodino, N. Y.

CONVENTION PROCEEDINGS

Report of the Michigan State Convention.

BY W. Z. HUTCHINSON.

The illness of the President, and of the Secretary's daughter, caused the postponement of the holding of the Michigan State Bee-Keepers' Convention until April 23 and 24, when it met in Lansing. Owing to its being "out of the season," so to speak, for conventions, and the poor honey crops that we have had of late, a large attendance was not expected, but it was thought best to hold a meeting, even if it should be slimly attended, as better years will probably come again, and an organization is needed, and a year or two of good crops will probably bring out a crowd again. As was expected, only what might be called "leading" bee-keepers were present, but a good, social time was enjoyed.

The meeting was called to order by Pres. M. H. Hunt, who then read the following address, on

Bee-Conventions.

A few years back our conventions were well attended—it was no trouble to get out 50 or 100—but now our State meetings scarcely ever exceed a score, and that number is made up of those who have been the life of its existence, the veterans, I might say.

I see those here to-day whom I have met with pleasure year after year, and it seems to me when for some cause they fail to come our conventional must cease. Others may develop enough enthusiasm to keep it alive, but the signs of the times do not point that way. The very excellent periodicals and books published in our interest, and so cheaply, have, I think, lessened the attractions of our meetings, especially to those who seek knowledge for what there is in it for their own individual benefit. It comes much cheaper to read the reports of a convention at home, than to attend it. The average expense of attending would pay the subscriptions to all the bee-journals published in this country.

The several poor seasons in succession have, no doubt, had a bearing on the matter, they having a tendency to incline him to economy, and also to rob him of some of his enthusiasm. A few good seasons, with fair prices, would help us, but should the seasons continue like the few just past, we will have to devise some means to stimulate our brother bee-keepers, or we will not see them at our gatherings.

Conventions are for the advancement of our business and social interests, and help much to place our industry on an equal with other pursuits. It was through them that the World's Fair provisions for a honey show were made, and many premium-lists increased and revised.

The Bee-Keepers' Union owes its origin to them, and it has shown itself worthy of its parentage. Its history is one of glorious achievements from the very commencement of its existence.

Our State association is a necessity. Important matters will be continually coming before it for adjustment. So let us make an individual effort to make our future meetings, each one more interesting than the last, and more numerously attended.

M. H. HUNT.

W. Z. Hutchinson—We need to have an organization, even if it is poorly attended in times of poor seasons. It was through the influence of this organization that bee-culture was added to the list of subjects that are experimented upon at our State Experiment Station. There may be a time when we will need legislation on the subject of bee-keeping, and it can be more readily secured through the influence of a State organization.

Pres. Hunt—One or two good seasons would bring out a crowd again.

R. L. Taylor—I think that is right. If a man gets no honey, he can't afford to attend a convention.

Mr. R. L. Taylor then read a paper entitled,

Lessons in Wintering.

One of the experiments made during the past winter was planned for the purpose of bringing out as prominently as possible the comparative advantages of wintering bees in the cellar and out-of-doors without protection. In addition to that the same experiment was made to serve another purpose. A bee-keeper of long experience advised me that bees would winter well without other protection if placed against the south side of a building where the sun does double duty. I confess that influenced by former experience I had a strong leaning to that opinion myself. Accordingly I selected five colonies on the whole in every respect better than the average except that two were in 8-frame Langstroth hives instead of Heddon hives in which all the others destined to fill the out-door part of the experiment were. These were placed about three feet up from the ground against the south side of my honey-house and barn, which extended beyond them on either side about 25 feet.

These bees flew out at rather frequent intervals during the winter. On two or three occasions when the air was still, and the sun bright, they came out the hives with the thermometer at so low a point in the shade as 36°, apparently without the loss of bees. Sometimes surrounding objects were spotted slightly. Nevertheless, both the colonies in Langstroth hives died about the middle of March, and one of those in Heddon hives early in April, leaving plenty of stores, and showing moderate evidence of dysentery. The two other colonies came through in good condition every way.

This raises the question whether it is true that frequent flights prevent disastrous results from dysentery during the winter months, and also whether it is not worth while to inquire whether hives composed of two shallow sections are not better for the wintering of bees than hives with frames no deeper even than the Langstroth.

The five hives in question were weighed on the 26th of

November, at the time the rest of my bees were placed in the cellar, for the sake of making a comparison of the amount of stores consumed by bees wintered out-of-doors with that consumed by those in the cellar. They were weighed again the 14th of April, when those taken from the cellar were reweighed. The bees left in the hives in which the colonies had perished, were not removed before weighing, and the extra amount of bees lost from them outside the hives was considered to compensate for the deficiency in the amount of stores consumed. The following figures show the result of the weighing and the amount of stores consumed:

Wt. Nov. 26,	Apr. 14.	Loss in wt.	
63	47 $\frac{3}{4}$	15 $\frac{1}{4}$	L. fr's, died in March.
46	29 $\frac{3}{4}$	16 $\frac{1}{2}$	L. fr's, died in March.
54 $\frac{1}{4}$	36 $\frac{1}{4}$	18	Hed. h'v, died in April.
67	48 $\frac{3}{4}$	18 $\frac{1}{4}$	Hed. h'v, alive in April.
74	51 $\frac{3}{4}$	22 $\frac{1}{4}$	Hed. h'v, alive in April.
Total consumption		90 $\frac{1}{4}$	
Average		18 1/20	

Of the colonies weighed when they were put into the cellar Nov. 26, six were selected for this comparison as being fairly equal in strength and prosperity to the five already considered. Their weights and consumption of stores were as follows:

Wt. Nov. 26,	Apr. 14.	Loss in wt.
62 $\frac{3}{4}$	52 $\frac{1}{2}$	10 $\frac{1}{4}$
62 $\frac{1}{4}$	55	7 $\frac{1}{4}$
55 $\frac{1}{2}$	47 $\frac{3}{4}$	7 $\frac{3}{4}$
58	48 $\frac{1}{4}$	9 $\frac{3}{4}$
39 $\frac{3}{4}$	33 $\frac{3}{4}$	6
49 $\frac{3}{4}$	37 $\frac{1}{2}$	12 $\frac{1}{4}$
Total consumption		53 $\frac{1}{4}$
Average		8.875

which show a consumption of less than one-half by those wintered in the cellar as compared with those wintered outside, effecting a saving of more than 9 pounds per colony, the exact amount saved being 9.175 on each colony. This with the much greater security afforded would seem a sufficiently strong incentive for the housing of bees during winter.

Six other colonies wintered in the cellar were weighed in like manner, but are not used for comparison because they were below the average in strength, having been treated for foul brood rather late last season, but as they wintered excellently, I give the results here to show how small an amount of honey colonies may require during the winter if well housed. The first two were in two-story Heddon hives, and the others were each in a single story.

Wt. Nov. 26,	Apr. 14.	Loss in wt.
37 $\frac{1}{4}$	29 $\frac{1}{2}$	7 $\frac{3}{4}$
35 $\frac{3}{4}$	30	5 $\frac{3}{4}$
30 $\frac{1}{4}$	24	6 $\frac{1}{2}$
26 $\frac{1}{2}$	20 $\frac{1}{4}$	6 $\frac{1}{4}$
29 $\frac{1}{4}$	25	4 $\frac{3}{4}$
30 $\frac{1}{4}$	23 $\frac{1}{4}$	6 $\frac{3}{4}$
Total consumption		37 $\frac{1}{2}$
Average		6 $\frac{1}{4}$

The bees in my cellar wintered exceptionally well—better, I think, than they ever did before except when they had sugar stores. Out of about 120 I lost three, apparently from dysentery, all the rest except one or two being in excellent heart. They were unusually quiet during the winter, as well as while they were being carried out. I cannot be certain of the exact cause of this, but I surmise that it was the manner in which they were treated.

Contrary to what had been the case before, during the past winter the cistern in the cellar was allowed to contain no water, but the hygrometer kept in the cellar indicated the same degree of moisture as during the preceding winter—about 25 per cent. almost complete saturation, but I do not think now any of these conditions had anything at all to do with the well-being of the bees. This raises the question of the agency of moisture in causing dysentery, but when bees winter almost perfectly in an atmosphere well-nigh surcharged with moisture, it furnishes very satisfactory evidence to me that moisture in itself is not the cause of ill-wintering.

Another point in which the bees received somewhat different treatment, was in the amount of disturbance they were subject to from frequent visits with a light. Previously they had been visited freely without any compunctions, and disturbed by lifting covers, etc., while during the past winter visits were as infrequent and as brief as the requirements of

my experiments permitted. I have always been persuaded that such visits and consequent disturbances were not specially harmful, and I am not as yet disturbed in that opinion by this last experience.

Still another point is that in former winters I had clung to a habit which took its rise when my cellar was overcharged with bees, which had a tendency to cause the temperature to raise to a higher point than was to my liking, on account of which I fell into the practice at such times of opening a door or window of a night to let the temperature of the cellar run down, and as this seemed to have a quieting effect, I naturally thought it was a good one, but on considering the debilitated state in which many of the weaker colonies came out of winter quarters, I began to question it, and during the past winter no outside door or window was opened from the time the last of the bees were put into the cellar till the day the first were taken out, and the inner door only when it was absolutely necessary for the purposes already suggested. It was the result of this, as I am now inclined to think, that the weaker colonies—and a few were decidedly weak—wintered as well as the stronger ones.

Of course it must not be forgotten that, in an effort to attain success in the wintering of bees in a cellar, scarcely less important than sound stores is the temperature of the cellar, and the weaker the colonies, and the moister the atmosphere, the higher is the temperature required to be to insure success. During the last winter, in my cellar, the temperature was maintained almost uniformly at 45°, running down a degree or two during the coldest periods. For a cellar so damp as that, I now think 45° best. For a very dry one, 40° might do very well.

R. L. TAYLOR.

L. A. Aspinwall—Isn't it possible that the exhalations from the bees, when there were so many, had something to do with the wintering of the bees? Too many cellars are simply "holes in the ground," from which there is no exit for the carbonic acid gas.

Mr. Taylor—The bottom of my cellar is but little below the general level. If the door should be opened, the gas could run out.

W. Z. Hutchinson—How about the law of the diffusion of gases?

Mr. Aspinwall—Carbonic acid gas is heavy, and will sink to the bottom of a cellar and lie there as water lies at the bottom of a depression in the ground. If there is some opening where it can run out, and the winds drive it about, it becomes mixed with the air, and in that way there is a diffusion.

W. Z. Hutchinson—I have often noticed that the bees near the cellar bottom did not winter so well as those that were near the top of the cellar, but I supposed that it was the matter of temperature rather than that of an accumulation of gas. Those at the top are warmer.

Mr. Taylor—I am done with out-door wintering, except as a matter of experiment. I have better success in out-door wintering with hives of thin walls than I have with chaff hives. The latter become damp.

W. Z. Hutchinson—I have seen bees wintered out-of-doors with the most perfect success. There are two ladies up near Farwell, of whom I have several times bought bees, and they winter their bees out-of-doors with the most perfect success. They pack the hives thickly in chaff, and on top, over the brood-nest, is an opening several inches square, cut through the cover of the packing box, and covered with wire-cloth to keep out mice. Over all is a roof to keep out the storms. They are particular to keep the entrances from becoming blocked up with snow. It seems more pleasant to winter bees out-of-doors. There are some disagreeable features connected with in-door wintering, but, like Mr. Taylor, I have been more successful in wintering bees in the cellar than I have out-of-doors.

Mr. Taylor—To what unpleasant features do you refer?

W. Z. Hutchinson—Well, it isn't very pleasant work carrying them into the cellar and out again.

Mr. Taylor—I think I have gotten rid of most of the unpleasant features.

W. Z. Hutchinson—Please tell us about it.

Mr. Taylor—The matter of temperature has much to do with the ease with which bees can be carried into or out of a cellar. If the weather is too cool, it is just as bad as though it were too hot. What might be termed a cool, cloudy day is best. I have the hives pried loose from the bottom-boards, and a block put under the edge of each hive to hold it up. This is done sometime previous, so that the bees may be quiet at the time they are carried down. In the cellar the hives are stacked up in single piles. That is, one hive is first set down, then another on top of that, then another, etc. Then, in carrying them out, only the ones in one pile are disturbed at the same time. Sticks are placed on top of the first hive, then the next hive set on these sticks, then sticks put on top of the next hive, and the next hive on top of these sticks. In carrying them out a hive is set down upon a bottom-board, and if the bees show any disposition to leave the hive, the entrance is closed until the hive is placed upon its summer stand. There is no necessity of rushing all of the bees out at one time, and in that exhausting the strength of the one who does the work. A few may be carried out in the morning, then a few in the evening. The next suitable day, a few more may be carried out, and this can be continued until they are all out.

Mr. Aspinwall—With me the loss in weight in wintering bees has been greater in the cellar than in the open air. In open air wintering there is always a chance for the bees to fly if there comes a suitable day.

(Concluded next week.)

Questions AND Answers

CONDUCTED BY

DR. C. C. MILLER, MARENGO, ILL.

[Questions may be mailed to the Bee Journal, or to Dr. Miller direct.]

Candied Comb Honey—Keeping Honey from Candying.

1. I have some comb honey that is candied, and unfit for table use. How can I best prepare it for fall feeding? If by heating, how shall I separate the wax from the honey?

2. How can I keep honey from candying? H. M. S.

ANSWERS.—1. Melt it *very slowly*. One way is to set it on the reservoir of a cook-stove where it can never reach the boiling-point. Another way is to set it in a pan of water on the back of the stove where the water won't boil, having pieces of shingle, or something of the kind, in the dish of water under the vessel of honey. No matter if it takes several days to melt it. When cold, remove the cake of wax, and there's your honey. Of course, it will candy again if left long enough.

2. Hardly in any way to be recommended. You can heat it to 160°, and seal it while hot in fruit-jars. But if you heat it too much, you'll spoil it.

Wet Inside the Hive—Comb-Leveler.

1. I have had bees only three years, have read up considerable, made a great many mistakes, and *know* that I have yet to learn a great deal, so I ask for information. I must say that some of your answers, and a great deal of information from the American Bee Journal, have saved me many a dollar. About two months ago we had several weeks of very fine weather, so that the bees reared brood at a fine rate; for the last month it has been raining most of the time. I now have a hive full of bees, but no brood or honey, so I am feeding several colonies. I have 7 colonies in dovetailed hives with flat covers, and I find part of them very wet inside, so bad

that I can scrape the paint off the bottom-boards with a knife. Have you any way to manage to avoid this? I have one hive shellac-varnished, and the others painted inside. If I can afford it, I will shellac all I make hereafter, and will surely shellac the bottom-boards, and by keeping the hives well slanted to the front, I know that the water will not soak into the wood, but will run out at the entrance. I don't allow any water to get in from the outside, or the bees would have all been drowned long ago. I use a movable shingle roof to each hive.

2. I have seen mention made of a comb-leveler made by Mr. B. Taylor. Can you describe it to me, or inform me the easiest way to get it? LEARNER.
Oregon.

ANSWERS.—1. The matter of having trouble from having too much wet from the outside working into a hive is something that has not come within my own experience. At least not from working through the wood, although I've had trouble with cracks in covers, and have found nothing that would so effectually keep wet from coming through cracks as a covering of tin. I wonder if it isn't possible that at least some of the wet that troubled you came from the inside instead of the outside. After I commenced using tin covers I sometimes found the inside of the cover soaked, and great drops standing over it, the moisture coming from the bees themselves. The only remedy I know of for this is to have a fair slant to the hive, and to have a good-sized entrance.

2. It is an arrangement of sheet iron, kept hot by a lamp standing under it, and a section placed upon it is melted down to a certain point determined by a stop. The work is done with great rapidity and with great perfection. Having used it, I can heartily recommend it.

Transferring Bees.

Last winter I bought two colonies of bees in box-hives. They are eight miles from my place, so naturally swarming is out of the question. Now, I would like to do one of two ways, viz:

1st. Drive the bees out, *a la* Heddon, on frames with narrow starters, with sections on top. Set the boxes alongside, and put the entrances at right angles to the new hives. Turn gradually the old boxes around until the entrances are close to the front of the new hives, and in about a week or ten days remove both old boxes to a new stand, and set one on top of the other. Twenty-one days from the driving transfer to a new hive.

2nd. Drive the bees in box No. 1 on narrow starters, with sections on top, and set new hive on the stand of No. 1. Remove the good combs to a second new hive, and fill up with foundation. Move box No. 2 to a new stand; put the second new hive filled with combs and foundation on the stand of No. 2, and furnish a queen for this hive.

I could set box No. 2 alongside of this last new hive, but in such a way that the entrance is at right angles to the other, turning the box around gradually until the entrances of both the box and No. 2 are together, then in about a week remove the box to a new stand. After two or three weeks I could transfer the combs and all to a new hive.

Which do you think is best? Or is there a better plan? I could work all for comb honey, or one for comb and the other for extracting. I will not drive till about the first of June.

Oregon.

H. A.

ANSWER.—The first thing I should want to do would be to get those bees just about eight miles nearer home. For by the plans laid out, a number of visits will be needed, making much travel. However, there may be special reasons why it is not desirable, and perhaps not possible to move them now, and it may be that other business frequently takes you where the bees are. Either way you mention can be carried out, only it is not a very good plan to transfer a colony late in June with the combs full of brood and honey. Better leave the last job of transferring till next year in fruit-bloom. But you can avoid either way by adopting the first plan, which, on the whole, will probably be most satisfactory.

The Names and Addresses of all your bee-friends, who are not now taking the Bee Journal, are wanted at this office. Send them in, please, when sample copies will be mailed to them. Then you can secure their subscriptions, and earn some of the premiums we have offered. The next few months will be just the time to easily get new subscribers. Try it earnestly, at least.

THE AMERICAN BEE JOURNAL

ESTABLISHED IN 1861

THE OLDEST BEE PAPER IN AMERICA

PUBLISHED WEEKLY BY

GEORGE W. YORK & COMPANY,

118 Michigan St., - CHICAGO, ILL.

REGULAR CONTRIBUTORS :

G. M. Doolittle, of New York. Prof. A. J. Cook, of California.
 Dr. C. C. Miller, of Illinois. Dr. J. P. H. Brown, of Georgia.
 J. H. Martin, of California. Rev. E. T. Abbott, of Missouri.
 Barnett Taylor, of Minnesota. Mrs. L. C. Axtell, of Illinois.
 Chas. Dadant & Son, of Illinois.

\$1.00 a Year—Sample Copy Sent Free.

[Entered at the Post-Office at Chicago as Second-Class Mail-Matter.]

Vol. XXXVI. CHICAGO, ILL., MAY 28, 1896. No. 22.



Advantage of a Long Tongue.—The value of the bee lies in its tongue, and, as the usefulness of this member as a honey extractor is supposed to vary with its length, efforts are being made in France to develop an improved, or long-tongued, race of bees. The tongue is measured by two methods, says one of our exchanges. M. Charton uses a box having a cover of wire-netting and a slightly inclined bottom; the bees which reach through the netting and suck sweets from the bottom farthest down the incline being those with the longest tongues. The apparatus of M. Legros is a vessel of sweetened liquid, with a perforated tin-plate cover, which can be adjusted at any desired height above the liquid. Ordinary bees are found to have tongues with a length of 6.5 millimeters (about one-fourth of an inch), while those of the black French bees reach 9.2 millimeters, and those of the best American bees have a maximum length of 8.73 millimeters. The colonies whose bees extract syrup from the greatest depths are preserved as stock for reproduction.

Apis Dorsata.—Both Gleanings and the Review have recently spoken out quite plainly in regard to the importation of *Apis dorsata*. Editor Root says this :

In view of what some of the correspondents of the American Bee Journal have said, a sample of which we give in this issue, and in view of the further fact that *Apis dorsata* would be of but little or no use to us for the purpose of fertilizing the flora of this country, Gleanings is opposed to any action on the part of the general government for importing these bees to our country. It would involve considerable expense, and very little if any good would result, even if the expedition were successful. Moreover, if money is to be used by the general government for the benefit of bee-keeping, it can be much more wisely expended in other ways—for instance, the United States Experiment Station, under the wing of the Department of Agriculture; or a national honey and bee show at Washington would be more acceptable to the mass of bee-keepers.

Editor Hutchinson has this paragraph in the May number of his paper :

Apis dorsata and its importation has received some attention of late in the bee-journals. A York State Association, seconded by Prof. Cook, is in favor of asking the government to try to import these bees. E. T. Abbott, Dr. C. C. Miller,

and H. D. Cutting, in the American Bee Journal, oppose their importation. It is evident that there is a little prejudice in the matter—some think Mr. Benton is after the job, and they don't want him to get it, as he has not proved himself to be a true man. The only real, fair opposition against the scheme is that we don't know but their importation may be a mistake. The Australians wanted the rabbits, but they don't want them now. We wanted the English sparrows, but don't want them now, neither do we want any more Cyprian bees. The suggestion that they be thoroughly tested in their own country before being brought here, strikes me as reasonable.

We agree fully with Editor Root, that if the general government has any money to spend for bee-keeping, it can do so much more profitably in the directions indicated in the closing part of his editorial paragraph quoted.

California Bee-Keepers.—Rambler says in Gleanings that there are over 1,000 bee-keepers in Southern California alone. We have seen the estimate somewhere that there are 3,000 bee-keepers in the whole of that great State. If such is the case, we think we are safe in saying that not one in three of them read bee-papers. We often wonder why they, as well as bee-keepers elsewhere, do not more generally read the bee-papers. Surely, any bee-keeper can well afford one dollar a year—about 8 cents a month—for bee-literature, no matter where he lives.

Again, we are often surprised that what is sometimes called the "Bee-Keepers' Paradise"—the wonderful South—takes so little interest in reading literature devoted to bee-culture. But the very portion of our country where one would naturally expect to find the largest proportion of bee-keepers, it seems right there are the fewest readers of bee-literature. Hence it is that scarcely can a bee-paper be successfully published in that region. They fail to give sufficient support. But with the continual migration of Northern people southward, in time that defect will be remedied, and the South will become, as it should be, the greatest bee-country in the world, and its apiarists will then read, as do their more northern friends.

"California 'Strained' Honey."—Accompanying two samples of what was sold for "honey," came this letter from Mr. J. H. Wing, of Syracuse, Kans., dated May 14:

MR. EDITOR:—I send you samples of "California strained honey" that is sold and laid down in our market at a price somewhat less than will buy a good article of pure honey on the Pacific Coast by the carload.

Two parties or firms in St. Joseph, Mo., appear to be engaged in this business.

I take it the article is not honey at all, but glucose brightened with chloride of zinc.

The dark sample is several years old, and grows darker with age.

The light-colored sample is fresh, and is warranted "not to granulate," and to keep several months.

I have sent samples to several persons for the purpose of getting their opinion of the stuff, and assistance in getting suitable laws passed for the protection of producers and consumers of honey from competition of such counterfeits.

Would you mind giving it a write-up in the "Old Reliable," and telling us what you think of it?

I think I will also send samples to some of my friends who are producers and dealers in honey, and reside in California and Colorado, that they may see what is selling on the reputation they have so successfully established for first-class honey.

How long will it take to ruin our markets for extracted honey if consumers are supplied with stuff like the samples I send you?

JAMES H. WING.

The samples were received and simply sampled—that was quite enough. We doubt very much if they ever were within ten miles of a bee-hive. Surely, bees would not be guilty of putting up such vile stuff.

The dark sample looks more like ordinary cough medicine, and tastes much worse. The light colored sample tastes

pretty much as if it had been "strained" through a dish-cloth—judging from its odor, also.

No, sir, Mr. Wing, we don't "mind" giving our opinion of such things in a very plain manner. But what's the good of "opinions" when you have no law to help stop the evil? It does about as much good as a church convention "resoluting" against the diabolical saloon, and the members failing to vote against it at every opportunity. What is first needed in both cases—against adulteration and saloons—are *prohibitive laws*. Then full enforcement. With such procedure, we'll guarantee that both evils would be "cured." And we are ready to help secure both the laws and their proper enforcement.

We believe right here is a fine opportunity for the National Bee-Keepers' Union to get in some good work for honest honey-producers. It should work with State and National law-making bodies looking toward the passing of the necessary laws against adulteration. Once having the laws, then it could turn its attention and money along the line of their strict enforcement. Every bee-keeper would aid in this work. It is something practical. It *must* come before bee-keepers can hope to make the success of honey-production that they are fairly entitled to.

Let our watch-word be, *Down with honey-adulteration!* And every bee-keeper help in the fight to put the tamperers with pure honey where they belong—behind iron bars!

Bee-Keeping and Fruit-Raising.—Mr. R. Touchton delivered an address on this subject before the California Bee-Keepers' convention held at Los Angeles, in which he said:

Yes, I think the honey-bee is a friend to fruit-growers. Some trees and plants require the agency of bees or other insects to fertilize and make them fruitful. In fact, I believe that they are a benefit to all flowering trees and plants. I have been informed by good authority that the cherry orchards of this State became unfruitful after the bees were removed from the vicinity, and that they became fruitful again after the bees were brought back for that purpose, and I have read of similar instances East. Where the bees were removed out of a fruit-growing belt, the trees became unfruitful, and the orchardists were glad to get the bees back again. There are some varieties of strawberries that are not self-fertilizing, and require the agency of either the wind or bees to transmit the pollen from those that are self-fertilizing. If they were depending solely on the wind, a great deal of the pollen would waste its sweetness on the desert air.

The foot-hills that skirt the valleys of Southern California from Santa Barbara to San Diego—and I presume in many other portions of the State also (but I am only acquainted with Southern California)—should be the homes of bee-keepers and fruit-raisers, living together in harmony. Or, what would be still better, every such fruit-raiser should be a bee-keeper, and *vice versa*. There are a great many practical bee-keepers who would like to engage in the business if they could live in society and have the ordinary home comforts, such as they could have along the foot-hills of our valleys, but if they have to go back into the mountains and away from society, they beg to be excused. I have had numerous letters from Eastern bee-keepers inquiring about the business and a chance for investing in it. But when I wrote them the true facts in regard to the business as carried on here now, they were satisfied to stay at home. Therefore, in the face of the existing facts, it is time to come to the front and defend their interests as against the encroachment and opposition to the fruit-raiser, and adjust the differences existing between them if we hope to maintain our position as the banner honey State of the Union.

"Extra Pages" in one some of the bee-papers that come to our desk have been such a regular thing lately that we wonder that particular attention is called to it. Especially when it occurs that the "extra pages" are caused by putting in a whole lot that either has no bearing on bee-keeping or else has the appearance of simply filling up.

It would be very easy to fill up extra pages in the Bee

Journal with good matter, but we believe we give in each number all that can be profitably read. Bee-papers are not to be read like story-papers—simply to pass away the time; but each article should be read slowly and digested, else the time would be wasted, at least for some readers.

Then there has been some talk about what color of cover shall be used on some of the bee-papers. Happily the Bee Journal is not troubled with that question. Its "cover" seldom changes, so its friends are able to recognize it at all times. But tinted covers are hardly expected on *weekly* publications. They are an expensive luxury, any way.

Natural Stores Preferred.

For several years I have kept a record of sugar-fed colonies, and I have been slowly forced to the conclusion that, under present conditions, natural stores are the best. Occasionally, when honey is of poor quality, sugar stores are the safest; but such years have lately been the rare exception, and our best results, on the average, come from hives heavy with natural stores in the fall. With small brood-chambers a larger proportion of the honey will be stored for market; but where will be the gain if sugar has to be returned for winter? Even if we grant that it can be fed so early as to promote a sufficient brood-rearing to maintain the normal strength of the colony, the extra amount consumed will more than counterbalance the difference in price per pound. The hundreds of tons of honey thus yearly thrown upon the market by the exchange of sugar for honey must make some difference in present prices—quite likely more than any of us surmise.—P. H. ELWOOD, in *Gleanings*.

The Mating of Queens.

QUESTION.—Do queens of second swarms "mate" before or after they lead out a swarm? I see one of our "bee-lights" says that "perhaps they may mate before going out with the swarm."

ANSWER.—If any bee-keeper of any prominence puts forth the claim that any queen leading out any after-swarm may mate the drone, or become fertile, before she leads the swarms, it is something I should not expect, and shows that he or she cannot have looked into the matter very thoroughly. I have made swarming and queen-rearing a study for the past 20 years, spending hours, days and weeks upon it; and if any queen was ever fertilized, or even flew out to meet the drone while there were other young queens in the cells, it is something I have never noticed, and something that all of my experiments go to prove never happens. All know that after-swarming comes only from a plurality of queens in the hive, and these queens are always those which have never been out of hive at all, except as they may have gone out with an after-swarm, and been returned by the apiarist. As a rule, during after-swarming, all young queens which would naturally emerge from the cells, except the first hatched, are kept in the cells by a guard of bees which feed them through a small opening in the cell, made by the young queen trying to bite the cover off; and these queens are constantly quawking because they are kept prisoners; and the one which has her liberty is piping back in her enraged condition—enraged because the bees keep her from destroying these quawking inmates of the cells.

While such a state of things as this is kept up in the hive, no queen has any desire to mate, and no after-swarming is ever conducted except under just such a state of affairs. In one or two instances, where after-swarms had been kept back for several days by unfavorable weather, and where only one queen went with the after-swarm, I have had every evidence to believe that said queens were fertilized while out with the swarm, as I saw them entering with the drone-organs attached to them, and they were laying two days afterward. But the rule is, that all queens accompanying after-swarms wait about their wedding-trip until they are established in their new home, when, in two to four days after hiving, on some pleasant afternoon, the bees will come out for a playspell, and the queen be seen to leave the hive to mate.—G. M. DOOLITTLE, in *Gleanings*.

The McEvoy Foul Brood Treatment is given in Dr. Howard's pamphlet on "Foul Brood; Its Natural History and Rational Treatment." It is the latest publication on the subject, and should be in the hands of every bee-keeper. Price, 25 cents; or clubbed with the Bee Journal for one year—both for \$1.10.

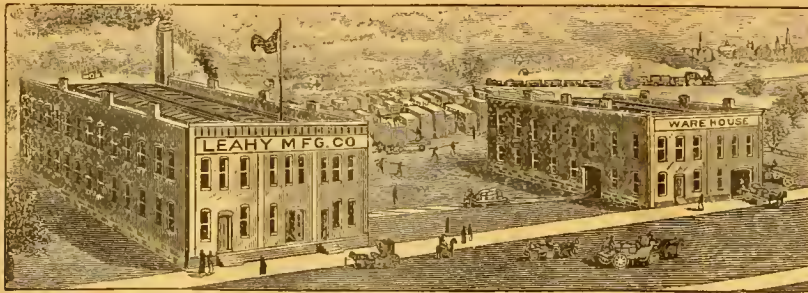

Largest Factory in the West COMPLETE STOCK. Good Supplies and Low Prices. Our Motto.

READ THIS—Mr. Keyes says: The 100 pounds of Extra-Thin Foundation you sent us is superior to anything he ever saw; and I think the same. R. L. TUCKER, Wewahitchka, Fla.
 Dear Sirs:—The Sections came duly to hand. Indeed, they are very nice. Yes, sir; they are as good as the best. CHARLES H. THIES, Steelville, Illinois.
 Leahy Mfg. Co.:—I have received the bill of goods. I must say they are the choicest lot of Hive-Stuff I have ever received from any place. I admire the smoothness of your work, and your close selection of lumber. Yours very truly, O. K. OLMSTEAD, Orleans, Nebr.
 Dear Sirs:—The Sections arrived in due time, and are all O. K. so far as examined. They are simply perfection. I can't see how you can furnish such goods at such low prices. I hope you may live long and do well. Yours respectfully, Z. S. WEAVER, Courtney, Tex.
 Gents:—I received the "Higginsville Smoker" all O. K. It's a dandy; please find enclosed stamps for another. Yours truly, OTTO ENDERS, Oswegatche, N. Y.
 Gentlemen:—I have bought Supplies from nearly all the large manufacturers by the carload, and I must say yours are as good as the best. Indeed, in many lines they are the best. It is a pleasure to handle them. E. T. FLANAGAN, Belleville, Illinois.
 The above unsolicited testimonials are a fair sample of hundreds we receive. Our prices are reasonable and the "Higginsville Goods" are the best.
The "Higginsville" Goods are for sale by the following parties:
 Chas. H. Thies, Steelville, Ill. E. T. Flanagan, Belleville, Ill.
 Henry L. Miller, Topeka, Kans. E. A. Seeley, Bloomer, Arkansas.
 J. W. Rouse & Co., Mexico, Mo. P. J. Thomas, Fredonia, Kans.
 Fulton & Gregg, Garden City, Kans. W. J. Finch, Jr., Springfield, Ill.
 If you need a Carload of Supplies, or only a Bee-Smoker, write to us. Remember, we are here to serve you, and will, if you give us a chance. **A Beautiful Catalogue Free.**
 Address, **LEAHY MANUFACTURING CO., HIGGINSVILLE, MO.**
 49A *Mention the American Bee Journal.*

PATENT WIRED COMB FOUNDATION
 Has No Sag In Brood-Frames
Thin Flat-Bottom Foundation
 Has No Fishbone in the Surplus Honey.
 Being the cleanest is usually worked the quickest of any Foundation made
J. VAN DEUSEN & SONS,
 Sole Manufacturers,
 Sprout Brook, Montgomery Co., N. Y.
Mention the American Bee Journal

ONE MAN WITH THE UNION COMBINATION SAW
 Can do the work of four men using hand tools, in Ripping, Cutting-off, Mitring, Rabbeting, Grooving, Gaining, Dadoing, Edging-up, Jointing Stuff, etc. Full Line of Foot and Hand Power Machinery Sold on Trial. Catalogue Free.
SENECA FALLS MFG. CO.,
 46 Water St., SENECA FALLS, N. Y.
 1A1y *Mention the American Bee Journal.*

Dadant's Foundation in Chicago!
 No other Goods kept here. Send for Price-List,
CHAS. DADANT & SON,
 118 Michigan St., CHICAGO, ILL.
 13Atf Please mention the Bee Journal.

BEES, QUEENS,
 and Several Carloads of
APIARIAN SUPPLIES
 always on hand.
 Brood Found., 42c lb.; Section, 50c lb.
I. J. STRINGHAM,
 105 Park Place. NEW YORK, N. Y.

That Queen-Clipping Device Free!
Works Like a Charm.
 The Monette Queen-Clipping Device WORKS LIKE A CHARM. With it I have clipped 30 queens, all in one day, when examining my bees. WM. STOLLEY, Grand Island, Nebr.
Couldn't Do Without It.
 I have clipped 19 queens, and must say the Monette Queen-Clipping Device is by far the best invention ever made, and will be welcome to many bee-keepers as it was to me. I could not do without one now.
 DR. GEO. LACKE, Newburgh, Ind.
PLEASE READ THIS OFFER TO PRESENT SUBSCRIBERS:
 Send us just one new name for the American Bee Journal a year (with \$1.00), and we will mail you the Queen-Clipping Device FREE of charge. Or, the Queen-Clipping Device will be sent postpaid for 50 cts. But why not get it as a Premium by the above offer? You can't earn 50 cts. any easier. Almost every bee-keeper will want this Device. See page 130 (Feb. 27) for full description of it. Complete directions accompany each one sent out. It is a most ingenious and useful article. Address,
GEORGE W. YORK & CO., 118 Michigan St., Chicago, Ill.

Question-Box.

In the multitude of counsellors there is safety.—Prov. 11-14.

Forcing the Bees into the Sections.

Query 15.—Which is the most economical and all around the best way to force bees into the sections, etc. viz.: The Heddon divisible brood-chamber method, or by feeding the brood-chamber full of sugar syrup early in the season, or by contraction?—WISCONSIN.

- Rev. M. Mahin—Contraction.
- Prof. A. J. Cook—The first and third are best.
- J. M. Hambaugh—Of this I am not sure. All these methods are practiced.
- C. H. Dibbern—I don't know, but I think judicious feeding is the most practicable.
- Chas. Dadant & Son—Let the bees go up naturally, by allowing them to breed plentifully.
- Mrs. L. Harrison—They need no forcing when honey is abundant. Feeding, if anything.
- Dr. C. C. Miller—Neither one is necessary. Put a bait section in the super, if anything is necessary.
- W. R. Graham—Get the hive chock-full of bees until there is no room for them in the brood-chamber.
- Allen Pringle—Keep out the syrup. Contraction of the brood-chamber, or other methods, as the circumstances may require.
- G. M. Doolittle—Use a suitable hive and sections, and the bees will enter them without "force" when there is nectar in the flowers.
- W. G. Larrabee—I have never used any of the above methods. A good honey-flow will force them into the sections soon enough for the good of the colony.
- R. L. Taylor—If you will have a mixture of black or German blood in your bees, they will need no "forcing"—they will be in the sections when the honey-flow comes.
- Eugene Secor—I don't know—I never tried the feeding method. But the contraction method, either by the Heddon plan or otherwise, will put about all the honey in the supers, if you want it there.
- B. Taylor—A moderately small hive crammed full of bees, and the supers at least half filled with drawn comb. This ends all doubt about getting the bees into the supers, provided there is any honey in the flowers.
- E. France—I don't know. I will tell you what I have done, and it worked well: When the bees were strong, and about to swarm, destroy the queen-cells, and then cage the queen in a section-box in the center of the super.
- Dr. J. P. H. Brown—The "best way" depends much upon the character of the colony to be operated on. Strong colonies, and supers placed on early, will do the work in most of cases. With some, the plans you name may work well.
- P. H. Elwood—I am inclined to think that expansion of the bees is better than contraction of the bee-hive for forcing bees into sections. As a rule, our colonies in hives containing 8 frames commenced first in the boxes and produced

BUY "DIRECT FROM FACTORY," BEST MIXED PAINTS

At WHOLESALE PRICES, Delivered FREE For Houses, Barns, Roofs, all colors, and SAVE Dealers profits. In use 54 years. Endorsed by Grange & Farmers' Alliance. Low prices will surprise you. Write for Samples. O. W. INGERSOLL, 289 Plymouth St., Brooklyn, N. Y.

12A13 Mention the American Bee Journal.

MURDERED

We have killed high prices. Give me a trial order and be convinced that good Queens can be reared for 50 cts. each. Untested, 50 cts.; Tested, 75 cts. Golden Italians, 3-Banded Italians, and Silver-Gray Carniolans, all the same price. Best of References given.

C. B. BANKSTON,

13A1f CHRISMAN, Burleson Co., TEX.

Mention the American Bee Journal.

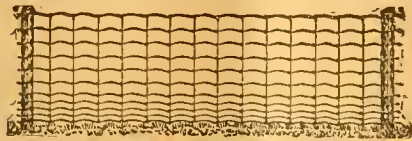

ALEXANDER WEPT

For other worlds to conquer. Alex should have changed his name, got a new tin sword and taken another whack at this same old world. That's the way some fence men do, but the PAGE conquests cause no weeping on either side and a "return engagement" is always welcome.

PAGE WOVEN WIRE FENCE CO., Adrian, Mich.

WHEN ANSWERING THIS ADVERTISEMENT, MENTION THIS JOURNAL.

A New Method

of refining wax without acid.

Result Better

Comb Foundation.

My prices are also the lowest.

A Job-Lot of No. 2

Polished Sections

Equal in finish to any No. 1's. 1 M. \$1.75; 2 M. \$3.40; 3 M. \$4.50; 5 M. \$7.50. Or I can furnish a cheaper quality. Also, a full line of

HIGGINSVILLE SUPPLIES.

See my List with prices.

W. J. FINCH, Jr., SPRINGFIELD ILLS.

Mention the American Bee Journal.

IF YOU WANT THE

BEE-BOOK

That covers the whole Apicultural Field more completely than any other published, send \$1.25 to Prof. A. J. Cook, Claremont, Calif., for his

Bee-Keeper's Guide.

Liberal Discounts to the Trade.

California

If you care to know of its Fruits, Flowers Climate or Resources, send for a Sample Copy of California's Favorite Paper—

The Pacific Rural Press

The leading Horticultural and Agricultural paper of the Pacific Coast. Published weekly, handsomely illustrated, \$2.00 per annum. Sample Copy Free.

PACIFIC RURAL PRESS,

220 Market St., - SAN FRANCISCO, CAL.

TEXAS QUEENS.

If you are in need of Queens, let me have your order. Price-List Free.

8A26t J. D. GIVENS, Lisbon, Tex.

Mention the American Bee Journal.

the most honey the past season. Had we contracted these to seven or six frames, they would have swarmed and stored but little honey. A weaker colony can often be forced into boxes by contraction. Feeding syrup at that time is not to be thought of.

Emerson T. Abbott—I would not use the Heddon divisible brood-chamber, feed the brood-chamber full of sugar syrup, nor contract. I would use an ordinary 8-frame hive, put the super on at the proper time, and let the bees have their own way about it.

J. E. Pond—Neither plan would operate in my own locality. Force the bees to fill the top of the frames close up to the top-bar with brood, and there will be no trouble in getting them into the sections. Exact close spacing will do this, or does it with myself.

James A. Stone—I think the best way is by having no more than separators between alternate sections, and then ventilate the upper part of hive, and I have found no trouble in their going to work above as soon as they ought, without neglecting the lower part of the hive.

H. D. Cutting—If your bees are in good spring condition, you will not have to resort to a Heddon brood-chamber. If you fill your brood-chamber with syrup, you will defeat just what you are trying to accomplish; and just at this time contraction is bad, unless you want more swarms.

G. W. Demaree—The best way to induce bees to enter the surplus department of the hive is to put on your surplus cases a little ahead of the honey-flow, then be sure you have plenty of bees to spare from the breeding department, and above all, order a good, rich and deep honey-flow. All the rest is "rot."

Queens and Queen-Rearing.

If you want to know how to have queens fertilized in upper stories while the old queen is still laying below; how you may safely introduce any queen, at any time of the year when bees can fly; all about the different races of bees; all about shipping queens, queen-cages, candy for queen-cages, etc.; all about forming nuclei, multiplying or uniting bees, or weak colonies, etc.; or, in fact, everything about the queen-business which you may want to know—send for Doolittle's "Scientific Queen-Rearing"—a book of over 170 pages, which is as interesting as a story. Here are some good offers of this book:

Bound in cloth, postpaid, \$1.00; or clubbed with the BEE JOURNAL for one year—both for only \$1.75; or given free as a premium for sending us three new subscribers to the BEE JOURNAL for a year at \$1.00 each.

Bee-Keeper's Photograph.—We have now on hand a limited number of excellent photographs of prominent bee-keepers—a number of pictures on one card. The likeness of 49 of them are shown on one of the photographs, and 121 on the other. We will send them, postpaid, for 50 cents each, mailing from the 121 kind first; then after they are all gone, we will send the 49 kind. So those who order first will get the most "faces" for their money. Send orders to the Bee Journal office.

The Bee-Keepers' Guide:

Or Manual of the Apiary,

BY PROF. A. J. COOK.

This 15th and latest edition of Prof. Cook's magnificent book of 460 pages, in neat and substantial cloth binding, we propose to give away to our present subscribers, for the work of getting NEW subscribers for the American Bee Journal.

A description of the book here is quite unnecessary—it is simply the most complete scientific and practical bee-book published today. Fully illustrated, and all written in the most fascinating style. The author is also too well-known to the whole bee-world to require any introduction. No bee-keeper is fully equipped, or his library complete, without "THE BEE-KEEPER'S GUIDE."

Given For 2 New Subscribers.

The following offer is made to PRESENT subscribers only, and no premium is also given to the two new subscribers—simply the Bee Journal for one year:

Send us Two New Subscribers to the Bee Journal (with \$2.00), and we will mail you a copy of Prof. Cook's book FREE as a premium. Prof. Cook's book alone sent for \$1.25, or we club it with the Bee Journal for a year—both together for only \$1.75. But surely anybody can get only 2 new subscribers to the Bee Journal for a year, and thus get the book as a premium. Let everybody try for it. Will you have one?

GEORGE W. YORK & CO.,

CHICAGO, ILLS.

A Bargain—EARLY QUEENS.

119 Colouies Italian Bees in Chaff Hives: two acre land; good house; excellent well.

Early Queens—Tested, \$1.00; Untested, 50c. Sent by return mail.

E. L. CARRINGTON,

16A1f PETTUS, Bee Co., TEX.

Reference—1st National Bank of Beeville.

Mention the American Bee Journal.

CARLOADS

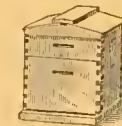

Of Bee-Hives, Sections, Shipping-Cases, Comb Foundation, and Everything used in the Bee-Industry.

I want the name and address of every Bee-Keeper in America. No reason why you cannot do business with me. I have Cheap Lumber and Experienced Workmen; a good Water-Power Factory and know how to run it. I am supplying Dealers as well as consumers. Why not you? Send for Catalogues, Quotations, etc. W. H. PUTNAM, 1E RIVER FALLS, Pierce Co., WIS.

Mention the American Bee Journal.

Page & Lyon Mfg. Co.,

NEW LONDON, WIS., operates two saw-mills that cut, annually, eight million feet of lumber, thus securing the best lumber at the lowest price for the manufacture of bee-keepers' supplies. They have also just completed one of

The Largest Factories,

and have the latest and most improved machinery for the manufacture of Bee-Hives, Sections, etc., that there is in the State. The material is cut from patterns, by machinery, and is absolutely accurate. For Sections, the clearest and

The Whitest Basswood

is used, and they are polished on both sides. Nearness to pine and basswood forests, and possession of mills and factory equipped with best machinery, all combine to enable this firm to furnish the best goods at

The Lowest Prices. ♡

For instance, it has a job lot of 200,000 No. 2 Sections that will be sold at 50 cts. per 1,000; or 2,000 Snow-White Sections will be sold for \$4.00, and larger quantities at still lower prices. Send for Circular and see the prices on a full line of supplies. 16A1f

Mention the American Bee Journal.

Abbott's Space.

Sections as low as the lowest for good goods. Send for Circular and say what you want. Special Agent for G. B. Lewis Co.'s goods. Write for prices. E. T. Abbott, St. Joseph, Mo.

The "St. Joe" stands at the TOP. Dovetailed Hives VERY CHEAP. Dadant's New Process Foundation at Dadant's prices, WHOLESALE and RETAIL.

SECTIONS CHEAP!

In order to reduce stock we will sell

40,000 4 1/4 x 4 1/4 x 2 40,000 4 1/4 x 4 1/4 x 1 15/16 250,000 4 1/4 x 4 1/4 x 1 1/2
150,000 4 1/4 x 4 1/4 x 1 1/4 80,000 4 1/4 x 4 1/4 x 7-to-ft,

Of our No. 2, One-Piece, Open-Top Sections, at the following Low Prices:

1,000 for \$1.00; 3,000 for \$2.50; 5,000 for \$3.75.

These Sections are all of good quality and manufacture, and prices will be maintained for a short time only.

G. B. LEWIS CO., WATERTOWN, WIS.

Be sure to mention the American Bee Journal when you write.

Sweet Clover 1/2 Canada.

At the following prices:

5 lbs. 10 lbs. 25 lbs. 50 lbs.
\$1.00 \$1.60 \$3.75 \$7.25.

Also a quantity of Motherwort and Catnip seed. Prices on application.

EGGS for Hatching. Buff Leghorns, Indian Games, & Light Brahmas. Choice Birds. A breeder for 30 years. Prices on application

JOHN McARTHUR,

881 Yonge Street, - TORONTO, ONT.
15Atf Mention the American Bee Journal.

J. W. TAYLOR

-HAS THE BEST-

Italian Queens for Sale

Untested, ready now, 75c. apiece; 6 for \$4.25, or 12 for \$8.00. Tested, \$1.25. Select Tested, best, \$2.00. Pay for Queens on arrival. I guarantee safe arrival and satisfaction.
14A9t **OZAN, ARK.**

WHEN ANSWERING THIS ADVERTISEMENT, MENTION THIS JOURNAL.

Honey-Clovers & Buckwheat SEED FOR SALE.

We have made arrangements so that we can furnish seed of several of the Clovers and Japanese Buckwheat, by freight or express, at the following prices, cash with order:

	5lb	10lb	25lb	50lb
Alsike Clover	\$.70	\$1.25	\$3.00	\$ 5.75
Sweet Clover	.75	1.40	3.25	6.00
White Clover	1.25	2.00	4.50	8.00
Alfalfa Clover	.65	1.10	2.70	5.00
Crimson Clover	.55	.90	2.00	3.50
Jap. Buckwheat	.20	.35	.90	1.25

Prices subject to market changes.

Add 25 cents to your order, for cartage, if wanted by freight.
Your orders are solicited.

GEORGE W. YORK & CO.,
CHICAGO, ILLS.



BINGHAM SMOKERS

Best on Earth and Cheapest.

Doctor, 3 1/2-in. stove, by mail, \$1.50; Conqueror, 3-in., \$1.10; Large, 2 1/2, \$1; Plain, 2, 70c; Little Wonder, 2, wt 10 oz, 60c
Bingham & Hetherington
Honey-Knives, 80 cents.

T. F. BINGHAM,
23Dtf Farwell, Mich.

For Sale HOME, APIARY, —QUEENS.—

1/2 Block of ground, some fruit, GOOD 6-room dwelling, shop, stable, honey-house and poultry-house (over 3,000 square feet of floor), 100 colonies of bees in chaff hives and fully equipped for comb honey, all in town of 1000 population and good alfalfa range and good water. Price, \$3,000. If unsold June 15th, will unqueen, and offer 2 year clipped queens at 25c.: 1 year, unclipped, at 50c. each. July 15th and after, young queens at 60c. each—all Italian and safe arrival guaranteed. This is a rare bargain, but I must get my wife to a lower altitude. Book your orders at once if you want these queens.
19Atf **R. C. AIKIN, Loveland, Colo.**



Promptness Is What Counts!

Honey-Jars, Shipping-Cases, and everything that bee-keepers use. **Root's Goods at Root's Prices,** and the best shipping point in the country. Dealer in Honey and Beeswax. Catalogue Free.

Walter S. Ponder
162 Mass. Ave. INDIANAPOLIS, IND.

Mention the American Bee Journal.

Queens for Sale

Italian Queens—after May 15—Untested, 75c. each; 6 for \$4.00; 12 for \$7.20.

Safe arrival and satisfaction guaranteed.

Reference—George W. York & Co. Address,

F. GRABBE,
LIBERTYVILLE, ILL.,

Mention the American Bee Journal.

HONEY We have a large amount of Pure No. 1 Alfalfa we will sell cheap.

Wax Wanted.

Boss bee-escape Warranted the best, simplest and quickest Escape on the market. Sent postpaid to any address for 30 cts. It can be returned at our expense if it is not as represented, or we will send the Escape on trial to any bee-keeper wishing to test it in good faith. We are agents for the **Ferguson Patent Hive** with double-case Super and Wicket-Gate Honey-Board, with the Escape. It is the easiest, quickest hive to handle for the production of comb honey. Address,

E. S. LOVESY & CO.,
355 6th East St., SALT LAKE CITY, UTAH.
Mention the American Bee Journal. 9Atf

BEGINNERS.

Beginners should have a copy of the Amateur Bee-Keeper, a 70-page book by Prof. J. W. Rouse. Price 25 cents; if sent by mail, 28c. The little book and the Progressive Bee-Keeper (a live, progressive 28-page monthly journal) one year, 65c. Address any first-class dealer, or

LEAHY MFG. CO., Higginsville, Mo.

Canada Up-to-date Bee-Supplies

I make a full line of at rock-bottom prices. Send for my annual Circular. A 12-inch Round Fdn. Mill in good order, 2nd hand, at a bargain for either Wax or Cash. Address,

W. A. CHURCHESLEB, Chatham, Ont.
19A4t Mention the American Bee Journal.

PERSONAL MENTION.

MR. R. McKNIGHT, we regret to see by the May Review, has lost his wife by death.

MRS. EFFIE BROWN, of Eau Claire, Wis., is the wide-awake editor of the department of "Bees and Honey" in the Northwestern Agriculturist. She makes it very interesting. Knows how.

MR. F. A. SNELL, of Milledgeville, Ill., is one of our oldest readers. In a recent letter he says: "I have all the numbers since 1867 of the "Old Reliable." Loug may its banner wave. My bees are in good condition."

MR. W. J. FARR, of Los Angeles county, Calif., wrote thus in a letter dated May 14: "You need not fear that California will glut the Eastern market with honey this year, unless from honey held over from last year. I am feeding my 540 colonies at this date. No swarming."

MR. F. L. THOMPSON, of Arvada, Colo., is fast becoming one of the few voluminous writers on apiculture. In the last Bee-Keepers' Review he fathers no less than three different contributions. He is well known to Bee Journal readers also. But probably the two Americans who write the most on the subject of bees are Mr. Doolittle, of New York, and Dr. Miller, of Illinois.

MR. W. T. RICHARDSON, President of the California Bee-Keepers' Exchange, while stepping from a moving train at Santa Paula, on the evening of April 10, was thrown so violently to the ground as to be rendered unconscious for several minutes. His condition has been extremely critical for several days, and at this writing he is not considered wholly out of danger.—Gleanings.

DR. A. B. MASON, of Toledo, Ohio, Secretary of the North American Bee-Keepers' Association, has been suffering with a severe attack of sciatica for nearly four weeks. In a letter he writes, "Don't talk to me about pain—I know him, PERSONALLY, and WELL." We are glad to know Dr. M. is recovering from the attack, and is hard at work on the program and arrangements for the next meeting of the North American, to be held at—(?). Quite likely it will be Lincoln, Nebr.

REV. EMERSON T. ABBOTT, of St. Joseph, Mo., has written a very interesting article on "Missouri Bee-Keeping: Its Extent, Pleasures, Profits and Possibilities," which was recently published in 50 county papers in Missouri. It was illustrated with seven engravings, and should do much to place bee-keeping in its proper light before Missouri readers. Seems to us others might well follow Mr. Abbott's example. It would help much to get people interested in the product of the hive. And that might aid in creating a larger demand for it. Mr. Abbott has done a good thing for the honey-producers of his State.

FULL COLONIES

Of Italian Bees for \$4.00. Are worth twice the money. Queens bred from fine imported mother. Langstroth frames: 10-frame hives. All combs built on foundation in wired frames and perfect. Can't possibly break down in shipment. I have been keeping bees as a specialty for many years, and wish to retire from business. A rare chance to get superior colonies cheap. No circular. Send the price and get your bees. See the following from Mr. T. C. Potter, Indianapolis, Ind.:

"April 21st, 1896, Mr. T. H. Kloer, Dear Sir:—The colony of bees came last evening. It is perfectly satisfactory. In fact, I have bought bees off and on for 15 years, and do not know that I ever have purchased a nicer colony at the time of year, or for such a moderate price. . . . I found the queen readily. The bees were very gentle, not one offering to sting. So I fancy I have a gentle strain—just what I wanted. Now I thank you very much for giving me a good colony for so small a price, and for packing them so that they could be opened up so readily. . . . If any one wants recommendation, refer to me."

Address. **T. H. KLOER,**
426 Willow St., TERRE HAUTE, IND.
20Atf Mention the American Bee Journal.

♦ MONEY SAVED IS MONEY GAINED. ♦

THE ROYAL UNION Life Insurance Company DES MOINES, IOWA.

The Iowa Policy

Is one that definitely promises to keep an accurate account with you; credit your premiums and interest, charge the actual expense and mortuary cost, and hold the remaining funds subject to your order.

Agents Wanted.

JOHN B. KING, GENERAL AGENT,
Suite 513 First Nat'l Bank Bld'g.
20Atf **CHICAGO, ILL.**

Mention the American Bee Journal.

The Patent Wood-Veneer Foundation.

Bee-keepers should give it a test, and my All-Wax Foundation. I will guarantee there is no better made, as six years ago I discarded the old way of dipping for wax sheets, and a new invention of my own was discovered, which enables me to make the toughest kind of Foundation; also, no acid used to purify the Beeswax, and it preserves the smell of honey, which is more acceptable to the bees. Now is the time to send wax and have it worked up at low prices. Send for Samples and Catalog with low prices. Wax wanted at 31c cash, or 33c trade, delivered.

AUG. WEISS, Hortonville, Wis.
12A13t Please mention the Bee Journal.

Mention the American Bee Journal.

1,000 Teachers' Oxford Bibles

Were bought for spot cash by a Chicago firm from an Eastern publisher who was about to be driven to the wall for the want of ready money. More than a million of these same Bibles, in every way like the illustration, have been sold during the past few years at three times the money we ask for them.

They are the genuine Teachers' Oxford Bibles, Divinity Circuit, round corners, gilt edges, complete teachers' helps, maps, 1,350 pages, bound in French seal, limp, with perfectly flexible backs. Sent prepaid.

Regular price, \$4.50; our price, \$2.25. Or we club it with the Bee Journal for one year—both for only \$2.75; or we will give this fine Bible free as a premium to any one sending 4 new subscribers to the Bee Journal one year (with \$4.00). No additional premium is given the new subscribers—simply the Bee Journal one year to each of them.

GEORGE W. YORK & CO.,
CHICAGO, ILLS.

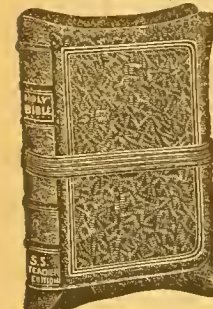

of the other, until I lessened the number materially. I then went to feeding them, having a quantity of the "Golden" feeders, thanks to Mr. G. for the description of his feeder, and also the American Bee Journal for the notice of the feeder that I received in it. By the way, the American Bee Journal has been a great help to me.

Well, I got the bees put away for winter by Thanksgiving Day—35 packed out-doors, with the feeder and hive cover combined. Nearly all seemed to winter well, but I lost a number in the spring, of old age and short of stores. Of the 16 in the cellar, some of them with scarcely any honey at all, I fed them all winter once a week, and 15 came out all right, the strongest in numbers of any I have. I am expecting them to commence to swarm soon. The Golden combined feeder and hive-cover is the thing for wintering bees.

It was feared that the combs would get moldy, but I saw only a very little, and that in the bottom of the lower hive where one hive was under the other, with the lower entrance closed.

The prospects now look very encouraging for a honey crop this season. Bees are breeding up fast, and the young bees are out making the air bum. White clover is springing up thick, and everything is very forward for the time of year. There are but a few bees around here. The people will not feed them or read about them. A. F. CROSBY.
Sheffield, Iowa, May 14.

Sweet Harp of Bee-Keeping.

The sweet harp of bee-keeping hangs low on the willow tree. Bees did not, last season, gather honey enough to board themselves in this section of country; consequently, the colonies are few and weak at this time. But the old Bee Journal is not weak, and it is interesting to note therein the ups and downs along the honey line, from Main to California, and from Washington to Florida; and may it never weaken, but ever grow strong in the sweet cause to which it is devoted. J. L. SEXTON.

Elkhart, Wis., May 19.

Water-Hyacinths for Bees.

A great many bee-keepers are troubled with their bees going into water buckets, troughs for watering stock, and other places, where they are in the way, seeking water, and in the warm, dry weather we all know they consume a great deal. I want to give a plan that will do away with all this annoyance. Take a whisky barrel, saw in two in the center, and locate it in a position to suit, no matter if in the hottest of sun. Fill half full of well-rotted manure or rich soil, then procure some bulbs of the water-hyacinth (*Pontederia grassipes*); place them in the tubs, and fill with water. In three weeks the top of the tubs will be covered with the foliage of the plants, and under the foliage the bees crawl and sip water without let or hindrance, never a bee getting drowned.

The whisky barrel, if sawed down (after being sawed in two), say 6 inches off the top of each would do better, the roots would strike the water sooner. In the absence of the barrel, any good, stout box will do. It is best to start the

plants where you have only two or three bulbs, in a smaller vessel, and transplant to the larger vessel as they grow larger. To keep through the winter, keep the roots always moist. They should be put into a green house and kept moist during the winter, or they can be taken to the cellar, the tub inverted on the ground, and they will come out all right in the spring.

Remember when you put the plants in the water they are planted, the roots will find the soil below in due time, and when the long, full spikes of superlatively beautiful flowers appear, no praise can be too high for them. After they begin blooming you can get half a dozen fine spikes any time you go for them. When the tub gets too full, they must be thinned out, or they will quit blooming. Keep the tub full of water, as it evaporates rapidly. R. P. JOHNSON.

Lee Co., Georgia.

Not a Flattering Outlook.

I put into winter quarters 45 colonies of bees, and I now have 33. They died of starvation mostly. The outlook here for honey this season is not flattering. We will have no white clover, and have had none for two years past. There is less clover in the fields this year than common. The basswood looks as if it would be full of bloom, which will be our only source for honey. All the honey I got last year was from basswood, and that from 25 colonies, in all 200 pounds. If I get that much this season I will feel satisfied. I have bought no supplies this season, as I have enough left over, unless the season is better than I think it will be. I sold my honey at home and realized 16 cents per pound for it. IRA ADAMSON.

Winchester, Ind., May 20.

Hard for Bees to Live.

I have 33 colonies now, the same as I had last year minus one. Bees did not swarm any in 1895. There was a good deal of white clover last year, but bees worked on it scarcely any. There is scarcely any white clover this year. I don't see how the bees will make a living, as we have no basswood and not much clover of any kind.

NOAH THOMAS.

Horatio, Ohio, May 18.

List of Honey and Beeswax Dealers.

Most of whom Quote in this Journal.

Chicago, Ills.

R. A. BURNETT & Co., 163 South Water Street.

New York, N. Y.

HILDRETH BROS. & SEGELKEN,
120 & 122 West Broadway.
CHAS. ISRAEL & BROS., 486 Canal St.

Kansas City, Mo.

C. C. CLEMOMS & Co., 423 Walnut St.

Buffalo, N. Y.

BATTERSON & Co., 167 & 169 Scott St.

Hamilton, Ills.

CHAS. DADANT & SON.

Philadelphia, Pa.

WM. A. SELSER, 10 Vine St.

Cincinnati, Ohio.

C. F. MUTH & SON, cor. Freeman & Central avs.

BEE-BOOKS

SENT POSTPAID BY

George W. York & Co.,
Chicago, Ills.

Bees and Honey, or Management of an Apiary for Pleasure and Profit. by Thomas G. Newman.—This edition has been largely re-written, thoroughly revised, and is "fully up with the times" in all the improvements and inventions in this rapidly-developing pursuit, and presents the apiarist with everything that can aid in the successful management of an apiary, and at the same time produce the most honey in an attractive condition. It contains 250 pages, and 245 illustrations—is beautifully printed in the highest style of the art, and bound in cloth, gold-lettered. Price, \$1.00.

Langstroth on the Honey-Bee, revised by Dadant.—This classic in bee-culture, has been entirely re-written, and is fully illustrated. It treats of everything relating to bees and bee-keeping. No apiarist's library is complete without this standard work by Rev. L. L. Langstroth—the Father of American Bee-Culture. It has 520 pages; bound in cloth. Price, \$1.25.

Price, postpaid, \$1.25.

Bee-Keepers' Guide, or Manual of the Apiary, by Prof. A. J. Cook, of the Michigan Agricultural College.—This book is not only instructive and helpful as a guide in bee-keeping, but is interesting and thoroughly practical and scientific. It contains a full delineation of the anatomy and physiology of bees. 460 pages; bound in cloth and fully illustrated.

Price, postpaid, \$1.25.

Scientific Queen-Rearing, as Practically Applied, by G. M. Doolittle.—A method by which the very best of Queen-Bees are reared in perfect accord with Nature's way. 175 pages, bound in cloth, and illustrated. Price, \$1.00.

A B C of Bee-Culture, by A. I. Root.—A cyclopaedia of 400 pages, describing everything pertaining to the care of the honey-bees. It contains 300 engravings. It was written especially for beginners. Bound in cloth. Price, \$1.25.

Advanced Bee-Culture, Its Methods and Management, by W. Z. Hutchinson.—The author of this work is too well known to need further description of his book. He is a practical and entertaining writer. You should read his book. 90 pages, bound in paper, and illustrated. Price, 50 cts.

Rational Bee-Keeping, by Dr. John Dzierzon.—This is a translation of his latest German book on bee-culture. It has 350 pages; bound in cloth, \$1.25; in paper covers, \$1.00.

Bienen-Kultur, by Thomas G. Newman.—This is a German translation of the principal portion of the book called BEES OF HONEY. 10 page pamphlet. Price, 40 cents.

Convention Hand-Book, for Bee-Keepers, Thomas G. Newman.—It contains the parliamentary law and rules of order for Bee-Conventions—also Constitution and By-Laws, with subjects for discussion, etc. Cloth, gold-lettered. Price, 25 cts.

Amerikanische Bienenzucht, by Hans Buschhaber.—Printed in German. A hand-book on bee-keeping, giving the methods in use by the best American and German apiarists. Illustrated; 135 pages. Price, \$1.00.

Thirty Years Among the Bees, by Henry Alley.—Gives the results of over a quarter-century's experience in rearing queen-bees. Very latest work of the kind. Nearly 100 pages. Price, 50c.

Why Eat Honey?—This Leaflet is intended for FREE distribution, to create a Local Market. 100 copies, by mail, 40 cts.; 500 for \$1.50; 1000, \$2.50.

☛ If 500 or more are ordered at one time, your name and address will be printed on them FREE.

How to Keep Honey and preserve its richness and flavor. Price same as Why Eat Honey.

Apiary Register, by Thos. G. Newman.—Devotes two pages to a colony. Leather binding. Price, for 50 colonies, \$1.00; for 100 colonies, \$1.25.

Preparation of Honey for the Market, including the production and cure of comb and extracted honey. A chapter from BEES AND HONEY. Price, 10 cents.

Bee-Pasturage a Necessity.—This book suggests what and how to plan. It is a chapter from BEES AND HONEY. Price, 10 cents.

The Hive I Use, by G. M. Doolittle. It details his management of bees, and methods of producing comb honey. Price, 5 cents.

Dr. Howard's Book on Foul Brood.—Gives the McEvoy Treatment and reviews the experiments of others. Price, 25 cts.

Dictionary of Apiculture, by Prof. John Phin. Gives the correct meaning of nearly 500 apicultural terms. Price, 50 cts.

Winter Problem in Bee-Keeping, by G. R. Pierce. Result of 25 years' experience. 50 cts.

Handling Bees, by Chas. Dadant & Son.—A Chapter from Langstroth Revised. Price, 8 cts.

Bee-Keepers' Directory, by H. Alley.—Latest methods in Queen-Rearing, etc. Price, 50c.

Foul Brood Treatment, by Prof. F. R. Cheshire.—Its Cause and Prevention. Price, 10 cts.

Foul Brood, by A. R. Kohnke.—Origin, Development and Cure. Price, 25 cts.

History of Bee-Associations, and Brief Reports of the first 20 conventions. Price, 15 cts.

Honey as Food and Medicine, by T. G. Newman.—A 32-page pamphlet; just the thing to create a demand for honey at home. Should be scattered freely. Contains recipes for Honey-Cakes, Cookies, Puddings, Foam, Wines, and uses of honey for medicine.

Prices, prepaid—Single copy, 5 cts.; 10 copies, 35 cts.; 50 for \$1.50; 100 for \$2.50; 250 for \$5.50; 500 for \$10.00; or 1000 for \$15.00.

When 250 or more are ordered, we will print the bee-keeper's card (free of cost) on the front cover page.

Bee-Keeping for Profit, by Dr. G. L. Tinker.—Revised and enlarged. It details the author's "new system, or how to get the largest yields of comb or extracted honey." 80 p.; illustrated, 25c.

Emerson Binders, made especially for the BEE JOURNAL, are convenient for preserving each number as fast as received. Not mailable to Canada. Price, 75 cts.

Commercial Calculator, by C. Ropp.—A ready Calculator, Business Arithmetic and Account-Book combined in one. Every farmer and business man should have it. No. 1, bound in water proof leatherette, call finish. Price, 40 cts. No. 2 in fine artificial leather, with pocket, silicate slate, and account-book. Price, 60 cts.

Green's Four Books, by Chas. A. Green.—Devoted to, 1st, How We Made the Old Farm Pay; 2nd, Peach Culture; 3rd, How to Propagate Fruit-Plants, Vines and Trees; 4th, General Fruit Instructor. Nearly 120 pages. Fully illustrated. 25 cts.

Green's Six Books on Fruit-Culture, by Chas. A. Green.—Devoted 1st, to Apple and Pear Culture; 2nd, Plum and Cherry Culture; 3rd, Raspberry and Blackberry Culture; 4th, Grape Culture; 5th, Strawberry Culture. 129 pp.; illustrated. 25 cts.

Garden and Orchard, by Chas. A. Green.—Gives full instructions in Thinning and Marketing Fruits; Pruning, Planting and Cultivating; Spraying, Evaporation, Cold Storage, Etc. 94 pages, illustrated. Price, 25 cts.

Kendall's Horse-Book.—35 pictures, showing positions of sick horses, and treats on all their diseases. English or German. Price, 25 cts.

Silo and Silage, by Prof. A. J. Cook.—It gives the method in operation at the Michigan Agricultural College. Price, 25 cts.

Lumber and Log-Book.—Gives measurements of lumber, logs, planks; wages, etc. 25c.

Maple Sugar and the Sugar Bush, by Prof. A. J. Cook.—Full instructions. Price, 35 cts.

Grain Tables, for casting up the price of grain, produce, hay, etc. Price, 25 cts.

Capons and Caponizing, by Dr. Sawyer, Fanny Field, and others.—Illustrated. All about caponizing fowls, and thus how to make the most money in poultry-raising. 64 pages. Price, 30 cts.

Our Poultry Doctor, or Health in the Poultry Yard and How to Cure Sick Fowls, by Fanny Field.—Everything about Poultry Diseases and their Cure. 64 pages. Price, 30 cts.

Poultry for Market and Poultry for Profit, by Fanny Field.—Tells everything about the Poultry Business. 64 pages. Price, 25 cts.

Turkeys for Market and Turkeys for Profit, by Fanny Field.—All about Turkey-Raising. 64 pages. Price, 25 cts.

Rural Life.—Bees, Poultry, Fruits, Vegetables, and Household Matters. 100 pages. 25 cts.

Strawberry Culture, by T. B. Terry and A. I. Root. For beginners. Price, 40 cts.

Potato Culture, by T. B. Terry.—It tells how to grow them profitably. Price, 40 cts.

Carp Culture, by A. I. Root and Geo. Finley.—Full directions. 70 pages. Price, 40 cts.

Hand-Book of Health, by Dr. Foote.—Hints about eating, drinking, etc. Price, 25 cts.

Alsike Clover Leaflet.—Full directions for growing. 50 for 25 cts.; 100 for 40 cts.; 200, 70c.

Book Clubbing Offers.

(Read Carefully.)

The following clubbing prices include the American Bee Journal one year with each book named. Remember, that only one book

can be taken in each case with the Bee Journal a year at the prices named. If more books are wanted, see postpaid prices given with the description of the books on this page. Following is the clubbing list:

1. Langstroth on the Honey-Bee.....	\$2.00
2. A B C of Bee-Culture.....	2.00
3. Bee-Keepers' Guide.....	1.75
4. Bees and Honey [Cloth bound].....	1.65
5. Scientific Queen-Rearing.....	1.75
6. Dr. Howard's Foul Brood Book.....	1.10
7. Advanced Bee-Culture.....	1.30
8. Amerikanische Bienenzucht [Germ.].....	1.75
9. Bienen-Kultur [German].....	1.25
10. Rational Bee-Keeping [Cloth bound].....	2.00
11. Rational Bee-Keeping [Paper bound].....	1.75
12. Thirty Years Among the Bees.....	1.30
13. Bee-Keeping for Profit.....	1.15
14. Convention Hand-Book.....	1.15
15. Poultry for Market and Profit.....	1.10
16. Turkeys for Market and Profit.....	1.10
17. Capons and Caponizing.....	1.10
18. Our Poultry Doctor.....	1.10
19. Green's Four Books.....	1.15
20. Green's Six Books on Fruit-Culture.....	1.15
21. Garden and Orchard.....	1.15
22. Rural Life.....	1.10
23. Emerson Binder for the Bee Journal.....	1.60
24. Commercial Calculator, No. 1.....	1.25
25. Commercial Calculator, No. 2.....	1.40
26. Kendall's Horse-Book.....	1.10
27. Strawberry Culture.....	1.20
30. Potato Culture.....	1.20
31. Carp Culture.....	1.20
32. Hand-Book of Health.....	1.10
33. Dictionary of Apiculture.....	1.35
34. Maple Sugar and the Sugar Bush.....	1.20
35. Silo and Silage.....	1.10
36. Winter Problem in Bee-Keeping.....	1.30
37. Apiary Register (for 50 colonies).....	1.75
38. Apiary Register (for 100 colonies).....	2.00
39. Bee-Keepers' Directory.....	1.30

Honey & Beeswax Market Quotations.

The following rules for grading honey were adopted by the North American Bee-Keepers' Association, and, so far as possible, quotations, are made according to these rules:

FANCY.—All sections to be well filled; combs straight, of even thickness, and firmly attached to all four sides; both wood and comb unsoiled by travel-stain, or otherwise; all the cells sealed except the row of cells next the wood.

No. 1.—All sections well filled, but combs uneven or crooked, detached at the bottom, or with but few cells unsealed; both wood and comb unsoiled by travel-stain or otherwise.

In addition to this the honey is to be classified according to color, using the terms white, amber and dark. That is, there will be "fancy white," "No. 1 dark," etc.

CHICAGO, ILL., May 19.—We quote: Fancy white, 14@15c.; No. 1, 12@13c.; fancy amber, 9@10c.; No. 1, 8@8½c.; fancy dark, 8@9c.; No. 1, 8c. Extracted, white, 5@7c.; amber, 4@5c.

Beeswax, 28@30c. It continues to sell well and there is no accumulation of shipments. We consider it a good time to sell.

R. A. B. & Co.

PHILADELPHIA, PA., Apr. 22.—We quote: No. 1 white, 9@10c.; fancy amber, 8@9c.; fancy dark, 7@8c. Extracted, white clover, 10c.; amber, 5@5½c.; dark, 4@4½c. Beeswax, 25@26c. Comb honey is dull. Extracted in fair demand. Beeswax lower. W. A. S.

BUFFALO, N. Y., Apr. 20.—We quote: Fancy white, 15@16c.; No. 1 white, 13@14c.; fancy dark, 8@9c.; No. 1 dark, 7@7½c. Beeswax, 25@28c. Trade very dull and honey not moving, except a few fancy lots; anything dark is hard to sell. B. & Co.

CINCINNATI, O., Apr. 22.—There is no fancy white comb honey on our market. Best white sells at 12@14c. in a jobbing way, with a fair demand. Demand is good for extracted at 4@7c., according to quality.

Beeswax is in good demand at 25@30c. for good to choice yellow. C. F. M. & S.

☐ **KANSAS CITY, Mo., May 20.**—We quote: No. 1 white, 13@14c.; No. 1 amber, 10@12c.; No. 1, dark, 8@10c. Extracted, white, 6c.; amber, 5c.; dark, 4c.

Beeswax, 22c.

C. C. C. & Co.

NEW YORK, N. Y., May 9.—There is some demand for white comb honey at unchanged prices. No market for buckwheat. Extracted remains quiet. New Southern is now arriving and selling at 5@6c. for fine grades and 50@55c. a gallon for fair to common. Beeswax easy at 28@29c. H. B. & S.

Bottom Prices

**BRING US BIG TRADE.
GOOD GOODS KEEP IT.**

If you want the best supplies that can be made at a little less cost than you can buy the same goods for elsewhere, write to us for low prices. 1896 Catalogue now ready—ask for it and a free copy of **The American Bee-Keeper** (36 pages).

Address,
THE W. T. FALCONER MFG. CO.,
JAMESTOWN, N. Y.
Mention the American Bee Journal.

COMB FOUNDATION!

Wax always wanted for Cash or in Exchange for Fdn. or other Supplies. My trade is established on **Low Prices** and the merit of my **Foundation**. Orders filled promptly.
WORKING WAX INTO FDN. BY THE LB. A SPECIALTY. Wholesale prices to dealers and large consumers. Send for Prices and Samples to—**GUS DITTMER, AUGUSTA, WIS.**
Reference—Augusta Bank. 1Atf
Mention the American Bee Journal.

ROOTS GOODS Prices Reduced on Dovetail Hives and Sections. A full line of Apian Supplies in stock to fill orders promptly at lowest prices for Best Goods. 36-page Catalogue Free.
JNO. NEBEL & SON, High Hill, Mo.
Mention the American Bee Journal. 4A26t

I ARISE



TO SAY to the readers of the **BEE JOURNAL** that **DOOLITTLE**

has concluded to sell **BEES and QUEENS**—in their season, during 1896, at the following prices:

- One Colony of Italians on 9 Gallip frames, in light shipping-box \$6.00
- Five Colonies..... 25.00
- Ten Colonies..... 45.00
- 1 untested queen. 1.00
- 6 " queens 5.50
- 12 " " 10.00
- 1 tested Queen... \$1.50
- 3 " Queens 3.50
- 1 select tested queen 2.00
- 3 " " Queens 4.00

Select tested queen, previous season's rearing . 4.00
Extra Selected for breeding, THE VERY BEST.. 5.00
About a Pound of BEES in a Two-frame Nucleus, with any Queen, \$2.00 extra.

☞ Circular free, giving full particulars regarding the Bees and each class of Queens.
Address

G. M. DOOLITTLE,
12A25t BORODINO, Onon. Co., N. Y.
Mention the American Bee Journal.

BEES QUEENS
Smokers, Sections, Comb Foundation, And all Apian Supplies cheap. Send for FREE catalogue. E. T. FLANAGAN, Belleville, Ill.
6A26t Please mention the Bee Journal.

PURE BARRED PLYMOUTH ROCK

Eggs, \$1.25 per 14. Our P. Rocks are very large, with fine plumage. Also.

BLACK MINORCA EGGS,
a non-sitting and great laying breed. Both kinds raised upon our farm. Minorca Cockereels, \$1.00 each. **Mrs. L. C. ANTELL,**
16Atf ROSEVILLE, Warren Co., ILL.
Mention the American Bee Journal.

19th Year Dadant's Foundation 19th Year

It still in the lead, for we use all the latest improvements, including the

NEW WEED PROCESS,

and still make the best goods. Remember that we do not use any acid to purify our beeswax, and that is why our Foundation preserves the smell of the honey and is more acceptable to the bees, than any other. It is kept for sale by

T. H. Strickler, Solomon City, Kansas.
G. K. Hubbard, Fort Wayne, Ind.
L. Hanssen, Davenport, Iowa.
C. Theilmann, Theilmanton, Minn.
E. C. Eaglesfield, Berlin, Wis.
E. T. Abbott, St. Joseph, Mo.
J. M. Jenkins, Wetumpka, Alabama
John Rey, East Saginaw, Mich.
Vickery Bros., Evansville, Ind.

The Jennie Atchley Company, Beeville, Texas.
C. F. Muth & Son, Cincinnati, Ohio
E. Kretzmer, Red Oak, Iowa.
G. B. Lewis Co., Watertown, Wis.
James Reynolds Elevator Co., Poughkeepsie, N. Y.
Louisiana Bee-Keepers' Supply Manufactory, Donaldsonville, La.
Page & Lyon, New London, Wis.
John Nebel & Son, High Hill, Mo.

and many other Dealers. All agree in saying that no goods are better than ours.

Those of our customers who formerly bought through Thos. G. Newman can get our Foundation in **Chicago, Ill.**, by addressing us at **118 Michigan Street**. We keep no other goods there.

We make a specialty of **Veils and Veil Stuffs** of best quality, cotton and silk.

"LANGSTROTH ON THE HONEY-BEE"—Revised.

Bee-Keepers' Supplies, Smokers, Sections, Tin Pails, etc.
Samples of Foundation and Tulle FREE with Circular. Instructions to beginners with Circular. Send us your address.

CHAS. DADANT & SON,
Mention the American Bee Journal. **HAMILTON, Hancock Co., ILL.**

25c Cash Paid for Beeswax!

For all the **good, pure yellow BEESWAX** delivered to our office till further notice, we will pay 25 cents per pound, cash; or 28 cents for whatever part is exchanged for the American Bee Journal, Books or Seed, that we offer. If you want **cash promptly** for wax, send it on at once. Dark or impure wax not taken at any price. Address plainly,

George W. York & Co., 118 Michigan St., Chicago, Ill.

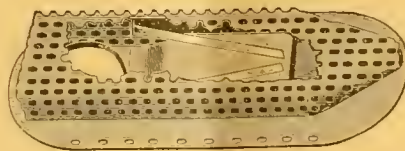

Porter Honey-House Bee-Escape

Have you seen it? Just the thing to put on the doors or windows of your bee-rooms. Indispensable, you'll say, after you have tried it.

Cornell Bee-Smokers.

Cheap, strong, serviceable. We have sold a good many of these, and so far there has been no complaint; but, on the other hand, there have been scores of letters in their praise. Price, 85 cts. Prepaid, \$1.10.

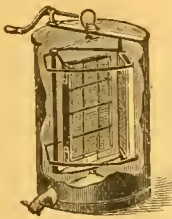

COWAN.

Cowan and Novice Extractors.

These are the best. We are prepared to furnish, on short notice, from any of our several Branches, 2, 4, and 6 frame Cowans and 2-frame Novices.

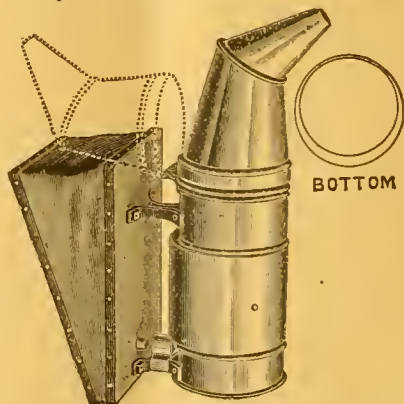

BOTTOM

If you want the genuine, see that they bear our name. **A 36-page Catalog sent Free on Application.**

THE A. I. ROOT CO., MEDINA, OHIO.
BRANCH OFFICES AT:
118 Michigan St., Chicago, Ill. **Syracuse, N. Y.**
1024 Mississippi St., St. Paul, Minn. **Mechanic's Falls, Maine.**

AMERICAN BEE JOURNAL

ESTABLISHED 1861
THE OLDEST BEE-PAPER IN AMERICA

DEVOTED EXCLUSIVELY
TO THE INTERESTS
OF HONEY-PRODUCERS

Published Weekly, at \$1.00 per annum.

Sample Copy sent on Application.

36th Year.

CHICAGO, ILL., JUNE 4, 1896.

No. 23



New Kind of Queen-Trap—Finding Queens.

BY C. DAVENPORT.

As mentioned in my last article, I will describe a trap that catches a queen, but does not prevent the drones from leaving or re-entering the hive. But before I do so, perhaps it would be of interest to some for me to explain how I came to think about making it.

I was in the yard one day last summer when a swarm issued from a box-hive. I was busy at the time, and as there was a trap attached to the hive, I did not pay any attention to them until soon after the swarm had all issued, when I stepped over to the hive and saw that the trap was out of place, and lacked about a quarter of an inch from being close up against the hive. I supposed, of course, that the queen had escaped, but upon looking closely I saw that she was still down in the lower part trying to get through the zinc in front.

Soon after, I made a number of traps 8 inches long, 3 thick, and as wide as the hives to which they were to be attached. The front end and the entire top, except $\frac{1}{4}$ inch next to the hive, was covered with ordinary queen-excluding zinc. The sides were made out of thin boards, and the bottoms of tin. On the inside, about $2\frac{1}{2}$ inches from the end next to the hive, a piece of zinc was fastened across this strip, which reaches clear across. The trap was made out of three pieces. The two end pieces were ordinary zinc but the center piece, which is about 5 inches long, is zinc, which will exclude drones, but allow queens to pass through. A wire cone of such a size and shape that it will entirely cover this center piece is attached to it in front, so that if a queen passes through this piece of drone-excluding zinc at any place, she will be in the wire cone, and if she follows the cone and passes out at the small hole in the end, she will be confined in the chamber in front instead of overhead, as in an ordinary trap.

Now, if I have made this description plain, the reader will understand that the trap, when attached to a hive, projects out in front, instead of up and down, and that there is a space $\frac{1}{4}$ inch wide clear across on the top of the trap next to the hive, which is not covered with zinc, but there is no space left at the sides.

Last summer I had three of these traps attached to hives from which swarms issued; in each case they caught the

queen. Two of these swarms were accompanied by laying queens; the other was an after-swarm, and I found three virgin queens in the trap. Another one was also discovered with the swarm; this one might not have gone through the cone into the chamber in front, or she may have done so, and then got through the zinc. I have had virgin queens escape in this way when using common traps.

Now, when one of these traps is attached to a hive when a swarm issues, of course there is nothing to prevent the queen from walking up the front of the hive and escaping through the open space there, but it seems that instead of doing so they go straight ahead, and when they meet with some obstruction in front, instead of turning back they try to get through it. Whether they will do so invariably remains to be seen.

One of these traps was also attached to a hive, the bees of which superseded their queen. While the trap was there this queen got out, mated, and returned all right. The only way I can account for this is, that a virgin queen, when she comes out to mate, does so in a more leisurely manner, and instead of rushing through the cone, escapes through the open space overhead.

When one of these traps is attached to a hive it is hardly any hindrance whatever to the bees, for they soon use the top for an alighting-board, and then pass through the open space into the hive. It bothers the drones some to get out, but it does not bother them any to re-enter the hive. If I had all frame hives, it is very little interest I would have in any kind of trap, for I much prefer clipped queens; and although I practice dividing, or artificial swarming mostly, with colonies that are in frame hives, I keep these queens clipped, for with me an artificial swarm sometimes tries to abscond.

It used to be a good deal of bother for me to find queens in populous colonies, sometimes, but it is not much now, for I can find a laying queen in an 8 or 10 frame hive with 4 or 5 minutes' work, no matter how populous the colony, or what kind of a queen it is; and although the method I practice has been described before, perhaps it might be of interest to some beginners for me to give it again.

As I remove the frames from the hives I look them over for the queen, and if she is not found readily (and with me it is seldom) the frames with the bees are all placed in an empty hive close by, or hung on a low rack made for this purpose. If there are many bees left in the hive, they are shaken out in front; an entrance-guard is now placed at the entrance, and the bees on the frames are all shaken off in front of the hive. As the bees on each comb are shaken off, the comb is placed back in the hive, and when all are in, the cover is put on, and the next hive containing a queen to be found is treated the same. If one has a number of queens to find, by the time the last hive has been gone over, the queens of the first hives

treated can be readily found in front of their hive among the few bees that have not gone in.

I have never as yet lost a queen by this method, but I will say for the benefit of beginners, that this method should not be practiced during cool weather in the spring, or late in the fall, after queens have stopped laying.

Southern Minnesota.



Benefits of a Foul Brood Law.

Read before the Wisconsin State Convention

BY N. E. FRANCE.

Perhaps this subject can as well be answered by answering some of the questions I so often hear. I am sorry to say there are too many keeping bees who seem to talk and act as if too wise to learn from our valuable bee papers or books. They ask, What is this disease? Is it contagious? Is it near us? Has any State a foul brood law?

Foul brood is a very fatal and contagious disease, doing its work by killing the bees in the grub or worm stage of life. As it takes only a few days from the egg to the hatched bee, you can see how short a time it would take to destroy the colony after once exposed. This dreaded disease became serious in Canada so that the industry seemed doomed; those wide-awake neighbors and members of the Ontario Bee-Keepers' Association could not be content to give up so valuable an industry, and on April 7, 1890, had a law passed providing for an inspector, and heavy fines to any one to sell or expose any diseased bees or appliances. Wm. McEvoy, as inspector, has so carefully and thoroughly done his duty that the disease can scarcely be found.

I am often asked, "How near is the disease to my beeyard?" As long as the disease is in this country, and no law to control it with our mail service carrying bees and supplies, I consider we are all in danger. Allow me to illustrate:

A bee-keeper told me he wanted a choice Italian queen, so sent to one of our Eastern States for it. The queen with a few bees came, and were introduced with the cage as instructed. He felt proud of his pretty queen, and after a time he opened the hive to find by some means the colony had foul brood. Not being the honey harvest season, the disease spread very fast, causing a loss of over 100 colonies.

California, for several years, has had a foul brood law, and their inspector (J. F. McIntyre) has done great good there, so that now that State is noted for her train loads of honey shipped to various places.

Colorado also has a foul brood law. Last winter Illinois and Minnesota, and at the same time I, as Wisconsin delegate, tried to get a foul brood law. Why did we fail to get it? Simply because the bee-keepers of the State did not do their duty. How careful we require by law a case of small-pox, or other contagious disease, to be quarantined and doctored. Likewise diseases among farm stock. Why not have a similar law to protect our bees? If you want such a law, you can have it, if you will only ask for it.

As delegate to appear before our legislature last winter, I soon learned that very few members of either House had been called on by bee-keepers of their district, and did not know one thing about the disease, or whether they wanted a law or not. I did all I could, but failed simply because I did not have backing. At least a dozen members of the legislature told me they would vote for the Bill if bee-men from their district would request it. A stitch in time, brother bee-keepers, will accomplish it.

I repeat, Do you want the protection of the law?

Platteville, Wis.



Now is the Time to work for new subscribers. Why not take advantage of the offer made on page 364?

Enlargement of the Bee-Keepers' Union.

BY W. D. FRENCH.

Several correspondents request me to again set forth, in detail, the proposition bearing upon the subject of an enlargement of the Bee-Keepers' Union, wherein all bee-keepers may be benefited.

This subject, to me, seems of vital importance, and will, at no distant day, be carried into execution. The object of a union should be for the protection of all apiarists, not only those who may be harassed by malicious individuals, but extend aid to all who produce honey.

The proposition I desire to discuss, which tends to accomplish this feat, may appear to the minds of some to be beyond consummation; but when we consider the fact that all industries in our land have combined, either to rob or for protection, must we look upon each other with fear and trembling timidity, and allow others to combine upon our product, and with less capital? Where there is a determination there is a way. Those who keep bees, but do not produce honey, may be loath to combine; but the great producing class will join together, and form one vast association, not for the purpose of robbery, but to protect themselves from being robbed.

A person in his first experience will be advised to begin with a small number of colonies, and in a few years he may possess a large apiary; beginning with caution and care, acquiring knowledge and information, and, as time rolls on, he becomes well versed in the pursuit; and it may be true with reference to the marketing of our product by the formation of a protective bee-keepers' union. It would undoubtedly require two or three years to place such an organization in full and complete operation, although in the first year of its usefulness it would be heard, seen and felt.

I do not wish to be understood as advocating a scheme that would in any manner deprive a single member of the present Bee-Keepers' Union from any part or fraction of benefits to which he may now be entitled; my sole object in presenting this proposition is to enhance the value and elevate the pursuit which we follow, classifying our industry in the category of those that are honorable, legitimate and profitable.

There is not a person who dares take issue with me upon this subject, basing his argument on the impracticability of co-operation in the marketing of honey. I may be in error upon different points of my proposition, but I believe in the main it is the only solution to be arrived at.

To illustrate my views in detail, which I am again requested to present, I would first say that every State bee-keepers' association should inaugurate a system of warehouses in every city where it might be deemed necessary, or where honey is produced in large quantities, or in amounts sufficient to warrant it, and the same be the distributing point for said city and locality; each point of distribution, however, should not carry more than the consumption of said city, or district, and all surplus be shipped to the great head center to be located in Chicago, which would constitute the distributing point for America. It should be operated by the same system as at present, although necessitating and requiring the full time and attention of its manager.

A commission should be charged sufficiently large to meet all operating expenses, and to establish a fund in which to pay freight bills, advances on consignments, etc.; and eventually paying the producer his cash upon arrival. By the aid of what cash there is now in the treasury, and one dollar from each new member, a sufficient sum could be realized to establish and maintain a bureau of distribution in Chicago.

Should State associations be negligent in the matter of establishing warehouses in their respective States or cities, then the same should be performed by the Board of Trustees, or officers of the Union.

I have no desire to formulate a method for electing offi-

cers, or dealing with a constitution or by-laws, but simply to outline its general principles and predict its usefulness.

The article by Prof. Conk, bearing upon the subject of the California Bee-Keepers' Exchange, on page 81, speaks correctly of grievances manifested by the honey-producers of California, and the article produced. He says: "They see no reason why they should not have a voice in determining prices on their own product. Could they but work in concert, act as one man, something after the manner of the Standard Oil Company, then they could adjust prices of their honey according to the amount and cost of production."

I would like Prof. Cook to tell me how the Standard Oil Company could maintain their price on oil without the co-operation of at least a majority of producers. And, also, how could the California Bee-Keepers' Exchange maintain a fixed price upon their product without the co-operation of bee-keepers outside of their State?

It must be borne in mind that honey is not only produced in California, but in every other State, and to co-operate on the principle of the Standard Oil Company, it must extend throughout the United States. The California Bee-Keepers' Exchange cannot fix the price of honey in New York, Chicago or Boston. It can only stimulate the price at home.

It must be remembered also that citrus fruits are produced only in certain States, hence the advantage the Citrus Fruit Exchange must have over the Bee-Keepers' Exchange where the product of every State comes into competition.

It is to be hoped that every State will now organize something on the principle of the California Bee-Keepers' Exchange, and when that has been accomplished, a National organization will be sure to follow, which will be indispensable in order that the product of the bees be properly distributed, and a uniform price be maintained throughout the United States. In other words, it will be necessary for each State to combine under one general management. As time passes on in its various events, and people becoming more convinced of the necessity of organization, it is apparent that a system based upon such a method would be more easily consummated.

There cannot be a shadow of doubt against the consistency of a National combination, neither should there be any serious controversy over the manner in which it could be matured; but in order to complete its usefulness, and bring to bear the object sought, every State should be united.

Now that the first link has been welded, it is the duty of other States to act in like manner, and form one great and powerful chain that cannot be broken. When that has been accomplished, bee-keepers can justly feel their independence, and show the world their ability to regulate and dispose of their own product.

While it is true there are honest men in the commission business, it is safe to assert that bee-keepers can manipulate their own business satisfactorily to themselves, and by proper distribution, adjust their own product to the various points as desired. It is not the object of bee-keepers to corner the product of the bees, and compel the innocent consumer to pay an exorbitant price for the sweetest of all sweets, but to maintain a uniform price much in advance of what they now receive, without extra cost to those who buy for their own consumption.

I would respectfully urge every State bee-association to move in this matter, and when that has been accomplished, a new era will dawn upon those who follow the pursuit of bee-keeping.

Foster, Calif.



The McEvoy Foul Brood Treatment is given in Dr. Howard's pamphlet on "Foul Brood; Its Natural History and Rational Treatment." It is the latest publication on the subject, and should be in the hands of every bee-keeper. Price, 25 cents; or clubbed with the Bee Journal for one year—both for \$1.10.

The Slotted Separator—Experiments.

BY B. TAYLOR.

In reply to a request, I give the following description of my handy separators:

They are made of two strips of wood $\frac{1}{8}$ inch thick. For $4\frac{1}{4}$ sections these strips are 2 inches wide; they are fastened together by cleats $4\frac{1}{2}$ long and $\frac{3}{8}$ by $\frac{1}{8}$. The cleats are nailed across the wide strips in four places, $4\frac{1}{4}$ inches apart, so the edges of the sections strike the cleats, leaving one-half bee-space in the separators. This brings the honey in the sections to within $\frac{1}{8}$ inch of the edge of the section, and the bees, for causes I will not try to explain here, will seal the honey smooth and level, right up to the wood of the sections, in a uniform, beautiful way that they never will do with plain-surface separators where the bee-space is all in the section.

The two 2-inch strips that make the finished separator, when cleated to $4\frac{1}{4}$ wide, leaves an open slot $\frac{1}{4}$ inch wide lengthwise, in the center of each separator; through these slots the bees can pass freely from section to section, right in the center of the super.

These separators can be used in any style of super. In the T super the edges are slotted where the T tins come, for these separators go clear to the top and bottom of the sections, leaving no chance for the bees to bulge the combs above and below the separators, as they often do with the old-style separators.

The question is often asked—Do not these thick separators occupy much space, and diminish the pounds of honey in a super? No, they increase the honey in any given sized super. They do lessen the number of sections in a super, but each section is enough heavier to more than make the difference, so there is a saving of four sections with their foundation in each super.

"But they are too costly," I hear some one say. They are in the final end cheaper than any thin wood separators, for but three of them are required in a 24-section super, and with care they will last a lifetime, and will help a novice to produce perfect-finished sections for shipping or show.

Dr. E. K. Jaques, of Crystal, Minn., exhibited two 24-section supers of honey at the Minnesota State Fair in 1895, which drew \$28 in three 1st Premiums for perfection in finish and shipping qualities.

EXPERIMENTS IN BEE-KEEPING.

In a recent number of the American Bee Journal I find the following paragraph, taken from the Farm, Stock and Home:

I am wintering some 40 colonies in two-story hives of 2,000 inches of comb space, and at least 50 pounds of honey per colony. I had intended to stop experimenting, but there are yet many unsettled things in bee-keeping, and I shall go on testing methods hereafter with more care than ever. I will set three large double hives, with their rich stores, on the summer stands, treat all as nearly alike as possible, and then keep a strict record of which gives the earliest and largest swarms, which class gives the most salable honey during the season, and then figure the comparative profit of each.

B. TAYLOR.

The editor copied the paragraph correctly, but the Farm, Stock and Home did not report me correctly. Where it reads, "I will set *three* large double hives," it should read, "I will set *these* large double hives," for I shall use all of them, and as many more of my small Handy hives of 1,000 inches of comb space, for the same purpose, viz.: which will under the same treatment, and in the same yard, give the most profitable results—hives of large or small size, in either comb or extracted honey? I will feed part of these colonies in both sizes of hives a few ounces of syrup each day without regard to their having a plenty of stores in the hives, to prove whether stimulative feeding pays.

I will run a part of these colonies for comb and part for

extracted honey, and note which gives the most dollars and cents. There are 38 colonies in two house-apiaries, part will be run for comb and part for extracted honey.

I will also make careful comparison between the house and open yard, as to greatest profit. The colonies I am using are the best lot of bees I ever owned—rich in bees and stores—and I expect to settle facts by proved conclusions, and not guesses based on prejudice.

Mr. Editor, you perhaps remember that I, last fall, reported my bees to be in fine condition for winter—plenty of stores and plenty of young bees. Well, out of 113 colonies I lost two queenless ones. I put them out April 12, and they were carrying pollen in one hour, and on April 14 they were working like in midsummer. Forestville, Minn.



Transferring—Something for Beginners.

BY J. A. GOLDEN.

I have many letters of inquiry in regard to the wintering features of my combined feeder and hive cover, from the various States, and I am frequently asked to give information on several items in apiculture by letter, which I gladly respond to in short sketches, referring the questioners to textbooks and Dr. Miller's department—Questions and Answers. But here lies a letter before me which says:

"I have bought several colonies of bees in box-hives, and I want to transfer them into movable-frame hives. Will you please tell me the best time, and how to do it? I take the American Bee Journal now, but it doesn't tell much about it."

I will give my plan and practices, hoping that it may meet the wants of many new readers of the American Bee Journal.

Having chosen the kind and style of hive we wish, the next is the tools requisite, viz.: A good smoker, a long-blade honey-knife, 1½ inches wide, square point, ground sharp; a board 2 feet long, 15 or 20 inches wide, dressed smooth, with saw-kerfs one inch apart across the board on one side; a ball of wrapping-yarn, and an old, thin-blade case-knife, square point, ground sharp; a small box with a hand-lampset inside, that the knife-blade can be quickly heated by holding over the flue; a nail-cutter and hatchet; a light, bottomless box, 10 or 12 inches square.

The best time to transfer combs and bees is, in my experience, (and I have done quite a little at that branch of apiculture), in this latitude, from April 15 to May 1. At this time the combs are light and free of new honey, and brood-rearing is but fairly started, consequently the work is quickly accomplished, without the loss of brood and a dauby mess of wasting honey, as is the case when combs become filled with new honey, and brood-rearing is in an advanced stage.

I use a table or bench to work on, and with everything ready, I cut enough wrapping-cord in lengths to put one strand in each saw-kerf of the transfer-boards. With the smoker give two or three puffs of smoke at the entrance of the box or hive to be transferred, and then carry the hive to the transfer-table, turn it upside down, and by the time I cut the nails off the side to be taken off, and with the long-bladed knife cut the combs carefully from the side to be removed, the bees will have filled themselves with honey. I set the bottomless box on top of the hive, and with the smoker smoke is applied at the bottom, and the queen and bees hastily scamper up into the bottomless box, which may be fastened in its place or set to one side.

Now, the long knife pushed end-wise under the bottom of the combs, severs them, and they can be lifted out, placing them on the board, and the edges straightened and squeezed close together. A frame is placed over the combs, pressing the top-bar against the top or thick edge, and with the left hand press the frame down on the combs; with the right hand heat the case-knife over the lamp, and cut clear round

the ends and bottom on the inside of the frame, holding the knife so as to cut a little under the frame. Slip out the cuttings, and press the frame down over the comb, draw the frame to the edge of the board, bring over a string and tie it; by turning the point around twice in tying the first knot, it won't slip. Some frames will require four or five strings, three usually. Clip off the points of strings, pull the frame from the board, at the same time raise it up and see that all is straight before placing in the hive close by.

Thus proceed, placing the honey part of the combs at the top of the frames, and the brood below, being careful to save all the brood; also putting the brood in as compact form as possible in the middle combs. If there are not combs enough to fill the frames desired, take strips of comb one inch wide, lay against the top-bar, heat the case-knife quite hot, and slide between the top-bar and strip of comb, then with the hot knife cut the strip to an edge, and the bees will do the rest.

After placing the hive on its stand, and the frames properly placed, raise the front of the hive one-half inch by a wedge or block, then dump the bees down at the entrance, and see that the queen goes in and not under the hive. Don't use smoke to drive the bees in—it's bad policy; use a small broom.

When all the bees are in, let the hive down, and close the entrance to two or three inches for a day or two. In two or three days uncover, and with a sharp knife cut the strings and slowly pull them from the combs, and the transfer is complete. Thus, one can transfer very speedily, and do it nicely.

Yes, we often wonder why the bee-papers don't give the transfer formula once a year—say in the January issue—knowing that new bee-keepers are yearly added to their readers. Reinersville, Ohio.

[As no one should think of starting in bee-keeping without one of the standard bee-books (which give full directions for transferring), it is hardly necessary to repeat the same things every year in the bee-papers. There is quite enough repetition, we think, without publishing over and over what is so clearly told in the books, and upon which there is now scarcely any difference of opinion.—EDITOR.]

CONVENTION PROCEEDINGS

Report of the Michigan State Convention.

BY W. Z. HUTCHINSON.

(Continued from page 343.)

Mr. Aspiwall then read a paper entitled,

The Requisites for Success in Bee-Keeping.

With the advancement of civilization various individual and local enterprises have, at times, been seriously hampered. The condition thus produced has in turn been a stimulus to further progress, and overcoming difficulties which were scarcely apparent at times when success was attainable in the hands of the unskilled. The plow and lumberman's axe have greatly affected the interests of bee-culture. Climatic changes have also tended to intensify the situation. However, Nature is very compensating, and men, whose trust is in the Divine, will see developments that can be attributed to her workings.

Necessity is a great stimulus to progress. Many of the old and abandoned gold-mines are again being worked by improved methods, yielding a profit fully equal to the first work-

ings. I might cite numerous illustrations of similar progress. I very well recollect when bee-keeping was not a profitable pursuit, although the sources of honey were abundant, and not until Mr. Quinby gave his system to the public was it otherwise; and with the advent of the Langstroth frame came still greater profits, attended with a wonderful degree of progress.

Notwithstanding the loss sustained by drainage of marsh lands, and clearing of the forests of basswood, also the production of crops which yield no honey, we have forage from shade-trees, fruit-bloom, the clovers, buckwheat, etc., in lieu of the primitive sources.

With changed conditions bee-keeping in many portions of the country has ceased to be a paying pursuit. Bee-paralysis has also tended to reduce the profits in many localities. Dry seasons have proved an equivalent to overstocking, resulting in the storage of much poor honey, which is unfavorable to successful wintering. These discouragements, intensified by a lack of control in swarming, tend to make the profits still less.

With these conditions relative to bee-keeping, what shall be the remedy? What will enable the bee-keeper to obtain a reasonable profit when the seasons are unfavorable? It requires no great skill to secure a crop of honey where the forage is abundant, with weather favorable to the secretion of nectar. I have met men who, with favorable seasons and good yields of honey, flattered themselves that they were bee-keepers, when really the bees were their keepers. He only is a bee-keeper who can secure surplus under unfavorable circumstances. To accomplish this, several requisites are necessary.

First, we should possess a thorough knowledge of bee-keeping to its latest developments. The bee-keeper should also possess a natural adaptability to the profession. Presuming the knowledge has been acquired, there still remains certain requisites not contained in the volumes of the bee-keeper's library. The numerous experiences of the past five years are sufficient evidence in support of such a statement. How few in Michigan have been able to show a balance in favor of bee-keeping. However, these seasons and conditions, already mentioned, have served as a school of necessity. Never was there known such an effort to lessen manipulation as of late; never so much experimenting to prevent swarming, and never so great a desire to winter bees successfully with inferior stores.

Let us consider some of the requisites for success in bee-keeping:

- 1st. A thorough knowledge of the up-to-date methods.
- 2nd. An easy and successful method of wintering.
- 3rd. Management with less than half the present manipulation.
- 4th. Complete control and prevention of swarming.
- 5th. A thorough and complete remedy for all diseases. I refer especially to foul brood and bee-paralysis.
- 6th. And lastly, we should include a good feeder.

In considering the method of wintering I will simply refer to it as a necessity. It is not within the scope of this article to treat the subject. I will merely allude to a statement made by Mr. Quinby, in which he said that "colonies well wintered were the only ones from which surplus could be expected."

The third requisite—requiring less manipulation—is contingent upon the methods employed throughout the year, wintering included, which must be simple and easy in management. It certainly should include a non-swarming system or hive. Every bee-keeper knows something of the labor and annoyance during the swarming season. This must be done away with, if possible, and comb honey produced exclusively. But an objection may be raised. Unless some extracted is obtained, we fail to realize the maximum profit

from our bees. This objection will hold good if manipulation is not taken into consideration.

I have come to believe that bee-culture must be so managed that, if desirable, it may be followed by a side-issue, or in connection with another occupation. With lessened manipulation, which implies no swarming or extracting of honey, larger holdings will be possible, also greater assurance of success. It is unnecessary for me to state that comb honey does, and always will, occupy a higher place than extracted, which, if secured at less expense, is a point gained.

Lessened manipulation in itself calls for a non-swarmers.

The demands of the times call for an advance in these lines, and they must and will be forthcoming.

In alluding to non-swarmers—the fourth requisite—I will state for the benefit of all concerned, that I have no small degree of confidence in their ultimate success. Two seasons of experiment upon a large scale demonstrated that but one colony in 20 non-swarming hives cast swarms, while all without the attachments swarmed. The non-swarmers gave a surplus, while the swarmers were almost destitute of stores. This season's experiments will be more complete, having gained by the experience of the past two years.

The fifth calls for a positive remedy for foul brood and bee-paralysis. The former is sufficiently understood by intelligent bee-keepers to be thoroughly under control, although it is liable to spread through carelessness and ignorance. As regards bee-paralysis, but little is understood as yet. Certainly the disease is such as to seriously affect the yield of honey.

The sixth requisite is a good feeder, without which the preparation for successful wintering cannot be accomplished. The use of comb foundation in the sections as a bait, together with the tiering system leaves the brood-nest depleted in stores at the close of the season. I am speaking relative to the unfavorable conditions already mentioned, hence the great necessity of feeding. To prepare for extreme winters, each colony should contain not less than 40 pounds of food.

L. A. ASPINWALL.

W. Z. Hutchinson—Bees don't need so much honey for the winter as the amount mentioned by Mr. Aspinwall, but they may use it in the spring.

M. H. Hunt—Mr. Aspinwall's paper is something to set inventors to thinking.

Mr. Aspinwall—Yes, that was what it was intended to do, and what I have set forth in that paper is what we must come to.

W. Z. Hutchinson—There is no question but what a safe method of wintering and a remedy for swarming would work almost a revolution in bee-keeping, as a man could scatter his apiaries about the country, and care for them with but little labor, and the result would be the production of honey at less expense.

Mr. Aspinwall—Out of 20 colonies in my non-swarming hive, only one swarmed, and all gave a fair surplus, while those in ordinary hives swarmed, and stored no surplus, and had to be fed in the fall.

The Secretary now read a paper from Mr. T. F. Bingham, entitled,

Horizontal Prices.

The only real satisfaction to be gained by a careful survey of our industry, is that bee-keeping, like other industries, is suffering from restricted consumption—in common phrase, "over-production."

We read that over-production is impossible. This may be true, and to prove that this belief is reasonable, we are told that the last five years have been light in the amount of honey produced. Yet this supposed short crop has not only held at former prices, but actually fallen in price. This is used as

evidence corroborative, that the production of honey, unlike other produce, is not subject to the laws that govern supply and demand.

Some have claimed that because the production of honey was not entirely in the hands of so-called specialists, the markets have been demoralized by small producers, who have sold their product for what they could get, regardless of the large producers.

Much has been written about honey exchanges and unions as a means to better prices. While many bee-keepers are loud on the various trusts and combines in other avocations, combines for the same purpose—namely, to secure better profits, and freeze out small producers—no slur is ever cast on any legal means of doing the same thing in the honey industry.

The honey industry, while in many respects governed by the immediate local conditions, is widely diffused, and therefore in a broad sense independent, comparatively, of other than general and widespread results. Like the production of eggs and butter, there does not at present appear any method of producing honey so cheaply and surely as when produced by those same small, widely-distributed methods.

We read of the financial results of immense crops of honey produced in localities where people prefer sour fruits to cheap honey, even; of no home market, and combines, etc. What does it all mean? Simply this, that honey, like other articles of food, is governed by the laws of demand and supply.

Should the time ever come (and it is striding that way, when a few colonies of bees will be kept by all classes of people, as hens and cats are now kept—not because there is much money in them, but because they pay as well in money and comfort as anything else on a small scale and in a limited way), the consumption of honey will be greatly increased as its price is reduced, and its supply augmented.

It is not necessary that specialists should be consulted. They have told over and over, and put it in different shapes in different books, till they have no more to offer; in fact, we have had efforts made to increase competition, and reduce the price of honey and books by petitioning the much-abused paternalism of the Government for aid in the free distribution of a very worthy and excellent manual of the apiary prepared under the auspices of the Department of Agriculture. Such petitions do not favor combines and honey exchanges. The laws of nature—vanity or interest—stand ever ready to teach school for a consideration. It may be a bee-convention, a Sunday school, a missionary meeting, or Salvation Army.

It is safe to say that until the arrival of the age of miracles it will pay in direct, or indirect, ways to produce honey and eggs and butter at rates at which they will be consumed.

T. F. BINGHAM.

W. Z. Hutchinson—I fear that Mr. Bingham forgets that honey is a luxury, and the price does not respond to the law of supply and demand as it does in the case of staples. People will pay \$1.00 a bushel for potatoes rather than do without them, but as soon as the price of honey begins to go up, its use is dropped by many.

Next came a paper by Dr. L. C. Whiting, of Saginaw, entitled:

Bee-Keepers Must Follow the Wild Flowers.

The failure in the crop of honey produced in any part of the country where the fields are all cultivated, must be met by emigration to pastures new, where the plow cannot disturb the wild flowers.

When the timber has just been cleared from the land, flowers spring up in variety and abundance. The ashes of the clearing are hardly cooled before fireweed, boneset and asters make their appearance. Raspberries and blackberries soon follow, and many other honey-producing plants cover the land. The forest, if at hand, furnishes another abundant

source of honey. White clover soon comes in, and the bees and bee-keepers are happy in the abundance of the stores. Should the land be so broken and rough that it cannot be cultivated, this condition of affairs may last many years.

As soon as the farmer puts his plow into the field, a large portion of these blooms disappear, and little remains except fruit-blossoms and white clover. The lumberman soon clears the basswood from the forest, and the bee-keeper wonders what is the matter with the honey season. What are we going to do about it? Sit down and see our bees die out, or seek more favorable locations?

This condition is facing many bee-keepers in Michigan to-day. Some of our prominent honey-producers have already taken this step, and are following the honey-flow into the new clearings, and success has proved the wisdom of their course.

There are many locations in the northern and western parts of the State which furnish the right conditions for profitable bee-keeping, to suit the most capricious bee-keeper.

Keep up your courage and follow the advice of Horace Greeley, and—"Go west." L. C. WHITING.

R. L. Taylor—How about Ohio, Indiana, Pennsylvania, Illinois and New York? These are old, cleared-up States, and have been for years, yet they have had good crops of honey since they were cleared and cultivated.

Mr. Hunt—In my locality we had good crops of honey for 11 years in succession. Then there was a change. It was abrupt. The floral conditions are the same in my locality now that they were in those 11 years of plenty.

Mr. Taylor—What we need is rain.

Mr. Aspinwall—You are right; and I believe that we will, in a measure, have an old-fashioned season this coming summer. There was more rain and snow the past winter than we have had in some time.

W. Z. Hutchinson was appointed to look after the matter of conferring with the State Board of Agriculture regarding the continuance of the Apicultural Experiment Station.

Officers were elected as follows: President, L. A. Aspinwall, of Jackson; Vice-President, Geo. E. Hilton, of Fremont; Secretary, W. Z. Hutchinson, of Flint; and Treasurer, M. H. Hunt, of Bell Branch.

The place for holding the next meeting was not definitely decided upon, it being left with the officers, but the talk was in favor of going more towards the northern part of the State. No meeting has been held very far north, and in that part of the State honey crops have been good the past year or two, and a larger attendance may be secured by going to a portion of the State where the bee-keepers have not had so many opportunities for attending a convention. Mt. Pleasant was mentioned as the probable place for holding the meeting.

W. Z. HUTCHINSON, Sec.

"Samantha at the World's Fair."—We want to make our present readers one of the best offers ever made. All know the excellent books written by "Samantha, Josiah Allen's Wife." Well, "Samantha at the World's Fair" is probably her best, and we are enabled to offer *this book and a year's subscription to the New York "Voice"* (the greatest \$1.00 weekly temperance paper published to-day), for sending us *only three new subscribers* to the American Bee Journal (with \$3.00), provided you are *not now* a subscriber to the "Voice." Think of it—a grand book and a grand weekly temperance newspaper *given simply for sending* us three new subscribers to the Bee Journal for a year! The Samantha book is exactly the same as the \$2.50 one, only the binding is of heavy manilla instead of cloth. It is a special 100,000-copy edition, and when they are all gone, the offer will be withdrawn by the publishers. Of course, no premium will also be given to the new subscribers—simply the American Bee Journal for one year.

Questions AND Answers

CONDUCTED BY

DR. C. C. MILLER, MARENGO, ILL.

[Questions may be mailed to the Bee Journal, or to Dr. Miller direct.]

Milkweed Pollen-Masses on the Feet of Bees.

I send two black bees for examination. Their feet are covered with a yellow, fuzz-like hair. It is something new to me.

Central City, Ill.

G. F. Y.

ANSWER.—If you will look closely you will see that the little bodies attached to the bees' feet are hardly fuzzy or hairy, but more like flat, solid affairs. They are pollen-masses from milkweed, and are each year the cause of a good deal of alarm to those unacquainted with them. Looking something like a diseased growth on the foot, it is no wonder anxiety may be felt lest similar growths take place on the feet of all the bees. It is unusually early in the season to be troubled with them, but this year doesn't seem to follow rules. You will find some of the bees so loaded with these pollen-masses as to lose the use of their feet, and to be driven out of the hives. As the milkweed is a good honey-plant, possibly the damage done to the bees is made up by the amount of nectar secured.

Bees Working Only in the Morning.

What is the matter with my bees? I have three strong colonies in a cool, shady place, and they work vigorously in the morning, but cluster on the front of the hive in the evening. I have had the supers on about three weeks, but they have not started any surplus yet. I first thought they were "fixing to swarm," but they have had time to rear a queen since they began to cluster. I also thought the honey-flow was coming to a close, as they killed out the drones, but they seem to have plenty to do in the morning. I live in a forest country, where we have wild grape-vines, ratan and many others; also pine, oak, hickory, black walnut, sweet gum, etc.

Delroy, Tex.

J. T. E.

ANSWER.—It is nothing unusual at times for bees to work busily in the forepart of the day and then lie idle in the afternoon for lack of anything to do. Very likely that's the case with your bees. Many plants seem to get ready through the night to offer the bees a feast in the morning, and when that's used up the bees know enough to stay at home. Even if nectar flows all day, if the number of flowers is very small, the bees may have nothing to do after the morning hours.

Actions of Wild Bees—Balled Queen, Etc.

1. What makes wild bees, after their tree is cut down, drink at their watering place stronger than they did before they were cut down, and the honey taken from them? Is it the overdose of honey they had eaten, or not?

2. What makes wild bees, after the tree is cut, work to the bait where they were first coursed from, and the honey all around where the tree was bursted? It seems that they were somewhat greedy.

3. On May 3 one colony of my bees swarmed. On May 4 I opened the old hive to pick out my choice in color of queens, and killed the rest of them. As my bees are very much mixed up, I want the best. Some of the cells were not open, and I opened three of them; to my surprise the queen was poking her tongue out. I helped her to get the door open, and saw a worker in the cell with her. The worker was turned head to tail with the queen, was dead, and appeared dry. I closed the cell-door, and thought that I would kill the queen and

send it to you. This may be very common, but not to me. Do you think when the cell was near being capped, the worker went in to see to the young queen, and some of the workers capped the cell? If not, how was it?

4. The other day I clipped one of my best, and put her back, and they balled her and killed her. I clip all of my queens, and this is the first to have been hurt when put back. I do not know why they did it.

G. W. B.

ANSWERS.—1. I don't know.

2. It seems certainly that they would be foolish to go off a long distance when honey is so near at hand, and I suppose most of them do work on the honey at hand, but the ones that have been working on the bait may start where they already know there is honey without noticing there is some nearer.

3. When several young queens are in a hive and the bees intend to swarm again, it is the common thing for all but one to remain in the cell, although the capping may be cut nearly around. You will often see the young queens stick out their tongues to be fed by the workers, and sometimes a queen will push her head out and dodge back. Again, you will see the queen try to get out and the bees drive her back. A worker-bee might enter a cell after the queen had gnawed the capping open, and the other workers might keep her there till she died.

4. In rare instances a queen will be balled on being returned, but if you close the hive at once and leave them, the bees will usually release the queen.

Sprayed Trees May Have Caused It.

I had four colonies of bees that died. They had plenty of honey to eat, and there were no moths, and no foul brood. I would like to know what was the matter. They died the first of May. They had been working nicely.

Moroceo, Ind.

G. E. L.

ANSWER.—I don't know. Possibly a case of poisoning. Fruit-bloom may have been visited by them about that time, and some one may have been so unwise as to have sprayed his fruit-trees with poisonous chemicals. If so, it was no doubt a case of ignorance, for spraying fruit-trees when in bloom is a damage to the trees, and can do no possible good.

Only One Cent a Copy for copies of the American Bee Journal before April 1, 1896. We have them running back for about 10 years. But you must let us select them, as we cannot furnish them in regular order, and probably not any particular copies. Just send us as many one-cent stamps as you may want old copies, and we will mail them to you.

The Names and Addresses of all your bee-friends, who are not now taking the Bee Journal, are wanted at this office. Send them in, please, when sample copies will be mailed to them. Then you can secure their subscriptions, and earn some of the premiums we have offered. The next few months will be just the time to easily get new subscribers. Try it earnestly, at least.

The Alsike Clover Leaflet consists of 2 pages, with illustrations, showing the value of Alsike clover, and telling how to grow it. This Leaflet is just the thing to hand to every farmer in your neighborhood. Send to the Bee Journal office for a quantity of them, and see that they are distributed where they will do the most good. Prices, postpaid, are as follows: 50 for 25 cents; 100 for 40 cents; or 200 for 70 cents.

A New Binder for holding a year's numbers of the American Bee Journal, we propose to mail, postpaid, to every subscriber who sends us 15 cents. It is called "The Wood Binder," is patented, and is an entirely new and very simple arrangement. Full printed directions accompany each Binder. Every reader should get it, and preserve the copies of the Bee Journal as fast as they are received. They are invaluable for reference, and at the low price of the Binder you can afford to get it yearly.

OLDEST BEE PAPER IN AMERICA

THE AMERICAN BEE JOURNAL

ESTABLISHED IN 1864

PUBLISHED WEEKLY BY
GEORGE W. YORK & COMPANY,
 118 Michigan St., - CHICAGO, ILL.

REGULAR CONTRIBUTORS:

G. M. Doolittle, of New York. Prof. A. J. Cook, of California.
 Dr. C. C. Miller, of Illinois. Dr. J. P. H. Brown, of Georgia.
 J. H. Martin, of California. Rev. E. T. Abbott, of Missouri.
 Barnett Taylor, of Minnesota. Mrs. L. C. Cxtell, of Illinois.
 Chas. Dadant & Son, of Illinois.

\$1.00 a Year—Sample Copy Sent Free.

[Entered at the Post-Office at Chicago as Second-Class Mail-Matter.]

Vol. XXXVI. CHICAGO, ILL., JUNE 4, 1896. No. 23.



Many Disappointments will have to be endured the next few weeks by those who failed to order their supplies in time to have them on hand when needed. Probably some honey will be lost on account of it. Nearly all dealers will likely be very busy for some time yet, and do the best they can, they just *cannot* fill all orders promptly. So be patient with them, for in all probability the blame is yours for not ordering earlier, or before the great rush that we have known at this time of the year to almost overwhelm some dealers in years gone by.

Removing Honey-Boards.—In a recent number of the Bee Journal, Dr. Miller asked Mr. Hutchinson to explain a point mentioned in one of his recent articles in this paper. In reply, Mr. H. said in the last Review:

Dr. Miller wants me to explain how I can unite weak colonies with those that are stronger, if I do not take off the honey-boards oftener than once in three years, on the average. As a rule, not more than one-fourth of my colonies each year need such treatment. To be honest, I don't believe very much in the uniting of colonies of bees at any time. Much depends, however, on circumstances, and what we wish to accomplish.

The Medals and Diplomas awarded at the World's Fair, in 1893, we understand have been finally presented to those who were so fortunate as to win them. Mr. W. C. Lyman, of Downer's Grove, Ill., wrote us on May 25, that he had received his medal and diploma, and that "they are beauties." We presume others have theirs. We hope our Canadian friends are now happy, for only recently they were casting reflections upon the United States for being so slow about issuing the awarded signs of honors. Being "slow" can be forgiven, if one is only "sure." And 'tis said, "All things come to him who waits."

The Fifth Year of the present management of the American Bee Journal is begun with this number. Four years' work is completed. We have tried to make advancement in the contents and general make-up of the Bee Journal, from time to time, and sometimes we think that we have succeeded, at least in a small degree.

We wish to take this opportunity to return sincere thanks

to the many who have encouraged us in our work by prompt payment of subscription, kind words, and various other ways. We hope always to merit them, and shall endeavor in the future, as in the past, to do the very best we can for our readers.

Judging from general reports as to the prospects for a good honey season this year, we feel that better days are in store for bee-keepers. We shall be glad to rejoice with them, if after so many years of failure in various localities this year shall prove to be a good one. Let all strive to make the very best of whatever comes, and then if success is not attained the fault will not be at their door.

State Appropriations for Bee-Keeping is asked about in the "Question-Box" department this week. The answers are varied and interesting. They show but very little agreement in the minds of leading bee-keepers as to just what is the most needed aid for apiculture by the State.

We had thought for some time that experiment stations would be the best investment for the State to make, but recently we have come to the conclusion that there are other lines that need and deserve help most.

The suggestion that it be used in distributing tracts and pamphlets telling about the many valuable and interesting uses of honey is a good one. This would aid all. It would help create a larger demand for honey. It seems to us that just now bee-keepers know pretty well *how* to produce the honey—and the next thing is to be able to get some cash out of it. While there is considerable fun in keeping bees, still most folks don't live entirely on fun. There must be some real financial profit connected with it, or it will likely soon be dropped.

The idea of using a State appropriation in circulating bee-papers of course would at least appeal to publishers, and that would indeed help bee-keepers themselves. But for the best all-around help, we believe it would better be invested in literature that will educate the general public as to the uses of pure honey, and thus finally aid in overthrowing all kinds of glucose mixtures which so compete with the real bees' honey.

Apicultural Experiments.—The 21st Annual Report of the Ontario Agricultural College, located at Guelph, Ontario, Can., has been received. But the part that particularly interests bee-keepers is the report of the apiculturist, Mr. R. F. Holtermann, covering an interesting series of experiments. Not having space to go over this report in detail, I shall have to go over most subjects briefly.

FEEDING THE BEES.

A number of colonies were fed sugar syrup, with the Boardman entrance-feeder, and the feed was given a little above blood heat. The results are tabulated, and the experimenter observes that "there is a considerable difference between the first weight of the hive, plus the syrup, and the actual weight six days after the last syrup was stored. The difference in weight may be attributed to evaporation, the consumption of stores which goes on all the time under natural conditions, and the increased consumption likely to go on whenever the bees are under the excitement or stimulus of storing."

The conclusion is thus stated:

1. That there is a greater difference between the weight of stores supplied to the bees in the feeders, and the increase in the weight of the hive. There is a loss which cannot be explained in any satisfactory way.
2. That it will not pay to extract the honey with a view to making a profit, and supply the bees with sugar syrup for winter.
3. That, when feeding has to be resorted to, the strong colonies should be given sufficient comb and stores to cover

their own wants, and, in addition, supply the weaker colonies with combs of sealed stores.

SEALED COVERS OR UPWARD VENTILATION.

I haven't the space to go into details; but the experiment of wintering two sets of colonies of ten each in clamps showed that the set having sealed covers did not winter nearly as well

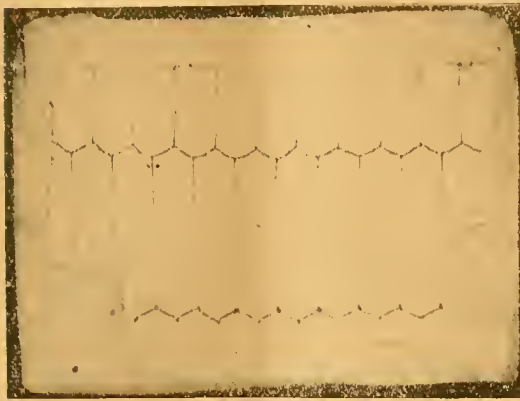

FIG. 1.—Giving a side view of comb foundation, 15 sq. ft. to the pound, and above the same after the comb has been completed and capped by the bees. The honey has been extracted and washed away from the comb, which, after a thorough drying, has been filled with plaster of Paris and a section cut down.

as those having upward ventilation. This agrees with the reports of two years ago.

COMB FOUNDATION.

Under this heading the experimenter gives some interesting results; and, so far as I know, he proceeds upon methods new and original. I can do no better than to quote nearly all he has to say on this subject:

The use of comb foundation has become general; in fact, few, if any, keeping bees in the movable-frame hive, attempt to do without it. At present, comb honey, owing to the quality of the comb foundation, is not generally of a kind satisfactory to the consumer. Although it is desirable to get a foundation which, when utilized and added to by the bees, gives a comb as thin as the natural one, many claim that comb a trifle heavier is not noticed by consumers. When, however, the base and bottoms of side walls are materially thickened, and the comb has an artificial appearance, and the wax does

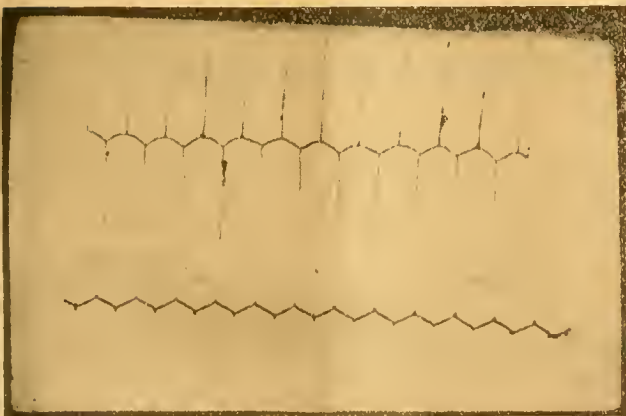

FIG. 2.—Giving a side view of comb foundation, 12 sq. ft. to the pound, and above the same after the comb has been completed and capped by the bees. The honey has been extracted and washed away from the comb, which, after a thorough drying, has been filled with plaster of Paris, and a section cut down.

not crumble when the comb is broken, the result is that the consumer objects, and the objection is intensified by the comparatively harmless nature of the change. Again, comb foundation and wax was wasted in the extra thickness; and this is no small item, as it is generally worth 50 or 60 cents per pound.

In our experiments, observations were taken along various lines—first, as to what extent, if any, the bees thin the base and side wall of the various thicknesses and kinds of comb foundation. Measurements were made, whenever possible, of the weight of foundation compared with the number of square feet, and the thickness of the base of foundation. Measurements were taken of the comb at the base, the side wall close to the hive, and half an inch up the side wall. The



FIG. 3.—Giving a side view of comb foundation, flat-bottomed, 12 sq. ft. to the pound. This shows a continuous piece of foundation. One half of the foundation was covered over, the other half exposed and worked out by the bees.

comb was put on ice to harden it for the purpose of more accurate measurement; and three measurements were taken in this case.

Again, to see just how the bees utilized the comb foundation, three tanks of melted wax were prepared. One was colored with a preparation of alkanet, another with a preparation of carbon, and the third was pure beeswax, uncolored. The various stages in the manufacture of comb foundation were carried out, giving comb foundation from each tank 10, 12, and 15 feet square to the pound.

These were placed side by side, and drawn out in the upper stories by the bees. It was manifested in various ways that the bees objected to the alkanet, so this kind was discarded. To the foundation, colored black with the preparation of carbon, the bees did not object. The object in placing foundation made of ordinary wax alongside of the colored, was to make measurements of each kind when drawn out by the bees. The measurements of the colored and uncolored being identical, gave us a basis for the statement that the bees did not object to this preparation; and the method of drawing this out was

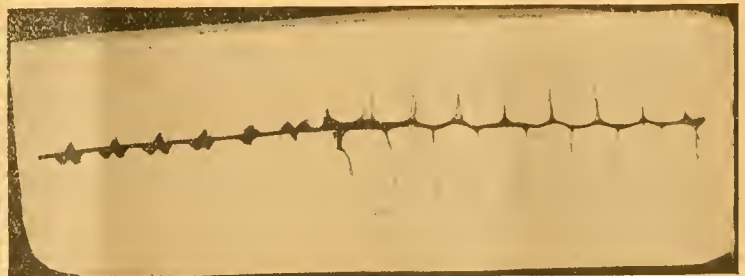

FIG. 4.—Giving a side view of comb foundation, flat-bottomed, 4 sq. ft. to the pound. This shows a continuous piece of foundation. One half of the foundation was covered over, the other half exposed and worked out by the bees.

identical with that of ordinary foundation. The base and lower part of the comb were not, as we might expect, of a black color, and the fresh and added wax white. Instead, there is a regular graduation from black at the base to white at the top of the cell. The heavier the foundation, the darker the base and adjoining side wall.

From the above it would appear reasonable to expect that

the bees kept adding scales of newly secreted wax and then pulling the side wall, thus decreasing gradually the percentage of colored wax. We also conclude that the quality of wax used in the foundation has an influence, not only on the base, but, to a certain extent, in almost the entire wall of the cell. The heavier the foundation, the greater the influence on the side wall. Again, notes were taken daily when the bees were beginning to draw the foundation; and although the heavier foundation was scattered about in various parts of the upper stories, they gave the preference to the heavier foundation, working on it first. Great caution must, of course, be observed in coming to conclusions. The bees, if the heavier foundation had been taken away, might have been almost as willing to go to work at once upon the lighter grade. At present no way appears open for conducting a satisfactory experiment to prove anything in this direction. The measurements taken at the base of the wall, and half an inch from the base, all tend to show that the wall is thicker at the base, and tapers, becoming thinner at the mouth. So far as I am aware, no one has ever made such measurements.

The "Vaudeusen" is a flat-bottom (unnatural) foundation. The various specimens of this kind which were put into the sections were partially covered to prevent the bees from

touching the covered portion. The remainder was left to the bees. In every case the bees changed the base from flat-bottom to natural. I have adopted a new method.

EXPERIMENTS WITH FIVE-BANDED ITALIAN BEES.

This is summed up in the following deductions:

- 1st. They are below the average as to wintering qualities.
- 2nd. They are short-lived, probably because of a high-strung temperament.
- 3rd. They are prolific.
- 4th. They are gentle, unless when queenless.
- 5th. They are inclined to rob.

In conclusion, I might say that the Ontario Agricultural and Experimental Union also conducted co-operative experiments with these bees. Nine successful experiments were made, and, with the exception of one experiment, the above results were indorsed.

[The foregoing is taken from *Gleanings*. We, also, received the Report referred to, which in all is a volume of over 400 large pages, about 10 pages being devoted to the "Report of the Apiculturist," by Mr. Holtermann.—EDITOR.]

PERSONAL MENTION.

EVERY SUBSCRIBER is invited to send us anything that would be appropriate for this or any other department of the *American Bee Journal*.

MR. T. F. BINGHAM (of bee-smoker fame), Farwell, Mich., wrote us May 16, as follows: "We have the most delightful spring—just as nice as California." That's the general report.

MR. H. E. HILL, of Spruce Bluff, Fla., has been writing some interesting letters to the *Aylmer Sun*, of Ont., Canada, about his travels in Cuba and the southern part of North America. Mr. Hill is a bee-keeper and writes occasionally for the bee-papers.

MR. B. TAYLOR, in his article on page 355, tells how the slotted separators are made. Any one interested, can have a sample separator mailed him by sending to Mr. Taylor (addressing him at Forestville, Minn.) 15 cents in stamps to pay postage and packing. Having a sample you will then know just how to make them yourself.

MRS. L. C. AXTELL, of Roseville, Ill., wrote on May 23: "Bees have been for three or six days making a living from white clover, which now promises to give us a better crop of honey than we have had for several years. We have had several heavy rains the past week." White clover seems to be reviving in various localities. Hope it will keep on till "the old-time honey crops" are here again.

MRS. B. J. LIVINGSTON, of Martin Co., Minn., is one of the busiest women we ever heard of. Referring to her active life, she says:

"I have too many irons in the fire. Myself and grown-up daughter are doing the work for three families—our own home with hired help to cook for; two (youngest) children who keep a room in town and are attending the Fairmount High School; and a bachelor son who has a farm two miles away. Then we are raising and shipping fancy

poultry and eggs—mostly white Holland turkeys and Light Brahma chickens. We also have 30 colonies of bees and the post-office, with reporting for two weekly papers, and making garden—but I'll stop."

Now, if the foregoing isn't enough for a small regiment to attend to, then we are away off. Where is the man that would undertake to successfully manage all that business? And yet some pompous individuals delight in referring to woman as the "weaker sex!" Not much. We know better, for our own dear mother is one of the "Livingston kind." All honor to the toiling, loving and never-despairing women!

MRS. M. LOUISE THOMAS, of Philadelphia, at the last meeting of the American Institute Farmers' Club, delivered an address on bee-keeping, in which she is reported to have said she knew of "two women who have incomes of \$5,000 each, annually, selling queens." Of course we don't like to doubt Louise's word, but in plain language we can only say we don't believe it. At least we won't until we have some proof for it.

We did hear, some time ago, that there was a noted (?) bee-woman somewhere that sold 5,000 queens in one season, but since learning that in reality the husband was doing business in his wife's name, we have put only about one-fifth as much confidence (if not less) in the 5,000 report.

As Mrs. Thomas was reported in the *Country Gentleman*, we call upon the publishers of that excellent paper to request her to furnish proof of her statement about those two "incomes of \$5,000 each, annually." We want to help crown somebody—either as the queen of bee-women or the princess of prevaricators.

Bee-Keepers' Photograph.—We have now on hand a limited number of excellent photographs of prominent bee-keepers—a number of pictures on one card. The likeness of 49 of them are shown on one of the photographs, and 121 on the other. We will send them, postpaid, for 50 cents each, mailing from the 121 kind first; then after they are all gone, we will send the 49 kind. So those who order first will get the most "faces" for their money. Send orders to the *Bee Journal* office.

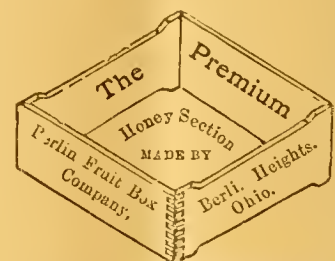

Address, **BERLIN FRUIT-BOX CO.**,
28A St. BERLIN HEIGHTS, OHIO.
Mention the *American Bee Journal*.

\$525 Agent's profits per month. Will prove it or pay forfeit. New articles just out. A \$1.50 sample and terms free. Try us. 22A St. CHIDESTER & SON, 28 Bond St., N. Y. WHEN ANSWERING THIS ADVERTISEMENT, MENTION THIS JOURNAL.

Hives & Combs For Sale.

45 10-frame Langstroth Hives, two-story, for extracting, as made and sold by T. G. Newman. These are empty—no frames—are well painted, and have been kept in the bee-house. Price, 75 cents each.

Also, 400 Brood or Extracting Combs for the above hives; they have the triangular top-bar as made by Newman. They are clean and in good condition. Price, \$15.00 per 100. I would take \$85.00 for the whole lot of Hives and Combs.

Reference—*American Bee Journal*.

W. C. LYMAN,
21A St. DOWNER'S GROVE, ILL.

MUTH'S HONEY EXTRACTOR PERFECTION Cold-Blast Smokers.

Square Glass Honey Jars, Etc. For Circulars, apply to CHAS. F. MUTH & SON, Cor. Freeman & Central Aves., Cincinnati, O. Send 10c for Practical Hints to Bee-Keepers. Mention the *American Bee Journal*.

Beautiful Golden Queens From Kan.

Let me tell you why my Golden Italians are better for comb honey than the 3-banders. Simply this—they cap their honey white like the blacks, and are splendid workers.

- | | |
|--|------|
| 1 Untested Queen, 75 cents or 3 for \$2.00 | |
| 1 Tested Queen, \$1.00. Breeders 2.50 | |
| 1 Breeder which I have bred from and found to be the best..... | 4.00 |
| 1 Franc Nuclei with Queen..... | 1.75 |
| 2 " " " | 2.25 |
| 3 " " " | 2.75 |

All orders filled promptly. Safe delivery guaranteed. P. J. THOMAS,
22A St. FREDONIA, KAN.

Mention the *American Bee Journal*.

A HANDY TOOL-HOLDER!

Sent by Express, for \$1.50 ; or with the Bee Journal one year—both for \$2.00.

Every Manufacturer, Miller, Carpenter, Cabinet Maker, Machinist, Wheelwright and Quarryman, Farmer, or any one using a grindstone, should have one of these Tool-Holders. One boy can do the work of two persons, and grind much faster, easier and with perfect accuracy. Will hold any kind of tool, from the smallest chisel to a draw shave or ax. Extra attachment for sharpening scythe blades included in the above price. The work is done without wetting the hands or soiling the clothes, as the water flows from the operator. It can be attached to any size stone for hand or steam power, is always ready for use, nothing to get out of order, and is absolutely worth 100 times its cost.

No farm is well-equipped unless it has a Tool-Holder. Pays for itself in a short time.

How to Use the Holder.

DIRECTIONS.—The Tool is fastened securely in the Holder by a set-screw and can be ground to any desired level by inserting the arm of the Holder into a higher or lower notch of the standard. While turning the crank with the right hand, the left rests on an steady the Holder; the Tool is moved to the right or left across the stone, or examined while grinding, as readily and in the same way as if held in the hands.

For grinding Round-Edge Tools, the holes in the standard are used instead of the notches.

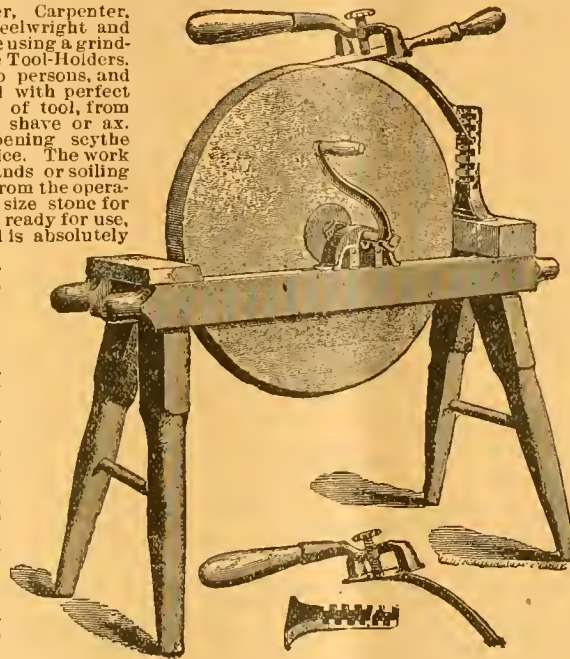

Address, GEORGE W. YORK & CO.,

CHICAGO, ILL.

PATENT WIRED COMB FOUNDATION

Has No Sag in Brood-Frames

Thin Flat-Bottom Foundation

Has No Fishbone in the Surplus Honey.

Being the cleanest is usually worked the quickest of any Foundation made

J. VAN DEUSEN & SONS,
Sole Manufacturers.

Sprout Brook Montgomery Co., N. Y.

Mention the American Bee Journal



ONE MAN WITH THE UNION COMBINATION SAW

Can do the work of four men using hand tools, in Rippling, Cutting-off, Mitering, Rabbeting, Grooving, Gaining, Dadoing, Edging-up, Jointing Stuff, etc. Full Line of Foot and Hand Power Machinery Sold on Trial. Catalogue Free.

SENECA FALLS MFG. CO.,

46 Water St., SENECA FALLS, N. Y.

1Aly Mention the American Bee Journal.

Dadant's Foundation in Chicago!

No other Goods kept here.

Send for Price-List,

CHAS. DADANT & SON,
118 Michigan St., CHICAGO, ILL.

13Atf Please mention the Bee Journal.

BEEES. QUEENS, and Several Carloads of APIARIAN SUPPLIES

always on hand.

Brood Found., 42c lb.; Section, 50c lb.

I. J. STRINGHAM,

105 Park Place. NEW YORK, N. Y.

That Queen-Clipping Device Free!

Works Like a Charm.

The Monette Queen-Clipping Device WORKS LIKE A CHARM. With it I have clipped 30 queens, all in one day, when examining my bees. WM. STOLLEY, Grand Island, Nebr.

Couldn't Do Without It.

I have clipped 19 queens, and must say the Monette Queen-Clipping Device is by far the best invention ever made, and will be welcome to many bee-keepers as it was to me. I could not do without one now.

DR. GEO. LACKE, Newburgh, Ind.

PLEASE READ THIS OFFER TO PRESENT SUBSCRIBERS:

Send us just one new name for the American Bee Journal a year (with \$1.00), and we will mail you the Queen-Clipping Device FREE of charge. Or, the Queen-Clipping Device will be sent postpaid for 50 cts. But why not get it as a Premium by the above offer? You can't earn 50 cts. any easier. Almost every bee-keeper will want this Device. See page 130 (Feb. 27) for full description of it. Complete directions accompany each one sent out. It is a most ingenious and useful article. Address,

GEORGE W. YORK & CO., 118 Michigan St., Chicago, Ill.

General Items.

A U. S. Bee-Association Urged.

The time is here when bee-keepers must organize so as to help themselves in every way possible. I very heartily approve of the plan given by Mr. W. F. Marks, on page 290, for organizing the "United States Association of Bee-Keepers' Societies"—(rather a long name, but I think it very expressive). The plan is a good one, and it seems to me that it is one that could be carried out easily. I think, though, that the county and district societies should be subordinate to their respective State societies; the county and district societies appointing delegates to the State meetings, and the State meeting appointing one delegate to the United States meeting from each congressional district. Thus, the bee-keepers of the entire United States would be represented in a great convention of bee-keepers, and the entire brotherhood would gain respect, and their rights would be observed by all.

And also the various and separate States would be thoroughly organized, and proper and needed legislation could be more easily secured.

Last winter the Central Iowa Bee-Keepers' Association appointed Mr. Jos. Nysewander, of Des Moines, and myself, as delegates to represent the bee-keepers' association, and present a petition before the Iowa legislature, asking that an experimental apiary be established at the Agricultural College at Ames, Iowa. The petition was presented, and all the assistance that could be given it was given, and I firmly believe that the reason the result was not more satisfactory was because of a lack of organization among the bee-keepers of the State. (I hope that this obstacle will be removed before another general assembly, and every bee-keeper in the State will be enlisted in the fight.)

This is a matter of great importance to every bee-keeper of the United States, and I believe that before we have gained all there is for us, we must take this step forward.

We are having abundance of rain, and everything is looking as if this would be a good honey-year. The bees all wintered well in this section, as a rule, last winter.

I hope bee-keepers will be encouraged enough to attend the bee-convention next fall at Marshalltown, Sept. 16 and 17. I will send further announcement later.

W. E. BRYAN.

New Sharon, Iowa, May 17.

Bee-Notes from Western Iowa.

Bees wintered well here last winter, for it was an extra open, mild winter. There are not as many bees as there were some years ago, on account of the recent drouthy seasons. Bees have been pretty poor property for the last three years, but it looks as if better days were dawning. We have had more than the average amount of rainfall since April first. We have just had (yesterday eve and to-day) the biggest rain we have had in a good many years. The past dry winter killed about one-half of the white clover, but the half that is left looks like the "better half," sure. If we escape frost, basswood may give us some honey again, and a wet spring

BUY "DIRECT FROM FACTORY," BEST MIXED PAINTS

At WHOLESALE PRICES, Delivered FREE For Houses, Baros, Roofs, all colors, and SAVE Dealers profits. In use 54 years. Endorsed by Grange & Farmers' Alliance. Low prices will surprise you. Write for Samples. O. W. INGERSOLL, 249 Plymouth St., Brooklyn, N. Y.

12A13 Mention the American Bee Journal

MURDERED

We have killed high prices. Give me a trial order and be convinced that good Queens can be reared for 50 cts. each. Untested, 50 cts.; Tested, 75 cts. Golden Italians, 3-Banded Italians, and Silver-Gray Carniolans, all the same price. Best of References given.

C. B. BANKSTON,

13A1f CHRISMAN, Burleson Co., TEX.

Mention the American Bee Journal.

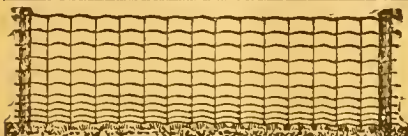

REFERENCES REQUIRED.

Before hiring a man you want to know where and how well he has worked. Just so with fences. Plenty of careful, thrifty farmers have had ours in use eight or ten years. Can you do better than ask their opinion. Send for our monthly paper free.

PAGE WOVEN WIRE FENCE CO., Adrian, Mich.

WHEN ANSWERING THIS ADVERTISEMENT, MENTION THIS JOURNAL.

A New Method

of refining wax without acid.

Result Better

Comb Foundation.

My prices are also the lowest.

A Job-Lot of No. 2

Polished Sections

Equal in finish to any No. 1's. 1 M. \$1.75; 2 M \$3.40; 3 M, \$4.80; 5 M, \$7.50. Or I can furnish a cheaper quality. Also, a full line of

HIGGINSVILLE SUPPLIES.

See my List with prices.

W. J. FINCH, Jr., SPRINGFIELD ILLS.

Mention the American Bee Journal.

IF YOU WANT THE

BEE-BOOK

That covers the whole Apicultural Field more completely than any other published, send \$1.25 to Prof. A. J. Cook, Claremont, Calif., for his

Bee-Keeper's Guide.

Liberal Discounts to the Trade.

California

If you care to know of its Fruits, Flowers Climate or Resources, send for a Sample Copy of California's Favorite Paper—

The Pacific Rural Press

The leading Horticultural and Agricultural paper of the Pacific Coast. Published weekly, handsomely illustrated, \$2.00 per annum. Sample Copy Free.

PACIFIC RURAL PRESS,

220 Market St., - SAN FRANCISCO, CAL.

TEXAS QUEENS.

If you are in need of Queens, let me have your order. Price-List Free.

8A26t J. D. GIVENS, Lisbon, Tex.

Mention the American Bee Journal.

ought to give us a good fall flow. So you see, with a few "ifs" and "ands," our prospects are quite fair for this year of grace, 1896.

Bees are running out of stores, and will probably need feeding before clover blooms. I suppose if we should get a crop we would have to give it away. There has not been any honey crop now for two or three years, and yet our home groceries sell comb honey for 12½ cents per pound. They call it "Colorado honey," and if it is not bogus, I wonder how much the man that produces it gets? I wouldn't think there would be much left after paying freight and commission.

I wish some reader in Colorado who knows, would let us know whether there is anybody in Colorado who can produce comb honey and ship it to Iowa, and retail it out for 12½ cents per pound. There was a neighbor of mine who has had bees a long time, who saw this honey, and who says it is "fed honey," or, in other words, sugar-honey, so-called. It seems to me this might be so, as I don't see why our Colorado brethren should sell their comb honey so cheap that it can be shipped this far, after being kept all winter, and sold cheaper than our own honey is sold, and that, too, when there is no other honey on our market. Of course, if they do it, and will persist in doing it, I have nothing further to say, but if this honey has sugar in it, I would like to find it out.

E. S. MILES.

Denison, Iowa, May 15.

A Report for 1895.

We started in with 39 colonies in the spring of 1895. We had 175 young colonies, besides some that we doubled up, and those we kept no trace of. We had 3,600 one-pound boxes, the rest being broken comb. We sold it for a shilling per pound. We put it in our last fall's report as extracted honey, but we did not extract any honey. We took up 30 colonies, and sold all we could, so we put 160 colonies into the cellar. When we took them out this spring there were three colonies dead, which left us 157 to start with. We have sold down, since we put the bees out, to 143, which we will keep this summer. If any one wants any proof, we would be pleased to have him write, and he will get it.

J. Z. RHODES & SONS.

Verndale, Minn., May 13.

Interesting Nebraska Notes.

In place of crying for rain, Nebraska people just now are complaining of too much rain. All the rain we didn't get for the last two years appears to be coming down all at once. It has rained nearly every day this month, and farmers begin to wonder how they will finish their spring planting.

To bee-keepers, though, the abundant moisture means the growth of honeypants, and perhaps honey. Bees have done well so far this spring. First came the bloom from soft maple, yielding enough honey to fill the hives in good condition for brood-rearing, which has been steady and well continued till the present time. The frequent rains for the last three weeks have prevented any vigorous honey-gathering, but as part of nearly every day the sun comes out, enough honey comes in for a living, and colonies are getting pretty crowded. The first swarm of the season came

The Bee-Keepers' Guide:

Or Manual of the Apiary,

By PROF. A. J. COOK.

This 15th and latest edition of Prof. Cook's magnificent book of 460 pages, in neat and substantial cloth binding, we propose to give away to our present subscribers, for the work of getting NEW subscribers for the American Bee Journal.

A description of the book here is quite unnecessary—it is simply the most complete scientific and practical bee-book published today. Fully illustrated, and all written in the most fascinating style. The author is also too well-known to the whole bee-world to require any introduction. No bee-keeper is fully equipped, or his library complete, without "THE BEE-KEEPER'S GUIDE."

Given For 2 New Subscribers.

The following offer is made to PRESENT subscribers only, and no premium is also given to the two new subscribers—simply the Bee Journal for one year:

Send us Two New Subscribers to the Bee Journal (with \$2.00), and we will mail you a copy of Prof. Cook's book FREE as a premium. Prof. Cook's book alone sent for \$1.25, or we club it with the Bee Journal for a year—both together for only \$1.75. But surely anybody can get only 2 new subscribers to the Bee Journal for a year, and thus get the book as a premium. Let everybody try for it. Will you have one?

GEORGE W. YORK & CO.,

CHICAGO, ILLS.

A Bargain—EARLY QUEENS.

119 Colonies Italian Bees in Chaff Hives: two acres land; good house; excellent well.

Early Queens—Tested, \$1.00; Untested, 50c. Sent by return mail.

E. L. CARRINGTON,

16A1f PETTUS, Bee Co., TEX.

Reference—1st National Bank of Beeville.

Mention the American Bee Journal.

CARLOADS



Of Bee-Hives, Sections, Shipping-Cases, Comb Foundation, and Everything used in the Bee-Industry.

I want the name and address of every Bee-Keeper in America. No reason why you cannot do business with me. I have

Cheap Lumber and Experienced Workmen; a good Water-Power Factory and know how to run it. I am supplying Dealers as well as consumers. Why not you? Send for Catalogues, Quotations, etc. W. H. PUTNAM, 1E RIVER FALLS, Pierce Co., Wis.

Mention the American Bee Journal.

Page & Lyon Mfg. Co.,

NEW LONDON, WIS., operates two saw-mills that cut, annually, eight million feet of lumber, thus securing the best lumber at the lowest price for the manufacture of bee-keepers' supplies. They have also just completed one of

The Largest Factories,

and have the latest and most improved machinery for the manufacture of Bee-Hives, Sections, etc., that there is in the State. The material is cut from patterns, by machinery, and is absolutely accurate. For Sections, the clearest and

The Whitest Basswood

is used, and they are polished on both sides. Nearness to pine and basswood forests, and possession of mills and factory equipped with best machinery, all combine to enable this firm to furnish the best goods at

The Lowest Prices. ♡

For instance, it has a job lot of 200,000 No. 2 Sections that will be sold at 50 cts. per 1,000; or 2,000 Snow-White sections will be sold for \$4.00, and larger quantities at still lower prices. Send for Circular and see the prices on a full line of supplies.

16A1f

Mention the American Bee Journal.

DO NOT ORDER UNTIL YOU HAVE WRITTEN US FOR PRICES ON

The "Boss" One-Piece Section



Also D. T. Hives, Shipping-Crates and Other Supplies.

We have completed a large addition to our Factory, which doubles our floor room; we are therefore in better shape than ever to fill orders on short notice. **Send for Price-List**

J. FORNCROOK,

WATERTOWN, Jeff. Co., Wis., Jan. 1st, 1896.

Barnes' Foot-Power Machinery.



Read what J. I. PARENT, of CHARLTON, N. Y., says: "We cut with one of your Combined Machines, last winter 50 chaff hives with 7-in. cap, 100 honey-racks, 500 broad frames, 2,000 honey-boxes and a great deal of other work. This winter we have double the amount of bee-hives, etc., to make and we expect to do it with this Saw. It will do all you say it will. Catalogue and Price-List

Free. Address, W. P. & JOHN BARNES, 45Ctf No. 995 Ruby St., Rockford, Ill.

The RURAL CALIFORNIAN

Tells all about Bees in California.

The Yields and Price of Honey; the Pasturage and Nectar-Producing Plants; the Bee-Hauches and how they are conducted. In fact the entire field is fully covered by and expert bee-man. Besides this, the paper also tells you all about California Agriculture and Horticulture. \$1.50 per Year; Six Months, 75 cents. Sample Free.

THE RURAL CALIFORNIAN,

218 N. Main St., - LOS ANGELES, CALIF.



Bee Supplies

Largest Stock and Greatest Variety in the West. **BEST Good at Lowest prices.** Cat. of 80 pages FREE.

KRETCMER, RED OAK, IOWA.

Mention the American Bee Journal. 23D9t

Sections & Foundation Reduced.

I am now selling Root's best polished **SECTIONS** at \$2.50 per 1,000; 2,000 for \$4.50; 3,000, \$6.45; 5,000, \$10.00. **The New Weed Process Comb Foundation** reduced 3c. per pound. See prices on page 14 of our Catalogue, or The A. I. Root Co.'s.

M. H. HUNT,

19D4t BELL BRANCH, MICH. Mention the American Bee Journal.

New England Supply Depot !

You can get the most complete Bee-Hive, also other Supplies, at—**H. ALLEY'S,** Room 5, 82 Water St., - BOSTON, MASS. 13Dtf Mention the American Bee Journal.

W. H. BRIGHT'S

CIRCULAR FOR 1896, describes everything needed in the apiary. Bees, Queens, Hives, Sections, Spraying Pumps, and Bright's Comb Foundation, sold at bottom prices. Send for one free.

Wm. H. BRIGHT,

17D4t MAZEPPA, MINN.

Full Colonies of Italian Bees for \$4.00. For particulars see larger ad. on page 350 of this paper. **Tested Queens,** after June 10th, 75 cts. each; 2 for \$1.25. Address, **T. H. KLOER,**

426 Willow St., TERRE HAUTE, IND. 23A4t Mention the American Bee Journal.

May 18. I try, by changing hives, to equalize the bees, and forming new colonies to prevent swarming as much as I can; still, they will swarm in spite of me, once in awhile, especially those in 8-frame hives.

Our bees wintered in excellent condition on fall honey. We did not have to feed any sugar, and they were apparently as strong when brought out this spring as when put into the cave last fall. We have fed no sugar this spring, but before flowers were plenty we supplied them with artificial pollen, and equalized the stores so that all had a plenty.

During the breeding season, in early spring, I disturb the interior of the hive as little as possible, managing to do most of the work without tearing the brood-nest all to pieces.

When our hives are brought out of the cellar they are placed in pairs on the stands. A glance tells their condition with regard to stores, and brood or eggs indicates the presence of the queen.

When they get so full of bees they begin to hang outside, and show symptoms of swarming, I fill a hive with brood and honey by taking one or two frames from several hives that can spare them, putting in empty combs or full sheets of foundation in their places, move two of the strong colonies from their stands to a new place, and set the hive in the middle of the stand where they stood. They can be given a queen or cell nearly ready to hatch, or be allowed to rear a queen for themselves. Having all the flying bees from the two hives moved away, they are very strong in bees, and ready for business right away; while the colonies moved will not swarm for awhile, and it disturbs them less than to tear the hive all to pieces hunting for queen-cells, which is no pleasant job at the best.

Mrs. A. L. HALLENBECK.

Millard, Nebr., May 21.

One of the Old-Timers Expected.

Bees are just rolling in the honey here. I look for one of those old-timers this year. Prospects were never better.

A. CARDER.

Tracy City, Tenn., May 23.

Why Fumigate Honey?—Outlook.

While reading "Fumigation of Comb Honey," by C. Davenport, on page 274, the query arose in my mind, Why is it necessary for him to fumigate his honey? My experience in handling comb honey is this:

When we first produced honey we used a box extending across the hive with glass in the ends and holes in the bottom for the bees to enter; later, we used a box composed of two-pound sections nailed together, and glass in the ends. When these boxes were removed from the hive, and free from bees, paper was pasted over the bottoms so nothing could enter. We never were bothered with moth-grubs in any honey kept in this way, but one box; and on examining it, found that there was a small hole broken in the glass, and we inferred that the moth entered through this and deposited her eggs.

Since using the one-pound sections, as soon as the cases are removed and free from bees, they are piled one upon another, leaving no aperture for moths, ants or bees to enter, and the uppermost

❖ MONEY SAVED IS MONEY GAINED. ❖

THE ROYAL UNION Life Insurance Company

DES MOINES, IOWA.

The Iowa Policy

Is one that definitely promises to keep an accurate account with you; credit your premiums and interest, charge the actual expense and mortuary cost, and hold the remaining funds subject to your order. Agents Wanted.

JOHN B. KING, GENERAL AGENT,

Suite 513 First Nat'l Bank Bld'g,

20A4t

CHICAGO, ILL.

Mention the American Bee Journal.

The Patent Wood-Veneer Foundation.

Bee-keepers should give it a test, and my All-Wax Foundation. I will guarantee there is no better made, as six years ago I discarded the old way of dipping for wax sheets, and a new invention of my own was discovered, which enables me to make the toughest kind of Foundation; also, no acid used to purify the Beeswax, and it preserves the smell of honey, which is more acceptable to the bees. Now is the time to send wax and have it worked up at low prices. Send for Samples and Catalog with low prices. Wax wanted at 31c cash, or 33c trade, delivered.

AUG. WEISS, Hortonville, Wis. 12A13t Please mention the Bee Journal.

1,000 Teachers' Oxford Bibles

Were bought for spot cash by a Chicago firm from an Eastern publisher who was about to be driven to the wall for the want of ready money. More than a million of these same Bibles, in every way like the illustration, have been sold during the past few years at three times the money we ask for them.



They are the genuine Teachers' Oxford Bibles, Divinity Circuit, round corners, gilt edges, complete teachers' helps, bound in French seal, limp, with perfectly flexible backs. Sent prepaid.

Regular price, \$4.50; our price, \$2.25. Or we club it with the Bee Journal for one year—both for only \$2.75; or we will give this fine Bible free as a premium to any one sending 4 new subscribers to the Bee Journal one year (with \$4.00). No additional premium is given the new subscribers—simply the Bee Journal one year to each of them.

GEORGE W. YORK & CO.,

CHICAGO, ILLS.

BEGINNERS.

Beginners should have a copy of the Amateur Bee-Keeper, a 70-page book by Prof. J. W. Rouse. Price 25 cents; if sent by mail, 28c. The little book and the Progressive Bee-Keeper (a live, progressive 28-page monthly journal) one year, 65c. Address any first-class dealer, or

LEAHY MFG. CO., Higginsville, Mo.

For Sale HOME, APIARY, QUEENS.—

½ Block of ground, some fruit, GOOD 6-room dwelling, shop, stable, honey-house and poultry-house (over 3,000 square feet of floor), 100 colonies of bees in chaff hives and fully equipped for comb honey, all in town of 1000 population and good alfalfa range and good water. Price, \$3,000. If unsold June 15th, will unqueen, and offer 2 year clipped queens at 25c.; 1 year, unclipped, at 50c. each. July 15th and after, young queens at 60c. each—all Italian and safe arrival guaranteed. This is a rare bargain, but I must get my wife to a lower altitude. Book your orders at once if you want these queens.

19A4t **R. C. ATKIN, Loveland, Colo.**

WHEN ANSWERING THIS ADVERTISEMENT, MENTION THIS JOURNAL.

one closely covered, and we have never found a moth-grub in a section yet, and we have never fumigated.

Where Italian bees are kept the moths have never an opportunity to deposit their eggs in the sections. Where Italian bees are kept, and an old hen with a lively brood have their freedom, the moths stand a poor show. I've been amused many a time by seeing an old hen giving a moth a lively chase, and catching him, too.

HIVES OF COMB.—In early spring, if we discover a hive with a dead colony we take out the combs, trim off queen-cells, and cut out undesirable comb, scrub the hive with hot soap-suds, rinse with boiling water, and as soon as it is dry, return the combs and store it in the cellar. It is a pleasure during swarming-time to bring up these hives without a grub in them.

OUTLOOK FOR HONEY.—In our experience in Illinois for half a century, we have never known so delightful a spring. The season up to April 5 appeared to be two weeks late, but since then vegetation has come forward on the double-quick; the leaves all made at once so new and fresh. There is the best prospect for white clover that there has been in five years, and sweet clover is very rank and abundant. May-day finds vegetation ahead of average seasons.

MRS. L. HARRISON.

Peoria, Ill., May 1.

The Charming Tune of Swarming-Time.

BY ED JOLLEY.

I seldom hear a dinner-bell
But thoughts arise like these—
Of how in yore it clattered
At the swarming of the bees.
We used to hear it often
In the months of May or June;
When the bees began their swarming,
Then we played our charming tune.

Grandma rang the dinner-bell,
Our aunt did beat a pan;
Brother Tom, he thumped the boiler,
While I hammered on a can.
When the swarm had all flown out,
And far around had spread,
"Just thump a little louder now,"
Our grandpa wisely said.

The way we beat that boiler, then,
"T'would make you smile to hear,
As the bees began to settle
On the lilac bushes near.
Then grandpa got the skep.
And with catnip rubbed it well,
So the bees would like their home
For its nice, perfumery smell.

When the work was all done up,
Did our grandpa smiling say:
"T'was by your lusty music, boys,
That you have saved the day!"
We smile to think it over now,
"T'was earnest business then
With grandpa, as well as us,
And nearly all the men.

But the work is different now—
The order's seen a change;
Things we used to think our duty
Are now thought very strange.
Yet I seldom hear a dinner-bell,
If the day is nice and warm,
But I seem to hear the boiler
And the tune that charmed the swarm.
Franklin, Pa.

Bee-Keeper's Guide—see page 364.



BINGHAM SMOKERS
Best on Earth and Cheapest.
Doctor, 3 1/2-in. stove, by mail, \$1.50; Conqueror, 3 in., \$1.10; Large, 2 1/2, \$1; Plain, 2, 70c; Little Wonder, 2, wt 10 oz, 60c
Bingham & Hetherington
Honey-Knives, 80 cents.
T. F. BINGHAM,
23D St Farwell, Mich.

Honey-Clovers & Buckwheat SEED FOR SALE.

We have made arrangements so that we can furnish seed of several of the Clovers and Japanese Buckwheat, by freight or express, at the following prices, cash with order:

	5lb	10lb	25lb	50lb
Alsike Clover	\$.70	\$1.25	\$3.00	\$ 5.75
Sweet Clover	.75	1.40	3.25	6.00
White Clover	1.25	2.00	4.50	8.00
Alfalfa Clover	.65	1.10	2.70	5.00
Crimson Clover	.55	.90	2.00	3.50
Jap. Buckwheat	.20	.35	.90	1.25

Prices subject to market changes.
Add 25 cents to your order, for cartage, if wanted by freight.
Your orders are solicited.

GEORGE W. YORK & CO.,
CHICAGO, ILLS.

Sweet Clover 1/2 Canada.

At the following prices:

5 lbs.	10 lbs.	25 lbs.	50 lbs.
\$1.00	\$1.60	\$3.75	\$7.25.

Also a quantity of Motherwort and Catnip seed. Prices on application.

EGGS for Hatching. Buff Leghorns, Indian Games, & Light Brahmans, Choice Birds. A breeder for 30 years. Prices on application

JOHN McARTHUR,
881 Yonge Street, TORONTO, ONT.
15A St Mention the American Bee Journal.



Promptness Is What Counts!
Honey-Jars, Shipping-Cases, and everything that bee-keepers use. **Root's Goods at Root's Prices,** and the best shipping point in the country.
Dealer in Honey and Beeswax. Catalogue Free.
162 Mass. Ave. Walter S. Ponder
INDIANAPOLIS, IND.
Mention the American Bee Journal.

Queens for Sale

Italian Queens—after May 15—Untested, 75c. each; 6 for \$4.00; 12 for \$7.20.
Safe arrival and satisfaction guaranteed.

Reference—George W. York & Co. Address,
F. GIABBE,
LIBERTYVILLE, ILL.,
Mention the American Bee Journal.

HONEY Wax Wanted.

We have a large amount of Pure No. 1 Alfalfa we will sell cheap.
Warranted the best, simplest and quickest Escape on the market. Sent postpaid to any address for 30 cts. It can be returned at our expense if it is not as represented, or we will send the Escape on trial to any bee-keeper wishing to test it in good faith. We are agents for the Ferguson Patent Hive with double-case Super and Wicket-Gate Honey-Board, with the Escape. It is the easiest, quickest hive to handle for the production of comb honey. Address,
E. S. LOVESY & CO.,
355 6th East St., SALT LAKE CITY, UTAH.
Mention the American Bee Journal. 9Atf

READERS Of this Journal who write to any of our advertisers, either in ordering, or asking about the Goods offered, will please state that they saw the Advertisement in this paper.

Question-Box.

In the multitude of counsellors there is safety.—Prov. 11-14.

State Appropriation for Apian Uses.

Query 16.—What are the best uses to be made of a \$500 State appropriation for the benefit of the bee-keeping interest?—COLO.

- C. H. Dibbern—I give it up.
- Rev. M. Mahin—I give it up.
- W. R. Graham—I don't know.
- H. D. Cutting—Experimental purposes in certain lines.
- Chas. Dadant & Son—Scatter publications over the country.
- E. France—Use it for the prevention and cure of foul brood.
- Eugene Secor—Get a law passed punishing adulteration, and use the money to enforce it.
- W. G. Larrabee—Prevent adulteration, and help to distribute the seeds of honey-producing plants.

Dr. C. C. Miller—I don't know. Perhaps to help establish a big State society or an experimental station.

R. L. Taylor—Those interested and acquainted with the situation there should be able to answer that.

Emerson T. Abbott—That depends entirely upon circumstances. All money raised by taxation should be used in a way that will benefit the general public.

Prof. A. J. Cook—It is best to discourage any such appropriation. Such legislation for the very few is very questionable, and the more if in a questionable cause.

Dr. J. P. H. Brown—In my judgment, the very best use it could be put to would be the dissemination of tracts, booklets, etc., teaching the people the uses of honey.

J. E. Pond—That depends so much upon localities, that each State should answer for itself. For my own State, it would require too much space to attempt to answer here.

B. Taylor—Give premiums for the greatest yields of honey from at least 25 colonies, with the method of producing it. Divide the \$500 into 20 or more premiums.

J. M. Hambaugh—By publishing the proceedings, conventions and other matters, of public interest, and placing it in the hands of the members of the bee-keeping pursuit.

P. H. Elwood—Spend it showing up the unhealthfulness of commercial glucose as food. It is much more objectionable than oleomargarine, and the popular recognition of this fact would enable us to outlaw it.

Mrs. L. Harrison—Invest it in the seed of the different varieties of clover, and distribute it gratuitously to all parts of the State, to those who would be likely to be interested in forage plants. He that hath grass, hath meat, milk and honey.

James A. Stone—Publishing reports of the associations, or expend it in literature (bee-papers) to circulate among those who will interest themselves

No. 1 4x4 Snow-white Sections \$2.00 per 1,000.



For the purpose of introducing our One-Piece Section to the bee-keepers generally, we have concluded to make the price \$2.00 per 1,000 for the season. Now is the time to get your Sections cheap. We have a choice lot of Section Lumber, gotten out of young timber, and we can furnish you the nicest Section to be had. Write for Sample Section Free.

THE MARSHFIELD MFG. CO.,

June 1st, 1896.

MARSHFIELD, Wood Co., WIS.

enough to become members of the organizations that work in the interests of bee-keepers. Farther than this we think an appropriation useless.

G. W. Demaree—Leave it in the State treasury. Thousands of people of our times who have a dread horror of modern "Socialism," are willing to practice the modern doctrine in an *exclusive* way. Universality, or not at all, is simple honesty.

G. M. Doolittle—Use it for reform literature to agitate so that all bee-keepers may not come to a state of serfdom. The high-priced (gold) dollar costs three times as much of our product to buy as formerly, and bee-keepers are fast becoming a race of slaves.

Allen Pringle—If the appropriation is an annual grant, a thoroughly organized State association ought to take charge of and expend the money in the interests of bee-culture in that State—by promoting the organization and affiliation of local societies to itself, etc.

Queens and Queen-Rearing.—

If you want to know how to have queens fertilized in upper stories while the old queen is still laying below; how you may safely introduce any queen, at any time of the year when bees can fly; all about the different races of bees; all about shipping queens, queen-cages, candy for queen-cages, etc.; all about forming nuclei, multiplying or uniting bees, or weak colonies, etc.; or, in fact, everything about the queen-business which you may want to know—send for Doolittle's "Scientific Queen-Rearing"—a book of over 170 pages, which is as interesting as a story. Here are some good offers of this book:

Bound in cloth, postpaid, \$1.00; or clubbed with the BEE JOURNAL for one year—both for only \$1.75; or given free as a premium for sending us three new subscribers to the BEE JOURNAL for a year at \$1.00 each.

No. 1 Sections—Cheap.

We offer for a few weeks, a surplus stock of our one-piece No. 1 Cream Sections at the following very low prices:

1000 for \$1.50.

3000 for \$4.00.

5000 for \$6.00.

These Sections are finely finished and No. 1 in all respects save color, being, as their name indicates, of a cream color.

The stock consists of a quantity each of the following sizes:

4½x2, open 2 sides 4¼x1 15-16, open 2 sides
4¼x1 7-8, open 2 sides
4¼x1½, open 2 sides 4¼x7-to-ft., open 2 sides

G. B. LEWIS CO.

WATERTOWN, WIS.

Mention the American Bee Journal.

Honey & Beeswax Market Quotations.

The following rules for grading honey were adopted by the North American Bee-keepers' Association and, so far as possible, quotations, are made according to these rules:

FANCY.—All sections to be well filled; combs straight, of even thickness, and firmly attached to all four sides; both wood and comb unsoiled by travel-stain, or otherwise; all the cells sealed except the row of cells next the wood.

NO. 1.—All sections well filled, but combs uneven or crooked, detached at the bottom, or with but few cells unsealed; both wood and comb unsoiled by travel-stain or otherwise.

In addition to this the honey is to be classified according to color, using the terms white, amber and dark. That is, there will be "fancy white," "No. 1 dark," etc.

CHICAGO, ILL., May 19.—We quote: Fancy white, 14@15c.; No. 1, 12@13c.; fancy amber, 9@10c.; No. 1, 8@8½c.; fancy dark, 8@9c.; No. 1, 8c. Extracted, white, 5@7c.; amber, 4@5c.

Beeswax, 28@30c. It continues to sell well and there is no accumulation of shipments. We consider it a good time to sell.

R. A. B. & Co.

PHILADELPHIA, PA., Apr. 23.—We quote: No. 1 white, 9@10c.; fancy amber, 8@9c.; fancy dark, 7@8c. Extracted, white clover, 10c.; amber, 5@5½c.; dark, 4@4½c. Beeswax, 25@26c. Comb honey is dull. Extracted in fair demand. Beeswax lower. W. A. S.

BUFFALO, N. Y., Apr. 20.—We quote: Fancy white, 15@16c.; No. 1 white, 13@14c.; fancy dark, 8@9c.; No. 1 dark, 7@7½c. Beeswax, 25@28c. Trade very dull and honey not moving, except a few fancy lots; anything dark is hard to sell. B. & Co.

CINCINNATI, O., Apr. 22.—There is no fancy white comb honey on our market. Best white sells at 12@14c. in a jobbing way, with a fair demand. Demand is good for extracted at 4@7c. according to quality.

Beeswax is in good demand at 25@30c. for good to choice yellow. C. F. M. & S.

KANSAS CITY, MO., May 20.—We quote: No. 1 white, 13@14c.; No. 1 amber, 10@12c.; No. 1 dark, 8@10c. Extracted, white, 6c.; amber, 5c.; dark, 4c. Beeswax, 22c. C. C. C. & Co.

NEW YORK, N. Y., May 9.—There is some demand for white comb honey at unchanged prices. No market for buckwheat. Extracted remains quiet. New Southern is now arriving and selling at 5@6c. for fine grades and 50@55c. a gallon for fair to common. Beeswax easy at 28@29c. H. B. & S.

List of Honey and Beeswax Dealers.

Most of whom Quote in this Journal.

Chicago, Ills.

R. A. BURNETT & Co., 163 South Water Street.

New York, N. Y.

HILDRETH BROS. & SEGELKEN,
120 & 122 West Broadway.
CHAS. ISRAEL & BROS., 486 Canal St.

Kansas City, Mo.

C. C. CLEMOMS & Co., 423 Walnut St.

Buffalo, N. Y.

BATTERSON & Co., 167 & 169 Scott St.

Hamilton, Ills.

CHAS. DADANT & SON.

Philadelphia, Pa.

WM. A. SELSER, 10 Vine St.

Cincinnati, Ohio.

C. F. MUTH & SON, cor. Freeman & Central avs.



PUBLISHED WEEKLY BY
GEORGE W. YORK & CO.,

At One Dollar a Year,

56 Fifth Avenue, CHICAGO, ILLS.

Postage to all Countries in the Postal Union is 50 cents extra. To all others, \$1.00 more than the subscription price.

Hebblewhite & Co., 369 George Street, Sydney, New South Wales, Australia, are our authorized agents. Subscription price, 6 shillings per annum, postpaid

Important to All Subscribers.

The American Bee Journal is sent to subscribers until an order is received by the publishers for its discontinuance, and all arrearages are paid.

Always State the Post-Office to which your paper is addressed, when writing to us.

A Sample Copy of the Bee Journal will be sent FREE upon application.

How to Send Money.—Remit by Express, Post-Office Money Order, or Bank Draft on New York or Chicago. If none of these can be had, Register your Letter, affixing Stamps both for postage and registry, and take a receipt for it. Money sent thus, IS AT OUR RISK; otherwise it is not. Do not send Checks on Local Banks—we have to pay 25 cents each, to get them cashed.

Never Send Silver in letters. It will wear holes in the envelope, or may be stolen.

Money Orders.—Make all Money Orders payable at Chicago, Ill.—not at any sub-station of Chicago.

Postage Stamps of any denomination may be sent for any fraction of a dollar; or where Money Orders cannot be obtained, stamps for any amount may be sent.

Subscription Credits.—The receipt for money sent us will be given on the address-label of every paper. The subscription is paid to the end of the month indicated.

Do not Write anything for publication on the same sheet of paper with business matters, unless it can be torn apart without interfering with either part of the letter.

Lost Numbers.—We carefully mail the Bee Journal to every subscriber, but should any be lost in the mails, we will replace them if notified before all the edition is exhausted. Please don't wait a month or two, for then it may be too late to get another copy.

Emerson Binders, made especially for the American Bee Journal, are convenient for preserving each weekly Number, as fast as received. They will be sent, post-paid, for 75 cents, or clubbed with the American Bee Journal for one year—both together for \$1.00. They cannot be sent by mail to Canada.

WARRANTED GOLDEN ITALIAN QUEENS By return mail; bred from a Breeder tested by Doolittle out of 1,000 Queens for his own use, and valued at \$50. Queens, 50c; 5 for \$2.75; or \$5.00 per dozen. **Leather Colored Queens** from Root's best imported stock same price. Bees from my Queens are excellent workers on red clover. I guarantee safe delivery. N. B.—I sent more than 200 Queens safely to California last season. **H. G. QUINN, Bellevue, Ohio.**
23A16 Mention the American Bee Journal.

Bottom Prices

**BRING US BIG TRADE.
GOOD GOODS KEEP IT.**

If you want the best supplies that can be made at a little less cost than you can buy the same goods for elsewhere, write to us for low prices. 1896 Catalogue now ready—ask for it and a free copy of **The American Bee-Keeper** (36 pages).

Address,
**THE W. T. FALCONER MFG. CO.,
JAMESTOWN, N. Y.**

Mention the American Bee Journal.

COMB FOUNDATION!

Wax always wanted for Cash or in Exchange for Fdn. or other Supplies. My trade is established on **Low Prices** and the merit of my **Foundation. Orders filled promptly.**

WORKING WAX INTO FDN. BY THE LB. A SPECIALTY. Wholesale prices to dealers and large consumers. Send for Prices and Samples to—**GUS DITTMER, AUGUSTA, WIS.** Reference—Augusta Bank. 1 Atf

Mention the American Bee Journal.

14 Years' Experience in breeding Italian Queens. **GOOD** Untested Queens, 75c, 3 for \$2.00. **CHOICE** Tested, young, \$1 each by return mail. A. I. Root Co.'s Supplies kept in stock at bottom prices. 36-page Catalog free.

JNO. NEBEL & SON, High Hill, Mo.

Mention the American Bee Journal. 4A26t

I ARISE



TO SAY to the readers of the **BEE JOURNAL** that **DOOLITTLE**

has concluded to sell—**BEEES and QUEENS**—in their season, during 1896, at the following prices:

- One Colony of Italians on 9 Gallup frames, in light shipping-box \$6 00
- Five Colonies..... 25 00
- Ten Colonies..... 45 00
- 1 untested queen. 1 00
- 6 " queens 5 50
- 12 " " 10 00
- 1 tested Queen... \$1 50
- 3 " Queens. 3 50
- 1 select tested queen 2 00
- 3 " Queens 4 00

Select tested queen, previous season's rearing . 4 00
Extra Selected for breeding, THE VERY BEST.. 5 00
About a Pound of BEES in a Two-frame Nucleus, with any Queen, \$2.00 extra.

• Circular free, giving full particulars regarding the Bees and each class of Queen.
Address

G. M. DOOLITTLE,

12A25t **BORODINO, Onon. Co., N. Y.**
Mention the American Bee Journal.

BEES **QUEENS**
Smokers, Sections, Comb Foundation, And all Apian Supplies cheap. Send for FREE catalogue. **E. T. FLANAGAN, Bellefite, Ill.**

6A26t Please mention the Bee Journal.

PURE BARRED PLYMOUTH ROCK

Eggs, \$1.25 per 14. Our P. Rocks are very large, with fine plumage. Also,

BLACK MINORCA EGGS,

a non-sitting and great laying breed. Both kinds raised upon our farm. Minorca Cockerels, \$1.00 each. **Mrs. L. C. AXTELL,** 16Atf **ROSEVILLE, Warren Co., Ill.**

Mention the American Bee Journal.

19th Year Dadant's Foundation 19th Year

Is still in the lead, for we use all the latest improvements, including the

NEW WEED PROCESS,

and still make the best goods. Remember that we do not use any acid to purify our beeswax, and that is why our Foundation preserves the smell of the honey and is more acceptable to the bees, than any other. It is kept for sale by

T. H. Strickler, Solomon City, Kansas.
G. K. Hubbard, Fort Wayne, Ind.
L. Hanssen, Davenport, Iowa.
C. Theilmann, Theilmanton, Minn.
E. C. Baglesfield, Berlin, Wis.
E. T. Abbott, St. Joseph, Mo.
J. M. Jenkins, Wetumpka, Alabama
John Rey, East Saginaw, Mich.
Vickery Bros., Evansville, Ind.

The Jennie Atchley Company, Beeville, Texas.
C. F. Muth & Son, Cincinnati, Ohio
E. Kretschmer, Red Oak, Iowa.
G. B. Lewis Co., Watertown, Wis.
James Reynolds Elevator Co., Poughkeepsie, N. Y.
Louisiana Bee-Keepers' Supply Manufactory, Donaldsonville, La.
Page & Lyon, New London, Wis.
John Nebel & Son, High Hill, Mo.

and many other Dealers. All agree in saying that no goods are better than ours.

Those of our customers who formerly bought through Thos. G. Newman can get our Foundation in **Chicago, Ill.**, by addressing us at **118 Michigan Street.** We keep no other goods there.

We make a specialty of **Veils and Veil Stuffs** of best quality, cotton and silk.

"LANGSTROTH ON THE HONEY-BEE"—Revised.

Bee-Keepers' Supplies, Smokers, Sections, Tin Pails, etc. **Samples of Foundation and Tulle FREE** with Circular. Instructions to beginners with Circular. Send us your address.

CHAS. DADANT & SON,

Mention the American Bee Journal.

HAMILTON, Hancock Co., ILL.

26c Cash Paid for Beeswax!

For all the **good, pure yellow BEESWAX** delivered to our office till further notice, we will pay 26 cents per pound, cash; or 30 cents for whatever part is exchanged for the American Bee Journal, Books or Seed, that we offer. If you want **cash promptly** for wax, send it on at once. Dark or impure wax not taken at any price. Address plainly,

George W. York & Co., 118 Michigan St., Chicago, Ill.

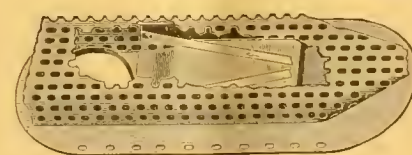

Porter Honey-House Bee-Escape

Have you seen it? Just the thing to put on the doors or windows of your bee-rooms. Indispensable, you'll say after you have tried it.

Corneil Bee-Smokers.

Cheap, strong, serviceable. We have sold a good many of these, and so far there has been no complaint; but, on the other hand, there have been scores of letters in their praise. Price, 85 cts. Prepaid, \$1.10.



COWAN.

Cowan and Novice Extractors.

These are the best. We are prepared to furnish, on short notice, from any of our several Branches, 2, 4, and 6 frame Cowans and 2-frame Novices. If you want the genuine, see that they

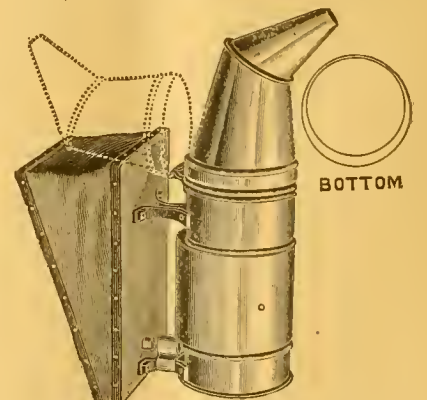

BOTTOM

bear our name. **A 36-page Catalog sent Free on Application.**

THE A. I. ROOT CO., MEDINA, OHIO.

BRANCH OFFICES AT:

118 Michigan St., Chicago, Ill.

1024 Mississippi St., St. Paul, Minn.

Syracuse, N. Y.

Mechanic's Falls, Maine.

AMERICAN BEE JOURNAL

DEVOTED EXCLUSIVELY TO THE INTERESTS OF HONEY-PRODUCERS

ESTABLISHED 1861
THE OLDEST BEE-PAPER IN AMERICA

Published Weekly, at \$1.00 per annum.

Sample Copy sent on Application.

36th Year.

CHICAGO, ILL., JUNE 11, 1896.

No. 24.



Working for Comb Honey—Swarming,

BY G. M. DOOLITTLE.

In my last article on working for comb honey, I spoke in brief about swarming, told something of when it should be done, how after-swarming could be prevented, and something about putting on sections. In this I will tell more minutely about how I manage swarms and swarming, and also how I often make an artificial increase with those which do not swarm up to the latest date that would make natural swarming profitable.

If we have worked along the lines given in previous articles, our hives will be well filled with bees in time for the honey harvest, and in order to meet with the best success swarming must be done up before the height of the season arrives, as I have already hinted at. Some seem to think that a larger amount of section honey can be secured where bees are not allowed to swarm, but I think this a mistaken idea, for the swarm and old colony, if rightly managed, will do as much separately as they would kept together, and, beside, if we tried to keep them together by cutting out queen-cells, etc., we would only delay swarming so it would come during the last half of the honey harvest, when it would be the most detrimental to our interests.

All of my early swarms are hived singly in a hive having five empty combs in it, as I usually have plenty of such on hand, and the sections transferred from the parent colony to the new swarm. At the end of 21 to 24 days, these five combs are spread apart and four empty combs put in each alternate space, so that there is no danger of these early swarms swarming again, and thus room is also given for the storing of sufficient honey for wintering. My hive holds nine frames, and the insertion of these four combs fills out the hive. If I used any other number of combs I would insert a number to make the full capacity of the hive, at this time.

By early swarms, as spoken of above, I mean those which come from 10 to 15 days before the honey harvest. Those coming from 5 to 8 days later are united so two are placed in a hive filled with comb foundation, the sections being set from the old colony which is moved away, on the doubled swarm. In this case one of the hives casting a swarm is taken to a new location, and the old queen belonging thereto is put back,

having the double swarm on the stand it previously occupied. The hive furnishing the queen for the doubled swarms, is not disturbed in eight days, when it is treated as I gave in my last article on this subject. All that have not swarmed at the commencement of the honey harvest are made to swarm in this manner:

A hive is filled with frames of empty combs and placed upon the stand of one of the colonies which have not swarmed, and all the sections are taken off and placed thereon; then all the bees are shaken and brushed off their combs of brood and honey in front of this prepared hive. Thus, we have the queen, bees, partly-filled sections, etc., which makes a colony ready for business at once. Previous to this, nuclei have been formed, so that I have plenty of laying queens to use as I may need them.

I now take all the combs from which the bees were brushed except one, and arrange them back in the hive, carrying it to the stand of another colony which has not swarmed. I next take the comb of brood which was left out, and go to a nucleus, taking out the frame having the laying queen on it, and put the comb of brood in its place. I now take the frame, bees, queen and all, and set it in the place left vacant for it when arranging the combs of brood. I next put on the proper amount of sections, and when all is complete move the colony not having swarmed to a new stand and set the prepared hive in its place. Thus I have a laying queen and enough of her own bees to protect her, combs full of brood, and all of the field or old bees from the removed colony, which makes a colony which is ready to go into the sections in a few days. The removed colony has simply lost the old or field bees, so as to stop the swarming impulse, and in a week will be ready for work in the sections again.

All colonies allowed to swarm naturally rear their own queens, contrary to the advice generally given, "that no colony should be allowed to go queenless at this season of the year by waiting for queen-cells to hatch," for, after repeated trials, I have come to the conclusion that better results can be secured by allowing the old colonies to rear their own queen than by giving them a laying queen immediately after swarming. As there is plenty of room given for storing in the brood-chamber as fast as the young bees hatch out, the honey is mostly stored below till the queen is fertilized, when it is at once removed to the sections to give her room to deposit eggs. In such cases I have frequently had a whole set of sections (60 pounds) filled and completed in 12 days.

As there is little honey secured in this locality after Aug. 10, if a laying queen was kept in the hive all of the time, the bees from her eggs would hatch in a time to only swell the number of consumers without being any profit, and much honey would be used in feeding the larvæ for these useless consumers; besides, such a colony usually takes the swarm-

ing-fever again so as to thwart the plans we have made. Where a person has a continuous honey harvest, then it is well to rear bees in abundance all of the season, but if I am well-informed, very few have such a locality.

All agree that it is a waste of time, honey and vitality, for bees to rear a lot of non-producing drones, and many articles have been given showing how this may be avoided, and I believe it is equally as absurd to rear a host of consuming workers out of season, and I have given in the above some of the things which give me this belief. Borodino, N. Y.



Bee-Keepers Not Suffering from Over-Production of the Honey Product.

BY H. F. COLEMAN.

I have read with much interest the article of Mr. Doolittle on page 163, with reference to over-production, but I cannot say that I was greatly surprised at the range of prices of honey from the year 1874 to the present—a period of 22 years. It is true that the difference between 28 to 30 cents per pound obtained in 1874, and 13 to 15 cents per pound obtained at present, is very large, but in my opinion the trouble is not in the over-production of honey, but in the increased production of other luxuries and necessities of life, combined with a contraction of the currency of the country. It is perhaps true that there is more honey produced now than in the year 1874, but not to a greater extent than the increase in the population of the country, and this being true, everything else being equal, there should be no very great difference in the prices or demand for honey. But everything else is not equal. There has been a great increase in the production of the fruits and sugars, and these combined, at their present low prices, to a great extent, have supplanted honey, and form the principal table-luxuries of the people.

It is a rule, founded in economy, that the human family will use and subsist upon the cheaper commodities, if the cheaper commodities will meet the ends in view. And this rule applies with unusual force at a time like this, when there is a stringency in money matters.

If Mr. Doolittle will reflect for a moment, he will remember that there has been a gradual decline in prices, of nearly all kinds of products, since 1874. Wheat, corn, pork, beef, potatoes and other farm products have declined to an extent that is almost alarming, and we should not be surprised to see honey in the wake.

And there is still another rule, founded in economy, that has its influence on the prices of honey. Honey is a luxury, and when men are in the straits, financially, they curtail expenses, and the luxuries are the first to be dispensed with.

It is not my purpose in this article to say anything with reference to my views as to the causes of the present financial depression, but we can see that it is very desirable to beekeepers that we have an era of prosperity—an era that will place within the reach of all the real luxuries of life. When this time comes, honey will again be sought after as an article of consumption, and the good old days of the long ago will in a measure be restored. I say in a measure, for I do not believe with the increased production of sugar and fruits, which are so easily turned into marmalades, jellies, and other luxuries, that honey will ever again be in as good demand for table use as in days gone by.

I usually sell my honey at home and in neighboring towns, and the demand is always graded by the supply of fruit, and the ability of my friends to buy. A few years ago (1885) my crop was the largest I ever had, but the fruit crop in my section was a failure, and the entire honey crop went off at fine prices before cold weather.

Last year my crop was medium, but the fruit crop was

large, and the result is, I have several hundred pounds of nice white honey still on hand.

Notwithstanding the low prices and comparatively small demand for honey, I do not mean to give up bee-keeping! Neither do I believe that Mr. Doolittle will give it up. The value of a product is not measured alone by the dollars and cents it will bring, but by the buying capacity of what it does bring. Twenty years ago, when we were getting fancy prices for our honey, we were paying the same kind of prices for what we bought. At that time we paid at least one dollar per bushel for wheat, and other things in proportion, and now it will not take a greater number of pounds of honey to buy a bushel of wheat than then. Of course, I mean generally speaking.

From what has been seen (from the above), we as beekeepers should not bemoan our fate alone, as to low prices, but should exercise that broad sympathy that will extend to all classes suffering from the same cause.

Sneedville, Tenn.



Wax Experiments—Methods of Rendering: Quantity and Quality.

BY R. C. AIKIN.

How shall we render wax? How much can I get from a given number of combs, and what will be the quality? We do stick to old methods with wonderful tenacity, even when there are ways that are better. I have rendered wax with water and with steam, using several different ways of applying the heat. I have also used the solar way for 10 or 15 years. I have made at least five solar extractors, ranging in size from 18x30 inches to 6x6 feet. I have made them movable and stationary; built two of brick, the last one of which is built against the south side of my shop, and is 6x6 feet, all openings into it being in the shop. A furnace is also beneath to apply fire when needed.

Last year I had occasion to melt a lot of extracting-combs. I thought this a good opportunity to test the yield of wax from a given number of combs. I remember reading years ago (I think in Kretschmer's "Bee-Keepers' Guide") that an ordinary brood-chamber required about two pounds of wax to build the comb to fill it. The combs I had to melt were in part almost new, both natural base and foundation combs. Part had been used for brood, some quite black. I first put 100 bright combs into the solar, average Langstroth size combs, and got 20 pounds of wax. Two other lots of 100 each were melted separately, the least yield being 17 pounds.

The 100 brighter combs yielded 20 pounds after having been extracted from a few times; I would expect almost as good a yield from strictly new combs—probably a little less wax but a little whiter. The dark combs, I am sure, have as much wax in them, but the mass of cocoons carry with them probably about 1/10. The grade of wax from these three lots was almost the same, being a bright yellow. The wax left with the refuse is not entirely lost, for it makes fine fuel and kindling, thus making the dark combs almost if not quite as valuable as the brighter ones.

Some seem to think there is no better way to render than the submerged-sack method; but all things considered, the solar is far ahead of this method. The first saving is in time. I save all odds and ends, burr-combs, hive-scrappings and bottom-board litter, and put all in the solar. The very blackest old comb you may have—though not yielding as much wax as the meltings before-mentioned—will give a bright wax from the solar; but if put through water it will be very dark.

Of the afore-mentioned meltings I took about a half-bushel of the refuse and put it into a sack and submerged it in a can of water, boiled, stirred, punched and twisted the stuff, and yet I could not get enough wax to rise to make a

scum on the water. I then took the bag out and put it under the pressure of my own weight, and squeezed out $\frac{1}{2}$ pound of wax—wax that was blacker than any I ever saw in the darkest brood-foundation. A few years ago I tried a similar plan on a lot of refuse, and got about 10 per cent. more wax that was quite dark, but in this case the solar work was rushed through, and the stuff not left to drain as it should, for I knew I was going to treat it again, and I wanted to get the wax out as quickly as possible. I suppose in the last 15 years I have produced 3,000 or 4,000 pounds of wax, the most of it going through the solar.

Another important point is the honey saved. Here and there are bits of candied honey, covered cells and bits that usually would be unnoticed, yet turn out quite a lot of honey that is saved for feeding. No care is needed in picking out patches of honey, for it will not be lost in the solar, but would be by the water method. I always accumulate from the solar more honey than wax. I always put a little water into the pan, for the evaporation would make the honey into taffy—too thick to pour.

The first mistake with apiarists is to make their solar wax-extractor too small. The next mistake is to make the box and sash of wood. Wood will not stand the extremes of heat, wet and dry. The putty will loosen and cracks open. I have a sash part wood and part iron. The iron stays all right, but the wood part is always more or less loose. The walls are of brick built upon the ground, and the inner parts of tin. It is 6 feet square, and fronts south. Were I to build again, I would make it longer east and west, or, what I think still better, build with the corners pointing north, east, west and south, making a hip roof with a southeast and southwest slope, and so get the sun all day. Large glass is not necessary. I have glass in mine that is not over 4 inches by 16. I use straight-edge glass and oil the joints, the glass butted—not lapped.

A large solar will also serve as a liquefying concern. Once in the month of March I liquefied a thousand pounds in two days. The honey was in three and five pound lard-pails, and all put in at one time. Fire was used beneath in this case, but where the cans of honey are spread over the solar so that the sun shines on each pail or can direct, the sun alone will do the work any ordinary clear summer day.

Should I continue to produce extracted honey, and have to liquefy the same, I would not do it with water or steam. An appliance for the use of hot air—much on the plan of an oven—will do the work just as well, and much cheaper, and any kind of a vessel can be put in. I have been using pails lacquered and stenciled, and it is no little satisfaction to be able to melt honey right in the pails when it has become candied in them. To set these pails in water would spoil the paint and lettering, but the dry hot air does no damage whatever.

Loveland, Colo.



Planting for Honey Alone—Lindens.

BY R. S. RUSSELL.

In reply to Dr. Miller (see page 486, of the Bee Journal for 1895) on the above topic, I would say that he demands the proof that it will pay, and admits that he may have been led astray in joining the crusade against planting for honey, or making any effort to perpetuate or improve our great honey-plants. He says he is ready to recant, provided the proofs are given that he is wrong. Now, it seems to me we should have some evidence to prove that the Creator of the bee did not understand the proper food required for its sustenance before admitting so mischievous a theory to controversy.

Who will come forward and prove that it will not pay to plant for honey alone? I wish to see this evidence. Let's

see. The field of this locality contains at least 100 square miles for 100 colonies, and is growing larger as the flora decreases. This decrease has been so rapid in the last 40 years as to be utterly beyond computation, yet it is safe to say that for each acre of this field sown to honey-plants, 1,000 have been rendered as barren as any desert for honey. And for each honey-producing tree planted in the field, more than 1,000 of the very finest have been destroyed. Our honey industry has kept in line with the general destruction of the native flora, and the result is now visible to our people.

In this once famous honey-belt where dearths were unknown, with its countless numbers of prosperous colonies in skeps, boxes and logs of all sizes and varieties, and the hollow trees breaking down with their loads of honey, and bees on a parity with gold and silver, may now be seen a lot of old patent hives of all kinds piled up in fence-corners, with now and then a diminutive colony labeled "For Sale," or trade, and, like the poor tramp, they are looking for a job.

But with this great object lesson before our eyes, who is there yet to still declare that it will not pay to plant for honey, for they have tried it? How many square miles of honey-plants has he placed in the field to substitute for the thousands of acres of corn, wheat, oats, potatoes, rye, barley, timothy, blue-grass, sorghum and tobacco raised in his field annually? How many lindens, poplars, honey-locusts, sour-woods, willows, etc., did he use in the experiment to substitute for the thousands destroyed in his field annually? How many years were required for the experiment? These are factors that will bring the question to a point.

It is seen that sowing a few acres in buckwheat, or a small field of clover, or planting a few lindens, is no test whatever, and the fact remains that we must sow or we cannot reap.

I am asked to point to a successful case of planting for honey alone. I answer, the wise Creator gave us a most beautiful example in North America, where each locality was supplied with honey-plants suitable to its latitude before introducing the honey-bee, and that he designed they should be perpetuated there can be no doubt, as he supplied each variety with an abundance of seed, so constituted as to admit of almost endless improvement, which, unlike other plants, have been wholly neglected, and are now mostly destroyed, causing most disastrous results to the honey industry. The situation is not only strange, but alarming, as many bee-keepers now admit that the goose that layed the golden egg has been killed.

The Doctor asks, What shall we plant? I answer for our latitude:

First of all, lindens, for the following reasons: They are long-lived, native trees, very hardy, and originally produced more honey than all other plants and trees combined, and by proper selection of varieties they will give a steady flow for two months, with rare failure.

2nd. They are the most beautiful shade or ornamental tree on the earth, and require no trimming or pruning; but maintain a most beautiful form until death, when their bodies would again doubly repay the expense for rearing them, aside from the honey and shade.

Perhaps in other localities some other tree might be more suitable for the purpose. We have 1,000 miles of public roads on each 100 miles square—sufficient room for 650,000 lindens, or 2,000,000 to each county, or 182,000,000 in our State; and it is thought our Legislature, at its next session, will pass a law compelling all land-owners to plant suitable shade-trees on said roads, and if so, why can we not have the lindens? Surely we can, if we make proper effort.

I, for one, am sure that no man need fear a failure of honey with 250,000 nice lindens in reach of his bees. The Indiana State Bee-Keepers' Association, at its last session,

passed a ringing resolution endorsing planting for honey alone, also urging our Legislature and various park commissioners, and all citizens of our State, to use their entire influence in propagating our most beautiful and useful lindens.

Prof. Cook, on page 177, has given some very fine suggestions, and it is hoped others may follow. I think Mr. Doolittle, on page 188, gave about the correct answer to Query No. 7, in bee-parlance: The National hive is overstocked with drones, and they are devouring all the honey.
Zionsville, Ind.



POISONOUS HONEY—DO BEES GATHER IT?

SKEPTICAL ABOUT POISONOUS HONEY.

I have been much interested in the articles which have appeared in the American Bee Journal of late respecting poisonous honey. It is a subject in which I have been much interested for many years, and to which I have given no little attention. I have also received from time to time specimens of the so-called poisonous honey, and so have had good opportunity to examine and test it. I must say that I am very skeptical in regard to the matter. It is so easy to see how reports of poisonous honey would get abroad without any real facts to support them, that I think that we may all be cautious in coming to conclusions in this matter.

Probably what gave rise to this opinion more than any other one thing was the old account from Xenophon, I think, of soldiers in the old days eating poisonous honey and becoming very sick. I much question if this account should have the least influence in forming the opinion of any careful investigator. I can very readily understand how soldiers might be very generally and very seriously ill by eating even the best of honey. I know of an excellent case in point: At the Michigan Agricultural College the students have always been required to labor upon the farm. In the early days, I think it was in the winter of 1858, the students were so fortunate, or perhaps unfortunate, as to cut a bee-tree well filled with honey. It was just before noon, and as is generally the case of young men, all were very hungry. It was needless to say that the honey tasted very good, and that the students indulged their appetites without let or hindrance. It is just as true that at the recitation that afternoon there were very few students. There were, however, two or three score of very sick young men; many of them thought surely their last days had come. Had there been some Xenophon present, we should no doubt have had a thrilling account of poisonous honey.

Another reason that has had its influence in giving currency to the opinion that honey from certain flowers is poisonous, comes from the fact that certain plants are poisonous; thus people would easily reason that if the foliage was poisonous to animals eating it, or if it poisoned those who rubbed against it, why, of course, the honey or the pollen would be poisonous to bees! Thus, with no fact to support the theory, the theory is set afloat to be copied annually or oftener into some paper, and thus the view becomes established in our literature as a fact. There is as little ground for the conclusion in this case as in the other.

We can well see how that in the development of any plant poisonous qualities would be of service, and through the principle of "natural selection" might be secured by the plant. We see just such developments in the poisonous hairs and secretion of insects which serve to protect them from their enemies. Thus it would be of advantage to plants to secrete poisonous substances within the substance of their leaves or branches. This, however, would not be at all true in case of the pollen or nectar. It is an advantage, not a disadvantage, for the bees and other insects to come and gather the pollen or the nectar. Thus, while a plant might secrete poison in

its leaves and foliage, it could never do so on the principle of "natural selection" in its pollen and nectar. The flower wants to attract the sweet-loving insects and foster their visits in quest of nectar or pollen, and so we should never expect to find either the nectar or the pollen poisonous, at least to insects, whose friendly visits are always of service to the flowers. We see, then, that in the physiology of plants we can easily explain the presence of poison in twig and foliage, but to find it in nectar and pollen would be entirely exceptional and inexplicable.

Another argument in favor of the poisonous qualities of some honey comes from actual cases often reported by physicians and the press. These cases are generally from regions where the mountain laurel or *kalmia latifolia* grows. The fact that this plant is said to be poisonous to stock might naturally lead to the opinion that the honey from it would be poisonous as explained above. There are very good reasons to doubt the accuracy of these observations and reports. It is an unquestioned fact that in many regions along the Alleghany Mountains this mountain laurel is very abundant, and is visited profusely by the bees. Yet there is never any trouble from poisonous honey.

As we have already seen, even the best of honey, especially if eaten in undue quantities, may make any person sick, and often will make some people always sick. So we see it is easy to account for the sickness without deciding that the honey is necessarily poisonous. I have often, myself, known of cases where people have been made deathly sick by taking only a few teaspoonfuls of honey, and that of the best quality—honey that I could eat *ad libitum* without the least injurious effect. Suppose, then, that a person should eat heartily of honey in the region of the mountain laurel bloom; it is easy to see how some not over-scrupulous or over-cautious physician might start a first-class sensational report regarding poisonous honey.

But I have other evidence which to me is more conclusive than any yet offered. While in Michigan I received a large number of samples of the so-called poisonous honey; some of them were as white and beautiful as the white clover honey, and as agreeable to the taste; while others were bitter, and some of it dark as well as ill-flavored. In every case I ate freely of this honey, and according to reports am alive yet. I even went farther than this. I took the great risk to ask my friends to eat of this honey, and in no case was there the least ill effects from it. I have thus had honey from Pennsylvania, Eastern Tennessee, North Carolina and South Carolina, all of which was reported to be poisonous, and all of which, to my certain knowledge, was as wholesome as any honey.

Of course, we ought not to be dogmatic in any such matter. It is very easy for any of us to be mistaken, but from the facts given above, I have come to the conclusion that we need more and better evidence than we have yet had before we decide positively that the flowers secrete poisonous nectar.

To sum up: It is easy to see how reports of poisonous honey have become current from the very nature of honey, and without any basis of fact. It is also easy to see how that people given to theorizing might conclude that honey from certain flowers was poisonous without any real reason for doing so. Again, the fact that many of the so-called poisonous plants abound in regions where poisonous honey is never reported, gives a "black eye" to this theory. Lastly, actual tests of the very honey pronounced poisonous have failed to show the presence of poison.
A. J. Cook.

Claremont, Calif.

PROBABLY POISONOUS POLLEN.

The communication from A. D. Watson, on page 220, on the subject of mountain laurel, was read with great interest. I have just learned from an old resident of this county, who is a close observer, of a case of poisoning from eating honey

taken from a bee-tree cut in the month of August, many years ago, about 50 miles south of this place. Two of the party died, but the third man recovered, and himself related the incident to my informant. He said that there was very little honey found in the tree, and that in eating it, they necessarily consumed a good deal of "bee-bread."

Perhaps in the above incident lies material for a reconciliation of conflicting theories as to poisonous honey. My own observation convinces me that honey gathered from mountain laurel is not poisonous. But history and many well-attested cases support the view that persons have been made sick while eating honey. Now, if the pollen gathered from plants of a toxic nature is poisonous, it would account for the effects said to be produced, and afford an opportunity for harmonizing opposing experiences.

I have seen some people eating comb honey from box-hives in which there were occasional cells filled with pollen and capped over. Though the taste in such cases is nauseous to my own palate, some persons are not much inconvenienced by the presence of a few cells of pollen. The soldiers of Xenophon, who came upon the bee-hives—perhaps after a long day's march, when they were tired and hungry to the last degree, probably in the scramble of each man for a morsel of honey-comb—did not stop to get rid of a cell of pollen here and there, and so numbers of them fell sick, and the poison which prostrated them may have been in the pollen and not in the honey.

My own firm belief is, that the Creator, who made the honey-bee for man's use, has so arranged the order of Nature that man will find in the use of the honey gathered by this insect nothing to destroy life. Pollen was not intended to be eaten. Its unpleasant taste under ordinary circumstances would cause it to be instantly rejected.

It is to be hoped that the editor will invite those of his readers who have had any experience "along this line," or who know of well-authenticated cases of poisoning from the use of honey, to make inquiries whether it was from eating comb or extracted honey, and if comb honey was consumed, whether pollen was not present in the honey eaten; and to report cases and compare notes in the American Bee Journal.

The occasional report of "death from eating poisonous honey" is not calculated to advance the market quotations. If the result of this investigation should crystallize into a conviction in the public mind that the only avenue of danger in any case is through consumption of honey in the comb when cells of pollen are present, it might be to the advantage of all.

Columbus, Miss.

• NOVICE.

NOT POSSIBLE FOR BEES TO STORE POISONOUS HONEY.

Like Novice, on page 146, I was for a long time skeptical concerning the theory of poisonous honey. Notwithstanding a few eminent ones have, all along, asserted that bees gather poisonous honey, and a few instances are recorded where persons have *apparently* been poisoned by it, I must assert that I do not believe it possible for a bee to store poisonous honey in her hive.

The bee was created for at least a two-fold purpose, viz.: First, for the transmission of pollen from one flower to another. Second, for gathering nectar from the flowers and storing it in combs for food for man.

While the instinct of the bee borders very closely upon reason, the possibility of her furnishing man with a poisonous diet was not left to instinct alone, but she was so constituted that any substance that would be poisonous to man would be poisonous to her. And the poisonous nectar (if there be such a product) taken into the honey-sac would affect the tissues and kill the bee before she could store it in the hive. I have arrived at this conclusion after experimenting with several poisons, feeding them to bees by dissolving them in honey. In every instance the bee has been affected by the poison to

that extent that she was not able to return to her hive, and in most cases died within the fatal limit of the poison used. A bee is more easily affected by a poison than is a man. A solution of alcohol so weak that a man could not hold enough of it to make him dizzy, will make a bee so drunk that she cannot get home. Try it, ye Doubting Thomases, and doubt no longer. *Don't drink it yourself, but give it to the bee!*

The mountain laurel and yellow jasmine (*Gelsemium sempervirens*) are thought by many to produce poisonous nectar, simply because their leaves and bark contain a poison. There is a great deal of mountain laurel near one of my apiaries, and the yellow jasmine is seen on every hillside, and along the creeks and branches all around. On their return home it is not easy to tell which bee has visited the laurel, but every one that has been in the jasmine blossom is known by her yellow coat.

The laurel yields honey, and is visited by many bees from 8 a.m. to 4 p.m. Yellow jasmine blooms here from April 10 to the 20th, while several other honey-yielding trees are in bloom, and the bees seem to prefer it to any other. During this time the bees usually store some honey. This is the first honey we get, and as soon as the children find out that there is honey coming in, they want some *new* honey; and every year we extract some of this half-ripe, watery stuff, and we all eat of it very freely. (We didn't know it was poison.) We sell several tons of honey to our neighbors every year, but never heard of it making any one sick.

Is it not likely that Dr. Brown has mistaken a case of paralysis for gelsemium poisoning? (See page 180, Vol. XXXIV.) The symptoms are very much the same. Really, I believe that in his diagnosis of the case under consideration, he gives one symptom that is always present in paralysis, and very rarely, if ever, present in gelsemium poisoning.

Bessemer, Ala.

C. C. PARSONS.

ACRES OF MOUNTAIN LAUREL.

Last season I had the care of 45 colonies of bees here which increased to 52. Mountain laurel is everywhere present, and I presume there was enough in the range of my bees to cover more than 50 acres solid. The bees worked freely on it for two or three weeks in June, at the same time that clover and many other blossoms were at hand. The weather was such that but little honey was secreted in the blossoms, and no surplus was stored in the hives. There was no evidence of poisonous honey, and I do not learn that there ever has been any complaint of poisonous honey here.

The bees gathered some honey from early blossoms and poplar trees; then all at once the weather changed, and but little honey was gathered for several weeks, and the bees did not breed very fast until the sourwood blossomed in July. Then in two or three weeks the bees filled up the hives and 600 sections.

This was my first season here. A good many had told me what fine honey the sourwood was, but I felt somewhat skeptical, having always been used to clover and basswood honey. However, I found it very fine, and, Mr. Editor, if you have missed getting a taste of sourwood honey you have missed a fine treat. I believe it is as good as clover honey, and as fine looking. As it comes in warm weather in July, the comb is very delicate. It is also very light in color.

The fall flow commenced about the first of September, and continued during the month, when a frost put a sudden stop to operations. A large part of this was gathered from Spanish-needles, golden-rod, asters and heart's-ease. There was 900 pounds of this which was quite dark. Part of it was extracted. One of our dealers said he thought it was richer and better than the white honey, and I was willing to have him think so. It seems to give satisfaction, but in some Northern markets it would go begging.

The Southern markets are poor, and it would be difficult

to sell a large amount here. I did not come here to carry on the bee-business, but on account of my health.

On April 19 bees were working lively, and had brood in from five to seven frames, and looked as if they would be ready to swarm in three or four weeks.

J. L. HUBBARD.

Hendersonville, N. C.

A SAMPLE OF HONEY-POISONING (?)

Apropos of poisonous honey which has lately become an interesting subject, I wish to say that our doctor called to see me professionally some time ago, and brought some of the news of the neighborhood.

"I had a case of honey-poisoning on the mountains a few days ago," he said.

As we are surrounded here by thousands of acres of mountain laurel, which is given a bad name by some people, I was interested.

"Yes," he continued, "it was a very bad case. He ate honey for breakfast, and in a couple of hours he showed most pronounced symptoms, violent purging and vomiting. He has gotten over it now, but he is weak."

I am a little acquainted with mountaineers, so I said:

"Doctor, how much did he eat?"

"Something over a pint!"

JIMSON.

[It seems to us that we have now had quite a good deal of experience reported as to poisonous honey. Still, if any one can throw any new light upon the subject, we will be pleased to publish it.—EDITOR.]



The Bee-Industry in Utah.

BY JOHN B. FAOG.

There are very few who know the extent of the bee-industry in Utah. Although it is carried on nearly all over the State, still there is not over one-fourth the honey produced that there should be. I am often asked where I sell my honey, and what I can do with it when I have a good crop. I have kept bees for 16 or 17 years, and have had honey to sell most of the time, and have not had too much. I would like to be troubled that way for once. We cannot expect to get a dollar for the same amount of honey that we could 15 years ago, neither can we get the same price for a great deal of other produce.

There is plenty of room for bee-keepers yet, for in a State like ours, where we irrigate, we are sure of a crop of honey if the farmer raises anything, and it will get better for some time to come, for every year large areas of new land are brought under cultivation, and many thousands of trees are set out every year, which helps the honey crop. We have not given the attention to bee-culture that it should have. Many of our wives and daughters might try the bee-business and make a good living out of it, if they felt so disposed, for with our improved methods of keeping bees, and movable-frame hives and bee-escapes, they could look after a few colonies, and they would find as much profit in them as they do in poultry or cows, and bees do not take as much work and attention.

If I were starting in the bee-business again, I would try to commence right. I would adopt some standard hive, and stay with it until I found something better. I would work for comb honey, for the most of it, and would only extract for the home market, or as much as I thought I could sell.

The greatest secret about bee-keeping is to keep your colonies strong; watch them in the spring, and don't let them die for the want of a little attention. Sometimes you can help a dwindling colony by taking them in time and giving them a little assistance from other colonies.

Don't try to increase too fast, and don't think that because you see queens advertised as such wonderful breeders, there are not just as good at home; and sometimes you will

find them better. Where a person has 20 or 30 colonies, there must be as much difference as there is in that many cows in regard to profit. You would raise your best calves, so you must rear your queens from your best colonies.

I am not afraid of producing too much honey, if we get it in the right shape, and of good quality, for we can find a market for a good article. Utah should export several million pounds annually, and we shall do it yet, and in the near future, I believe.

I believe in dividing rather than natural swarming, for I am not always there to watch them at the proper time, and before I am around they may be gone, although I have had some swarms come out and stay, and I always catch them if I can, and they do well as a general thing.

If any are contemplating starting to keep bees for a business, I would advise them to select some good location, and not get too near large apiaries, but get plenty of room, for bees are like sheep—the more pasture they have the larger will be the profit. If the pasture is short, there will not be much profit in keeping bees. Some times you can get a fair crop from 100 colonies, where if you had 200 colonies there would be no surplus.

I think we should have about 100 colonies at our Agricultural College for the students to play with. I think some of the students would be interested in them, and gain much information, and I don't think it would be all loss, either.

In regard to laws for the protection of bee-keepers, we should have them as simple as possible, and be made effective. I do not think any one should "kick" if their bees have foul brood to have them inspected, and a remedy prescribed for it, if it is no other than to destroy them, and in very bad cases that would be the cheapest in the long run. I know that most bee-men will see to it that they will not have diseased bees, for they know there is no money in them.

I don't care how much people spray, so that they do not spray while the trees are in bloom. I want to say one thing, and that is, I do not believe that any one ever got any benefit whatever, but it was in the opposite direction. In Utah they wear out the material used, and their time, and washed the pollen from their trees if they sprayed while the trees were in full bloom, and lost fruit by the operation.

I congratulate the bee-keepers on their success in the past, and the prospect for the future, for I think they are right, and they will yet be classed among the great producers of the State. Utah honey is very little known in the East, but what is known is that our honey compares very favorably with any that is produced in the country.

To be on the safe side, I would advise every bee-keeper to have a label or a stamp with his name and address, for you will find that good quality and neat packages will advertise you, and if you follow this plan, the market will seek you instead of you having to seek the market.

East Mill Creek, Utah.

Honey as Food and Medicine.—A new and revised edition of this 32-page pamphlet is now issued. It has 5 blank pages on which to write or paste recipes taken from other sources. It is just what its name indicates, and should be liberally distributed among the people everywhere to create a demand for honey. It contains a number of recipes on the use of honey as food and as medicine, besides much other interesting and valuable information. Prices, postpaid, are: Single copy, 5 cts.; 10 copies 30 cts.; 50 for \$1.00; 100 for \$1.75. Better give them a trial. Send all orders to the Bee Journal office.

Only One Cent a Copy for copies of the American Bee Journal before April 1, 1896. We have them running back for about 10 years. But you must let us select them, as we cannot furnish them in regular order, and probably not any particular copies. Just send us as many one-cent stamps as you may want old copies, and we will mail them to you.

Questions AND Answers

CONDUCTED BY

DR. C. C. MILLER, MARENGO, ILL.

[Questions may be mailed to the Bee Journal, or to Dr. Miller direct.]

Rearing Queens from 3-Days-Old Larvæ.

After putting a comb of sealed brood and eggs in a hive to rear a queen, how long will the eggs remain for them to rear a queen from? Can they rear a queen from the eggs after six days, allowing the eggs to be three days old when put into the hive? J. M.

ANSWER.—No, if you put in eggs already three days old, six days later, or nine days from the time the eggs were laid, no queen can be reared from them, for in nine days from the time the eggs were laid the larvæ ought to be sealed over. To rear a good queen the larvæ ought not to be more than 3 days old—that is, six days from the time of laying the eggs. During the first three days of its existence, a larva intended for a worker is fed the same as if intended for a queen. After that time the food of the worker is changed, less concentrated, and not so fully digested, while to the queen is continued the same food it first had. To the queen, food is given so lavishly that jelly half the size of a pea is left in the cell after the queen emerges while no such wasteful feeding occurs with workers. Their rations are carefully measured out so that they have just enough to supply their wants, and not a fraction more. If to a queenless colony be given a larva four or five days old, that is, seven or eight days from the laying of the egg, the bees will rear a queen from it, but it will be a very poor queen.

Trying to Keep Down Increase.

I thought I would keep down the increase of my colonies this year, in this manner: When the first swarm came out I gave them three frames of brood from the mother hive. The next day two swarms coming out were given the seven remaining frames, after all queen-cells had been destroyed. I thought this would work nicely, plenty of empty frames for the bees to work out their swarming-fever, and three frames of brood to keep them strong. But it did not turn out as I expected; one swarmed out in four days, and another on the seventh day. In one case I would find no queen-cells; in the other four just started, none sealed. Is this what I should have expected, or is it unusual?

I thought I had hit on a good idea, but the bees did not seem to think so. F. T. B.

ANSWER.—Perhaps the occurrence cannot be said to be anything more than might be expected. Suppose a colony on eight frames should send out a swarm and you have it and give it back its eight frames. You would expect nothing else than that it would swarm again. If you gave it no frames it would not swarm. Now, somewhere between no frames and eight frames if suppose the bees draw a line and say, "If you give us more than this number of frames of brood we'll swarm again;" and very likely that line may be between one frame and two frames. In other words, if you give a swarm more than one frame of brood they'll swarm out again. In some cases they might stay content if only half their frames of brood were replaced with empty frames, there being no fixed rule about it.

Dividing a Colony—Dark Pollen.

I received two 3-frame nuclei May 8. When they arrived one was a great deal better than the other—it contained two full frames of brood, and some in the other, and they have increased so rapidly that they are now a monstrous colony, and I want to divide about June 15.

1. Now, as I am going to divide them, will it pay me better to order a queen, or divide and let the old colony rear one for themselves?

2. Would you advise me to divide the brood as nearly as

possible, or take say three frames of brood and leave the rest?

3. When I divide and take the frames of brood out, and put three frames of foundation in the old hive, would you put the three side by side, or one of foundation then one of the combs of brood, and so on?

4. What kind of a plant is it my bees are getting black, or a terribly dark-green, pollen from, between the hours of 4 and 7 in the afternoon; they carry bright yellow all the rest of the day. H. W. S.

Baraboo, Wis.

ANSWERS.—1. That depends somewhat upon circumstances. If your time is valuable, or if you have little time to work with bees, or if you are anxious to have them build up rapidly, better buy a queen. If you are anxious to increase your practical knowledge of bee-keeping as much as possible, rear your own queen.

2. Again that depends. If you want to have one colony store as much honey as possible, and only care to have the other build up into a good colony for winter, then take three frames of brood with adhering bees for the new colony, leaving the remainder with the queen on the old stand. If you want to have the two colonies more nearly alike, take one more than half the frames of brood for the new colony, or possibly two more than half. The old colony on the old stand will have the advantage of retaining the larger force of bees.

3. With a strong colony and honey yielding well, it doesn't make a great deal of difference about the arrangement of the frames. If the colony is not strong it will be better to have the brood all together. Less danger of chilling brood in that way, and if a frame of foundation is between two frames of brood when little honey is coming in, the tendency is to make the cells of the old combs deeper, and leave the cells of the new combs shallow.

4. I don't know. The blackest pollen I ever saw was from poppies, but poppies were hardly in bloom to any extent June 1. Red clover yields dark-green pollen, but that again would hardly be worked on by the bees so early.

Early Swarming—Remedy for Moth-Worms.

1. My colony of bees that were swarmed March 31, 1896, sent out a new swarm last Thursday (May 14). Is this not something unusual, to send out a swarm so soon? Some one may say that it was the swarm of March 31 leaving, but not so, for there is a strong working force yet. The box that they were housed in is, in the clear, 23x10x11½ inches, and, from its weight, seems to be full of honey. The last swarm hied away to the woods. There are large quantities of mesquite and horsemint (both fine nectar-producing plants) now in bloom.

2. I enclose the following clipping from a Beeville, Tex., paper—is the suggestion practical?

"Hives of black bees can be saved from the ravages of the moth-worm by scattering salt over the floor of the hive. It is there the moth lays her eggs which hatch out young worms, that as soon as they are able to crawl go up into the cells where the young bees are and eat them out. The worms grow rapidly, and soon destroy a colony of bees. I tried it on some of our bees last year, and they are all doing well, but those that were not so treated are all gone.—ESTELLA."

Mathias, Tex.

Mrs. M. M. D.

ANSWERS.—1. Yes, it would be called a very remarkable case in some places, but in others not so very unusual.

2. It may be that colonies in hives treated with salt lived while those left without treatment died, but that does not make it certain that the salt had anything to do with it. I've known hundreds of colonies to live all right without salt, and if a weak, queenless colony of black bees should have salt an inch deep on its floor-board, I should be afraid the combs would fall a prey to the wax-worms. Neither do all the worms that are found in combs climb up from the floor-board. Take a hive of combs left by a colony that died in early spring, and set it on a slab of solid salt and when warm weather comes if you don't find worms hatching out from eggs in the combs, I shall be very much surprised.

A New Binder for holding a year's numbers of the American Bee Journal, we propose to mail, postpaid, to every subscriber who sends us 15 cents. It is called "The Wood Binder," is patented, and is an entirely new and very simple arrangement. Full printed directions accompany each Binder. Every reader should get it, and preserve the copies of the Bee Journal as fast as they are received. They are invaluable for reference, and at the low price of the Binder you can afford to get it yearly.

OLDEST BEE PAPER IN AMERICA ESTABLISHED IN 1881

THE AMERICAN BEE JOURNAL

PUBLISHED WEEKLY BY
GEORGE W. YORK & COMPANY,

118 Michigan St., CHICAGO, ILL.

REGULAR CONTRIBUTORS :

G. M. Doolittle, of New York. Prof. A. J. Cook, of California.
Dr. C. C. Miller, of Illinois. Dr. J. P. H. Brown, of Georgia.
J. H. Martin, of California. Rev. E. T. Abbott, of Missouri.
Barnett Taylor, of Minnesota. Mrs. L. C. Axtell, of Illinois.
Chas. Dadant & Son, of Illinois.

\$1.00 a Year—Sample Copy Sent Free.

[Entered at the Post-Office at Chicago as Second-Class Mail-Matter.]

Vol. XXXVI. CHICAGO, ILL., JUNE 11, 1896. No. 24.



Dark Honey—either comb or extracted—can scarcely be sold at any price in the Chicago market. Don't ship it, expecting to get very much for it. Better forward a sample first, and get a quotation for it before sending a whole shipment. If at all possible dispose of all dark grades of honey in the home market. Only the tempting white honey is sought for in city markets, and brings the best price.

Don't Make a Mistake this year, and send your honey to some unreliable city commission firm. Better take two or three cents a pound less for your honey than to ship it any great distance to market, and run the risk of leakage, breakage, and paying high commissions. Supply the home demand first, by all means, and make some effort to enlarge it. Many families do not know how healthful honey is, and need only to be assured of the fact, when they will become regular users of it.

The North American at Lincoln.—The Secretary of the North American Bee-Keepers' Association informs us that the Executive Committee, after conferring with the Nebraska bee-keepers, have decided that the next meeting of the Association will be held at Lincoln, Nebr. The time for the meeting will be made known as soon as arrangements for reduced railroad rates have been completed.

We are glad the matter has now been definitely settled. We presume the Nebraska friends are happy. 'Tis all right. It will be a good meeting. And the hospitality will be of the finest. We saw it published somewhere that all who attend from outside of the State of Nebraska will be entertained free during the convention. That's too generous, altogether, and we fear somebody will regret having made that offer. But it's good enough for those too-open-hearted Nebraska bee-keepers. Perhaps next time they'll favor going with the Grand Army. At any rate, we hope that just as many as possible living outside of that State will go, for we don't know of a better way to "get even" with them than for about 500 good-sized bee-keepers, with well-developed appetites, to be present at the convention, and take in just as much as possible of the hospitality and sights.

Present Prospects for Honey seem to be very good in many localities. In the last issue of Farm, Stock and Home, Mr. B. Taylor, of Forestville, Minn., has this encouraging paragraph :

Rain, rain, rain has been the word here for weeks, and Mother Earth is again full to overflowing. The honey-plants are just blooming everywhere, and the bees are in the best condition we ever had a like number at this season. We expect a big honey crop, and are getting everything in prime order so there may be no loss from neglect.

Loss from neglect! Who'd be guilty of that after so many poor seasons? What a pity it would be, if a good crop were at hand, and the bee-keepers had neglected to make full preparation for harvesting it! Oh, no; every one will have his "dish right side up" this year. Just let the "honey-shower" come on.

In Mailing Queens, says the Bee-Keepers' Review, it is important that the right number of bees of the proper age be put into the cage. Willie Atchley says that in a small cage in summer weather, six are sufficient. In a large cage, eight or nine are enough. In the fall and spring he would put in twice that number. Don't pick out the large, old bees that are filled with honey. When confined in the cage they have no opportunity to clear themselves, and do not live long. He would use thrifty young bees that are old enough to have been once filled with honey. Select bees that are slim and gaunt. Such are empty and cannot fill themselves with the candy sufficiently to injure themselves. Never put in a bee that has stung you, as it will soon die, and is quite likely to get stuck fast in the entrance to the food chamber.

Carelessness is found among bee-keepers as well as elsewhere. We have just received a letter from "Alexander," with no State or even name and address of the writer given. Of course we can do nothing with it until we get another letter from the same writer, who will likely "kick" because we do not reply to his former letter, when we have no means of knowing who the man is, or in what State he lives. Be careful *always* to sign your name to a letter, and also give your address in full.

No Slipshod Work, or lack of careful work, will go in these days of close competition. Did you, last year, put your comb honey on the market without scraping well every section? If so, don't be guilty of such carelessness or laziness again. Attractiveness is almost everything in comb honey. No neat and tidy housekeeper wants to buy honey in a section that is covered with propolis, or that is otherwise dingy and coarse in appearance. It will pay to put only the neatest and nicest sections of honey on the market.

Past and Present of Bee-Keeping.—On page 163, Mr. G. M. Doolittle has an article on this subject. Editor Holtermann, of the Canadian Bee Journal, copied the article entire in his May number, and made the following editorial comments thereon :

If our readers will study that article first, they will better understand what we are about to say. Mr. Doolittle wants to know if the depreciation in price is not due to over-production. In reply to that first question we would say that when some of our best bee-keepers say they would sooner produce a pound of honey than a pound of pork (and pork is quoted at present at \$4.75 per hundred), we can hardly say that there is over-production. One of the essential characteristics of over-production, in our estimation, is having to produce an article and sell it so as not to leave a living profit. We find cases in which people have sold honey at very low figures, but that does not necessarily prove over-production. It may show that the man has not found the best way of marketing his honey, or that owing to carelessness or ignorance, or disadvantage of locality or season, he has produced an inferior

article. Again, without being justified in using the term over-production, there is in almost every business "the survival of the fittest," and in that management and locality plays an important part.

What has brought diminished prices to-day is the fact that \$1.00 will go further to-day than it would in 1874. Take that very American Bee Journal—in those days it cost, monthly, \$1.00 or \$2.00, where to-day you can get it weekly for \$1.00. You can get a much better suit of clothes for \$10.00 to-day than you could in 1874; bee-supplies are less, and so on. Again, every one admits there was big money in bee-keeping in those days. Those who engage in a new business at that stage say it is a reward for shrewdness and quickness to perceive an opening for business. The same man, if another man engages in the business, and he is the buyer, calls it "highway robbery prices," and so on, but as more engage in it, prices come down to something like a living profit.

As a study was made of bee-keeping, increase was kept down, comb foundation was used more freely, the value of shade and ventilation was, by some at least, known; we were able to produce for much less money, and yet make the same profit. As men learned better methods of wintering, and were more certain to bring their bees out strong in the spring they could produce for less money. These are only directions in which every business must go without arriving at the stage of over-production.

But there is still another point to which we must draw attention: Can we say that we have over-production before we have developed and cultivated our markets to the fullest extent? We think not. Bee-keepers have gone on, and on, producing, yet they have made little or no efforts to increase the demand for honey. Here and there, true, an individual has made the effort, but he has become discouraged through lack of assistance from those who benefit as much as himself. He has done it without remuneration beyond what all other bee-keepers would receive through his efforts, and the necessity of winning bread for himself has prevented continuing that work.

United States bee-keepers could well combine, and engage the services of not one man, but several men, whose duty it would be through press and tongue to put the advantages to be derived from the use of honey before the public. We know of extensive manufacturers who guard the fact they use honey in the preparation of their products as a trade secret, and they will, and have been known to, purchase no more from those who mentioned the fact to rival manufacturers to secure further trade. Amongst such men are confectioners, bakers, vinegar makers, liquor and beverage manufacturers, tobaccoists, and makers of printers' rollers. Here is a vast field to work on, as yet almost untouched.

Again, few are using as a table article honey—one of the most wholesome and pleasant of foods. The people could be educated and induced to use 1,000 pounds where they use one to-day. This can be done by judicious items constantly supplied to the press; it is a case of "keeping everlastingly at it brings success." Keep honey before the people, in the paper, in the stores, and at the table, and success is as certain as it is sure that daylight follows darkness.

We have before spoken of educating and inducing the public to use honey. Honey at present prices is an economic and valuable food—one which has a right to appear on the poor man's table, but during and since the days of ancient history it has been looked upon in the light which honey is, will suffer very much from the suspicion of adulteration. Much of that suspicion is unjust; it is in part owing to the finish and perfection of comb and extracted honey, the quantity produced, and ignorance about bee-keeping, that the idea is gaining ground. We can get nothing more powerful and quicker in action in returning confidence than Legislatures making adulteration a severe offence. A copy of such an Act upon the package, to spread the fact abroad that such an Act exists, will give confidence as nothing else can; and if needed, will apply the bluster which will correct any evil tendency.

No, Mr. Doolittle, we do not think any one is justified in throwing the blame on over-production. Take action, or get your Government to take action, along the above lines, and bee-keeping will have a new era of prosperity. Let the development of markets go hand in hand with the development of bee-keeping.

R. F. HOLTERMANN.

□ **The McEvoy Foul Brood Treatment** is given in Dr. Howard's pamphlet on "Foul Brood; Its Natural History and Rational Treatment." It is the latest publication on the subject, and should be in the hands of every bee-keeper. Price, 25 cents; or clubbed with the Bee Journal for one year—both for \$1.10.

PERSONAL MENTION.

MR. B. TAYLOR, of Forestville, Minn., is very sick. So reported his son, Jewell Taylor, on June 1. We trust he may soon recover, as he has under way some interesting experiments that he had hoped would decide some important apicultural questions.

DR. C. C. MILLER, of Marengo, Ill., called on us for an hour on Tuesday, June 2, when on his way home from the Presbyterian Assembly which had just closed its meeting at Saratoga Springs, N. Y. The Doctor was feeling well, and ready to pitch into the neglected bee-work, as soon as he should reach home.

MR. THOS. PIERREPONT, of Rochester, N. Y., wrote us on Dec. 30, 1895: "I consider the American Bee Journal the best bee-paper in the world; one reason being that it is all bees."

MR. VERNON BURT, of Mallett Creek, O., was "pictured" in last Gleanings. He has about 250 colonies of bees, and bears the unusual "distinction of securing a crop of honey every year." Yet, he's too modest to come out and tell how he does it. Editor Root says, "although he's within a year of 40, he has not yet taken unto himself a wife." Also, that he feels sorry for Mr. Burt, "and for the nice girl that—that—well, ought to have him." There's a chance for Rambler to get some sympathy!

MRS. B. J. LIVINGSTON, of Center Chain, Minn., wrote us as follows, May 30:

I send you to-day a sprig of basswood, showing the advanced state of buds, considering the date, also the "promise of plenty." From July 1 to the 10 is the usual time of blossoming in southern Minnesota. I am glad to say the bees are doing well. I am sorry to say it is on mustard.

MRS. LIVINGSTON.

The sprig of basswood was duly received. It is the same way in this locality—being two weeks or more in advance of ordinary years.

MR. PAUL WHITEBREAD, of Hobbie, Pa., said recently: "I have all of my 1895 copies of the Bee Journal, and would not part with them for a five-dollar bill. The index in the last number for December is as well put up as I ever saw anything of its kind. I am very much pleased with the Bee Journal, and trust it may live long."

SECRETARY DR. A. B. MASON, of the North American, has been accidentally trying the bee-sting remedy for rheumatism, and in a letter dated June 1, wrote as follows:

"For nearly a week previous to last Wednesday, nearly all the pain I suffered was in my instep. On that day I was sitting in a neighbor's apiary (he has my bees on shares this season) to watch for swarms while he was absent. As a swarm was issuing I hobbled along to secure the queen. I put my "game" (lame) foot, on which I had a black sock and a low slipper, close to the entrance of an adjoining hive. In a jiffy three or four bees had given my painful instep as many hypodermic injections. On the instant I thought of what some one had recently said about his sciatica and bee-stings, and I let the stingers alone until I had secured the queen. I was almost immediately relieved of the pain in my instep, and in a few minutes I could stamp my foot quite firmly on the ground without pain, which I had not been able to do before for several weeks. Last night, pain in the same instep was a little annoying, and if it doesn't behave itself in good style in the future, more bees will have to be sacrificed for 'suffering humanity.'"

We hope the Doctor will let the bees "keep at him" until they have effected a complete cure.

General Items.

Clover Seems to Have No Nectar.

So far my bees have not commenced to store any honey. There is but little clover, and what there is seems to have no nectar in it, owing, I think, to the wet weather. MATHILDA CANDLER. Cassville, Wis., May 25.

Wintered All Right.

Bees wintered all right in the cellar, and were in good condition this spring. The flowers have been badly whipped to pieces by rain and wind. No swarms yet, but they will all swarm as soon as we have settled weather. J. V. B. HERRICK. Champlin, Minn., May 25.

Severe Spring for Bees.

We are having a late spring, and it has been rather severe on bees. There seems to have been some loss in the spring through not being a sufficient amount of August and September bees to live through. It would have been all right if the spring had been a nice one. GEO. E. DUDLEY. Provo, Utah, May 24.

A Hopeful California Bee-Keeper.

The prospect for a large crop of honey is not good, as I am feeding my bees at this time. The weather has been cold and windy, and bees have stored very little honey this month—not half as much as they have consumed; but we are yet hopeful that the weather will change soon, and bees will go to work again. JOHN YEARGIN. Fresno, Calif., May 21.

Have Not Swarmed in 8 Years.

My bees are doing first-rate. They came through the winter all right, but there is one thing that I cannot account for, and that is, my bees have not swarmed in eight years, neither have I divided any. I have two places where I keep bees, about 5 miles apart. I use the extractor, and increase my bees by buying them, or getting them out of the woods. C. A. FINGER. Marissa, Ill., May 25.

Basswood the Only Prospect.

Bees wintered well, and the weather is favorable for them. They are strong, with plenty of bees, but they have nothing to do, as there is no white or red clover here this spring—it all dried up last summer. The only prospect for honey is the basswood, which will bloom well, if it does not rain too much. When that comes, we may get a little, if the bees don't swarm too much. I have had no swarms yet, and do not want any, for I have enough bees now, and to spare. M. J. KISTLER. Collingwood, Ind., May 26.

The Gila Farm Apiaries.

The first swarm issued April 28, and a number since. Bees are gathering honey principally from the wild poppy. Windy days have been a great drawback

THE "NOVELTY" POCKET-KNIFE!



Your Name on the Knife.—When ordering, be sure to say just what Name and Address you wish put on the Knife.

The NOVELTY KNIFE is indeed a novelty. The novelty lies in the handle. It is made beautifully of indestructible celluloid, which is as transparent as glass. Underneath the celluloid, on one side of the handle is placed an AMERICAN BEE JOURNAL reminder, and on the other side, name and residence of the Subscriber.

The material entering into this celebrated knife is of the very best quality; the blades are handforged out of the very finest English razor-steel, and we warrant every blade. The holsters are made of German silver, and will never rust or corrode. The rivets are hardened German silver wire; the linings are plate brass; the back springs of Sheffield spring steel, and the finish of handle as described above. It will last a lifetime, with proper usage.

Why purchase the Novelty Knife? In case a good knife is lost, the chances are, the owner will never recover it; but if the Novelty is lost, having name and address of owner, the finder will return it; otherwise to try to destroy the name and address, would destroy the knife. If traveling, and you meet with a serious accident, and are so fortunate as to have one of the Novelties, your pocket KNIFE will serve as an identifier; and in case of death, your relatives will at once be apprised of the accident.

How appropriate this knife is for a Christmas, New Year or birthday present! What more lasting memento could a mother give to a son, a wife to a husband, a sister to a brother, a lady to a gentleman, or vice versa, a son to a mother, a husband to a wife, a brother to a sister or a gentleman to a lady—the knife having the name of the recipient on one side?

The accompanying cut gives a faint idea, but cannot fully convey an exact representation of this beautiful knife, as the "Novelty" must be seen to be appreciated.

How to Get this Valuable Knife.—We send it postpaid, for \$1.00, or give it as a Premium to the one sending us three new Subscribers to the BEE JOURNAL (with \$3.00), and we will also send to each new name a copy of the Premium Edition of the book "Bees and Honey." We club the Novelty Knife with the BEE JOURNAL for one year, both for \$1.90.

Any Name and Address Put on the Knife.

GEORGE W. YORK & CO., CHICAGO, ILLS.

Allow about two weeks for your order to be filled.

PATENT WIRED COMB FOUNDATION

Has No Sag in Brood-Frames

Thin Flat-Bottom Foundation

Has No Fishbone in the Surplus Honey.

Being the cleanest is usually worked the quickest of any Foundation made

J. VAN DEUSEN & SONS, Sole Manufacturers, Sprout Brook Montgomery Co., N. Y.

Mention the American Bee Journal

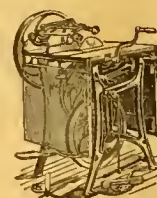

ONE MAN WITH THE UNION COMBINATION SAW

Can do the work of four men using hand tools, in Rippling, Cutting-off, Mitering, Rabbeting, Grooving, Gaining, Dadoing, Edging-up, Jointing Stuff, etc. Full Line of Foot and Hand Power Machinery Sold on Trial. Catalogue Free.

SENECA FALLS MFG. CO., 46 Water St., SENECA FALLS, N. Y. 1A1y Mention the American Bee Journal.

Dadant's Foundation in Chicago!

No other Goods kept here. Send for Price-List,

CHAS. DADANT & SON, 118 Michigan St., CHICAGO, ILL. 13A1f Please mention the Bee Journal.

BEES, QUEENS, and Several Carloads of APIARIAN SUPPLIES always on hand.

Brood Found., 42c lb; Section, 50c lb. I. J. STRINGHAM, 105 Park Place. NEW YORK, N. Y.

That Queen-Clipping Device Free!

Works Like a Charm.

The Monette Queen-Clipping Device WORKS LIKE A CHARM. With it I have clipped 30 queens, all in one day, when examining my bees. WM. STOLLEY, Grand Island, Nebr.

Couldn't Do Without It.

I have clipped 19 queens, and must say the Monette Queen-Clipping Device is by far the best invention ever made, and will be welcome to many bee-keepers as it was to me. I could not do without one now.

DR. GEO. LACKE, Newburgh, Ind.

PLEASE READ THIS OFFER TO PRESENT SUBSCRIBERS:

Send us just one new name for the American Bee Journal a year (with \$1.00), and we will mail you the Queen-Clipping Device FREE of charge. Or, the Queen-Clipping Device will be sent postpaid for 50 cts. But why not get it as a Premium by the above offer? You can't earn 50 cts. any easier. Almost every bee-keeper will want this Device. See page 130 (Feb. 27) for full description of it. Complete directions accompany each one sent out. It is a most ingenious and useful article. Address,

GEORGE W. YORK & CO., 118 Michigan St., Chicago, Ill.

BUY "DIRECT FROM FACTORY," BEST MIXED PAINTS

At **WHOLESALE PRICES**, Delivered **FREE** For Houses, Barns, Roofs, all colors, and **SAVE** Dealers profits. In use 54 years. Endorsed by Grange & Farmers' Alliance. Low prices will surprise you. Write for Samples. O. W. INGERSOLL, 289 Plymouth St., Brooklyn, N. Y.

12A13 *Mention the American Bee Journal.*

WARRANTED GOLDEN

ITALIAN QUEENS By return mail; bred from a Breeder tested by Doollittle out of 1,000 Queens for his own use, and valued at \$50. Queens, 50c; 6 for \$2.75; or \$5.00 per dozen.

Leather Colored Queens from Root's best imported stock same price. Bees from my Queens are excellent workers on red clover. I guarantee safe delivery. N. B.—I sent more than 200 Queens safely to California last season. **H. G. QUIRIN, Bellevue, Ohio.**

23A16 *Mention the American Bee Journal.*

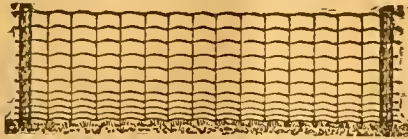

A MODEL TESTIMONIAL

It comes to us this 18th day of May, 1896, from one of the most prosperous railways, the Lake Shore and Michigan Southern. They have hundreds of miles in use, but spend no time in praising it. Simply order 75 3-8 miles shipped at once, to nine points in four states.

Actions speak louder than words. Next! **PAGE WOVEN WIRE FENCE CO., Adrian, Mich.**

WHEN ANSWERING THIS ADVERTISEMENT, MENTION THIS JOURNAL.

A New Method

of refining wax without acid.

Result Better

Comb Foundation.

My prices are also the lowest.

A Job-Lot of No. 2

Polished Sections

Equal in finish to any No. 1's. 1 M. \$1.75; 2 M \$3.40; 3 M, \$4.80; 5 M, \$7.50. Or I can furnish a cheaper quality. Also, a full line of

HIGGINSVILLE SUPPLIES.

See my List with prices.

W. J. FINCH, Jr., SPRINGFIELD ILLS.

IF YOU WANT THE

BEE-BOOK

That covers the whole Apicultural Field more completely than any other published, send \$1.25 to Prof. A. J. Cook, Claremont, Calif., for his

Bee-Keeper's Guide.

Liberal Discounts to the Trade.

California

If you care to know of its Fruits, Flowers Climate or Resources, send for a Sample Copy of California's Favorite Paper—

The Pacific Rural Press

The leading Horticultural and Agricultural paper of the Pacific Coast. Published weekly, handsomely illustrated, \$2.00 per annum. Sample Copy Free.

PACIFIC RURAL PRESS,

220 Market St., - SAN FRANCISCO, CAL.

TEXAS QUEENS.

If you are in need of Queens, let me have your order. Price-List Free.

8A26t **J. D. GIVENS, Lisbon, Tex.**

Mention the American Bee Journal.

up to date, since the season opened. We had a light frost last week. Alfalfa and other vegetation is very backward. One case of bee-paralysis was discovered last week. Alfalfa does not secrete honey until it is in bloom about ten days, when, by that time, a great deal of it is cut for hay, then the chances for honey are gone. Prospects for a good season are encouraging. March and April were the hardest months on the bees in this locality. **SIGEL BRAUTIGAM.**
Cliff, New Mex., May 18.

Rolling in the Sweets.

What bees are kept here are just rolling in the sweets. **S. H. CLARK.**
Elwood, Iowa, June 4.

Just Rolled in the Honey.

Bees have just rolled in the honey in this section this season, and we have white clover, basswood, sourwood, and the fall flowers yet to hear from; and the best part of all—the bees are not swarming—too busy, I reckon.

I don't think it economy for any bee-keeper to do without the American Bee Journal, for I have tried it six months. **M. D. ANDES.**

Bristol, Tenn., June 4.

Bountiful Crops Expected.

We have had no crops for two years here, but the prospects are now for a bountiful crop this year. We have had more rain already this spring than we have had since 1891. Bees wintered well, coming through without loss. In the spring of 1895 we had a dust and snow storm that drowned all but one colony, which I divided July 4, and made three out of it; two swarms came to me, so I have five to commence with this year. I winter them on the summer stands, boxed up and packed with chaff, facing the east. **J. A. HOGG.**

Shelton, Nebr., May 23.

Bright Prospects.

Everything looks bright for a good honey season, but I would have to throw up my hand without the American Bee Journal. **HENRY R. ELSMLIE.**
Richmond Hill, N. Y., May 26.

Bees Poorly Cared For.

Last winter and the early spring months of this year were very bad for bees about the country near here, judging by the number of colonies that died. I have been to several apiaries within six miles of here, and have talked with several bee-keepers whose apiaries I have not visited, and all have lost—some only a few, others all, and at one apiary that I visited 13 colonies had died out of 18. In this last apiary, the colonies were left on the summer stands in single-walled hives, and the only protection (?) was a 25 or 30 pound stone right on top of the 1/4-inch cover; 2 or 3 colonies had been in double-walled hives and packed with leaves, so the owner said, but there were about enough leaves in the whole hive to pack one side. One hive had the entrance-blocks contracted so that only about 1 1/2 inches of an entrance remained for the bees. The dead bees in this hive had blocked up the

❖ MONEY SAVED IS MONEY GAINED. ❖

THE ROYAL UNION Life Insurance Company
DES MOINES, IOWA.

The Iowa Policy

Is one that definitely promises to keep an accurate account with you; credit your premiums and interest, charge the actual expense and mortality cost, and hold the remaining funds subject to your order. **Agents Wanted.**

JOHN B. KING, GENERAL AGENT,
Suite 513 First Nat'l Bank Bld'g,
20A1f **CHICAGO, ILL.**
Mention the American Bee Journal.

The Patent Wood-Veneer Foundation.

Bee-keepers should give it a test, and my All-Wax Foundation. I will guarantee there is no better made, as six years ago I discarded the old way of dipping for wax sheets, and a new invention of my own was discovered, which enables me to make the toughest kind of Foundation; also, no acid used to purify the Beeswax, and it preserves the smell of honey, which is more acceptable to the bees. Now is the time to send wax and have it worked up at low prices. Send for Samples and Catalog with low prices. Wax wanted at 31c cash, or 33c trade, delivered.

AUG. WEISS, Hortonville, Wis.
12A13t *Please mention the Bee Journal.*

1,000 Teachers' Oxford Bibles

Were bought for spot cash by a Chicago firm from an Eastern publisher who was about to be driven to the wall for the want of ready money. More than a million of these same Bibles, in every way like the illustration, have been sold during the past few years at three times the money we ask for them.

They are the genuine Teachers' Oxford Bibles, Divinity Circuit, round corners, gilt edges, complete teachers' helps, maps, 1,350 pages, bound in French seal, limp, with perfectly flexible backs. Sent prepaid.

Regular price, \$4.50; our price, \$2.25. Or we club it with the Bee Journal for one year—both for only \$2.75; or we will give this fine Bible free as a premium to any one sending 4 new subscribers to the Bee Journal one year (with \$4.00). No additional premium is given the new subscribers—simply the Bee Journal one year to each of them.

GEORGE W. YORK & CO.,
- CHICAGO, ILLS.

BEGINNERS.

Beginners should have a copy of the Amateur Bee-Keeper, a 70-page book by Prof. J. W. Rouse. Price 25 cents; if sent by mail, 28c. The little book and the Progressive Bee-Keeper (a live, progressive 28-page monthly journal) one year, 65c. Address any first-class dealer, or

LEAHY MFG. CO., Higginsville, Mo.

For Sale HOME, APIARY, —QUEENS.—

1/2 Block of ground, some fruit, good 6-room dwelling, shop, stable, honey-house and poultry-house (over 3,000 square feet of floor), 100 colonies of bees in chaff hives and fully equipped for comb honey, all in town of 1000 population and good alfalfa range and good water. Price, \$5,000. If unsold June 15th, will unqueen, and offer 2 year clipped queens at 25c.; 1 year, unclipped, at 50c. each. July 15th and after, young queens at 60c. each—all Italian and safe arrival guaranteed. This is a rare bargain, but I must get my wife to a lower altitude. Book your orders at once if you want these queens.

19A1f **R. C. AIKIN, Loveland, Colo.**
WHEN ANSWERING THIS ADVERTISEMENT, MENTION THIS JOURNAL.

Honey-Clovers & Buckwheat SEED FOR SALE.

We have made arrangements so that we can furnish seed of several of the Clovers and Japanese Buckwheat, by freight or express, at the following prices, cash with order:

	5lb	10lb	25lb	50lb
Alsike Clover	\$.70	\$1.25	\$3.00	\$ 5.75
Sweet Clover75	1.40	3.25	6.00
White Clover	1.25	2.00	4.50	8.00
Alfalfa Clover65	1.10	2.70	5.00
Crimson Clover55	.90	2.00	3.50
Jap. Buckwheat20	.35	.90	1.25

Prices subject to market changes.

Add 25 cents to your order, for cartage, if wanted by freight.

Your orders are solicited.

GEORGE W. YORK & CO.,
CHICAGO, ILLS.

Sweet Clover $\frac{1}{2}$ Canada.

At the following prices:

5 lbs.	10 lbs.	25 lbs.	50 lbs.
\$1.00	\$1.60	\$3.75	\$7.25.

Also a quantity of Motherwort and Catnip seed. Prices on application.

EGGS for Hatching. Buff Leghorns, Indian Games, & Light Brahmans. Choice Birds. A breeder for 30 years. Prices on application

JOHN McARTHUR,
881 Yonge Street, - TORONTO, ONT.
15A1f Mention the American Bee Journal.



Promptness Is What Counts!

Honey-Jars, Shipping-Cases, and everything that bee-keepers use. **Root's Goods at Root's Prices,** and the best shipping point in the country. Dealer in Honey and Beeswax. Catalogue Free.

Walter S. Ponder
162 Mass. Ave.
INDIANAPOLIS, IND.
Mention the American Bee Journal.

Queens for Sale

Italian Queens—after May 15—Untested, 75c. each; 6 for \$4.00; 12 for \$7.20.

Safe arrival and satisfaction guaranteed.

Reference—George W. York & Co. Address,

F. GRABBE,
LIBERTYVILLE, ILL.

Mention the American Bee Journal.

HONEY We have a large amount of Pure No. 1 Alfalfa we will sell cheap.

Wax Wanted.

Boss bee-escape Warranted the best, simplest and quickest Escape on the market. Sent postpaid to any address for 30 cts. It can be returned at our expense if it is not as represented, or we will send the Escape on trial to any bee-keeper wishing to test it in good faith. We are agents for the

Ferguson Patent Hive with double-case Super and Wicket-Gate Honey-Board, with the Escape. It is the easiest, quickest hive to handle for the production of comb honey. Address,

E. S. LOVESY & CO.,
355 6th East St., SALT LAKE CITY, UTAH.
Mention the American Bee Journal. 9A1f

Sections FOUNDATION QUEENS Cheap

Send for prices. **J. F. MICHAEL,**
24A21 GREENVILLE, O.

For Sale Having disposed of most of my Bees, I will sell about 150 Simplicity Combs for extracting, at \$10 per hundred. All in good condition. Would like a few good Queens in exchange for Queen Excluders, standard size. Address,

C. A. MEADE, Brookside, Mich.

READERS Of this Journal who write to any of our advertisers, either in ordering, or asking about the Goods offered, will please state that they saw the Advertisement in this paper.

carried it out where the queen took flight. The bees in the cage might have flown away if they had been disposed, but they stuck to the cage. In a few minutes the queen returned, and lit on the cage, when I caught her again, and this time I carried her to the box.

This is the first time I have tried to handle a queen. After this I think I will be more careful, as I do not believe that queens will always come back to my hands after they have once made their escape.

We are just at the end of more than a week of rainy weather. This is the first sunny day since a week ago last Monday. The prospect is good for a good deal of white clover bloom this season. **EDWIN BEVINS.**

Leon, Iowa, May 21.

Good Honey Crop Promised.

Bees have wintered well in this section, and a good honey crop is promised for this year. **F. G. WILKE.**

Wilcox, Nebr., June 1.

Honey Outlook Not Promising.

The honey outlook here is not promising. One may, however, learn something from a paper like the American Bee Journal in times of failure as well as in times of success. **BRUNO NICKEL.**

Acton, Calif., May 25.

Bees Booming.

Bees are just booming here now. I expect to get over 100 pounds to the colony, spring count. Linden and sourwood, and also sumac, are to bloom yet. I will probably report when the season is over. **A. CARDER.**

Tracy City, Tenn., May 29.

A Successful Season Expected.

Bees have not done anything here for the last two years. I have 20 colonies, wintered the best that I ever had any in the cellar, with empty supers on the hive, and only a board cover over them. They are booming now, having just begun to work on white clover. I am looking for better success this year.

List of Honey and Beeswax Dealers.

Most of whom Quote in this Journal.

Chicago, Ills.

R. A. BURNETT & Co., 163 South Water Street.

New York, N. Y.

HILDRETH BROS. & SEGELKEN,
120 & 122 West Broadway.
CHAS. ISRAEL & BROS., 486 Canal St.

Kansas City, Mo.

C. C. CLEMOMS & Co., 423 Walnut St.

Buffalo, N. Y.

BATTERSON & Co., 167 & 169 Scott St.

Hamilton, Ills.

CHAS. DADANT & SON,

Philadelphia, Pa.

WM. A. SELSER, 10 Vine St.

Cincinnati, Ohio.

C. F. MUTH & SON, cor. Freeman & Central avs.

Toronto Convention Report has been issued in pamphlet form, and will be mailed from the Bee Journal office for 25 cents. Better have a copy, if you have not read it. Only a limited number of copies were bound.



PUBLISHED WEEKLY BY

GEORGE W. YORK & CO.,

At One Dollar a Year,

56 Fifth Avenue, CHICAGO, ILLS.

Postage to all Countries in the Postal Union is 50 cents extra. To all others, \$1.00 more than the subscription price.

Hebblewhite & Co., 369 George Street, Sydney, New South Wales, Australia, are our authorized agents. Subscription price, 6 shillings per annum, postpaid

Important to All Subscribers.

The American Bee Journal is sent to subscribers until an order is received by the publishers for its discontinuance, and all arrearages are paid.

Always State the Post-Office to which your paper is addressed, when writing to us.

A Sample Copy of the Bee Journal will be sent FREE upon application.

How to Send Money.—Remit by Express, Post-Office Money Order, or Bank Draft on New York or Chicago. If none of these can be had, Register your Letter, affixing Stamps both for postage and registry, and take a receipt for it. Money sent thus, IS AT OUR RISK; otherwise it is not. Do not send Checks on Local Banks—we have to pay 25 cents each, to get them cashed.

Never Send Silver in letters. It will wear holes in the envelope, or may be stolen.

Money Orders.—Make all Money Orders payable at Chicago, Ill.—not at any sub-station of Chicago.

Postage Stamps of any denomination may be sent for any fraction of a dollar; or where Money Orders cannot be obtained, stamps for any amount may be sent.

Subscription Credits.—The receipt for money sent us will be given on the address-label of every paper. The subscription is paid to the end of the month indicated.

Do not Write anything for publication on the same sheet of paper with business matters, unless it can be torn apart without interfering with either part of the letter.

Lost Numbers.—We carefully mail the Bee Journal to every subscriber, but should any be lost in the mails, we will replace them if notified before all the edition is exhausted. Please don't wait a month or two, for then it may be too late to get another copy.

Emerson Binders, made especially for the American Bee Journal, are convenient for preserving each weekly Number, as fast as received. They will be sent, postpaid, for 75 cents, or clubbed with the American Bee Journal for one year—both together for \$1.60. They cannot be sent by mail to Canada.

Please Send Us the Names of your neighbors who keep bees, and we will send them sample copies of the BEE JOURNAL. Then please call upon them and get them to subscribe with you, and secure some of the premiums we offer.

Bee-Keeper's Guide—see page 380.

WOVEN WIRE FENCE
 Over 50 Styles The best on Earth. Horse high, Bull strong, Pig and Chicken tight. You can make from 40 to 60 rods per day for from 14 to 22c. a Rod. Illustrated Catalogue Free. KITSELMAN BROS., Ridgeville, - Indiana.

48Etf Mention the American Bee Journal

TWO APIARIES!

500 Nuclei devoted to Queen-Rearing. Prices for May will be as follows: Untested, 75c.; 1/4 doz., \$4.00; Tested, \$1.00. June - Untested, 65c.; 1/4 doz., \$3.60; Tested, 85c. All Queens promptly sent by return mail.

6Etf LEININGER BROS., FT. JENNINGS, OHIO.

Mention the American Bee Journal

I have one of the choicest flocks of BROWN LEGHORNS IN THE STATE

Keep no other kind. Eggs, 75c. per 15; \$1.25 per 30. B. G. SCOTHAN, OTISVILLE, MICH

16Etf Mention the American Bee Journal

ITALIAN BEES.

Untested Queens, \$1.00. Tested, \$1.25. Bees by the lb. \$1.00. Nuclei—Two frame, with Queen, \$2.50; one frame, \$2.00.

Also, Banded and White Plymouth Rock Eggs for setting; \$1.00 for 15.

18E7c Mrs. A. A. SIMPSON, SWARTS, PA.

Mention the American Bee Journal

Up to Guarantee!

On June 1 I shall be prepared to ship Queens of my famous

ADEL STRAIN.

This strain of beautiful yellow-banded Bees is practically non-swarming and non-stinging. Queens, each, \$1.00. Special prices by the dozen. Everything guaranteed. Cat'g free.

18Etf HENRY ALLEY, WENHAM, ESSEX CO., MASS.

Full Colonies of Italian Bees for \$4.00, or particulars see larger ad. on page 350 of this paper. Tested Queens, after June 10th, 75 cts. each; 2 for \$1.25.

Address, T. H. KLOEHL, 426 Willow St., TERRE HAUTE, IND. 23A4t Mention the American Bee Journal.

\$3.00 Worth for \$2.00!

Until further notice, we propose to give you a chance to get some good reading-matter for the long winter evenings, at half price.

Send us \$2.00, and we will mail you your choice of \$3.00 worth of the following booklets, and also credit your subscription to the American Bee Journal for one year:

- Poultry for Market and Profit..... 25c
- Our Poultry Doctor..... 30c
- Turkeys for Market and Profit..... 25c
- Capons and Caponizing..... 30c
- Rural Life..... 25c
- Preparation of Honey for the Market..... 10c
- Bee-Pasturage a Necessity..... 10c
- Hive I Use, by Doolittle..... 5c
- Foul Brood, by Dr. Howard..... 25c
- Foul Brood, by Kohnke..... 25c
- Foul Brood, by Cheshire..... 10c
- Bee-Keeping for Profit, by Dr. Tinker..... 25c
- Kendall's Horse-Book—Eng. or German..... 25c
- Silo and Silage, by Prof. Cook..... 25c
- Hand-Book of Health, by Dr. Foote..... 25c
- Maple Sugar and the Sugar Bush..... 35c
- Potato Culture, by Terry..... 40c
- Carp Culture, by Root & Finney..... 40c
- Strawberry Culture, by Terry & Root..... 40c
- Blenen Kultur, by Newman [German]..... 40c
- Winter Problem in Bee-Keeping [Pierce]..... 50c
- Bee-Keepers' Directory, by Henry Alley..... 50c
- Advanced Bee-Culture, by Hutchinson..... 50c
- 5 Honey as Food and Medicine..... 25c

GEORGE W. YORK & CO., CHICAGO, ILLS.

YOUNG QUEENS BY RETURN MAIL

From the South. Bred from our hardy strain of GRAY CARNIOLANS and GOLDEN ITALIANS. Untested Queen, 75 cts.; Tested, \$1.50. If you want a Fine Imported or a Select Tested Breeding-Queen, or BEES BY THE POUND, Nuclei and Full Colonies, we can furnish you at bottom prices. We never saw Foul Brood or Bee-Paralysis. Satisfaction guaranteed. PRICE-LIST FREE.

F. A. LOCKHART & CO., Lake George, N. Y.

Please mention the American Bee Journal.

16Etf

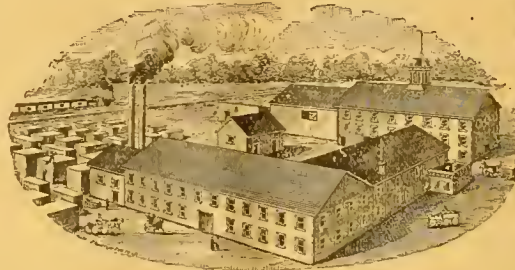

BEE-SUPPLIES!

We have the best equipped Factory in the West. Capacity—one carload a day; and carry the largest stock and greatest variety of every thing needed in the apiary, assuring BEST goods at the LOWEST prices, and prompt shipment.

Illustrated Catalog, 80 pages, Free.

22E8t Address, E. KRETCHMER, Red Oak, Iowa.

Question-Box

In the multitude of counsellors there is safety.—Prov. 11-14.

A Model Foul Brood Law.

Query 17—Please state briefly your idea of the essentials of a model foul brood law.—WISCONSIN.

Eugene Secor—I can't do it.

H. D. Cutting—This space is too short.

W. R. Graham—I have no statement to make.

Mrs. L. Harrison—Let your bee-keeping lawyers answer that.

Emersoo T. Abbott—"Thou shalt love thy neighbor as thyself."

Prof. A. J. Cook—I think the California and Michigan laws good.

J. M. Hambaugh—I have as yet had no experience with foul brood.

Dr. J. P. H. Brown—Too big a question to answer under this head.

G. M. Doolittle—"Do unto others as you would have others do unto you."

C. H. Dibbern—I don't know, as I have had no experience with foul brood.

B. Taylor—I have had no experience with foul brood, and do not know the requirements.

W. G. Larrabee—I will let some one answer this that knows more about such things than I do.

Dr. C. C. Miller—Compulsory report of every case, and compulsory cure or destruction of each case.

R. L. Taylor—If you take the law of Michigan against "yellows" in peaches as a model, you cannot go far wrong.

P. H. Elwood—Inspector to stamp all brood-chambers containing foul brood, and when he finds the same infected another season he is to burn them.

N. E. France—1. A State Inspector, chosen by the State Bee-Keepers' Society, and appointed by the Governor. 2. A foul brood law, much like the Ontario foul brood law. 3. Any bee-keeper in the State having diseased bees, or know-

ing of any diseased, to report to the inspector for instructions. 4. To enforce the law which protects the industry. It is not necessary to destroy by fire, but thorough treatment is needed, and that in proper time.

Rev. M. Mahin—I am not sufficiently posted to comply. I am blissfully ignorant concerning foul brood. There has never been any of it in this part of the country.

G. W. Demaree—We don't want any statutory law on the subject. If men's own interests fail to guard their industries, law will be a failure, except to foster tyranny, and "beastly" interference with individual rights.

Allen Pringle—Our Ontario Foul Brood Act (which I had a hand in drafting) is said to be the best in existence—at any rate, our Foul Brood Inspector says it is "the best in the world," and that he can "beat the world" in curing foul brood under it.

J. E. Pond—Not being familiar with the laws of Wisconsin, I can't give essentials that I should consider of value, except to attach a heavy penalty to willful violation. A commission should form part of such a law, in order that honest ignorance could not be confounded with willfulness.

James A. Stone—To provide a competent inspector (to be appointed or approved by the bee-keepers' associations) who shall have a salary large enough so that he can be expected to spend all his time if needed. And in addition a fund to be drawn from to pay one-half value of the colonies he may deem best to destroy.

Bee-Keepers' Photograph.

—We have now on hand a limited number of excellent photographs of prominent bee-keepers—a number of pictures on one card. The likeness of 49 of them are shown on one of the photographs, and 121 on the other. We will send them, postpaid, for 50 cents each, mailing from the 121 kind first; then after they are all gone, we will send the 49 kind. So those who order first will get the most "faces" for their money. Send orders to the Bee Journal office.

BEE-BOOKS

SENT POSTPAID BY

George W. York & Co.,
Chicago, Ills.

Bees and Honey, or Management of an Apiary for Pleasure and Profit, by Thomas G. Newman.—This edition has been largely re-written, thoroughly revised, and is "fully up with the times" in all the improvements and inventions in this rapidly-developing pursuit, and presents the apiarist with everything that can aid in the successful management of an apiary, and at the same time produce the most honey in an attractive condition. It contains 250 pages, and 245 illustrations—is beautifully printed in the highest style of the art, and bound in cloth, gold-lettered. Price, \$1.00.

Langstroth on the Honey-Bee, revised by Dadant.—This classic in bee-culture, has been entirely re-written, and is fully illustrated. It treats of everything relating to bees and bee-keeping. No apiarist's library is complete without this standard work by Rev. L. L. Langstroth—the Father of American Bee-Culture. It has 520 pages; bound in cloth. Price, postpaid, \$1.25.

Bee-Keepers' Guide, or Manual of the Apiary, by Prof. A. J. Cook, of the Michigan Agricultural College.—This book is not only instructive and helpful as a guide in bee-keeping, but is interesting and thoroughly practical and scientific. It contains a full delineation of the anatomy and physiology of bees. 460 pages; bound in cloth and fully illustrated. Price, postpaid, \$1.25.

Scientific Queen-Rearing, as Practically Applied, by G. M. Doolittle.—A method by which the very best of Queen-Bees are reared in perfect accord with Nature's way. 176 pages, bound in cloth, and illustrated. Price, \$1.00.

A B C of Bee-Culture, by A. I. Root.—A cyclopaedia of 400 pages, describing everything pertaining to the care of the honey-bees. It contains 300 engravings. It was written especially for beginners. Bound in cloth. Price, \$1.25.

Advanced Bee-Culture, Its Methods and Management, by W. Z. Hutchinson.—The author of this work is too well known to need further description of his book. He is a practical and entertaining writer. You should read his book. 90 pages, bound in paper, and illustrated. Price, 50 cts.

Rational Bee-Keeping, by Dr. John Dzierzon.—This is a translation of his latest German book on bee-culture. It has 350 pages; bound in cloth, \$1.25; in paper covers, \$1.00.

Bienen-Kultur, by Thomas G. Newman.—This is a German translation of the principal portion of the book called BEES OF HONEY. 10, page pamphlet. Price, 40 cents.

Convention Hand-Book, for Bee-Keepers. Thomas G. Newman.—It contains the parliamentary law and rules of order for Bee-Conventions—also Constitution and By-Laws, with subjects for discussion, etc. Cloth, gold-lettered. Price, 25 cts.

Amerikanische Bienenzucht, by Hans Buschbauer.—Printed in German. A hand-book on bee-keeping, giving the methods in use by the best American and German apiarists. Illustrated; 138 pages. Price, \$1.00.

Thirty Years Among the Bees, by Henry Alley.—Gives the results of over a quarter-century's experience in rearing queen-bees. Very latest work of the kind. Nearly 100 pages. Price, 50c.

Why Eat Honey?—This Leaflet is intended for FREE distribution, to create a Local Market. 100 copies, by mail, 40 cts.; 500 for \$1.50; 1000, \$2.50. If 500 or more are ordered at one time, your name and address will be printed on them FREE.

How to Keep Honey and preserve its richness and flavor. Price same as Why Eat Honey.

Apiary Register, by Thos. G. Newman.—Devotes two pages to a colony. Leather binding. Price, for 50 colonies, \$1.00; for 100 colonies, \$1.25.

Preparation of Honey for the Market, including the production and care of comb and extracted honey. A chapter from BEES AND HONEY. Price, 10 cents.

Bee-Pasturage a Necessity.—This book suggests what and how to plan. It is a chapter from BEES AND HONEY. Price, 10 cents.

The Hive I Use, by G. M. Doolittle. It details his management of bees, and methods of producing comb honey. Price, 5 cents.

Dr. Howard's Book on Foul Brood.—Gives the McEvoy Treatment and reviews the experiments of others. Price, 25 cts.

Dictionary of Apiculture, by Prof. John Philo. Gives the correct meaning of nearly 500 apicultural terms. Price, 50 cts.

Winter Problem in Bee-Keeping, by G. R. Pierce. Result of 25 years' experience. 50 cts.

Handling Bees, by Chas. Dadant & Son.—A Chapter from Langstroth Revised. Price, 8 cts.

Bee-Keepers' Directory, by H. Alley.—Latest methods in Queen-Rearing, etc. Price, 50c.

Foul Brood Treatment, by Prof. F. R. Cheshire.—Its Cause and Prevention. Price, 10 cts.

Foul Brood, by A. R. Kohnke.—Origin, Development and Cure. Price, 25 cts.

History of Bee-Associations, and Brief Reports of the first 20 conventions. Price, 15 cts.

Honey as Food and Medicine, by T. G. Newman.—A 32-page pamphlet: just the thing to create a demand for honey at home. Should be scattered freely. Contains recipes for Honey-Cake, Cookies, Puddings, Foam, Wines, and uses of honey for medicine.

Prices, prepaid—Single copy, 5 cts.; 10 copies, 35 cts.; 50 for \$1.50; 100 for \$2.50; 250 for \$5.50; 500 for \$10.00; or 1000 for \$15.00.

When 250 or more are ordered, we will print the bee-keeper's card (free of cost) on the front cover page.

Bee-Keeping for Profit, by Dr. G. L. Tinker.—Revised and enlarged. It details the author's "new system, or how to get the largest yields of comb or extracted honey." 80 p.; illustrated, 25c.

Emerson Hinders, made especially for the BEE JOURNAL, are convenient for preserving each number as fast as received. Not mailable to Canada. Price, 75 cts.

Commercial Calculator, by C. Ropp.—A ready Calculator, Business Arithmetic and Account-Book combined in one. Every farmer and business man should have it. No. 1, bound in water proof leatherette, calf finish. Price, 40 cts. No. 2 in fine artificial leather, with pocket, silette alate, and account-book. Price, 60 cts.

Green's Four Books, by Chas. A. Green.—Devoted to, 1st, How We Made the Old Farm Pay; 2nd, Peach Culture; 3rd, How to Propagate Fruit-Plants, Vines and Trees; 4th, General Fruit Instructor. Nearly 120 pages. Fully illustrated. 25 cts.

Green's Six Books on Fruit-Culture, by Chas. A. Green.—Devoted 1st, to Apple and Pear Culture; 2nd, Plum and Cherry Culture; 3rd, Raspberry and Blackberry Culture; 4th, Grape Culture; 5th, Strawberry Culture. 129 pp.; illustrated. 25 cts.

Garden and Orchard, by Chas. A. Green.—Gives full instructions in Thinning and Marketing Fruits; Pruning, Planting and Cultivating; Spraying, Evaporation, Cold Storage, Etc. 94 pages, illustrated. Price, 25 cts.

Kendall's Horse-Book.—35 pictures, showing positions of sick horses, and treats on all their diseases. English or German. Price, 25 cts.

Silo and Silage, by Prof. A. J. Cook.—It gives the method in operation at the Michigan Agricultural College. Price, 25 cts.

Lumber and Log-Book.—Gives measurements of lumber, logs, planks; wages, etc. 25c.

Maple Sugar and the Sugar Bush, by Prof. A. J. Cook.—Full instructions. Price, 35 cts.

Grain Tables, for casting up the price of grain, produce, hay, etc. Price, 25 cts.

Capons and Caponizing, by Dr. Sawyer, Fanny Field, and others.—Illustrated. All about caponizing fowls, and thus how to make the most money in poultry-raising. 64 pages. Price, 30 cts.

Our Poultry Doctor, or Health in the Poultry Yard and How to Cure Sick Fowls, by Fanny Field.—Everything about Poultry Diseases and their Cure. 64 pages. Price, 30 cts.

Poultry for Market and Poultry for Profit, by Fanny Field.—Tells everything about the Poultry Business. 64 pages. Price, 25 cts.

Turkeys for Market and Turkeys for Profit, by Fanny Field.—All about Turkey-Raising. 64 pages. Price, 25 cts.

Rural Life.—Bees, Poultry, Fruits, Vegetables, and Household Matters. 100 pages. 25 cts.

Strawberry Culture, by T. B. Terry and A. I. Root. For beginners. Price, 40 cts.

Potato Culture, by T. B. Terry.—It tells how to grow them profitably. Price, 40 cts.

Carp Culture, by A. I. Root and Geo. Finley.—Full directions. 70 pages. Price, 40 cts.

Hand-Book of Health, by Dr. Foote.—Hints about eating, drinking, etc. Price, 25 cts.

Alsike Clover Leaflet.—Full directions for growing. 50 for 25 cts.; 100 for 40 cts.; 200, 70c.

can be taken in each case with the Bee Journal a year at the prices named. If more books are wanted see postpaid prices given with the description of the books on this page. Following is the clubbing-list:

1. Langstroth on the Honey-Bee.....\$2.00
2. A B C of Bee-Culture..... 2.00
3. Bee-Keeper's Guide..... 1.75
4. Bees and Honey [Cloth bound]..... 1.65
5. Scientific Queen-Rearing..... 1.75
6. Dr. Howard's Foul Brood Book..... 1.10
7. Advanced Bee-Culture..... 1.30
8. Amerikanische Bienenzucht [Germ.] 1.75
9. Bienen-Kultur [German]..... 1.25
10. Rational Bee-Keeping [Cloth bound] 2.00
11. Rational Bee-Keeping [Paper bound] 1.75
12. Thirty Years Among the Bees..... 1.30
13. Bee-Keeping for Profit..... 1.15
14. Convention Hand-Book..... 1.15
15. Poultry for Market and Profit..... 1.10
16. Turkeys for Market and Profit..... 1.10
17. Capons and Caponizing..... 1.10
18. Our Poultry Doctor..... 1.10
19. Green's Four Books..... 1.15
20. Green's Six Books on Fruit-Culture... 1.15
21. Garden and Orchard..... 1.15
22. Rural Life..... 1.10
23. Emerson Binder for the Bee Journal. 1.60
25. Commercial Calculator, No. 1..... 1.25
26. Commercial Calculator, No. 2..... 1.40
27. Kendall's Horse-Book..... 1.10
29. Strawberry Culture..... 1.20
30. Potato Culture..... 1.20
31. Carp Culture..... 1.20
32. Hand-Book of Health..... 1.10
33. Dictionary of Apiculture..... 1.35
34. Maple Sugar and the Sugar Bush... 1.20
35. Silo and Silage..... 1.10
36. Winter Problem in Bee-Keeping..... 1.30
37. Apiary Register (for 50 colonies).... 1.75
38. Apiary Register (for 100 colonies).... 2.00
39. Bee-Keepers' Directory..... 1.30

Honey & Beeswax Market Quotations.

The following rules for grading honey were adopted by the North American Bee-Keepers' Association, and, so far as possible, quotations, are made according to these rules:

FANCY.—All sections to be well filled; combs straight, of even thickness, and firmly attached to all four sides; both wood and comb unsoiled by travel-stain, or otherwise; all the cells sealed except the row of cells next the wood.

No. 1.—All sections well filled, but combs uneven or crooked, detached at the bottom, or with but few cells unsealed; both wood and comb unsoiled by travel-stain or otherwise.

In addition to this the honey is to be classified according to color, using the terms white, amber and dark. That is, there will be "fancy white," "No. 1 dark," etc.

CHICAGO, ILL., June 6.—We quote: Fancy white, 14@15c.; No. 1, 12@13c.; fancy amber, 9@10c.; No. 1, 8@8½c.; fancy dark, 8@9c.; No. 1, 8c. Extracted, white, 5@7c.; amber, 4@5c.

Beeswax, 27@28c. It continues to sell well and there is no accumulation of shipments. We consider it a good time to sell.

R. A. B. & Co.

PHILADELPHIA, PA., Apr. 22.—We quote: No. 1 white, 9@10c.; fancy amber, 8@9c.; fancy dark, 7@8c. Extracted, white clover, 10c.; amber, 5@5½c.; dark, 4@4½c. Beeswax, 25@26c. Comb honey is dull. Extracted in fair demand. Beeswax lower. W. A. S.

BUFFALO, N. Y., Apr. 20.—We quote: Fancy white, 15@16c.; No. 1 white, 13@14c.; fancy dark, 8@9c.; No. 1 dark, 7@7½c. Beeswax, 25@28c. Trade very dull and honey not moving, except a few fancy lots; anything dark is hard to sell. B. & Co.

CINCINNATI, O., Apr. 22.—There is no fancy white comb honey on our market. Best white sells at 12@14c. in a jobbing way, with a fair demand. Demand is good for extracted at 4@7c., according to quality. Beeswax is in good demand at 25@30c. for good to choice yellow. C. F. M. & S.

KANSAS CITY, Mo., May 20.—We quote: No. 1 white, 13@14c.; No. 1 amber, 10@12c.; No. 1, dark, 8@10c. Extracted, white, 6c.; amber, 5c.; dark, 4c. Beeswax, 22c. C. C. C. & Co.

NEW YORK, N. Y., May 9.—There is some demand for white comb honey at unchanged prices. No market for buckwheat. Extracted remains quiet. New Southern is now arriving and selling at 5@6c. for fine grades and 50@55c. a gallon for fair to common. Beeswax easy at 28@29c. H. B. & S.

Book Clubbing Offers.

(Read Carefully.)

The following clubbing prices include the American Bee Journal one year with each book named. Remember, that only ONE book

Bottom Prices

**BRING US BIG TRADE.
GOOD GOODS KEEP IT.**

If you want the best supplies that can be made at a little less cost than you can buy the same goods for elsewhere, write to us for low prices. 1896 Catalogue now ready—ask for it and a free copy of **The American Bee-Keeper** (36 pages).

Address,
THE W. T. FALCONER MFG. CO.,
JAMESTOWN, N. Y.
Mention the American Bee Journal.

COMB FOUNDATION!

Wax always wanted for Cash or in Exchange for Fdn. or other Supplies. My trade is established on **Low Prices and the merit of my Foundation. Orders filled promptly.**
WORKING WAX INTO FDN. BY THE LB. A SPECIALTY. Wholesale prices to dealers and large consumers. Send for Prices and Samples to—**GUS DITTMER, AUGUSTA, WIS.**
Reference—Augusta Bank. 1Atf
Mention the American Bee Journal.

14 Years' Experience in breeding Italian Queens. **GOOD** Untested Queens, 75c, 3 for \$2.00. **CHOICE** Tested, young, \$1 each by return mail. A. I. Root Co.'s Supplies kept in stock at bottom prices. 36-page Catalog free.
JNO. NEBEL & SON, High Hill, Mo.
Mention the American Bee Journal. 4A26t

I ARISE



TO SAY to the readers of the **BEE JOURNAL** that **DOOLITTLE**

has concluded to sell—**BEEES and QUEENS**—in their season, during 1896, at the following prices:

- One Colony of Italians on 3 Gallup frames, in light shipping-box \$6 00
- Five Colonies..... 25 00
- Ten Colonies..... 45 00
- 1 untested queen. 1 00
- 6 " queens 5 50
- 12 " " 10 00
- 1 tested Queen... \$1 50
- 3 " Queens. 3 50
- 1 select tested queen 2 10
- 3 " Queens 4 00

Select tested queen, previous season's rearing . 4 00
Extra Selected for breeding, the **VERY BEST.** 5 00
About a Pound of **BEEES** in a Two-frame Nucleus, with any Queen, \$2.00 extra.

Circular free, giving full particulars regarding the Bees and each class of Queens.
Address

G. M. DOOLITTLE,
12A25t **BORODINO, Onon. Co., N. Y.**
Mention the American Bee Journal.

BEEES QUEENS
Smokers, Sections, Comb Foundation, And all Apiairan Supplies cheap. Send for FREE catalogue. **E. T. FLANAGAN, Belleville, Ill.**
6A26t Please mention the Bee Journal.

PURE BARRED PLYMOUTH ROCK
Eggs, \$1.25 per 14. Our P. Rocks are very large, with fine plumage. Also.

BLACK MINORCA EGGS,
a non-sitting and great laying breed. Both kinds raised upon our farm. Minorca Cockereels, \$1.00 each. **Mrs. L. C. AXTELL,**
16Atf **ROSEVILLE, Warren Co., ILL.**
Mention the American Bee Journal.

19th Year Dadant's Foundation 19th Year

Is still in the lead, for we use all the latest improvements, including the

NEW WEED PROCESS,

and still make the best goods. Remember that we do not use any acid to purify our beeswax, and that is why our Foundation preserves the smell of the honey and is more acceptable to the bees, than any other. It is kept for sale by

T. H. Strickler, Solomon City, Kansas.
G. K. Hubbard, Fort Wayne, Ind.
L. Hanssen, Davenport, Iowa.
C. Theilmann, Theilmanton, Minn.
E. C. Eaglesfield, Berlin, Wis.
E. T. Abbott, St. Joseph, Mo.
J. M. Jenkins, Wetumpka, Alabama
John Rey, East Saginaw, Mich.
Vickery Bros., Evansville, Ind.

The Jennie Atchley Company, Beeville, Texas.
C. F. Muth & Son, Cincinnati, Ohio
E. Kretschmer, Red Oak, Iowa.
G. B. Lewis Co., Watertown, Wis.
James Reynolds' Elevator Co., Poughkeepsie, N. Y.
Louisiana Bee-Keeper's Supply Manufactory, Donaldsonville, La.
Page & Lyon, New London, Wis.
John Nebel & Son, High Hill, Mo.

and many other Dealers. All agree in saying that no goods are better than ours.

Those of our customers who formerly bought through Thos. G. Newman can get our Foundation in **Chicago, Ill.**, by addressing us at **118 Michigan Street**. We keep no other goods there.

We make a specialty of **Veils and Veil Stuffs** of best quality, cotton and silk.

"LANGSTROTH ON THE HONEY-BEE"—Revised.

Bee-Keeper's Supplies, Smokers, Sections, Tin Pails, etc.
Samples of Foundation and Tulle FREE with Circular. Instructions to beginners with Circular. Send us your address.

CHAS. DADANT & SON,
Mention the American Bee Journal. **HAMILTON, Hancock Co., ILL.**

26c Cash Paid for Beeswax!

For all the **good, pure yellow BEESWAX** delivered to our office till further notice, we will pay 26 cents per pound, cash; or 30 cents for whatever part is exchanged for the American Bee Journal, Books or Seed, that we offer. If you want **cash promptly** for wax, send it on at once. Dark or impure wax not taken at any price. Address plainly,

George W. York & Co., 118 Michigan St., Chicago, Ill.

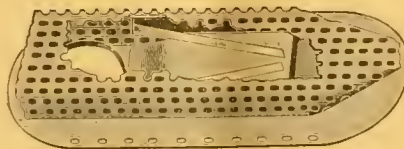

Porter Honey-House Bee-Escape

Have you seen it? Just the thing to put on the doors or windows of your bee-rooms. Indispensable, you'll say after you have tried it.

Cornell Bee-Smokers.

Cheap, strong, serviceable. We have sold a good many of these, and so far there has been no complaint; but, on the other hand, there have been scores of letters in their praise. Price, 85 cts. Prepaid, \$1.10.



COWAN.

Cowan and Novice Extractors.

These are the best. We are prepared to furnish, on short notice, from any of our several Branches, 2, 4, and 6 frame Cowans and 2-frame Novices. If you want the genuine, see that they

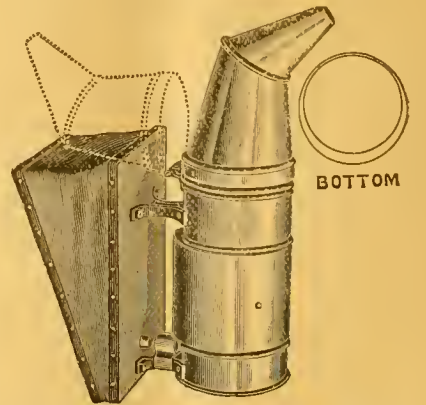

BOTTOM

bear our name. **A 36-page Catalog sent Free on Application.**

THE A. I. ROOT CO., MEDINA, OHIO.

BRANCH OFFICES AT:

118 Michigan St., Chicago, Ill.
1024 Mississippi St., St. Paul, Minn.

Syracuse, N. Y.
Mechanic's Falls, Maine.

AMERICAN BEE JOURNAL

DEVOTED EXCLUSIVELY TO THE INTERESTS OF HONEY-PRODUCERS

ESTABLISHED 1861
THE OLDEST BEE-PAPER IN AMERICA

Published Weekly, at \$1.00 per annum. Sample Copy sent on Application.

36th Year.

CHICAGO, ILL., JUNE 18, 1896.

No. 25.



The New "Jardine" Bee-Escape.

BY JAMES PEARSON.

The time has now dawned upon us when "Improvement is the order of the age." In all lines of work we find that Progress is led onward and upward by the strong hand of Invention. We can look back through the history of our labors among the honey-bees, and remember how we used to kill the poor little creatures in order to get their honey; and how we got along a little farther, so that with ourselves all "done up in a rag," and a big smoker, we could manage to get the honey, leaving the bees in terrible anger for several days. Step by step we advanced along this line until an escape like the Porter was invented. It was a grand thing, and a large step toward the mark of the high calling which is in Perfection. The super case was raised a little, and a board, similar to a honey-board, put in between the super and the brood-frames. In the center of this board was placed the escape. This escape was made with an opening large enough to allow a bee to crowd herself out, but could not return. Of course, as nature had taught them to go down and out the door, they would go down out of the super case, through this little opening and thus enter the brood department, never more to return. This worked very nicely. Other inventors revised the opening, by using doors, etc., of various kinds, but all used the one principle—of letting the bees out through some sort of an opening which would prohibit them returning in the super department.

This method at first seemed perfect, but as time went on, one thing seemed to be wanting—that was, greater escaping-room. Mr. James Jardine, of Nebraska, an old veteran at the bee-business, conceived the idea that if the bees would go out through an opening in one of these small escapes, they would surely go out in less time through half a dozen holes. Hence, he went to work and made the new "Jardine" escape, which is illustrated here.

About three years ago he made the first one, and it worked so well that he made several and scattered them around in various parts of the United States for trial. Every trial brought back a hearty endorsement, and many comments on it, especially in regard to its rapidity. So he has "applied for a patent" on it.

He has made them of different materials, but has decided to use thin basswood for bottom and top, while the partitions are pressed tin, soldered in a perfect shape. Each door is hung to the top with a very fine staple; and is left high enough from the bottom to admit a bee's head, and then she goes through, while the door drops down like a flood-gate.

The bottom and top is securely fastened together by six wood-screws. The entrance at the top is a 1 1/4-inch round hole, affording ample room for a larger business. It will be seen by the cut that there are six doors instead of one as is found on the Porter and other old-style escapes. Any pupil in primary arithmetic can see that so many bees can pass out through six doors of the same size in much less time than through one door. It is as plain as the nose on your face. Each door is made with a flange, shutting on the outside of the tin edges, or door-flaps of the partitions, thus avoiding any gumming or sticking.

As will be noticed, we save a great deal of time, affording the same escape-room and capacity with one of the "Jardine" escapes as with six of the old-style escapes; also much lumber is saved, and time in making boards for the escapes to be placed in. When using six Porter escapes you must have six boards, while we require but one. This escape is put up to

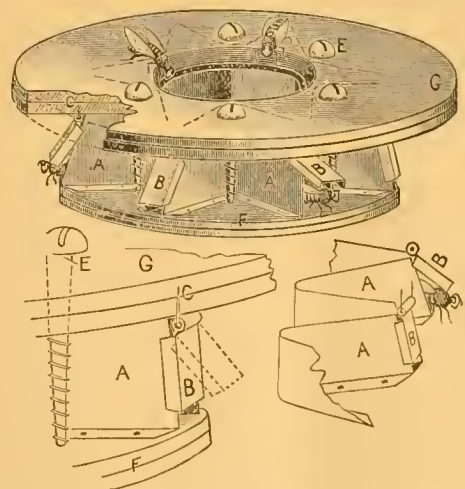

last a long time—a life time, if good care is taken of it—and it is attractive in its natural appearance, as well as fine in its mechanical appearance.

Of course, a little more must be charged for it than for the single-file escapes, but the price is nowhere near as high in proportion to its capacity as the prices of the other makes; besides saving so many boards, and much valuable time. It seems as if every "up-to-date" bug-keeper could not afford to be without one.

The Carniolan Bees—Their Color, Etc.

BY EMERSON T. ABBOTT.

Just before he discontinued the publication of the American Apiculturist, Mr. Alley, in reply to an article of mine, made some statements about which I wish to offer a few suggestions. I do not do this for the sake of controversy, as life is too short to spend much of it in argument simply for argument's sake, but to see if we cannot get the facts a little more clearly before us. The matter seems important to me, as I am confident that the time will come when the Carniolan bees will be given more attention than they are now receiving in the United States. I might say, in passing, that so far as my information goes, they are likely to prove of much more value to the bee-keepers of this country than *Apis dorsata*, about which a good deal is being said at the present time.

But to return to the article of Mr. Alley. He asks, addressing himself to me: "Do you not know that the silver-gray rings of the dark Carniolan bee are merely the result of the yellow blood in the Carniolans?" To which I reply that I do not know anything of the kind. The gray bees of the South and Southwest have the same rings, and these bees do not show even a trace of yellow blood when purely bred. More, they possess many of the desirable traits of the Carniolans, and I am inclined to think that they originally sprung from the same stock. I have seen colonies of these bees in Missouri which were as gentle as the Carniolans, and that stuck to their combs as closely as the Italians. The truth of the matter is, I think any one who has the gray bees without any admixture of Italian or the ordinary black blood makes a mistake if he does not take pains to keep them pure.

Mr. Alley further says: "When we breed Italians from imported mothers, the progeny, both queens and workers, runs back to solid black." This has not been my experience. They do not do that way with me. In fact, the very opposite is true. Every generation, if purely bred, becomes more yellow, so that it seems to me that the entire tendency of the progeny of imported Italians, if kept pure, is toward increased yellowness.

Again he says, "There are no *all* steel-gray colonies of bees to be found in Carniola." While I cannot say from actual observation that this is a mistake, yet I do know that I have had a queen in my apiary since I lived in St. Joseph, which came direct from Carniola, the progeny of which did not show even a trace of *yellow*. However, the fact that there is a tendency in nearly all bees which come from that country to show yellow, does not prove that the original color of these is yellow. Every breeder of Barred Plymouth Rock fowls knows that they show a tendency to become black, but this does not prove that the natural color of these fowls is black. There is also at the same time a tendency to become white, and from this by the same process of reasoning one might prove their natural color to be white. Both are unwarranted conclusions, and prove nothing as to the original color, or rather, the true color of these fowls. They do prove, however, that the Barred Plymouth Rocks are what may be called a combination breed, that is, made up of mixed blood, and that the color tends to vary according to the pre-potency of the fowl furnishing the blood which produces the prevailing color. It is claimed, I know, that there is a tendency in Nature to variation independent of the blending blood, but I doubt this being true. There may be a mixture of blood in most of the bees found in Carniola at the present time. If so, we would expect all of the progeny of such mixture to show traces of it for a long time.

The longer fowls are carefully bred and selected as to a special marking or color, the more permanent that marking or color will become, and the less tendency there will be to variation, or to revert back. This is just as true of bees as it is of fowls, but we would expect any mixture of foreign blood

to show through several generations. With proper care and careful selection any color can be bred out or in. You can take a white hen and breed her to a black cock, and then by judicious selection breed out every tendency to either black or white in the progeny, no difference which color seems to predominate. The predominancy of color, as I said above, will depend entirely upon the pre-potency of the parent furnishing the blood, or, to speak more correctly, the germ which produces the tendency to the color predominating. This law of heredity, as previously suggested, is just as applicable to bees as to any other animals. I have no doubt but what he can take Carniolan bees showing a tendency to yellow and breed out every trace of gray; or, if he choose, he can breed out every trace of yellow, that is, if he can control the matings. This, of course, will take time, but it can be done. The doing of it, however, would not prove anything as to the original color of Carniolans.

Which strain of these bees would prove to be the best I am not prepared to say. From what little experience I have had along this line at the present writing I would select the yellow. As to which strain would come the nearer being like the bee which was first given the name Carniolan, I do not know this, either. In fact, I doubt if any one knows, or could demonstrate it beyond successful contradiction. It would require a long and careful investigation in the native land of these bees to come any where near settling the matter, and even then the chances are the question might remain unsettled. It is my opinion that steel-gray is the original color, but I may not be correct.

There is one point that is fully settled in my mind, and that is, that the Carniolans are much more valuable than the mass of bee-keepers at the present time seem to think. I am thoroughly convinced that all that is needed is to put them to the test in order to demonstrate their superior qualities. I think, too, that the mixture of yellow blood improves them. Here is a field for some of our workers at the experiment stations. Will not some one take it up, who has no financial interests in the result, and see what can be developed out of it?

Let me say in conclusion that I do not have any of these bees for sale, and have no interest in the business of any one who has.

St. Joseph, Mo.



Painted or Unpainted Hives—Which?

BY J. A. NASH.

On page 243, C. Theilmann advocates the non-painting of bee-hives, referring to an article on page 746 (1895) by Mr. Thomas. On examining my file of the "Old Reliable" for last year, I find that number missing. I believe, however, that Mr. Thomas advocated the oiling of hives with *old* linseed oil, instead of a priming coat, as is usually done by experienced painters.

I think that Mr. Theilmann has taken untenable ground in this case. I have made hives and painted them for many years, and am well aware that lead and oil add greatly to the cost, but I have always believed that it was money well invested. I am a practical mechanic, and for years, in the earlier part of my life, followed house-building, as well as bee-keeping. Now, I consider a bee-hive and a house very much alike in many respects. Both should be made of good, sound, dry lumber; the joints should be tight fitting and well nailed. But let a house be ever so well built, of the best material, and not painted, and in a few years it presents an unsightly appearance; boards are warped and split, water has soaked into the once tight joints and rotted them; nails that once were driven down "flush," or sunk beneath the surface, now protrude, or, as the workman would say, "the sun drew them." Sashes and doors are sagged out of square, and the pins and keys that held them together are loose. These and

many other "landmarks" of the lack of paint can be seen on any house where paint has been omitted.

Now, in case of a hive it is much the same. It should be well painted everywhere that the elements can reach. I have been troubled in years past by the rotting of tops and bottoms of brood-chambers, cases, etc., where the water soaked in from the outside. Some years ago I began painting all my new hives on the joints, also the top of the floor or bottom-board, and now I have but little trouble from decayed lumber.

I have never kept bees in unpainted hives, therefore I can only speak of them as I have found them in other apiaries. I have purchased bees frequently in hives that were fairly well made, of good material, but *not* painted, and I have usually had a job to prepare them for removal. Boards were warped and cracked, corners gaping, and bees "leaking out" here and there in a most aggravating manner.

Dr. Miller says on page 774 (1895): "But I think covers should be painted, and I came to this belief after years of experience with unpainted ones." You are right, Doctor; and it does the rest of the hive good also. I have come to this belief after years of experience with *painted* ones.

Now, I have not arrived at this conclusion from keeping a few colonies. My apiaries (though at present like many others in Iowa where we find honey crops like angel's visits—few and far between) have in the past numbered from 100 to 400 colonies, and I have found the business fairly remunerative.

Mr. Thomas, on page 114, gives as a reason for bees deserting their hives the presence of "fat" or resinous knots causing a strong smell of turpentine in the hive. If these knots are varnished with shellac, the smell will be confined inside the wood. Such places should always be treated with a coat of shellac before the paint is applied, otherwise the knot is apt to show through several coats of white lead.

Monroe, Iowa.



The "Golden Beauties"—Notes and Comments.

BY EDWIN BEVINS.

Alas! my golden beauties have gone where the woodbine twineth. An examination to-day (May 6) revealed the fact that scarcely more than a hundred bees remained of a strong colony that was built up from a two-pound lot of bees which I got from Texas about a year ago. There was plenty of honey in the hive.

A two-pound lot of 3-banders was obtained of the same party at the same time. The two lots received the same treatment, and last fall the two colonies were of equal strength, and well supplied with stores for winter. They had the same winter protection. The 3-banders are now strong and active, and doing a land-office business at brood-rearing.

Golden Beauties! Will somebody arise and explain why this term is never applied to a yellow dog? Here's my hand, Mr. Quigley, *et al.* It is not *very* sore. I suppose your fingers have gotten entirely well. I shall not deliberately thrust mine into the fire again.

Some two or three weeks ago I went around among the bees and fed the colonies which seemed to be light in stores. I was too late, however, with one colony, as it had already perished of starvation. Another colony, protected like the rest, had perished with a hive nearly full of honey. It probably went into winter quarters without a queen. These two circumstances impress upon me the necessity for watchfulness. Both of these losses might have been avoided—the one by providing the colony a queen last fall, and the other by timely feeding this spring.

To-day I went over the yard again. One colony was found about as strong in bees and brood as colonies are generally found in swarming-time, but there was not much of anything

in the hive for the bees to eat. This colony was built up from a weak nucleus made last June. Late in July this nucleus was found to be without a queen. It was given a queen and strengthened with a frame of brood. Late in October an examination showed a hive full of bees, but there was not a pound of honey in the hive. The bees were immediately fed three gallons of syrup made after Mr. Doolittle's formula. At the time of my first examination this spring I gave them a few unfinished sections. There was a little of this honey left when I examined to-day, but I could find none in the brood-frames. Then I took the hive full of honey left by that queenless colony, and placed it on top of the hive just mentioned. I found another colony which seemed to be stronger than there is any need for just now, and which seemed to be anxious for additional room. On top of this colony I put the hive full of empty combs, and I propose to feed the bees heavily until the honey-flow comes.

Now, will somebody prognosticate for me the results of this tomfoolishness? I have an idea that by the time the honey-flow comes the queens and most of the bees of these two colonies will be occupying the upper stories. Then I will take off these upper stories and force most of the bees into the lower stories, in the expectation that I shall get a good deal of work done in the sections placed on them. But perhaps I have overlooked some condition, or conditions, that will result in bringing about the defeat of my expectation.

I also noticed in my search to-day one colony where a good many bees were gathered about the entrance of the hive, apparently in great distress. A few dead bees were lying around, which had the appearance of having recently died. This colony had been fed some time before, and the population had gotten quite numerous. On opening the hive the feed was found to be exhausted, and there was no honey to be seen along the top-bars of the frames. I made some haste to give them something to eat, and that colony was saved.

Almost all of this watchfulness and work of feeding is called for by bees in 8-frame hives, with frames of standard depth. My big colonies, in the big hives, go serenely on their way, and do not favor anybody. I am growing more and more in favor of that system of bee-management, inaugurated and practiced by the Dadants. For saving of labor and safety of wintering I believe this system cannot be surpassed. Whether it will prove to be as good as any other where comb honey is the object in view, I wish bee-keepers would make haste to find out. It seems as if the honey adulterators have gotten us where we are obliged to work for comb honey, whether we like it or not.

The pollen sign is not always a sure one that your bees are rearing brood. For a few days after pollen could first be gathered I watched carefully, and was sure that I saw pollen going into every hive. Later I noticed two hives that had a good many bees gathered on the alighting-board, spending their time in idleness. I watched for the return of bees that might be afield. Many returned, but they brought no pollen. A hasty examination showed the two colonies to be queenless. I am waiting with some impatience the arrival of queens.

I keep part of my bees in a house made for the purpose, and I am ready to indorse all that has been said about the superior comfort of handling bees in house-apiaries. When I open one of these hives the bees do not fly up and present the business end with the same alacrity that bees do from hives that stand in the sunshine.

I note with mild surprise that Doolittle has his old man out in the same old garb, and I presume that I am to blame for his not being better dressed. I did not buy any queens of Doolittle last season. But Doolittle is partly to blame that I did not buy any queens of him. I do not know that he has ever told us that he handles anything but "golden beauties." If the old man does not come out in a new suit next year, I

mean to throw the blame on Doolittle. Let him go to rearing leather-colored queens. When anybody solicits me to buy "golden beauties" now, I shake my head very much as a hen is said to do when offered a worker-bee to eat.

Leon, Iowa.



De Honey Am Comin' in de Doah.

BY MRS. E. R. B.

Dere's a cabin dat's a buildin' 'long de basswood trees—
O de honey am comin' in de doah;
For I 'clare dose gums hol' a mighty sight o' bees—
O de honey am comin' in de doah.
Watch out, you darkeys, for de gran' log rollin',
Hab ebry banjo strung for de all-night thummin',
For we's in for de fun while de bees am swabmin',
And de honey am comin' in de doah.

Dere's a mockin'-bird singin' by de garden gate—
O de honey am comin' in de doah;
And I feared he tell dat dis niggah out late—
O de honey am comin' in de doah.
Watch out, you darkeys, for to hunt dat 'possum,
Down to yonda where the 'sinnon swamp blossom,
For we'll roas' dat meat, and we'll carve him handsome,
While de honey am comin' in de doah.

Dere's a weddin' a fixin' for de middle of June—
O de honey am comin' in de doah;
An I tote my darlin' to de little cabin soon—
O de honey am comin' in de doah.
Watch out, you darkeys, get ebry han' workin',
Ready for d'day when parson do de talkin',
Ready for de hive dats chock-full for swabmin',
And de honey am comin' in de doah. Nunda, N. Y.

CONVENTION PROCEEDINGS

Vermont Bee-Keepers' Convention Report.

BY O. J. LOWREY.

The 21st annual convention of the Vermont State Bee-Keepers' Association was held at Burlington, Jan. 29 and 30, 1896.

The convention was called to order by President H. W. Scott, prayer was offered by H. L. Leonard, and the minutes of the last meeting were read and approved, after which came roll-call of members. The Treasurer's report showed the Association to be in good condition financially.

LAROE OR SMALL HIVES.

M. A. Everest opened the subject of "Large or small hives; which are best for bee-keepers?" He thinks for his work a hive with space enough for 10 frames 14x8½ inches large enough; he likes a long entrance on the side instead of from below, as in the Bristol hive, because the wind does not blow in as much.

H. L. Leonard—I think the size of the hive very important to the successful production of honey. I like a medium-sized hive measuring about 2,000 cubic inches, and having usually 10 frames 10x13 inches, inside measure. The advantages of this hive, to me, are, that I can extend the size by moving the division-board; can get a large colony not wanting to swarm early; never have to feed much—often place a

comb of honey back of the division-board. I have used other sized hives.

O. J. Lowrey uses a hive for 9 or 12 frames, 11¼x11¼ inches; he thinks this is as large as most queens can fill; only about five in 100 will fill over 10 frames. In his location 8-frame Langstroth hives are large enough. He thinks the amount of honey in the fall is usually as much in the 8 as in the 10 frame hives.

M. F. Cram thinks 9-frame hives best, as smaller ones cause too early swarming.

R. H. Holmes uses Langstroth hives with from 4 to 11 frames, and division-board. He thinks it beneficial to contract in the fall, often to 7 frames or less. In the spring he expands slowly as they need; he thinks the gradual expansion keeps off the idea of swarming. Large hives, less feeding, less surplus; small hives, more feeding, more surplus. The apiarist and the location make much difference as to the size of hive needed, and results obtained.

COMB VS. EXTRACTED HONEY.

A paper from W. G. Larrabee was read, on "Comparative Cost of Producing the Two Honey—Comb and Extracted." In his experience some years extracted paid the best, while in others comb honey was the most profitable. In starting an apiary for extracted honey, the expense is more in getting supplies than for comb honey, but it can be produced much cheaper. The labor required to produce extracted honey is very much less. Two hours of good, hard work will do all that is necessary for a colony in a good year. If one desires to get the most profit from the least labor, run for extracted honey, but if one is looking for the pleasure that is to be found, he would by all means produce comb honey.

In the discussion that followed it was decided that conditions and seasons differed much as to the comparative profit.

H. W. Scott thinks extracted honey much cheaper and most profitable. He uses 10-frame Langstroth hives, two stories until the honey-flow, then keeps the queen below with an excluder. He says they do not swarm as much. He leaves the honey on until half sealed.

Ques.—"If honey comes slowly why do they use more in producing comb honey than in extracted?" Ans.—"In building comb slowly they make heavy comb; this requires much more honey."

H. L. Leonard prefers to produce both honeys together.

Reports of members for the season of 1895 showed that the crop of honey was very light, giving an average of 19.2 pounds per colony, spring count, and a very small increase in colonies.

The question-box was next opened.

PREVENTION OF DRONES FLYING.

1st. "Is it practicable to prevent drones flying from all colonies that are not above medium in working qualities? If so, what is the best method?"

O. J. Lowrey—The apiarist should breed only from the best stock, keeping back poor drones by shaving the cells. A queen-breeder should take every precaution against poor drones by using drone-traps all the time. I do not think the traps interfere with the working of colonies.

BREEDING FROM THE LIGHTEST-COLORED QUEENS.

2nd. "Is there danger of deterioration by continually breeding from the lightest-colored queens?"

H. W. Scott—Yes.

R. H. Holmes—That depends upon whether the lightest-colored bees are the best; many times they are not. As a rule, I prefer the leather-colored bees.

GOLDEN-ROD HONEY FOR MARKET.

3rd. "Will it pay Vermont bee-keepers to put honey on the market as poor as the golden-rod at any price?"

A Member—No; do not sell poor honey at any price.

THE EVENING SESSION—SPRAYING FRUIT-TREES.

At the evening session Prof. L. R. Jones, of the Experiment Station, read a very interesting paper on spraying. After some remarks upon the general subject of spraying and its growing importance to the horticulturist and fruit-grower, he passed at once to the main topic of the paper—the danger of poisoning bees by the use of arsenical sprays on fruit-trees. He gave a history of the controversy on spraying, speaking of the experiments by Prof. A. J. Cook, of California, and Prof. F. M. Webster, of Wooster, Ohio. None of the experiments were accepted by the Association of Economic Entomologists as conclusive evidence that bees were killed by arsenical sprays until Prof. Webster's report at Rochester, N. Y., in 1894. These last experiments ended the controversy.

Prof. Jones sent seven questions to the following, who are considered as among the leading entomologists of the country:

L. O. Howard, Entomologist United States Department of Agriculture; Dr. J. A. Lintner, State Entomologist, Albany, N. Y.; Prof. F. M. Webster, Wooster, Ohio; Prof. M. V. Slingerland, Assistant Entomologist, Cornell Experiment Station, Ithaca, N. Y.; Prof. S. A. Beach, Horticulturist, Geneva Experiment Station, Geneva, N. Y.; Prof. J. A. Fletcher, Entomologist Central Experimental Farm, Ottawa, Canada.

The following are the questions sent and a summary of the answers received:

1. Do you consider it a demonstrated fact that honey-bees may be poisoned by arsenical or other sprays applied to fruit-trees when in blossom?

Lintner (Aug., 1893)—No.

Webster (Aug., 1892)—No. (Aug., 1894). Yes. Bees are liable to be poisoned.

Howard—No. (Considers further experimentation necessary.)

Fletcher—Yes.

Slingerland—I consider the fact fully demonstrated by Webster.

Ques. 2.—Do you consider it a demonstrated fact that bees visiting such sprayed trees may convey the poison to the hive and contaminate the comb of honey with it in such a manner as to render this unfit for human food?

Lintner—No.

Webster (Aug., 1894)—Brood evidently killed by the arsenic brought.

Howard—No. (Considers further experimentation necessary.)

Fletcher—Yes (?). (Cites poisoning of brood by arsenic.)

Slingerland—Webster's experiment would indicate it, but the fact not fully demonstrated.

Ques. 3.—Do you consider that spraying apple or pear trees with arsenical poisons during the blossoming period gives appreciably better protection to the tree than can be gained from spraying before and after the blossoming period?

Prof. Lintner makes no positive statement, but considers it probable.

Prof. Howard uniformly recommends spraying before and after; never during blossom.

Fletcher—I am sure there is no advantage in spraying when in blossom.

Slingerland—No. The insects can be as effectually reached by spraying before and after.

Ques. 4.—Do you consider that spraying fruit-trees during the blossoming period is liable to be injurious to the tree in any way? and especially in the way of interfering with fertilization of the blossoms?

Fletcher—Yes.

Prof. Beach is of the opinion that the fertilization of the flower might be interfered with.

Slingerland—Yes, a liquid spray of any kind would be injurious.

Ques. 5.—Do you find fruit-growers in your State or locality spraying during the blossoming period?

Fletcher—No.

Beach—No.

Slingerland—No; I know of no New York fruit-grower who sprays when the fruit is in bloom.

Ques. 6.—Do you favor any attempt to forbid by legislative measures the spraying of fruit-trees during the blossoming season?

Lintner—Decidedly opposed to it.

Slingerland—No. (Considers it both unnecessary and impracticable.)

Ques. 7.—Are you at present using, or recommending for use in spraying, any compounds or solutions containing sugar or other sweet substances which might induce bees to eat it?

Howard—Not for fruit trees. Glucose with arsenate of lead for elms, shade-trees, etc.

Fletcher—No. Sugars, etc., are unnecessary. Use lime instead.

Beach—No.

Slingerland—No.

REPORT ON EXPERIMENTS CONDUCTED.

The report of work done at the Experiment Station for the previous season was given by D. D. Howe, Farm Superintendent, and O. J. Lowrey, of Jericho.

Experiment No. 3 was with different-sized frames, shallow brood-chambers, and wintering bees in the same. No perceptible difference has yet been noticed.

No. 7.—To see if bees would use yellow wax in building comb and finishing the capping of the honey. It has been proven that they will, by the mottled appearance of the comb honey finished during said feeding.

No. 8.—Experiment with the Langdon non-swarmers. Proved not satisfactory in the production of honey or prevention of swarming.

No. 9.—The experiment of cutting out drone-brood once in ten days to prevent swarming. It did not prove a success.

No. 10.—Three samples of comb foundation, one made on Given press and two made on roller mills, and given the bees to fill under like conditions. It was exhibited and sampled by members of the convention. The examination proved that they could not distinguish honey stored on the roller foundation from that stored on the press foundation.

The committee on nomination of officers for the Association for the ensuing year gave their report, recommending that the old officers be re-elected. This was done with the exception that C. W. Fisher resigned, and O. J. Lowrey, of Jericho, was elected Secretary.

The committee on resolutions submitted their report, which was unanimously adopted as follows:

Resolved, That our thanks are tendered to the proprietor of the Van Ness House for favors shown us during the meeting.

Resolved, That the thanks of the members of this association be tendered to the Central Vermont railroad for reduced rates during this session.

Resolved, That we express our hearty thanks to Prof. L. R. Jones for his painstaking effort in procuring reliable information from the best authorities in the country on the subject of spraying of fruit-trees, showing the uselessness of spraying while in bloom, thus protecting the interests of the bee-keepers as well as producing the best results to the fruit-grower.

Resolved, That we highly appreciate the interest shown by the Board of Control and Director of the Vermont Experiment Station, as well as the labor performed by the Farm Superintendent in the work of the apiary. COMMITTEE.

The committee to confer with the Board of Control at the Experiment Station in regard to work to be done there the coming season are, O. J. Lowrey, R. H. Holmes and M. F. Cram.

REMOVING CHAFF CUSHIONS IN SPRING.

Ques.—“How early in the spring should the chaff cushions be removed?”

M. A. Everest—Locations and colonies vary greatly in regard to the time the cushions should be removed. Much judgment is needed. I remove from strong colonies about May 20.

R. H. Holmes—I remove chaff cushions at about the same time, but question if it is advisable to leave them on so long.

H. L. Lennard keeps the cushion on until he puts on sections, unless they need feeding. He has raspberry honey, so

he has to put cases on early. Sometimes he puts the cushions on over the section-cases.

OUTLOOK FOR HONEY-PRODUCTION.

The future outlook for honey-production in this State was discussed. Some thought the outlook rather poor, but generally there was hopes of better crops in the future. V. N. Forbes said: "I have practiced furnishing Alsike clover seed to neighbors at cost price, and think this is the best way to get a crop of honey. I advise mixing mammoth clover with the Alsike."

As there was no unfinished business, it was voted to hold the next meeting at Vergennes, in January, 1897. The convention then adjourned. O. J. LOWREY, Sec.

Questions AND Answers

CONDUCTED BY

DR. C. C. MILLER, MARENGO, ILL.

[Questions may be mailed to the Bee Journal, or to Dr. Miller direct.]

Why Did the Bees Leave the Hive?

I had only one colony of bees last year, increased to four, and all seemed to be in good condition, but all at once one took a notion to leave the hive and go into a neighboring colony. I examined the hive, and could not see a thing the matter. I had a good supply of honey. I kept putting the queen back, but the bees would fly off and stay sometimes 15 to 30 minutes. I kept them in for two months. What was the matter? What could I do for them to quiet them? E. M. T.

ANSWER.—Hard to tell, unless it was the desertion that occurs a good many times in spring when a colony is not very strong. It occurs, I think, generally, if not always, when a colony has more brood than it can cover. Just why the bees desert I don't know, unless they become discouraged because they can't cover all the brood.

Various Kinds of Smoker-Fuel.

How do you keep the smoker lighted? I use the Clark, but find it difficult to keep it going long enough. What kind of fuel is best to use in it? C. M. M.

ANSWER.—If the door of a Clark smoker fits very closely there is not draft enough to keep it going. In that case open the door just a little. Stand the smoker with the nozzle uppermost, and it will burn better than to lay the smoker down. Of course, the kind of fuel makes a great difference. If you use punk, you will have no trouble about the fire going out, no matter how the smoker stands. I have had great satisfaction in using the soft, white, rotten wood from apple-trees. If you want to make it extra-good, dissolve saltpeter in water, soak the rotten wood in that, then dry it. The least spark of fire touched to it will burn, and you will have hard work to put it out. Some use cheap paper rolled together and soaked in saltpeter.

A great many different things are recommended for smoker fuel, some calling one thing best, some another. The thing a man finds out for himself is likely to be thought best by him. There's a good deal in being used to a thing. Then it makes a difference as to what is most easily obtained. I have used planer-shavings more than anything else, not because they are better than anything else, but because I can go to the planing mill any time and get all I want. Pine

shavings are perhaps used more than anything else, because most readily got, but they're not the best. Basswood shavings are good, especially if you can get those that are a sort of compromise between shavings and sawdust. Some use corn-cobs chopped up. Pine needles are not bad. Old cotton rags are excellent, and not inclined to go out. Cowdung has been used, but I've never tried it. It has been objected to on the score of cleanliness. Cotton-waste—that which has been used on the journals of railroad cars and thrown away—is good. Dry twigs of hard wood broken up are good. If you are blowing hard and keeping up a big fire, you can use green twigs a fourth to half an inch thick, and you'll have a dense, sharp smoke. In fact, you can use almost anything that will burn, and that you can get into a smoker, if the pieces are not too large.

Rearing Queens—Clipping—Bee-Zinc.

1. Are queens reared from queen-cells during swarming-time, with a good queen in the hive, fully developed in all cases except where cramped or injured?

2. Do the bees sometimes use larvæ too old to make good queens, during the swarming-fever period?

3. Do you think it pays to keep all queens' wings clipped, with the bees in large hives? I like the idea, but my, what a job it is! I try to keep my hives as populous as possible, and even in the early spring I find it a long task to search for the queens among such multitudes of bees. Where one can give but limited time to the bees, as with me, I am more and more beginning to favor excluding-zinc to prevent swarms from absconding. After all, do you think the zinc hinders the bees very much, especially if it is placed as in one of the cuts on page 99 of the "A B C of Bee-Culture," so the bees do not have to climb up any, but simply walk through on the bottom-board? E. M.

ANSWERS.—I. I'm not sure that they are. Certainly there's a difference in the appearance of the cells and a difference in the queens, and if some queens are different from others it seems reasonable to infer that there may be so much difference that some of them will hardly be considered fully developed, but it may not go so far as that.

2. When the bees start preparations for swarming I don't believe they ever start with a larva, but always with an egg in a queen-cell. Queens are started from larvæ only in cases where the queen has been removed.

3. I think it pays me. The looking over and clipping can be done before the busy time comes. I hardly think the hindrance of perforated zinc is a very serious matter. Of course, however, there must be no zinc in the way when a young queen wants to leave the hive on her wedding tour.

Honey from Motherwort.

What is the quality, color, etc., of honey stored from motherwort? I had hundreds of pounds last summer of dark, cloudy honey, that had a very peculiar taste (not a very pleasant one, either), and I am anxious to know whether it was from motherwort or honey-dew. My bees worked on both? Pugh, Ohio. S. B.

ANSWER.—I don't know. Who can tell? I suspect the dark and cloudy honey was more likely honey-dew.

Drone-Trap Questions.

1. My two colonies of bees came through the winter in fine condition, packed with dry leaves on the summer stands. They are boiling over with bees now, and I think they will swarm as soon as it stops raining long enough. Thinking they might come out while I was at church yesterday, I put on the drone-trap, and it was a grand success, for it was packed full of drones, when I got home, with many of them dead. Now, what did so many drones coming out indicate?

2. What ought I to have done with the drones? (I let them go back into the hive.)

3. What would have become of my queen if they had

tried to swarm? I have a neighbor who claims to be authority on bees; I might ask him, but I prefer to ask the "Old Reliable." He introduces a queen by turning her loose in front, and spends his extra time in picking the surplus eggs out of the cells of one colony (whose "layer" seems bound to put three or four eggs in every cell) with a pin.

A. B. GINNER.

ANSWER.—1. I hardly think it indicated anything more than that the day was warm enough so the drones wanted to come out to play.

2. Very likely it would have been economy to have killed the most of them, as it is a matter of some expense to keep a big lot of drones.

3. Probably the queen would have been caught in the trap the same as the drones were. If left long enough in the trap she would probably perish, but at the time of swarming the bees are supposed to have one or more young queens ready to emerge from their cells about eight days later. That young queen would have to be allowed to leave the hive for fecundation or the colony would perish. If a trap is placed in front of a hive, it will not do to leave it unnoticed throughout the season.

Will They Carry Up the Syrup?

I feed my bees until the hive is full, of syrup made of sugar; then when the honey-flow comes (if it does), will the bees carry this syrup above and deposit it in the surplus case, or will they put the nectar in the surplus boxes, and leave the syrup below? I want a square answer to this, if you please.

J. M.

ANSWER.—I'll try to give you a square answer, and tell you at least what I think. If you feed enough so that every cell in the hive not occupied with brood is crammed, and the queen has not enough room to lay, and supers are put on immediately after feeding, I think the bees will be likely to carry up some of the syrup to make room for the queen to lay. If the feeding is done some time before the harvest, I don't think there is much likelihood that anything but newly-gathered honey will be carried above. But I don't know anything about it from actual trial.

Two Grubs in a Queen-Cell.

On May 20 my first swarm issued, and to prevent after-swarms I proceeded to cut out the queen-cells. On the first frame I picked up there was the biggest cell I ever saw. In length it was about two inches, and not more than $\frac{3}{4}$ inch in circumference. You can imagine my surprise when, on cutting it open, two well-developed grubs tumbled out. What was the cause of it? Is this a phenomenon, or do you older chaps see these things often?

L. E. H.

ANSWER.—No, I don't think we old chaps often find two grubs in a queen-cell, although it does sometimes happen.

The Names and Addresses of all your bee-friends, who are not now taking the Bee Journal, are wanted at this office. Send them in, please, when sample copies will be mailed to them. Then you can secure their subscriptions, and earn some of the premiums we have offered. The next few months will be just the time to easily get new subscribers. Try it earnestly, at least.

The Alsike Clover Leaflet consists of 2 pages, with illustrations, showing the value of Alsike clover, and telling how to grow it. This Leaflet is just the thing to hand to every farmer in your neighborhood. Send to the Bee Journal office for a quantity of them, and see that they are distributed where they will do the most good. Prices, postpaid, are as follows: 50 for 25 cents; 100 for 40 cents; or 200 for 70 cents.

Every Present Subscriber of the Bee Journal should be an agent for it, and get all others possible to subscribe for it.



Sell Only Good Honey.

Only last season, or 1894, I got a rather limited supply of sweet honey. Yes, it tasted sweet, all right, but somehow the little basswood and no white clover honey was mixed with something that made it slightly off in color; also it did not have just the right taste; but it was up to standard in weight. Now, I believe a majority of us would have called this honey good enough to offer to our best customers. We would not expect at least any serious harm; but let me tell you about it. I wanted some of those greenbacks and silver dollars. I had my doubts about it, but I rather reluctantly loaded up and went to town. I commenced right on the start to tell my customers that honey this season was not quite as good as usual. Those who wanted 50 pounds or more, I would persuade them to cut down their usual supply. In one instance a 50-pound customer wanted their own way; the whole family tasted while I talked. I finally got them down 10 pounds—they took 40. Now for the result. This season (1895) my honey was never better. When I called at this place with the usual good morning, I told them I was around with honey again. The little children playing in the front yard didn't even look up.

"Well," says the good woman, "somehow we don't like honey as we used to. We have kept putting it on the table every day, but we have quite a bit left that we got of you last season."

I referred to what I said the season before.

"Now," said I, "you bring out that old honey and I will trade you new honey even up for it." The trade was made. "Now, I want you to take enough more to make your usual 50 pounds." She hardly thought it best, but finally let me have my way.

Just a few days ago the man of this house called out from the other side of the street:

"Say, White, we are about out of honey; can we get about 20 pounds more?"

"No, sir," said I, "we are all sold out."

"That's too bad. We will see we get more than 50 pounds next season."—DAN WHITE, in *Gleanings*.

Small Hives.

In this matter of small hives some seem to think that Doolittle is not helping the bee-fraternity much, for, say they, "better results can be secured with large brood-chambers." Well, if such as say this are right, I made a mistake in those trials made years ago, and many others are making the same mistake to-day, for the larger part of our successful comb-honey producers are to-day using small brood-chambers; some even smaller than I use. But as the reports of those using these small brood-chambers are always larger, on an average, than those who recommend large hives, I conclude that I have not made a mistake.

What is a brood-chamber for? My answer would be, for the purpose of rearing as many bees as possible for working in the honey season, and as few at all other times of year as consistent with accomplishing this object. The main secret of successful comb-honey production is the getting of the combs in the brood-chamber literally full of brood before the honey harvest, thus securing a full force of workers ready for the field just when they are needed. What man is there who hires a lot of hands to hoe potatoes before the potatoes are up? Not one; but they wait till the potatoes are ready to hoe, and then hire the help. Just so, we want our bees at the right time to have them profitable. A hive full of bees in March is of no more use than a field full of men to hoe potatoes would be at that season of the year; for May and June is the time we hoe potatoes in this latitude. Again, if we do not have the brood and bees in time for the honey harvest, all the extra powers of the queen are spent in vain, for it would be like employing a lot of hands to hoe potatoes in October, after they were all ripe and dug.—G. M. DOOLITTLE, in *Progressive Bee-Keeper*.

OLDEST BEE PAPER IN AMERICA ESTABLISHED IN 1851

THE AMERICAN BEE JOURNAL

PUBLISHED WEEKLY BY
GEORGE W. YORK & COMPANY,

118 Michigan St., CHICAGO, ILL.

REGULAR CONTRIBUTORS :

G. M. Doolittle, of New York. Prof. A. J. Cook, of California.
Dr. C. C. Miller, of Illinois. Dr. J. P. H. Brown, of Georgia.
J. H. Martin, of California. Rev. E. T. Abbott, of Missouri.
Barnett Taylor, of Minnesota. Mrs. L. C. Axtell, of Illinois.
Chas. Dadant & Son, of Illinois.

\$1.00 a Year—Sample Copy Sent Free.

[Entered at the Post-Office at Chicago as Second-Class Mail-Matter.]

Vol. XXXVI. CHICAGO, ILL., JUNE 18, 1896. No. 25.



The Amalgamation Question seems to have taken a rest. It has received some opposition, we know, but perhaps the best thing now is to have a vote on it, in order to discover just where those interested stand. The objections and favoring ideas having been advanced, and possibly about all being in, we should like now to see where the majority are on the question. Why not have the vote?

A Foreign Leaflet on Honey, recently published in the Review, contains these sentences:

"I know parents, who, in times of epidemics give to their children as an antiseptic, honey in abundance, and with complete success, these children having invariably escaped the illness."

"The Creator seems to have united every property in this remedy. Honey is not only sweet and wholesome, but also a food, a blood-producer of the highest order."

"Whoever takes regularly this bee honey will not only be much better nourished, but will also be spared under ordinary conditions, a heavy medicine bill, and will in any case increase his individual capacity."

Tare on Honey-Packages.—There doesn't seem to be much uniformity on the part of dealers, in the matter of tare deducted for the weight of five-gallon cans and the cases holding them. A California bee-keeper reports in the Pacific Rural Press that last year he was defrauded out of over 900 pounds of honey on account of too high tare on what was sold for 15 tons.

In Gleanings for June 1, Editor Root, in commenting upon this subject, said:

"There is too great a variety in allowances made for tare. The only fair and correct way is to allow for actual tare, whatever that is. In round numbers a square can weighs 2½ pounds; and it is customary to estimate that a pair of cans weighs 5 pounds. In round numbers, a box for holding two square cans, without partition, weighs about 15 pounds, although some of the boxes from basswood run slightly under this, some going as low as 12 pounds.

"When we receive a carload of honey in square cans we

weigh the whole package, and then weigh the box separately. As the weight of the cans is nearly invariable we get at the weight of the honey. It is a little more work to weigh the boxes one at a time; but, as you see, it is the only fair way of getting at the tare. It should be stated that, when the boxes are made of hard wood, and have an inside partition, they will weigh some more; but it seems to me that every commission firm, if it wishes to hold its trade, should get at the *actual tare* by weighing the boxes one by one, all of them. It is too much guess work to estimate a certain amount for boxes; and, moreover, the temptation is pretty strong to put the estimate high enough so that the buyer will be on the safe side. I do not see how we can have exact uniformity; but what we do need most of all is actual tare. Let the bee-keepers and commission men buy and sell honey at its actual weight."

"**From Our Neighbors' Fields**" is the heading of a new department recently started in Gleanings. It gives promise of being exceedingly good. It ought to be, when most of the "neighbors' fields" are generally teeming with luxuriance and richness. Anything that the gleaner of Gleanings can glean in our fields he will be more than welcome to—even to the gleanings of full sheaves.

A Handy Hive-Carrier is described in Gleanings by N. Young, of Iowa, as follows:

"I have of late been rigging up a contrivance or device which I think can be used in many apiaries to good advantage in moving light loads about the apiary; and as the cost of it is so trifling I think almost any one can afford to give it a trial. Get a large-sized fence-wire, say 100 or 200 feet long. Tie one end to the corner of the honey-house or bee-cellar; perhaps a good solid post near by, well braced, would be better. Then tie the other end to something solid out in the backyard, or wherever you think you want it; then stretch it tight with a wire-stretcher. I make a car by getting a dry-goods box, or make one large enough to receive a bee-hive. Knock off the sides, then take two pieces, 2x4, about 20 inches long. Nail them edgewise to the end of the box; then get two roller hinges and fasten on to each end of the box or car, hang it on the wire, and you have the outfit."

California Notes.—Prof. Cook recently sent us the following paragraphs:

LITTLE HONEY FOR 1896.—California will get very little honey this season. There was some storing from the early orange-bloom, and something may be expected from the alfalfa fields, especially where irrigation is practiced. However, it is safe to say that the honey crop of California for 1896 will be practically *nil*.

The above should make all California bee-keepers alive to the probable necessity of feeding bees to prevent starvation. It is a curious fact that we get no honey in Southern California after winters of scant rainfall. Yet we do get often quantities of flowers. Does this not come from the fact of the lack of vigor in the plants which causes a failure to secrete nectar? Might we not safely conclude from the above that it would be better to irrigate orchards, when possible, quite liberally during winters of extreme drouth?

NORTH AMERICAN IN NEBRASKA.—We learn that the North American Bee-Keepers' Association meets this year at Lincoln, Nebr., the seat of the State University. We are pleased that it is so. Valuable aid will be secured from such able scientists as Dr. C. E. Bessey and Prof. Lawrence Bruner. These meetings are very valuable. We hope that many will gather at Lincoln, and that there will be a strong program. Surely, much will be expected from the able bee-keepers of

Nebraska, in which State the Association meets for the first time. Nebraska has a wide-awake apiarian fraternity which will surely be heard from at Lincoln.

DEEP-BLUE POLLEN.—One of the curiosities which the observer notices in California is the presence of deep-blue pollen on the legs of the honey-bees. I never saw colored pollen in Michigan. Such pollen is secured from flowers of plants belonging to the family Polemoniaceæ, of which there are many species in this region. I have seen at least three species of *Gilia* with pollen of this color. A. J. Cook.

-Claremont, Calif.

Wiring Frames for natural comb-building is thus told about by B. F. Averill, of Virginia, in the Review for May:

"The present high price of foundation in connection with the depression of the times, may make it desirable for some to know, that very perfect wired combs may be obtained in frames fitted only with comb guides or starters. I experimented last year with about 20 colonies, and, with little trouble, secured wired combs in all the frames. I used, altogether, less than two pounds of foundation. I wired the frames with three horizontal wires, and in the majority of instances the bees built the septum along the wires with surprising accuracy.

"I found the best plan for attaching the foundation, to use a narrow strip the length of the top-bar, and imbed it firmly to the top wire; or else use three narrow, triangular strips a suitable distance apart for Langstroth frames. Perfect wired combs may be in this manner obtained with very little attention. The hives must be as level as possible cross-wise of the frames, to obtain the best results."

PERSONAL MENTION.

COL. W. F. CODY (Buffalo Bill) is reported having about 700 acres of alfalfa on his large farm adjoining the city of North Platte, Nebr. He ought to have a large apiary to gather the nectar that his many acres of alfalfa must yield.

MR. N. E. FRANCE, of Platteville, Wis., is the delegate of the State Bee-Keepers' Association to make another effort to get a foul brood law through the Legislature. He desires, and should have, the hearty co-operation of every bee-keeper in Wisconsin. Write him for instructions as to what each individual bee-keeper can and should do. It is a very important matter.

DR. GALLUP, of Santa Ana, Calif., is "Galluping" back into the bee-business at a lively rate for a man 75 years old. In a letter dated June 4 he reports having 13 colonies, and intimates that he may later on give his "experience in starting an apiary in Southern California without bees and needing no capital." Dr. G. thinks his (Orange) county the finest in the State. His bees are within $\frac{1}{4}$ mile of 20 acres of Lima beans, which are good honey-yielders there. It may seem funny that beans and honey bring the money out there.

MR. F. A. GEMMILL, of Stratford, Ont.—the Assistant Foul Brood Inspector of the Province—wrote us thus encouragingly of the prospects in his locality:

"The bees here are doing well—as well, if not a little better, than any previous year for some time past. Things at present look very promising for a good flow from both clover and basswood; in fact, I have already extracted a few hundred pounds of choice honey to satisfy some of my customers."

On almost all sides there are reports similar to Mr. Gemmill's. It does begin to look as if we were going to have a

"regular old-timer" this year. Should such be the fact, bee-keeping will be greatly revived in many parts of the country, and all connected with the industry, in whatever way, will feel the joyful thrill of prosperity and renewed hopefulness that would accompany a bounteous honey crop.

MR. ED. STRONG, of Kalamazoo, Mich., wrote as follows on Dec. 30, 1895: "The American Bee Journal is the most perfect of its kind now published. The outside departments are wonderfully well prepared. The freedom of their expression, each in his own way, is a rest to the weary."

MR. E. J. ATCHLEY, of Texas—referring to the queen-selling item in this department on page 362—says that one year they reared 3,000 queens and bought 2,000 more, to supply their orders; that the net income from the 5,000 queens was not over \$750. That's quite different from \$5,000, that Mrs. M. Louise Thomas reported. But we want the names of the "two women who have incomes of \$5,000 each, annually, selling queens." We want to give them a big, free advertisement.

MR. E. WHITCOMB, of Friend, Nebr.—our big-hearted bee-brother—we learn is being proposed for State Senator. With a few men like him in the Nebraska Legislature, bee-keeping would stand a good chance to get a hearing there. We often think that if some of our grand bee-keepers had an opportunity to help make the laws of the land there would soon be a big improvement in many directions. Some time we hope the conscienceless politicians will be elected to stay at home, and the sensible, righteous and incorruptible sons of toil sent to the legislative halls.

MR. T. P. EVANS, of Little Cedar, Iowa, writes: "The American Bee Journal is No. 1. Everything in it is good. Any one keeping but one colony of bees should take it. He would gain twice the amount of its cost."

DR. MILLER, when writing to us on June 9, said:

"Oh, but the bees are piling in the honey! A number of my colonies have the second super, and other years at this date supers were not yet needed. Everything seems favorable for a good year."

That's good. If there is any one among all the thousands that we would like to see get a big crop of honey this year, it is Dr. Miller. Two years ago he had to feed \$75 worth of sugar to get his bees through the winter, and last year he again got no honey, though the bees did gather plenty last fall for the winter. We think he could stand an average of say 100 pounds of comb honey per colony this year.

THE ROOT FAMILY AND ANCESTORS were gone into at some length in Gleanings for June 1. It seems some one of the family, in order to "get at the Root of the matter," published a book of 533 pages, giving the Root genealogy. One sentence in that big book reads thus:

"The whole line have been characterized for shrewdness, and noted especially for a strong anti-humbugativeness."

Some of them are also noted for their "honey-bugativeness," too, though we are not informed whether the book said so or not. We have never been much interested in genealogies, though to some people they are very fascinating.

Honey as Food and Medicine.—A new and revised edition of this 32-page pamphlet is now issued. It has 5 blank pages on which to write or paste recipes taken from other sources. It is just what its name indicates, and should be liberally distributed among the people everywhere to create a demand for honey. It contains a number of recipes on the use of honey as food and as medicine, besides much other interesting and valuable information. Prices, postpaid, are: Single copy, 5 cts.; 10 copies 30 cts.; 50 for \$1.00; 100 for \$1.75. Better give them a trial. Send all orders to the Bee Journal office.

General Items.

Some "Learned" (?) Bee-Notes.

The season is somewhat advanced, and most of the "big guns" among the bee-writers have exploded. To be sure, some of them have gone off on the half-cock; however, they have made about as much smoke and gas as they otherwise would. New and luminous lights are springing up in the ranks of the honest and virtuous bee-keepers and extracted honey-producers; with little or no glucose in the samples. One of these bright and shining lights would "sit down" on all one-horse bee-keepers and freeze them out with ignorance, by running up the price of bee-papers to \$10 and onward. This benevolent and kind-hearted gentleman would make a sweet and juicy missionary to the cannibal islands; he has the right spirit and plenty of gall, and if he is fat, he would be acceptable.

The season here is good and promising. The fruit-bloom was immense, and the weather favorable for the bees. If the few bee-keepers hereabouts do not spend more than half their time in fussing with their bees, killing queens and introducing others not half as good, and puffing in smoke every day, and lifting out the frames, and changing ends, and tormenting the bees with division-boards and queen-excluders, and turning the hive to the right, and the left, and rear, and dividing the colonies, and then uniting them again, and tracing up the pedigree of the great and only white-headed drone ever known, and pumping out un-ripe nectar together with young bees and grub-gravy, and bottling it up and labeling it "pure extracted honey from the apiary of John Do Lack Sense"—it is possible that a few pounds of comb honey may be obtained in the fall, otherwise a sweet substitute can be made with sugar syrup boiled with empty comb and a drop of mint oil and two drops of glucose to smooth it up. This stuff cannot be known from the extracted honey on the market after it has passed through the hands of the honest retailers, and is good enough for the pancake harvest. Great are the wonders of modern bee-scientists!

C. W. LEARNED.

Dearborn, Mich., June 3.

Losses in Winter. Etc.

I commenced with 5 colonies of bees. I have devoted most of my time in this pursuit since that time. I have at present 34 colonies, having lost three the past winter—one by diarrhea and two by starvation, although there was plenty of honey in the hive. Last year I got no honey. The past six years have been rather poor years, save one, but last year was a tough one. When I saw bass-wood fail I took off all surplus arrangements and commenced feeding for dear life. I said, "Dead bees or sugar. I choose the latter."

I asked a neighbor, who had 18 or 20 colonies, "How are your bees faring?" This was in September. "O I do not know," was the reply. I said to myself, "Dead bees next spring." He wintered them in a very nice cellar, and has not a live bee to-day.

I put my bees in outside cases on Oct. 3, and on Jan. 9 I put in the packing of

THE "NOVELTY" POCKET-KNIFE!

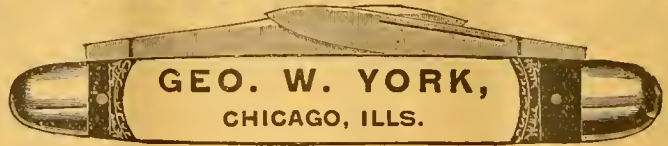

Your Name on the Knife.—When ordering, be sure to say just what Name and Address you wish put on the Knife.

The NOVELTY KNIFE is indeed a novelty. The novelty lies in the handle. It is made beautifully of indestructible celluloid, which is as transparent as glass. Underneath the celluloid, on one side of the handle is placed an AMERICAN BEE JOURNAL reminder, and on the other side, name and residence of the Subscriber.

The material entering into this celebrated knife is of the very best quality; the blades are handforged out of the very finest English razor-steel, and we warrant every blade. The bolsters are made of German silver, and will never rust or corrode. The rivets are hardened German silver wire; the linings are plate brass; the back springs of Sheffield spring steel, and the finish of handle as described above. It will last a lifetime, with proper usage.

Why purchase the Novelty Knife? In case a good knife is lost, the chances are, the owner will never recover it; but if the Novelty is lost, having name and address of owner, the finder will return it; otherwise to try to destroy the name and address, would destroy the knife. If traveling, and you meet with a serious accident, and are so fortunate as to have one of the Novelties, your pocket KNIFE will serve as an identifier; and in case of death, your relatives will at once be apprised of the accident.

How appropriate this knife is for a Christmas, New Year or birthday present! What more lasting memento could a mother give to a son, a wife to a husband, a sister to a brother, a lady to a gentleman, or vice versa, a son to a mother, a husband to a wife, a brother to a sister or a gentleman to a lady—the knife having the name of the recipient on one side?

The accompanying cut gives a faint idea, but cannot fully convey an exact representation of this beautiful knife, as the "Novelty" must be seen to be appreciated.

How to Get this Valuable Knife.—We send it postpaid, for \$1.00, or give it as a Premium to the one sending us three new Subscribers to the BEE JOURNAL (with \$3.00), and we will also send to each new name a copy of the Premium Edition of the book "Bees and Honey." We club the Novelty Knife with the BEE JOURNAL for one year, both for \$1.90.

Any Name and Address Put on the Knife.

GEORGE W. YORK & CO.,
CHICAGO, ILLS.

Allow about two weeks for your order to be filled.

PATENT WIRED COMB FOUNDATION

Has No Sag in Brood-Frames

Thin Flat-Bottom Foundation

Has No Fishbone in the Surplus Honey.

Being the cleanest is usually worked the quickest of any Foundation made

J. VAN DEUSEN & SONS,

Sole Manufacturers,
Sprout Brook, Montgomery Co., N. Y.

Mention the American Bee Journal



ONE MAN WITH THE UNION COMBINATION SAW

Can do the work of four men using hand tools, in Rippling, Cutting-off, Mitting, Rabbeting, Grooving, Gaining, Dadoing, Edging-up, Jointing Stuff, etc. Full Line of Pent and Hand Power Machinery Sold on Trial, catalogue free.

46 Water St., SENECA FALLS, N. Y.
1Aly Mention the American Bee Journal.

Dadant's Foundation in Chicago!

No other Goods kept here.

Send for Price-List.

CHAS. DADANT & SON,
118 Michigan St., CHICAGO, ILL.
13A1f Please mention the Bee Journal.

3-Frame Nucleus

and Italian Queen, after July 1st, \$2.50.

Untested Queens, 75c each.

Discount on quantities.

A Catalogue of Practical Apian Supplies, Free. Address,

I. J. STRINGHAM,
105 Park Place. NEW YORK, N. Y.

That Queen-Clipping Device Free!

Works Like a Charm.

The Monette Queen Clipping Device WORKS LIKE A CHARM. With it I have clipped 30 queens, all in one day, when examining my bees. WM. STOLLEY, Grand Island, Nebr.

Couldn't Do Without It.

I have clipped 19 queens, and must say the Monette Queen-Clipping Device is by far the best invention ever made, and will be welcome to many bee-keepers as it was to me. I could not do without one now.

DR. GEO. LACKE, Newburgh, Ind.

PLEASE READ THIS OFFER TO PRESENT SUBSCRIBERS:

Send us just one new name for the American Bee Journal a year (with \$1.00), and we will mail you the Queen-Clipping Device FREE of charge. Or, the Queen-Clipping Device will be sent postpaid for 50 cts. But why not get it as a Premium by the above offer? You can't earn 50 cts. any easier. Almost every bee-keeper will want this Device. See page 130 (Feb. 27) for full description of it. Complete directions accompany each one sent out. It is a most ingenious and useful article. Address,

GEORGE W. YORK & CO., 118 Michigan St., Chicago, Ill.

✦ MONEY SAVED IS MONEY GAINED. ✦

THE ROYAL UNION Life Insurance Company

DES MOINES, IOWA.

The Iowa Policy

Is one that definitely promises to keep an accurate account with you; credit your premiums and interest, charge the actual expense and mortuary cost, and hold the remaining funds subject to your order.

Agents Wanted.
JOHN B. KING, GENERAL AGENT,
Suite 513 First Nat'l Bank Bld'g,
20Atf **CHICAGO, ILL.**
Mention the American Bee Journal.

WARRANTED GOLDEN ITALIAN QUEENS By return mail; bred from a Breeder tested by DoLittle out of 1,000 Queens for his own use, and valued at \$50. Queens, 50c; 6 for \$2.75; or \$5.00 per dozen.

Leather Colored Queens from Root's best imported stock same price. Bees from my Queens are excellent workers on red clover. I guarantee safe delivery. N. B.—I sent more than 200 Queens safely to California last season. **H. G. QUIRIN, Bellevue, Ohio.**
23A16 *Mention the American Bee Journal.*

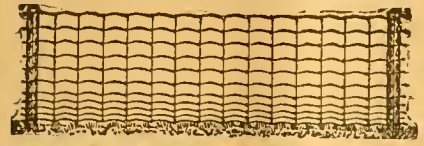

"OVER THE FENCE IS OUT"

This rule was unquestioned in the days when "two old cat" was the favorite ball game. Applying the same rule to farm stock, we raised the standard height to five feet. **Through the fence is as bad as over.** So with abundant ELASTICITY and double strength wire, we "shut them out" (or in) and rule the world on fence.

PAGE WOVEN WIRE FENCE CO., Adrian, Mich.
WHEN ANSWERING THIS ADVERTISEMENT, MENTION THIS JOURNAL.

IF YOU WANT THE BEE-BOOK

That covers the whole Apicultural Field more completely than any other published, send \$1.25 to Prof. A. J. Cook, Claremont, Calif., for his

Bee-Keeper's Guide.

Liberal Discounts to the Trade.

California

If you care to know of its Fruits, Flowers Climate or Resources, send for a Sample Copy of California's Favorite Paper—

The Pacific Rural Press

The leading Horticultural and Agricultural paper of the Pacific Coast. Published weekly, handsomely illustrated, \$2.00 per annum. Sample Copy Free.

PACIFIC RURAL PRESS,
220 Market St., - SAN FRANCISCO, CAL.

TEXAS QUEENS.

If you are in need of Queens, let me have your order. Price-List Free.

8A26t **J. D. GIVENS, Lisbon, Tex.**
Mention the American Bee Journal.

Full Colonies of Italian Bees for \$4.00. For particulars see larger ad. on page 350 of this paper. **Tested Queens,** after June 10th, 75 cts. each; 2 for \$1.25.

Address: **T. H. KLOER,**
426 Willow St., **TERRE HAUTE, IND.**
23A4t *Mention the American Bee Journal.*

chaff, having put on Hill's device and other arrangements. When put in the boxes with two burlap quilts, a place was cut in the first quilt for upward ventilation, and a surplus box filled partly full of chaff. In February I put a little more in it—would you believe it?—the dampness came up through that hole!

Then twice or three times I quietly removed the wet chaff. They wintered nicely. I kept the entrances clear of snow—some times 1½ inches open, then 4 inches, and again 6 inches. I watched the mercury and the weather sharply. I never had bees come through in better condition.

Another bee-keeper in the city took his bees out of the cellar the first of March, and packed them; he lost 16 colonies. Another over the river from the city, wintered his bees in the cellar, or a large cave, and lost 18 colonies. He put in some 60 or 70 colonies, I think. I know of but two colonies left in our neighborhood.

We have had a glorious fruit-bloom—calm and quiet weather, with plenty of nectar in the blossoms, and we are now having beautiful rains. Clover is in bloom; basswood bids to bloom splendidly. How things may go the next six weeks time will tell, but the cloud that hung over us last year seems now to have a silver lining.

Now, all those that I have mentioned, and others who have lost a good many bees, I have asked them time and time again to take the "old reliable" American Bee Journal, but no. I tell you, I have learned many good lessons from it, besides the leading works that I have a good supply of. We must read and inform ourselves as young bee-keepers, and as the farmers said when their hay was short, and the young seeding all burnt up last year, "We must sow plenty of seed next year;" and as they had to feed stock to get them through the winter, so in like manner I fed the bees. You see I have the bee on the brain, and I am going to "try, try again." I still use my own feeder, and it works like a charm; no drowning of bees, nor lifting quilts when I feed, but sometimes I feed in the comb.

JACOB MOORE.

Ionia, Mich., June 1.

Has Many Things to Learn.

I bought one colony of bees last May (1895), which is all I have—no increase. They came through the winter in fine condition. I fed them some syrup this spring. I have them in the old-fashioned straight box-hive, so I have no way of knowing how much honey they have, but I think the hive must be about full. The bee-business is not entirely new to me, but I had, and still have, a great many things to learn, and of course I do not intend to do without the American Bee Journal. **MRS. E. R. TOMLINSON.**
Alexander, Ark., June 2.

Killing Off the Drones, Etc.

Our bees have killed off the drones during the past 10 days, and they are working some on ripe strawberries, which indicates that there is no honey to be had. I am satisfied that the days of bee-keeping here are numbered, as there is not an acre of land that is not either cultivated or pastured, and such land, aside from fruit-bloom, never produces

1,000 Teachers' Oxford Bibles

Were bought for spot cash by a Chicago firm from an Eastern publisher who was about to



be driven to the wall for the want of ready money. More than a million of these same Bibles, in every way like the illustration, have been sold during the past few years at three times the money we ask for them.

They are the genuine Teachers' Oxford Bibles, Divinity Circuit, round corners, gilt edges, complete teachers' helps, maps, 1,350 pages, bound in French seal limp, with perfectly flexible backs. Sent prepaid.

Regular price, \$4.50; our price, \$2.25. Or we club it with the Bee Journal for one year—both for only \$2.75; or we will give this fine Bible free as a premium to any one sending 4 new subscribers to the Bee Journal one year (with \$1.00). No additional premium is given the new subscribers—simply the Bee Journal one year to each of them.

GEORGE W. YORK & CO.,
- CHICAGO, ILLS.

BEGINNERS.

Beginners should have a copy of the Amateur Bee-Keeper, a 70-page book by Prof. J. W. Rouse. Price 25 cents; if sent by mail, 28c. The little book and the Progressive Bee-Keeper (a live, progressive 28-page monthly journal) one year, 65c. Address any first-class dealer, or

LEAHY MFG. CO., Higginsville, Mo.

Mention the American Bee Journal.

For Sale HOME, APIARY, —QUEENS.—

½ Block of ground, some fruit, good 6-room dwelling, shop, stable, honey-house and poultry-house (over 3,000 square feet of floor), 100 colonies of bees in chaff hives and fully equipped for comb honey, all in town of 1000 population and good alfalfa range and good water. Price, \$3,000. If unsold June 15th, will unqueen, and offer 2 year clipped queens at 25c.; 1 year, unclipped, at 50c. each. July 15th and after, young queens at 60c. each—all Italian and safe arrival guaranteed. This is a rare bargain, but I must get my wife to a lower altitude. Book your orders at once if you want these queens.

19Atf **R. C. AIKIN, Loveland, Colo.**
WHEN ANSWERING THIS ADVERTISEMENT, MENTION THIS JOURNAL.

\$3.00 Worth for \$2.00 !

Until further notice, we propose to give you a chance to get some good reading-matter for the long winter evenings, at half price.

Send us \$2.00, and we will mail you your choice of \$2.00 worth of the following book-lets, and also ere lit your subscription to the American Bee Journal for one year:

- Poultry for Market and Profit..... 25c
- Our Poultry Doctor..... 30c
- Turkeys for Market and Profit..... 25c
- Capons and Caponizing..... 30c
- Rural Life..... 25c
- Preparation of Honey for the Market..... 10c
- Bee-Pasturage a Necessity..... 10c
- Hive I Use, by Doolittle..... 5c
- Foul Brood, by Dr. Howard..... 25c
- Foul Brood, by Kohnke..... 25c
- Foul Brood, by Cheshire..... 10c
- Bee-Keeping for Profit, by Dr. Tinker..... 25c
- Kendall's Horse-Book—Eng. or German..... 25c
- Silo and Silage, by Prof. Cook..... 25c
- Hand-Book of Health, by Dr. Foote..... 35c
- Maple Sugar and the Sugar Bush..... 40c
- Potato Culture, by Terry..... 40c
- Carp Culture, by Root & Finney..... 40c
- Strawberry Culture, by Terry & Root..... 40c
- Blenn Kultur, by Newman [German]..... 40c
- Winter Problem in Bee-Keeping [Pierce]..... 50c
- Bee-Keepers' Directory, by Henry Alley..... 50c
- Advanced Bee-Culture, by Hutchinsonson..... 50c
- 5 Honey as Food and Medicine..... 25c

GEORGE W. YORK & CO.,
CHICAGO, ILLS.

The Bee-Keepers' Guide:

Or Manual of the Apiary,

By Prof. A. J. Cook.

This 15th and latest edition of Prof. Cook's magnificent book of 460 pages, in neat and substantial cloth binding, we propose to give away to our present subscribers, for the work of getting new subscribers for the American Bee Journal.

A description of the book here is quite unnecessary—it is simply the most complete scientific and practical bee-book published to-day. Fully illustrated, and all written in the most fascinating style. The author is also too well-known to the whole bee-world to require any introduction. No bee-keeper is fully equipped, or his library complete, without "THE BEE-KEEPER'S GUIDE."

Given For 2 New Subscribers.

The following offer is made to PRESENT subscribers only, and no premium is also given to the two new subscribers—simply the Bee Journal for one year:

Send us Two New Subscribers to the Bee Journal (with \$2.00), and we will mail you a copy of Prof. Cook's book FREE as a premium. Prof. Cook's book alone sent for \$1.25, or we club it with the Bee Journal for a year—both together for only \$1.75. But surely anybody can get only 2 new subscribers to the Bee Journal for a year, and thus get the book as a premium. Let everybody try for it. Will you have one?

GEORGE W. YORK & CO.,
CHICAGO, ILLS.

A Bargain—EARLY QUEENS.

119 Colonies Italian Bees in Chaff Hives: two acres land; good house; excellent well.

Early Queens—Tested, \$1.00; Untested, 50c. Sent by return mail.

E. L. CARRINGTON,
16A St. PETTUS, Bee Co., TEX.
Reference—1st National Bank of Beville.

Mention the American Bee Journal.

CARLOADS



Of Bee-Hives, Sections, Shipping-Cases, Comb Foundation, and Everything used in the Bee-Industry.

I want the name and address of every Bee-keeper in America. No reason why you cannot do business with me. I have Cheap Lumber and Experienced Workmen; a good Water-Power Factory and know how to run it. I am supplying Dealers as well as consumers. Why not you? Send for Catalogues, Quotations, etc. W. H. PUTNAM,
18 RIVER FALLS, Pierce Co., Wis.

Mention the American Bee Journal.

Page & Lyon Mfg. Co.,

NEW LONDON, Wis., operates two saw-mills that cut, annually, eight million feet of lumber, thus securing the best lumber at the lowest price for the manufacture of bee-keepers' supplies. They have also just completed one of

The Largest Factories,

and have the latest and most improved machinery for the manufacture of Bee-Hives, Sections, etc., that there is in the State. The material is cut from patterns, by machinery, and is absolutely accurate. For Sections, the clearest and

The Whitest Basswood

is used, and they are polished on both sides. Nearness to pine and basswood forests, and possession of mills and factory equipped with best machinery, all combine to enable this firm to furnish the best goods at

The Lowest Prices. ♡

For instance, it has a job lot of 200,000 No. 2 Sections that will be sold at 50 cts. per 1,000; or 2,000 Snow-White Sections will be sold for \$4.00, and larger quantities at still lower prices. Send for Circular and see the prices on a full line of supplies. 16A St.

Mention the American Bee Journal.

any honey. We have several basswood trees that are hanging full of clusters of bloom that will be opened in a few days, but we get honey from that source only about once in five years. Our bees are strong in numbers, and with their drones killed off, they are in splendid condition to take advantage of the basswood, provided there is any honey in the bloom.

We have considerable white clover, but our bees have not worked on it to any extent for over 10 years; as a honey-producing plant it has got to be a failure with us.

Altogether, the outlook for bee-keeping is dismal, indeed. Our bees have died off, from one cause or another, until there is not more than 10 per cent. of them remaining. The most extensive bee-keeper in the county told me a day or two ago that his losses in the past three years had reduced his colonies to 20 per cent. of the original number, and that at present there was not an average of one pound of honey in each hive; that he has had no surplus honey in three years, and doesn't expect any this season, or in the seasons to follow. The woodman's axe has cleaned up all the timberland, and it has become set in blue grass, and is pastured. No young trees are allowed to grow up, and there are no wild flowers to furnish honey. When the present growth of trees are cut off there will be none to take its place, and wood will be a scarce article. Land that is worth from \$60 to \$100 per acre is too valuable to be allowed to go without making immediate returns, hence it must be either cultivated or else pastured. W. S. FULTZ.

Muscatine, Iowa, June 8.

No Nectar in the Blossoms.

We have had more rain so far this year than for the past two years put together. It seems we had so much rain that there was no nectar in the blossoms all spring. I have about 30 locust trees that were just as full of bloom as could be, but never could I see a bee on or near them. In May, 1894, they were in full bloom, and the bees just swarmed on them, and one could smell the aroma all over the place, but it lasted only one or two days, then a heavy frost killed them. Last year they didn't bloom at all. This year one could not smell the aroma if he held the blossom right up to his nose, because there was no nectar in it.

I have fed my bees all spring, and haven't stopped yet. I live about 6 miles north of Kearney. I have alfalfa in bloom, but I fail to see my bees go near it. On the outskirts of Kearney there is quite a lot of alfalfa, and the bees there are doing finely, and seem to be getting all their honey from alfalfa. I have one acre of sweet clover that is budding now, and I expect it will bloom in a few days, and if they don't get anything from that I will have to wait till the buckwheat blooms. J. C. KNOLL.

Kearney, Nebr., June 8.

Alfalfa and Sweet Clover Honey.

One member of the Denver Bee-Keepers' Association, who has handled as much honey as any one in Colorado, said he never had any comb honey candy before Jan. 1. He has done much shipping, and heard no complaints. In some seasons it candies sooner than in others.

No. 1 Sections—Cheap.

We offer for a few weeks, a surplus stock of our one-piece No. 1 Cream Sections at the following very low prices:

1000 for \$1.50.

3000 for \$4.00.

5000 for \$6.00.

These Sections are finely finished and No. 1 in all respects save color, being, as their name indicates, of a cream color.

The stock consists of a quantity each of the following sizes:

4½x2, open 2 sides 4¼x1 15-16, open 2 sides
4¼x1 7-8, open 2 sides
4¼x1½, open 2 sides 4¼x7-to-ft., open 2 sides

G. B. LEWIS CO.

WATERTOWN, WIS.

Mention the American Bee Journal.

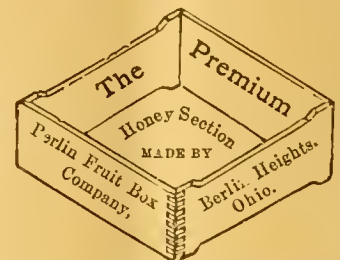

—BEE-SUPPLIES—
and all kinds of Boxes, Berry-Crates, and Baskets. We make a specialty of 1-piece Sections & Wood Separators.

Address, BERLIN FRUIT-BOX CO.,
20A St. BERLIN HEIGHTS, OHIO.

Mention the American Bee Journal.

\$525 Agent's profits per month. Will prove it or pay forfeit. New articles just out. A \$1.50 sample and terms free. Try us. 22A St. CHIDESTER & SON, 28 Bond St., N. Y.

WHEN ANSWERING THIS ADVERTISEMENT, MENTION THIS JOURNAL.

Hives & Combs For Sale.

45 10-frame Langstroth Hives, two-story, for extracting, as made and sold by T. G. Newman. These are empty—no frames—are well painted, and have been kept in the bee-house. Price, 75 cents each.

Also, 400 Brood or Extracting Combs for the above hives; they have the triangular top-bar as made by Newman. They are clean and in good condition. Price, \$15.00 per 100. I would take \$85.00 for the whole lot of Hives and Combs.

Reference—American Bee Journal.

W. C. LYMAN,
21A St. DOWNER'S GROVE, ILL.

MUTH'S HONEY EXTRACTOR

PERFECTION
Cold-Blast Smokers,

Square Glass Honey Jars, Etc.

For Circulars, apply to CHAS. F. MUTH & SON, Cor. Freeman & Central Aves., Cincinnati, O. Send 10c for Practical Hints to Bee-Keepers.

Mention the American Bee Journal.

Beautiful Golden Queens From Kan.

Let me tell you why my Golden Italians are better for comb honey than the 3-banders. Simply this—they cap their honey white like the blacks, and are splendid workers.

1 Untested Queen, 75 cents or 3 for \$2.00	
1 Tested Queen, \$1.00	Breeders 2.50
1 Breeder which I have bred from and found to be the best	4.00
1 Frame Nuclei with Queen	1.75
2 " " "	2.25
3 " " "	2.75

All orders filled promptly. Safe delivery guaranteed. P. J. THOMAS,
22A St. FREDONIA, KAN.

Mention the American Bee Journal.

READERS Of this Journal who write to any of our advertisers, either in ordering, or asking about the Goods offered, will please state that they saw the Advertisement in this paper.

Honey-Clovers & Buckwheat SEED FOR SALE.

We have made arrangements so that we can furnish seed of several of the Clovers and Japanese Buckwheat, by freight or express, at the following prices, cash with order:

	5lb	10lb	25lb	50lb
Alsike Clover	\$.70	\$1.25	\$3.00	\$ 5.75
Sweet Clover	.75	1.40	3.25	6.00
White Clover	1.25	2.00	4.50	8.00
Alfalfa Clover	.65	1.10	2.70	5.00
Crimson Clover	.55	.90	2.00	3.50
Jap. Buckwheat	.20	.35	.90	1.25

Prices subject to market changes.

Add 25 cents to your order, for cartage, if wanted by freight.

Your orders are solicited.

GEORGE W. YORK & CO.,
CHICAGO, ILLS.

Sweet Clover & Canada.

At the following prices:

5 lbs.	10 lbs.	25 lbs.	50 lbs.
\$1.00	\$1.60	\$3.75	\$7.25.

Also a quantity of Motherwort and Catnip seed. Prices on application.

EGGS for Hatching. Buff Leghorns, Indian Games, & Light Brahmas. Choice Birds. A breeder for 30 years. Prices on application

JOHN MCARTHUR,

881 Yonge Street, - TORONTO, ONT.
15Atf *Mention the American Bee Journal.*



Promptness Is What Counts!

Honey-Jars, Shipping-Cases, and everything that bee-keepers use. **Root's Goods at Root's Prices,** and the best shipping point in the country. Dealer in Honey and Beeswax. Catalogue Free.

Walter S. Ponder
162 Mass. Ave.
INDIANAPOLIS, IND.

Mention the American Bee Journal.

Queens for Sale

Italian Queens—after May 15—Untested, 75c. each; 6 for \$4.00; 12 for \$7.20.

Safe arrival and satisfaction guaranteed.

Reference—George W. York & Co. Address.

F. GRABBE,
LIBERTYVILLE, ILL.,

Mention the American Bee Journal.

HONEY We have a large amount of Pure No. 1 Alfalfa we will sell cheap.

Wax Wanted.

Boss bee-escape Warranted the best, simplest and quickest Escape on the market. Sent postpaid to any address for 30 cts. It can be returned at our expense if it is not as represented, or we will send the Escape on trial to any bee-keeper wishing to test it in good faith. We are agents for the **Ferguson Patent Hive** with double-case Super and Wicket-Gate Honey-Board, with the Escape. It is the easiest, quickest hive to handle for the production of comb honey. Address,

E. S. LOVESY & CO.,

355 6th East St., SALT LAKE CITY, UTAH.
Mention the American Bee Journal. 9Atf

Sections Foundation Cheap

Send for prices. **J. F. MICHAEL,**

24A2t GREENVILLE, O.

For Sale Having disposed of most of my Bees, I will sell about 150 Simplicity Combs for extracting, at \$10 per hundred. All in good condition. Would like a few good Queens in exchange for Queen Excluders, standard size. Address,

C. A. MEADE, Brookside, Mich.

READERS Of this Journal who write to any of our advertisers, either in ordering, or asking about the Goods offered, will please state that they saw the Advertisement in this paper.

It should be shipped anyhow before the weather is cold enough to break the combs. If sealed, there will be no trouble from candying; though he had unsealed honey for three years without candying.

Another member said that in 1893 he did not sell until March, and out of 6,000 pounds only two cases were candied. If any Utah comb honey candies quickly, he suggested it is because of the abundance of sweet clover there. The opinion of the Association was that Oct. 26 is not too late to sell alfalfa comb honey.

I have the impression of having read somewhere that pure sweet clover honey does not candy readily. However that may be, an extensive honey-producer told me in conversation some time ago that whether from sweet clover or other fall flowers, late honey here was more apt to candy than that from the first crop. He could recall no instance of early comb honey candying soon, and gave a case in which a large amount was sold after being kept over a year without candying.

So far, there is no evidence whatever to show that the sale of the bulk of alfalfa comb honey need be at all injured on Oct. 26. Extracted alfalfa honey, on the other hand, candies quickly, especially the late honey.

Arvada, Colo. F. L. THOMPSON.

Bees Have Not Done Much.

My bees have not done much thus far. Two weeks ago I had to feed them to keep them from starving. I lost one colony this spring, I believe from starvation. Lots of bees died in this part of the country this spring, for want of food. Willows bloomed the latter part of January and first part of February, but a heavy frost killed it all. During fruit-bloom it was too rainy for the bees to gather any honey.

AUG. BACHMANN.

Seattle, Wash., June 2.

The Bee and Grape Question.

I suppose Mr. W. S. Fultz (see page 291) will admit that there are lots of different people, and their observations and opinions on the same subjects will differ very much some times. You want to give the devil his just dues if he does a neat job.

Mr. Fultz says he has seen the bee drive the pickers out of the berry patch. A sister of mine was once stung on the knee, and her leg from the hip to the foot was black and blue, swollen, and very painful for six weeks. I believe that she would stampe if there were one dozen bees in sight if she were picking. Were his pickers on that order? I have had the bees work on grapes—the Ives and Concord. I never saw them work on berries. My observation on the grape was that when they did so work, the grapes were too ripe to be in good marketable condition. A good horticulturist will not let his Bartlett pears get soft-ripe on the tree. Is there not a proper time to pick grapes? I think there is a bare possibility that under certain conditions fungus growth will weaken the skin of fruit enough to give the bee a start; that is all it wants, and it is soon on the inside. A fly will suck itself full of blood through a cowhide, and you cannot see the opening before



BINGHAM SMOKERS
Best on Earth and Cheapest.
Doctor, 3½-in. stove, by mail, \$1.50; Conqueror, 3-in., \$1.10; Large, 2½. \$1; Plain, 2. 70c; Little Wonder, 2, wt 10 oz, 60c
Bingham & Hetherington
Honey-Knives, 80 cents.
T. F. BINGHAM,
23Dtf Farwell, Mich.

Sections & Foundation Reduced.

I am now selling Root's best polished **SECTIONS** at \$2.50 per 1,000; 2,000 for \$4.50; 3,000, \$6.45; 5,000, \$10.00. **The New Weed Process Comb Foundation** reduced 3c. per pound. See prices on page 14 of our Catalogue, or The A. I. Root Co.'s.

M. H. HUNT,

19D4t BELL BRANCH, MICH.
Mention the American Bee Journal.

1880 Special Offer. 1896

Warranted Queens, bred from best imported or home-bred Queens, at 60 cts. each; ¼ doz., \$3.50. Untested, 55 cts.; ½ doz., \$3.15. Tested, 70 cts.; ½ doz., \$4.00. All Queens sent promptly by return mail.

LEININGER BROS.,
FT. JENNINGS, OHIO.

25Dtf *Mention the American Bee Journal.*



Bee Supplies

Largest Stock and Greatest Variety in the West. **BEST** Goods at **LOWEST** prices. Cat. of 80 pages FREE.

E. KRETZMER, RED OAK, IOWA.

Mention the American Bee Journal. 23D9t

Warranted Queens

BY RETURN MAIL.

Either **Golden** or **Leather-Colored**, at \$5.00 per doz. Choice Tested Queens at \$1.00 each. I guarantee safe delivery.

F. A. CROWELL, Granger, Minn.

25A6t *Mention the American Bee Journal.*

Down Go the Prices!

I am having such good luck in queen-rearing, I shall the balance of the season sell our fine **ADEL QUEENS** at the following prices—One Queen, \$1.00; three, \$2.50; six, \$4.50; or one dozen for \$8.00. Safe arrival and quality guaranteed. Cat. free.

HENRY ALLEY,

25Atf WENHAM, Essex Co., MASS.

5 per ct. Off to Reduce Stock

on all kinds of **SUPPLIES.**

—COMB FOUNDATION—

which will be sold in lots of 10 lbs, or more as follows: Medium, 38 cts.; Light, 40 cts.; Thin Surplus, 45 cts.; Extra Thin, 50 cts.

Queens—Untested, 75c.; Tested, \$1.00.

W. J. FINCH, Jr., SPRINGFIELD ILLS.

Mention the American Bee Journal.

Bee-Keepers' Photograph.—We have now on hand a limited number of excellent photographs of prominent bee-keepers—a number of pictures on one card. The likeness of 49 of them are shown on one of the photographs, and 121 on the other. We will send them, postpaid, for 30 cents each, mailing from the 121 kind first; then after they are all gone, we will send the 49 kind. So those who order first will get the most "faces" for their money. Send orders to the Bee Journal office.

or after with the naked eye. A good horticulturist has lots of points to look to, and does not always find time to give to thorough investigation that it requires. I am not a millionaire, and I am trying to bring up a family of five, the oldest not 10 years old, and I do not find time to satisfy my curiosity as I would like. H. KLOTH.
Blanchester, Ohio, May 28.

The Season in Orange Co., Calif.

Mr. Oderlin started in with 250 colonies of bees in good condition, and I may say all colonies throughout Southern California were in splendid condition in the spring. February and March were warm and pleasant, but April and the first part of May were uniformly cooler than I have seen it since coming to the State, some 16 years ago. Well, Mr. Oderlin has taken out 92 cans of honey (60 pounds each), one ton of that being new honey of this season's gathering. He has had 45 new swarms, all of which he put back except some seven of them. His bees are at this date in splendid condition, and still gathering more than they consume. But there will be no more extracting this season. He has not had to feed any, but had he not put back his new swarms, both the old colonies and the new swarms would have had to be fed heavily.

His bees are in two apiaries, and located in the foot-hills, not at a high altitude. There has been an abundance of bloom, but so cool that there was no nectar secreted.

Mr. Harding, located at an elevation of about 1,300 feet, at the head of Santiago canyon, says there was a frost, or freeze, night after night, and the wind so cool that bees could leave their hives only a short time in the middle of the day. There was an abundance of bloom, but no nectar. Many bee-keepers are having to feed heavily. Still, I cannot help believing if all bee-keepers had left their supers full of sealed honey from last season, and then put back all swarms, or prevented swarming in any manner, their bees would be self-sustaining in any season that I have ever seen in this State. We can calculate in advance almost invariably what the prospect is ahead, by the amount of rain in winter.

I do not hear of any one that beats Mr. Oderlin. DR. E. GALLUP.
Santa Ana, Calif., June 4.

Queens and Queen-Rearing.

If you want to know how to have queens fertilized in upper stories while the old queen is still laying below; how you may safely introduce any queen, at any time of the year when bees can fly; all about the different races of bees; all about shipping queens, queen-cages, candy for queen-cages, etc.; all about forming nuclei, multiplying or uniting bees, or weak colonies, etc.; or, in fact, everything about the queen-business which you may want to know—send for Doolittle's "Scientific Queen-Rearing"—a book of over 170 pages, which is as interesting as a story. Here are some good offers of this book:

Bound in cloth, postpaid, \$1.00; or clubbed with the BEE JOURNAL for one year—both for only \$1.75; or given free as a premium for sending us three new subscribers to the BEE JOURNAL for a year at \$1.00 each.



BEE JOURNAL
PUBLISHED WEEKLY BY
GEORGE W. YORK & CO.,

At One Dollar a Year,

56 Fifth Avenue, CHICAGO, ILLS.

Postage to all Countries in the Postal Union is 50 cents extra. To all others, \$1.00 more than the subscription price.

Hebblewhite & Co., 369 George Street, Sydney, New South Wales, Australia, are our authorized agents. Subscription price, 6 shillings per annum, postpaid.

Important to All Subscribers.

The American Bee Journal is sent to subscribers until an order is received by the publishers for its discontinuance, and all arrearages are paid.

Always State the Post-Office to which your paper is addressed, when writing to us.

A Sample Copy of the Bee Journal will be sent FREE upon application.

How to Send Money.—Remit by Express, Post-Office Money Order, or Bank Draft on New York or Chicago. If none of these can be had, Register your Letter, affixing Stamps both for postage and registry, and take a receipt for it. Money sent thus, IS AT OUR RISK; otherwise it is not. Do not send Checks on Local Banks—we have to pay 25 cents each, to get them cashed.

Never Send Silver in letters. It will wear holes in the envelope, or may be stolen.

Money Orders.—Make all Money Orders payable at Chicago, Ill.—not at any sub-station of Chicago.

Postage Stamps of any denomination may be sent for any fraction of a dollar; or where Money Orders cannot be obtained, stamps for any amount may be sent.

Subscription Credits.—The receipt for money sent us will be given on the address-label of every paper. The subscription is paid to the end of the month indicated.

Do Not Write anything for publication on the same sheet of paper with business matters, unless it can be torn apart without interfering with either part of the letter.

Lost Numbers.—We carefully mail the Bee Journal to every subscriber, but should any be lost in the mails, we will replace them if notified before all the edition is exhausted. Please don't wait a month or two, for then it may be too late to get another copy.

Emerson Binders, made especially for the American Bee Journal, are convenient for preserving each weekly Number, as fast as received. They will be sent, postpaid, for 75 cents, or clubbed with the American Bee Journal for one year—both together for \$1.60. They cannot be sent by mail to Canada.

Please Send Us the Names of your neighbors who keep bees, and we will send them sample copies of the BEE JOURNAL. Then please call upon them and get them to subscribe with you, and secure some of the premiums we offer.

Bee-Keeper's Guide—see page 396.

Question-Box.

In the multitude of counsellors there is safety.—Prov. 11-14.

Open-Cornered Sections vs. the Ordinary Kind.

Query 18.—Are open-cornered sections, standard size, likely to be better than the ordinary kind in producing high grade honey?

R. L. Taylor—No.

James A. Stone—No.

E. France—I don't know.

W. R. Graham—I think not.

Prof. A. J. Cook—I doubt it.

J. M. Hambaugh—I don't know.

G. M. Doolittle—I don't think so.

Mrs. L. Harrison—I do not know.

Allen Pringle—I have not used them.

B. Taylor—I never used them, and do not know.

J. E. Pond—I don't see why they should be.

Chas. Dadant & Son—We have never tried them.

W. G. Larrabee—Perhaps no better, but just as good.

G. W. Demaree—I can't see why they possibly could be. Try them.

C. H. Dibbern—I think not. The plainer the section the better.

Dr. J. P. H. Brown—One kind will work quite as well as the other.

Dr. C. C. Miller—I don't see why there should be an difference in the honey.

Emersoo T. Abbott—I have never tested them; therefore, am not prepared to say.

P. H. Elwood—I have not tried them. I should judge there would not be very much difference.

Rev. M. Mahin—I never saw open-cornered sections, and did not know that any such existed.

H. D. Cutting—I don't know as I understand the question. If you mean the 4-piece section, I say yes.

Eugene Secor—Do you mean 4-piece sections? Yes. I like them better, much better. 1. They are made of whiter wood. 2. They are stronger.

List of Honey and Beeswax Dealers.

Most of whom Quote in this Journal.

Chicago, Ills.

R. A. BURNETT & Co., 163 South Water Street.

New York, N. Y.

HILDRETH BROS. & SEGELKEN,
120 & 122 West Broadway.

CHAS. ISRAEL & BROS., 486 Canal St.

Kansas City, Mo.

O. C. CLEMOMS & Co., 423 Walnut St.

Buffalo, N. Y.

BATTERSON & Co., 167 & 169 Scott St.

Hamilton, Ills.

CHAS. DADANT & SON.

Philadelphia, Pa.

WM. A. SELSER, 10 Vine St.

Cincinnati, Ohio.

C. F. MUTH & SON, cor. Freeman & Central avs.

BEE-BOOKS

SENT POSTPAID BY

George W. York & Co.,
Chicago, Ills.

Bees and Honey, or Management of an Apiary for Pleasure and Profit, by Thomas G. Newman.—This edition has been largely re-written, thoroughly revised, and is "fully up with the times" in all the improvements and inventions in this rapidly-developing pursuit, and presents the apiarist with everything that can aid in the successful management of an apiary, and at the same time produce the most honey in an attractive condition. It contains 250 pages, and 245 illustrations—is beautifully printed in the highest style of the art, and bound in cloth, gold-lettered. Price, \$1.00.

Langstroth on the Honey-Bee, revised by Dudant—This classic in bee-culture, has been entirely re-written, and is fully illustrated. It treats of everything relating to bees and bee-keeping. No apiarist's library is complete without this standard work by Rev. L. L. Langstroth—the Father of American Bee-Culture. It has 520 pages; bound in cloth. Price, postpaid, \$1.25.

Bee-Keepers' Guide, or Manual of the Apiary, by Prof. A. J. Cook, of the Michigan Agricultural College.—This book is not only instructive and helpful as a guide in bee-keeping, but is interesting and thoroughly practical and scientific. It contains a full delineation of the anatomy and physiology of bees. 460 pages; bound in cloth and fully illustrated. Price, postpaid, \$1.25.

Scientific Queen-Rearing, as Practically Applied, by G. M. Doolittle.—A method by which the very best of Queen-Bees are reared in perfect accord with Nature's way. 175 pages, bound in cloth, and illustrated. Price, \$1.00.

A B C of Bee-Culture, by A. I. Root.—A cyclopaedia of 400 pages, describing everything pertaining to the care of the honey-bees. It contains 300 engravings. It was written especially for beginners. Bound in cloth. Price, \$1.25.

Advanced Bee-Culture, Its Methods and Management, by W. Z. Hutchinson.—The author of this work is too well known to need further description of his book. He is a practical and entertaining writer. You should read his book. 90 pages, bound in paper, and illustrated. Price, 50 cts.

Rational Bee-Keeping, by Dr. John Dzierzon.—This is a translation of his latest German book on bee-culture. It has 350 pages; bound in cloth, \$1.25; in paper covers, \$1.00.

Bienen-Kultur, by Thomas G. Newman.—This is a German translation of the principal portion of the book called **BEEES OF HONEY**. 105 page pamphlet. Price, 40 cents.

Convention Hand-Book, for Bee-Keepers, by Thomas G. Newman.—It contains the parliamentary law and rules of order for Bee-Conventions—also Constitution and By-Laws, with subjects for discussion, etc. Cloth, gold-lettered. Price, 25 cts.

Amerikanische Bienenzucht, by Hans Buschbauer.—Printed in German. A hand-book on bee-keeping, giving the methods in use by the best American and German apiarists. Illustrated; 138 pages. Price, \$1.00.

Thirty Years Among the Bees, by Henry Alley.—Gives the results of over a quarter-century's experience in rearing queen-bees. Very latest work of the kind. Nearly 100 pages. Price, 50c.

Why Eat Honey?—This Leaflet is intended for FREE distribution, to create a Local Market. 100 copies, by mail, 40 cts.; 500 for \$1.50; 1000, \$2.50. If 500 or more are ordered at one time, your name and address will be printed on them FREE.

How to Keep Honey and preserve its richness and flavor. Price same as Why Eat Honey.

Apiary Register, by Thos. G. Newman.—Devotes two pages to a colony. Leather binding. Price, for 50 colonies, \$1.00; for 100 colonies, \$1.25.

Preparation of Honey for the Market, including the production and cure of comb and extracted honey. A chapter from **BEEES AND HONEY**. Price, 10 cents.

Bee-Pasturage a Necessity.—This book suggests what and how to plan. It is a chapter from **BEEES AND HONEY**. Price, 10 cents.

The Hive I Use, by G. M. Doolittle. It details his management of bees, and methods of producing comb honey. Price, 5 cents.

Dr. Howard's Book on Foul Brood.—Gives the McEvoy Treatment and reviews the experiments of others. Price, 25 cts.

Dictionary of Apiculture, by Prof. John Phin. Gives the correct meaning of nearly 500 apicultural terms. Price, 50 cts.

Winter Problem in Bee-Keeping, by G. B. Pierce. Result of 25 years' experience. 50 cts.

Handling Bees, by Chas. Dadant & Son.—A Chapter from Langstroth Revised. Price, 8 cts.

Bee-Keepers' Directory, by H. Alley.—Latest methods in Queen-Rearing, etc. Price, 50c.

Foul Brood Treatment, by Prof. F. R. Cheshire.—Its Cause and Prevention. Price, 10 cts.

Foul Brood, by A. R. Kohnke.—Origin, Development and Cure. Price, 25 cts.

History of Bee-Associations, and Brief Reports of the first 20 conventions. Price, 15 cts.

Honey as Food and Medicine, by T. G. Newman.—A 32-page pamphlet; just the thing to create a demand for honey at home. Should be scattered freely. Contains recipes for Honey-Cakes, Cookies, Puddings, Foam, Wines, and uses of honey for medicine.

Prices, prepaid—Single copy, 5 cts.; 10 copies, 35 cts.; 50 for \$1.50; 100 for \$2.50; 250 for \$5.50; 500 for \$10.00; or 1000 for \$15.00. When 250 or more are ordered, we will print the bee-keeper's card (free of cost) on the front cover page.

Bee-Keeping for Profit, by Dr. G. L. Tinker.—Revised and enlarged. It details the author's "new system, or how to get the largest yields of comb or extracted honey." 80 p.; illustrated. 25c.

Emerson Hinders, made especially for the BEE JOURNAL, are convenient for preserving each number as fast as received. Not mailable to Canada. Price, 75 cts.

Commercial Calculator, by C. Ropp.—A ready Calculator, Business Arithmetic and Account-Book combined in one. Every farmer and business man should have it. No. 1, bound in water proof leatherette, calf finish. Price, 40 cts. No. 2 in the artificial leather, with pocket, silicate slate, and account-book. Price, 60 cts.

Green's Four Books, by Chas. A. Green.—Devoted to, 1st, How We Made the Old Farm Pay; 2nd, Peach Culture; 3rd, How to Propagate Fruit-Plants, Vines and Trees; 4th, General Fruit-Instructor. Nearly 120 pages. Fully illustrated. 25 cts.

Green's Six Books on Fruit-Culture, by Chas. A. Green.—Devoted 1st, to Apple and Pear Culture; 2nd, Plum and Cherry Culture; 3rd, Raspberry and Blackberry Culture; 4th, Grape Culture; 5th, Strawberry Culture. 129 pp.; illustrated. 25 cts.

Garden and Orchard, by Chas. A. Green.—Gives full instructions in Thinning and Marketing Fruits; Pruning, Planting and Cultivating; Spraying, Evaporation, Cold Storage, Etc. 94 pages, illustrated. Price, 25 cts.

Kendall's Horse-Book.—35 pictures, showing positions of sick horses, and treats on all their diseases. English or German. Price, 25 cts.

Silo and Silage, by Prof. A. J. Cook.—It gives the method in operation at the Michigan Agricultural College. Price, 25 cts.

Lumber and Log-Book.—Gives measurements of lumber, logs, planks; wages, etc. 25c.

Maple Sugar and the Sugar Bush, by Prof. A. J. Cook.—Full instructions. Price, 35 cts.

Grain Tables, for casting up the price of grain, produce, hay, etc. Price, 25 cts.

Capons and Caponizing, by Dr. Sawyer, Fanny Field, and others.—Illustrated. All about castrating fowls, and thus how to make the most money in poultry-raising. 64 pages. Price, 30 cts.

Our Poultry Doctor, or Health in the Poultry Yard and How to Cure Sick Fowls, by Fanny Field.—Everything about Poultry Diseases and their Cure. 64 pages. Price, 30 cts.

Poultry for Market and Poultry for Profit, by Fanny Field.—Tells everything about the Poultry Business. 64 pages. Price, 25 cts.

Turkeys for Market and Turkeys for Profit, by Fanny Field.—All about Turkey-Raising. 64 pages. Price, 25 cts.

Rural Life.—Bees, Poultry, Fruits, Vegetables, and Household Matters. 100 pages. 25 cts.

Strawberry Culture, by T. B. Terry and A. I. Root. For beginners. Price, 40 cts.

Potato Culture, by T. B. Terry.—It tells how to grow them profitably. Price, 40 cts.

Hand-Book of Health, by Dr. Foote.—Hints about eating, drinking, etc. Price, 25 cts.

Alsike Clover Leaflet.—Full directions for growing. 50 for 25 cts.; 100 for 40 cts.; 200, 70c.

Book Clubbing Offers.

(Read Carefully.)

The following clubbing prices include the American Bee Journal one year with each book named. Remember, that only ONE book

can be taken in each case with the Bee Journal a year at the prices named. If more books are wanted, see postpaid prices given with the description of the books on this page. Following is the clubbing-list:

1. Langstroth on the Honey-Bee.....	\$2.00
2. A B C of Bee-Culture.....	2.00
3. Bee-Keepers' Guide.....	1.75
4. Bees and Honey [Cloth bound].....	1.65
5. Scientific Queen-Rearing.....	1.75
6. Dr. Howard's Foul Brood Book.....	1.10
7. Advanced Bee-Culture.....	1.30
8. Amerikanische Bienenzucht [Germ.].....	1.75
9. Bienen-Kultur [German].....	1.25
10. Rational Bee-Keeping [Cloth bound].....	2.00
11. Rational Bee-Keeping [Paper bound].....	1.75
12. Thirty Years Among the Bees.....	1.30
13. Bee-Keeping for Profit.....	1.15
14. Convention Hand-Book.....	1.15
15. Poultry for Market and Profit.....	1.10
16. Turkeys for Market and Profit.....	1.10
17. Capons and Caponizing.....	1.10
18. Our Poultry Doctor.....	1.10
19. Green's Four Books.....	1.15
20. Green's Six Books on Fruit-Culture.....	1.15
21. Garden and Orchard.....	1.15
22. Rural Life.....	1.10
24. Emerson Binder for the Bee Journal.....	1.60
25. Commercial Calculator, No. 1.....	1.25
26. Commercial Calculator, No. 2.....	1.49
27. Kendall's Horse-Book.....	1.10
29. Strawberry Culture.....	1.20
30. Potato Culture.....	1.20
32. Hand-Book of Health.....	1.10
33. Dictionary of Apiculture.....	1.35
34. Maple Sugar and the Sugar Bush.....	1.20
35. Silo and Silage.....	1.10
36. Winter Problem in Bee-Keeping.....	1.30
37. Apiary Register (for 50 colonies).....	1.75
38. Apiary Register (for 100 colonies).....	2.00
39. Bee-Keepers' Directory.....	1.30

Honey & Beeswax Market Quotations.

The following rules for grading honey were adopted by the North American Bee-Keepers' Association, and, so far as possible, quotations, are made according to these rules:

FANCY.—All sections to be well filled; combs straight, of even thickness, and firmly attached to all four sides; both wood and comb unsoiled by travel-stain, or otherwise; all the cells sealed except the row of cells next the wood.

NO. 1.—All sections well filled, but combs uneven or crooked, detached at the bottom, or with but few cells unsealed; both wood and comb unsoiled by travel-stain or otherwise.

In addition to this the honey is to be classified according to color, using the terms white, amber and dark. That is, there will be "fancy white," "No. 1 dark," etc.

CHICAGO, ILL., June 6.—We quote: Fancy white, 14@15c.; No. 1, 12@13c.; fancy amber, 9@10c.; No. 1, 8@8½c.; fancy dark, 8@9c.; No. 1, 8c. Extracted, white, 5@7c.; amber, 4@5c.

Beeswax, 27@28c. It continues to sell well and there is no accumulation of shipments. We consider it a good time to sell.

R. A. B. & Co.

PHILADELPHIA, PA., Apr. 22.—We quote: No. 1 white, 9@10c.; fancy amber, 8@9c.; fancy dark, 7@8c. Extracted, white clover, 10c.; amber, 5@5½c.; dark, 4@4½c. Beeswax, 25@26c. Comb honey is dull. Extracted in fair demand. Beeswax lower. W. A. S.

BUFFALO, N. Y., Apr. 20.—We quote: Fancy white, 15@16c.; No. 1 white, 13@14c.; fancy dark, 8@9c.; No. 1 dark, 7@7½c. Beeswax, 25@26c. Trade very dull and honey not moving, except a few fancy lots; anything dark is hard to sell. B. & Co.

CINCINNATI, O., Apr. 22.—There is no fancy white comb honey on our market. Best white sells at 12@14c. in a jobbing way, with a fair demand. Demand is good for extracted at 4@7c., according to quality. Beeswax is in good demand at 25@30c. for good to choice yellow. C. F. M. & S.

NEW YORK, N. Y., May 9.—There is some demand for white comb honey at unchanged prices. No market for buckwheat. Extracted remains quiet. New Southern is now arriving and selling at 5@6c. for fine grades and 5@5½c. a gallon for fair to common.

H. B. & S.

KANSAS CITY, Mo., June 13.—We quote: No. 1 white comb, 14c.; No. 1 amber, 12c.; No. 1 dark, 10c. Extracted, white, 6½c.; amber, 5c.; dark, 4½c.

Beeswax, 25c. C. C. & Co.

Bottom Prices

**BRING US BIG TRADE.
GOOD GOODS KEEP IT.**

If you want the best supplies that can be made at a little less cost than you can buy the same goods for elsewhere, write to us for low prices. 1896 Catalogue now ready—ask for it and a free copy of **The American Bee-Keeper** (36 pages).

Address,
**THE W. T. FALCONER MFG. CO.,
JAMESTOWN, N. Y.**

Mention the American Bee Journal.

COMB FOUNDATION!

Wax always wanted for Cash or in Exchange for Fdn. or other Supplies. My trade is established on **Low Prices** and the merit of my **Foundation**. Orders filled promptly. **WORKING WAX INTO FDN. BY THE LB. A SPECIALTY.** Wholesale prices to dealers and large consumers. Send for Prices and Samples to—**GUS DITTMER, AUGUSTA, WIS.** Reference—Augusta Bank. 1Atf

Mention the American Bee Journal.

14 Years' Experience in breeding Italian Queens. **GOOD** Untested Queens, 75c, 3 for \$2.00. **CHOICE** Tested, young, \$1 each by return mail. A. I. Root Co.'s Supplies kept in stock at bottom prices. 36-page Catalog free.
JNO. NEBEL & SON, High Hill, Mo.
Mention the American Bee Journal. 4A26t

I ARISE



TO SAY to the readers of the **BEE JOURNAL** that **DOOLITTLE**

has concluded to sell **BEES and QUEENS**—in their season, during 1896, at the following prices:

- One Colony of Italians on 9 Gallap frames, in light shipping-box \$5 00
- Five Colonies..... 25 00
- Ten Colonies..... 45 00
- 1 untested queen. 1 00
- 6 " queens 5 50
- 12 " " 10 00
- 1 tested Queen... \$1 50
- 3 " Queens. 3 50
- 1 select tested queen 2 00
- 3 " " Queens 4 00

Selected tested queen, previous season's rearing . 4 00
Extra Selected for breeding, **THE VERY BEST.** 5 00
About a Pound of **BEES** in a Two-frame Nucleus, with any Queen, \$2.00 extra.

☐ Circular free, giving full particulars regarding the Bees and each class of Queens.
Address

G. M. DOOLITTLE,

12A25t **BORODINO, Onon. Co., N. Y.**
Mention the American Bee Journal.

BEES QUEENS
Smokers, Sections, Comb Foundation, And all Apian Supplies cheap. Send for FREE catalogue. E. T. FLANAGAN, Belleville, Ill.
6A26t Please mention the Bee Journal.

PURE BARRED PLYMOUTH ROCK

Eggs, \$1.25 per 14. Our P. Rocks are very large, with fine plumage. Also.

BLACK MINORCA EGGS,

a non-sitting and great laying breed. Both kinds raised upon our farm. Minorca Cockers, \$1.00 each. **Mrs. L. C. AXTELL,**
16Atf **ROSEVILLE, Warren Co., Ill.**
Mention the American Bee Journal.

19th Year Dadant's Foundation 19th Year

Is still in the lead, for we use all the latest improvements, including the

NEW WEED PROCESS,

and still make the best goods. Remember that we do not use any acid to purify our beeswax, and that is why our Foundation preserves the smell of the honey and is more acceptable to the bees, than any other. It is kept for sale by

T. H. Strickler, Solomon City, Kansas.
G. K. Hubbard, Fort Wayne, Ind.
L. Hanssen, Davenport, Iowa.
C. Theilmann, Theilmanton, Minn.
E. C. Eaglesfield, Berlin, Wis.
E. T. Abbott, St. Joseph, Mo.
J. M. Jenkins, Wetumpka, Alabama
John Rey, East Saginaw, Mich.
Vickery Bros., Evansville, Ind.

The Jennie Atchley Company, Beeville, Texas.
C. F. Muth & Son, Cincinnati, Ohio
E. Kreichmer, Red Oak, Iowa.
G. B. Lewis Co., Watertown, Wis.
James Reynolds Elevator Co., Poughkeepsie, N. Y.
Louisiana Bee-Keepers' Supply Manufactory, Donaldsonville, La.
Page & Lyon, New London, Wis.
John Nebel & Son, High Hill, Mo.

and many other Dealers. All agree in saying that no goods are better than ours.

Those of our customers who formerly bought through Thos. G. Newman can get our Foundation in **Chicago, Ill.**, by addressing us at **118 Michigan Street**. We keep no other goods there.

We make a specialty of **Veils and Veil Stuffs** of best quality, cotton and silk.

"LANGSTROTH ON THE HONEY-BEE"—Revised.

Bee-Keepers' Supplies, Smokers, Sections, Tin Pails, etc. **Samples of Foundation and Tulle FREE** with Circular. Instructions to beginners with Circular. Send us your address.

CHAS. DADANT & SON,

Mention the American Bee Journal.

HAMILTON, Hancock Co., Ill.

25c Cash Paid for Beeswax!

For all the good, pure yellow **BEESWAX** delivered to our office till further notice, we will pay 25 cents per pound, cash; or 28 cents for whatever part is exchanged for the American Bee Journal, Books or Seed, that we offer. If you want **cash promptly** for wax, send it on at once. Dark or impure wax not taken at any price. Address plainly,

George W. York & Co., 118 Michigan St., Chicago, Ill.

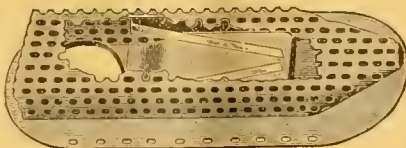

Porter Honey-House Bee-Escape

Have you seen it? Just the thing to put on the doors or windows of your bee-rooms. Indispensable, you'll say after you have tried it.

Corneil Bee-Smokers.

Cheap, strong, serviceable. We have sold a good many of these, and so far there has been no complaint; but, on the other hand, there have been scores of letters in their praise. Price, 85 cts. Prepaid, \$1.10.



COWAN.

Cowan and Novice Extractors.

These are the best. We are prepared to furnish, on short notice, from any of our several Branches, 2, 4, and 6 frame Cowans and 2-frame Novices. If you want the genuine, see that they

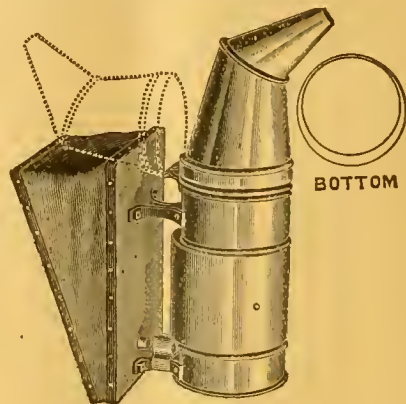

BOTTOM

be our name. **A 36-page Catalog sent Free on Application.**

THE A. I. ROOT CO., MEDINA, OHIO.

BRANCH OFFICES AT:

115 Michigan St., Chicago, Ill.

1024 Mississippi St., St. Paul, Minn.

Syracuse, N. Y.

Mechanic's Falls, Maine.

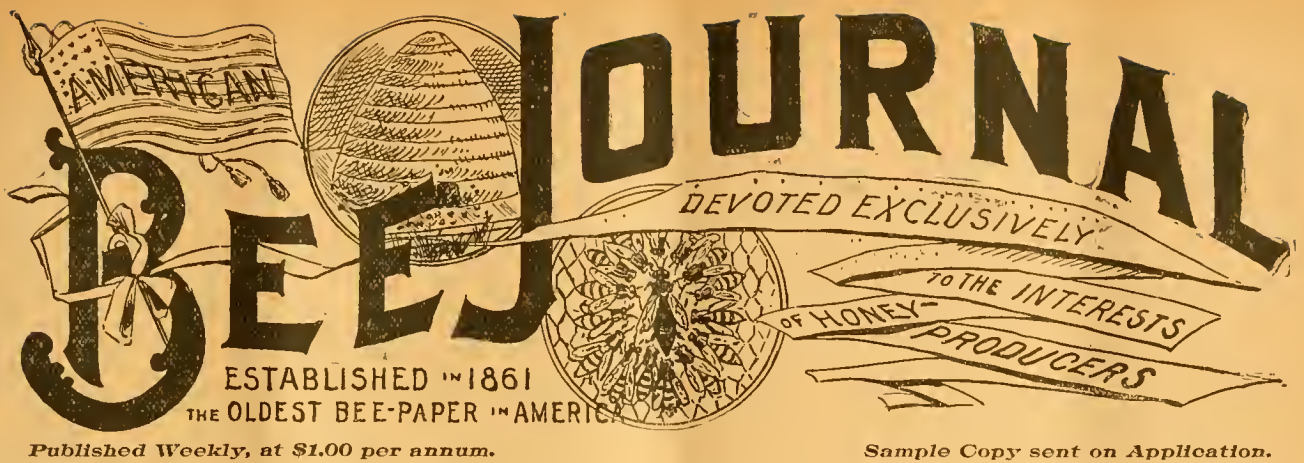

AMERICAN BEE JOURNAL

DEVOTED EXCLUSIVELY TO THE INTERESTS OF HONEY-PRODUCERS

ESTABLISHED 1861
THE OLDEST BEE-PAPER IN AMERICA

Published Weekly, at \$1.00 per annum. Sample Copy sent on Application.

36th Year.

CHICAGO, ILL., JUNE 25, 1896.

No. 26.

Now for a 2-Month Campaign

Please Read All of this Page.

A Few of the Good Things to Appear in the Bee Journal the Next Six Months:

Fifteen Year's Experience in Bee-Keeping.

Mrs. Sallie E. Sherman will begin, in the first number for July, a full account of her 15 years of bee-keeping in Texas. An article from her will appear each week for a number of weeks. They will be of much interest to all, and especially so to Southern bee-keepers.

A Dozen Articles by "The Dadants."

Chas. Dadant & Son, of Illinois, are the leading extracted honey producers of this part of the country. One year they had 48,000 pounds. They will contribute during the next six months, at least a dozen articles, drawn from their experience of a third of a century of bee-keeping.

A Dozen Articles by Mr. Doolittle.

G. M. Doolittle is unquestionably one of the very ablest bee-keepers in this country, and his writings on practical bee-culture have made him famous. With his 27 years' experience, he is well equipped to write profitably for the beginner or even the expert bee-keeper.

A Half-Dozen Articles by Prof. Cook.

Prof. A. J. Cook, of California, author of "The Bee-keepers' Guide," will contribute at least six good articles before Jan. 1, 1897. He is always interesting and helpful.

A Full Report of the North American Convention

will be published in this paper immediately after the annual meeting, which will be held in September or October next, at Lincoln, Nebr. The Secretary—Dr. A. B. Mason—is now at work on the program, which promises to be the best ever gotten up by the Association. Every American bee-keeper will be interested in the many valuable essays and discussions found in the proceedings of their great annual convention.

A Variety of Contributions by Many Others,

who are well qualified to teach modern bee-culture, will also appear during the next six months. All the foregoing in addition to the

Several Special or Regular Departments

will make the American Bee Journal almost priceless to the man or woman who desires to make a genuine success of bee-culture, and keep informed about the doings of the apiarian world.

Some Liberal Premiums to Regular Subscribers.

We want every regular reader of the American Bee Journal to go to work to secure new subscribers, which we will accept at

40 Cents for the Next Six Months.

Yes, sir; we will mail the American Bee Journal from July 1, 1896, to Jan. 1, 1897—26 numbers in all—to any one not now a subscriber, for just 40 cents. And to those of our present subscribers who will work to get the new names, we make these

Generous Premium Offers:

For sending us One New Six-Months' Subscription (with 40 cents), we will mail the sender his or her choice of one of the following list of pamphlets:

Foul Brood, by Dr. Howard.	Dr. Foote's Hand-Book of Health.
Kendall's Horse-Book.	Poultry for Market and Profit.
Rural Life.	Our Poultry Doctor.
Silo and Silage, by Prof. Cook.	Turkeys for Market and Profit.
Foul Brood, by Kohnke.	Capons and Caponizing.

For sending Two New Six-Months' Subscriptions (with 80 cents), your choice of one of the following:

Monette Queen-Clipping Device.	Winter Problem, by Plerce.
Rural Kultur.	Alley's 30 Years Among the Bees.
Bees and Houey (paper cover).	Queenie Jeanette (a Song.)

For sending Six New Six-Months' Subscriptions (with \$2.40), your choice of one of the following:

Novelty Pocket-Knife (with name). Prof. Cook's Bee-Keeper's Guide

\$25.00 Cash, in Addition to the Above.

Besides all the foregoing premiums, we will distribute, on Sept. 1, 1896, \$25.00 in cash to the nine having sent in the highest number of new 40-cent subscriptions before that date, (but only those having sent 10 or more new subscriptions can compete for the extra cash premiums) in these amounts: To the one sending the highest number, \$10.00. The 2nd highest, \$5.00; 3rd, 4th and 5th highest, \$2.00 each; and to the 6th, 7th, 8th and 9th highest, \$1.00 each.

Let Every One Begin NOW to Work.

We will be glad to mail free sample copies, upon request, either to a club-raiser, or direct to those you desire to solicit, if you will send in the names and addresses.

If You Get Two Copies of This Number

of the Bee Journal, kindly hand one of them to a neighbor bee-keeper, whom you probably can get to subscribe for it on the 40-cent offer.

All subscriptions will begin with the first number in July.

Yours for a two-months' campaign,

GEO. W. YORK & CO., 118 Mich. St., Chicago.

Special to Those Not Now Subscribers, who may receive this

By sending us 40 cts., we will enter your name as a regular subscriber for the six months ending Jan. 1, 1897, and then you will be entitled to take advantage of the offers made above, by going to work and getting other new subscribers. Please remember, no premium will also be sent to a new subscriber—only to those who are regular subscribers, and who go to work to get the names of others.



The Spraying of Fruit-Trees vs. Bees.

BY PROF. A. J. COOK.

As is well-known to the bee-keepers, I have urged for many years the danger to bees of spraying fruit-trees while in bloom. I have been the only entomologist in the country that has done so. Indeed, some entomologists in the country, notably Prof. F. M. Webster, of the Ohio Experiment Station (formerly of the Indiana Experiment Station), urged the opposite view; or, at least, questioned the truth that spraying our fruit-trees while in bloom ever did injury to bees. He has several times intimated that the assertion was made with no experimental facts or convincing observations back of it. He has referred to my opinion as based on nothing conclusive; and takes upon himself great unction as the one to settle this matter. I am very glad that Prof. Webster has made the investigations that he has, although I think they do not add in the least to the certainty of the matter. All scientific research is desirable, and we all should welcome any and all if made with care, wisdom and conscientious caution.

I am glad to repeat the evidence that came to me years ago, and which, to my mind, was just as conclusive and absolute as could be needed, and so I repeat that in my opinion Prof. Webster has not made this matter any more certain.

We all know that bees never die wholesale except through starvation, or long confinement during the extreme rigors of our severe northern winters. True, bees do succumb to "foul brood;" but in such cases gradually perish, and by a disease now well understood by all intelligent bee-keepers. The same may be said of "bee-paralysis," and of the new malady which attacks the brood. After years of experience, our many students of bee-culture—men of great intelligence and culture—know of no other fatality among bees other than those mentioned above. Now, all at once, such men discovered sudden and terribly devastating mortality among bees, where both mature bees and brood suddenly perished in exceeding numbers. There was plenty of honey in the hives, and so starvation was ruled out. It was during the genial warmth of May, and so winter's rigors could not be held responsible. There was no "foul brood" in the apiary, and often none in the entire region; and so foul brood could not be accused as the enemy. In those first years the later bee-diseases were unknown, and, besides, their methods of destruction are so different that they could not have been the cause of this new fatality. Plainly then some new evil or cause was at work to produce this great mortality among the bees.

In every case the bees were in the close vicinity of large orchards. In every case the weather was propitious so that the fruit-bloom was full of nectar and crowded with bees. In every case the orchards were liberally sprayed with the arsenite while still in blossom, and before the extensive visits by the bees. In every case the adult bees and broods perished alike and in great numbers. This last condition was unknown in all bee-keeping experience until spraying came into vogue; and is never witnessed except the bees visit orchards sprayed with the arsenite while in bloom. Was it then presumption to say that the bees were poisoned with the arsenite? Was it necessary to make a chemical analysis of the bees or the contents of their stomachs in order to speak ex-cathedra on this subject?

Years ago I discovered that by spraying our fruit-trees just after the blossoms had fallen, I destroyed the coddling-moth larvæ. As a consequence of this discovery, I sent abroad the statements far and near to all our fruit-growers, that the so-called apple-worm could be destroyed by spraying the trees at this time. Yet I did not think it necessary to make a chemical analysis to see whether there was poison in the alimentary canal of the little caterpillars. Prof. Webster has also said the same thing. Did he make analysis or think it necessary in order to announce this fact? Why not, if this course was necessary in regard to the bees? How many entomologists have stated that Paris green was sure death to the potato beetle, elm-leaf beetles, etc.? We all said so because we sprayed the vines or foliage and the insects died. We thought it proof enough, and did not analyze the contents of the various insect stomachs. Did not Prof. Webster do just this very thing? If he did not—and I am very sure this is the case—would it be quite fair for me to state that he was giving advice without any sufficient reason that he was correct, or his advice necessarily good? I have known flour mixed with Paris green to be left in the field with cattle over night. The next morning the Paris green and flour was all gone, and there were several very sick or dead cattle lying around in the meadow. I reported that the cattle had died from eating the Paris green. Was that a piece of great presumption because I did not have the stomachs of the cattle analyzed?

Prof. Webster (see *Insect Life*, Vol. V, page 121) gives an article upon this subject, in which he says:

"Although much has been said with regard to the effect upon bees of spraying fruit-trees with arsenites while in bloom, there seems to have been no careful experiment made for the purpose of securing exact proof, and therefore all assertions were necessarily very largely opinionated. Bee-keepers were, as a rule, of the opinion that bees would be killed by spraying the bloom, some because their bees had died, others because some one else said such results would follow. Most entomologists did not care to express an opinion based on the very little accurate information on hand, while others, including the writer, doubted the fatality of the measure, because it was thought that the poison thus applied would either blast the bloom, and thus render it distasteful, or the poison would not reach the nectar, and, being insoluble, otherwise would not affect the bees."

Prof. Webster then goes on to give an account of his experiments. His first experiment shows conclusively that he was no bee-keeper, and knew very little about bees. After spraying the tree, he enclosed the same, including the hive of bees, with brown sheeting. Of course, no one with any knowledge of bees need be told that the bees would at once attempt to escape upon finding themselves enclosed, and would soon worry themselves to death. Such a course would be poison to the bees, but they wouldn't get any of the poison. Subsequent experiments, where the trees were sprayed when in bloom, and bees secured which had worked upon the flowers, were more satisfactory. The bees were washed so as to be sure to wash off all the poison, and then by analysis poison was found, showing that bees had taken it.

In the same magazine, Vol. VII, page 132, Mr. Webster gives another article upon the same subject, and with very similar results. He concludes as follows:

"In summing up the matter, then, I can see no other conclusion that can be drawn from the results of my experiments, than that bees are liable to be poisoned by spraying the bloom of fruit-trees, the liability increasing in proportion as the weather is favorable for the activity of the bees, and that all bloom must have fallen from the trees before the danger will have ceased."

To the person familiar with bees, the fact that they are known to die extensively, and in a way in which they are never known to die under other circumstances, after working upon trees which have been sprayed while in blossom, is much better proof than that secured by Prof. Webster. In most of

the cases he describes, he could not know that the bees certainly died because of the poison, while in the other cases there would be no chance to avoid this conclusion. As I have already suggested, Prof. Webster is not so careful in regard to other insects, and with good reason.

It seems strange to me that he should have required so much more testimony in the case of bees. It is well-known to all bee-keepers that in many seasons bees hardly visit fruit-bloom at all, owing either to cold, damp weather, or possibly absence of nectar. Thus, it is easy to see why in such cases spraying trees while in bloom is not injurious to bees. The same condition prevents cross-pollination, and often accounts for failure of a fruit crop, because of the lack of cross-pollination by bees. I was positive, years ago, from the evidence given above, that spraying trees while in bloom, with the arsenites, was always fatal to bees if they worked at all extensively on the bloom. It also may destroy the brood as well. I am no more positive now that I have the results of Prof. Webster's experiments.

If Prof. Webster had owned a large apiary, and had he witnessed the utter extermination of his bees, as many bee-keepers have done, after seeing the bees work on sprayed bloom, he would not have been so exacting in his call for proofs; no more exacting than in the case with other insects. But it is fortunate that he is at last convinced, and will not longer throw his influence on the side of error and mischief.

Claremont, Calif.



Apis Dorsata—The Queen-Business.

BY W. P. FAYLOR.

For one, I am sorry to learn of some of our bee-keepers using their influence against the good-will and earnest wishes of those who desire the importation of the "giant bees" from the East. And now, Mr. Editor, have you not given your influence somewhat in the same direction? Should the introduction of new races or species of bees add nothing better to what we have, we will still be as well off as before; and should we gain by another importation, then, surely, all bee-keepers will have reason for rejoicing.

The absconding nature of *Apis dorsata* is the worst feature urged against them; but I think this is due largely because of their building their combs so frequently in the open air. Our bees will do the same thing under similar circumstances; and when mice or any pestilence annoy them, or when starvation stares them in the face, the tamest bees in the world will abscond in search of better surroundings.

The best description I ever saw of this race was that reported by Mr. Henry Alley, and published in the American Apiculturist some years ago, by a man who kept a colony of the "giant bees" for a good part of a hot summer. Here, where the heat is less intense, and our summers shorter, and the honey-flow more frequent, even *Apis dorsata* would be less inclined to abandonment.

But our greatest hope is in obtaining a cross with some of the bees we have. Because the queens of this large bee are supposed to mate at about sundown or dusk, many have concluded that *Apis dorsata* could never be crossed with other bees; but is this not mere presumption? My observation has been that the queen goes out on her wedding tour only when the bees of her colony urgently request her to go. Then, again, in a very hot climate and a dry atmosphere drones fly much later in the day than when bees are gathering nectar freely. During a hot, dry spell of weather, our own domesticated drones will fly most thickly between 3 and 5 o'clock in the afternoon; and when the weather is cooler, in May or June, they are seen most thickly at about 1 p.m. May not climatic influences have much to do with varying traits of bees?

For one, I should like to see *Apis dorsata* given a fair

trial in a fair country for honey-flows. The importation of fresh blood of some of the same races we now have might also be an improvement to our bees. We have reason to believe that the best bees from Italy at present are not being imported to our country. About all the queens now imported are reared by the artificial method, and are not so large nor prolific as those that come by Nature's method. I am quite sure we dropped the "Syrians" and the "Cyprians" too soon. By careful selection a better Cyprian and Syrian type might also be introduced than what has already been tried.

Poultry men search the world for the best hen to lay eggs, and why not let the earth be searched for the best bee to gather honey? Now, my brother bee-keeper, if you have no faith in the importation of new races of bees, in the name of reason and judgment do not throw a stumbling-block in the way of those who wish to give this matter one fair trial.

SENDING QUEENS PROMPTLY.

It seems to me that those who engage in the business of rearing queens for the market should go into the business on a large enough scale to meet the market demands promptly. Nearly a month ago I sent an order to Texas for two queens; one arrived a few days ago, the other has not come yet. This queen-breeder never sent any statement as to whether the order had been received or not. It would seem like business, to me, that when a queen cannot be sent promptly, a statement ought to be sent, saying when a queen, or queens, will be sent.

ADVERTISE THE PRICES OF THINGS.

Every one who advertises things for sale should give the prices for which they can be had. For instance, some one advertises in the American Bee Journal (a splendid medium for advertising) "Queens by return mail. Write for price-list." Perhaps the bee-keeper wants a queen within a day or two, and does not desire to spend time and a postal to get prices.

Do not withhold the price because some one else advertises cheaper than you can sell. Some one who advertises queens for one dollar may get an order as soon as the one who sells queens for half that price.

Hansell, Iowa, May 26.



One Way to Hunt for Bee-Trees.

BY PETER STEINEBACH.

E. S. G. asks, on page 278, how to hunt bees. I will give my way.

I enclose a picture of a hunting-box in three parts, marked No. 1, No. 2, and No. 3.

No. 1 has a part soldered to the bottom so that it will set on a stick. I use an old hoe-handle, cutting the hoe off. I sharpen the iron so that I can run it in the ground, or, if need be, in wood, or in the road, and have it set solid. The ferrule of box No. 1 should just fit over the other end of the hoe-handle.

Box No. 2 must fit over box No. 1, where you see the beeswax. Box No. 3 must fit in box No. 2 on the under side. These boxes can be made small so that they can be carried in the coat-pocket.

Now, to hunt bees, select some time when bees cannot get anything, or when they will rob. I go where I think a bee-tree might be. Have prepared the box and honey. For bait I use honey and water— $\frac{1}{2}$ water, $\frac{1}{2}$ honey. Put both into a bottle, and shake until it is well mixed. When it gets sour take new.

When I get where I want to begin, I run the hoe-handle in the ground; take box No. 1 and fill it from the honey in the bottle, and carefully lick off with the tongue all the honey that does not run into the cells. Now set the box on the hoe-handle.

You can catch bees with box No. 2 or No. 3, but I like a

small tumbler best. Take the tumbler in one hand, holding the other hand over, and get both as near as can be to the bee you want to catch; bring the tumbler and hand together quick, with the bee between. If you have the flower on your hand you can let the flower slip out while the bee is buzzing on the other end of the tumbler.

Now, keep your hand on the tumbler so that the bee cannot get out; go to box No. 1, bring the tumbler as near the wax as you can, and while the bee is trying to get out of the upper end of the tumbler, drop it on the wax—not hard, but as lightly as you can, so as not to settle it in the wax. Now hold around the box and all, an old felt hat, so as to make it dark, when the bee will see the honey, and load up. Now, when she stops buzzing, take the hat off carefully; also take it off so the sun will not throw a shadow over the box, or the bee may leave, and you would have to get another. Now while she takes her load, get out your watch, and lie down on your back so that your feet will be near the stick that box No. 1 is on, and watch the box.

If your bee did not daub, she will come out on the wing. If she daubs, she will crawl out, and hang on the outside of

may be too nearly loaded to be of use to you to move. When a bee comes back, bring up box No. 2, which should fit over box No. 1, and as quick as you can get the bee up shove the slide, and all the bees on the box are shut up in box No. 2.

Now take box No. 3, set that on box No. 2, the glass of both boxes outside. Open both slides, darken No. 2, and the bees will go into box No. 3, and your bees are all in box No. 3.

Now lay down No. 3, take No. 2, catch more until you have about six hungry bees, not counting the bees that were in box No. 1 when you caught the first bee.

Now you might think that box No. 3 is not necessary, but when you put box No. 2 on box No. 1 to catch another bee, the bee you have will run down, nine times out of ten, and she will get so much honey in her that she would not locate well when you move the box.

To get your cross-line, you should, while running the first line, watch for an open spot or field, where you can set the box; it should be 20 rods or more one side of first line. Having such a spot, set box No. 1 just as before, lie on your back and get this line just as you did the first one, and when you come to the cross-line, you are very near the tree.

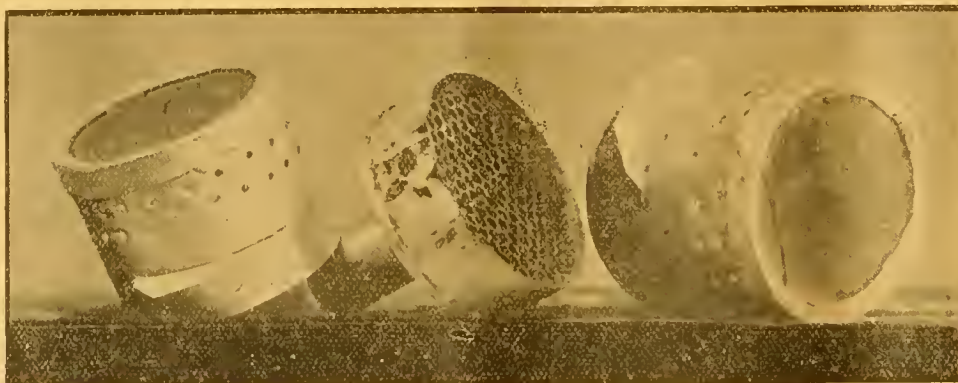

No. 3.

No. 1.

No. 2.

the box. Waste no time on her, but catch another, and try again.

Now, when the bee comes out on the wing, keep your eye on her, and if you are quick, and keep her between you and the sky, you are all right.

Now mark some object the bee flies over (in your mind), that is, when the bee has stopped circling. Look at your watch, and if the bee gets back in 15 minutes, the tree is within half a mile.

Now catch another bee and put her in the box as before. You can generally catch about three bees, and put in the box before the first one gets back. But as soon as one comes back, and buzzes around the box, get out of the way and let her load, and you need catch no more. But while she loads, lie down as before, and watch to see which way she goes.

Now that you have bees to work, you must get an exact line. To do this, you must be patient, and lie on your back, and watch every bee that leaves the box, and as she flies home she will fly over something that you can take for your line.

To know you have a line, there must be a number of bees flying over the exact spot. Set your compass, and run that line out just as exact as if you were surveying land worth \$100 per acre. When you are running out the first line, and judging by the time the bees were gone home—for you must run the line, also—you must mark the line so you will know it, when you get to it with your cross-line. You should have left box No. 1 right where it was, well loaded with the sweet, so the bees were working all the time.

Now go back and take box No. 2 and stand close to box No. 1, and watch. Don't catch the bees in the box, as they

Don't think that the tree you see is just the right one for a bee-tree, for they will surprise you very much. Look at every thing, big and little. Also, don't look as you would look for a grizzly bear. They may be so high that by looking a long time in one place you may see just a streak; or they may be so slow that the first you will know is a whack on the side of the head.

In hunting the bees in box No. 1, you can set box No. 2 right over box No. 1, darken it, and they will go down, or you can put them into the tumbler.

If bees are getting honey off the flowers, they may not come back; if they don't get back in two hours, set box No. 1 where you had it the first time, and go it all over again, except running the line. If they do not come back the second time, let them work one day, so that they will get thoroughly aroused. As said before, for bait I use honey and water, about one-third water, in a bottle; mix well. Don't use it if it gets sour. If you can't get honey take granulated sugar, and make a thin syrup. Don't let any one bother you by telling you oil of anise. If no bees can be caught when you wish to set your box, take a fire-shovel, or tin plate, and burn some pieces of old wax until they come. When burning wax set the box handy, and may be the first bee that comes will jump right in the box. Also have the box or tumbler handy, so you can trap one of them over the bee before she gets in the fire or burning wax.

Colby, Wis.



Every Present Subscriber of the Bee Journal should be an agent for it, and get all others possible to subscribe for it.

Flowery Month of June.

BY ROSE SEELYE-MILLER.

A breath of fragrance stirs the air,
And life and beauty everywhere;
The birds sing songs within the trees,
Amidst the flowers the hum of bees,
And life is sweet, and love is dear,
When June shows skies of azure clear.

A distant sound of rippling brook,
That bends and curves like shepherd's crook,
And in its depths the minnows swim,
Their shining sides like silver dim,
And life is sweet, and love more dear,
When June shows skies of azure clear.

We see a field and grazing kine,
We breathe the air like mild, sweet wine,
And dream of life when love was young,
And Eden's flowers eternal spring;
For life is joy in sweet June time,
All Nature sings in rhythmic chime.

Love is the key that makes life sweet,
A love so strong, so broad, complete,
That we can scarcely understand
The waving of the mystic wand;
For God is Love, and love is sweet,
'Tis this that makes life's June complete.

—Selected.



Beeswax and Its Adulterants.

Read before the Philadelphia Bee-Keepers' Association, Feb. 10, 1896.

BY LYMAN F. KEELER, PH. C., B. S.

Considerable controversy has arisen from time to time as regards the exact manner of the production of beeswax. For a long time it was the received opinion that beeswax was nothing more or less than a simple modification of the pollen-grains, and that the pollens required for such a conversion a simple pressure and a kind of kneading by the bees' feet. When we consider the chemical composition of this commodity only superficially, the erroneoussness of the idea and the crudeness of the opinion are at once made manifest.

In process of time another theory was advanced, viz., that the wax was precontained in the pollen and nectar, serving as food for the bees; that the bees isolated the wax contained in the pollen and nectar by digesting away and otherwise removing constituents not wax. This view carries with it a certain amount of weight, inasmuch that when bees are fed upon sugar alone they appear to be incapable of developing wax to any extent. On the other hand it must be admitted that the character of the food necessarily varies much in different quarters of the globe, yet the chemical composition of beeswax does not vary to any notable extent. Samples of this article obtained in various localities in Europe, Asia, South America, Australia, all possess a similar composition. This fact is barely compatible with the idea that the wax pre-existed as such in the pollen and nectar of the great variety of flowers contributing to the sustenance of bees.

The third and most probable theory is that beeswax is a product peculiar to the special life action of the bee, wasp and allied species of insects; that the wax is not collected from flowers as wax, but is secreted by special glands situated beneath the rings of the abdomen of the neuter or working-bee. Huber claims to have proven, by a series of well-conducted experiments, that the quantity of wax secreted is proportioned to the honey consumed, and if the bees are fed on a solution of sugar and water even greater quantities are produced.

Whatever may be the true theory regarding the production of beeswax, these three facts stand paramount:

1. That genuine beeswax has yet to be produced in which the special life action of the bee or allied insects has not taken a part.

2. No considerable quantity of beeswax has ever been produced by bees that have not had access to flowers.

3. From whatever quarter of the globe a beeswax may be accumulated, and whatever may have been its environments, the chemical composition is always approximately uniform.

The first and third statements are intimately correlated. No definite chemical compound can be produced or exist without the action of certain definite forces.

Unscrupulous individuals are continually calling into play certain unprincipled forces designedly intended to defraud their fellowman. After having succeeded in a measure in hoodwinking the public, they endeavor to brush away the last shadow of a doubt by applying fanciful names to their inferior products. How often do we meet these euphonic names displayed in these days of advertisements. Even our most patriotic sentiments are not spared, as is exemplified in the following: "First in war, first in peace and first in the hearts of his countrymen."—Washington. "First in purity, first in nutritiousness and in palatability." Enshrine the falsified products in words ever so flowery, in sentiments ever so patriotic, dishonesty will manifest itself in due time.

The old adage—"There are tricks in all trades"—has place in the calling of a bee-keeper. These tricks have in many instances increased to an alarming extent; especially is this true with beeswax. In some cases the adulterations are so cleverly adjusted that a thorough trial of the most approved methods of analysis is requested before even an opinion of reasonable assurance can be expressed. The chemist seldom encounters a product that presents more analytical difficulties than beeswax.

The true friend of the bee-keeper is not he who shuts his eyes to the adulterations of beeswax—unpleasant facts though they are—but, rather, he who having seen the enormous extent of the sophistications, supports the labors of those who seek to detect and endeavor to prevent this degrading business, and with every instance of exposed fraud are stimulated to renewed energy, determined to bring into disrepute the goods of deliberate deceivers.

There are cases where the producer is entirely innocent. For example, Mr. A purchases comb foundation of Mr. B, who represents it to be pure, yet when Mr. A's beeswax is examined it is pronounced adulterated. Where is the difficulty? An examination of the comb foundation discloses definitely the source of the adulteration. Mr. A suffers. Is he guilty of an offense? You say, and rightly, certainly not. Is Mr. B guilty? Probably. Yet Mr. B might have purchased his wax of Mr. C, etc., *ad infinitum*. The writer holds that Mr. B has transgressed. He must have realized that unless he exercised extreme care and eternal vigilance his inferior comb foundation would become the center of a most distressing evil. It was his duty to examine, or to have some one examine, every purchase of beeswax made which was made for the purpose of making comb foundation.

Several writers appear to think that it is not possible to employ ceresin as an adulterant of beeswax, intended for comb foundation. They argue that its melting point is too low. It may have been the case a number of years ago, but today we can secure ceresin with a melting point much higher than that of beeswax.

In 1892, Dr. Wiley reported that the United States Department of Agriculture had comb foundation purchased from every available source, but was unable to find any adulterated product. In order to secure analytical data on adulterated comb foundation to be incorporated in the chemical examination then in progress, it was necessary to import the product from Canada, where it appears to have been amply adulterated. Would that such were the case now. Of the limited number examined by the writer, one-half were adulterated.

In purchasing beeswax, it is quite essential to specify beeswax and not simply wax, for wax is a general term and covers a multitude of sins. Beeswax has been the cause of considerable litigation in England of late. The following is an extract of one of the proceedings:

"What color is it?" "Dirty white."
"Well, it is white; don't put the dirty in."
"Is that a piece of white wax or is it not?" "I don't know; I am not an analyst."
"Does the certificate say it is wax?" "It says it is composed of 30 parts of beeswax and 70 parts of paraffin wax."
"Well, is that wax?" Yes, I will take it for what it is on the certificate."
"That is, wax?" "Yes."
"And it is white?" "Yes."
"And that is all you asked for?" "Yes."
"And that is a piece of wax, and you say it is white? It is absolutely what you asked for, is it not?"

It is needless to say that the bench upheld the defendant's contention.

Within the last few years the writer has examined a goodly number of samples of beeswax. Nearly two years ago he reported that about one-half of the beeswax in the market was adulterated. Many samples have been examined since then, and not until recently have spurious goods again come into my hands.

It has frequently been asserted that beeswax is often adulterated with such substances as brick-meal, pea-meal, heavy spar, gypsum, kaolin, chrome yellow, litharge, yellow ochre and sulphur. The writer had come to the conclusion that the days of such gross sophistications had passed away, but the examination of several samples lately convinced him that this nefarious business had again been awakened from the slumber-room of time, if it has been asleep.

Inorganic substances are chiefly added to weight the wax. A few, like chrome yellow, litharge and yellow ochre, are added to give color as well as weight. These adulterants can occasionally be detected by scraping the wax on the side corresponding to the bottom of the vessel in which the wax was molded. On examining the freshly cut surface with a hand-lens, or even with the naked eye, minute particles of the foreign substances are revealed. They may also be detected by melting the wax and cooling slowly, whereby these heavy substances separate and settle to the bottom.

We will now briefly consider the properties of waxes and wax-like substances used as substitutes for and adulterants of beeswax.

SUBSTANCES USED AS BEESWAX ADULTERANTS.

ARTIFICIAL WAX.—A patent has been granted in France for manufacturing a wax consisting of two parts of resin and one part of paraffin melted together. An alternative process consists in extracting three parts of resin and one part of soap, or stearic acid, or vegetable wax, with potash.

One of our pharmaceutical editors, in commenting on the debased condition of beeswax in London, supposes that none of his readers will find artificial beeswax in this country. How fortunate if such were the case. The writer with reluctance announces that he has in his possession two samples of wax that are decided infringements on the bees' rights, to the extent of at least 300 pounds. This wax has never been near an apiary. It consists entirely of resin and paraffin, colored with chrome yellow.

CARNAUBA OR BRAZIL WAX.—This is a secretion of the carnauba palm-tree which grows along the rivers of Brazil. The wax has a dirty, grayish yellow to greenish color, is tasteless, hard and brittle. When fresh it has the odor of new-mown hay, but later it becomes odorless. It is seldom used as an adulterant of beeswax at the present time.

CERESIN OR CERITE.—Ceresin is also called artificial wax. This substance in the crude state is known by various names—as mineral wax, earth wax and ozokerite. Probably no other single substance is so extensively employed in adulterating beeswax as ceresin. None is more easily detected. It varies in color, according to the method of purification, from a white to a yellow or brown. Not infrequently gamboge, turmeric, dragon's-blood, or one of the various aniline dyes, soluble in fats, are employed to produce a desirable tint. According to the degree of purity, ozokerite often has an agreeable wax-like odor. The consistency of ceresin varies from soft and pliable to hard and brittle, the latter showing a conchoidal fracture on breaking. The general term "paraffin" frequently includes ceresin.

CHINESE WAX.—This is known as China wax, China vegetable wax, insect wax, insect white wax, pela wax, tree wax and vegetable spermaceti. As several of the names imply, China wax is distinctly the secretion of an insect. It is a secretion from the body of the female and young insects growing on trees in China. As the insects develop, the surface of the branches gradually becomes coated with a white substance, or the wax crust in which these little organisms become imbedded. The wax is of a white or slightly yellowish color, odorless, tasteless, lustrous, crystalline, hard and brittle.

JAPAN WAX.—China wax is frequently confused with Japan wax. The latter is distinctly a vegetable wax, while the former is an insect secretion. The melting points also differ greatly. Japan wax has a somewhat resinous, tallowy, rancid odor and taste; is also quite hard and brittle. It is largely used in this country.

PARAFFIN OR PARAFFIN-WAX.—This is a solid, white translucent substance resembling wax. It is prepared by distilling the residuum obtained in the preparation of petroleum. The distillate is collected and purified for the market. It was formerly obtained from ozokerite, and in the destructive distillation of shale, etc. Paraffin is a generic name and properly includes ceresin. It is very extensively used in adulterating beeswax, and is very readily detected.

ROSIN.—Common rosin or colophony is the residuum left after distilling off the volatile oil from crude turpentine. Rosin is a transparent or translucent resin having a faint terebinthinate odor, and is nearly tasteless, but some varieties have a

nauseous and highly characteristic aftertaste. It varies in color from pale amber to a dark reddish brown, and is very brittle.

STEARIC ACID.—This is prepared by treating tallow with caustic soda or potash, decomposing the resulting soap with a dilute acid and purifying the resulting fatty acid. The commercial product is commonly known as "stearine" and is really a mixture of stearic and palmitic acids. Its quality varies greatly. The color is white to yellowish white. It has been used as an adulterant of beeswax on several occasions.

TALLOW.—Is a time-honored adulterant of beeswax and does not need any comments here as it is very little used now.

VEGETABLE WAX.—This name, which formerly included palm, carnauba, myrtle and Japan waxes, is now used to signify a kind of wax produced in India.

METHODS OF DETECTING ADULTERATED BEESWAX.

We will now briefly consider the methods employed in detecting adulterated beeswax. The methods used for detecting the presence of weighting substances has been spoken of above. Pure beeswax has either a straight or convex upper surface, never a concave surface. A concave surface indicates the presence of ceresin or allied bodies. When pure beeswax is melted in a smooth, flat-bottomed, shallow vessel and allowed to congeal the wax invariably shrinks away from the sides of the vessel. Ceresin and allied products will not do this. A wax containing a small per cent. of ceresin will shrink away, while a large per cent. prevents this phenomenon. A beeswax containing an appreciable amount of paraffin can be readily masticated. Beeswax always becomes brittle when chewed.

Having examined the wax externally the specific gravity is next ascertained. The writer has found the following the most satisfactory and expeditious method:

Melt a sample of the wax in a small vessel and pour the wax upon a moist plate in such a manner as to form little pellets of wax. Allow these pellets to cool thoroughly. In a cylindrical vessel make a mixture of one part of alcohol and two parts of water. Allow the air bubbles to escape, then add the pellets of wax to the mixture. If they rise add more alcohol; if they sink add more water. Continue this until the wax floats indifferently in the liquid. The specific gravity of the liquid now corresponds to that of the wax and can easily be ascertained by a specific gravity spindle or a specific gravity bottle. In case the specific gravity bottle is employed, the determination must be made at 15° C. The specific gravity of beeswax at 15° C. is about 0.960.

The melting point is a telling factor in the analysis of beeswax and is easily obtained as follows:

Dip the bulb of the thermometer into the sample of beeswax an instant; on removing and cooling, the bulb will be covered with a fine film of the beeswax. Introduce the thermometer into a large test-tube, through its perforated stopple. The stopple must have a second perforation or other device for equalizing the pressure. The test-tube is now introduced into warm water, the temperature and the film carefully watched, and the instant a hanging drop is formed, the temperature noted and the melting point recorded.

The acid and the ether numbers are valuable factors in the analysis of beeswax. The process of the acid number is as follows:

Heat 3 or 4 grams of the wax with 20 cubic centimeters of neutral 95 per cent. alcohol; while hot titrate with a semi-normal alcoholic solution of potash, using phenolphthalein as indicator.

For estimating the ether number, add 20 cubic centimeters more of the alkaline solution, and saponify by boiling the solution briskly in a reflux condenser for one hour, then titrate back the excess of alkaline solution with a semi-normal acid. The number of milligrams of potassium hydroxide required to saturate the free acids of one grain of wax is called the "acid number." The number of milligrams of potassium hydroxide required to decompose the wax ethers of one gram of the wax is called the "ether number." The acid number varies from 19 to 24, while the ether number varies from 73 to 76.

Scientific investigation has made it possible to prepare a mixture that will comply to the constants of beeswax in all of the above tests. For this reason it is necessary to resort to several specific tests, which will eliminate the substances that can be so employed.

Stearic acid can readily be detected by Febling's process, which will indicate the presence of one per cent. of this substance, and is executed thus: Boil one grain of the wax to be tested with 10 cubic centimeters of 80 per cent. alcohol, for a few minutes; cool to 18 or 20° C., filter; to the filtrate add

water and shake. If stearic acid is present it will separate in flock on the surface, leaving the underlying liquid nearly clear.

Rosin is best detected by the following method: Placing 5 grains of the wax into a flask, add 20 cubic centimeters of commercial nitric acid (sp. gr. 1.32); heat the mixture to boiling, and retain at this temperature for one minute. Add, while still warm, an equal bulk of cold water, then an excess of ammonia water. With pure wax the alkaline fluid is colored yellow only, but the presence of rosin renders the liquid deep brown.

Paraffin or Ceresin.—Add 5 grains of the wax to 30 cubic centimeters of strong sulphuric acid, heat to 160° C. for one half hour, allow the charred mass to cool somewhat and add water; if a wax-like body separates on the top of the liquid, paraffin or ceresin is present.

The reader undoubtedly has queried in his mind why the melting-points, specific gravities, etc., were not given in the descriptions above. This was not done simply because the writer desired to embody all common properties in a table for convenient reference. The table appears herewith under the title of

A TABLE OF CONSTANTS FOR BEESWAX AND ITS ADULTERANTS.

Substance	Melting Point.	Sp. Gr. at 15° C.	Acid Number.	Ether Number.	Ratio.*	Total.
Yellow Beeswax.....	62-64	0.955-964	19-21	73-76	3.5-3.8	91-97
White Beeswax.....	63-64	0.960-973	19-24	76-84.3	3.5-3.8	93-107.3
Cocoa Butter.....	30-34.5	0.945-982	0-3	192-204	—	192-207
Carnauba Wax.....	83-84	0.990-999	4-6	75-76	18.7-12.6	79-82
Ceresin or Mineral Wax.....	60-84	0.918-952	0	0	0	0
China Wax.....	81-83	0.970	0	63	—	63
Japan Wax.....	47-54	0.963-984	18-28	194-200	10.7-7.8	212-228
Paraffin Wax.....	38-74	0.913-914	0	0	0	0
Resin.....	53.5	1.104-1108	146-173	10-21	—	156-194
Spermaceti.....	40-50	0.905-96	0-5	125-138	—	125-143
Stearic Acid.....	53-69.2	0.901-1000	204-209	4-5	—	208-214
Tallow.....	40-50.5	0.982-96	275-5	193-208	—	195.75-213
Vegetable Wax.....	47-55.6	0.947	17-19	200-210	11.7-11	218-220

* Ratio of acid number to ether number.

In closing the writer desires to leave for the reader's perusal a table embodying the analytical data of a number of samples of adulterated beeswax, interspersed with data from a few genuine samples, by way of contrast:

RESULTS OF ANALYSIS OF 21 SPECIMENS OF YELLOW BEESWAX.

Serial Number.	Melting Point.	Sp. Gr. at 15° C.	Acid Number.	Ether Number.	Ratio.	Total.	Adulterants.
1	63.80	0.9640	19.60	75.60	3.85	95.20	
2	62.81	0.9608	29.40	70.00	2.48	99.40	Stearic acid.
3	48.00	0.9250	25.13	48.30	1.12	73.43	Chrome yellow, rosin and paraffin.
4	63.20	0.9602	18.20	65.80	3.61	84.00	Some ceresin.
5	52.00	0.9100	4.20	12.60	3.00	16.80	Yellow ochre, earthy matter and paraffin.
6	63.80	0.9624	20.30	77.00	3.78	97.30	
7	54.42	0.9120	14.70	45.59	3.10	60.29	Paraffin.
8	55.00	0.9250	4.61	16.10	3.49	20.71	Earthy matter, Hematite and paraffin.
9	60.00	0.9420	26.20	59.50	2.26	85.70	Paraffin and stearic acid.
10	49.00	0.9400	43.58	0.00	?	49.58	Chrome yellow, rosin and paraffin.
11	63.00	0.9620	18.04	74.49	4.13	92.53	
12	50.00	0.9410	18.57	0.00	?	18.57	Chrome yellow, rosin and paraffin.
13	66.00	0.9459	16.80	56.00	3.33	72.80	Ceresin.
14	65.00	0.9550	16.20	75.58	3.60	93.78	
15	66.00	0.9350	11.20	37.61	3.35	48.81	Mineral wax.
16	63.10	0.9581	29.40	71.40	2.43	100.80	Stearic acid.
17	59.00	0.9431	17.50	71.35	4.01	88.85	Paraffin.
18	74.00	0.9210	10.50	19.60	1.86	30.10	Mineral wax.
19	64.41	0.9581	17.50	67.20	3.84	84.70	Paraffin and rosin.
20	62.81	0.9690	21.70	81.90	3.77	103.61	
21	62.45	0.9501	18.91	71.51	3.77	90.42	Paraffin.

Philadelphia, Pa.

The Tornado in St. Louis a few weeks ago was a terrible destroyer of both life and property. In the last Progressive Bee-Keeper (which is published in Missouri), Editor Leahy says:

"The tornado which visited St. Louis last week is without parallel in the history of our country. Hundreds of lives were lost, and millions of dollars' worth of property destroyed; homes laid waste, and hearths made desolate, while sad-eyed mourners watch and wait in vain for those who never come. In a recent card, Mr. E. T. Flanagan, of Belleville, Ill., states that the report of the storm was not in the least exaggerated, and that the destruction of life and property is simply awful. He also informs us that the tornado destroyed over \$500 worth of fruit for him, but his bees escaped, and he is thankful that the lives of his family and himself were spared."

Chicago, as well as other cities, have done much to aid in relieving the suffering in East St. Louis and St. Louis, caused by the devastating tornado. How quickly suffering levels all, and calls out generous sympathy.

Sacaline.—In reply to several inquiries, Mr. A. I. Root, in Gleanings for June 15, has this to say about the plant called sacaline, which was mentioned a year or so ago as a honey-plant:

"Sacaline, at the present writing, even in our rich plant-beds, is only 4 or 5 feet high. I thought if it grew 17 feet, as the catalogues claim, on ordinary ground, possibly it might grow 25 or 30, or possibly as tall as the giant bamboo in Florida, if I put it in the rich plant-beds. Of course, it did not do much last season, but I supposed it was getting rooted; but the present indications are that it will not do much better this year. Perhaps I gave it too good a chance. A plant that I put in hard ground near a slop-drain seems to be of a little healthier color; but none of them so far come anywhere near what the catalogues represent."

THE AMERICAN BEE JOURNAL

ESTABLISHED IN 1861

OLDEST BEE PAPER IN AMERICA

PUBLISHED WEEKLY BY

GEORGE W. YORK & COMPANY,

118 Michigan St., - CHICAGO, ILL.

REGULAR CONTRIBUTORS :

G. M. Doolittle, of New York. Prof. A. J. Cook, of California.
 Dr. C. C. Miller, of Illinois. Dr. J. P. H. Brown, of Georgia.
 J. H. Martin, of California. Rev. E. T. Abbott, of Missouri.
 Barnett Taylor, of Minnesota. Mrs. L. C. Axtell, of Illinois.
 Chas. Dadant & Son, of Illinois.

\$1.00 a Year—Sample Copy Sent Free.

[Entered at the Post-Office at Chicago as Second-Class Mail-Matter.]

Vol. XXXVI. CHICAGO, ILL., JUNE 25, 1896. No. 26.



Distributing Honey-Pamphlets.—The Buffalo County Bee-Keepers' Association, of Nebraska, at its last meeting, resolved to purchase 100 copies of "Honey as Food and Medicine," to be distributed by the members to their friends, for the purpose of increasing the demand and consumption of honey. This is a good move, surely. It is the kind of work that will pay every member of that Association. Others should "go and do likewise."

We will supply the above pamphlet, by express, for \$1.50 per 100 copies. Now is the time to "sow the seed"—just before the honey is ready to market.

Shipping Queens Promptly.—Mr. W. P. Faylor, on page 403 of this number, calls attention to what sometimes is an unbearable as well as wholly inexcusable evil on the part of queen-dealers. This thing of not notifying the customer when the dealer cannot send a queen *promptly*, is the cause of much annoyance, and often loss.

About a week ago a Colorado subscriber complained to us about two queen-dealers who advertised in the Bee Journal about two months ago. One of them waited until the customer wrote to him, and wanted either the queen or his money back. In a few days he got the money, but not a word *why* the queen was not sent. From the other he has not yet had even his money returned, let alone the queen. At least so he reports to us.

The result of the above experience was, that our Colorado friend lost a colony of bees valued at \$5.00. Of course, the negligent queen-dealers should stand the loss, as it was entirely their fault. For if they had answered promptly, that they could not supply the queens, the buyer could have gotten one elsewhere, and thus have saved his colony.

We hope all queen-dealers who read this will be very careful to see that they cause their customers no unnecessary worry and perhaps needless loss.

Beeswax and Its Adulterants—the article by Prof. Kebler, on page 405—is well worth a careful reading. True, it is rather lengthy, but it is a big subject, and one that needs attention. It is really alarming, the extent to which

beeswax is adulterated in cities, especially in Chicago. We know of at least two firms here that make a business of adulterating pure beeswax with cheap ceresin, and then placing it on the market simply as "beeswax."

When attempting to get laws against honey-adulteration, we may as well include beeswax. We would like to see the Bee-Keepers' Union try its heretofore invincible hand at getting some anti-adulteration laws in the interest of the producers of pure honey and pure beeswax. If only Illinois had a good law on the subject, the American Bee Journal would enjoy helping to see that it is enforced. So long as the adulteration business is allowed to go on without any check whatever, just so long will the prices of honey and beeswax continue to decline.

If our Government wishes to do something really helpful to honest bee-culture, it probably could do no better than to give us some good anti-adulteration laws, with severe enough penalties attached so that one good enforcement would last awhile.

Lysol and Foul Brood.—In the May Review, Editor Hutchinson says this about lysol as a cure for foul brood:

"Lysol and its value in cases of foul brood appears to me in a different light after reading the article of F. L. Thompson on that subject. It seems that the feeding of lysol may cure foul brood; but if there is infected honey in the hive, the use of that honey at some future time will again bring in the disease. In other words, foul brood can never be permanently eradicated from a colony so long as its old combs of honey are left in the hive. The use of lysol in a region of country where there are colonies of bees infected with foul brood may be a good thing—it certainly would be if its use would prevent the contraction of the dread disease, and Mr. Thompson seems sure that it will. For this purpose I can see that the use of some drug might be valuable. I suppose the philosophy of the matter is that, if all of the honey is brought into the hive in times of scarcity, at times when bees will rob, is tinctured with lysol, any germs of disease that are brought in will come in contact with the lysol, and thereby be killed."

Honey Crop for 1896.—The American Bee-Keeper for this month says:

"It looks now as if the honey crop of 1896 will be the largest for several years. The weather since spring opened has, in this locality, been all that the bee-keeper could ask for."

Another editorial in the same paper, reads as follows:

"The bee-industry in the Eastern States is pretty 'dead' this season, as is shown by the letters and small number of orders received."

Gleanings for June 15 starts off with this hopeful editorial item:

"The reports of the good times we *hope* are coming, or perhaps already here, are just beginning to come in. Here is a sample:—"

We are in the midst of the heaviest honey-flow I ever saw—raspberry and other wild flowers.
 Morrill, Minn., June 8. A. T. MCKIBBEN.

"Our bees are just starting on the basswoods, and by the myriads of buds now opening, we anticipate a good flow of honey."

Nearly all bee-keepers around Chicago report bees hard at work now. Basswood is in bloom, and sweet clover soon will be. We have heard it said that there is no better locality for bees anywhere than right around this big city. So far as we know, there is scarcely ever a crop failure.

We have been surprised this year, to find that there are so many keeping bees either in Chicago, or just outside of it. It seems to us that there might be a fine Chicago bee-keepers' association organized. Philadelphia has one.

PERSONAL MENTION.

MR. C. H. DIBBERN, of Milan, Ill., in a letter dated June 17, said: "Bees are now booming on basswood, and are gathering honey freely."

CHAS. DADANT & SON, of Hamilton, Ill., in a letter dated June 15, say: "We have been looking for a clover honey crop, and may get it yet. We have a fine prospect for grapes."

EDITOR E. R. ROOT, in Gleanings for June 1, has this appreciated sentence: "The department of 'Personal Mention,' in the American Bee Journal, is an interesting feature of that periodical."

MRS. E. G. BRADFORD, of Hagley, Del., wrote on June 17: "I find the American Bee Journal a great help, and I am much interested in it. I have fine Italian bees, which give me a great deal of pleasure; and also a great deal of honey."

MR. E. T. CARRINGTON, of Pettus, Bee Co., Tex., reported on June 10, that he had averaged 100 pounds of honey per colony so far this year. He says he never saw such a good place for honey as where he lives. Mr. C. is running a small advertisement in our columns. Better look it up.

MR. L. SYLVESTER, of Aurora, Ill., called on us last week. He reported that bees were working on sweet clover bloom, which was nearly one month earlier than usual. Last year from that source he secured some 1,600 pounds of comb honey. Mr. S. is a contractor and builder, but finds time to take good care of his bees.

MR. GEO. W. BRODBECK, of Los Angeles, Calif., reports very discouragingly about the prospects for a honey crop this year in that State. He says it was a fortunate thing for himself that he left his bees last year with an abundance of stores, for otherwise he would have been forced to feed to preserve them. This makes it very unfortunate for the new Bee-Keepers' Exchange, but its members purpose holding together and wait for better times. Surely, all will be interested in the success of the Exchange, and will regret it if anything interferes.

MR. JAMES B. DRURY, of New Orleans, La., writing on June 13, kindly said: "I do not know how I would get along without the 'Old Reliable.' I take several papers, and I am always most anxious when Saturday comes to get it as soon as possible. I have all the copies, and have a pile of the last year's before me. It is a wonder how you can afford to send such a vast mass of reading-matter for the trivial sum of one dollar. Why, Mr. Editor, in some things, if not all, it is even better than a copy of 'Langstroth Revised,' or 'Bees and Honey,' as they are becoming old, while the American Bee Journal is always up to date."

DR. MILLER, writing on June 17, said this about his bee-work these days:

"We've had a busy time of it with the bees. Been getting up at 4 o'clock—this morning 4:15—and working till dark. One evening we didn't get home to supper till 8:30. One trouble has been so much bad weather when we couldn't work. Oh, for some hot weather."

Seems to us the Doctor is getting out pretty early for a man over 65 years of age. Sixteen hours a day is rather long, though we have often put it in, both on the farm and since being in the city. But then, we are only about half his age. Better take things easier, Doctor, or you won't live to be 100—the length of life your many friends hope you will attain unto, at least.

Questions AND Answers

CONDUCTED BY

DR. C. C. MILLER, MARENGO, ILL.

[Questions may be mailed to the Bee Journal, or to Dr. Miller direct.]

What Ails the Bees?

On April 24 the bees were all in fairly good condition, and from that time on to June first they fell off gradually; in order to build them up I united them all, two and two together, but that did not do any apparent good, for at the present time the strongest colony has not a pint of bees. What can be the cause? There were very few bees dead around the hives, showing that they must have died in the fields. I saw lots of them come out of the hive, and would try four or five times to fly before they would make it, each trial making only about two or three feet, and then drop to the ground. I also observed dead brood in them all, with the brood-nest at the present time not more than 4 square inches on each side of one frame, with some of the cells having as high as four and five eggs in them. They have lots of honey in the hives. Is it foul brood or bee-paralysis, or were they poisoned from spraying the fruit-bloom?

J. S.

Denver, Colo.

ANSWER.—I'm sorry to say I don't know what the trouble is, but it looks a good deal like a case of some kind of poisoning. If any one has any light to shed upon the case, let him rise.

Getting Bees Into Supers—Controlling Robbing.

Early in the spring I divided one black and one Italian colony (all I had), thus making four. The blacks reared a queen of their own, the other also, but the latter disappeared on her mating trip. So I got a choice yellow queen from a breeder at San Mateo. We had a long, dry spell, and the bees will not go into the super, although the palmetto is in full bloom, and the lower department is crowded with honey. Also, the yellow ones have developed to be arrant robbers of the two old mother colonies. Now, how shall I break them of that, and how shall I make them go above?

T. D.

Pabor Lake, Fla.

ANSWERS.—If the super is placed directly over the brood-nest, so there is direct and ready entrance, the bees will usually go to work in the super when they have plenty of honey to store there. But sometimes they are slow about it, and something may be done to make them commence work in the super sooner than they otherwise would. If working for extracted honey, put a frame of brood in the super until they commence storing there, although that can be necessary only when there is nothing but foundation in the super. If working for comb honey, put in the super a section containing comb at least partly drawn out. If the comb is fully drawn out, all the better. Such a bait section will be commenced on very promptly, and if the yield is very light, you may have the bait section filled and sealed and not another section touched. But if there is honey enough, the bees will extend their attentions to the other sections. If you have no bait sections, cut a piece of brood out of a brood-frame—drone-brood is as good as any—put it in a section, and put in the super, and if there's any honey to store you will find the bees carrying it into the super.

Controlling the robbers is not so easy a matter. You can't do anything with the robbers themselves unless you brimstone them or kill them in some other way, so your whole attention must be directed to the bees that are being robbed. And it's very much harder to break up robbing when once started

than to prevent it in the first place. Some bees will protect themselves better than others, blacks, as a rule, making a less defence than Italians. If a colony of moderate strength will allow itself to be robbed, better change the stock for something of better blood. If a weak colony has trouble defending itself, help it by closing the entrance partly. In some cases it may be necessary to allow an entrance only large enough for one bee to pass at a time. In a bad case of robbing, pile hay or straw in front of the hive and around it, and keep the hay well wetted by pouring or spraying water upon it.

A weak queenless colony will sometimes give up to robbers, and nothing you can do seems to be of any use. The only thing is to break it up. But be careful about taking out of the way a hive upon which the robbers have been at work. If you take the hive away bodily, the robbers will not understand it, and will suppose it is somewhere in the neighborhood, and will make a desperate assault upon one of the nearest colonies. But if you leave it until the robbers have emptied it, the neighboring colonies will likely not be disturbed. If, however, you leave a similar hive in place of the one removed, the bees will work upon that. Leave a comb, or piece of comb, in the hive with a little honey in it, and when the robbers finish that they will be satisfied without attacking neighboring colonies.

Several Questions About Carniolan Bees.

1. What is a silver-gray Carniolan?
 2. Are they more prolific than Italians?
 3. Are they better nectar-gatherers?
 4. Are they any better than Italians?
 5. Are they any harder than Italians?
 6. Are they proof against the bee-moth?
 7. Are they any larger or smaller than the Italians?
 8. Which is the better, in your opinion, Italian or Carniolan?
 9. Would a cross between them be of any value?
 10. Do they rob as much as Italians or blacks?
 11. Will they work in the supers earlier than Italians?
- Any other information that you can furnish through the "Old Reliable" will be very thankfully received by the undersigned.
- J. B. D.

ANSWERS.—1. Carniolans are sometimes called silver-gray Carniolans to distinguish them from those that are more or

less mixed with other races, so silver-gray Carniolans are simply Carniolans. They come from Carniola, Austria, and at a hasty glance might be called common black bees. Indeed, so close is the resemblance that some good authorities have said the difference could be easily distinguished, but could not be described. I think, however, that you will have no difficulty in distinguishing them at sight by noticing the distinct white rings on the abdomen, that the common black bee does not possess.

2. From all the testimony given, they are fully as prolific as Italians; hardly more so.

3. I think not.

4. Yes, they are the gentlest of all races, according to the testimony of those who have handled them much, while others say they are very savage. These conflicting statements probably come from the fact that some which have been sent out as pure were not so, or else that a very great difference exists in different colonies.

5. The claim has been made that they are hardier, and as they come from a comparatively cool climate one would expect them to be hardy.

6. I have never seen such claim made, neither have I seen the objection made that they succumb readily to the moth, so I suppose in that respect they do not differ from Italians.

7. The workers are said to be larger than Italians. I have never seen but a few specimens, and I think you would not readily notice any difference in size.

8. From the fact that I have never kept Carniolans, my personal opinion would be of little value. Some speak very highly of them, but after being introduced into this country a number of years, they do not seem to grow in popularity. Indeed, the statement has been repeatedly made that no pure Carniolans can now be found in this country, and their great swarming propensities form an undesirable trait. In their favor is the whiteness of their cappings.

9. With proper selection a desirable cross might be obtained.

10 and 11. I do not know that there is any difference. If you have Italians, you may do well not to change for Carniolans till you have tried the latter on a small scale.

Question-Box.

In the multitude of counsellors there is safety.—Prov. 11-14.

Section Folding and Foundation Fastening in One Machine.

Query 19.—What objections, if any, are there to the combination of section-folding and foundation-fastening in one machine?—COLORADO.

E. France—I have no objections.

G. M. Doolittle—I never tried the combination.

R. L. Taylor—None, if the machine works well.

P. H. Elwood—I have never used a folding-section.

W. R. Graham—I have no objections to such a machine.

Chas. Dadant & Son—There are several of these machines made.

Dr. J. P. H. Brown—I have no experience with the "combination."

C. H. Dibbern—None at all, if the machine will do both equally well.

H. D. Cutting—No objection if the machine does its work satisfactorily.

Eugene Secor—None that I know of, if the combined machine does the work well.

Dr. C. C. Miller—I don't know of any if the work is done as well and as quickly.

James A. Stone—I cannot see any, though on trial I do not know how it might be.

Allen Pringle—If the machine will do both efficiently and expeditiously, I can see no objections.

W. G. Larrabee—I do not see what objection there can be if the work is done just as well.

Prof. A. J. Cook—The more good work any machine does, the better. I have used no such machine.

J. M. Hambaugh—If such a machine can be made to work perfectly, it would be an acquisition to honey-producing paraphernalia.

Rev. M. Mahin—If such a machine can be made, I do not know of any objection against it. All would depend upon the machine.

B. Taylor—I never used one, and do not know. As a general principle, I do

not favor combination machines. In my shop, each class of work is done on a special machine.

Mrs. L. Harrison—I never used a machine in folding sections. Too much pleasure in doing it the old way; it's a long time since I've had the pleasure.

Emerson T. Abbott—None, if the work is done as effectively and as rapidly. Generally speaking, "combinations" are not the most desirable things in the world.

J. E. Pond—None whatever, that I can see. Economy both of time and expense is the point to be provided for, and should be the end sought after in experimental apiculture.

G. W. Demaree—Nobody objects, I presume. But the combination is impracticable, nevertheless. I use a little machine devised by John Reese, of this State, that squares the sections by simply pressing a little treadle with the foot; and I fix the "starters" in place by a little machine of my own devising, that does the work by a slight pressure of one hand.

Bee-Keeper's Guide—see page 412.

General Items.

The Dadant Hive.

I would like to receive, through these columns, an expression of how the Dadant hive compares with others, from any who have them. Having nearly decided to use a number of those hives the ensuing year, I await a reply.

Sound Beach, Conn. E. MUNSON.

Bees Doing Fairly Well.

We had a failure here with bees last season, and this spring was too wet. Bees have been doing fairly well lately; some are building in sections. I have 75 colonies, all in good cedar hives.

JOHN UPHOUSE.

Sedro, Wash., May 31.

Honey Will Soon Roll In.

The American Bee Journal reaches me promptly every week, and is well read and noticed. The "Personal Mention" department is good; lots of truth in it. It takes a No. 1 expert queen-breeder to rear and sell 5,000 queens in one season. Alfalfa is just commencing to bloom in this locality, and the honey will soon roll in.

SIGEL BRAUTIGAM.

Cliff, New Mex., June 10.

The Spring Problem.

As I lately wrote under "the wintering problem," giving some of my experience in wintering, I would like to extend the account of my experience to the present date.

After the examination of my colonies about the middle of April, I let them "severely alone" until May 27, when they commenced to swarm. At this time just about half of my colonies have cast swarms, and the other half apparently are ready to swarm. Considering that I am located in latitude 43½ degrees, on the hills of New Hampshire, and that we have had a very dry spring, it seems to me that these facts show the wisdom of my management.

J. P. SMITH.

Sunapee, N. H., June 5.

Annianias and Sapphira Stories.

Dear, me! Why couldn't I have had that sweet plum (mentioned on page 362) to put in my essay—"Bee-Culture for Women"—delivered at Atlanta: "two women who have incomes of \$5,000 each, annually, selling queens?" While these women have been making big money I've been fooling away my time in a land of drouths and repeated failures of honey crops; while these women live in an El Dorado for bee-keepers, where there is a demand for queens "annually." I'm getting to be very credulous about women who report such golden eggs as the bees lay for them. I've been reliably informed that they never crimp or bang their hair, wear big sleeves, or gored skirts. Mrs. Lizzie or Jennie are better drawing cards than Johnnie or Jimmie.

When I was a child I went to Sunday-school, and read the story of Annianias, and Sapphira, his wife; it was so impressed upon my young, plastic mind

THE "NOVELTY" POCKET-KNIFE!

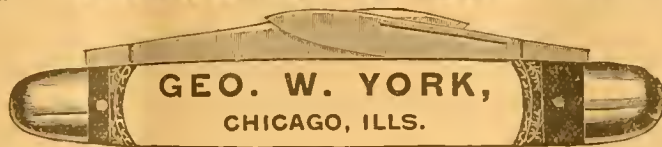

Your Name on the Knife.—When ordering, be sure to say just what Name and Address you wish put on the Knife.

The NOVELTY KNIFE is indeed a novelty. The novelty lies in the handle. It is made beautifully of indestructible celluloid, which is as transparent as glass. Underneath the celluloid, on one side of the handle is placed an AMERICAN BEE JOURNAL reminder, and on the other side, name and residence of the Subscriber.

The material entering into this celebrated knife is of the very best quality; the blades are hand-forged out of the very finest English razor-steel, and we warrant every blade. The bolsters are made of German silver, and will never rust or corrode. The rivets are hardened German silver wire; the linings are plate brass; the back springs of Sheffield spring steel, and the finish of handle as described above. It will last a lifetime, with proper usage.

Why purchase the Novelty Knife? In case a good knife is lost, the chances are, the owner will never recover it; but if the Novelty is lost, having name and address of owner, the finder will return it; otherwise to try to destroy the name and address, would destroy the knife. If traveling, and you meet with a serious accident, and are so fortunate as to have one of the Novelties, your pocket KNIFE will serve as an identifier; and in case of death, your relatives will at once be apprised of the accident.

How appropriate this knife is for a Christmas, New Year or birthday present! What more lasting memento could a mother give to a son, a wife to a husband, a sister to a brother, a lady to a gentleman, or vice versa, a son to a mother, a husband to a wife, a brother to a sister or a gentleman to a lady—the knife having the name of the recipient on one side?

The accompanying cut gives a faint idea, but cannot fully convey an exact representation of this beautiful knife, as the "Novelty" must be seen to be appreciated.

How to Get this Valuable Knife.—We send it postpaid, for \$1. , or give it as a Premium to the one sending us three new Subscribers to the BEE JOURNAL (with \$3.00), and we will also send to each new name a copy of the Premium Edition of the book "Bees and Honey." We club the Novelty Knife with the BEE JOURNAL for one year, both for \$1.90.

Any Name and Address Put on the Knife.

GEORGE W. YORK & CO.,
CHICAGO, ILLS.

Allow about two weeks for your order to be filled.

PATENT WIRED COMB FOUNDATION

Has No Sag in Brood-Frames

Thin Flat-Bottom Foundation

Has No Fishbone in the Surplus Honey.

Being the cleanest is usually worked the quickest of any Foundation made

J. VAN DEUSEN & SONS,
Sole Manufacturers,
Sprout Brook Montgomery Co., N. Y.
Mention the American Bee Journal



ONE MAN WITH THE UNION COMBINATION SAW

Can do the work of four men using hand tools, in Rippling, Cutting-off, Mitring, Rabbeting, Grooving, Gaining, Dadoing, Edging-up, Jointing Stuff, etc. Full Line of Foot and Hand Power Machinery Sold on Trial. Catalogue Free.

SENECA FALLS MFG. CO.,
46 Water St., SENECA FALLS, N. Y.
1 A 1 y Mention the American Bee Journal.

Dadant's Foundation in Chicago!

No other Goods kept here. Send for Price-List.

CHAS. DADANT & SON,
118 Michigan St., CHICAGO, ILL.
13 A 1 f Please mention the Bee Journal.

3-Frame Nucleus

and Italian Queen, after July 1st, \$2.50. Untested Queens, 75c each. Discount on quantities. A Catalogue of Practical Apian Supplies, Free. Address,

I. J. STRINGHAM,
105 Park Place. NEW YORK, N. Y.



That Queen-Clipping Device Free!

Works Like a Charm.

The Monette Queen-Clipping Device WORKS LIKE A CHARM. With it I have clipped 30 queens, all in one day, when examining my bees. WM. STOLLEY, Grand Island, Nebr.

Couldn't Do Without It.

I have clipped 19 queens, and must say the Monette Queen-Clipping Device is by far the best invention ever made, and will be welcome to many bee-keepers as it was to me. I could not do without one now.

DR. GEO. LACKE, Newburgh, Ind.

PLEASE READ THIS OFFER TO PRESENT SUBSCRIBERS:

Send us just one new name for the American Bee Journal a year (with \$1.00), and we will mail you the Queen-Clipping Device FREE of charge. Or, the Queen-Clipping Device will be sent postpaid for 30 cts. But why not get it as a Premium by the above offer? You can't earn 30 cts. any easier. Almost every bee-keeper will want this Device. See page 130 (Feb. 27) for full description of it. Complete directions accompany each one sent out. It is a most ingenious and useful article. Address,

GEORGE W. YORK & CO., 118 Michigan St., Chicago, Ill.



✦ MONEY SAVED IS MONEY GAINED. ✦

THE ROYAL UNION Life Insurance Company DES MOINES, IOWA.

The Iowa Policy

Is one that definitely promises to keep an accurate account with you; credit your premiums and interest, charge the actual expense and mortality cost, and hold the remaining funds subject to your order.
Agents Wanted.

JOHN B. KING, GENERAL AGENT,
Suite 513 First Nat'l Bank Bld'g,
20A1f **CHICAGO, ILL.**
Mention the American Bee Journal.

**WARRANTED GOLDEN
ITALIAN QUEENS** By return mail; bred from a Breeder tested by Doolittle out of 1,000 Queens for his own use, and valued at \$50. Queens, 50c; 6 for \$2.75; or \$5.00 per dozen.

Leather Colored Queens from Root's best imported stock same price. Bees from my Queens are excellent workers on red clover. I guarantee safe delivery. N. B.—I sent more than 200 Queens safely to California last season. **H. G. QUITIN, Bellevue, Ohio.**

23A16 Mention the American Bee Journal.

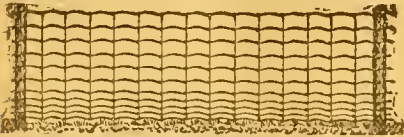

A SOFT ANSWER

Works on the same plan as elasticity, but besides "turning away wrath," ELASTICITY turns away domestic and wild animals, practically insuring the farmer against loss. The PAGE is full of ELASTICITY, and like the soft answer, has such a winning way. It makes friends wherever it goes.

PAGE WOVEN WIRE FENCE CO., Adrian, Mich.

WHEN ANSWERING THIS ADVERTISEMENT, MENTION THIS JOURNAL.

IF YOU WANT THE —BEE-BOOK

That covers the whole Apicultural Field more completely than any other published, sent \$1.25 to Prof. A. J. Cook, Claremont, Calif., for his

Bee-Keeper's Guide.

Liberal Discounts to the Trade.

California ❁❁

If you care to know of its Fruits, Flowers Climate or Resources, send for a Sample Copy of California's Favorite Paper—

The Pacific Rural Press

The leading Horticultural and Agricultural paper of the Pacific Coast. Published weekly, handsomely illustrated, \$2.00 per annum. Sample Copy Free.

PACIFIC RURAL PRESS,
220 Market St., - SAN FRANCISCO, CAL.

TEXAS QUEENS.

If you are in need of Queens, let me have your order. Price-List Free.

8A26t **J. D. GIVENS, Lisbon, Tex.**
Mention the American Bee Journal.

Full Colonies of Italian Bees for \$4.00. No. 2 Sections that will be sold at 50 cts. per 1,000; or 2,000 Snow-White sections will be sold for \$4.00, and larger quantities at still lower prices. Send for Circular and see the prices on a full line of supplies. 16A1f

Address, **T. H. KROER,**
426 Willow St., **TERRE HAUTE, IND.**
23A4t Mention the American Bee Journal.

that I'm a poor person to write flowery articles on bee-culture.

While attending school I read the fable of the hen that laid a golden egg every day, and her owner killed her, thinking to get the gold all in a lump, and he was surprised to find only what was in other hens. And that is just my experience with bee-culture—the same as in other hens. If a person has a good soil, works it well, plants good seed, and he is blessed with a growing season, he will harvest a good crop, be it potatoes, corn or beans. I'm not the favored person who harvests a crop of honey whenever there is nectar secreted in the flowers or not. **MRS. L. HARRISON,**
Peoria, Ill.

Working Well.

Bees are working well. I have had one swarm so far. Success to the American Bee Journal. It never misses to get here. I hope it will have a prosperous year for 1896. **HENRY W. BROWN,**
Scottville, Mich., June 5.

Basswood Promises Extra-Good.

I had 21 colonies of bees, spring count. They are all in good condition now, with considerable white clover and mustard in bloom. Basswood promises to be extra-good this year.

P. G. ABBOTT,
Mt. Auburn, Iowa, June 11.

Best Prospects in Several Years.

The prospects for a good yield of honey this year are the best in several years. I started in the spring with 8 colonies, having lost 3 out of 11, which were queenless. I have had 4 new swarms—one in May, three the first of June. The bees are doing well, considering the amount of windy and rainy weather, for it rains most of the time. The fruit-trees are loaded down with blossoms, and raspberries, too. The bees have commenced killing off the drones, but there are plenty left yet. I winter my bees on the summer stands, in 10-frame Langstroth chaff hives.

IRA D. HYDE,
Worden, Mich., June 8.

Several Bee-Notes.

While there is always much of interest in the Bee Journal, the June 4th number seems unusually good. Mr. Davenport's and Mrs. Harrison's letters are helpful, especially to beginners.

I have for several years been buying queens, watching the Bee Journal advertisements for "snaps;" never buying more than two queens of one man, and I can say I have never failed in but one instance to get good value for my money, and I believe the Bee Journal advertisers are men who will do as they agree. The single instance mentioned was for a \$1.50 tested queen that was fine colored, but an "old lady" that should have been laid on the shelf. She was almost beyond laying, and had I not reared a young queen from her, she would have been a total loss, as she died the next winter, and I lost the colony in the spring.

The honey business must be about as far down the toboggan slide as it can get. I have sold nice white honey

The Bee-Keepers' Guide:

Or Manual of the Apiary,

By Prof. A. J. Cook.

This 15th and latest edition of Prof. Cook's magnificent book of 460 pages, in neat and substantial cloth binding, we propose to give away to our present subscribers, for the work of getting new subscribers for the American Bee Journal.

A description of the book here is quite unnecessary—it is simply the most complete scientific and practical bee-book published to-day. Fully illustrated, and all written in the most fascinating style. The author is also too well-known to the whole bee-world to require any introduction. No bee-keeper is fully equipped, or his library complete, without "THE BEE-KEEPER'S GUIDE."

Given For 2 New Subscribers.

The following offer is made to PRESENT subscribers only, and no premium is also given to the two new subscribers—simply the Bee Journal for one year:

Send us Two New Subscribers to the Bee Journal (with \$2.00), and we will mail you a copy of Prof. Cook's book FREE as a premium. Prof. Cook's book alone sent for \$1.25, or we club it with the Bee Journal for a year—both together for only \$1.75. But surely anybody can get only 2 new subscribers to the Bee Journal for a year, and thus get the book as a premium. Let everybody try for it. Will you have one?

GEORGE W. YORK & CO.,
CHICAGO, ILLS.

A Bargain—EARLY QUEENS.

119 Colonies Italian Bees in Chaff Hives; two acres land; good house; excellent well.

Early Queens—Tested, \$1.00; Untested, 50c. Sent by return mail.

E. L. CARRINGTON,
16A1f **PETTUS, Bee Co., TEX.**
Reference—1st National Bank of Beeville.

Mention the American Bee Journal

CARLOADS



Of Bee-Hives, Sections, Shipping-Cases, Comb Foundation, and Everything used in the Bee-Industry.

I want the name and address of every Bee-Keeper in America. No reason why you cannot do business with me. I have Cheap Lumber and Experienced Workmen; a good Water-Power Factory and know how to run it. I am supplying Dealers as well as consumers. Why not you? Send for Catalogues, Quotations, etc. **W. H. PUTNAM,**
1E **RIVER FALLS, Pierce Co., Wis.**

Mention the American Bee Journal.

Page & Lyon Mfg. Co.,

New LONDON, Wis., operates two saw-mills that cut, annually, eight million feet of lumber, thus securing the best lumber at the lowest price for the manufacture of bee-keepers' supplies. They have also just completed one of

The Largest Factories,

and have the latest and most improved machinery for the manufacture of Bee-Hives, Sections, etc., that there is in the State. The material is cut from patterns, by machinery, and is absolutely accurate. For Sections, the clearest and

The Whitest Basswood

is used, and they are polished on both sides. Nearness to pine and basswood forests, and possession of mills and factory equipped with best machinery, all combine to enable this firm to furnish the best goods at

The Lowest Prices. ♡

For instance, it has a job lot of 200,000 No. 2 Sections that will be sold at 50 cts. per 1,000; or 2,000 Snow-White sections will be sold for \$4.00, and larger quantities at still lower prices. Send for Circular and see the prices on a full line of supplies. 16A1f

Mention the American Bee Journal.

can't expect a big crop of corn, wheat and hay. We had two short crops of corn. I have a good prospect for good crops of wheat, corn and potatoes. The hay crop will be short, but I will carry over about 12 tons for another year. We can't complain, only if wheat would get better in price. I am hauling my last year's crop of wheat at only 65 cents per bushel.

The fruit crop will be very short—no apples—but the prospect for peaches is very good so far. L. A. HAMMOND.
Keedysville, Md., June 8.

LATER.—June 15.—The long drouth has been broken with lots of rain, almost floods in places, and everything is in a flourishing condition. The bees are rolling the honey in. L. A. H.

Queens and Queen-Rearing.—

If you want to know how to have queens fertilized in upper stories while the old queen is still laying below; how you may safely introduce any queen, at any time of the year when bees can fly; all about the different races of bees; all about shipping queens, queen-cages, candy for queen-cages, etc.; all about forming nuclei, multiplying or uniting bees, or weak colonies, etc.; or, in fact, everything about the queen-business which you may want to know—send for Doolittle's "Scientific Queen-Rearing"—a book of over 170 pages, which is as interesting as a story. Here are some good offers of this book:

Bound in cloth, postpaid, \$1.00; or clubbed with the BEE JOURNAL for one year—both for only \$1.75; or given free as a premium for sending us three new subscribers to the BEE JOURNAL for a year at \$1.00 each.

Please Send Us the Names of your neighbors who keep bees, and we will send them sample copies of the BEE JOURNAL. Then please call upon them and get them to subscribe with you, and secure some of the premiums we offer.

List of Honey and Beeswax Dealers.

Most of whom Quote In this Journal.

- Chicago, Ills.**
R. A. BURNETT & Co., 163 South Water Street.
- New York, N. Y.**
HILDRETH BROS. & SEGELKEN,
120 & 122 West Broadway.
- CHAS. ISRAEL & BROS., 486 Canal St.
- Kansas City, Mo.**
O. C. CLEMOMS & Co., 423 Walnut St.
- Buffalo, N. Y.**
BATTERSON & Co., 167 & 169 Scott St.
- Hamilton, Ills.**
CHAS. DADANT & SON.
- Philadelphia, Pa.**
WM. A. SELSER, 10 Vine St.
- Cincinnati, Ohio.**
C. F. MUTH & SON, cor. Freeman & Central avs.

YOUR BEESWAX !

UNTIL FURTHER NOTICE, we will allow 28 cents per pound for Good Yellow Beeswax, delivered at our office—in exchange for Subscription to the BEE JOURNAL, for Books, or anything that we offer for sale in the BEE JOURNAL. Or, 24 cts. cash.

GEORGE W. YORK & CO.,
CHICAGO, ILLS

VALUE RECEIVED

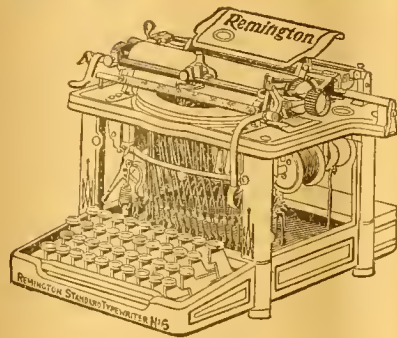

EVERY TIME, SAY BUYERS OF THE

**NUMBER SIX MODEL
REMINGTON**

*** STANDARD TYPEWRITER. ***

Value in Work Done—in Time Saved—in Convenience.

Always Ready. In Service, Always Reliable

Send for Illustrated Booklets.

WYCKOFF, SEAMANS & BENEDICT,

169 La Salle Street,

CHICAGO, ILL.

Mention the American Bee Journal.

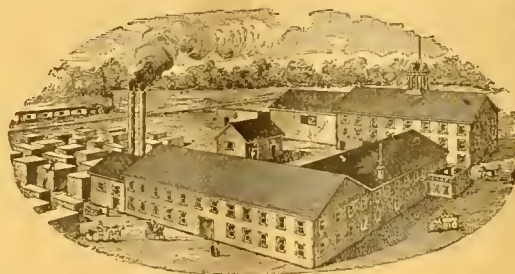

BEE-SUPPLIES !

We have the best equipped Factory in the West. Capacity—one carload a day; and carry the largest stock and greatest variety of everything needed in the apiary, assuring BEST goods at the LOWEST prices, and prompt shipment.

Illustrated Catalog, 80 pages. Free.

Address, **E. KRETCHMER, Red Oak, Iowa.**

ITALIAN BEES.

Untested Queens, \$1.00. Tested, \$1.25. Bees by the lb., \$1.00. Nuclei—Two frame, with Queen, \$2.50; one frame, \$2.00.

Also, Barred and White Plymouth Rock Eggs for setting; \$1.00 for 15.

Mrs. A. A. SIMPSON,
18E7t SWARTS, PA.

Mention the American Bee Journal.

5 per ct. Off to Reduce Stock
on all kinds of SUPPLIES.

—COMB FOUNDATION—

which will be sold in lots of 10 lbs. or more as follows: Medium, 38 cts.; Light, 40 cts.; Thin Surplus, 45 cts.; Extra Thin, 50 cts.

Queens—Untested, 75c.; Tested, \$1.00.

W. J. FINCH, Jr., SPRINGFIELD ILLS.

WOVEN WIRE FENCE

Over 50 Styles The best on Earth. Horse high, Ball strong, Pig and Chicken tight. You can make from 40 to 60 rods per day for from 14 to 22c. a Rod. Illustrated Catalogue Free. KITSELMAN BROS., Ridgeville, - Indiana.

48Etf Mention the American Bee Journal.

Down Go the Prices !

I am having such good luck in queen-rearing, I shall the balance of the season sell our fine **ADEL QUEENS** at the following prices—One Queen, \$1.00; three, \$2.50; six, \$4.50; or one dozen for \$8.00. Safe arrival and quality guaranteed. Cat. free.

HENRY ALLEY,
25Atf WENHAM, Essex Co., MASS.

BEE-BOOKS

SENT POSTPAID BY

George W. York & Co.,
Chicago, Ills.

Bees and Honey, or Management of an Apiary for Pleasure and Profit, by Thomas G. Newman.—This edition has been largely re-written, thoroughly revised, and is "fully up with the times" in all the improvements and inventions in this rapidly-developing pursuit, and presents the apiarist with everything that can aid in the successful management of an apiary, and at the same time produce the most honey in an attractive condition. It contains 230 pages, and 245 illustrations—is beautifully printed in the highest style of the art, and bound in cloth, gold-lettered. Price, \$1.00.

Langstroth on the Honey-Bee, revised by Dadant—This classic in bee-culture, has been entirely re-written, and is fully illustrated. It treats of everything relating to bees and bee-keeping. No apiarist's library is complete without this standard work by Rev. L. L. Langstroth—the Father of American Bee-Culture. It has 530 pages; bound in cloth. Price, \$1.25.

Bee-Keepers' Guide, or Manual of the Apiary, by Prof. A. J. Cook, of the Michigan Agricultural College.—This book is not only instructive and helpful as a guide in bee-keeping, but is interesting and thoroughly practical and scientific. It contains a full delineation of the anatomy and physiology of bees. 400 pages; bound in cloth and fully illustrated. Price, post paid, \$1.25.

Scientific Queen-Rearing, as Practically Applied, by G. M. Doolittle.—A method by which the very best of Queen-Bees are reared in perfect accord with Nature's way. 176 pages, bound in cloth, and illustrated. Price, \$1.00.

A B C of Bee-Culture, by A. I. Root.—A cyclopaedia of 400 pages, describing everything pertaining to the care of the honey-bees. It contains 300 engravings. It was written especially for beginners. Bound in cloth. Price, \$1.25.

Advanced Bee-Culture, Its Methods and Management, by W. Z. Hutchison.—The author of this work is too well known to need further description of his book. He is a practical and entertaining writer. You should read his book. 90 pages, bound in paper, and illustrated. Price, 50 cts.

Rational Bee-Keeping, by Dr. John Dzierzon.—This is a translation of his latest German book on bee-culture. It has 350 pages; bound in cloth, \$1.25; in paper covers, \$1.00.

Bienen-Kultur, by Thomas G. Newman.—This is a German translation of the principal portion of the book called BEES OF HONEY. 103 page pamphlet. Price, 40 cents.

Convention Hand-Book, for Bee-Keepers. Thomas G. Newman.—It contains the parliamentary law and rules of order for Bee-Conventions—also Constitution and By-Laws, with subjects for discussion, etc. Cloth, gold-lettered. Price, 25 cts.

Amerikanische Bienenzucht, by Hans Buschbauer.—Printed in German. A hand-book on bee-keeping, giving the methods in use by the best American and German apiarists. Illustrated; 138 pages. Price, \$1.00.

Thirty Years Among the Bees, by Henry Alley.—Gives the results of over a quarter-century's experience in rearing queen-bees. Very latest work of the kind. Nearly 100 pages. Price, 50c.

Why Eat Honey?—This Leaflet is intended for FREE distribution, to create a Local Market. 100 copies, by mail, 40 cts.; 500 for \$1.50; 1000, \$2.50. If 500 or more are ordered at one time, your name and address will be printed on them FREE.

How to Keep Honey and preserve its richness and flavor. Price same as Why Eat Honey.

Apiary Register, by Thos. G. Newman.—Devotes two pages to a colony. Leather binding. Price, for 50 colonies, \$1.00; for 100 colonies, \$1.25.

Preparation of Honey for the Market, including the production and care of comb and extracted honey. A chapter from BEES AND HONEY. Price, 10 cents.

Bee-Pasturage a Necessity.—This book suggests what and how to plan. It is a chapter from BEES AND HONEY. Price, 10 cents.

The Hive I Use, by G. M. Doolittle. It details his management of bees, and methods of producing comb honey. Price, 5 cents.

Dr. Howard's Book on Foul Brood.—Gives the McEvoy Treatment and reviews the experiments of others. Price, 25 cts.

Dictionary of Apiculture, by Prof. John Phila. Gives the correct meaning of nearly 500 apicultural terms. Price, 50 cts.

Winter Problem in Bee-Keeping, by G. R. Pierce. Result of 25 years' experience. 50 cts.

Handling Bees, by Chas. Dadant & Son.—A Chapter from Langstroth Revised. Price, 8 cts.

Bee-Keepers' Directory, by H. Alley.—Latest methods in Queen-Rearing, etc. Price, 50c.

Foul Brood Treatment, by Prof. F. R. Cheshire.—Its Cause and Prevention. Price, 10 cts.

Foul Brood, by A. R. Kohnke.—Origin, Development and Cure. Price, 25 cts.

History of Bee-Associations, and Brief Reports of the first 20 conventions. Price, 15 cts.

Honey as Food and Medicine, by T. G. Newman.—A 32-page pamphlet; just the thing to create a demand for honey at home. Should be scattered freely. Contains recipes for Honey-Cakes, Cookies, Puddings, Foam, Wines, and uses of honey for medicine. Prices, prepaid—Single copy, 5 cts.; 10 copies, 35 cts.; 50 for \$1.50; 100 for \$2.50; 250 for \$5.50; 500 for \$10.00; or 1000 for \$15.00.

When 250 or more are ordered, we will print the bee-keeper's card (free of cost) on the front cover page.

Bee-Keeping for Profit, by Dr. G. L. Tinker.—Revised and enlarged. It details the author's "new system, or how to get the largest yields of comb or extracted honey." 50 pp.; illustrated. 25c.

Emerson Binders, made especially for the BEE JOURNAL, are convenient for preserving each number as fast as received. Not mailable to Canada. Price, 75 cts.

Commercial Calculator, by C. Ropp.—A ready Calculator, Business Arithmetic and Account-Book combined in one. Every farmer and business man should have it. No. 1, bound in water proof leatherette, calf finish; 4th, Grape Culture; No. 2 in fine artificial leather, with pocket, silicate slate, and account-book. Price, 60 cts.

Green's Four Books, by Chas. A. Green.—Devoted to, 1st, How We Made the Old Farm Pay; 2nd, Peach Culture; 3rd, How to Propagate Fruit-Plants, Vines and Trees; 4th, General Fruit Instructor. Nearly 120 pages. Fully illustrated. 25 cts.

Green's Six Books on Fruit-Culture, by Chas. A. Green.—Devoted 1st, to Apple and Pear Culture; 2nd, Plum and Cherry Culture; 3rd, Raspberry and Blackberry Culture; 4th, Grape Culture; 5th, Strawberry Culture. 129 pp.; illustrated. 25 cts.

Garden and Orchard, by Chas. A. Green.—Gives full instructions in thinning and Marketing Fruits; Pruning, Planting and Cultivating; Spraying, Evaporation, Cold Storage, Etc. 94 pages, illustrated. Price, 25 cts.

Kendall's Horse-Book.—35 pictures, showing positions of sick horses, and treats on all their diseases. English or German. Price, 25 cts.

Silo and Silage, by Prof. A. J. Cook.—It gives the method in operation at the Michigan Agricultural College. Price, 25 cts.

Lumber and Log-Book.—Gives measurements of lumber, logs, planks; wages, etc. 25c.

Maple Sugar and the Sugar Bush, by Prof. A. J. Cook.—Full instructions. Price, 35 cts.

Grain Tables, for casting up the price of grain, produce, hay, etc. Price, 25 cts.

Capon and Caponizing, by Dr. Sawyer, Fanny Field, and others.—Illustrated. All about caponizing fowls, and thus how to make the most money in poultry-raising. 64 pages. Price, 30 cts.

Our Poultry Doctor, or Health in the Poultry Yard and How to Cure Sick Fowls, by Fanny Field.—Everything about Poultry Diseases and their Cure. 64 pages. Price, 30 cts.

Poultry for Market and Poultry for Profit, by Fanny Field.—Tells everything about the Poultry Business. 64 pages. Price, 25 cts.

Turkeys for Market and Turkeys for Profit, by Fanny Field.—All about Turkey-Raising. 64 pages. Price, 25 cts.

Rural Life.—Bees, Poultry, Fruits, Vegetables, and Household Matters. 100 pages. 25 cts.

Strawberry Culture, by T. B. Terry and A. I. Root. For beginners. Price, 40 cts.

Potato Culture, by T. B. Terry.—It tells how to grow them profitably. Price, 40 cts.

Hand-Book of Health, by Dr. Foote.—Hints about eating, drinking, etc. Price, 25 cts.

Alsike Clover Leaflet.—Full directions for growing. 50 for 25 cts.; 100 for 40 cts.; 200, 70c.

Book Clubbing Offers.

(Read Carefully.)

The following clubbing prices include the American Bee Journal one year with each book named. Remember that only ONE book

can be taken in each case with the Bee Journal a year at the prices named. If more books are wanted, see postpaid prices given with the description of the books on this page. Following is the clubbing-list:

1. Langstroth on the Honey-Bee.....\$2.00
2. A B C of Bee-Culture..... 2.00
3. Bee-Keeper's Guide..... 1.75
4. Bees and Honey [Cloth bound]..... 1.65
5. Scientific Queen-Rearing..... 1.75
6. Dr. Howard's Foul Brood Book..... 1.10
7. Advanced Bee-Culture..... 1.30
8. Amerikanische Bienenzucht [Germ.] 1.75
9. Bienen-Kultur [German]..... 1.25
10. Rational Bee-Keeping [Cloth bound] 2.00
11. Rational Bee-Keeping [Paper bound] 1.75
12. Thirty Years Among the Bees..... 1.30
13. Bee-Keeping for Profit..... 1.15
14. Convention Hand-Book..... 1.15
15. Poultry for Market and Profit..... 1.10
16. Turkeys for Market and Profit..... 1.10
17. Capons and Caponizing..... 1.10
18. Our Poultry Doctor..... 1.10
19. Green's Four Books..... 1.15
20. Green's Six Books on Fruit-Culture... 1.15
21. Garden and Orchard..... 1.15
22. Rural Life..... 1.10
23. Emerson Binder for the Bee Journal. 1.60
25. Commercial Calculator, No. 1..... 1.25
26. Commercial Calculator, No. 2..... 1.40
27. Kendall's Horse-Book..... 1.10
29. Strawberry Culture..... 1.20
30. Potato Culture..... 1.20
32. Hand-Book of Health..... 1.10
33. Dictionary of Apiculture..... 1.35
34. Maple Sugar and the Sugar Bush... 1.20
35. Silo and Silage..... 1.10
36. Winter Problem in Bee-Keeping.... 1.30
37. Apiary Register (for 50 colonies).... 1.75
38. Apiary Register (for 100 colonies).... 2.00
39. Bee-Keepers' Directory..... 1.30

Honey & Beeswax Market Quotations.

The following rules for grading honey were adopted by the North American Bee-Keepers' Association, and, so far as possible, quotations are made according to these rules:

FANCY.—All sections to be well filled; combs straight, of even thickness, and firmly attached to all four sides; both wood and comb unsoiled by travel-stain, or otherwise; all the cells sealed except the row of cells next the wood.

No. 1.—All sections well filled, but combs uneven or crooked, detached at the bottom, or with but few cells unsealed; both wood and comb unsoiled by travel-stain or otherwise.

In addition to this the honey is to be classified according to color, using the terms white, amber and dark. That is, there will be "fancy white," "No. 1, dark," etc.

CHICAGO, ILL., June 20.—We quote: Fancy white, 14@15c.; No. 1, 12@13c.; fancy amber, 9@10c.; No. 1, 8@8½c.; fancy dark, 8@9c.; No. 1, 8c. Extracted, white, 5@7c.; amber, 4@5c.

Beeswax, 25@27c. It continues to sell well and there is no accumulation of shipments. We consider it a good time to sell.
H. A. B. & Co.

PHILADELPHIA, PA., Apr. 22.—We quote: No. 1 white, 9@10c.; fancy amber, 8@9c.; fancy dark, 7@8c. Extracted, white clover, 10c.; amber, 5@5½c.; dark, 4@4½c. Beeswax, 25@26c. Comb honey is dull. Extracted in fair demand. Beeswax lower. W. A. S.

BUFFALO, N. Y., Apr. 20.—We quote: Fancy white, 15@16c.; No. 1 white, 13@14c.; fancy dark, 8@9c.; No. 1 dark, 7@7½c. Beeswax, 25@28c. Trade very dull and honey not moving, except a few fancy lots; anything dark is hard to sell. B. & Co.

CINCINNATI, O., Apr. 22.—There is no fancy white comb honey on our market. Best white sells at 12@14c. in a jobbing way, with a fair demand. Demand is good for extracted at 4@7c., according to quality. Beeswax is in good demand at 25@30c. for good to choice yellow. C. F. M. & S.

NEW YORK, N. Y., May 9.—There is some demand for white comb honey at unchanged prices. No market for buckwheat. Extracted remains quiet. New Southern is now arriving and selling at 5@6c. for fine grades and 50@55c. a gallon for fair to common. Beeswax easy at 28@29c. H. B. & S.

KANSAS CITY, Mo., June 20.—We quote: No. 1 white comb, 1-lbs., 13@14c.; No. 3, 11@12c.; No. 1 amber, 11@12c.; No. 2, 8@10c. Extracted, white, 5½@6c.; amber, 5@5½c.; dark, 4@4½c. Beeswax, 22@25c. C. C. C. & Co.

Bottom Prices

**BRING US BIG TRADE.
GOOD GOODS KEEP IT.**

If you want the best supplies that can be made at a little less cost than you can buy the same goods for elsewhere, write to us for low prices. 1896 Catalogue now ready—ask for it and a free copy of **The American Bee-Keeper** (36 pages).

Address,
**THE W. T. FALCONER MFG. CO.,
JAMESTOWN, N. Y.**

Mention the American Bee Journal.

COMB FOUNDATION!

Wax always wanted for Cash or in Exchange for Fdn. or other Supplies. My trade is established on **Low Prices and the merit of my Foundation. Orders filled promptly.**
WORKING WAX INTO FDN. BY THE LB. A SPECIALTY. Wholesale prices to dealers and large consumers. Send for Prices and Samples to—**GUS DITTMER, AUGUSTA, WIS.** Reference—Augusta Bank. 1A7f
Mention the American Bee Journal.

EQUAL TO X RAYS. Our strain of Itallans penetrate red clover blossoms. Choice Untested Queens, 70c.; 3 for \$2—by return mail. A full line of **A. I. Root & Co.'s** goods on hand. 36-page Catalogue Free. **JNO. NEBEL & SON, High Hill, Mo.**
Mention the American Bee Journal. 4A26t

I ARISE



TO SAY to the readers of the **BEE JOURNAL** that **DOOLITTLE**

has concluded to sell **—BEEES and QUEENS—** in their season, during 1896, at the following prices:

- One Colony of Itallans on 9 Gallap frames, in light shipping-box \$6.00
- Five Colonies..... 25.00
- Ten Colonies..... 45.00
- 1 untested queen. 1.00
- 6 " queens 5.50
- 12 " " 10.00
- 1 tested Queen... \$1.50
- 3 " Queens. 3.50
- 1 select tested queen 2.00
- 3 " Queens 4.00

Select tested queen, previous season's rearing 4.00
Extra Selected for breeding, **THE VERY BEST.** 5.00
About a Pound of **BEEES** in a Two-frame Nucleus, with any Queen, \$2.00 extra.

☐ Circular free, giving full particulars regarding the Bees and each class of Queens.
Address

G. M. DOOLITTLE,
12A25t **BORODINO, Onon. Co., N. Y.**
Mention the American Bee Journal.

BEEES QUEENS
Smokers, Sections, Comb Foundation, And all Apian Supplies cheap. Send for FREE catalogue. **E. T. PLANAGAN, Belleisle, Ill.**
6A26t Please mention the Bee Journal.

PURE BARRED PLYMOUTH ROCK

Eggs, \$1.25 per 14. Our P. Rocks are very large, with fine plumage. Also,

BLACK MINORCA EGGS,

a non-sitting and great laying breed. Both kinds raised upon our farm. Minorca Cockrels, \$1.00 each. **Mrs. L. C. AXTELL,**
16A7f **ROSEVILLE, WARREN Co., ILL.**
Mention the American Bee Journal.

19th Year

Dadant's Foundation

19th Year

Is still in the lead, for we use all the latest improvements, including the

NEW WEED PROCESS,

and still make the best goods. Remember that we do not use any acid to purify our beeswax, and that is why our Foundation preserves the smell of the honey and is more acceptable to the bees, than any other. It is kept for sale by

T. H. Strickler, Solomon City, Kansas.
G. K. Hubbard, Fort Wayne, Ind.
L. Hanssen, Davenport, Iowa.
C. Theilmann, Theilmantown, Minn.
E. C. Eaglesfield, Berlin, Wis.
E. T. Abbott, St. Joseph, Mo.
J. M. Jenkins, Wetumpka, Alabama
John Rey, East Saginaw, Mich.
Vickery Bros., Evansville, Ind.

The Jennie Atchley Company, Beeville, Texas.
C. F. Muth & Son, Cincinnati, Ohio.
E. Kretschmer, Red Oak, Iowa.
G. B. Lewis Co., Watertown, Wis.
James Reynolds Elevator Co., Poughkeepsie, N. Y.
Louisiana Bee-Keepers' Supply Manufactory, Donaldsonville, La.
Page & Lyon, New London, Wis.
John Nebel & Son, High Hill, Mo.

and many other Dealers. All agree in saying that no goods are better than ours.

Those of our customers who formerly bought through Thos. G. Newman can get our Foundation in **Chicago, Ill.**, by addressing us at **118 Michigan Street.** We keep no other goods there.

We make a specialty of **Veils and Veil Stuffs** of best quality, cotton and silk.

"LANGSTROTH ON THE HONEY-BEE"—Revised.

Bee-Keepers' Supplies, Smokers, Sections, Tin Pails, etc.
Samples of Foundation and Tulle FREE with Circular. Instructions to beginners with Circular. Send us your address.

CHAS. DADANT & SON,
Mention the American Bee Journal. **HAMILTON, Hancock Co., ILL.**

Williams' Automatic Reversible Honey-Extractor.

Has no sprocket gear or chain at bottom of reel to get dandubed with honey and corrode and break it. The reversing arrangement of the Williams is at the top of the comb-baskets. "The best extractor on the market"—so says the veteran bee-keeper. Mr. N. E. France, of Platteville, Wis.

ITALIAN BEES.

Bright Yellow or Leather-Colored. Queens of either strain—Untested, 60 cents each; two, \$1.00. Select, 75c. Tested, \$1.00. Full Colonies cheap. No foul brood or bee-paralysis. Remit by Express Money Order, payable at Barum, Wis. Many customers send \$1.00 and \$2.00 bills, which are very convenient. Stamps taken for less than \$1.00. **Price-List Free.**

26A7f

VAN ALLEN & WILLIAMS, BARNUM, WIS.

Please mention the American Bee Journal.

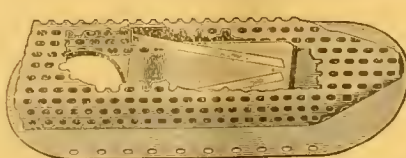

Cornell Bee-Smokers.

Cheap, strong, serviceable. We have sold a good many of these, and so far there has been no complaint; but, on the other hand, there have been scores of letters in their praise. Price, 85 cts. Prepaid, \$1.10.



COWAN.

Cowan and Novice Extractors.

These are the best. We are prepared to furnish, on short notice, from any of our several Branches, 2, 4, and 6 frame Cowaus and 2-frame Novices. If you want the genuine, see that they

bear our name.

A 36-page Catalog sent Free on Application.

THE A. I. ROOT CO., MEDINA, OHIO.

BRANCH OFFICES AT:

118 Michigan St., Chicago, Ill.

1024 Mississippi St., St. Paul, Minn.

Syracuse, N. Y.

Mechanic's Falls, Maine.

Porter Honey-House Bee-Escape

Have you seen it? Just the thing to put on the doors or windows of your bee-rooms. Indispensable, you'll say after you have tried it.

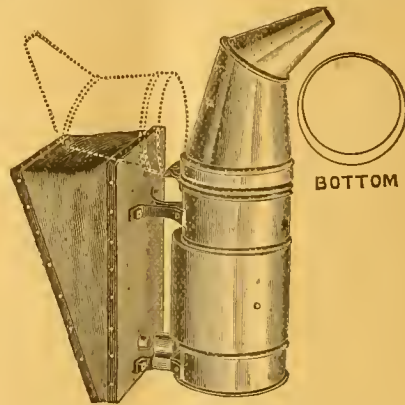

BOTTOM

AMERICAN BEE JOURNAL

DEVOTED EXCLUSIVELY TO THE INTERESTS OF HONEY-PRODUCERS

ESTABLISHED 1861
THE OLDEST BEE-PAPER IN AMERICA

Published Weekly, at \$1.00 per annum.

Sample Copy sent on Application.

36th Year.

CHICAGO, ILL., JULY 2, 1896.

No. 27.



Fifteen Years' Experience in Bee-Keeping.

BY MRS. SALLIE E. SHERMAN.

In the fall of 1879, I purchased my first colony of bees of Rev. Willis J. King, who lived nearly a mile from our little home on the opposite side of the creek. They were the common little black bee, as that was the only kind in all this part of the country at that time, and were in a box-hive, as that was the only kind then in use hereabouts.

My son (a lad of 13 years) and I went at night with a wheelbarrow after the bees. After securely wrapping them up with a sheet, we started to bring them home. We had to cross a foot swinging-bridge, but by me holding the hive and he rolling the wheelbarrow, we got them safely over.

We set the hive close to the dwelling, so that we could see them when they would swarm. I knew nothing about bees except that they stored honey and would sting. The sting of a bee hurt me, I suppose, as badly as almost any one they ever stung, swelling my flesh fearfully. The fear of the sting hindered my learning their habits, etc., as soon as I otherwise would have done. I had never seen or heard of such a thing as a smoker, and didn't know that a book had ever been written upon the subject of bee-culture. Finally, a friend sent me a copy of "The Bee-Keepers' Magazine," for February, 1875, in which I saw the picture of an "American hive." I sent for the directions how to have one made, and got a carpenter to make two for me, for which I paid him \$10.

In the back of the hives was a glass so that I could see the inside of the hive while the bees were at work. The hive was a movable-frame structure with six boxes laid on top; each box, when full of honey, held 9 pounds, making in all 54 pounds of surplus.

However, previous to having these hives made, I put the first swarm into a box-hive the same as the original. The two box-hives were made with the cross-sticks in the lower part or brood-nest proper. A small opening was left on one side, so that the bees could go up above and store their surplus. On the opposite side from this opening was a kind of door, held in place by two nails. The opening was left by not allowing the plank to reach quite clear across; thus you see it was something like a box on top, yet all together. This, I still think, is the best box-hive I know of.

When "robbing-time," as we called it then, came, then came my trouble. I knew that there was honey ready to be taken, but for fear of the stings I would put it off from day to day, and in some cases from week to week, hoping that somebody would come who knew how to "rob" them. It is indeed mortifying now to think of my timidity and ignorance along these lines.

When my first swarms came—oh, what a dreadful time I did have! There, however, was one comfort—there was one gentleman in town who actually knew a queen by sight. I then thought that he was indeed quite a bee-man. After a terrible din, ringing of bells, beating tin pans, etc., they settled, and I sent for John Anderson ("my Joe")—the wonderful bee-man. He came, and also a near neighbor, who seemed to think he, too, knew quite a lot about bees, as he had in days long ago lined them to trees, and cut them and secured, as he termed it, wild honey.

The bees had settled high up on a large limb of a live-oak. Imagine, if you can, what a ludicrous scene we all presented, as after the bees we went. A long ladder stood near the body of the tree; a large dining-table underneath, upon which



Mrs. Sallie E. Sherman.

neighbor C. and I stood with up-stretched arms, each of us holding in our hands two quilting-frames, to which the four corners of a sheet had been securely tied. John Anderson—a man with very thick, long, heavy whiskers, without veil, smoker, gloves, or any protection whatever—was in the tree with saw and axe, with a large swarm of irate little black

bees. My, my! It is too bad to contemplate, much less to be a real actor in the scene.

We, of course, had the hive ready. His plan was to jar the bees off with the axe into the sheet, then we were to close it up and carry it to the hive.

Just as he struck the limb, a few bees fell on Mr. C., who dropped his end of the sheet and ran for dear life, thus throwing the whole swarm on top of my head. This rough treatment of course angered them very much. They stung me considerably, but nothing to compare with what they did Mr. Anderson, who still staid in his position and let them settle again, meantime tying the rope around the limb, and securing it in another place so that he could let them down easy-like, after sawing the limb off.

After so long a time we got them down, but hadn't yet gotten them into the hive, for they again took wing, this time, however, settling on an old stump near by. Mr. Anderson this time succeeded in finding the queen, and in getting them into the hive all right. He then called for the camphor bottle, and bathed his hands, neck and face freely with it. I haven't a doubt but what he had received a hundred stings, but Mr. C. said that he never grunted, and told a good joke on him about hiving the widow's bees, saying that he didn't believe that he would have grunted if every bee in the whole swarm had stung him!

After this experience, I decided if I ever expected to make a success with my bees I must learn to depend more upon myself, and less upon others. I also learned that there were Italian bees which were said to be far superior to the little blacks, and much more easily handled, not being so vicious. I sent to Ohio for an Italian queen, hunted and found the black one, which I killed, and introduced the Italian queen in her stead. This was in one of the American hives that I had made. With what anxiety I will leave you to imagine rather than try to explain, did I wait the full three weeks, with a few days over, to see whether I had succeeded in introducing her royal majesty or not. Ah! what joy and exultation there was when I first saw the young Italians! I could have been seen at almost any hour of the day when I had leisure, looking at them through the little glass door in the back of the hive. Oh! how proud I was of those bees, and in being successful in Italianizing them. They were to me a great source of pleasure and enjoyment. In a word, I was full of enthusiasm on the subject of bee-culture.

In the meantime I had gotten a copy of "The Bee-Keepers' Text-Book," which I took great delight in reading and studying. By this time I had run out of hives, so I looked around to see what I could use as a substitute until I could order and get them here. I found several kerosene cases which I decided to use, and with saw, hammer, nails, and a case-knife, I proceeded to turn them into temporary movable-frame hives, which I succeeded in doing very nicely. There was one thing, however, at which I failed utterly, and that was in getting my bees to store surplus comb honey in the rear of the hive in which I placed three of my 9-pound boxes. This decided me at once in favor of putting the surplus arrangement above the brood-nest—an idea to which I still adhere.

When my hives came, it was very nice to lift out the frames with adhering bees, and place them thus in the new hives.

Well, you needn't laugh so about those primitive frames that I made, for they are still good, and doing service yet. The old adage says that "where there's a will there's a way." You see, I had the will, and made the way. Where an edge wouldn't cut, I whetted it and made it cut. I was determined to succeed. I would work and think about my bees during the day, and dream about them at night. Often afraid to move lest I should kill a fine queen, I would sometimes think

that they were all over the bed. There, now, did you ever know any one more enthusiastic?

The second queen I got came from the same dealer, with one frame of hatching brood. This was sent by express, and had to come 22 miles on the stage. The charges were enormous. When it got to the post-office here, a magistrate took it upon himself to deliver it in person. He thought it was a most unheard-of thing, that live bees could be sent in that way. I still have the little, single-frame box in which they came. I had it made into a little two-story wren-box, with ten little doors and a perch in front of each, and have reared one, and sometimes two, broods a year, but they are too cross to use each little division at the same time.

The hives that I ordered were the "New American." I bought them of a dealer in New York city. I got one ready nailed and painted, with starters in the section-boxes, and heavy comb foundation for the brood-chamber, which was wired. I very soon decided that I much preferred it without wire, and have never had any occasion to change my ideas in regard to it. My bees would cut out the wire in many places, and would not as readily accept and draw it out as that which I got later on without wire.

Bell County, Tex.

[To be continued.]



Black or Honey Locust—Other Items.

BY P. J. SCHATZ.

Black or honey locust, as some bee-books say, is a very good honey-tree with only one exception, and that is that it blooms but once in three years. We have a grove of about 90 locust-trees, and I have known them to bloom every year for 13 years without fail, but the bloom is of very short duration. It is a good honey-tree, the honey being of very fine flavor, but is a little too dark for No. 1 honey. The trees also make a desirable shade-tree, but the wood is very brittle, and the branches break off very easily, and therefore it is not a very good looking tree. It blossoms when but four or five years old, coming into bloom about one week after late fruit-bloom, which keeps the bees out of mischief somewhat, and keeps up brood-rearing. It is very easy to cultivate, and grows very quickly.

BEE'S PUNCTURING FRUIT.—On page 291, Mr. W. S. Fultz says that bees puncture fruit. Now, we have about 18 acres of fruit, and I have been connected in that very branch of business for 13 years, and have kept bees for only four years. Without doubt bees can puncture fruit as well as wasps and hornets, but do they?—that is the question. Now, will Mr. F. answer why grapes and fruit are punctured when there are no bees at work on them? If the bees have plenty of forage he will find that they will not bother fruit at all. Why is it that cherries are punctured when the bees have plenty of forage? Why is it that pears are punctured with nary a bee in sight? Why not say that the wild bees and flies puncture fruit as well as domesticated bees?

There are thousands of birds, wasps and hornets here that work on fruit during the season, and in my estimation it is the birds that peck the fruit which starts the juice to running, and the bees gather it in. Some years, when forage is scarce, bees work on fruit, while some years they won't touch it. But when they do work on fruit, I must say they are a perfect nuisance. One has to be careful not to get stung while bunches of grapes are fairly covered with bees. Give them plenty of forage, and there won't be any trouble with bees puncturing fruit.

WHAT AILED THE BEES?—On page 326, A. C., of Pollock, Mo., wants to know what ails his bees. I have had a bad case of the very kind, or rather my bees had it, and I don't wonder that A. C. was alarmed. When bees come out

of the hive and look like queens, then it does not look like dysentery. It is a very bad disease, and affects the bees and queen alike. When hundreds of bees come out of the hive for a week and die, you will wonder how there could be any in the hive. I would call it the same as A. C. has—constipation. One of my colonies has been affected the same way, while the one alongside was not affected at all. I think the cause of it was poor packing for winter. I found some of the combs moldy, and mold on the bottom-board. I tried feeding, which did but little good, and the first warm day I took out the moldy combs, and put on a new bottom-board, and found my colony queenless. I bought a queen, but the bees were too far gone to be saved, but I managed to save the queen and put her in a nucleus.

SWEET CLOVER, BASSWOOD, ETC.—Sweet clover bloomed its first on June 6, basswood on June 14, which shows that sweet clover does bloom the forepart of June. Basswood is two weeks ahead, and loaded with blossoms. White clover is better this year, and more of it than I have seen for years, and bees are busy working on it. Bees have an abundance of bloom, and I expect 150 pounds per colony—perhaps more. Again I say, sweet clover is the best honey-plant in existence, all things considered.

Lemont, Ill., June 18.



Distance from Center to Center for Brood-Combs.

BY G. M. DOOLITTLE.

"What is the proper distance from center to center to space brood-combs?" is a question that I am asked much more often than any other of late, and so I believe I can do no better at this time than to say a few words upon this subject, as the swarming season is upon us, and we shall have to decide this matter when we hive our swarms. We are told by some that $1\frac{1}{4}$ inches is right; by others that $1\frac{3}{8}$ inches is the only correct spacing, and others insist that $1\frac{1}{2}$ inches is right, while many say that anywhere from $1\frac{5}{16}$ to $1\frac{7}{16}$ will do. Some have even figured so nicely as to the closeness which brood-combs can be placed to each other and yet allow the brood to hatch all right, that I almost begin to fear that we might yet be able to place the combs so close together, were some one to carry out the ideas advanced by some, that we should need scarcely any bees at all, but could fill out our hives solid with combs of brood with only a few bees and the queen around the outside, which would so cheapen honey that the most of us would have to go out of the business, leaving a few specialists in possession of the field to secure and monopolize the honey-trade, as is being done with coal and oil.

But what is the proper distance to space brood-combs? I am not going to lay down any rule for others, but I will say that from an experience of 27 years, many experiments being conducted along this line during that time, I am convinced that $1\frac{1}{2}$ inches is the right distance from center to center to space brood-combs, where all worker-combs are used, and $1\frac{3}{8}$ where drone-comb is used. Some tell us they do not know why $1\frac{3}{8}$ inches is better than $1\frac{1}{4}$ or $1\frac{1}{2}$ inches, even though they prefer the same, but I will tell why I believe that $1\frac{1}{2}$ is right, and how I come to so believe.

It has been said that Doolittle is great for following Nature, and Nature told me that $1\frac{1}{2}$ inches was right, more than 26 years ago. At that time I could not find in any of the books on bees, that I then had, how far apart the frames should be placed, so in order to ascertain, I went into the lift of the barn where were stored all the old box-hives from my father's old apiary, to the number of some 30 or more, and, upon measuring the inside of the tops to the hives from which the combs had been cut, I found that all of the central combs were very nearly $1\frac{1}{2}$ inches apart, while some of the combs

near the sides of the hive, where drone-combs are usually found, where bees have their own sweet will, were from $1\frac{1}{8}$ to $1\frac{1}{4}$ inches, those having the greatest distance being where the combs run in the hive so the last one came in or near the corners. Since then, whenever I have come across a box-hive where the bees were out of it, I have measured the distance of the combs where they were attached to the top of the hive, and have invariably found the same, as above given, or so nearly so that the difference was scarcely noticeable.

Now, is it reasonable to suppose that the bees do not know what is right in this matter when they have to furnish food, fuel, and the whole business? In order to keep up the necessary warmth for brood-rearing in early spring, the bees form a living wall around the brood, thus keeping the heat from escaping the cluster; and to do this it takes the depth or thickness of two or three bees all the way around, as I have often ascertained by tipping up the hives at that time of the year. If the reader has never tipped up hives on cool or frosty mornings in April or early May, it will be an interesting thing for such an one to do. It is a nice sight to see how nicely the bees are packed, all with their abdomens pointing away from the center of the cluster, and almost or entirely motionless. This is the hive proper, and inside this crust of pointed abdomens, brood-rearing is going on nicely, while some unlucky bee on the outside is so cold it can hardly move or walk. But enough on this point.

Those who advocate close spacing always tell us that as brood-combs are only $\frac{3}{8}$ in thickness, there would be $\frac{3}{8}$ of an inch between them for the bees to loaf away their time where $1\frac{1}{2}$ spacing is used, while $\frac{3}{8}$ is plenty room enough for all necessary purposes in feeding the brood and keeping up the necessary heat. In this statement they leave out one very important item, which is, that although empty brood-combs average only about $\frac{3}{8}$ of an inch in thickness, these same combs, when filled with capped brood, measure one inch in thickness.

I have many times measured worker brood-combs having capped larvæ or embryo bees in them, and have never found a single comb, even when it had the very first brood in the new comb, where it was any less than one inch through it. The way I measured was as follows:

I looked over my inch wire nails till I found one which was just one inch from the under side of the head to the point of the nail, when I went to the apiary, took out combs from the different hives and pushed the nail through the sealed brood till the head was just level with the capping, and in no instance did the point any more than just pierce the capping on the opposite side, while in many cases the capping had to be flattened so that I could feel the point.

Another thing: I have often measured bees as they were standing on the combs, and found that they stood about $\frac{1}{4}$ of an inch high, and as I claim that the combs should be far enough apart so that the bees can stand back to back in their traveling about the combs, this would also give $\frac{1}{2}$ inch as the right distance between one-inch thick combs of sealed brood.

From all of these experiments, and others I have not space to mention, I believe $1\frac{1}{2}$ inches to be the right distance from center to center for brood-combs. Borodino, N. Y.



Some Excellent Hints on Marketing Honey.

BY B. F. ONDERDONK.

A great deal has been written about the low price for honey. I take it the reason is the lack of demand; this results from various causes, the principal one being absence of printer's ink. Go into any grocery and your eye is attracted by handsome show-cards, or taking sentences—"Eat H. O. and grow beautiful;" "The sun shines the brighter for sapolio." "Take home a cake of Bon Ami, and make your wife

happy." Now, here is a chance for our supply-men to do business.

Get up a nicely lithographed card, about 12x15 inches—a clump of attractive honey-plants in colors, and a colony of bees in the foreground, apiary in the middle, in the distance a farm house and out-buildings. Have labels for cartons of above landscape reduced. Let the whole work be a fine artistic specimen. The placards could be sold at from 10 to 25 cents each, while the labels would cost probably 10 cents per hundred. The lettering should be striking, and perhaps read thus: "\$1,000 Reward will be paid to any one who can find a pound of artificial comb honey. This honey is warranted pure, and is the product of the bees at the apiary of ———. For sale here."

Last year I bought one colony of Italian bees in a movable-frame hive, and divided in May, making two. These produced 98 pounds of nice comb honey. I had two colonies of blacks transferred, and they stored 37 pounds. This was more than we needed, so we asked the groceryman who serves us, if he could sell any honey. He said: "No, we have a lot on the shelf and can't get rid of it."

I showed him some of my stock—sections carefully scraped. He said: "Why, what we have isn't like that. I'll try a 12-pound box." Result: He sold 82 pounds, and created a demand that even helped a neighbor to dispose of a lot of dirty, ill-conditioned sections.

I have a rubber stamp, and print thus my sections on one outside: "The product of Italian bees, from the apiary of B. F. Onderdonk, Mountain View, N. J." This, of itself, is a guarantee of purity.

Now, I don't like to peddle honey, or anything else, but make your grocer do that—it is a part of his business.

Advertise in your local paper. Write a neat little article on the habits of the honey-bee—the local editor will gladly publish it. Give him some of the honey if he won't take it in exchange for an advertisement. Give some to your pastor. Take some to a sick friend or *enemy*. Invite a neighbor up to see your bees, provide him or her with a veil, show them the inside of the hives, the brood, honey and queen; get them interested. Suppose two or three of your neighbors go into the business, and come to you for instruction, give it freely if they produce honey, and induce them to put out only first-class stock. Competition won't hurt you, it will be one more drummer to extol the merits of honey.

I did not sell a pound of honey for less than 15 cents, and had I fixed the price at 20 cents I believe it would have been paid willingly. Instead of one grocer who "did not sell" honey last year, there are now three who want to handle my product for the coming season. Mountain View, N. J.



The Disease Called "Bee-Paralysis."

BY T. S. FORD.

A. C., on page 326, inquires what is the matter with his bees. Having had a four years' experience with the disease, and having lately noticed several inquiries indicating a want of familiarity with the symptoms, I concluded that I would answer A. C.'s question, especially in view of the fact that Dr. Miller does not recognize what the trouble is.

A. C. has undoubtedly a genuine case of what is very improperly called bee-paralysis. He describes the symptoms of the disease in its most virulent form, and when it reaches this stage, the result in my experience has been the loss of the colony; and because the loss is assured, and there is danger that all his bees may become infected, he should at once use the sulphur pit, and destroy the diseased colony. I think that it is hardly necessary to destroy the combs, but that they may be given, after being so disinfected, to another colony.

The early indications of the presence of the malady are

as follows: The guards will be seen hustling the infected bee, crawling all over her with abdomen curved in the attitude to sting, and furiously gnawing the hair from the sick bee. This continues until the patient and her persecutor tumble off the alighting-board to the ground. This process is continually repeated with every sick bee until after awhile a considerable number of individuals will be noted with all the hair plucked from both abdomen and thorax, and the infected ones will have a sleek, black, shiny look. Soon these bees will be observed slightly staggering and crawling around with quivering motion of the wings, that present an appearance as if the wings were stirred by a breeze. Many of these will soon appear to be emaciated to a very considerable degree. Occasionally during this period a bee will be seen slipping out of the hive, dragging her limbs as though having been stung. In an apiary infected with bee-paralysis, many colonies never get beyond this stage.

After awhile, however, a colony will be observed which passed into the second stage of the disease, and when this occurs, the guard bees will have ceased to hustle the sick, and their duties in this regard will be only to the dead. Bees with abdomens enormously distended will be seen dragging themselves about with a staggering, quivering motion, which once seen will be recognized at a glance ever afterwards. Some of these individuals will void a thin yellow discharge, making a yellow splotch on the alighting-board, giving a characteristic appearance, which marks the doom of the colony, as it is exceedingly rare for a colony to survive when the yellow spots are numerous. If one of these swollen bees is gently pressed, the thin yellow excrement will be squirted a distance of several inches.

Every morning the melancholy sound of bees flying off with the dead may be heard. These sometimes accumulate in front of the hive in great numbers, sometimes as many as a gallon of dead bees will be seen. When there are several hives in this condition, the final and worst manifestation of the malady may be witnessed, during which the infection is so virulent that apparently there is not time for the bees to reach the swelled condition, and they will perish by thousands all around the apiary, with no visible signs of the infection. The ground for many yards around will be strewn thickly with the dead, and under the trees where they resort at this period, multitudes of the dead will be seen, some with their pollen-baskets half filled, and some with a heavy load on. I have seen them drop dead as they reached the hive, as though struck by lightning. Fortunately, it is rare that the malady reaches this stage. I have seen it so only during one spring, and that year there was not an ounce of surplus gathered.

Generally these symptoms moderate at the approach of warm weather, and those colonies which have reached only the first stage, recover perfectly, or at least appear to do so. Those that have reached the second stage, linger along, and finally perish in most cases. I have never seen them amount to anything afterwards. My opinion is that the queen becomes diseased, and remains so.

There is no doubt but that the malady is infectious, and can be conveyed from one sick individual to another, and from a diseased queen to her offspring. Whether the germs lurk in the honey or combs is uncertain. I have never seen it propagated from the combs from a diseased colony being introduced into a healthy one.

I have used all the remedies given in the journals, and I am of the opinion that there is little good to be gotten from any of them. I have used nothing in my apiary for a year, and I have only three colonies that show the disease. Still, from past experience, I am persuaded that the infection is there, and under conditions favorable to its development, is liable to blaze up in all its fury again.

For the last two years it has done but little harm, and

hope suggests the idea that it may finally disappear. But I am still uneasy, and cannot help thinking that it is only dormant.

A. C. should examine his hives carefully, and if he can find that the infection has not already spread to other colonies, he ought to destroy the infected colony without delay. The treatment that I last used, and which I would recommend, is to dust each frame of the infected hive thoroughly with powdered sulphur, and to provide a place where the bees can have access to salty water whenever they want it. I use the Simplicity feeder for this purpose, filling up a dozen or more with salty water every other day, and leaving it in the shade in some place about the apiary. It is astonishing what a quantity will be taken.

Great care should be used in the purchase of queens, as it is by this means that the infection is transmitted. It is not safe to buy queens except from some reliable breeder, who has an apiary free from the disease.

Speaking of the use of salty water gives occasion to remark that I have had this year over 60 swarms from 47 colonies, and an apiary of blacks and hybrids only 300 yards away from mine, consisting of over 30 colonies, has sent out only one swarm this season.

I can't help thinking that salt is essential to bees. If it is not supplied, they swarm in great numbers about privies and urinals, and this does not happen if the brackish water is exposed where they can reach it. I gave a friend one of my finest Italian colonies this spring, and he tells me that it did not swarm, whereas, I did not have a single healthy one this year that failed to swarm at least once, and many sent out several.

If Simplicity feeders are not available for watering bees, any vessel that will not be corroded can be used, if precautions be taken against drowning the bees. A cloth may be spread so as to dip down into the water a little, which will do quite as well.

Though the honey-flow has not been nearly so abundant this year as it was last, bees have never, in my experience, been so prolific, and so strong in numbers, which fact is to be attributed to their having access to salt during the spring months.

Columbia, Miss., May 23.



Locating an Apiary in an Exposed Position.

BY IRVIN GROVER.

The article written by Mr. C. Davenport (on page 82) with regard to his apiary in an unprotected position, has induced me to tell my experience along that line. I call mine the "Lakeview Apiary." It is situated on top of a hill 500 feet above the level of Otsego Lake, which is about $\frac{3}{4}$ of a mile distant, with nothing to obstruct the view. This is the beautiful Glimmer Glass which was made famous by the pen of Cooper, and is one of the nicest sheets of water in the State. When I first located here I thought it was too much exposed to winds for bees, there being no natural protection except a slight rise of ground, and woods about 90 rods away to the northwest. The wind has full sweep in other directions.

I began with two colonies, locating them close up on the east side of an out-building, wintering them on the summer stands. I have now been here nine winters, and have a regular bee-yard with a tight board-fence on two sides of it. The fence is 5 feet high, and is in the form of a carpenter's square, the hives facing the southeast. They winter and spring here very nicely when they have good stores. Spring dwindling does not trouble them.

Now, I have a relative less than two miles from here, in a valley. His yard is well protected on all sides. I have walked down to his place when the cold spring winds were blowing, and my bees were not flying at all, but it would be warm

enough there for a man to work among the bees with his coat off. The first spring he was there I envied him his location, but observation has convinced me that his yard is too well protected. The warm sunshine induces the bees to fly when the weather is unsuitable a little ways from the yard, and spring dwindling is the result. I have been watching both yards the past five years, and four years out of the five his bees have been troubled with spring dwindling, some times losing half of them, the balance being too weak to work for comb honey. He has quit trying to produce comb honey, and is giving his attention to the production of extracted, and never gets a good yield. He uses the same kind of hive as myself, and winters them on the summer stands.

We both use the New Quinby hive, and it suits me better than any I ever saw. When the boxes are removed, and the frames turned at right angles, there is plenty of room for packing. My bees come through the winter strong in numbers, and breed up in season for the honey-flow, which is from clover and basswood.

My friend from the highly-protected yard came to my place to see me in 1893; it was fruit-blossom time. I was sick, and asked him if he would see to some queen-cells for me. When he came in he said he would let me pick three colonies from his yard for each one that I would let him select from mine.

Cooperstown, N. Y.



Best Size of Hive for Comb Honey.

BY FRANK COLE.

I see the discussion is still in order, so I have something to say in regard to the size of hive we should use. I have been on Mr. Edwin Bevin's side of the fence for some time. I work my bees exclusively for comb honey; I don't use the extractor at all. In the fall my hive is full of honey, and it is full in the spring, and by the time the honey-flow strikes us here—about the first of June—it is full of bees, ready for business. Perhaps in some localities large hives are not the best for comb honey, but I am convinced that here they are.

My hives are 20 inches long by 12 inches deep, and I use 12 frames, and a good, prolific queen will fill those just as well as an 8-frame hive. I experimented some last year, by giving a surplus of bees at the honey harvest. I had hives that I had four supers on, of 28 sections each, and I gave to those about a medium-sized colony, and those bees gave me a little over 50 pounds of nice comb honey each per week. This experiment was tried with four colonies, and all four averaged over 50 pounds per week for three weeks. By this time the surplus of bees began to diminish, and they then fell back with the rest of my bees, which was a little over 100 pounds per colony, and no increase.

If Mr. Doolittle can get 566 pounds of honey from one colony in a 4-foot hive, why can't we reduce the hive one-half, and get one-half as much honey, which would be an enormously good yield of comb honey?

When my bees get to hanging out on the hive, I raise it from the bottom-board one inch, and then if they don't stop I raise them higher. I think that raising them is a very good preventive of swarming. I have little trouble from their swarming from these hives.

I keep my bees in the cellar during the winter, with the bottom-boards off, and the tops filled with dry sawdust. If this gets damp, I heat some bricks and bury one in the sawdust of each hive, and it does the rest.

PREVENTION OF ROBBING.

I will give to the readers of the Bee Journal the benefit of an implement to keep bees from robbing, which almost invariably proves a success with me, unless it is a very weak colony:

I take some $\frac{1}{8}$ -inch strips and cut them nearly as long as

the hive is wide. These strips are for the sides of a box. Then cut the end-pieces and tack on a bottom of thin stuff. This makes a box, and it wants to be only $\frac{1}{2}$ -inch or so deep.

Now cut three or four small holes that the bees can get through nicely, in one of the edges of the side, and in the other side cut just one hole just large enough for one bee to get in. Now, if the bottom-board does not project out in front of the hive, place some board down just level with the bottom of the entrance, and turn this box bottom side up on this board, tight up to the hive, with the surplus of holes next to the hive. This gives ample room for all guard bees to get in, and when a robber gets in through that first hole, and thinks she is going to crawl safe up into the hive, she has just made a mistake. When she gets into that "scrap-box," as I call it, her time is very short. Just try it, bee-keepers, and note the effect.

Mecosta, Mich.



California Bee-Keepers' Exchange.

An outline of an essay read at the San Jacinto Farmers' Institute,
BY J. H. MARTIN.

THE CALIFORNIA HONEY-INDUSTRY.—The production of honey has been practiced for the past 40 years in California upon what might be termed a very loose system. There has never been a season since the State has been extensively stocked with bees, that the output of honey could be definitely ascertained, and for statistics in relation to shipments we have to depend upon figures from the various transportation lines. The same lack of system and uncertainty prevails in relation to the number of colonies of bees owned, and even the number of persons engaged in the business is left largely to conjecture. San Bernardino county is not so largely engaged in bee-keeping as some of the adjoining counties, but being the most progressive and the largest in area, it has not allowed the bee-keeping industry to remain a hidden factor. From a county official I find fully 100 bee-keepers, owning in the aggregate 6,000 colonies of bees.

The yield of honey for the past year was 325 tons, or 27 carloads. This amount of sweetness should have brought into our county over \$35,000, but owing to the depressed markets and the lack of system in marketing, the cash received will fall below \$25,000.

When we consider that the above statistics apply to only one of the many counties of our State, the magnitude of the industry can be dimly realized. In Southern California there are over 1,000 bee-keepers, and the product, as far as can be ascertained from railroad statistics, is over 7,000,000 pounds for the year 1895, and while Southern California boasts of the largest area and variety of honey-producing plants, and honey of the finest quality, we are reminded that central California, from Bakersfield to Fresno, is becoming a large producer of honey from its great area of alfalfa fields.

ONE LINE OF PROGRESS OPEN.—The appliances for the management of bees and the production of honey have been improved to such an extent that we cannot expect any further startling inventions in that direction in the future. There is, however, a neglected field where great improvement can be made, and that is in the improved methods of marketing our product, and the most healthful signs of the times is the wide attention this subject is enlisting. California, the banner State for co-operative associations, has lately added to the list The Bee-Keepers' Exchange.

The one great aim and end of our Exchange is to bring a measure of prosperity and happiness to the honey-producer and his family. To reduce the cost of production puts corresponding profits into the pockets of the producer. In that direction the Exchange reports progress, for we have secured control of the leading supplies used in the manipulation of

bees, and every member can save a large percentage that has hitherto gone to local speculators. There is such a multitude of these appliances used that this feature alone would warrant the creation of an exchange, and the securing of a large membership.

NEW PACKAGES.—One important feature of reform sought is to put our product into new and clean packages. Hundreds of carloads of honey have in past years been shipped East in second-hand gasoline, and even kerosene, cans. The Exchange proposes to supply the producer with new cans at reduced rates, and if he cannot comply with the excellent regulation he will have to stay outside the Exchange. Another radical improvement is to put our best grades of honey into small packages for the retail trade, and it is to be hoped that the brand of "The California Bee-Keepers' Exchange" will carry with it such a guarantee of quality that there will be no suspicion of mixed goods.

WHAT IS TO BE GAINED.—From this small-package proposal there is much to encourage us. When we consider that the annual output of honey in the United States is only about 63,000,000 pounds, and the population 70,000,000, there is something radically wrong in our present system of marketing. The best liquid honey produced in California, or the world, commands only 4 or 4 $\frac{1}{4}$ cents per pound, still, there is not enough produced to supply one pound per capita to the people of the Nation, not mentioning a large foreign market. The remedy can be found in a more equal distribution of the product; along these lines the Exchange proposes to work. The Exchange is purely a co-operative association. It is not a joint, stock company where a few, if so disposed, can get control of the product for selfish ends, but every member has equal rights and privileges. One dollar with an assessment of 25 cents per month for the first year secures a membership certificate. Every member agrees to market his honey through the Exchange, the latter receiving 5 per cent. of the proceeds for handling it. Other features too numerous to mention at this time, are embodied in the by-laws which are accessible to bee-keepers and others.

Box 152, Los Angeles, Calif.

A New Binder for holding a year's numbers of the American Bee Journal, for postage to mail, postpaid, to every subscriber who sends us 15 cents. It is called "The Wood Binder," is patented, and is an entirely new and very simple arrangement. Full printed directions accompany each Binder. Every reader should get it, and preserve the copies of the Bee Journal as fast as they are received. They are invaluable for reference, and at the low price of the Binder you can afford to get it yearly.

The Alsike Clover Leaflet consists of 2 pages, with illustrations, showing the value of Alsike clover, and telling how to grow it. This Leaflet is just the thing to hand to every farmer in your neighborhood. Send to the Bee Journal office for a quantity of them, and see that they are distributed where they will do the most good. Prices, postpaid, are as follows: 50 for 25 cents; 100 for 40 cents; or 200 for 70 cents.

The Names and Addresses of all your bee-friends, who are not now taking the Bee Journal, are wanted at this office. Send them in, please, when sample copies will be mailed to them. Then you can secure their subscriptions, and earn some of the premiums we have offered. The next few months will be just the time to easily get new subscribers. Try it earnestly, at least.

The McEvoy Foul Brood Treatment is given in Dr. Howard's pamphlet on "Foul Brood; Its Natural History and Rational Treatment." It is the latest publication on the subject, and should be in the hands of every bee-keeper. Price, 25 cents; or clubbed with the Bee Journal for one year—both for \$1.10.

Questions AND Answers

CONDUCTED BY

DR. C. C. MILLER, MARENGO, ILL.

[Questions may be mailed to the Bee Journal, or to Dr. Miller direct.]

A Swarm-Hiving Experience.

June 5, about 6 p.m., I was informed by a neighbor that a colony of bees had clustered on a tree one mile south of my home. With a rope and coffee-sack I reached the tree—a large hemlock—about an hour later. The bees were about 50 feet from the ground, and 8 feet from the trunk, on a branch too small to support my weight. I made a hoop of a small limb and placed it in the mouth of the sack; then stuck a branch long enough to reach the bees through the sack, holding it under and jarring the bees from the limb, most of them falling into the sack. In attempting to close the sack, I let it fall; it lodged some 15 feet below, spilling most of the bees.

When I reached home I had about three dozen stings and one-third of the bees. I emptied them in front of a Langstroth hive; they clustered in front, I drove them in, and the next morning I could not find the queen.

When I returned from work in the evening, I found a queen and large colony of bees in the hive. Did they communicate with the bees remaining on the tree? They are working as good as any colony I have. D. S.
Cenemaugh, Pa.

ANSWER.—Only a guess can be given, and I guess you have guessed correctly, that the remainder of the swarm found their way to your hive. Hardly, though, did the bees in the hive communicate with the bees on the tree, but just the other way—the bees on the tree found those in the hive. It is quite possible that the queen was in the hive, even if you couldn't find her, and the bees in the tree, scouring the country in all directions, would easily find where the queen was, and those which first found the hive would set up a call that would help to bring others. Or, it is possible that the queen remained on the tree, and scouts found the hive.

Caging the Queen During the Honey-Flow.

1. Do you think there is any disadvantage in caging the queen of a strong colony during a good honey-flow?

2. How would the common mailing-cage do for caging a queen in a full colony? Would the bees feed her while caged, or would I have to put candy in the cage for her? Would it be a good idea to cage her alone, or net? J. M. W.
Evelyn, Tex.

ANSWERS.—1. That is a difficult question to answer, taken in all its bearings. There is diversity of opinion, and among those who favor caging the queen there is diversity of practice. Under certain circumstances the advantages of having the queen caged may far outweigh the disadvantages. Some years ago I practiced quite largely a plan that involved keeping the queen caged for ten days. The plan was given by Doolittle, and I have always felt under obligation to him for it. Here it is:

When a swarm issues, cage the clipped queen and put her in the hive where the bees can care for her. Don't merely stick the cage at the entrance. If a cool spell comes she will be deserted by the bees and will die. But put her somewhere in the hive where she will always keep warm, and where the bees will have free access to her. When they're trying to swarm they don't seem to have so much affection for a queen that can't or won't do as they want and go out with them. About five days after the issuing of the swarm, cut out all

queen-cells. Five days later, or ten days from the issuing of the swarm, cut out all cells again and liberate the queen.

That's the plan, and I got some good crops of honey while following the plan. If I were going to watch for swarms I rather think I would follow the same plan, or a modification of it. The queen was caged ten days, and when liberated went to work and gave no further thought to swarming.

Another case in which queens are caged, is without any swarming, leaving the queen caged during most of the honey-flow. The fact is, that if she is caged during the last three weeks of the honey-flow, she will be saved from rearing a lot of workers that will come too late for the harvest; and to carry it farther, the last five weeks of the honey-flow will do better without any eggs, for it takes three weeks to rear a worker from the egg, and then the worker must be two weeks old before she gathers from the field. However the theory may be, it didn't turn out well with me in practice. The combs were badly clogged with pollen, and when the queen was freed she didn't get to laying for some time, and sometimes swarmed out. Others may succeed with the plan, and they may modify it, but I don't think I'll ever try it again.

On the whole, I think a colony seems best satisfied to have the queen free, and I think they generally work with better heart when the queen is putting in her best work. I know, however, that good authorities say the bees work with great vim when hopelessly queenless, and perhaps I've never struck just the right plan.

2. Any cage will do that allows the bees free access to the queen through the meshes of wire-cloth, and that is not too large to be put into the hive.

Transplanting Basswoods—Crimson Clover.

1. I live near some second-growth basswood and young seedlings; the seedlings are about 6 feet tall. Would it be advisable to induce the neighbors, with my assistance, to transplant them for shade trees, in leisure hours? How long would one have to wait for such trees to produce any honey? The neighbors would care for them and water them, so as to get the shade. How long would I have to wait before I would get any profit? You see, no money would have to be expended. Could they be planted in June or July?

2. Could crimson clover be sown in waste-places, and would it thrive like sweet clover? The seed is cheap here. Would it take care of itself after planting? J. M. Q.
Syracuse, N. Y.

ANSWERS.—1. The probability is that it would be an advisable thing to do as you propose. Of course, if an unlimited supply of lindens are already growing wild within reach of your bees, and if there is no likelihood that they will be removed, then there might be no object in transplanting. But if you get some young seedlings planted as shade trees, they would be safe for many years. Certainly, if it is a profitable thing for others to go to the expense of setting out and caring for trees on their own land, as some do, it ought to be well for you to induce others to do it for you.

I should say at a guess that seedlings six feet high might begin to bloom in from three to five years. The profit would be small at the start, but it would increase from year to year. You couldn't make them live if you transplant when in full leaf. Like other deciduous trees, you will do best to transplant in early spring; but you might also succeed in the fall after the leaves have fallen. The same principles that apply in transplanting common fruit-trees will apply in planting lindens. Save as many small roots as possible in digging the trees, dig a hole three or four feet square, spread the roots naturally, and sift in loose earth among them; fill the hole even full, and tramp down hard, and fill the top with loose earth.

2. I hardly think crimson clover would succeed if scattered in waste-places, but you could try it on a small scale.

OLDEST BEE PAPER IN AMERICA ESTABLISHED IN 1861

THE AMERICAN BEE JOURNAL

PUBLISHED WEEKLY BY

GEORGE W. YORK & COMPANY,

118 Michigan St., CHICAGO, ILL.

REGULAR CONTRIBUTORS:

G. M. Doolittle, of New York. Prof. A. J. Cook, of California.
 Dr. C. C. Miller, of Illinois. Dr. J. P. H. Brown, of Georgia.
 J. H. Martin, of California. Rev. E. T. Abbott, of Missouri.
 Barnett Taylor, of Minnesota. Mrs. L. C. Axtell, of Illinois.
 Chas. Dadant & Son, of Illinois.

\$1.00 a Year—Sample Copy Sent Free.

[Entered at the Post-Office at Chicago as Second-Class Mail-Matter.]

Vol. XXXVI. CHICAGO, ILL., JULY 2, 1896. No. 27.

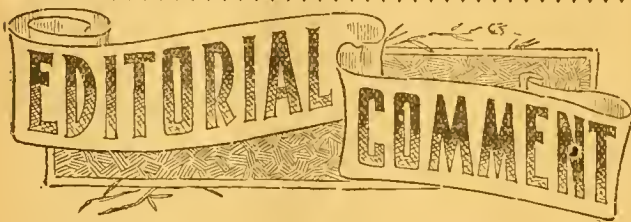

A National Bee-Association.—Editor Root, in Gleanings for June 15, says that a private letter from a prominent bee-keeper, commenting on the amalgamation matter, contains the following, the italics being put in by Mr. Root:

"All this talk about "marrying," and "a poor society wanting to get the money of the other," is "all bosh," for those who are the very backbone of each are the very ones who are in favor of a union or a new organization, the outgrowth of the others.....It makes no difference to me, and I guess not to any one else, what we organize, so that it is what beekeepers want."

Then following the above quoted paragraph, is this editorial comment:

"The bee-keepers of this country want, if they want anything, a national association; and the easiest way, in my estimation, is to make the Union a deliberative body, having annual meetings. Let the old North American stand as it is."

Again we agree with Mr. Root, in making the National Bee-Keepers' Union a "national" organization—in fact, what it is in name. The old North American can "stand" or fall, in case the Union is remodeled so as to hold annual meetings.

But it seems to us it would be a good thing to have a vote taken by the Union before the next meeting of the North American, as the result might help in the decision of some things that will likely come up then. Whether the amalgamation project carries or is defeated, it would be well to know the feeling of the Union members on the matter in advance of the North American meeting, to be held in a few months.

The Marketing of Honey will soon be a question that many readers of the Bee Journal will be called on to solve. And it will be hard for some to decide just what is best to do. In view of this, we wish to hear from those who have been successful in their efforts to make the most out of their honey when selling the same. If those who have had such experience will please write it out, we will be glad to give it place in these columns. Let us hear what is best for the small producer as well as the large.

Naming Honey-Plants.—Dr. H. S. Pepon, 936 Belleplaine Ave., Station X., Chicago, Ill., has kindly offered to name, in the Bee Journal, any plants sent to him by our subscribers. Those desiring to take advantage of the Doctor's kind offer, will please send the specimens direct to him, when he will report on them to us. Please be particular to send a letter with each specimen, telling all you know about the plant, the kind of soil it grows on, the common, local name, if it has one, in fact, anything that might aid in its certain identification.

Mr. Hayck, of Quincy, Ill., sent us a specimen recently, accompanied by the following letter:

MR. EDITOR:—I send a flower on which bees work with all their might. On bunches like the one I send there are constantly from three to six bees. I found only three bushes, and each bush has about 20 stalks, with as many clusters of flowers. It grows on fine, sandy soil, about 20 to 24 inches in high. Will you kindly let me know through the American Bee Journal what name the flower has, if it has any?

B. W. HAYCK.

Dr. Pepon, to whom we submitted the specimen, says:

The plant sent by Mr. Hayck is known commonly by the names "pleurisy-root" and "butterfly-weed," having the botanical name of *Asclepias tuberosa*. It is a member of the Milkweed family, as may easily be seen by comparing the flowers with those of the common milk or silk weed. All the milkweeds are great favorites with the bees. This particular plant is a most showy one, and easy of cultivation.

H. S. PEPOON.

Bee-Paralysis.—Editor Root, in last Gleanings, says that the question has been asked "as to how the name 'bee-paralysis' originated for a certain kind of disease that afflicts bees, causing them to become swollen, black, and shiny, and to exhibit a palsied or trembling motion." In reply, Mr. Root says:

When our "A B C of Bee-Culture" was first written, its author described this disease as above, and then said he had no name for it. For a time it was called the "nameless bee-disease." This, certainly, was a misnomer, and a discredit to those of us who help to make our special nomenclature.

I called Prof. Cook's attention to the matter, and asked him to give us a name from his standpoint as an entomologist, that would be appropriate and at the same time indicative of the real symptoms and characteristics of the disease. He suggested "bee-paralysis." Liking the appellation, I incorporated it in all our own bee-keeping literature as far as possible, instead of the old or "nameless" name that had been used formerly.

This same disease was called by Mr. Cheshire, *Bacillus Gaytoni*, after Miss Gayton, who first called his attention to this peculiar disease; but at that time we were not aware that bee-paralysis and *Bacillus Gaytoni* were probably one and the same; but we now have good reasons to believe that they are, from descriptions that have come to us from across the water, as they tally so closely with what we now know to be and call bee-paralysis.

T. S. Ford has an interesting article on "Bee-Paralysis" in this very number, page 420. Read it. He has had large experience with the disease.

Milk and Honey.—In the Agricultural Epitomist, Mr. H. B. Geer says there is more significance in the biblical expression of "a land that flows with milk and honey," than is generally understood. It is a physical, or digestive, so to speak, significance. For there is a connection between milk and honey that makes the latter of much more value as a food when the relation between the two is understood. It exists in the fact that honey in large quantities can be eaten by any one who will drink sweet milk freely at the same time.

Just what the natural affinity between the two is in a gastronomic sense we do not know, but we do know that sweet milk is a good antidote for what otherwise would be an overdose of honey. Whether the ancients knew of this happy connection between the two articles of food that they have

associated in immortal verse of course is unknown. But from the fact that milk and honey unite in the human system without painful or injurious effect, it is quite probable that they did.

The Bay State Fair will be held in Worcester, Mass., beginning Sept. 1. The following are the rules and premiums offered in the apiarian department:

1. Exhibitors in this department cannot compete for more than one premium with the same exhibit.
2. Observatory hives must be a single frame inclosed with glass, so that both sides of the comb can be readily examined.
3. Any adulteration detected in honey on exhibition bars the same from competition.
4. All honey must be of this season's crop, and exhibited by the producers.

Best full colony of any pure race of bees, in movable-frame hives, 1st, \$5; 2nd, \$2; 3rd, V. H. C.

Largest and best collection of the different races of bees in observatory hive, 1st, \$8; 2nd, \$4; 3rd, V. H. C.

Best colony of Italian bees in observatory hive, 1st, \$2; 2nd, \$1; 3rd, V. H. C.

Best colony of black bees in observatory hive, 1st, \$2; 2nd, \$1; 3rd, V. H. C.

Best exhibit of queen-cells containing live embryo queens on one frame, as built by the bees, in observatory hive, 1st, \$2; 2nd, \$1; 3rd, V. H. C.

Best exhibit of bees in embryo, showing the different stages of development, from the egg to mature bee, 1st, \$2; 2nd, \$1; 3rd, V. H. C.

Best exhibit of live queens in shipping cages, with attendant bees, 1st, \$2; 2nd, \$1; 3rd, V. H. C.

Best case of comb honey, to contain not less than 24 pounds, 1st, \$2; 2nd, \$1; 3rd, V. H. C.

Largest and best exhibit of comb honey, 1st, \$6; 2nd, \$3; 3rd, V. H. C.

Best display of comb honey in fancy style, as made by the bees, 1st, \$4; 2nd, \$2; 3rd, V. H. C.

Largest and best exhibit of extracted honey, 1st, \$6; 2nd, \$3; 3rd, V. H. C.

Best exhibit of extracted honey, showing the greatest variety from the different flowers, 1st, \$3; 2nd, \$1; 3rd, V. H. C.

Best exhibit of apiarian implements, 1st, \$5; 2nd, \$3; 3rd, V. H. C.

The foregoing list should call out a liberal display. Bee-keepers should encourage the Fair managers by showing that they appreciate the efforts put forth to attract a large number of exhibits. They are not slow, usually, to increase the premiums in future years when they know that great interest is manifested.

Starting an Argument.—In the American Bee-Keeper for June we find this editorial paragraph:

At the present time there is no particular subject pertaining to bee-keeping that is receiving any more attention than another. This is a very unusual state of affairs. Some one ought to start an argument of some kind.

If ever the American Bee-Keeper had a good chance it is now. Why should it continue to be so extremely modest? Here is a grand opportunity to "start an argument of some kind," and it simply says that "some one ought to" do it. We move that our esteemed contemporary make the effort just for once, "to start an argument," and may be the rest of us will try to help it change the present "very unusual state of affairs" which seems to worry our Eastern friend.

We shall look for the "argument" to start about July 4, accompanied with a grand pyrotechnical display.

A Correction.—In the last six paragraphs of the article by Lyman C. Kebler (pages 406 and 407), on "Beeswax and Its Adulterants," please read "gram" instead of "grain" wherever the word "grain" appears. It should have been "gram" in each case.

Now is the Time to work for new subscribers. Why not take advantage of the offers made on page 426?

PERSONAL MENTION.

MR. E. A. SEELEY, of Bloomer, Ark., when renewing his subscription June 9, wrote thus: "As long as I keep bees I intend to take the 'Old Reliable.' I could not get along without it."

MRS. SALLIE E. SHERMAN begins this week the series of articles on her "Fifteen Years' Experience in Bee-Keeping." Mrs. S. is an interesting writer, and a pleasant lady to meet. She has made a success of bee-culture, and loves to inspire other women to "go and do likewise."

MR. THOMAS G. NEWMAN's little grandson, we regret very much to learn, was near Death's door for weeks recently, with inflammation of the lungs, but Mrs. Newman seems to improve in health in the San Diego (Calif.) climate. We hope she will continue to get better until fully recovered.

MR. J. B. HALL, of Woodstock, Ont., was once the preceptor of Mr. H. E. Hill, who in the American Bee-Keeper reports that Mr. Hall once remarked that bee-keeping would pay him even if he lost all of his bees every winter, but he never knew him to meet with a winter loss worth mentioning.

MRS. HALLENBECK, of Nebraska, in the last Progressive Bee-Keeper, says: "Nebraska never does things by halves, and whether it is wet or dry, we are pretty certain of an abundance of the predominating variety. . . . Although we have had a good deal of wet, no one complains. The severe lesson of the last two years has taught us better."

MR. EMERY NEWELL, of Kane county, Ill., recently wrote thus kindly:

"Enclosed you will find the amount to pay for your excellent Bee Journal to the end of 1896. We enjoy your paper very much, for it contains practical facts for practical people, and we earnestly hope it will increase its subscribers, and continue to instruct its patrons."

MR. H. E. HILL, of Florida, when renewing his subscription, on June 19, wrote these very kind words, which we assure him are very much appreciated:

"Circumstances have several times prevented me from giving expression to my appreciation of the American Bee Journal, under its present editorial management, and I will now refrain from verbose eulogies, but briefly and heartily assure you of the entire satisfaction which it carries weekly to one subscriber. During my 16 years of bee-keeping I have been a constant reader of the American Bee Journal, and I am sure any competent and unbiased critic must admit that it is a better journal to-day than at any stage of its existence, thanks to your earnest and no less able efforts. A remarkable feature, and one fully appreciated, is the marvelous regularity of its weekly arrivals. Of the several journals which I receive, none arrive nearly so regularly."

MR. JOHN ORVAL, who is trying to write cute things in one of our Southern exchanges, says, in referring to our item of a few weeks ago, about someone selling 5,000 queens in a season:

"Say, York, give me the name of that woman that reported a sale ten times too big, and John Orval will show her up in the light she so justly deserves."

We never said that a woman herself reported that she sold 5,000 queens in one year, for she never did, so far as we know.

"John" further says that he is "a dandy at showing up frands." While there may be plenty of them in the North, he'll have no trouble in finding at least one in the South. Wake up, John, and show it up.

Now for a 2-Month Campaign

Please Read All of this Page.

A Few of the Good Things to Appear in the Bee Journal the Next Six Months:

Fifteen Years' Experience in Bee-Keeping.

Mrs. Sallie E. Sherman will begin, in the first number for July, a full account of her 15 years of bee-keeping in Texas. An article from her will appear each week for a number of weeks. They will be of much interest to all, and especially so to Southern bee-keepers.

A Dozen Articles by "The Dadants."

Chas. Dadant & Son, of Illinois, are the leading extracted honey producers of this part of the country. One year they had 48,000 pounds. They will contribute during the next six months, at least a dozen articles, drawn from their experience of a third of a century of bee-keeping.

A Dozen Articles by Mr. Doolittle.

G. M. Doolittle is unquestionably one of the very ablest bee-keepers in this country, and his writings on practical bee-culture have made him famous. With his 27 years' experience, he is well equipped to write profitably for the beginner or even the expert bee-keeper.

A Half-Dozen Articles by Prof. Cook.

Prof. A. J. Cook, of California, author of "The Bee-Keepers' Guide," will contribute at least six good articles before Jan. 1, 1897. He is always interesting and helpful.

A Full Report of the North American Convention

will be published in this paper immediately after the annual meeting, which will be held in September or October next, at Lincoln, Nebr. The Secretary—Dr. A. B. Mason—is now at work on the program, which promises to be the best ever gotten up by the Association. Every American bee-keeper will be interested in the many valuable essays and discussions found in the proceedings of their great annual convention.

A Variety of Contributions by Many Others,

who are well qualified to teach modern bee-culture, will also appear during the next six months. All the foregoing in addition to the

Several Special or Regular Departments

will make the American Bee Journal almost priceless to the man or woman who desires to make a genuine success of bee-culture, and keep informed about the doings of the apiarian world.

Some Liberal Premiums to Regular Subscribers.

We want every regular reader of the American Bee Journal to go to work to secure new subscribers, which we will accept at

40 Cents for the Next Six Months.

Yes, sir; we will mail the American Bee Journal from July 1, 1896, to Jan. 1, 1897—26 numbers in all—to any one not now a subscriber, for just 40 cents. And to those of our present subscribers who will work to get the new names, we make these

Generous Premium Offers:

For sending us One New Six-Months' Subscription (with 40 cents), we will mail the sender his or her choice of one of the following list of pamphlets:

Foul Brood, by Dr. Howard.
Kendall's Horse-Book.
Rural Life.
Silo and Silage, by Prof. Cook.
Foul Brood, by Köhnke.

Dr. Foote's Hand-Book of Health.
Poultry for Market and Profit.
Our Poultry Doctor.
Turkeys for Market and Profit.
Capon and Caponizing.

For sending Two New Six-Months' Subscriptions (with 80 cents), your choice of one of the following:

Monette Queen-Clipping Device.
Blenden-Kultur.
Bees and Honey (paper cover).

Winter Problem, by Pierce.
Alley's 30 Years Among the Bees.
Queenie Jeanette (a Song.)

For sending Six New Six-Months' Subscriptions (with \$2.40), your choice of one of the following:

Novelty Pocket-Knife (with name). Prof. Cook's Bee-Keeper's Guide

\$25.00 Cash, in Addition to the Above.

Besides all the foregoing premiums, we will distribute, on Sept. 1, 1896, \$25.00 in cash to the nine having sent in the highest number of new 40-cent subscriptions before that date, (but only those having sent 10 or more new subscriptions can compete for the extra cash premiums) in these amounts: To the one sending the highest number, \$10.00. The 2nd highest, \$5.00; 3rd, 4th and 5th highest, \$2.00 each; and to the 6th, 7th, 8th and 9th highest, \$1.00 each.

Let Every One Begin NOW to Work.

We will be glad to mail free sample copies, upon request, either to a club-raiser, or direct to those you desire to solicit, if you will send in the names and addresses.

All subscriptions will begin with the first number in July.

Yours for a two-months' campaign,

GEO. W. YORK & CO., 118 Mich. St., Chicago.

"Samantha at the World's Fair."—We want to make our present readers one of the best offers ever made. All know the excellent books written by "Samantha, Josiah Allen's Wife." Well, "Samantha at the World's Fair" is probably her best, and we are enabled to offer *this book and a year's subscription to the New York "Voice"* (the greatest \$1.00 weekly temperance paper published to-day), for sending us *only three new subscribers* to the American Bee Journal (with \$3.00), provided you are *not now* a subscriber to the "Voice." Think of it—a grand book and a grand weekly temperance newspaper *given simply for sending* us three new subscribers to the Bee Journal for a year! The Samantha book is exactly the same as the \$2.50 one, only the binding is of heavy manilla instead of cloth. It is a special 100,000-copy edition, and when they are all gone, the offer will be withdrawn by the publishers. Of course, no premium will also be given to the new subscribers—*simply the American Bee Journal for one year.*

Only One Cent a Copy for copies of the American Bee Journal before Jan. 1, 1896. We have them running back for about 10 years. But you must let us select them, as we cannot furnish them in regular order, and probably not any particular copies. Just send us as many one-cent stamps as you may want old copies, and we will mail them to you.

Honey as Food and Medicine.—A new and revised edition of this 32-page pamphlet is now issued. It has 5 blank pages on which to write or paste recipes taken from other sources. It is just what its name indicates, and should be liberally distributed among the people everywhere to create a demand for honey. It contains a number of recipes on the use of honey as food and as medicine, besides much other interesting and valuable information. Prices, postpaid, are: Single copy, 5 cts.; 10 copies 30 cts.; 50 for \$1.00; 100 for \$1.75. Better give them a trial. Send all orders to the Bee Journal office.

General Items.

Too Cold and Wet.

Swarming here is late this season; we have had a cold, wet spring. Clover is out in full bloom, yet the bees get very little chance to get at it on account of the rain and cold. I do not think we will get much of a crop this season, if the weather continues this way.

G. D. LITTOOY.

Tacoma, Wash., June 11.

Discouraging Prospects.

The present season in the surrounding vicinity is the worst experienced by beekeepers for 20 years. Hundreds of colonies are without a drop of honey in the hive, as continuous rains have washed all the nectar from the flowers during the past six weeks. Our main hope—the dry-weather honey-vine—does not give bright prospects, as the many rains give the farmers an opportunity of clearing their corn-fields of the vine, where it delights in winding about the corn. It is only in seasons of severe drouth that we get a good crop from it. White clover yields nothing; we have had no perceptible yield from that source in five years. Very little swarming is heard of, I having secured but two swarms to date, and they were forced.

I have planted seeds of every known honey-producing plant, that I may find the best kinds for my vicinity, and further those species.

Mrs. Schultz, with 100 colonies, secured considerable comb honey from crimson clover in May, but she reports the color dark and quality rank. If this be true, it will not prove such a boon to bee-keepers as some think.

J. C. WALLENMEYER.

Evansville, Ind., June 12.

A Report from Mexico.

I want to tell you how much I like the American Bee Journal. I began two years ago with one Mexican colony of bees, which I lost in transferring. From the next one I bought, I have now more than 50. There are none around me within about 1,000 miles that could tell me anything about bees. Nevertheless, I am selling now in sections as nice honey as could be sold in the United States.

You will be astonished how easily I manage my bees. First, there is no winter here, which spares me a good deal of trouble. The sun and rains here are so heavy that I thought it better to put my bees under shelter. I bought the cover of an old car, put it on posts, and cross-woods between the posts on which rests my hives, three rows, one above the other. This summer I will try some out-doors, with a tin on top for the rain.

The hive I use is of the Langstroth size outside. I put the frames in cross-wise—not the long way—because they seem to me too clumsy and heavy to handle nice and quick. By my way I get in just 13 frames. This summer I am trying some hives with only 10 frames. The entrance is 6 by 1/2 inch, because bees have more enemies here, and can defend themselves more easily with a smaller entrance. The bottom is nailed to the hive. I use shallow frames

THE "NOVELTY" POCKET-KNIFE!

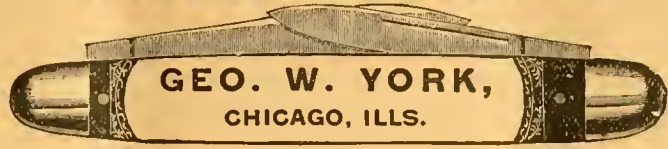

Your Name on the Knife.—When ordering, be sure to say just what Name and Address you wish put on the Knife.

The NOVELTY KNIFE is indeed a novelty. The novelty lies in the handle. It is made beautifully of indestructible celluloid, which is as transparent as glass. Underneath the celluloid, on one side of the handle is placed an AMERICAN BEE JOURNAL reminder, and on the other side, name and residence of the Subscriber.

The material entering into this celebrated knife is of the very best quality; the blades are handforged out of the very finest English razor-steel, and we warrant every blade. The bolsters are made of German silver, and will never rust or corrode. The rivets are hardened German silver wire; the linings are plate brass; the back springs of Sheffield spring steel, and the finish of handle as described above. It will last a lifetime, with proper usage.

Why purchase the Novelty Knife? In case a good knife is lost, the chances are, the owner will never recover it; but if the Novelty is lost, having name and address of owner, the finder will return it; otherwise to try to destroy the name and address, would destroy the knife. If traveling, and you meet with a serious accident, and are so fortunate as to have one of the Novelties, your pocket KNIFE will serve as an identifier; and in case of death, your relatives will at once be apprised of the accident.

How appropriate this knife is for a Christmas, New Year or birthday present! What more lasting memento could a mother give to a son, a wife to a husband, a sister to a brother, a lady to a gentleman, or vice versa, a son to a mother, a husband to a wife, a brother to a sister or a gentleman to a lady—the knife having the name of the recipient on one side?

The accompanying cut gives a faint idea, but cannot fully convey an exact representation of this beautiful knife, as the "Novelty" must be seen to be appreciated.

How to Get this Valuable Knife.—We send it postpaid, for \$1.00, or give it as a Premium to the one sending us three new Subscribers to the BEE JOURNAL (with \$3.00), and we will also send to each new name a copy of the Premium Edition of the book "Bees and Honey." We club the Novelty Knife with the BEE JOURNAL for one year, both for \$1.90.

Any Name and Address Put on the Knife.

GEORGE W. YORK & CO.,
CHICAGO, ILLS.

Allow about two weeks for your order to be filled.

PATENT WIRED COMB FOUNDATION

Has No Sag in Brood-Frames

Thin Flat-Bottom Foundation

Has No Fishbone in the Surplus Honey.

Being the cleanest is usually worked the quickest of any Foundation made

J. VAN DEUSEN & SONS,

Sole Manufacturers,

Sprout Brook Montgomery Co., N. Y.

Mention the American Bee Journal



ONE MAN WITH THE UNION COMBINATION SAW

Can do the work of four men using hand tools, in Rippling, Cutting-off, Milling, Rabbling, Grooving, Gaining, Dadoing, Edging-up, Jointing Stuff, etc. Full Line of Foot and Hand Power Machinery Sold on Trial. Catalogue Free.

SENECA FALLS SFG. CO.,

46 Water St.,

SENECA FALLS, N. Y.

1A1y Mention the American Bee Journal.

Dadant's Foundation in Chicago!

No other Goods kept here.

Send for Price-List.

CHAS. DADANT & SON,

118 Michigan St.,

CHICAGO, ILL.

13A1f

Please mention the Bee Journal.

3-Frame Nucleus

and Italian Queen, after July 1st, \$2.50.

Untested Queens, 75c each.

Discount on quantities. A Catalogue of Practical Apian Supplies, Free. Address,

I. J. STRINGHAM,

105 Park Place.

NEW YORK, N. Y.

That Queen-Clipping Device Free!

Works Like a Charm.

The Monette Queen-Clipping Device WORKS LIKE A CHARM. With it I have clipped 30 queens, all in one day, when examining my bees. WM. STOLLEY, Grand Island, Nebr.

Couldn't Do Without It.

I have clipped 19 queens, and must say the Monette Queen-Clipping Device is by far the best invention ever made, and will be welcome to many bee-keepers as it was to me. I could not do without one now.

DR. GEO. LACKE, Newburgh, Ind.

PLEASE READ THIS OFFER TO PRESENT SUBSCRIBERS:

Send us just one new name for the American Bee Journal a year (with \$1.00), and we will mail you the Queen-Clipping Device FREE of charge. Or, the Queen-Clipping Device will be sent postpaid for 30 cts. But why not get it as a Premium by the above offer? You can't earn 30 cts. any easier. Almost every bee-keeper will want this Device. See page 130 (Feb. 27) for full description of it. Complete directions accompany each one sent out. It is a most ingenious and useful article. Address,

GEORGE W. YORK & CO., 118 Michigan St., Chicago, Ill.

❖ MONEY SAVED IS MONEY GAINED. ❖

THE ROYAL UNION Life Insurance Company DES MOINES, IOWA.

The Iowa Policy

Is one that definitely promises to keep an accurate account with you; credit your premiums and interest, charge the actual expense and mortality cost, and hold the remaining funds subject to your order.

Agents Wanted.

JOHN B. KING, GENERAL AGENT,
Suite 513 First Nat'l Bank Bld'g,
20 Atf
CHICAGO, ILL.

Mention the American Bee Journal.

WARRANTED GOLDEN ITALIAN QUEENS By return mail; bred from a Breeder tested by Doolittle out of 1,000 Queens for his own use, and valued at \$50. Queens, 50c; 6 for \$2.75; or \$5.00 per dozen.

Leather Colored Queens from Root's best imported stock same price. Bees from my Queens are excellent workers on red clover. I guarantee safe delivery. N. B.—I sent more than 200 Queens safely to California last season.

H. G. QUINN, Bellevue, Ohio.

23A16 Mention the American Bee Journal.

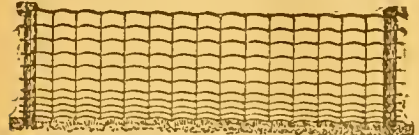

The Ten Year Test

This is attracting considerable attention among fence buyers. They realize that all wire fences are nice when first put up, but that very few are presentable after two or three years. After ten years service there is but one able to answer roll call—

The Page Woven Wire Fence, made at Adrian, Mich.

WHEN ANSWERING THIS ADVERTISEMENT, MENTION THIS JOURNAL.

IF YOU WANT THE BEE-BOOK

That covers the whole Apicultural Field more completely than any other published, send \$1.25 to Prof. A. J. Cook, Claremont, Calif., for his

Bee-Keeper's Guide.

Liberal Discounts to the Trade.

California ❀❀

If you care to know of its Fruits, Flowers Climate or Resources, send for a Sample Copy of California's Favorite Paper—

The Pacific Rural Press

The leading Horticultural and Agricultural paper of the Pacific Coast. Published weekly, handsomely illustrated, \$2.00 per annum. Sample Copy Free.

PACIFIC RURAL PRESS,
220 Market St., - SAN FRANCISCO, CAL.

TEXAS QUEENS.

If you are in need of Queens, let me have your order. Price-List Free.

8A26t **J. D. GIVENS, Lisbon, Tex.**
Mention the American Bee Journal.

Full Colonies of Italian Bees for \$1.00, or particulars see larger ad. on page 350 of this paper. **Tested Queens**, after June 10th, 75 cts. each; 2 for \$1.25. Address, **T. H. KLOER,** 426 Willow St., **TERRE HAUTE, IND** 23A4t. Mention the American Bee Journal.

for the supers for extracting, or sections, of which 31 go in a super. I have pieces of tin or zinc cut to size for separators. The sections I fix with T tins. Till now I had only once a little drone-brood in a super, though I do not have any queen-excluder. I think the capacity of my brood-nest is about right for here.

I do not fuss very often with my bees. To make them work straight, I put little bits of wax on the frames as a guide. Now I alternate straight-built frames with empty ones. Sometimes I examine the new ones, so they will not build crooked combs, that is nearly all. Every now and then I look into the super, and when there are full sections or frames, I exchange them for empty ones. I cannot pile them up in the house, for the reason that I have to make all things myself. I do not know yet the use of various supplies used in the United States. All foreign goods here have an awfully high duty on them.

Of course, I do not call this management scientific bee-keeping, but it suits me, and is easy and far superior to the Indian way. It pays well enough, especially the wax which sells for \$1.00 per pound. For that reason I should like to have a strain of bees that makes only wax.

F. BUSSLER,
Orizaba, Mexico, May 26.

Not a Large Crop Expected.

Having a very dry fall in 1895, and a sorghum-mill near me, my colonies ran down so that they went into winter quarters in poor condition. I had to feed full winter stores to about 6 colonies, I had to double up, and from robbing and the loss of queens brought me to 40 colonies from some 50 at fruit-bloom the first of April.

Bees did well on tulip or poplar in May. White clover is a failure, as I have seen but two or three bees on the bloom, it being in bloom since about May 10. June, so far, is a failure. Bees are consuming their stores and getting nothing. There is about 200 pounds of surplus, but I am afraid to take it, as only about one-third of the basswood trees will bloom, and some of them sparingly.

W. W. MOUNT,
Farmington, Tenn., June 11.

Not Much Surplus Clover Honey.

White and Alsike clovers are and have for some time been in full bloom; and are getting some pollen and a little honey from them. No work is being done in the sections to amount to anything yet. Unless there is a change, and that soon, we will not get much, if any, surplus clover honey here.

C. MONETTE,
Chatfield, Minn., June 12.

Bees in a Green-House.

I am very much pleased with the Bee Journal, as I find a great many practical hints on bee-keeping and other useful articles on bees.

This spring I had a pure Italian queen and not over 200 bees left with her. I wanted to save her if possible. I took her to the green-house, fed them oatmeal and wheat flour, which they carried in. In two weeks they had brood about 2 inches square. I then gave them a brood-comb with all the bees adhering to the comb. In two weeks more

The Bee-Keeper's Guide:

Or Manual of the Apiary,

BY PROF. A. J. COOK.

This 15th and latest edition of Prof. Cook's magnificent book of 460 pages, in neat and substantial cloth binding, we propose to give away to our present subscribers, for the work of getting new subscribers for the American Bee Journal.

A description of the book here is quite unnecessary—it is simply the most complete scientific and practical bee-book published today. Fully illustrated, and all written in the most fascinating style. The author is also too well-known to the whole bee-world to require any introduction. No bee-keeper is fully equipped, or his library complete, without "THE BEE-KEEPER'S GUIDE."

Given For 2 New Subscribers.

The following offer is made to PRESENT subscribers only, and no premium is also given to the two new subscribers—simply the Bee Journal for one year:

Send us **Two New Subscribers** to the Bee Journal (with \$2.00), and we will mail you a copy of Prof. Cook's book FREE as a premium. Prof. Cook's book alone sent for \$1.25, or we club it with the Bee Journal for a year—both together for only \$1.75. But surely anybody can get only 2 new subscribers to the Bee Journal for a year, and thus get the book as a premium. Let everybody try for it. Will you have one?

GEORGE W. YORK & CO.,
CHICAGO, ILLS.

A Bargain—EARLY QUEENS.

119 Colonies Italian Bees in Chaff Hives; two acres land; good house; excellent well

Early Queens—Tested, \$1.00; Untested, 50c. Sent by return mail.

E. L. CARRINGTON,
16Atf **PETTUS, Bee Co., TEX.**
Reference—1st National Bank of Beville.

Mention the American Bee Journal.

CARLOADS



Of Bee-Hives, Sections, Shipping-Cases, Comb Foundation, and Everything used in the Bee-Industry.

I want the name and address of every Bee-keeper in America. No reason why you cannot do business with me. I have Cheap Lumber and Experienced Workmen; a good Water Power Factory and know how to run it. I am supplying Dealers as well as consumers. Why not you? Send for Catalogues, Quotations, etc. **W. H. PUTNAM,** 1E RIVER FALLS, Pierce Co., WIS.

Mention the American Bee Journal.

Page & Lyon Mfg. Co.,

► **NEW LONDON, Wis.**, operates two saw-mills that cut, annually, eight million feet of lumber, thus securing the best lumber at the lowest price for the manufacture of bee-keepers' supplies. They have also just completed one of

The Largest Factories,

► and have the latest and most improved machinery for the manufacture of Bee-Hives, Sections, etc. that there is in the State. The material is cut from patterns, by machinery, and is absolutely accurate. For Sections, the clearest and

The Whitest Basswood

► is used, and they are polished on both sides. Nearness to pine and basswood forests, and possession of mills and factory equipped with best machinery, all combine to enable this firm to furnish the best goods at

The Lowest Prices. ♡♡

► For instance, it has a job lot of 200,000 No. 2 Sections that will be sold at 50 cts. per 1,000; or 2,000 Snow-White sections will be sold for \$1.00, and larger quantities at still lower prices. Send for Circular and see the prices on a full line of supplies. 16Atf

Mention the American Bee Journal.

\$25.00 { Given Away in GOLD } to Contestants.

Who can form the greatest number of words from the letters in **CONTESTANTS** by using them backward or forward? You are smart enough to make fifteen or more words, we feel sure, and if you do you will receive a good reward. Do not use any letter more times than it appears in the word. Here is an example of the way to work it out: Con, cust, coat, on, test, to, eat, etc. The publishers of **WOMAN'S WORLD** and **JENNIS MILLER MONTHLY** will pay \$10 in gold to the person able to make the largest list of words from the letters in the word **CONTESTANTS**; \$6 for the second largest; \$3 for the third; \$3 for the fourth, and \$1 to the fifth, and a lady's handsome American movement watch for each of the seven next largest lists. Every person sending a list of fifteen words or more is guaranteed a present by return mail of a large 100-page book, "Beside the Bonnie Briar Bush," by Ian Maclaren, one of the most fascinating books of the age. The above rewards are given free and without consideration for the purpose of attracting attention to our handsome and valuable ladies' magazine, twenty-four pages, ninety six long columns, finely illustrated, and all original matter, long and short stories by the best authors; price \$1 per year. It is necessary for you to send 12 two-cent stamps for a three-months' trial subscription with your list of words. Satisfaction guaranteed in every case or your money refunded. List of successful contestants published in the September issue. Our publication has been established nine years. We refer you to any mercantile agency for our standing. Write now. Address **J. H. PLUMMER**, Publisher, 905 Temple Court, New York City.

DO NOT ORDER UNTIL YOU HAVE WRITTEN US FOR PRICES ON

The "Boss" One-Piece Section



Also D. T. Hives, Shipping-Crates and Other Supplies.

We have completed a large addition to our Factory, which doubles our floor room; we are therefore in better shape than ever to fill orders on short notice. **Send for Price-List**

J. FORNCROOK,

WATERTOWN, Jeff. Co., Wis., Jan. 1st, 1896.

Barnes' Foot-Power Machinery.



Read what **J. I. PARENT**, of **CHARLTON, N. Y.**, says—"We cut with one of your Combined Machines, last winter 50 chaff hives with 7-in. cap, 100 honey-racks, 500 broad frames, 2,000 honey-boxes and a great deal of other work. This winter we have double the amount of beehives, etc., to make and we expect to do it with this Saw. It will do all you say it will. Catalogue and Price-List

Free. Address, **W. F. & JOHN BARNES**, 45Ctf No. 995 Ruby St., Rockford, Ill.

Mention the American Bee Journal.

The RURAL CALIFORNIAN

Tells all about Bees in California.

The Yields and Price of Honey; the Pasturage and Nectar-Producing Plants; the Bee-Ranches and how they are conducted. In fact the entire field is fully covered by an expert bee-man. Besides this, the paper also tells you all about **California Agriculture and Horticulture**. \$1.50 per Year; Six Months, 75 cents. Sample Free.

THE RURAL CALIFORNIAN, 218 N. Main St., LOS ANGELES, CALIF.

Down Go the Prices!

I am having such good luck in queen-rearing, I shall the balance of the season sell our fine **ADEL QUEENS** at the following prices—One Queen, \$1.00; three, \$2.50; six, \$4.50; or one dozen for \$8.00. Safe arrival and quality guaranteed. Cat. free.

HENRY ALLEY, 25Atf WENHAM, Essex Co., MASS.

I had over 1,000 young bees, and this was about the first of April. I gave them two combs more full of brood, and put them out-doors. I have now a large swarm and six young queens from her.

I also sold two colonies to a greenhouse man—a subscriber to the Bee Journal. He wanted them to put in his cucumber houses to fertilize the vines. He had cucumbers early, and sold some for \$1.50 per dozen.

Another greenhouse man came to see Mr. Strong's cucumbers; he said his vines had not any cucumbers on. "What do you do to have your vines bear so?" It is the bees. He went and bought a colony right off, and put in his cucumber house.

Mr. Strong's bees did not all go back to the hive; the young bees would fly against the glass and tire themselves out. It was a pleasant sight to see them working on the blossoms when it was cold out-of-doors. I told him he would not get much honey if they were not put out-of-doors. He said: "I don't care; I have had more than the bees cost me." The bees are out-of-doors now, and are doing well. They go in and out of the greenhouse windows.

I have never noticed anything of nursing weak swarms or bees in greenhouses, or keeping bees in greenhouses to fertilize cucumbers. **R. L. MACEY**, Grand Rapids, Mich., June 12.

More White Clover than for Years.

We have more white clover this year than we have had for five or six years, and bees are just rolling in the honey. I have had bad luck this year with the bees from spring dwindling, so that I have only a few colonies to gather honey. **A. J. PEDERSEN**, St. Paul, Minn., June 16.

Prospects Quite Good.

Bees are lively, and seem to want to swarm. Basswood is budded quite full, and the present prospects are quite good for a honey crop. **N. D. WEST**, Middleburgh, N. Y., June 17.

Bees Swarming Lively.

I have 125 colonies, spring count. They are swarming pretty lively now. I look for the American Bee Journal every week, and I am not disappointed. **J. H. WARNER**, Middleburgh, N. Y., June 19.

Promising Prospects.

The prospect for a honey crop was quite promising, but for the past week we have had rain every day, more or less, together with cloudy weather, so that bees could do but little or nothing in the way of gathering honey, but sweet clover and catnip are yet before us, and with plenty of moisture we may still get a good honey crop. **H. G. QUIRIN**, Bellevue, Ohio, June 15.

Bees Not Doing Well.

I am living in the Black Fork Mountains, 6 miles east of the Indian Territory line. I am 45 years old, and have worked with bees nearly all my life, and yet never saw a nice, finished bee-hive. I have now 26 colonies, but it is a hard

No. 1 Sections—Cheap.

We offer for a few weeks, a surplus stock of our one-piece **No. 1 Cream Sections** at the following very low prices:

- 1000 for \$1.50.
- 3000 for \$4.00.
- 5000 for \$6.00.

These Sections are finely finished and No. 1 in all respects save color, being, as their name indicates, of a cream color.

The stock consists of a quantity each of the following sizes:

- 4 1/4 x 2, open 2 sides 4 1/4 x 1 15-16, open 2 sides
- 4 1/4 x 1 7-8, open 2 sides
- 4 1/4 x 1 1/4, open 2 sides 4 1/4 x 7-to-ft., open 2 sides

G. B. LEWIS CO.

WATERTOWN, WIS.

Mention the American Bee Journal.

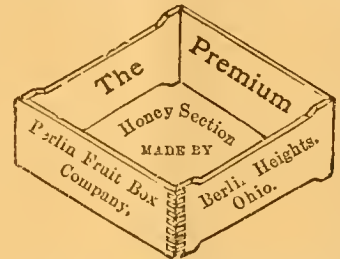

—BEE SUPPLIES—
and all kinds of Boxes, Bee-Crates, and Baskets. We make a specialty of 1-piece Sections & Wood Separators

Address, **BERLIN FRUIT-BOX CO**, 20A8t BERLIN HEIGHTS, OHIO.

Mention the American Bee Journal.

\$525 Agent's profits per month. Will prove it or pay forfeit. New articles just out. A \$1.50 sample and terms free. Try us. 22A8t **CHIDESTER & SON**, 28 Bond St., N. Y.

WHEN ANSWERING THIS ADVERTISEMENT, MENTION THIS JOURNAL.

Hives & Combs For Sale.

45 10-frame Langstroth Hives, two-story, for extracting, as made and sold by T. G. Newman. These are empty—no frames—are well packed, and have been kept in the bee-house. Price, 75 cents each.

Also, 400 Brood or Extracting Combs for the above hives; they have the triangular top-bar as made by Newman. They are clean and in good condition. Price, \$15.00 per 100.

I would take \$85.00 for the whole lot of Hives and Combs.

Reference—American Bee Journal.

W. C. LYJIAN, 21Atf DOWNER'S GROVE, ILL.

MUTH'S HONEY EXTRACTOR PERFECTION Cold-Blast Smokers.

Square Glass Honey Jars, Etc.

For Circulars, apply to **CHAS. F. MUTH & SON**, Cor. Freeman & Central Aves., Cincinnati, O. Send 10c for Practical Hints to Bee-Keepers.

Beautiful Golden Queens From Kan.

Let me tell you why my Golden Italians are better for comb honey than the 3-banders. Simply this—they cap their honey white like the blacks, and are splendid workers.

- 1 Untested Queen, 75 cents or 3 for \$2.00
- 1 Tested Queen, \$1.00. Breeders 2.50
- 1 Breeder which I have bred from and found to be the best. 4.00
- 1 Frame Nuclei with Queen. 1.75
- 2 " " " 3.25
- 3 " " " 2.75

All orders filled promptly. Safe delivery guaranteed. **P. J. THOMAS**, 22A8t FREDONIA, KAN.

Mention the American Bee Journal.

Warranted Queens

BY RETURN MAIL,

Either Golden or Leather-Colored, at \$5.00 per doz. Choice Tested Queens at \$1.00 each. I guarantee safe delivery.

F. A. CROWELL, Grainger, Illin. 25A6t Mention the American Bee Journal.

Honey & Beeswax Market Quotations.

The following rules for grading honey were adopted by the North American Bee-Keepers' Association, and, so far as possible, quotations, are made according to these rules:

FANCY.—All sections to be well filled; combs straight, of even thickness, and firmly attached to all four sides; both wood and comb unsoiled by travel-stain, or otherwise; all the cells sealed except the row of cells next the wood.

No. 1.—All sections well filled, but combs uneven or crooked, detached at the bottom, or with but few cells unsealed; both wood and comb unsoiled by travel-stain or otherwise.

In addition to this the honey is to be classified according to color, using the terms white, amber and dark. That is, there will be "fancy white," "No. 1 dark," etc.

CHICAGO, ILL., June 20.—We quote: Fancy white, 14@15c.; No. 1, 12@13c.; fancy amber, 9@10c.; No. 1, 8@8½c.; fancy dark, 8@9c.; No. 1, 8c. Extracted, white, 5@7c.; amber, 4@5c.

Beeswax, 25@27c. It continues to sell well and there is no accumulation of shipments. We consider it a good time to sell.

R. A. B. & Co.

PHILADELPHIA, PA., Apr. 22.—We quote: No. 1 white, 9@10c.; fancy amber, 8@9c.; fancy dark, 7@8c. Extracted, white clover, 10c.; amber, 5@5½c.; dark, 4@4½c. Beeswax, 25@26c. Comb honey is dull. Extracted in fair demand. Beeswax lower. W. A. S.

BUFFALO, N. Y., Apr. 20.—We quote: Fancy white, 15@16c.; No. 1 white, 13@14c.; fancy dark, 8@9c.; No. 1 dark, 7@7½c. Beeswax, 25@28c. Trade very dull and honey not moving, except a few fancy lots; anything dark is hard to sell. B. & Co.

CINCINNATI, O., Apr. 22.—There is no fancy white comb honey on our market. Best white sells at 12@14c. in a jobbing way, with a fair demand. Demand is good for extracted at 4@7c., according to quality.

Beeswax is in good demand at 25@30c. for good to choice yellow. C. F. M. & S.

NEW YORK, N. Y., June 24.—No demand for comb honey of any kind. New crop of Southern extracted is arriving freely, and sells fairly good at 50@52c. per gallon for common, and 55@60c. per gallon for better grades. Beeswax dull at 26@27c.

KANSAS CITY, Mo., June 20.—We quote: No. 1 white comb, 1-lbs., 13@14c.; No. 2, 11@12c.; No. 1 amber, 11@12c.; No. 2, 8@10c. Extracted, white, 5½@6c.; amber, 5@5½c.; dark, 4@4½c.

Beeswax, 22@25c.

C. C. C. & Co.

List of Honey and Beeswax Dealers.

Most of whom Quote in this Journal.

Chicago, Ills.

R. A. BURNETT & Co., 163 South Water Street.

New York, N. Y.

HILDRETH BROS. & SEELKEN,
120 & 122 West Broadway.

CHAS. ISRAEL & BROS., 486 Canal St.

Kansas City, Mo.

O. C. CLEMOMS & Co., 423 Walnut St.

Buffalo, N. Y.

BATTERSON & Co., 167 & 169 Scott St.

Hamilton, Ills.

CHAS. DADANT & SON.

Philadelphia, Pa.

WM. A. SELSER, 10 Vine St.

Cincinnati, Ohio.

C. F. MUTH & SON, cor. Freeman & Central avs.

5 per ct. Off to Reduce Stock

on all kinds of SUPPLIES.

—COMB FOUNDATION—

which will be sold in lots of 10 lbs. or more as follows: Medium, 38 cts.; Light, 40 cts.; Thin Surplus, 45 cts.; Extra Thin, 50 cts.

Queens—Untested, 75c.; Tested, \$1.00.

W. J. FINCH, Jr., SPRINGFIELD ILLS.

VALUE RECEIVED

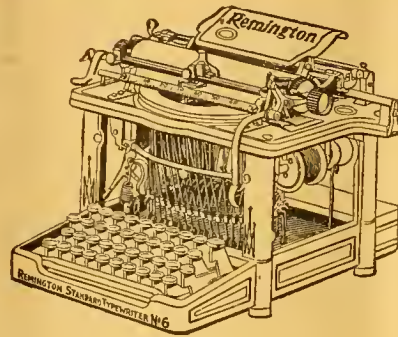

—EVERY TIME, SAY BUYERS OF THE—

NUMBER SIX MODEL REMINGTON

✳ STANDARD TYPEWRITER. ✳

Value in Work Done—in Time Saved—in Convenience.

Always Ready. In Service, Always Reliable

Send for Illustrated Booklets.

WYCKOFF, SEAMANS & BENEDICT,

169 La Salle Street,

CHICAGO, ILL.

Mention the American Bee Journal.

looking apary. My bees are not doing well now. In the spring they did well for a short time. One colony swarmed three times, two colonies swarmed twice each, and one colony swarmed once. They did all their swarming in April, beginning the 6th, and about the first of May the swarming impulse was cut short.

The prospect for honey is poor yet.

A. R. YANDELL.

Sullivan, Ark., June 14.

Doing Finely—Good Prospects.

Bees are doing finely. Prospects are good for a good honey crop.

I can't keep bees without the American Bee Journal. GEO. H. WEED.

Lanark, Ill., June 18.

Toothache Relief—Sticky Fly-Paper.

As bee-keepers are as apt to have toothache as any one else, I here want to say for their benefit that a little baking soda, or powdered alum, applied to the aching tooth will sometimes relieve the pain.

Some one has said that it was cruel to catch the flies on sticky paper, but when we can make it ourselves it is so cheap that we can afford to put up a new sheet every day, and burn it at night. Here is the way to make it:

Heat together ½ pint of honey and one pint of castor-oil; when hot, add 1½ pounds of resin. Stir till all is dissolved

and well mixed. Spread on paper. It will keep all summer. This recipe is not original, but I hope the author will forgive me for copying it, as I thought it was worth repeating.

To all appearance we shall not have much honey for market this year. There is any amount of clover bloom, but so much rain and cool weather that the bees have been unable to gather what the heavy rains did not wash out.

EDW. SMITH.

Carpenter, Ills., June 15.

Report from Florida—Good Yield.

I have plenty of honey on hand, but not much sale here for it. I have 90 colonies of Italian bees. From my best colony I have taken 63 pounds of extracted, and 16½ pounds of section honey, making in all 227 pounds from the one colony. JOHN L. NAIL.

Cocoa, Fla., June 15.

Swarming on White Clover.

Bees are swarming on white clover—I have not seen the like in eight years. I had the first swarm on June 15; on the 18th my scale hive gained 9½ pounds. I got a queen from an Ohio breeder last fall, and she is a dandy. Her bees are all yellow, and will swarm in a few days.

R. E. FORBES.

St. George, Vt., June 19.

Honey-Clovers & Buckwheat SEED FOR SALE.

We have made arrangements so that we can furnish seed of several of the Clovers and Japanese Buckwheat, by freight or express, at the following prices, cash with order:

	5lb	10lb	25lb	50lb
Alsike Clover	\$.70	\$1.25	\$3.00	\$ 5.75
Sweet Clover	\$.75	1.40	3.25	6.00
White Clover	1.25	2.00	4.50	8.00
Alfalfa Clover	.65	1.10	2.70	5.00
Crimson Clover	.55	.90	2.00	3.50
Jap. Buckwheat	.20	.35	.90	1.25

Prices subject to market changes.

Add 25 cents to your order, for cartage, if wanted by freight. Your orders are solicited.

GEORGE W. YORK & CO.,
CHICAGO, ILLS.

Sweet Clover ¹/_N Canada.

At the following prices:

5 lbs.	10 lbs.	25 lbs.	50 lbs.
\$1.00	\$1.60	\$3.75	\$7.25.

Also a quantity of Motherwort and Catnip seed. Prices on application.

EGGS for Hatching. Buff Leghorns, Indian Games, & Light Brahmans. Choice Birds. A breeder for 30 years. Prices on application

JOHN McARTHUR,
881 Yonge Street, TORONTO, ONT.
154t *Mention the American Bee Journal.*



Promptness Is What Counts!
Honey-Jars, Shipping-Cases, and everything that bee-keepers use. **Root's Goods at Root's Prices,** and the best shipping point in the country. Dealer in Honey and Beeswax. Catalogue Free.

Walter S. Ponder
162 Mass. Ave., INDIANAPOLIS, IND.

HONEY We have a large amount of Pure No. 1 Alfalfa we will sell cheap.

Wax Wanted.

Boss bee-escape Warranted the best, simplest and quickest Escape on the market. Sent postpaid to any address for 30 cts. It can be returned at our expense if it is not as represented, or we will send the Escape on trial to any bee-keeper wishing to test it in good faith. We are agents for the **Ferguson Patent Hive** with double-case Super and Wicket-Gate Honey-Board, with the Escape. It is the easiest, quickest hive to handle for the production of comb honey. Address,

E. S. LOVESY & CO.,
355 6th East St., SALT LAKE CITY, UTAH.
Mention the American Bee Journal. 9Atf

Queens! Queens!



Fine Untested Queens mailed promptly at 60 cts. each, or Six for \$3.30. Safe delivery and satisfaction guaranteed. Address,

F. GRABBE,
LIBERTYVILLE, Lake Co., ILL.
26Atf *Mention the American Bee Journal*

BEGINNERS.

Beginners should have a copy of the Amateur Bee-Keeper, a 70-page book by Prof. J. W. Rouse, Price 25 cents; if sent by mail, 28c. The little book and the Progressive Bee-Keeper (a live, progressive 28-page monthly journal) one year, 65c. Address any first-class dealer, or

LEAHY MFG. CO., Higginsville, Mo.

READERS Of this Journal who write to any of our advertisers, either in ordering, or asking about the Goods offered, will please state that they saw the Advertisement in this paper.

Question-Box.

In the multitude of counsellors there is safety.—Prov. 11-14.

Where Bees Tend Most to Store Honey.

Query 20.—The idea has been advanced, that the principle, "Bees tend to store honey above the brood," is erroneous, and that the correct principle is, "Bees tend to store honey away from the entrance." The reason assigned for the error is that we all use bottom entrances. What do you think of this? and why?—COLO.

G. M. Doolittle—I think it is mainly a fallacy.

Mrs. L. Harrison—I believe that bees tend to store honey above the brood is correct.

W. R. Graham—It is the bees' natural way of doing, to store their honey above the brood-nest.

W. G. Larrabee—I do not think bees will store honey below the brood, wherever the entrance is.

Rev. M. Mahin—I think bees tend to store above the brood regardless of the location of the entrance.

Dr. J. P. H. Brown—I take no stock in the "idea," and less in the "reason." I have disproved both by actual tests.

B. Taylor—I believe that the idea that bees are inclined to store honey as far as possible from the entrance, is correct.

Emerson T. Abbott—It has been my observation that the bees store the honey above the brood, let the entrance be where it may.

Allen Pringle—I think the natural and proper tendency of the bee is to store honey above and around, but not below, the brood.

E. France—If we use a deep hive, the honey will be stored above; in a very shallow hive the honey would be stored in the back end of the hive.

H. D. Cutting—My experience has been that bees will store honey above the brood whether the entrance is at the bottom or near the top.

P. H. Elwood—Bees prefer to store honey above the brood-nest, but when there is no room there, they prefer to store it away from the entrance.

J. M. Hambaugh—It may be that the entrance would have some influence as to how the bees store their surplus honey, yet the natural tendency is above the brood.

Prof. A. J. Cook—I feel very sure that the old idea is correct. In bee-trees I have seen cases where the opening was at the top, yet the honey was above the brood, as in a hive.

Chas. Dadant & Son—Bees usually live above the entrance. They want their honey above them so they can reach it in cold weather. But there are exceptions to all rules.

R. L. Taylor—I should be astonished to find a colony of bees storing honey below the brood from choice. Honey is better cured above, and is where the bees can best get it in cold weather.

G. W. Demaree—The natural tendency of the bee is to crawl upward. Try her on a window! But she will do the best

she can, and will fly from the top of her domicile when the habit is once formed. Bees are jealous and exclusive about their wealth, and will store their goods where there is the least danger from robbers. That is all I can see in it.

Dr. C. C. Miller—Both may be right. When I've had entrances at the top I think the bees still put honey in the upper part of the comb. Combs are perhaps stronger with the deeper cells for honey above.

C. H. Dibbern—I think the idea is wrong, and that above the brood is where the bees would naturally store surplus. I think the idea of having the hive-entrance at the top of the hive is wrong, too.

J. E. Pond—I can but follow my own observation and experiments. I am thereby taught that bees invariably store honey above the brood, and the natural laws governing the matter seem to point exactly in that direction.

James A. Stone—I think that bees try to get their work all as high up in the space allowed as they can, and they first protect their brood by placing it in the center, and then store the honey wherever they can, always keeping as near the brood as possible.

Eugene Secor—If the entrance were at the top there may be some truth in the new doctrine. Otherwise I think the prevailing opinion correct. It appears to be natural for them to begin to build comb where the heat of the cluster assists, and that is above the brood-nest.



BINGHAM SMOKERS
Best on Earth and Cheapest.
Doctor, 3 1/4-in. stove, by mail \$1.50; Conqueror, 3 in., \$1.10; Large, 2 1/2 \$1; Plain, 2, 70c; Little Wonder, 2, wt 10 oz. 60c
Bingham & Hetherington
Honey-Knives, 80 cents.
T. F. BINGHAM,
23Dtf *Farwell, Mich.*

1880 Special Offer. 1896

Warranted Queens, bred from best imported or home-bred Queens, at 60 cts. each; 1/2 doz., \$3.50. Untested, 55 cts.; 1/4 doz., \$3.15. Tested, 70 cts.; 1/2 doz., \$4.00. All Queens sent promptly by return mail.

LEININGER BROS.,
FT. JENNINGS, OHIO.
Mention the American Bee Journal.



Bee Supplies
Largest Stock and Greatest Variety in the West. **BEST** food at Low-EST prices, cat. of 50 pages FREE.

E. KRETZMER, RED OAK, IOWA.

Mention the American Bee Journal. 23D9t

HARDY—&—PROLIFIC QUEENS

Gray Carniolans or Golden Italians bred in separate apiaries—One Untested Queen, 65c.; six for \$3.50. Tested, \$1.25. Select Tested, \$2.25. Best Imported, \$4.00

Never saw foul brood or bee-paralysis. **SATISFACTION GUARANTEED.** Descriptive Price-List Free.

F. A. LOCKHART & CO.,
27Dtf **LAKE GEORGE, N. Y.**
Mention the American Bee Journal.

Bottom Prices

**BRING US BIG TRADE.
GOOD GOODS KEEP IT.**

If you want the best supplies that can be made at a little less cost than you can buy the same goods for elsewhere, write to us for low prices. 1896 Catalogue now ready—ask for it and a free copy of **The American Bee-Keeper** (36 pages).

Address,
**THE W. T. FALCONER MFG. CO.,
JAMESTOWN, N. Y.**
Mention the American Bee Journal.

COMB FOUNDATION!

Wax always wanted for Cash or in Exchange for Fdn. or other Supplies. My trade is established on **Low Prices** and the merit of my **Foundation**. Orders filled promptly. **WORKING WAX INTO FDN. BY THE LB. A SPECIALTY.** Wholesale prices to dealers and large consumers. Send for Prices and Samples to—**GUS DITTMER, AUGUSTA, WIS.** Reference—Augusta Bank. 1Atf
Mention the American Bee Journal.

EQUAL TO X RAYS. Our strain of Italian red clover blossoms. Choice Untested Queens, 70c; 3 for \$2—by return mail. A full line of **A I Root & Co.'s Goods** on hand. 36-page Catalogue Free. **JNO. NEBEL & SON, High Hill, Mo.**
Mention the American Bee Journal. 4A26t

I ARISE



TO SAY to the readers of the **BEE JOURNAL** that **DOOLITTLE**

has concluded to sell **BEES and QUEENS** in their season, during 1896, at the following prices:

- One Colony of Italians on 9 Gallup frames, in light shipping-box \$8 00
- Five Colonies..... 25 00
- Ten Colonies..... 45 00
- 1 untested queen. 1 00
- 6 " queens 5 50
- 12 " " 10 00
- 1 tested Queen... \$1 50
- 8 " Queens. 3 50
- 1 select tested queen 2 00
- 8 " Queens 4 00

Select tested queen, previous season's rearing . 4 00
Extra Selected for breeding, **THE VERY BEST**. 5 00
About a Pound of **BEES** in a Two-frame Nucleus, with any Queen, \$2.00 extra.

☞ Circular free, giving full particulars regarding the Bees and each class of Queens.
Address

G. M. DOOLITTLE,
12A25t **BORODINO, Onon. Co., N. Y.**
Mention the American Bee Journal.

BEES QUEENS

Smokers, Sections, Comb Foundation, And all Apisara Supplies cheap. Send for FREE catalogue. **E. T. FLANAGAN, Belleville, Ill.**

6A26t Please mention the Bee Journal.

PURE BARRED PLYMOUTH ROCK

Eggs, \$1.25 per 14. Our P. Rocks are very large, with fine plumage. Also,

BLACK MINORCA EGGS,

a non-sitting and great laying breed. Both kinds raised upon our farm. Minorca Cockerels, \$1.00 each. **MRS. L. C. AXTELL,** 16Atf **ROSEVILLE, Warren Co., ILL.**

Mention the American Bee Journal.

19th Year Dadant's Foundation 19th Year

It still in the lead, for we use all the latest improvements, including the

NEW WEED PROCESS,

and still make the best goods. Remember that we do not use any acid to purify our beeswax, and that is why our Foundation preserves the smell of the honey and is more acceptable to the bees, than any other. It is kept for sale by

T. H. Strickler, Solomon City, Kansas.
G. K. Hubbard, Fort Wayne, Ind.
I. Hanssen, Davenport, Iowa.
C. Theilmann, Theilmanton, Minn.
E. C. Eaglesfield, Berlin, Wis.
E. T. Abbott, St. Joseph, Mo.
J. M. Jenkins, Wetumpka, Alabama
John Key, East Saginaw, Mich.
Vickery Bros., Evansville, Ind.

The Jennie Atchley Company, Beeville, Texas.
C. F. Muth & Son, Cincinnati, Ohio
E. Kretzmer, Red Oak, Iowa.
G. B. Lewis Co., Watertown, Wis.
James Reynolds Elevator Co., Poughkeepsie, N. Y.
Louisiana Bee-Keepers' Supply Manufactory, Donaldsonville, La.
Paez & Lynn, New London, Wis.
John Nebel & Son, High Hill, Mo.

and many other Dealers. All agree in saying that no goods are better than ours.

Those of our customers who formerly bought through Thos. G. Newman can get our Foundation in **Chicago, Ill.**, by addressing us at **118 Michigan Street**. We keep no other goods there.

We make a specialty of **Veils and Veil Stuffs** of best quality, cotton and silk.

"LANGSTROTH ON THE HONEY-BEE"—Revised.

Bee-Keepers' Supplies, Smokers, Sections, Tin Pails, etc. **Samples of Foundation and Tulle FREE** with Circular. Instructions to beginners with Circular. Send us your address.

CHAS. DADANT & SON,

Mention the American Bee Journal.

HAMILTON, Hancock Co., ILL.

Williams' Automatic Reversible Honey-Extractor.

Has no sprocket gear or chain at bottom of reel to get daubed with honey and corrode and break it. The reversing arrangement of the Williams' is at the top of the comb-baskets. "The best extractor on the market"—so says the veteran bee-keeper, Mr. N. E. France, of Platteville, Wis.

ITALIAN BEES.

Bright Yellow or Leather-Colored. Queens of either strain—Untested, 60 cents each; two, \$1.00. Select, 75c. Tested, \$1.00. Full Colonies cheap. No foul brood or parapalysis. Remit by Express Money Order, payable at Barnum, Wis. Many customers send \$1.00 and \$2.00 bills, which are very convenient. Stamps taken for less than \$1.00. **Price-List Free.**

26Atf

VAN ALLEN & WILLIAMS, BARNUM, WIS.

Please mention the American Bee Journal.

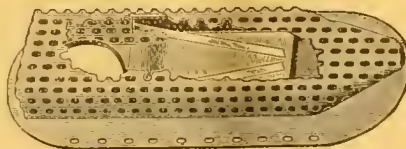

Porter Honey-House Bee-Escape

Have you seen it? Just the thing to put on the doors or windows of your bee-rooms. Indispensable, you'll say after you have tried it.

Cornell Bee-Smokers.

Cheap, strong, serviceable. We have sold a good many of these, and so far there has been no complaint; but, on the other hand, there have been scores of letters in their praise. Price, 85 cts. Prepaid, \$1.10.



COWAN.

Cowan and Novice Extractors.

These are the best. We are prepared to furnish, on short notice, from any of our several Branches, 2, 4, and 6 frame Cowans and 2-frame Novices. If you want the genuine, see that they

bear our name.

A 36-page Catalog sent Free on Application.

THE A. I. ROOT CO., MEDINA, OHIO.

BRANCH OFFICES AT:

118 Michigan St., Chicago, Ill.

Syracuse, N. Y.

1024 Mississippi St., St. Paul, Minn.

Mechanic's Falls, Maine.

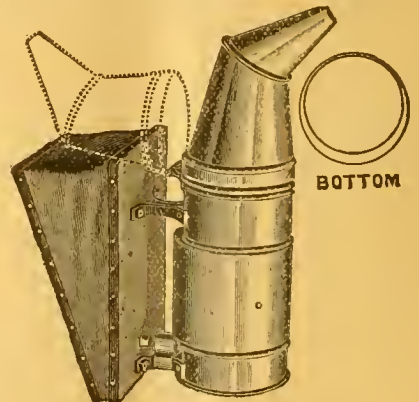

BOTTOM

AMERICAN BEE JOURNAL

DEVOTED EXCLUSIVELY TO THE INTERESTS OF HONEY PRODUCERS

ESTABLISHED IN 1861
THE OLDEST BEE-PAPER IN AMERICA

Published Weekly, at \$1.00 per annum.

Sample Copy sent on Application.

36th Year.

CHICAGO, ILL., JULY 9, 1896.

No. 28.

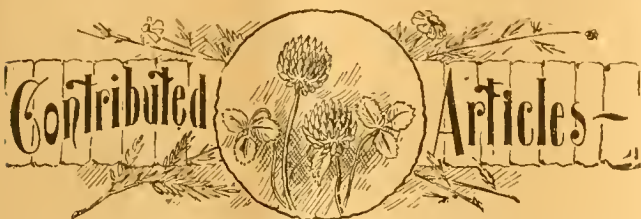

The Prevention of Swarming—Questions.

[We received the following letter from Dr. Miller, in which he asks "The Dadants" some questions. Upon its receipt, we forwarded the letter, and, in due time, there came back with it a reply from both Mr. Chas. Dadant and his son, C. P. The Doctor's letter and the two answers are as follows:—Ed.]

MESSEURS. DADANT & SON:—You have done what you could to embitter my life by keeping bees that would not swarm, or by keeping hives from which bees would not swarm. At any rate, you report only from three to five colonies out of a hundred as swarming, and you attribute it chiefly to the large amount of room you give your colonies. This year I gave to most of my colonies 16 Langstroth combs, making, I think, about one-third more capacity than you give to your colonies. Most of them were reduced to one story with eight frames at the time of putting on supers, but before being so reduced a number of them made ready for swarming, and of those left on 16 frames the large majority decided to swarm.

It might be said that being in two stories the bees did not work in both, but that is a mistake, there was brood in both stories, and the queen went freely from one story to another. Now, why do my bees deport themselves so differently from yours? Is it "locality," or is there something in the shape of the hive? Is it some witchcraft you brought over from France? If the latter, will you teach me the secret if I come down to your place?

Enviously yours,

C. C. MILLER.

CHAS. DADANT'S ANSWER TO DR. MILLER.

There is nothing in discordance with what we hold to be the habits of the bees, in the above facts as described by Dr. Miller. The frames of our large hives have about 100,000 cells; those of the 8-frame Langstroth about 60,000, or two together about 120,000, but as soon as the crop begins we add one super containing about 50,000 cells, and when this is a little over half full we add a second one, if the season is favorable, thus raising the capacity of the hive to 200,000 cells.

The difference in the quantity of swarms is not due only to those successive enlargements of the hive. A colony, in a state of nature, always builds its combs from the top down, and continues them downward without interruption, without leaving any space open. The queen may thus run over them without obstacles or irregularities. It is not thus with a double-story hive, and for that reason the queen always hesi-

tates more or less either to go up into the upper tier or down again in the lower. The upper combs are separated from the lower, by the top-bar of the lower combs, the empty space, and the bottom-bar of the upper combs. This space compels her to hunt around in the dark, in a way which is not according to her instinct.

In a large, single-story hive the case is different. She finds in the brood-chamber the entire space that she needs.

In our apiary of about 80 colonies, here at home, we have had but two swarms this season. We should gladly welcome Dr. Miller, and show him how our bees behave with our methods.

In a criticism on page 391, Mr. Doolittle, speaking of large hives, writes that it is useless to have hives full of brood and bees in the month of March, for it would be as if one hoed the potatoes before they were up. We do not know where Mr. Doolittle has seen hives full of brood and bees in March, probably not in our latitude, which is about the same as his.

It is just the other way. In either large or small hives, one usually does not get brood and bees as early as one would wish. Every season we try to induce our bees to breed early, by giving them flour before the pollen comes.

I would add that I should be very glad to find a way to get still stronger colonies than we usually have in April, for there is a great deal of fruit-bloom every year, and at that time there are but few colonies, even in large hives, that are sufficiently strong to harvest more than is necessary to breed from.

CHAS. DADANT.

C. P. DADANT'S ANSWER.

Dr. Miller is either trying to poke fun at us, or he is wanting to bring us out with our hobbies. I rather think the latter is the case. Although Dr. M.'s motto is "I don't know," we suspect him of knowing a great deal more than he lets on, and we think that he is not nearly so ignorant as he would let us believe. Well, Doctor, we will take you as if in dead earnest, and will "talk back."

Right here, in the home apiary, we have about 80 colonies just now. We have had two swarms, and think we have lost another. Mr. Dadant, senior, has had the task of watching the bees, and he seems to think that he is wasting his time.

Here are two colonies side by side, both apparently very strong. We opened their hives about a week ago, and found one of them with about five extracting-frames full of honey, the center ones partly sealed, but the other nine frames nearly dry. The supers are of the American size, and hold 14 half-frames. The colony is evidently expecting to fill the entire width by and by, but their restricting themselves to a certain number of combs shows that they do not feel crowded, and are comfortable. There are no idle bees on the outside.

The other hive has a large cluster hanging on the outside

(elles font la barbe), literal translation, "they make a beard"—a very explicit way of putting it, if it is French. An examination of the inside reveals less honey than the other colony, but that honey is scattered all through the super from one end to the other, and not a single cell sealed. Why, then, do they hang out, since they have room to spare, their super having really less honey than that of the other colony? My dear, sir, it is very plain—they are crowded. Their hive, although very large, and their large super, are both inadequate, or perhaps they suffer more from the heat, owing to being more exposed to the sun. At any rate they cannot all stay inside. We will try one remedy first. We take one of the entrance-blocks, and raise the hive from its bottom, in front, placing the block under the edge of the hive. This gives them a good chance to ventilate the entire hive from several sides. No tight bottoms with us, you understand.

Two days after we examine again. That hive still has a number of bees on the outside, while the other has not an idle worker. It won't do to let it "make the beard" so long, and we will add another super. Raising the first one, we find that there are only about 15 pounds of honey in it, and that they have made but little headway. We now have two supers, or room for 120 pounds on this hive. This morning we examined it. They have honey in both supers, and, I am glad to say, not a bee is idle—no more barber needed. I have not the shadow of a doubt that you will agree with me when I say that this colony would have been very likely to swarm had we not done as we did. You will also agree that, if it does swarm, there will be nothing astonishing about it, because, as we all know, when they once have the swarming-fever there is no cure except by swarming.

Dr. Miller tells us that he put a number of colonies on 16 frames, that is, two 8-frame brood-nests, and that a number of them made ready for swarming. We would have to know just when those additional hives were put on to have an opportunity of ascertaining what is the probable trouble. From what the Doctor says, they must have laid eggs and reared brood quite plentifully in those two stories, and the colonies must have been about one-half more populous than those on eight frames. They must have needed, then, nearly twice as much surplus room as the others, and yet with the floor space of an 8-frame hive there is only room for 24 sections in one tier. It is true that you can pile several stories on top of each other, but this is not usually done. How many did you put on? Then the ventilation is much more difficult.

I remember some 25 years ago when we were still using the little square 6-pound honey-box, with glass on four sides, and an inch hole at the bottom, I often wondered why the bees remained idle on the outside and not a bee would go into those boxes. It was the heat and the lack of ventilation that hindered them. We had a very good chance of making sure of this when we began using the section honey-box, thanks to D. L. Adair, of Kentucky. His section-box was too large, but it was a great improvement on the glass box, for the bees had much better access to it.

Doctor, put the supers on, but put on enough to give them a good chance. The great trouble in producing comb honey is, that you do not wish to put on so many that they may leave a lot of them unsealed, and it is a much finer task to judge of the proper space to give than when you expect to extract it, for in the latter case it does not matter a particle whether the honey is sealed or not, so it has been well ripened.

But I wish to say much more on this subject, and will ask leave to put off the balance till another day.

Hamilton, Ill., June 24.

C. P. DADANT.



Every Present Subscriber of the Bee Journal should be an agent for it, and get all others possible to subscribe for it.

Value of Bees to Apricot Growers.

BY DR. E. GALLUP.

This season has been a very peculiar one for California. Our apricots usually bear full crops every other year, and this should have been the bearing year, but owing to the unusual cool, dry weather while they were in bloom, the crop is extremely light in many places, and in some localities almost a failure. Now this could have been remedied. How? Why, by having bees to fertilize the bloom.

This article is suggested by the complaint of a friend. He had a large colony of bees take possession of the roof of his tank-house some time in April, and now he is in a sweat as to how to get rid of them, as he says they are a terrible nuisance on the apricots while drying, etc. That they do work on apricots while drying, especially over-ripe ones, is a fact which I am not going to deny. Now, this friend has a very light crop of apricots, and is very anxious to make the most of them, and I want to whisper in his ear a trifle:

Friend S., providing you had four or six colonies of bees to fertilize your apricots while in bloom, you would have had a heavy crop, and knowing that the bees were the cause of the heavy crop, could you have begrudged them the small quantity of juice they would have taken while they were drying? You discover the bees on the drying-trays, and do you not *imagine* that they are doing a great sight more harm than they really are? You are a pretty close observer in most cases, please look into this matter thoroughly.

Now for facts: At the time the trees were in bloom, it was so cool that bees could fly but a short distance from their hives, and only a few hours in the day. I notice some 20 trees on First street literally loaded with nice fruit, while a short distance from them the trees are almost bare of fruit. There is a cause for this, and *what* is that cause? Why, there are two large colonies of bees in the cornice of a house adjoining the lots where those trees are.

I met a friend three days ago; he was making preparations for apricot drying. "Well, how is your crop?" I asked.

"I never had a heavier crop, or a finer one, and as my neighbors have only very light crops, and some of them almost none at all, I expect to get a good price for mine."

So you see this friend was in extra-good spirits. Why does he have such a fine crop? There must be a cause, and *what is it?* Why, a widow has some eight colonies of bees in box-hives just across the street, only a few rods from friend H.'s apricot trees. Now, in all probability this same man will find fault with the widow's bees for taking a trifle of the juice while his fruit is drying!

Let the bees have a trifle for their labor. The laborer is worth of his hire; muzzle not the ox that treadeth out the corn.



Fifteen Years' Experience in Bee-Keeping.

BY MRS. SALLIE E. SHERMAN.

(Continued from page 418.)

I was the first person in this part of Texas, so far as I know, who had sent for and Italianized their bees, and had them in movable-frame hives, with section-honey for sale. It attracted a great deal of attention, and many thought if I could make such (to them) wonderful success, that they, too, could do likewise. Many came to see me and to talk bees, for miles around. Some of them bought bees of me, paying me \$12.50 per colony, and had me order hives, smokers, vells, etc., for them. There were, however, only a few of them that made a paying business of bee-keeping. It, as you know, is a business requiring close attention to minor details,

which a great many people are not willing to give, hence their failure.

My son and I did quite a good deal of transferring bees from box to movable-frame hives. In many directions for miles around we had calls for this kind of work. I remember on one occasion a man happened in while we were in the midst of transferring. Of course, before beginning we had drummed on the hive and frightened the bees until they had filled themselves with honey, so of course they were very docile, and almost as easily handled as flies on a cold morning would have been. He looked on in mute astonishment, and wanted to know if we hadn't mesmerized them? When we told him no, he was a "doubting Thomas," and did not believe us. He went off and told that we couldn't fool him that way, for, said he, "They either gave them something to stupefy them, or else they conjured them." Whatever the "conjuring" meant, I am sure I don't know, for I had never heard it used except by negroes.

As the years rolled past, I was all the time reading and studying everything I could get my hands on that treated upon the subject of bee-culture. I subscribed for the Bee-Keepers' Magazine, and eagerly devoured its contents; but it did not satisfy me. Its visits were too far apart. I then took the American Bee Journal and the Apiculturist; got "Bees and Honey," by Thomas G. Newman, and "A Year Among the Bees," by Dr. Miller; "Bee-Keepers' Guide," by Prof. Cook; Alley's "Handy-Book, or 30 Years Among the Bees;" "Blessed Bees," by John Allen; Gleanings in Bee-Culture, and "A B C of Bee-Culture," by A. I. Root; Dr. Phin's "Dictionary of Apicultural Terms," etc. I hardly know all that I have read, for when I would get through a book there was almost always some one who wanted it; I would let them have it, and buy another from a different author. By this means I read more than perhaps I otherwise would have done. I have but few standard works on hand at this time, for reasons above mentioned, but I have a good-sized trunk full of journals.

I finally decided that I could get more honey and manage it more easily by running more for extracted and less for comb honey, so I sent a special order for 20 top stories for the American hives, to run for extracted instead of comb honey. I had them made the same as bottom stories, with the exception of a bee-entrance which was not cut out. These I set on top, after having filled them with heavy comb foundation. Thus, the frames were interchangeable, which I found to be very convenient.

A little later on I ordered 100 Eclectic hives, 50 of which I used for extracted honey, and the others were ordered for a gentleman in an adjoining county. He, too, was very enthusiastic on the subject of bee-keeping. He said before he got bees and used so much honey that he always had from \$50 to \$100 doctor's bills to pay each year; afterwards none at all, until his family took the measles; they then lost one son. Both he and his wife told me about how very badly she once had erysipelas, which extended half around her body, several inches wide, from which she had been suffering the most excruciating pain for several days and nights without obtaining relief, notwithstanding there were several physicians attending her. Finally, her husband asked the physicians if they had any objection to his making and applying a plaster composed of honey and flour. They replied no; that if it did no good it certainly would do no harm. They assured me that in less than 15 minutes after it was applied she was perfectly easy, and dropped off to sleep, and in three days it was healed over so that she could dress herself and get around the house. I relate this, thinking it might be of use to some suffering human being. It is certainly worth remembering, and given a trial in case one is similarly afflicted.

I have received orders and shipped bees hundreds of miles in various directions over the State—I mean full colonies. I

quote a few lines from Mr. Wm. Little (now deceased), formerly of Hutchins, Dallas county, Tex., dated July 4, 1884:

"DEAR MRS. SHERMAN:—I am glad to report to you that the bees, etc., you shipped me arrived in good condition. You certainly did a most excellent job in packing, etc., and I believe they would have gone across the continent by rail in good order and condition. You fixed them up so nicely and well. I am delighted with them, and they are doing splendid work. I prepared and set the bees in a good place, made good shade over them, and they went to work at once, and seem to increase in numbers and working force every day.

"WM. LITTLE."

I always guaranteed safe arrival and full satisfaction in every case. I never had a customer that I failed to satisfy.

I learned a great deal from my observatory hive, which I kept all through the working season with one frame of bees, brood, etc., in my gallery, where I could see and study the inside workings of a full colony, so to speak, at any and every leisure moment I had. I took great pleasure in showing it to my friends when they visited me. I also had it on exhibition at our county fairs, and at many farmers' institutes, which I attended. In this way I have shown queens to thousands of people, many of whom had never seen one before. I was asked on one occasion to show a lady the "queen's throne." Speaking of this reminds me of an incident that occurred at Chicago, while attending the World's Fair and bee-keepers' convention. Never having had the pleasure of meeting Mr. G. M. Doolittle, and on being shown his bees that were on exhibition, I asked for and obtained permission to get up on the platform so I could see them better. I watched my opportunity and caught a drone, and then a worker-bee; then in company with a bee-keeper from Colorado, we went walking around on a tour of inspection amongst the many bee-fixtures there on exhibition. Presently we met a large Pennsylvanian, who began talking bees; noticing the drone I held by one wing, he said:

"Them's the kind of bees we have down in our State, and I'll tell you they haint made no honey there in several years."

I asked him if he wasn't mistaken in the kind of bees.

"No," said he, "them's the kind, shore."

The bee-keeper and I laughed, and told him that that was a drone.

"I don't care if it is, them's the kind we've got down there, shore, and they haint made no honey to amount to anything in three or four years."

We told him that we were not surprised at all at their failure, if that was the kind they depended on for gathering and storing the honey.

I killed the worker-bee as soon as I caught it, but still had it in my hand, and showed it to him, and told him that that was the kind of bee that stored honey in Texas.

"Why," said he, "that is nothing but a gad-fly!"

I finally killed the drone and wrapped the two together in a little piece of paper, and brought them home with me. In looking over some papers, etc., a few weeks ago, I came across them, or rather I opened the paper in which they were, and found the dried shells or skins and half a dozen very queer-looking, lively little insects, different from anything I had ever seen, which I suppose had devoured the bees.

Bell County, Tex.

[To be continued.]



Alfalfa—Cleome—Sweet Clover—Something About Honey-Flows.

BY R. C. AIKIN.

Alfalfa is thought by many to be a sure yielder. Even some of the writers from the alfalfa districts have been guilty of giving the impression that it yields the whole summer through. I have before this told the public, through the api-

cultural press, that the alfalfa honey-flow was not one long-drawn-out, all-summer flow. I have now been six years in a region where the plant is grown very extensively, and I must say that I find it about as some other plants in regard to reliability.

The season of 1890 the flow was very rapid at first, and continued for about 50 days. In 1891 it was not so rapid, but continued about the same time. In 1892, if it had not been for red clover we would have been almost without surplus. In 1893 it was about like 1892, the flow lasting only about two weeks, and mostly from red clover. In 1894 alfalfa again yielded fairly well, giving us about 40 or 50 pounds in a two or three weeks' flow. But 1895 was the poorest in many years, though the bloom was fine, and I thought promised the best in the six years. Thus, alfalfa has practically failed to give a surplus three years out of six.

I consider alfalfa a fine honey-plant, and the honey of a quality that is hard to excel. I believe, too, that under irrigation any plant will be a little more certain to yield some nectar, though the alfalfa is subject to the same influence (whatever it is) that keeps other plants from secreting nectar.

That long-drawn-out bloom is to some extent a myth. In this part of the country it begins to bloom about June 15 to 20, and, if left to grow on at will, continues to put forth fresh bloom for six or eight weeks, then gradually ceases, unless, like any of the clovers, it takes a second growth. This second growth will bloom quite profusely, but I have never known it to yield much. Just like red clover, it will grow a second crop when the first has been cut for hay, but I have not found this to yield much.

Alfalfa grows more rapid, larger, and more woody than the red clover, being practically between the red and sweet clovers, and the farmers aim to cut it just as it begins to bloom. I have seen many hundred acres just beginning to get nicely into bloom, and the bees just getting started on it, when down would go the whole for hay. Happy is the apiarist who lives where alfalfa seed is grown, or where the farmers are behind with their work. Ditch-banks, fence-rows, roadsides, and nooks and corners are frequently a good share of our dependence for pasture. Last year was wet for this country, and many farmers were behind with their work, letting much of the first crop get into full bloom, yet with all the fine outlook the flowers would not "give down." Many said it was too wet, but I have seen good flows from heart's-ease with much more rain. Yes, and from white clover, too.

The much-famed Rocky Mountain bee-plant (cleome) is tricky, too, and no more to be depended upon than the others. I do not know what sweet clover will do. The poor plant has a hard time of it. It tries hard to live, and succeeds to some extent, but the farmers fight it as the worst of weeds. Few localities have enough left to give it a fair test. I think both sweet clover and cleome are good, and would help out most likely when the other sources fail.

I have for years eagerly read what has appeared in the journals on the subject of planting for honey. At this date I am of the opinion that one may plant, with profit, if the crop be of value for other purposes; but to plant for honey alone, or to plant out of season to lengthen the flow, I have very little hopes of success. My observation is that in good years plants will yield some out of season; but when we get but little *in season*, the out-of-season bloom gives nothing. By in and out of season I mean the regular or natural time for a particular plant—or by late sowing, etc., to get it to bloom at some other season.

We discuss the whys and wherefores of these matters, and offer wise counsel; but, after all, what can we do? The Power that made all these wonderful things in Nature can and does manipulate them as He pleases. Scientific research to find out the methods in Nature by which these things are ac-

complished is interesting, and may be rightly used; but if we knew all the details of His methods it is not in the least probable that we could avert the disaster that overtakes us. Does not all sacred and profane history teach us that if we live and do as becometh brethren, then our land bringeth forth in plenty; but when greed and gain are the prevailing motives we are brought into straits, and immediately begin to look elsewhere than to our own selves for the cause?

Loveland, Colo.



Feeding Back—What Becomes of the Feed?

BY HON. R. L. TAYLOR,

Superintendent of the Michigan Experiment Apiary.

Feeding bees for profit, *i. e.*, feeding back honey which has been extracted, for the purpose of producing comb honey, which is a more valuable article, is a very complicated matter, if the probability or degree of profit to be derived therefrom is alone considered. So many items which are unknown qualities enter into the problem that it is not to be wondered at that some even of the most skillful apiarists have been unable to realize a financial success. But others have been entirely successful, and it is hardly necessary to say that a negative result has comparatively little weight when confronted with a case of actual success, for if all the circumstances existing in the latter case had had place in the former the result must have been alike successful. Failure where there has been success proves that the only requisite to general success is the discovery and application of the appropriate conditions.

While the exact extent of the bearing of these several conditions is to a considerable degree uncertain, their tendency is in most cases tolerably well understood, though there is a difficulty still in some particulars in determining whether they are the best possible or not; as, for instance, the characteristics of the bees of a particular colony which is to be made use of in respect to persistent energy, comb-building, etc. These and some other points cannot always be infallibly determined without an actual practical test.

Among the more important points to be considered in order to induce the most favorable conditions are the following:

1. The character of the bees to be employed. There is a wonderful variety in the character of the bees in the different colonies even in the same apiary and of the same race. This difference shows itself in many ways, especially in the degree of excitability, in smoothness of combs built, in the whiteness of the cappings of comb honey, in energy and activity, and in the disposition to cling to the brood-chamber, to crowd it with honey, and when that affords no more room, to cease labor rather than to overcome the disinclination to pass beyond the limits of the brood-nest into a surplus apartment above. In selecting bees to be employed for feeding back, no point is more important than that those should be chosen that enter willingly upon work in the supers. The Italian race is very defective in this respect, while the black or German race or crosses in which black blood predominates are superior, though even among these judicious selections may be made with great advantage.

2. The character of the queen. The pertinent point here is that the queen should be prolific, not that prolificness is specially necessary after the feeding has begun, but unless she is so the colony will not have the numerical strength desirable, and the existing brood will not be great enough in amount to furnish the required reinforcements as the work progresses and the older bees perish.

3. The season. That must be early—the earlier the better after the advent of summer weather. In selecting this time we gain in two ways; first, we avoid as far as possible the disposition of the bees to store honey in the brood-chamber, a disposition which ever increases as the season wanes, and, second, we secure the great advantage of having the work done during the hottest weather during which alone bees produce wax and build comb most economically. Of course, the work must not be undertaken while honey is being gathered from the fields. The opportune time is the interim between the early summer and the late honey season which begins generally about the 20th of July at the failure of the basswood bloom.

4. The size and condition of the brood-chamber. For obvious reasons this should be small, because, otherwise, an opportunity is furnished for the production of a large amount of brood whose value beyond a certain limit cannot be great, and whose production must cost the consumption of an indefi-

nately large amount of the honey fed, and also because, otherwise, room is given for the storage of a large amount of honey where it is of less value than it was before it was fed. The capacity of five Langstroth frames is about right, or of one section of the Heddon hive, and this latter is better because this hive is so shallow that that amount of comb occupies a space equal horizontally to that occupied by the sections in a section-case, so that the heat and odor rise equally from the brood-chamber to all parts of the section-case. This is an advantage, especially if there should be cool weather before the feeding is finished. The combs used should be such as are filled with brood so far as possible, and the residue with honey, thus the bees are prevented as far as possible from using or storing the honey so as to entail a loss.

5. The condition of the sections to be filled should be considered. The farther the comb in them is worked out, the more honey they contain when they are given to the bees to be completed, the greater will be the relative profit. On the other hand, the less they contain, and the less work done upon them, the less the profit, if, indeed, it does not pass the vanishing point. The liberal feeding contemplated will turn a great army of quiet bees into active laborers, and will induce the rearing of increased amounts of brood, and growing brood and active laborers require a large amount of food—we don't know how large, but probably more than one could guess, so the economy is seen of aiding the bees so far as we can by giving them the best possible comb to fill, as in other ways, so that the work they have to do may be finished at the earliest possible moment, that the wages they exact in the shape of food may be stopped. The matter of the amount of honey required for food while the bees are in a state of activity, and for the production of the wax needed to carry the work to completion is one of very great importance, as may be seen from the details of the results of an experiment which are given in the accompanying table.

	Weight Aug. 10, in lbs. and ozs.	Weight Sept. 15, in lbs. and ozs.	Weight Nov. 26, in lbs. and ozs.	Total amount fed in lbs. and ozs.	Dry sugar repre- sented.	Comb honey pro- duced.	Gain in weight of brood-chamber.	Amt. consumed.
No. 1	51-8	73-12	97-12	213-4	122-2	46-7	22	53-13
No. 2	57-8	83-4	67-12	137-8	75-3	41-6	25	11-6
No. 3	55	84	74	127-8	73	24-5	27	19-11

The experiment referred to was made for several purposes; one of which was to show the results that may be expected to follow a disregard of some of the principles stated in the foregoing. Not having a supply of honey for the purpose, I used granulated sugar, which was made into a syrup by boiling a certain amount of water and adding an equal quantity of sugar by weight. In the process of preparation there was an evaporation such that the weight put in was 14.65 per cent. greater on the average than that taken off.

The feeding was begun the 10th of August last, and required four and a half weeks for its completion. The three colonies employed were dark hybrids of more than the average strength of the apiary. Each colony had a brood-chamber consisting of a two-section Heddon hive with a fair amount of brood for that season in a year of great dearth of bee-pasturage. The sections to be filled were all furnished with foundation only, and one case was given to one of the colonies, and two to each of the others. The feed was supplied to the bees in pans placed above the sections, and was given as rapidly as it could be taken. The greatest care was taken in keeping a record of the amount fed, the amount given each time being weighed separately. During the greater part of the time when feeding was going on, there was a moderate amount of honey being gathered, sufficient, however, to supply most of the apiary with abundant winter stores, notwithstanding previously the danger that most of the colonies would have to be fed for winter seemed imminent, and many stored a considerable surplus in empty combs. It cannot of course be determined how much honey the colonies under consideration gathered. Probably not nearly so much so as they would have done had they not been receiving feed, and judging from the results, one of the three gathered much less than either of the others. If this was so, it resulted from the difference in the characteristics of the bees of the different colonies. All three certainly brought in large quantities of pollen.

It will be noticed that in the table the weight of each brood-chamber before and after the feeding is given, and to

that is added the weight of each at the time of putting them into winter quarters. In the next column appears the weight of the liquid food given each, and that is followed by figures showing the amount of dry sugar that went to make up the syrup; then after the weight of the honey produced and the gain in the weight of the brood-chamber, comes, last of all, the amount of sugar which has disappeared entirely, and this upon the assumption which is a somewhat violent one, that one pound of dry sugar made but one pound of ripened syrup. But if we assume that a pound of sugar made $1\frac{1}{2}$ pounds of sugar-honey, the figures showing the amounts consumed would be greatly changed, and, disregarding fractions, we find No. 1 consumed 84 pounds, No. 2, 31 pounds, and No. 3, 38 pounds.

The question—What has become of these large amounts?—is a puzzling one, but our ability to answer it at least sufficiently to enable us in practice to greatly reduce them is the point upon which the answer to the question—Can feeding back be made profitable?—must turn. As bees have never been suspected of casting good syrup out of the hive we may assume that it was all used legitimately in carrying on the work of the hive, but for different purposes, as it answers for food, fuel, and building-material. It would be rash for one to undertake to say for which of these purposes the greatest amount was used, but probably if the facts could be got at it would be that for food, if we include under that head all that is used for the nourishment of the brood as well as that portion of the honey consumed by the mature bees, and needed to make, with the pollen consumed, a balanced ration. This disposition of the matter would leave the honey or syrup consumed by the bees more than that to be divided and ascribed to the other two purposes, that of creating heat and that of producing wax.

The only point that remains to be noticed in this matter is the method by which the expenditure of material for any of the purposes above defined may be curtailed.

The expenditure for food pure and simple could be judiciously decreased to any great extent. That of the mature bees could not be decreased to any great extent. That of the mature bees could not be decreased at all (if the work were done at that season for the same length of time), and that of the brood only to the extent the brood itself might be safely decreased. As bees at the season mentioned are seldom inclined to rear much more brood than is necessary to bring the colony through in good condition to the next spring, not very much could have been saved here in this case, but all that could have been done in this direction would have been accomplished without danger of curtailing the brood too much by allowing each colony a brood-chamber of a single section instead of two. Earlier in the season when bees are inclined to give more attention to the rearing of brood, such cutting down of the brood-chamber would without question effect a large saving in the expenditure of food. The contraction of the brood-chamber would prove very effective in other ways, especially in the saving of honey as fuel, as the size of the space to be warmed would be greatly lessened, and a much greater percentage of bees would be forced into the surplus-cases where heat is especially needed while the working of wax is going on; and, too, the amount of the food given stored in the brood-chamber would be cut down about one-half. (See account of my feeding back experiment made in 1893.)

Again, the choosing of the season from the middle of July to the middle of August would be an advantage in all ways, for the heat of the sun would serve largely to keep up the temperature which must otherwise be maintained by the consumption of fuel, the amount of food would also be decreased to some extent, and, as comb is made thinner, and so goes farther in hot than in cool weather, a substantial economy in the saving of building-material would result.

I shall only continue this to mention one other point already referred to, which is hardly excelled by any in importance as an element in securing the highest success, viz.: the providing the bees with sections containing comb well worked out and partly filled with honey, such as are usually plentiful at the close of the early honey harvest, instead of empty sections. This is an advantage in many ways. The combs are in condition for the process of filling to proceed at once, and comparatively little wax needs to be produced, so that the work is greatly hastened, and the consumption of honey saved in every direction. The honey, also, in such sections, which is unsalable in that condition, is doubled in value by the completion of the sections; indeed, without the motive of bringing such sections to a salable condition, feeding-back should seldom be undertaken.—Review. Lapeer, Mich.



Specialty in Country Life Considered.

BY F. L. THOMPSON.

On page 97, Mr. Abbott, in commenting on my statement that general farming, as it actually exists, stultifies the mind, says, "It is no more degrading to milk a cow," etc. I did not say it was. Nor was the faintest intimation of such an idea intended in that article or in my thoughts. "Stultify" and "drudge" do not imply moral debasement.

"If farm life is so stultifying to man's intellectual life, why is it that some of our best and ablest men come from the farm?" To get away from it, of course. That is where they show their sense. They want specialty.

"There is an intelligent way to milk a cow, clean a stable," etc. Agreed; but when such work continues all day and every day, the mental part of the labor becomes infinitesimal. Result: Mental starvation, none the less real because often unconscious.

"I find recreation in all of these things, and education, too." One might wonder why Mr. Abbott is not farming. There is nutriment in a lump of dirt, but we do not choose to eat clay on that account.

"If it were not for them, I should soon have to cease all intellectual work." I am not talking about recreation, or the daily constitutional, but about business. Earnestness and enthusiasm in the distraction of half-a-dozen equal occupations cannot be attained in nearly the same degree as in one. *Subordinated* variety is the spice of life.

"No necessary work is drudgery unless we make it so." I have also heard it said, "Be virtuous and you will be happy." I don't deny it. All that the quotation from Mrs. Garfield amounts to is this: When there is an "inevitable necessity" there is room for any amount of sermonizing. But when there is not an inevitable necessity there is a choice, and that choice is governed by principles.

"The most disagreeable work may become a certain source of enjoyment, if looked at in the right light." Just my sentiments, and the "right light" is furnished by specialty. The sense of fresh development, the quickened sympathy with the relations of things, the thorough comprehension of what is to be done, and other influences which can hardly be expressed in language, combine to make work of any kind a pleasure. These influences in non-specialty are far inferior. To say that they make no difference is to shut one's eyes to the facts.

We work for the sake of achieving objects, not primarily for work's sake, and we might as well say so. That work is a blessing, is not the main fact.

Drudgery is not the work itself, but is a mental condition, the protest of Nature against this false estimate of work. It is almost a pathological fact. We do not cure dyspepsia by preaching. To bear up against adverse circumstances is one thing; to control circumstances, another. Mr. Abbott confuses the two.

I agree with all that he says or quotes about disagreeable work; but I consider his application of it a fundamental mistake, one that has already caused untold misery. A certain amount of drudgery to be overcome is a tonic; an excess is deadly. Much of our preaching is unconscious selfishness. We forget half of our own experience, ignore the rest, and because we would be so comfortable if others felt as we now do, we infer they ought to.

The majority think it is enough to exercise the mind as we do the body. Like animals, they eat, drink, work, and are merry, and don't bother themselves about other than receptive thought more than they have to. As long as they are not conscious of mental hunger, they think they are not starving. Others have found that different laws govern the exercise of the mind; that to be healthy, it must be progressive. The former class may turn work into comfort; but this one aims to turn work into fresh achievement. "The best work," says a recent editorial in *The Dial*, "is not, as a rule, done by those who toil for the greatest number of hours or days, but rather by those who so shape their lives as to maintain the working period at its highest potency."

On page 633 (1895) Mr. Abbott mentions several things which "should fill to the brim the cup of human happiness," but a growing mind is not one of them. If I had not read his ideas on page 590 (1895), which I think cannot readily be carried out on non-special lines, I would be tempted to say that he seems to be safe with the majority.

The restlessness of the second class is exceedingly irritating to the first one, which cannot chew its cud in peace. It is not backward about giving No. 2 a piece of its mind. It says, "You are not like me, therefore you are a fool," or, "You shall not be different from me. I will not have it;" or

when, as sometimes happens, aspiration takes the form of education, "Oh, want to be a gentleman, do you? think yourself too good for common folks;" by which deliberate falsehood, when directed against natural and worthy instincts, there is no telling how many lives have been embittered.

Mr. Abbott has come too near the implication of something like this, no doubt from good motives. But I wish he would stop and think what it leads to. Some, undoubtedly, are low enough to be "above" cleaning stables when necessary, but plenty others avoid too great a portion of stable-cleaning in their lives for no such reason, but because they wish to be *men*, and because life is too short, and human nature too limited, to neglect a continuous and considerable attention to the needs of the mind. Such unqualified talk, from leaders of thought, is indeed discouraging.

Yet in spite of ignorance and injustice, more and more are leaving the ranks of the first-class and joining the second. It is beginning to be seen that it is against Nature for the majority to be where they are; that progress is the life-blood of civilization; that even perfection must keep moving "lest one good custom should corrupt the world."

Non-specialists necessarily belong to the first class. It is all they can do to follow other men at a long distance behind, when trying to do several things at once. Their inspiration, if it comes at all, must come from work for work's sake. Sometimes it does. But does it, and will it, in the majority of cases? Human nature says no.

The farmer's cup of happiness is to be filled to the brim, with a mild dash of diluted theory for flavoring, by regarding work as the end instead of the means. No wonder Mr. Abbott makes a moral question out of this. It needs extraordinary support. But we cannot deceive even ourselves with impunity. Moral laxity inevitably follows moral falsity.

Such principles preserve aristocracy. If it was the exception to find men without some individual superiority, snobishness might die out. But why should not that be? I do not believe in any philosophy of life which does not include the majority. Most men are naturally fitted to excel in some one particular, and should have the opportunity to do so.

Is not T. B. Terry a specialist? Who supposes he devotes one acre of land to one variety of potato, and does nothing else? Who connects Edison with the phonograph only? These are the only proper parallels to the study of one language exclusive of others, or the dative case. A broad basis of subsidiary knowledge is necessary for specialty to amount to much, but it is none the less specialty, for all that.

"A broad-minded man the specialist can never be." Mr. Abbott seems to want to give the word "specialist" a very attenuated meaning, and fight it out on that line. I protest. I understand by the word "specialist" just what is understood by it—a man who understands his business well enough to develop its applications, and who practices only what he thoroughly understands. This specialist is under no influence whatever which narrows him more than the non-specialist. The one practices one department thoroughly; the other, several departments superficially. The influences are different, to be sure, but I cannot comprehend by what sort of mental gymnastics the non-specialist can be made out to have the advantage. It cannot be because he has several irons in the fire, because by that line of reasoning if he studies 36 subjects instead of three, he will be 12 times wiser. It is not because the specialist is like a student who investigates the dative case alone, because the great majority of money-making specialists that we are talking about cannot know one thing thoroughly without being familiar with a great variety of related subjects—more, in fact, than the average non-specialist finds it worth while to bother with, in spite of his numerous requirements.

If, as is almost always the case, the specialist has more or less acquaintance with other things which he might follow for a livelihood, but does not, that does not make him a non-specialist. He does one thing (and the best thing) at a time. That is the main point. As a matter of fact, I have met many more narrow-minded men among non-specialists than among specialists. I wonder why.

"The farmer who devotes all his energies to other things and buys his honey usually has none, as he generally thinks times too hard to buy honey." True at present. But considering the great quantities of fine extracted honey annually sold at the same prices as syrup, it is rather due primarily to false commercial conditions than to any disadvantage in not producing one's own honey.

"Children are crying" for it, and we want it "three times a day, 365 days in the year." I quickly get sick and tired of the finest honey if obliged to eat it at every meal, and have met plenty others who are affected likewise. Is not a little revision needed here?

After being so arbitrary (which I can't help, because I so thoroughly believe in the foregoing), it is rather a relief to find something to be cautious about. I will just give it as one of my notions that Mr. Abbott's argument—"The ordinary every-day work of life must [?] be done, and it is generally done by those who are not specialists"—while good as far as it goes, does not go far. Even now, a large proportion have the choice between specialty and non-specialty in most of their work, and the whole tendency of the age is to keep increasing that proportion. Suppose we all took a notion to be specialists—would stable-cleaning, and milking, and sweeping, and washing clothes, go by default? How about making a relaxation out of them? For instance, I do just as Mr. Abbott does. I clean my own hen-house (I wouldn't have a horse on the place), and do my own house-keeping—all but the starched clothes, which I am proud to say I use as little as possible, B. Taylor and W. Z. Hutchinson to the contrary notwithstanding. As for blacking my shoes to work among the bees, I would be ashamed to think of such a thing. Selah.

The necessary readjustments take some stretching of the imagination. But man is a various animal, and we can't tell what may happen—certainly queer things *have* happened. But given what I believe to be an impregnable fact—that stogleness of purpose and concentration of energy (with any desired subordinate variety) bring out the highest development of man—it seems to me that specialty for all is only a question of time; if so, that end should be kept in view, however distant. The greatest obstacle in the way is the existence of useless luxuries, and in this respect, I admit, human nature seems likely to stand in its own way for a few thousand years to come, more or less. Still, that need not prevent individuals from being sensible; and that a condition is difficult of attainment does not prove it is not the very thing to strive for. "Whatever is, is right," is not sense.

As to how far specialty *can* be now applied (without reference to its desirability), Mr. Abbott knows, or if he doesn't he ought to, about 25 times as much as I do. It is evident, however, that it is not practiced as much as it can be even now.

To say as some do, "Most people have to work with their hands, therefore should not take mind-work into consideration," is one of those intellectual flim-flams that do not impose on a healthy mind for a moment, but themselves illustrate the necessity for more wide-spread mental training. It does not need much thinking to show that while at present few have the opportunity for liberal education, many may take advantage of the mental benefits of specialty, by which I do *not* mean factory piece-work, but something which is capable of development, which repays original thought.

Specialty in the country is the only great influence to oppose to the hybrid specialties of the city—factory work, clerking, cab-driving, etc. People can understand how there is no more drudgery in particular farming than in anything else, and that it does not require rising at nerve-depressing hours; but it won't do to puff general farming, for that is the cause of the exodus from country to city. Arvada, Colo.

A New Binder for holding a year's numbers of the American Bee Journal, we propose to mail, postpaid, to every subscriber who sends us 15 cents. It is called "The Wood Binder," is patented, and is an entirely new and very simple arrangement. Full printed directions accompany each Binder. Every reader should get it, and preserve the copies of the Bee Journal as fast as they are received. They are invaluable for reference, and at the low price of the Binder you can afford to get it yearly.

The Names and Addresses of all your bee-friends, who are not now taking the Bee Journal, are wanted at this office. Send them in, please, when sample copies will be mailed to them. Then you can secure their subscriptions, and earn some of the premiums we have offered. The next few months will be just the time to easily get new subscribers. Try it earnestly, at least.

The McEvoy Foul Brood Treatment is given in Dr. Howard's pamphlet on "Foul Brood; Its Natural History and Rational Treatment." It is the latest publication on the subject, and should be in the hands of every bee-keeper. Price, 25 cents; or clubbed with the Bee Journal for one year—both for \$1.10.

Now is the Time to work for new subscribers. Why not take advantage of the offers made on page 445?

PERSONAL MENTION.

MR. HARRY LATHROP, of Browntown, Wis., wrote us on June 25: "Bees are rolling in the honey from linden."

MR. F. A. GEMMILL, of Stratford, Ont., received a visit from the reporter of the Stratford Beacon, which printed a full column about Mr. G.'s bees and apiary. He purchased his first Italian queen in 1864, and the reporter says his apiary is one of the finest and best managed in that region.

MR. E. J. BAXTER, of Nauvoo, Ill., gave us a very pleasant call last week. He is a son-in-law of Mr. Chas. Dadant, and has 250 colonies of bees. He will have some honey this year, having taken several thousand pounds from white clover thus far. Mr. B. is also extensively engaged in strawberry and grape growing.

MR. W. S. G. MASON, of Morenci, Mich., called on us for a few minutes last week. Mr. M. has been a constant reader of the Bee Journal for many years. Though never having met before, it is often the case with many of our readers who call on us, we seem to have been old friends, upon the first meeting. So it seemed when Mr. Mason came in.

DR. GALLUP, of Santa Ana, Calif., has sent us a copy of The Evening Blade—a local newspaper—containing almost a page description of Catalina Island, the great summer and winter pleasure resort of the Pacific Coast. It is 25 miles off the coast of Los Angeles county, and is about 8x21 miles in size. This is the place where it was reported some time ago that a certain enterprising bee-keeper expected to establish a queen-rearing apiary. But we have not yet learned whether the project was carried through or not.

THE PAGE & LYON MFG. CO., of New London, Wis., were given a whole page write-up, with illustration of their manufacturing plant, in a neat local pamphlet issued recently describing the various business enterprises and prominent men of that wide-awake Wisconsin city. H. H. Page is the President of the company; Vice-President, T. Knapstein; Secretary, A. C. Daugherty; and Treasurer-Manager, M. D. Keith. They are one of the largest and best known manufacturers of and dealers in bee-keepers' supplies in the State. Their advertisement runs regularly in the American Bee Journal, just as should all who expect to reach the consumers of apiarian necessities.

MR. W. F. MARKS, of Chapinville, N. Y., in a sort of pop-cupinish article in the June American Bee-keeper, says that "at no very distant date *Apis dorsata* will be domesticated, and will remain to bless mankind long after *they* and their memories shall be dead and forgotten." The "they" which we have put in Italics refers to all those who in the American Bee Journal opposed the scheme of the Government making the attempt to get "the giant bees" into this country.

Now, we don't see what is to hinder Mr. Marks and his like-thinking friends from themselves going ahead and getting those big bees, and not wait for the Government and what he almost intimates are asinine bee-keepers, to help them. Just think of the glory to be reaped from such an undertaking!

Now, we gladly give our full permission for them or any one else to go right after *Apis dorsata*. And if they deserve a crown for their unselfish work, the American Bee Journal will very willingly do its part in securing it for them, and also a suitable monument to mark their last resting place, or any other deserved "Marks" of honorable recognition that being martyrs to the big sting of *Apis dorsata* entitles them.

OLDEST BEE PAPER IN AMERICA ESTABLISHED IN 1881

THE AMERICAN BEE JOURNAL

PUBLISHED WEEKLY BY

GEORGE W. YORK & COMPANY,

118 Michigan St., CHICAGO, ILL.

REGULAR CONTRIBUTORS:

G. M. Doolittle, of New York. Prof. A. J. Cook, of California.
 Dr. C. C. Miller, of Illinois. Rev. E. T. Abbott, of Missouri.
 Barnett Taylor, of Minnesota. Mrs. L. C. Axtell, of Illinois.
 Cbas. Dadant & Son, of Illinois.

\$1.00 a Year—Sample Copy Sent Free.

[Entered at the Post-Office at Chicago as Second-Class Mail-Matter.]

Vol. XXXVI. CHICAGO, ILL., JULY 9, 1896. No. 28.

EDITORIAL COMMENT

The Langstroth Monument Fund has been languishing for some time. So far we have received only \$2.75, the last 50 cents coming from Brooks D. Cook, of Wilton, N. H. When remitting, Mr. Cook wrote thus:

FRIEND YORK:—I enclose 50 cents as my donation to the Langstroth Monument Fund. May the bee-keeping fraternity respond to this cause with alacrity, is the wish of a novice bee-keeper.

Yours truly,

BROOKS D. COOK.

We are ready to acknowledge in the American Bee Journal all contributions that bee-keepers may feel like sending in. Probably as soon as the honey crop is sold, all will feel better able to spare something for this worthy object. No doubt every bee-keeper in the world will be glad to contribute, and thus have a part in the erection of a suitable monument to the memory of Father Langstroth, to whom modern apiculture owes so much for its past and present success, and promise of future advancement.

Keeping Well.—Editor Hutchinson, in the May Review, says this:

"Keeping well is simply the result of wearing proper clothing, paying attention to the right kind of bathing, breathing pure air in a proper manner, and, most important of all, eating the right kinds of food, which means, of course, using the right kind of drink—pure water."

That is well summed up in one sentence. But how few of us can follow *all* the prescription!

Selling Honey.—There are many who desire to know just how to realize the most out of their honey, for of what avail is it if a crop is secured and the producer get nothing for it?

Mr. B. Taylor, of Minnesota, has had long experience in almost everything connected with bee-keeping, and here is what he says on the subject of selling honey, in the Farm, Stock and Home:

Forty years ago a merchant, when he wished to replenish his stock, journeyed to some wholesale city and personally selected his goods. That is all changed now, and an army of trained salesmen travel to every nook and corner of the country, each carrying samples of the goods in his line. This is a

costly method of doing business, which the consumers finally have to pay, yet it has some advantages which producers of honey may profit by, as the following experience will illustrate:

Having eight 18-section crates of nice comb honey unsold, we resolved to carry it to a neighboring thrifty village and offer it to supply the holiday trade. On arriving in town we first offered the honey to local dealers. Finding the two leading grocers, one, after much talk, said he would take two crates (about 32 pounds); I expressed surprise that he did not want the eight crates, as there was no white comb honey in town. He said there was but very little call for honey, and that 36 one-pound sections would make all he could probably sell. We said if the dealers did not want it we would go out and sell it directly to consumers by the crate. He smiled derisively, and said that would be the best way.

We visited a second store with about the same result, except he thought one crate would be all he could sell. This left five crates. Taking a sample crate we went into the street and sold the five crates to the first six persons they were offered to, and at a cent more a pound than the dealers were asked. In one hour we were back. The grocers were astonished; they said: "Why can't they ask us for honey? We would not have had call for that much in three months." We told them we could sell 50 crates in two days, and we are confident we could.

The dealers were no doubt nearly right in thinking they would have but little call for honey; it is not an article of necessity, and none but the well-to-do can use much of it these times, and they do not search for it as a rule, but we know by much experience that if fine comb or extracted honey is brought to their notice, they will buy liberally.

To ship our honey mostly to the cities, to be sold in competition, is now a fatal policy for honey-producers. Friends, develop your home markets, have your honey in first-class order, and then solicit orders among your friends in town and country. Many think it humiliating to thus peddle their wares; I confess we do not relish that way of doing business, but would much prefer to be a well fed and well clothed "beggar" of this sort than one to accept alms or go hungry.

Beeswax and Honey.—We notice by the "Year-Book of the United States Department of Agriculture" for 1895, just received, that for the year ending June 30, 1895, there were 90,875 pounds of beeswax exported; and there were imported during the years ending June 30, 1891 to 1895, the following amounts of beeswax: 1891, 379,135 pounds; 1892, 271,068; 1893, 238,000; 1894, 318,660; and in 1895, 288,001 pounds.

There were exported during the year ending June 30, 1895, \$118,873 worth of honey; and there were imported during the years ending June 30, 1891 to 1895, the following amounts of honey: 1891, 47,740 gallons; 1892, 70,103; 1893, 176,147; 1894, 152,643; and in 1895, 67,444 gallons.

Why Bees Swarm.—Mr. Hasty, in his "Condensed View of Current Bee-Writings," in the Bee-Keepers' Review, has this to say when commenting on an article written by Geo. F. Robbins, and published on page 225 of the American Bee Journal:

Mr. Robbins jauntily says he knows why bees swarm; and he can tell us (e'enymost) how to prevent it. Let me see if I can't beat you at that, Friend R. Bees swarm because there is a hole in their hive. Abolish the hole and swarming is cured—I can warrant 'em. Perchance the Robbins' remedy is not quite so illusory as mine; but it may fail sometimes, and mine will not. He takes away the contents of the hive, and leaves the hole—and the bees. The objections are that you have doubled your stock, and you may want to prevent that; you have a lot of hungry babies that must starve, as there are no nurses to feed them; and you have a lot of sealed brood that may chill in a sudden cold spell of weather; and you may get the whole thing scooped by robbers. These combs can indeed be given to weak colonies, but only in a small way; and we want a scheme that covers the whole apiary. If he will take away the combs from several hives each day continuously, and put them into a big, warm, tenement hatchery; when the young bees get numerous ladle them a few quarts into each original hive—well, I think that's the direction from which morning is most likely to arise. Perhaps the man who works out the finished details of this may be

canonized as a benefactor. I have never got around to begin the trial, although I have long had the scheme in mind. The outcome of such a hatchery is not increase of colonies, but a lot of nearly empty combs.

Don't think that this article is aught else than one of the most valuable that have been written on this topic. Especially does Friend Robbins get down to "pay gravel" when he says substantially that we cannot at once, and perhaps cannot ever, eradicate the wants of bee-nature; but the line of hope is in the line of *supplying these wants in some other way than hap-hazard swarming.*

The Poisonous Honey Question.—Recently we published a number of communications on the subject of poisonous honey. We have now received the following from "Novice," who started the discussion:

MR. EDITOR:—I have been specially interested in the discussion of the poisonous honey question. I hope that you will encourage further articles on the subject, until all who have any experience on this line shall have contributed what they know through your columns, so that the materials for a correct opinion may be amassed, and bee-keepers may know what is the real truth in regard to this matter. Theory is one thing, and the real, exact truth may be a wholly different thing. The true way to arrive at a correct conclusion is, to get all the facts well in hand, and then it will be time to frame a hypothesis consistent with all the known facts. My opinion given in a former number of the American Bee Journal, to the effect that nectar gathered from the kalmia was harmless, and that the toxic effects, if any, were the result of ingestion of the "bee-bread" or pollen, perhaps was premature, but I cannot help clinging to that idea until it has been demonstrated to be incorrect. If any of the readers of the American Bee Journal know of any instances of poisoning from the use of honey, I would be glad if, with the consent of the editor, they would report the cases, and at the same time give the answers to the inquiry whether pollen was consumed by the patients as they ate the supposed poisonous honey.

Columbia, Miss.

NOVICE.

Of course, we are willing to give space to more information on this matter, but it would almost seem that the subject has been pretty well canvassed.

Editor Hutchinson, of the Review, is a great man to simmer matters down, or, in other words, to push the pith out of things. Here are a few of his condensed paragraphic "edlets" that appeared in his paper lately:

Advertising of an inefficient sort has been tritely compared to a ladder not quite long enough to reach to the top of the house.

Sealed covers did not give so good results in wintering as did upward ventilation, in some experiments made by R. F. Holtermann.

Foundation is not needed at all times in the sections, so writes Doolittle in the Progressive, but when starters only are used in the sections, separators are needed.

Five-banded bees, according to experiments made by Mr. Holtermann, are below the average as to wintering qualities, are short lived, prolific, gentle unless queenless, and are inclined to rob.

P. H. Elwood, in Gleanings, says that the feeding of sugar as suggested, advised and practiced by Mr. Boardman, would have the effect of throwing hundreds of tons more honey on the market. That is exactly what bee-keepers are now needing above all things.

In liquefying honey, Mr. McKnight spoke of liquefying nearly a ton in one day by the use of a wash-boiler and a cook-stove. Mr. F. L. Thompson thinks that there must be a mistake somewhere. He thinks that one hour for the melting of two 50-pound cans of honey is too short altogether.

To Subscribers Only.—It goes without saying that every subscriber to the American Bee Journal is desirous that its influence and circulation shall increase; it is conceded these results can be brought about by individual effort more quickly than in any other way, and as increase of circulation means continual improvement in quality, quantity and

general benefits to all, the hearty co-operation of our subscribers is invoked.

To this end, the publishers ask each individual reader to send us, on a postal card, the names and addresses of at least five persons *whom they absolutely know to be interested in bee-keeping*, and are not now among our regular readers. To these names *three copies* of the American Bee Journal will be sent *free*; this will allow the paper to be its own advocate, and give every one so receiving it an opportunity to decide whether it is to their interest to subscribe.

We have faith enough to carry out our part. Please send on your names. Address, Geo. W. York & Co., 118 Michigan St., Chicago, Ill.

Questions AND Answers

CONDUCTED BY

DR. C. C. MILLER, MARENGO, ILL.

[Questions may be mailed to the Bee Journal, or to Dr. Miller direct.]

Bees That "Run Out" or Deteriorated.

Will a colony of bees get "run out" so the queen will not be prolific? They are in double-walled hives, and wintered out-doors on the summer stands. J. S. Y.

Belle Plaine, Wis.

ANSWER.—Close in-breeding is not considered good, and if a single colony is kept for a series of years isolated, say five miles from any other colony, it will probably deteriorate or "run out." But if other bees are within a mile or two, the supposition is that there will be a constant admixture. It is a good plan to introduce fresh blood frequently, and if the fresh stock is of the best, there can be no doubt as to improvement instead of running out.

Several Questions on Bees and Honey.

How can I raise honey and no bees? How can I raise bees and no honey? What can I do with the drones after swarming? How many times do bees swarm in a season? I don't understand the bee-business very well, and I want to find out what to do. A. R.

Eagle River, Wis.

ANSWER.—Very likely you'll be told that you can raise bees but you can only *produce* honey. I'm not so sure about that, for in each case you cause something to come into existence, and I hardly see why a man doesn't raise butter as well as cows. Certainly we are allowed to speak of raising money, and why not honey? Still, if it is insisted that "produce" is the better word when speaking of honey, I'll try to say "produce" if I don't forget.

You can raise bees without securing a crop of honey, but you can't get the crop of honey without bees. But what you are driving at, I suppose, is to know how to manage so as to secure as much honey as possible without increasing the number of colonies, or, on the other hand, to get as large an increase of bees as possible without caring to get any surplus honey? Much can be done in directing the energies of the bees in one direction or the other, but you must remember that in a bad year, when little nectar can be secured from the flowers, no kind of management on the part of the bee-keeper can make sure of a crop of honey, neither can he secure increase without feeding.

If you want honey, and no increase, give your bees plenty

of room, and keep the honey constantly extracted, and in many cases there will be no attempt at swarming. This will give you the largest returns in honey with no increase, providing the early or white clover and linden harvest is the only source of honey. If, however, the fall flow is considerable, possibly the chief harvest, then you may get better returns by having the bees swarm early so as to have a double force working on the late harvest.

If you work for comb honey instead of extracted, then the problem of keeping down swarming with its consequent increase is a very difficult one. Large hives may do something toward it, but in spite of all you do the bees are likely to swarm. Perhaps the best way for you to do is to count on having the bees swarm once. Then hive the swarm on the old stand, setting the old hive a little to one side to make place for it. In five or seven days remove the old hive to a new location, perhaps 10 feet or more away, and the result of this removal will be that all the field-bees from the old hive, when they return from gathering in the fields, instead of returning to the old hive, will go straight to the spot where it formerly stood, and join the swarm. The swarm thus strengthened will give you the crop of honey, and if the season is very good there may be some yield from the old colony, especially if there is a fall flow.

If increase is your object, there are several ways of managing. One way is to let the bees swarm naturally, and hive the swarm on a new stand. Then hive all after-swarms, if any there be, and if some of them are very weak, give them a frame or two of brood from the first swarm. Sometimes, however, bees refuse to swarm, in which case you may use one of the different plans for artificial increase. Here's one way: Take two frames of brood and bees with the queen, and put them into an empty hive on a new stand, but don't do this till about the time they ought to swarm naturally, say about the beginning of clover harvest. Then not more than nine or ten days later, you can divide the contents of the old hive, putting brood, bees and queen-cells in two or more hives. Two frames of brood well covered with bees will make a fair nucleus. In this way your original colony can be increased to three, four or more. How well they come out will depend on the season, the original strength of the colony and the amount you feed when they can gather nothing.

Probably the best thing to do with drones is to let them alone and prevent too many being reared by having very little drone-comb in the hives. You can cut out the drone-comb and put patches of worker-comb in its place, and you can have all new combs built on worker foundation.

Bees left to themselves will generally send out one swarm in a season, often sending out a second swarm, sometimes a third, fourth, and even a fifth and sixth swarm.

Keeping Bee-Eggs and Royal Jelly.

1. How long will an egg keep, or is there no "keep" to an egg? Must it be in condition to hatch, or become dead?

2. How long will royal jelly keep, to be of good use?

Of course, I mean queen-eggs—if they can be kept as one would keep hen's eggs a certain limit, and then be put in condition to hatch. A. J. W.

ANSWERS.—1. I don't know just how long an egg will keep, but I'm afraid from a very little experimenting that I've done in that direction that there's practically "no keep" to a bee's egg. When it gets so old that it will not hatch, of course it is practically dead.

2. I don't know whether any experiments have ever been tried as to the keeping qualities of royal jelly, but I should have some faith that it might be kept safely out of the hive for a day or two. You can try the experiment by taking from the hive a queen-cell containing a grub and well supplied with jelly, keeping it out of the hive for a time, and then seeing

whether the bees would go on making use of it when returned. Your questions have a direct practical bearing, for if either eggs, or queen-cells containing larvæ, can be safely kept out of the hive, then they can be sent by mail.



"Strawlets" Gleaned from "Gleanings."

Centralblatt says foul brood spores can give the disease after being kept seven years.

Great Britain, says British Bee Journal, imported in 1895 honey to the value of \$200,000.

M. S. Thibaut, editor of *Le Progres Apicole*, says honey is used in the manufacture of all the best toilet soaps.

In France there is complaint that honey granulates too slowly this year, making consumers suspect its genuineness.

Gravenhorst says he has often had laying workers in the same colony with virgin queens, the laying workers disappearing when the queens commenced business.

Total sugar consumed in U. S. in '95, 3,899,488,000 lbs.—just about 60 lbs. for every man, woman, and child. Wouldn't the nation be stronger if one pound out of ten had been honey?

Brood-frames filled with foundation usually have a space of $\frac{1}{4}$ -inch left at the sides. Is that desirable when the frames are wired? I have a lot of combs built on foundation that touched the end-bars, and it seems to work perfectly.

I've been anxious for a genuine sample of sweet clover honey. I got some from Editor York that's reliable. Smells distinctly like sweet clover seed. I didn't like it much at first, but it grows on acquaintance. I'd like a crop of it.

Normally, no bee less than two weeks old works in the field, and no bee more than three weeks old does housework; but if necessary a bee five days old can forage, and it can tend baby and build comb when more than six months old.

De Layens reports in *L'Apiculteur* a thorough series of experiments which seems to show that bees ventilate, not to cool the hive, but to evaporate the honey. The number of fanners early in the morning was in proportion to the flow of honey.

When talking about the danger of missing queen-cells in cutting them out, bear in mind that it makes a big difference whether you cut out after natural swarming or after removal of queen without swarming. In the latter case the cells are much harder to find.

Unite a swarm having a virgin queen with a colony having a fecundated queen, whether she lays or not, and Gravenhorst says the bees with the virgin queen will be killed. But remove the virgin queen and sprinkle the bees with salt water, flour, etc., and all will be well.

When it comes to adulteration of wax, America must take a back seat for Germany. Much has been said about the adulteration of foundation; and now comes an enterprising firm at Cologne, boldly advertising *Gewerbe-wachs* (trade-wax) of three grades, at 18, 25, and 31 cents a pound. The best is $\frac{3}{4}$ beeswax; the cheapest is pure *Gewerbe-wachs*.

Renewal of queens. Herr Strutz says in *Centralblatt* that he thinks strong colonies usually renew their queens annually at the close of harvest, and that prime swarms do the same. That may be partially true; for, naturally, a queen that had laid heavily throughout the season would be more likely to be superseded than one whose laying room had been limited.

A seedsman in Kent, England, as reported in *British Bee Journal*, banished bees from his neighborhood because of crossing his seeds; but when he found the seeds were insufficiently fertilized he was glad to get the bees back. [It is the same old story over again, and yet some won't be convinced. Keep such stories, as long as they are true, afloat.—Ed.]

Question-Box.

In the multitude of counsellors there is safety.—Prov. 11-14.

Hiving Swarms During a Honey Flow.

Query 21.—In hiving prime swarms during a honey-flow, how much foundation do you put in the brood-frames?—ILLINOIS.

B. Taylor—I fill them full.

W. G. Larrabee—Full sheets.

R. L. Taylor—I fill the frames.

James A. Stone—The more, the better.

Dr. J. P. H. Brown—I use full sheets.

W. R. Graham—About one-inch starters.

H. D. Cutting—From three inches to a full frame.

Prof. A. J. Cook—I like them full, on wired frames.

Allen Pringle—That depends. Usually, however, I fill them.

Eugene Secor—Not so much as I used to. About an inch strip now.

J. M. Hambaugh—Full sheets, when I can get it, and the frames wired.

Rev. M. Mahin—If I had the foundation I would fill the frames with it.

E. France—We make all swarms by dividing—have no natural swarms to hive.

P. H. Elwood—Full sheets where we use them. We have no swarms, but artificial.

C. H. Dibbern—I use full sheets, as by using only strips I get entirely too much drone-comb.

G. M. Doolittle—From a starter to full sheets, according to the time of year and my desires.

Dr. C. C. Miller—I seldom hive prime swarms, but if I gave them any foundation I would want the frames filled, so as to have no drone-comb.

Emerson T. Abbott—During a rapid honey-flow I should use full sheets of foundation, if I desired to secure the largest possible amount of honey.

G. W. Demaree—I fill the frames if I have the foundation. But, really, I use full empty combs, and have the foundation drawn out in the upper stories.

Mrs. L. Harrison—I have had plenty of combs to give all swarms during the last four years. When they are all used up I will experiment along that line.

J. E. Pond—I usually hive on frames filled with foundation, but use only as many frames as seem to be enough for the swarm; filling up with filled frames, as occasion requires. I use a 10-frame Langstroth hive.

Bee-Keepers' Photograph.—We have now on hand a limited number of excellent photographs of prominent bee-keepers—a number of pictures on one card. The likeness of 49 of them are shown on one of the photographs, and 121 on the other. We will send them, postpaid, for 30 cents each, mailing from the 121 kind first; then after they are all gone, we will send the 49 kind. So those who order first will get the most "faces" for their money. Send orders to the Bee Journal office.

THE "NOVELTY" POCKET-KNIFE!



Your Name on the Knife.—When ordering, be sure to say just what Name and Address you wish put on the Knife.

The NOVELTY KNIFE is indeed a novelty. The novelty lies in the handle. It is made beautifully of indestructible celluloid, which is as transparent as glass. Underneath the celluloid, on one side of the handle is placed an AMERICAN BEE JOURNAL reminder, and on the other side, name and residence of the Subscriber.

The material entering into this celebrated knife is of the very best quality; the blades are handforged out of the very finest English razor-steel, and we warrant every blade. The bolsters are made of German silver, and will never rust or corrode. The rivets are hardened German silver wire; the linings are plate brass; the back springs of Sheffield spring steel, and the finish of handle as described above. It will last a lifetime, with proper usage.

Why purchase the Novelty Knife? In case a good knife is lost, the chances are, the owner will never recover it; but if the Novelty is lost, having name and address of owner, the finder will return it; otherwise to try to destroy the name and address, would destroy the knife. If traveling, and you meet with a serious accident, and are so fortunate as to have one of the Novelties, your pocket KNIFE will serve as an identifier; and in case of death, your relatives will at once be apprised of the accident.

How appropriate this knife is for a Christmas, New Year or birthday present! What more lasting memento could a mother give to a son, a wife to a husband, a sister to a brother, a lady to a gentleman, or vice versa, a son to a mother, a husband to a wife, a brother to a sister or a gentleman to a lady—the knife having the name of the recipient on one side?

The accompanying cut gives a faint idea, but cannot fully convey an exact representation of this beautiful knife, as the "Novelty" must be seen to be appreciated.

How to Get this Valuable Knife.—We send it postpaid, for \$1.00, or give it as a Premium to the one sending us three new Subscribers to the BEE JOURNAL (with \$3.00), and we will also send to each new name a copy of the Premium Edition of the book "Bees and Honey." We club the Novelty Knife with the BEE JOURNAL for one year, both for \$1.90.

Any Name and Address Put on the Knife.

GEORGE W. YORK & CO.,
CHICAGO, ILLS.

Allow about two weeks for your order to be filled.

PATENT WIRED COMB FOUNDATION

Has No Sag in Brood-Frames

Thin Flat-Bottom Foundation

Has No Fishbone in the Surplus Honey.

Being the cleanest is usually worked the quickest of any Foundation made

J. VAN DEUSEN & SONS,

Sole Manufacturers,

Sprout Brook Montgomery Co., N. Y.

Mention the American Bee Journal

Dadant's Foundation in Chicago!

No other Goods kept here. Send for Price-List.

CHAS. DADANT & SON,
118 Michigan St., CHICAGO, ILL.
134tf Please mention the Bee Journal.



ONE MAN WITH THE UNION COMBINATION SAW

Can do the work of four men using hand tools, in Rippling, Cutting-off, Milling, Rabbeting, Grooving, Gaining, Dadoing, Edging-up, Jointing Stuff, etc. Full Line of Foot and Hand Power Machinery Sold on Trial. Catalogue Free.

SENECA FALLS MFG. CO.,
46 Water St., SENECA FALLS, N. Y.
1A1y Mention the American Bee Journal.

3-Frame Nucleus

and Italian Queen, after July 1st, \$2.50.

Untested Queens, 75c each.

Discount on quantities. A Catalogue of Practical Apian Supplies, Free. Address,

I. J. STRINGHAM,
105 Park Place. NEW YORK, N. Y.



That Queen-Clipping Device Free!

Works Like a Charm.

The Monette Queen-Clipping Device WORKS LIKE A CHARM. With it I have clipped 30 queens, all in one day, when examining my bees. WM. STOLLEY, Grand Island, Nebr.

Couldn't Do Without It.

I have clipped 19 queens, and must say the Monette Queen-Clipping Device is by far the best invention ever made, and will be welcome to many bee-keepers as it was to me. I could not do without one now.

DR. GEO. LACKE, Newburgh, Ind.

PLEASE READ THIS OFFER TO PRESENT SUBSCRIBERS:

Send us just one new name for the American Bee Journal a year (with \$1.00), and we will mail you the Queen-Clipping Device FREE of charge. Or, the Queen-Clipping Device will be sent postpaid for 30 cts. But why not get it as a Premium by the above offer? You can't earn 30 cts. any easier. Almost every bee-keeper will want this Device. See page 130 (Feb. 27) for full description of it. Complete directions accompany each one sent out. It is a most ingenious and useful article. Address,

GEORGE W. YORK & CO., 118 Michigan St., Chicago, Ill.



Now for a 2-Month Campaign

Please Read All of this Page.

A Few of the Good Things to Appear in the
Bee Journal the Next Six Months:

Fifteen Years' Experience in Bee-Keeping.

Mrs. Sallie E. Sherman will begin, in the first number for July, a full account of her 15 years of bee-keeping in Texas. An article from her will appear each week for a number of weeks. They will be of much interest to all, and especially so to Southern bee-keepers.

A Dozen Articles by "The Dadants."

Chas. Dadant & Son, of Illinois, are the leading extracted honey producers of this part of the country. One year they had 48,000 pounds. They will contribute during the next six months, at least a dozen articles, drawn from their experience of a third of a century of bee-keeping.

A Dozen Articles by Mr. Doolittle.

G. M. Doolittle is unquestionably one of the very ablest bee-keepers in this country, and his writings on practical bee-culture have made him famous. With his 27 years' experience, he is well equipped to write profitably for the beginner or even the expert bee-keeper.

A Half-Dozen Articles by Prof. Cook.

Prof. A. J. Cook, of California, author of "The Bee-Keepers' Guide," will contribute at least six good articles before Jan. 1, 1897. He is always interesting and helpful.

A Full Report of the North American Convention

will be published in this paper immediately after the annual meeting, which will be held in September or October next, at Lincoln, Nebr. The Secretary—Dr. A. B. Mason—is now at work on the program, which promises to be the best ever gotten up by the Association. Every American bee-keeper will be interested in the many valuable essays and discussions found in the proceedings of their great annual convention.

A Variety of Contributions by Many Others,

who are well qualified to teach modern bee-culture, will also appear during the next six months. All the foregoing in addition to the

Several Special or Regular Departments

will make the American Bee Journal almost priceless to the man or woman who desires to make a genuine success of bee-culture, and keep informed about the doings of the apian world.

Some Liberal Premiums to Regular Subscribers.

We want every regular reader of the American Bee Journal to go to work to secure new subscribers, which we will accept at

40 Cents for the Next Six Months.

Yes, sir; we will mail the American Bee Journal from July 1, 1896, to Jan. 1, 1897—26 numbers in all—to any one not now a subscriber, for just 40 cents. And to those of our present subscribers who will work to get the new names, we make these

Generous Premium Offers:

For sending us One New Six-Months' Subscription (with 40 cents), we will mail the sender his or her choice of one of the following list of pamphlets:

Foul Brood, by Dr. Howard.	Dr. Foote's Hand-Book of Health.
Kendall's Horse-Book.	Poultry for Market and Profit.
Rural Life.	Our Poultry Doctor.
Silo and Silage, by Prof. Cook.	Turkeys for Market and Profit.
Foul Brood, by Kohoke.	Capons and Caponizing.

For sending Two New Six-Months' Subscriptions (with 80 cents), your choice of one of the following:

Monette Queen-Clipping Device.	Winter Problem, by Pierce.
Blenen-Kultur.	Alley's 30 Years Among the Bees.
Bees and Honey (paper cover).	Queenie Jeanette (a Song.)

For sending Six New Six-Months' Subscriptions (with \$2.40), your choice of one of the following:

Novelty Pocket-Knife (with name). Prof. Cook's Bee-Keeper's Guide

\$25.00 Cash, in Addition to the Above.

Besides all the foregoing premiums, we will distribute, on Sept. 1, 1896, \$25.00 in cash to the nine having sent in the highest number of new 40-cent subscriptions before that date, (but only those having sent 10 or more new subscriptions can compete for the extra cash premiums) in these amounts: To the one sending the highest number, \$10.00. The 2nd highest, \$5.00; 3rd, 4th and 5th highest, \$2.00 each; and to the 6th, 7th, 8th and 9th highest, \$1.00 each.

Let Every One Begin NOW to Work.

We will be glad to mail free sample copies, upon request, either to a club-raiser, or direct to those you desire to solicit, if you will send in the names and addresses.

All subscriptions will begin with the first number in July.

Yours for a two-months' campaign,

GEO. W. YORK & CO., 118 Mich. St., Chicago.

"Samantha at the World's Fair."—We want to make our present readers one of the best offers ever made. All know the excellent books written by "Samantha, Josiah Allen's Wife." Well, "Samantha at the World's Fair" is probably her best, and we are enabled to offer *this book and a year's subscription to the New York "Voice"* (the greatest \$1.00 weekly temperance paper published to-day), for sending us *only three new subscribers to the American Bee Journal* (with \$3.00), provided you are *not now* a subscriber to the "Voice." Think of it—a grand book and a grand weekly temperance newspaper *given simply for sending us three new subscribers to the Bee Journal for a year!* The Samantha book is exactly the same as the \$2.50 one, only the binding is of heavy manilla instead of cloth. It is a special 100,000-copy edition, and when they are all gone, the offer will be withdrawn by the publishers. Of course, no premium will also be given to the new subscribers—*simply the American Bee Journal for one year.*

Only One Cent a Copy for copies of the American Bee Journal before Jan. 1, 1896. We have them running back for about 10 years. But you must let us select them, as we cannot furnish them in regular order, and probably not any particular copies. Just send us as many one-cent stamps as you may want old copies, and we will mail them to you.

Honey as Food and Medicine.—A new and revised edition of this 32-page pamphlet is now issued. It has 5 blank pages on which to write or paste recipes taken from other sources. It is just what its name indicates, and should be liberally distributed among the people everywhere to create a demand for honey. It contains a number of recipes on the use of honey as food and as medicine, besides much other interesting and valuable information. Prices, postpaid, are: Single copy, 5 cts.; 10 copies 30 cts.; 50 for \$1.00; 100 for \$1.75. Better give them a trial. Send all orders to the Bee Journal office.

A HANDY TOOL-HOLDER!

Sent by Express, for \$1.50; or with the Bee Journal one year—both for \$2.00.

Every Manufacturer, Miller, Carpenter, Cabinet Maker, Machinist, Wheelwright and Quarryman, Farmer, or any one using a grindstone, should have one of these Tool-Holders. One boy can do the work of two persons, and grind much faster, easier and with perfect accuracy. Will hold any kind of tool, from the smallest chisel to a draw shave or ax. Extra attachment for sharpening scythe blades included in the above price. The work is done without wetting the hands or soiling the clothes, as the water flows from the operator. It can be attached to any size stone for hand or steam power, is always ready for use, nothing to get out of order, and is absolutely worth 100 times its cost.

No farm is well-equipped unless it has a Tool-Holder. Pays for itself in a short time.

How to Use the Holder.

DIRECTIONS.—The Tool is fastened securely in the Holder by a set-screw and can be ground to any desired bevel by inserting the arm of the Holder into a higher or lower notch of the standard. While turning the crank with the right hand, the left rests on an steady the Holder; the Tool is moved to the right or left across the stone, or examined while grinding, as readily and in the same way as if held in the hands.

For grinding **Round - Edge Tools**, the holes in the standard are used instead of the notches.

Address, **GEORGE W. YORK & CO.,**

CHICAGO, ILL.

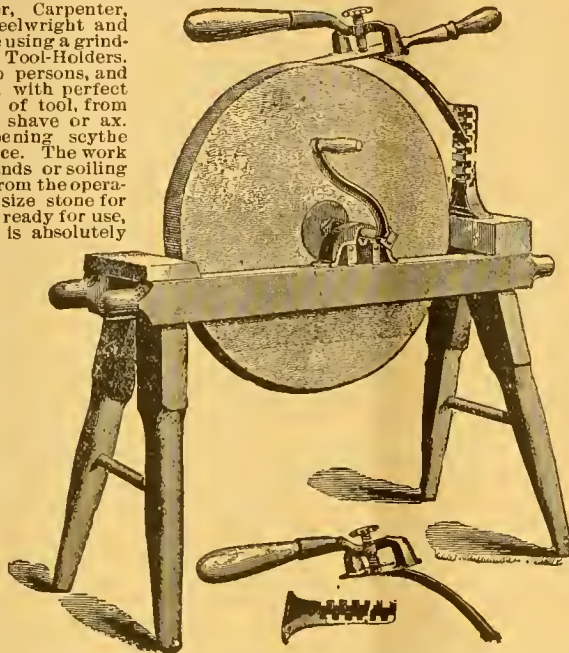

General Items.

Bees Did Well.

Bees have done very well. The honey season is now over. Dry weather killed all the white clover. H. ALLEY.

Wenham, Mass., June 30.

Look for a Big Crop.

Bees are working finely on white and Asike clover. I look for a big crop of honey this year, for we have had plenty of rain. Golden-rod and other honey-producing plants are looking well at present.

I could not do without the American Bee Journal. JACOB WIRTH.

Rickel, Ill., June 30.

No Nectar in White Clover.

The honey season in this county (Jersey) is virtually over, unless we have a fall crop, and the season has proved a failure. There was more white clover than we have had for four years, but it did not secrete any nectar, and as that is about all we have to depend upon (having no basswood), we are "in the hole." Sweet clover yielded honey, but there was not enough of it to amount to much. Bees are working on it from morning till night, while we scarcely ever see a bee on white clover.

The prospect for a fall crop is pretty good, as it has been raining nearly every

day this week, 4.25 inches of water having fallen between June 21 and 27, and still raining, spoiling a good deal of wheat in the shock, and corn on the flat lands.

The last four years having been failures here in the bee-business, there is not more than 20 per cent of the bees in the county there were seven years ago; most of the farmers have let their bees die off—it is only those that have fed their bees and looked after them that have any left, and if we do not get a fall crop of honey this season, and the bees have to be fed to carry them through the winter, there will be very few bees in the spring, and less beekeepers, as the most of them will be out of the business, as the outlook here is not very favorable for bee-keeping; we have nothing to depend upon for surplus but white clover, and if that refuses to yield, we may just as well go out of the business. H. D. EDWARDS.

Delhi, Ill., June 27.

The Season—8-Frame Hives.

My bees came through the winter in very good condition; they built up very strong on fruit-bloom, one colony storing some honey in the sections from apple-bloom. White clover bloomed well, and the bees were storing honey in the sections right along, but about May 20 it commenced raining, and has been so wet ever since that bees have done nothing, and the clover is about through bloom-

ing. I have had two swarms—one on May 30 and the other June 8—but if the weather doesn't fair up pretty soon, there will be no more swarming and no surplus.

At this time last season (1895) I had taken 200 pounds of honey from seven colonies, and this season from 14 I haven't taken 10 pounds, with no prospect for any more until fall.

I use the 8-frame hive, and prefer it to the 10-frame for comb honey. Some tell me that 8 frames are not enough, and that bees will swarm too much if kept in 8-frame hives, but my neighbors who keep bees in 10-frame hives, or boxes of all shapes and sizes, have just as much, or more, swarming than I do, and get less honey.

I had a rather singular experience with a swarm last season. On the first Sunday in August a swarm issued unobserved, and clustered and was not seen until they began to break the cluster, when they went straight for a patch of timber $\frac{1}{4}$ mile away. On the next Tuesday morning, about 8 o'clock, they came back and acted as if they were going into the hive which they had issued from, but they clustered and were hived, and it is as good a colony as I have in the yard this season. Some may say that it was not the same swarm that left the Sunday before, that came back, but I am satisfied that it was, for the morning that they returned it had been misting rain until within half an hour before they came, and they came exactly from the same direction the swarm went off. It was a prime swarm with a laying queen.

What has become of the Benton bee-book? I haven't heard anything said about it lately. W. E. WHITTINGTON.

Benton, Ills., June 18.

[The extra edition of the Benton book has been issued, and many of them distributed. Any one can get a copy free by writing to his United States senator or representative, in Washington.—Ed.]

Bees Working "Like Tigers."

I began the season with 32 colonies of bees, increased to 50 by natural swarming, and have a good show for from 50 to 75 pounds of comb honey per colony for the season. The bees are working like tigers at present, on white and sweet clover.

Success to the old American Bee Journal. A. WICHERTS.

Mattison, Ill., July 1.

Gathered No Surplus.

Bees in this part of the country have gathered no surplus honey so far this season. The basswood failed; the trees were covered with bloom, but contained no nectar. In the spring it looked as if we were going to have a good crop of honey, but now it looks differently. We may get a little honey if we get enough rain. FRANK RASMUSSEN.

Greenville, Mich., July 2.

Honey-Clovers & Buckwheat SEED FOR SALE.

We have made arrangements so that we can furnish seed of several of the Clovers and Japanese Buckwheat, by freight or express, at the following prices, cash with order:

	5lb	10lb	25lb	50lb
Alske Clover	\$.70	\$1.25	\$3.00	\$ 5.75
Sweet Clover75	1.40	3.25	6.00
White Clover.....	1.25	2.00	4.50	8.00
Alfalfa Clover....	.65	1.10	2.70	5.00
Crimson Clover....	.55	.90	2.00	3.50
Jap. Buckwheat....	.20	.35	.90	1.25

Prices subject to market changes.

Add 25 cents to your order, for cartage, if wanted by freight.
Your orders are solicited.

GEORGE W. YORK & CO.,
CHICAGO, ILLS.

Sweet Clover ¹/₂ Canada.

At the following prices:

5 lbs.	10 lbs.	25 lbs.	50 lbs.
\$1.00	\$1.60	\$3.75	\$7.25.

Also a quantity of Motherwort and Catnip seed. Prices on application.

EGGS for Hatching. Buff Leghorns, Indian Games, & Light Brahmans. Choice Birds. A breeder for 30 years. Prices on application

JOHN McARTHUR,
881 Yonge Street. TORONTO, ONT.
15Atd *Mention the American Bee Journal.*

Promptness Is What Counts!

Honey-Jars, Shipping-Cases, and everything that bee-keepers use. **Root's Goods at Root's Prices,** and the best shipping point in the country.
Dealer in Honey and Beeswax. Catalogue Free.

Walter S. Ponder
162 Mass. Ave.
INDIANAPOLIS, IND.

HONEY We have a large amount of Pure No. 1 Alfalfa we will sell cheap.

Wax Wanted.

Boss bee-escape Warranted the best, simplest and quickest Escape on the market. Sent postpaid to any address for 30 cts. It can be returned at our expense if it is not as represented, or we will send the Escape on trial to any bee-keeper wishing to test it in good faith. We are agents for the **Ferguson Patent Hive** with double-case Super and Wicket-Gate Honey-Board, with the Escape. It is the easiest, quickest hive to handle for the production of comb honey. Address,
E. S. LOVESV & CO.,
355 6th East St., SALT LAKE CITY, UTAH.
Mention the American Bee Journal. 9Atd



Queens! Queens!

Fine Untested Queens mailed PROMPTLY at 60 cts. each, or Six for \$3.30.

Safe delivery and satisfaction guaranteed. Address.

F. GRABBE,
LIBERTYVILLE, Lake Co., ILL.
26Atd *Mention the American Bee Journal.*

BEGINNERS.

Beginners should have a copy of the Amateur Bee-Keeper, a 70-page book by Prof. J. W. Rouse. Price 25 cents; if sent by mail, 28c. The little book and the Progressive Bee-Keeper (a live, progressive 28-page monthly journal) one year, 65c. Address any first-class dealer, or

LEAHY MFG. CO., Higginsville, Mo.

READERS Of this Journal who write to any of our advertisers, either in ordering, or asking about the Goods offered, will please state that they saw the Advertisement in this paper.

Honey & Beeswax Market Quotations.

The following rules for grading honey were adopted by the North American Bee-Keepers' Association, and, so far as possible, quotations, are made according to these rules:

FANCY.—All sections to be well filled; combs straight, of even thickness, and firmly attached to all four sides; both wood and comb unsoiled by travel-stain, or otherwise; all the cells sealed except the row of cells next the wood.

No. 1.—All sections well filled, but combs uneven or crooked, detached at the bottom, or with but few cells unsealed; both wood and comb unsoiled by travel-stain or otherwise.

In addition to this the honey is to be classified according to color, using the terms white, amber and dark. That is, there will be "fancy white," "No. 1 dark," etc.

CHICAGO, ILL., July 2.—There is little, if any, trade in honey at this time. We quote: Extracted, amber, 4½@5¼c. Beeswax, 25@27.

PHILADELPHIA, Pa., Apr. 22.—We quote: No. 1 white, 9@10c.; fancy amber, 8@9c.; fancy dark, 7@8c. Extracted, white clover, 10c.; amber, 5@5½c.; dark, 4@4½c. Beeswax, 25@26c. Comb honey is dull. Extracted in fair demand. Beeswax lower. W. A. S.

BUFFALO, N. Y., Apr. 20.—We quote: Fancy white, 15@16c.; No. 1 white, 13@14c.; fancy dark, 8@9c.; No. 1 dark, 7@7½c. Beeswax, 25@28c. Trade very dull and honey not moving, except a few fancy lots; anything dark is hard to sell. B. & Co.

CINCINNATI, O., Apr. 22.—There is no fancy white comb honey on our market. Best white sells at 12@14c. in a jobbing way, with a fair demand. Demand is good for extracted at 4@7c., according to quality.

Beeswax is in good demand at 25@30c. for good to choice yellow. C. F. M. & S.

NEW YORK, N. Y., June 24.—No demand for comb honey of any kind. New crop of Southern extracted is arriving freely, and sells fairly good at 50@52c per gallon for common, and 55@60c per gallon for better grades. Beeswax dull at 26@27c.

KANSAS CITY, Mo., June 20.—We quote: No. 1 white comb, 1-lbs., 13@14c.; No. 2, 11@12c.; No. 1 amber, 11@12c.; No. 2, 8@10c. Extracted, white, 5½@6c.; amber, 5@5½c.; dark, 4@4½c. Beeswax, 22@25c. C. C. C. & Co.

List of Honey and Beeswax Dealers.

Most of whom Quote in this Journal.

- Chicago, Ills.**
R. A. BURNETT & Co., 163 South Water Street.
- New York, N. Y.**
HILDRETH BROS. & SEGELKEN,
120 & 122 West Broadway.
CHAS. ISRAEL & BROS., 486 Canal St.
- Kansas City, Mo.**
O. C. CLEMOMS & Co., 423 Walnut St.
- Buffalo, N. Y.**
BATTERSON & Co., 167 & 169 Scott St.
- Hamilton, Ills.**
CHAS. DADANT & SON.
- Philadelphia, Pa.**
WM. A. SELSER, 10 Vine St.
- Cincinnati, Ohio.**
C. F. MUTH & SON, cor. Freeman & Central avs.

5 per ct. Off to Reduce Stock on all kinds of SUPPLIES.

—**COMB FOUNDATION**— which will be sold in lots of 10 lbs. or more as follows: Medium, 38 cts.; Light, 40 cts.; Thin Surplus, 45 cts.; Extra Thin, 50 cts.

Queens—Untested, 75c.; Tested, \$1.00.

W. J. FINCH, Jr., SPRINGFIELD ILLS.

Mention the American Bee Journal.

Bee-Keeper's Guide—see page 447.

The Bee-Keepers' Guide:

Or Manual of the Apiary,

BY PROF. A. J. COOK.

This 15th and latest edition of Prof. Cook's magnificent book of 460 pages, in neat and substantial cloth binding, we propose to give away to our present subscribers, for the work of getting NEW subscribers for the American Bee Journal.

A description of the book here is quite unnecessary—it is simply the most complete scientific and practical bee-book published to-day. Fully illustrated, and all written in the most fascinating style. The author is also too well-known to the whole bee-world to require any introduction. No bee-keeper is fully equipped, or his library complete, without "THE BEE-KEEPER'S GUIDE."

Given For 2 New Subscribers.

The following offer is made to PRESENT subscribers only, and no premium is also given to the two new subscribers—simply the Bee Journal for one year:

Send us Two New Subscribers to the Bee Journal (with \$2.00), and we will mail you a copy of Prof. Cook's book FREE as a premium. Prof. Cook's book alone sent for \$1.25, or we club it with the Bee Journal for a year—both together for only \$1.75. But surely anybody can get only 2 new subscribers to the Bee Journal for a year, and thus get the book as a premium. Let everybody try for it. Will you have one?

GEORGE W. YORK & CO.,
CHICAGO, ILLS.

Mention the American Bee Journal.

A Bargain—EARLY QUEENS.

119 Colonies Italian Bees in Chaff Hives; two acres land; good house; excellent well.

Early Queens—Tested, \$1.00; Untested, 50c. Sent by return mail.

E. L. CARRINGTON,
16Atd PETTUS, Bee Co., TEX.
Reference—1st National Bank of Beeville.

Mention the American Bee Journal.

TESTED QUEENS!

BY RETURN MAIL, \$1.00 each, or six for \$5.00. Other breeders may sell you queens cheaper, but they can't furnish any better queens, and in many instances you may have to wait weeks before you get them. It costs something to keep a lot of queens on hand in nuclei, but it is worth something to get queens by return mail when you want them. The REVIEW and one Queen for only \$1.50.

W. Z. HUTCHINSON,
28Etd FLINT, MICH.

Mention the American Bee Journal.

TO EXCHANGE—200 Egg Incubator, one Green-Bone Cutter, nine Buff Cochins Hens and one Cock. Bees or Honey preferred.

P. H. EMERY, Summit, So. Dak.

Queens and Queen-Rearing.

If you want to know how to have queens fertilized in upper stories while the old queen is still laying below; how you may safely introduce any queen, at any time of the year when bees can fly; all about the different races of bees; all about shipping queens, queen-cages, candy for queen-cages, etc.; all about forming nuclei, multiplying or uniting bees, or weak colonies, etc.; or, in fact, everything about the queen-business which you may want to know—send for Doolittle's "Scientific Queen-Rearing"—a book of over 170 pages, which is as interesting as a story. Here are some good offers of this book:

Bound in cloth, postpaid, \$1.00; or clubbed with the BEE JOURNAL for one year—both for only \$1.75; or given free as a premium for sending us three new subscribers to the BEE JOURNAL for a year at \$1.00 each.

Bottom Prices

**BRING US BIG TRADE.
GOOD GOODS KEEP IT.**

If you want the best supplies that can be made at a little less cost than you can buy the same goods for elsewhere, write to us for low prices. 1896 Catalogue now ready—ask for it and a free copy of **The American Bee-Keeper** (36 pages).

Address,
**THE W. T. FALCONER MFG. CO.,
JAMESTOWN, N. Y.**

Mention the American Bee Journal.

COMB FOUNDATION!

Wax always wanted for Cash or in Exchange for Fan, or other Supplies. My trade is established on **Low Prices** and the merit of my **Foundation**. **Orders filled promptly.** WORKING WAX INTO FDN. BY THE LB. A SPECIALTY. Wholesale prices to dealers and large consumers. Send for Prices and Samples to—**GUS DITTMER, AUGUSTA, WIS.** Reference—Augusta Bank. 1Atf

Mention the American Bee Journal.

EQUAL TO X RAYS. Our strain of **trate red clover blossoms.** Choice **Untested Queens, 70c**; 3 for \$2—by return mail. A full line of **A. I. Root & Co.'s Goods** on hand. 36-page Catalogue Free. **JNO. NEBEL & SON, High Hill, Mo.** *Mention the American Bee Journal.* 4A26t

I ARISE



TO SAY to the readers of the **BEE JOURNAL** that **DOOLITTLE**

has concluded to sell **—BEEES and QUEENS—** in their season, during 1896, at the following prices:

- One Colony of Italians on 9 Gallip frames, in light shipping-box \$6.00
- Five Colonies..... 25.00
- Ten Colonies... 45.00
- 1 untested queen. 1.00
- 6 " queens 5.50
- 12 " " 10.00
- 1 tested Queen... \$1.50
- 3 " Queens. 3.50
- 1 select tested queen 2.00
- 3 " " Queens 4.00

Select tested queen, previous season's rearing . 4.00
Extra Selected for breeding, **THE VERY BEST**.. 5.00
About a Pound of **BEEES** in a Two-frame Nucless, with any Queen, \$2.00 extra.

☐ Circular free, giving full particulars regarding the Bees and each class of Queens.
Address

G. M. DOOLITTLE,

12A25t **BORODINO, Onon. Co., N. Y.**
Mention the American Bee Journal.

BEEES QUEENS
Smokers, Sections, Comb Foundation, and all Apian Supplies cheap. Send for FREE catalogue. **E. T. FLANAGAN, Belleisle, Ill.** 6A26t Please mention the Bee Journal.

PURE BARRED PLYMOUTH ROCK

Eggs, \$1.25 per 14. Our P. Rocks are very large, with fine plumage. Also,

BLACK MINORCA EGGS,

a non-sitting and great laying breed. Both kinds raised upon our farm. Minorca Cockrels, \$1.00 each. **Mrs. L. C. AXTELL,** 16Atf **ROSEVILLE, Warren Co., ILL.**

Mention the American Bee Journal.

19th Year Dadant's Foundation 19th Year

Is still in the lead, for we use all the latest improvements, including the

NEW WEED PROCESS,

and still make the best goods. Remember that we do not use any acid to purify our beeswax, and that is why our Foundation preserves the smell of the honey and is more acceptable to the bees, than any other. It is kept for sale by

T. H. Strickler, Solomon City, Kansas.
G. K. Hubbard, Fort Wayne, Ind.
L. Hanssen, Davenport, Iowa.
C. Theilmann, Theilmanton, Minn.
E. C. Eaglesfield, Berlin, Wis.
E. T. Abbott, St. Joseph, Mo.
J. M. Jenkins, Wetumpka, Alabama
John Ray, East Saginaw, Mich.
Vickery Bros., Evansville, Ind.

The Jennie Atchley Company, Beeville, Texas.
C. F. Muth & Son, Cincinnati, Ohio
E. Kretschmer, Red Oak, Iowa.
G. B. Lewis Co., Watertown, Wis.
James Reynolds Elevator Co., Poughkeepsie, N. Y.
Louisiana Bee-Keeper's Supply Manufactory, Donaldsonville, La.
Page & Lyon, New London, Wis.
John Nebel & Son, High Hill, Mo.

and many other Dealers. All agree in saying that no goods are better than ours.

Those of our customers who formerly bought through Thos. G. Newman can get our Foundation in **Chicago, Ill.**, by addressing us at **118 Michigan Street**. We keep no other goods there.

We make a specialty of **Veils and Veil Stuffs** of best quality, cotton and silk.

"LANGSTROTH ON THE HONEY-BEE"—Revised.

Bee-Keeper's Supplies, Smokers, Sections, Tin Pails, etc. **Samples of Foundation and Tulle FREE** with Circular. Instructions to beginners with Circular. Send us your address.

CHAS. DADANT & SON,

Mention the American Bee Journal.

HAMILTON, Hancock Co., ILL.

Williams' Automatic Reversible Honey-Extractor.

Has no sprocket gear or chain at bottom of reel to get daubed with honey and corrode and streak it. The reversing arrangement of the Williams is at the top of the comb-baskets. "The best extractor on the market"—so says the veteran bee-keeper, Mr. N. E. France, of Platteville, Wis.

ITALIAN BEES.

Bright Yellow or Leather-Colored. Queens of either strain—Untested, 60 cents each; two, \$1.00. Select, 75c. Tested, \$1.00. Full Colonies cheap. No foul brood or bee-paralysis. Remit by Express Money Order, payable at Barnum, Wis. Many customers send \$1.00 and \$2.00 bills, which are very convenient. Stamps taken for less than \$1.00. **Price-List Free.**

26Atf

VAN ALLEN & WILLIAMS, BARNUM, WIS.

Please mention the American Bee Journal.

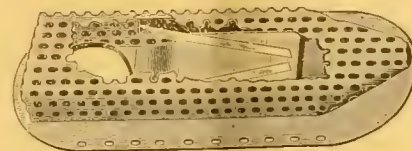

Porter Honey-House Bee-Escape

Have you seen it? Just the thing to put on the doors or windows of your bee-rooms. Indispensable, you'll say after you have tried it.

Corneil Bee-Smokers.

Cheap, strong, serviceable. We have sold a good many of these, and so far there has been no complaint; but, on the other hand, there have been scores of letters in their praise. Price, \$5 cts. Prepaid, \$1.10.



COWAN.

Cowan and Novice Extractors.

These are the best. We are prepared to furnish, on short notice, from any of our several Branches, 2, 4, and 6 frame Cowans and 2-frame Novices. If you want the genuine, see that they

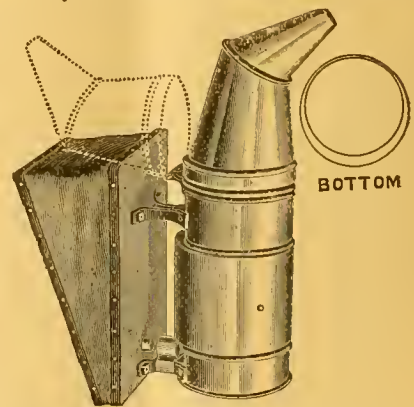

BOTTOM

bear our name. **A 36-page Catalog sent Free on Application.**

THE A. I. ROOT CO., MEDINA, OHIO.

BRANCH OFFICES AT:

118 Michigan St., Chicago, Ill.

1024 Mississippi St., St. Paul, Minn.

Syracuse, N. Y.

Mechanic's Falls, Maine.



AMERICAN BEE JOURNAL

DEVOTED EXCLUSIVELY TO THE INTERESTS OF HONEY-PRODUCERS

ESTABLISHED 1861
THE OLDEST BEE-PAPER IN AMERICA

Published Weekly, at \$1.00 per annum.

Sample Copy sent on Application.

36th Year.

CHICAGO, ILL., JULY 16, 1896.

No. 29.



Working for Comb Honey—Finishing the Season

BY G. M. DOOLITTLE.

We will suppose that by the time this reaches the readers of the American Bee Journal, swarming is all done with and we are ready to look after the sections. If we had sections of empty comb to put in the center of our surplus arrangement, as I have advised so often in the bee-papers, we will only have to look after these the first time over the apiary, for if any are finished it will be these, for bees can fill empty comb and seal it over much sooner than they can build comb or draw out foundation.

The first thing to be done is to get the smoker, having it lighted and ready for use, together with a spring wheelbarrow. On the wheelbarrow is placed some wide frames of sections with starters to take the place of the full ones as they come off. Having arrived at a hive, take off the cover and gently pry the wide frames apart with a stout knife, when a little smoke is blown down through the crack between them, so as to drive the bees away that we may see if any are completed, which is told by the cells being sealed over. Unless all in one wide frame are finished I do not attempt to take any, but when they are I remove such wide frame, shaking the bees off, which is readily done at this time, except a few behind the separator, as each bee is filled with honey so it is easily rolled off by the usual method of shaking brood-combs, which I have several times described.

The wide frame of honey is now placed on the wheelbarrow and a wide frame of empty sections put in its place on the hive. If more than one wide frame of sections are finished they are taken off also, and others put in their places, the same as was the first. Proceed to the next hive, working the same as at the first, and so on until you have been over the whole apiary.

Of course, it would be less work to leave the honey all on until the close of the season, and then take all off together, but if we do this, much of this first finished will get travel-stained and not sell for so fancy a price as it will if taken off when snow-white.

If the honey-yield keeps good, I go over the apiary in the same way a week later, and so on until the honey season draws near its close, when what remains on the hives is al-

lowed to stay as long as there is prospect of the bees completing any more sections, after which the whole is taken off by means of the bee-escape board, so often spoken of in our bee-papers.

As fast as taken off, the honey is stored in a dry, airy room, and the warmer this room can be the better, for in such a dry, warm, airy room the honey in the sections keeps growing thicker and thicker, and better and better, as long as it remains, bringing it to a condition where it will not so quickly gather moisture or "sweat," if the consumer or dealer does not happen to store it in a favorable place when it comes into his hands. This item of properly curing honey is of more importance than the average bee-keeper places upon it, judging from the numerous letters which I receive every fall, asking "What ails my honey? It is taking on a watery appearance, and the honey in the unsealed cells is standing out in drops. What can I do for it?" Nothing ails the honey, only that the apiarist has stored it in a damp, cool place so that it has taken on moisture till the expansion has become so great that it has touched the sealing to the cells, giving it the watery appearance; and if left in such a place long the cappings will burst, the honey run out, sour, and become so deteriorated as to be unfit for use. It seems too bad to have a nice crop of honey, which has been worked for so hard to obtain, spoil, or become second class, from lack of knowledge regarding how it should be cared for when off the hives.

Being kept in a warm, dry room, as all honey should be, the next difficulty which is liable to appear, comes in the shape of the larvæ of the wax-moth, for warmth is what they revel in. How the eggs from the moth come on our comb honey is a mystery, as the bees guard the hive with vigilance against these moth enemies; but certain it is, that they are on the combs, or else there would be no larvæ to commit depredations. All sections fully sealed and snow-white should be placed by themselves, as these are rarely troubled, but those having pollen in them, or which are discolored near the bottom by the bees working bits of old comb from the hive below into that in the sections, should be carefully watched, and if the works of the larvæ are seen upon them, they should be stored in hives, tiered up or in a tight box or room, and sulphured, as has been given so many times in our bee papers and books.

The honey being properly cured, it should now be crated and gotten ready for market. Some are almost as careless about this part as they are about curing the honey, tumbling the sections into a wagon and hauling to market in a manner which shows they are not posted in their business, this giving the groceryman the clue that he can buy the honey at his own price, thus giving the producer poor returns for his labor, and injuring the market for others who know how honey should be handled.

The honey should be properly graded and put up into

tasty crates, even though the producer have only 50 pounds as his production. Many rules for grading have been given, but as far as I know each is at liberty to adopt what he thinks best. I make three grades which I call, XXX, XX, and X. In the first I place only white honey, stored in white combs and thoroughly sealed. In the second, white honey in combs that are somewhat travel-stained, and those having a few unsealed cells next the wood and near the bottom. In the third I put all honey which I consider salable, the same being off color, one-sixth sealed, or badly travel-stained, together with fall honey if I have such, which is not often.

Having all parts done to the best of my ability, I generally ship on commission all that I do not sell at home, which is very little, as I live in a rural district, with enough small bee-keepers about me to supply all the wants of their neighbors and mine.

Borodino, N. Y.



A Swarm-Hiving Experience—Bee-Stings.

BY EDWIN BEVINS.

To-day (June 24) I have the most grotesque-looking face in America. Yesterday I had a swarm of bees come out and alight on a branch of that same oak-tree where the swarm lit last year, that gave me so much trouble. There was a big wood-pile under the tree again this year, and a big box was placed on top of the wood-pile and a hive placed on top of the box. Then an assistant, robed in scare-crow attire, climbed into the tree to saw off the branch. When he got up there, he said he wanted some help.

I went up with hat and veil on to assist him. I found that another branch of a large limb a little higher than the one the bees were clustered on was broken in a way to let some of the twigs fall onto the top of the cluster. Some of the bees were clustered on these twigs. My veil and hat had got torn from my head while climbing up the tree. While my assistant held the branch having most of the bees, I endeavored to cut some of the twigs of the other branch with my jack-knife. Then the bees made a rush for my bare face, and the bare spot on the top of my head. I closed the knife and thrust it into my pocket, and then scrambled down with as much speed as possible to one of the lower limbs of the tree. Suspending myself by the arms from this, I dropped to the ground. My assistant shook what bees he could in front of the hive, but they soon went back to the tree.

After ridding myself of my pets, I put on some ku-kluk fixings, and resolved that I would hive that swarm. I placed the hive on the ground at the foot of the wood-pile, and then got a bushel basket and attached it to the end of a pole by means of a piece of fence-wire. Then I climbed on top of the wood-pile and thrust the basket close up under the cluster. My assistant hit the branch a rap with a pole, above the cluster, and the bees were dumped in front of the hive. Half of them went back to the branch, and the dumping process was repeated. Then the bees staid hived, except a few that seemed to think it their duty to chase everybody in sight the rest of the day.

About 40 stings was the number administered, where, it is charitable to suppose, the bees thought they would do the most good. I scraped out stingers most of the afternoon yesterday, and occasionally find one to-day. Strange to say, all these stings have caused me no pain. The feeling produced by them is rather comfortable than otherwise. I have been stung before in places where I had been feeling rheumatic pains, and the pains did not return. It is not unlikely that formic acid may be a specific for some kinds of rheumatism. Some persons may be so fastidious as to object to its application in the rough-and-tumble way, and the wholesale quantity that it was applied to me yesterday.

The fact that the stings I got gave me no pain, and that

they may prove beneficial to my health, will save the next advocate of natural swarming I meet from getting licked.

I think, however, that I will buy a Manum swarm-catcher before the bees begin to swarm next year.

Leon, Iowa.



Dealing with Foul Brood—Experience.

BY HON. R. L. TAYLOR,

Superintendent of the Michigan Experiment Apiary.

It is coming to be more and more important, apparently, that a thorough knowledge of the disease called foul brood, and of the steps necessary to exterminate it, should be disseminated among those who keep bees, for it seems to have a foothold in many widely separated portions of the State, and it must always be terribly destructive when it is not dealt with intelligently; so a record of my experience with it during the past year will have its value.

For the purpose of study and experimentation I have aimed, latterly, to keep a colony or two having the disease, but last summer the disease broke out afresh, making the number of diseased colonies uncomfortably large; there being now eleven colonies which underwent treatment, not to speak of others that first or last were united with one or another of these. The cause of this marked reappearance, as I think, was owing to the fact that on account of the dearth of nectar during June and July, the bees encroached on their oldest stores, even to their almost entire consumption, more or less of which had been in their hives for years, and contained, in a quiescent state, the germs of the disease.

These colonies were treated according to the plan described in my report of two years ago, by driving or shaking the bees into a clean hive furnished with foundation. The majority of the colonies were so treated at the beginning of honey gathering from fall flowers, the rest two or three weeks later, when the honey-flow was nearly over. The decided advantage of treating diseased colonies when there is a considerable flow of nectar was clearly seen by an inspection of these two lots of bees after the treatment. Of the first lot every colony went to work at once contentedly, and with a will, and at the close of the season were fair colonies with natural stores for winter. Of those treated later, all were discontented, and all, or nearly all, attempted to swarm out, some of them frequently. The consequence was that all were weak even after some had been united.

The reason that all were not treated at the earlier date was that it was deemed desirable to save some of the brood taken from the first lot by giving it to others, to be cared for, till it should hatch. The event showed that it would have been more profitable to have sacrificed all the brood, and had the treatment performed at the opening of the honey-flow.

These colonies have been kept distinct from the other colonies of the apiary and carefully watched for evidence for or against the effectiveness of the plan of treatment used. The result, so far, is that all are entirely free of the disease at this writing (May 25, 1896) unless one be excepted, in which were found two cells of dead brood which bore some resemblance to that affected with the disease, and which it is barely possible may yet prove to be an incipient stage of foul brood, but, should this be the case, so much time has elapsed since the treatment it is extremely improbable that it had its source in the case of the disease with which the colony was afflicted before treatment. For a full description of the disease and the above method of cure, I must refer to my report for the year ending May 31, 1894.

Other methods of cure have been, or are still, recommended. The fasting cure, so-called from its requirement that the bees be shut up in a box till the honey carried with them is consumed, and individual bees begin to drop from

hunger, I experimented with extensively at one time and found that while it has no advantage in any particular over the method I now recommend, it is subject to several weighty objections.

The method of cure by the administration of drugs, once recommended by high authority, is not practical, even if it ever really effected a cure, and yet drugs have a place in the management of the disease. To prevent the spread of the infection when opening the hives and handling the combs of colonies having the disease, Benton recommends a solution of $\frac{1}{8}$ ounce of corrosive sublimate in one gallon of water, to be used to wash thoroughly the hands and all tools used about the hive before opening another hive. If for any reason the treatment of a colony must be delayed, I have found a preparation of $\frac{1}{4}$ ounce of salicylic acid dissolved in one ounce of alcohol and well mixed in one pint of water, and this added to rather thin syrup or honey for feeding at the rate of one pint to four quarts, and then given freely to the colony, has a surprising effect upon the disease and the bees in thoroughly checking—not curing—the former and increasing the prosperity of the latter. One part of carbolic acid or phenol to about 600 parts of such food, syrup or honey is recommended for the same purpose. It is reasonable to suppose that if this sort of feeding prevents the increase of the disease within the hive, as it certainly does, it would certainly prevent its spread to other colonies—a very desirable thing.

It is of the highest importance that every one who keeps bees should become thoroughly acquainted with the characteristics of the disease under consideration in so far as that acquaintance may be had from the description of those who have had experience with it, that he may recognize it at once if it should invade his domain. Prompt efforts on its first appearance would be by far the most effective. Especially should every colony lacking in activity or any other sign of waning prosperity be carefully examined. On the first appearance of the scourge, before the honey containing the spores is scattered through the apiary by robbing or careless handling, it should be stamped out by the most thorough measures. This will be found the cheapest course. Burning utterly every affected colony at this stage, hive, combs and bees, letting no bee escape, will in the end be more profitable than a good crop of honey with traces of the disease retained. In connection the antiseptic food preparation hereinbefore described should be administered freely to every colony and every attention given to the destruction of every particle of the virus. If by ignorance, robbing, or carelessness, many colonies have become affected, then curative measures would probably be preferable, but no less care in mastering directions, and intelligence and energy in applying them, should be exercised than though there were a prospect of the immediate eradication of the disease by more drastic measures.—Review. Lapeer, Mich.

[Remember that Dr. Howard's book on foul brood we mail for 25 cents, or it will be sent with the American Bee Journal one year—both together for \$1.10. Send all orders to the Bee Journal office.—Ed.]



A Prolific Colony of Bees.

BY WM. S. BARCLAY.

If it interests our brother bee-keepers as much to read of a prosperous colony of bees as it does myself, I shall not have written its description in vain.

On May 28, 1895, I hived a very large natural swarm of bees, giving it the stand of the parent colony. On June 27 (just one day less than a month after hiving it) it became so populous that from fear of losing one of my best queens if I permitted the swarm to fly, I took from it a large artificial swarm with the old queen. The product of this swarm may

be recorded as follows: A good artificial swarm, 20 pounds of comb honey, 47 pounds and 11 ounces of extracted honey, 2 combs of sealed brood, and 3 sealed queen-cells, besides 3 or 4 combs of young bees shaken into two weak colonies to strengthen them; this for one living in a location which is not a good one for honey-production, is, I think, a pretty good one; but in fairness I must admit that last season produced a greater honey-yield than usual.

The queen of this colony is from my favorite stock, being as near as I am able to describe about $\frac{2}{8}$ to $\frac{3}{8}$ Syrian, being crossed with my dark or leather-colored Italians, and although not so docile and easily handled, they are by far the most prolific, hardy, longest-lived, and best honey-producers I have had after 35 years' careful breeding and cross-breeding. I have now a bee which comes almost up to my expectations, let it be "Apis Americana" or whatever else it may be termed, and I only regret that it will be difficult for me to procure fresh Syrian blood to further advance this grade of bee.

I had forgotten to state that this variety is much larger and stronger than any other I have ever met.

After an experience of over 40 years, and with all varieties of bees except the Cyprian and Egyptian (and these I do not want), I have no recollection of any colony equal to the one described, if I may except an Italian colony I owned about 25 years ago, when my honey resources were much better than now, and from which I obtained 113 $\frac{3}{4}$ pounds of extracted honey and a large artificial swarm; these were the darker Italians, and although much more gentle and excellent honey-gatherers, they were not nearly so hardy or long-lived as my present stock. I have 4 or 5 queens from this queen almost the equal, and one, I think, superior to the old one.

I should be glad to learn from whom I could renew the Syrian blood in my apiary. Beaver, Pa.



Fifteen Years' Experience in Bee-Keeping.

BY MRS. SALLIE E. SHERMAN.

(Continued from page 435.)

I guess I was one of the first to get and use the Alley drone-trap and queen-cage combined. At any rate, I smothered and killed two colonies of bees before they were beveled or cut away at the edge. You see, they were just left square at the edge next to the hive, so that it completely closed the entrance, and as the weather was intensely hot, they became excited, which increased rather than diminished the heat. When I looked into the hives late in the evening they were a mass of dead or dying bees. I wrote to Mr. Alley about it, and told him what I thought the trouble was. He very generously sent me several of his fine queens to replace those that I had lost from the defective traps, and those that I got of him afterwards were all right, and with me a wonderful success, as it entirely stopped the climbing and mutilating of my nice shade-trees.

I think about as pretty a sight as I ever saw during my 15 years of bee-keeping experience, and during a long, lingering spell of slow fever that my son had during swarming time, was a beautiful, very large swarm of bees that came out and settled on the very topmost limbs of an elm tree in the yard. As soon as I heard them (the hive was near the house) I ran out and put a trap to the entrance so as to cage the queen. I then moved the old hive and put a new one in its place; then placed the trap containing the queen at the entrance of the newly-prepared hive. By the time this was done, the golden beauties came pouring back in a stream from their high perch. It was indeed a sight worth seeing. In 15 minutes from the time I left my sick child, I was back to him again with my bees hived and everything all right. I would just as soon think of going back to the little black bee and

box-hive, as to keep bees without the queen trap or cage. I think that the Italian bee is as far superior to the little blacks as a Berkshire hog is to a razor-back; although I am aware that there are some who prefer the razor-backs and blacks.

Another excellent and useful implement was "the bee-keepers' staff." I had two made according to the directions in the American Bee Journal—one with a pole 12 feet long and the other 16. Sometimes a queen would get out with the swarm, and they would cluster or settle so I could reach them with the short staff, and sometimes I would have to use the long one. I remember on one occasion a swarm came out and left. I was very tired, so I thought I would not bother about them. A close neighbor saw them coming, so she ran out beating a pan, and sure enough they settled quite low. She called to me to come and get my bees; I told her she could have them. "No," said she, "come and get them yourself." I took my short staff, and in a few minutes had them all nicely clustered on it, and brought them home. Just as I was coming down the lane a gentleman, who was coming to the house, saw me with the bees on the staff, and so concluded he had business further up the street, and wouldn't come until he saw that I had them safely in their hive.

It seems to me that there must be an odor left on the tree where bees settle after swarming, from the fact that so many select the same place upon which to settle. In 1888, 37 swarms out of 49 that I had during the season, settled on a gum-elastic tree, at that time about 14 feet high. If it wasn't an odor that caused so many to select not only the same tree, but often the same limb, then I must plead ignorance of the cause.

I am fully satisfied that on one occasion, if not more, I had bees move eggs, not from one part of the hive to another, but from one hive to another, from which they reared four as nice Italian queens as I ever saw. It was this way:

I had made a new colony by division, putting in sealed brood with adhering bees in all the frames except one, in which was fresh-laid eggs from which to rear a queen, as I at that time did not happen to have either a queen or queen-cell. At the proper time I looked in and found a nice lot of ripe cells ready to transfer to other hives, which I proceeded to do, of course leaving one. I did not open the hive again for two weeks, and when I did so, I failed to find either the queen or any eggs. I then closed it, as it was late in the evening, intending to give them a queen the next morning, or eggs from which to rear one; but on the morrow it was raining, and unfavorable weather for several days, so that it was 10 days before I again looked in, then intending to give them a queen; imagine my surprise, upon opening the hive, to find four large, fine queen-cells nearly ready to cap, with not another egg or larvæ in the hive. Now, the question is, Where did those eggs come from? The nearest hive to this one was 12 feet away, and in it were hybrids, and not pure Italians; so they must have been brought from a colony still farther off, as it does not seem at all reasonable that a queen would have entered this queenless hive and laid only four eggs, and then have left. I have had other cases that I had good reason to believe that the bees moved the eggs, but this one instance is enough to go into the details about.

I used to feel anxious to see a laying worker depositing her eggs, but I never had that pleasure but once, although I used to be considerably annoyed by this great nuisance.

The occasion above referred to was inside of one hour after I had removed the queen from my observatory hive. I was very much astonished at this, for I had always thought that it never occurred until the bees were hopelessly queenless. She went at her work, it seemed to me, rather hurriedly, depositing from three to seven and eight eggs in each cell without any apparent system in her work.

As to clipping queens' wings, I must acknowledge that I

have but a limited experience, never having clipped more than about a half dozen, all of which were either killed outright, or balled and superseded in a few weeks. This satisfied me that I wanted no more such mutilation. Thus ended my clipping experience.

I failed ever to find a wooden vessel that held honey to my satisfaction. I had two large honey-extractors, one a two and the other a four frame. I sometimes used one in extracting and sometimes the other. The one I kept in my honey-room I used as a receptacle into which I poured the honey after emptying it out of the one in the bee-tent, in which I had extracted it. I then drew it off into five-gallon square kerosene or gasolene cans, two cans in a case. There, there, don't hold up your hands in holy horror, for they were clean, and never so much as a scent about either the cans or cases. How did I clean them? Well, don't be in such a hurry; just give me a little time, and I will tell you all about it:

You see I never had to pay more than 15 cents a piece, and have bought hundreds of them at 5 cents each. I melted the little piece off, always saving the screw-cap, to be replaced after the can had been thoroughly cleaned and filled with honey, and a nice cork put in the opening. After thus opening the cans, I usually turned them over to Aunt Rachel (a good old darky), who cleaned them with concentrated lye and boiling water, after which I rinsed them thoroughly in clean hot water, drying them with a clean cloth put inside and tossed around so as to get them dry. I then put a little rag in which was tied a table-spoonful or two of parched ground coffee, and let them air for several days. They were then as nice and clean and free from any unpleasant odor as though they had just come from the tin-shop. I paid Aunt Rachel 5 cents each for cleaning them. Thus, you see, they cost me only 10 to 20 cents each when clean. I went to the tin-shop and found that I could not get them made for less than 50 cents each—a saving, you see, of from 30 to 40 cents for each can, which, considering the number I have used, would have amounted to a snug little sum.

The cases were cleaned, aired, and painted with one coat of paint, which added considerable to their appearance.

Bell County, Tex.

[To be continued.]



Those Questions Asked by Mr. Doolittle.

BY EMERSON T. ABBOTT.

On page 324, Mr. Doolittle has asked me a number of questions, the full answer to which would be very much out of place in this or any other journal of apiculture, but as the questions found their way into these columns, I presume I am expected to make some reply. I will do so briefly.

"Why do we have to *push* our interests?" Simply because this is an age of *push*, and nothing goes without *pushing*. I doubt if we are any the worse off for having to push. I have heard a good deal about the good old times when men did not have to push, but I am just enough of an optimist to think these times, taken as a whole, are just about as good as we read about, even though honey did bring 25 cents a pound. I very much doubt if Mr. Doolittle's "me and mine" enjoyed any more real comforts than they do now.

"Will Mr. A. tell us why times are close?" Well, I could tell why I think they are close, but that would open questions which should not be discussed in these columns, therefore I respectfully decline.

"Does he mean that I have no privilege to share his market for honey with him?" No, sir; you are a long way from my meaning. Society, through the enactments of legislators, has encroached so much on the rights of individuals that I am thoroughly convinced that the time has come when individuality should begin to assert itself. The world is every man's

market, and no man, nor set of men, has a right to shut him out of it. No, sir, Mr. D., I do not object to the coming of any one. The freer men are, the better; and being left free, not hampered by useless laws, if I cannot hold my own in competition with the world, if needs be, I am willing to go to the wall. And though I go down and sink into oblivion and eternal forgetfulness, I will not whine.

"Does he not know that bee-keepers are being robbed?" No, I do not know anything of the kind. It is a great deal easier to call men "robbers" than it is to correct the real ills that beset human life. One can sneer about so-called statesmen with much less trouble than he can be a statesman. There is entirely too much of this charging dishonest motives and methods upon men in high authority. God has not left the world to sin and vice, neither are all men corrupt who do not agree with you and me. It seems to me that it becomes men and women who profess to be followers of Him who went about doing good, to look for the bright side of life, and not be eternally holding up the bad, and crying "thief," "robbers," etc. What effect must such tossing about of words and phrases, attributing bad motives to our rulers and law makers, have on the rising generation? It seems to me it cannot be anything but bad.

I trust this cry "in plain language" to the "humble ones," and the great as well, from one who has been a "watchman on the towers of Zion," may have its proper effect, and that hereafter we may believe in real truth, and in the fullest sense that "The earth is the Lord's and the fullness thereof." St. Joseph, Mo.



Wintering on Langstroth Frames on Ends.

BY THOS. THURLOW.

On page 343, Mr. R. L. Taylor's report reminds me that I promised to let you know how my bees wintered on Langstroth frames standing on end, and I will now proceed to do so, as I have kept a memoranda from the time I put them into winter quarters until they were taken down in the spring.

Oct. 15, 1895, there being little brood in the hives, and that capped, and in the central frames, the manner of fixing a hive for winter was as follows:

Taking a hive off of its stand and setting it on the ground alongside, a floor is placed on the stand and then a body put in position; then a bridge $1\frac{1}{2}$ inches wide, on the floor, inside the body at the entrance, then the inside case (which has an inch high entrance across one side at the bottom) is set on the floor close against the bridge, an equal distance from each side of body; the frames are then taken from the hive and carefully set in the case on end, seeing that the queen and all the brood goes along, until full.

(The frames rest on two strips $\frac{3}{8}$ -inch thick, with V's in the top edge, to keep the frames spaced rightly, and are high enough to keep the end of the top-bar $\frac{1}{4}$ inch from the floor, are fastened to the case, and run from front to back, so the frames are crosswise to the entrance, and the case is $\frac{1}{4}$ inch higher than the upper end of the top-bar. The upper end of the frames are spaced with a light strip of wood with notches cut in it, to slip onto the frames easily.)

Another body is then put on, and granulated cork filled in all around, flush with the top of the case; then two or three thicknesses of bagging, cut a little larger than the top of the inside case, are laid on top of the same; then an empty section-case is put on top of the bodies, and a cork cushion put in it; the cover comes last, and one hive is fixed for winter.

The bees remaining in the old hive are brushed down at the entrance, and the spare frames put away for spring.

All my colonies were so fixed, and each had about 15 pounds of honey; that was far from 40 pounds, as B. Taylor recommends in a late number of the American Bee Journal,

but it was enough and to spare, as I have not been able to get all the spare frames of honey left out in the fall back into the hives this spring, but have had to use frames of empty comb to give the queen room.

Last winter was a hard winter here, not much snow, but more than average cold and windy; after the first week in November the bees were not able to fly until Dec. 21, when they had a good flight, and cleaned out their dead, which were very few, and they flew a little until the 30th, after which the next time they got out was Jan. 30, 1896, when they cleaned house and "went to bed" again until Feb. 15, then it was quite warm, and I looked them over. In 12 out of the 14 hives the bees were at the top of the frames, which verifies what I said last year, that bees will get to the top of the frames in winter where it is the warmest, and leave capped honey below them; almost all of them had capped brood.

March was a hard month; the 28th was the next flight they had, then I looked for brood, but found very little; the bees looked bright and dry, the inside of the case perfectly dry, and not a sign of dysentery did I see all winter.

On Nov. 25, 1895, I weighed the hives very carefully, as I was curious to know just what they would lose in their new winter arrangement; on March 28 I weighed again, and this is their exact loss after four months of cold and windy winter:

No.	Nov. 25. lbs.	March 28. lbs.	Loss. lbs.	No.	Nov. 25. lbs.	March 28. lbs.	Loss. lbs.
1.	76 $\frac{1}{2}$	69 $\frac{1}{2}$	7	8.	72	65	7
2.	71 $\frac{1}{4}$	65 $\frac{1}{2}$	5 $\frac{3}{4}$	9.	74 $\frac{1}{4}$	67 $\frac{1}{2}$	6 $\frac{3}{4}$
3.	69	62	7	10.	74 $\frac{1}{4}$	67 $\frac{1}{2}$	6 $\frac{3}{4}$
4.	70	62 $\frac{3}{4}$	7 $\frac{1}{4}$	11.	68 $\frac{3}{4}$	62	6 $\frac{3}{4}$
5.	69 $\frac{1}{2}$	62 $\frac{3}{4}$	7 $\frac{1}{4}$	12.	71 $\frac{1}{4}$	64 $\frac{3}{4}$	7
6.	66 $\frac{1}{2}$	59	7 $\frac{1}{2}$	13.	75 $\frac{1}{4}$	68	7 $\frac{1}{4}$
7.	72 $\frac{1}{4}$	64	8 $\frac{1}{4}$	14.	70 $\frac{1}{4}$	64 $\frac{3}{4}$	5 $\frac{1}{2}$

The average loss was 7 pounds, or only 2 $\frac{3}{4}$ pounds between maximum and minimum loss, and wintered on dark fall honey.

Now, what do you think? Is it a good plan for wintering, or no better than many others? I have never seen anything in the American Bee Journal that I remember equal to it.

This has been a poor spring here for bees; they get very little honey from red maple, fruit-bloom or locust, and the nights have been so cool all along that brood-rearing has been kept back more than I ever knew before. White clover has now been in bloom two weeks, and there is no surplus honey yet; if the weather prophet does not give us hot weather pretty quick, the honey crop in this vicinity will be *non est*.

WIRING BROOD-FRAMES.—I don't know how other people string wire into brood-frames, but I invented this plan, and the wire does not kink and bother:

First, string a frame, then take the wire out, then take a strip of board about an inch square, a little longer than the wire (say 6 inches), drive two wire nails near each end, just the length of the wire apart, take a spool of wire, fasten the end to one nail and wind round from nail to nail as many lengths as you want, and fasten the end; then take any kind of a string and wrap around the stick and wire from nail to nail about a dozen turns, and fasten; then cut all the wires on the outside of the nails; tack the strip to the edge of a bench, wire up, clamp a brood-frame to the bench at the end of the strip, draw out a wire, and string into the frame as you draw out.

TIGHTENING SECTIONS IN CASES.—The book says to tighten sections in cases "put a wedge between the follower and side of the case." Don't do that. Use a piece of light band-iron about $\frac{3}{8}$ inch or $\frac{1}{2}$ inch wide, and about 7 inches long; bend it in the middle flat ways, so it will be in the shape of two parentheses, convex sides outwards; two for each case, between the follower and side of the case; they allow the sections to swell or shrink as the weather pleases,

and still just keep tight together. They can be pulled out easily with a nail or anything that will hook into the loop.

ADULTERATION AND LOW PRICES.—If eternal vigilance is the price of liberty, so constant hammering at adulteration will eventually give laws stringent enough to stop the most of it, and that will give us a little better price for honey. Comb honey is a luxury, and the working class are a little short of money just now, hence less demand and lower price.

Lancaster, Pa., June 15.



Hunting Wild Bees—An Experience.

BY C. F. ZIOLER.

I have been hunting wild bees since I was a boy 12 years old, and will tell somewhat of my experience last year.

Myself and a friend located and cut 16 wild bee-trees last fall. I use a box with a sliding lid to keep the bees in while carrying them from one point to another. I then find bees working on flowers, or bloom, of some kind (sumac and buckwheat being my favorites). I have a bottle of extracted honey, also another small bottle about one-half full of water, which I fill with honey, and shake well, with just a scent of oil of anise. I then take a mouthful of this mixture and blow it over a few bunches of flowers, that I see the bees are working the most on, then I sit down and watch the bees working till I have a direct course, or line, which won't take long if done in the way above mentioned.

After watching them carefully, and having obtained a straight line, I cut off these few bunches of flowers and carry them to some point where I can hide, or destroy them from the notice of the bees; and in a few minutes I am ready to start after the line, for as soon as the bees can find no more of this mixture on the flowers, they will go into the box; so in this way one will have no trouble at all to get the bees to work in the box from the start, for all experienced bee-hunters know that it is a very hard matter at times to get bees off of flowers and get them to work in a box on comb containing pure honey, or sugar syrup, as the strange smell of the combs, etc., make the bees very shy, but experience has taught me that to take pure honey and make it half water it comes nearer being the same as the bees are gathering from the flowers, and they will load much quicker than from pure honey, and it is not nearly so sticky—they never get daubed as much as they do from pure honey or sugar syrup.

Now, all you have to do is to follow up this line until you find where the colony is; but sometimes this becomes a very trying piece of business, and gets very interesting before one gets through with it, as it did in one case with me last summer, which I wish to relate:

It was a beautiful morning, July 24, that myself and friend started out to see if we could locate a colony of wild bees. We went $3\frac{1}{2}$ or 4 miles away to some old fields, and found bees working on sumac blossom; it didn't take long to start the bees, and get a straight line, which, without a doubt, would prove to be a colony of wild bees. We had a mountain to cross, and therefore we tried to get as many bees as possible before starting, as it generally is a pretty hard matter to get bees to come down as you go up a mountain, but in this case it didn't prove very hard, and we followed them until sundown, taking them over two miles from where we started them the first day.

The next morning we started early, taking everything we needed to cut a bee-tree, and have a colony of bees with, for we expected to find it in a short time, for we thought we were close to the colony when we left off the evening before.

But to our surprise we took it over two miles further—in all over four miles from where we started it; but we failed to find it until 6 o'clock that evening, and after looking at all

the trees for a circle of three-fourths of a mile around, and even looking in the rocks and at the old logs, I found the colony hanging on a limb in the top of a large tree, and if it had not been for the noise of the bees, we would not have found them that day.

We then came to the conclusion that some one had found the colony before, and not caring for anything but the honey, they had left the swarm in the woods, and it had settled on this tree; but after looking closely we were still more surprised to see the beautiful white comb they had built, shining through the bees. We then cut the tree down, and secured between 30 and 35 pounds of fine honey, being gathered chiefly from wild raspberry, and it having built comb 2 feet long and from 10 to 12 inches deep; I hived the swarm, brought it home and transferred it to a hive filled with comb, and so far have it living yet.

Hunting wild bees is a trade in itself, and it matters not how much knowledge one has of bees, if he never hunted them any to get the theory or idea, I am sorry to say, he will never make much headway at the business.

I find great sport and enjoyment in looking through the woods in the summer and fall, in hunting for wild bees, and I am never so happy as when working with these busy little creatures.

Waterside, Pa.

Questions AND Answers

CONDUCTED BY

DR. C. C. MILLER, MARENGO, ILL.

[Questions may be mailed to the Bee Journal, or to Dr. Miller direct.]

Shady Places for Bees.

1. Can there be too shady a place for bees?
2. Is there any danger of comb becoming moldy in a hive on a stand say 6 or 8 inches up from the ground where it is so shady no grass or any other weeds will grow? E. A. W.

ANSWERS.—1. A place can be made so shady as to be dark as in a cellar, but I can hardly think any growth of trees or vines can be so dense as to make it too dark for the bees. But there may be such a dense growth on all sides that there is too little circulation of air about the hives. I once had combs melt down in hives upon which the light of the sun never directly shone. There was such a dense growth on all sides that there was very little stir of air, so the combs melted down with the heat.

2. There is no danger under ordinary circumstances. For several years I kept an out-apiary in an evergreen grove, and the dense shade allowed no grass or weeds to grow, but there was no trouble from mold or anything else. But there was full chance for the air to move under the trees. It is barely possible that some peculiar spot might be so close and damp as to favor the growth of mold.

Now the way is open if any others have more light to give on this shady question.

A Mixed-Up Colony—Holy-Lands.

1. I have a black colony, black queen and all. Now this spring some of her bees were dark black, some a little light, and others 5-banded, just like Italians. What kind of a colony would you call that?
2. In April I took from it 6 frames of bees and brood, and put it in an empty hive and set it off by itself in a corner.

In due time a queen hatched, and is now laying as good as any others, but she is just like an Italian queen, a bright leather (yellow) color almost to the tip of her tail, and *all* of her bees are characterized with the five bands, a bright yellow color just like some of my Italians. What is the second one—black, hybrid or Italian?

3. Why is it that the bees that work on foundation are so long and slim, while those that are on the brood are so plump and fat looking?

4. What is a "Holy-Land" bee? Can they be bought in this country? J. B. D.

ANSWERS.—1. I should be inclined to think that last year, perhaps in the fall, a young queen had been reared, and had mated with a yellow drone, thus making a hybrid colony from which you might expect to find workers of various shades.

2. Certainly it isn't black. And if all the workers are yellow it's hard to call it hybrid. It's barely possible that a young queen from some yellow colony flew into the hive and was accepted, for virgin queens have a way of going to other hives than their own.

3. I don't know. I never noticed that difference.

4. The Holy-Land bee comes from Syria, and is also called Syrian. It is doubtful if you can, at the present time, find any pure Holy-Lands in this country. Years ago they were brought into this country, but no one seems to have cared enough for them to continue them in their purity.

Late Preparation of Bees for Winter.

1. I can get a number of colonies of bees given to me by people who keep them in box-hives, about Oct. 1, 1896. If I transfer them into dovetailed hives on full sheets of foundation, and feed them sugar syrup with a Miller feeder, will they draw the cells during the months of October and November, and carry the syrup below?

2. How many pounds of syrup will each colony require to winter them?

3. I have a new stone building with 18-inch walls; inside measurements are $5\frac{1}{2} \times 5\frac{1}{2} \times 6\frac{1}{2}$ feet, pitch roof, under side of rafters lathed and plastered, a vent hole 4x6 inches in the east gable end; doors $2\frac{1}{2} \times 3\frac{1}{2}$ feet, out and inside, facing the west, quite tight-fitting. Will this be all right to winter 30 colonies of bees in 8-frame dovetailed hives, tiered up? Would you advise the enamel cloth alone or chaff cushion?

4. Shall I use thick or thin syrup? P. O.
Northampton, N. Y.

ANSWERS.—1. That depends on the weather. If it's warm enough there will be no trouble about it, but if the weather continues so cold that bees will not fly you can't get them to work out their combs. In August or September it's fun to see how nicely they'll fill and cap combs from foundation, and if you can have weather warm enough in October they may do just as well then. But you'll not always get the weather.

3. That depends somewhat on the size of the colony. Fifteen pounds of granulated sugar may take a fair colony through, but if they can be got to take 20 it will be better.

3. Such a building will do finely under ground, but above ground it will be pretty sure to prove a failure. The thick walls will help to keep a steady temperature, but it will be steadily cold, and a steady temperature of 30° is worse than to have it part of the time at 10° and part of the time at 50°. The enamel cloth alone, or a board cover alone, is all right if the bees are in a cellar that is warm enough and have abundant chance for ventilation below. But it ought to be pretty warm for enamel cloth. It's just the least bit like a metal surface, and the moisture from the bees condenses on it and drops down on the bees. For a colder place the chaff cushions would be safer.

4. For feeding in October it will be probably necessary to have the syrup thick, for if fed thin there will be too little time for the bees to thicken it. And yet it seems to work better toward working out combs if the syrup is fed thin. Very likely, too, the bees will make some change in the character

of the stores when fed thin that they cannot so well make when fed thick. I suspect that thick syrup would have less formic acid put in it than thin, and that stores made from thin syrup in hot weather would be healthier for the bees than thick syrup fed in cool weather.

On the whole, it is somewhat doubtful if you can make a great success of October-made colonies. I'll tell you what I should do if I wanted to take bees in October to prepare for winter: I'd commence to get ready for it as early as August, and I'd have the combs of sealed stores all ready to put them on in October. I'm taking it for granted that you have colonies of bees in frame hives that can be used to get ready the combs. If they are getting a flood of honey in August, well and good, let them fill up and seal combs to be ready for October. But as soon as forage becomes scarce, put on your feeders and set them to work, not on sugar syrup, but on sugar and water, and plenty of water.

You can use the crock-and-plate method that has been described more than once in these columns, but as you have Miller feeders you can use them, and except for the matter of expense I much prefer the feeders. Stuff rags in the cracks left for the passage of the syrup from one compartment to another, so that grains of sugar cannot pass through, but not so tight as to stop passage of water at least slowly. Put into the feeder the sugar, then pour water on it. It isn't so particular what proportion of water you use. Better pour on just a little at first, say a tenth as much water as sugar, and let that stand a quarter or half an hour before putting in more. If you put in a big lot of water at first, it will run through clear before it has time to dissolve the sugar, and there will be so little sweet in it that the bees will not take it. But put in a little at first and that will get the sugar partly dissolved, and then you can pour in more. If there is room for it in the feeder, you may put in as much as a pint of water for every pound of sugar, but it doesn't matter if you put in less, for you can fill in more water as fast as the bees use it out.

With combs got ready in this way you may have a good deal fairer prospect of success than to attempt to get combs built in October. Of course, you will put your bees on these combs, and you will do well to be sure to give them plenty.

Growing Too Fast—Queen-Rearing.

This is my first year in bee-keeping, and I find it easy to succeed. I have now 12 colonies, and I intend to increase to 100 for next year, partly by buying, and then go to queen-rearing. Do you think that will be going too fast?

C. B.

ANSWER.—Very decidedly I should say that as a rule no one is likely to be able to run very successfully 100 colonies in his second year. I don't say the thing can't be done. It might be, but the chances are very much the other way. Neither is any one likely to be a successful queen-breeder in his second year. At least I'd rather not buy queens from him. And there isn't such a bonanza in queen-rearing as some think. The business is probably much overdone. Taking into account the failures and perplexities connected with the business, I'd rather stick to honey-production.

A New Binder for holding a year's numbers of the American Bee Journal, we propose to mail, postpaid, to every subscriber who sends us 15 cents. It is called "The Wood Binder," is patented, and is an entirely new and very simple arrangement. Full printed directions accompany each Binder. Every reader should get it, and preserve the copies of the Bee Journal as fast as they are received. They are invaluable for reference, and at the low price of the Binder you can afford to get it yearly.

OLDEST BEE PAPER IN AMERICA ESTABLISHED IN 1861

THE AMERICAN BEE JOURNAL

GEORGE W. YORK. Editor.

PUBLISHED WEEKLY BY

GEORGE W. YORK & COMPANY,

118 Michigan St., CHICAGO, ILL.

REGULAR CONTRIBUTORS:

G. M. Doolittle, of New York. Prof. A. J. Cook, of California.
 Dr. C. C. Miller, of Illinois. Rev. E. T. Abbott, of Missouri.
 Barnett Taylor, of Minnesota. Mrs. L. C. Axtell, of Illinois.
 Chas. Dadant & Son, of Illinois.

\$1.00 a Year—Sample Copy Sent Free.

[Entered at the Post-Office at Chicago as Second-Class Mail-Matter.]

Vol. XXXVI. CHICAGO, ILL., JULY 16, 1896. No. 29.

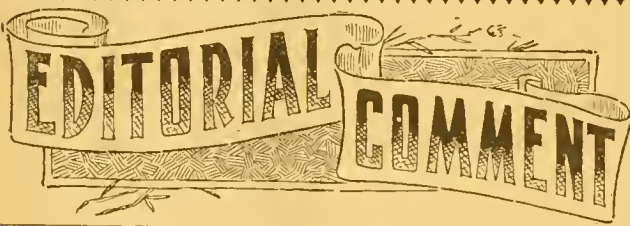

The Honey Crop for 1896.—We called on Messrs. R. A. Burnett & Co., of this city, on July 7, and in conversation with Mr. Burnett, he had this to say about the present honey crop:

"The prospects are that the largest flow of honey ever secured east of the Rocky Mountains to the Atlantic coast will be obtained this season. Some of the harvest is now on the market, selling in a small way at the prices given in our market quotations."

This is the judgment of the oldest and most extensive honey-dealer in Chicago—a man who, though very quiet, keeps in touch with the honey-producers all over the country. He makes no great boasts as do some, but "gets there just the same," when it comes to handling honey, hence his estimate of the amount of honey in the country this year ought to be somewhat reliable.

In view of the above, producers should exercise great care not to flood any one market with honey, and thus break down prices. Neither should they neglect near-by markets and ship to a distance. This year, as in every year, the home demand should be carefully met first, and then if there still be a surplus, ship it to the nearest reliable dealer to sell, unless you are very certain a far distant dealer will net you better returns.

The North American Program.—The following has come to hand from the Secretary of the North American Bee-Keepers' Association:

STATION B. TOLEDO, Ohio, July 10, 1896.

MR. EDITOR:—The fixing of the time for the meeting of the North American Bee-Keepers' Association at Lincoln, Nebr., has been left, by the Executive Committee, with the Nebraska bee-keepers, so that they may be able to arrange for reduced railroad rates, and in a letter just received from Mr. L. D. Stilson, of York, Nebr. (Secretary of the Nebraska State Bee-Keepers' Association, who has the matter in charge), he says:

"I have been to Omaha to see the railroad people who promised to let me know July 1, but no satisfaction yet as to rates or dates. . . . I will write you at the earliest moment, when I know the dates. They gave me dates for our Horticultural meeting more than 90 days before the meeting."

I was hoping to get the program for the meeting in all the

July hee-journals, but have waited so as to get the time set. So far as arranged for, the following can be announced:

The Past and Future of Bee-Keeping—Mrs. J. N. Heater, of Columbus, Nebr.

Bee-Keepers' Exchange—Prof. A. J. Cook, of Claremont, Calif.

The Wild Bees of Nebraska—Prof. Lawrence Bruner, of Lincoln, Nebr.

Improvements in Bee-Culture—Ernest R. Root, of Medina, Ohio.

Some of the Conditions of Nebraska—L. D. Stilson, of York, Nebr.

The Union and Amalgamation—Thomas G. Newman, of San Diego, Calif.

Economic Value of Bees and their Products—C. P. Dadant, of Hamilton, Ill.

Artificial Heat and Pure Air, Properly Applied in Wintering—R. F. Holtermann, of Brantford, Ont.

The Honey-Producer and Supply-Dealer—Rev. Emerson T. Abbott, of St. Joseph, Mo.

An original poem by Hon. Eugene Secor, of Forest City, Iowa.

Importance of Watering in the Apiary—Hon. E. Whitcomb, of Friend, Nebr.

Honey Adulteration and Commission—George W. York, of Chicago, Ill.

Sweet Clover as a Honey-Producing Plant—Wm. Stolley, of Grand Island, Nebr.

The President, Mr. A. I. Root, will give an address, and it is expected that "Somnambulist" will be present with one of her inimitable papers, but as she must now be asleep, I have not been able to learn the subject of it.

It is the present intention to devote most of the second evening session to an address of welcome by the Hon. Geo. E. McLean, Chancellor of the Nebraska State University, with a response by Hon. Eugene Secor, of Iowa. The Hon. Alvin Saunders, an old-time bee-keeper and a War Governor of Nebraska, will also address the convention, and if time will allow, other addresses will be made or papers read.

A. B. MASON, Sec.

You Will Make a Mistake if you do not read all of page 463, and take a part in extending the circulation of the American Bee Journal; and also earn some of the premiums offered for getting six-months' subscribers. Then, too, you might easily get a share of the \$25 in cash that we offer. Remember, the contest ends Sept. 1, only 6 weeks yet. Many are at work, and you have an equal chance to be the lucky one. You will find that a ten-dollar bill, or a five, would come in handy. Better try for it.

Your Experience in bee-keeping is always in order in these columns. We trust none of our subscribers will wait for a personal invitation to write out and send us what they have learned in practical work with the bees. Remember that the American Bee Journal is yours for the interchange of apiarian ideas and results of actual experience. We try to give everybody a fair chance to "have their say" when it has direct application to bee-keeping. While we never lack for material for our columns, there is always room for more contributions that tend to the assistance and real advancement of practical apiculture.

Bees and Agriculture.—In The Spectator—a California periodical—was published a short time ago a story of an old man and his faithful companion who lived high up on the mountain side. Their only occupation was that of keeping bees, from the products of which they were enabled to live comfortably.

In the valley below were a number of farms and orchards. In the summer-time the bees from the mountains visited the valley and gathered large quantities of honey from the blossoms of the apple, the clover, and the corn, in turn scattering the pollen and more effectually fertilizing the flowers, enabling the farmers to gather abundant harvests. In the fall, when the bees could no longer gather nectar from the flowers,

they visited the cider-press, and often sipped the juice from the grapes that had burst from over-ripeness, or which had been punctured by other insects or the birds.

The farmers regarded the little bees as great pests, and demanded that the old man must abandon his occupation. Failing to comply with their demands, they set fire to his little apiary, and barely escaping with his life himself and companion went to dwell in another country.

The next year the crops were shorter than ever before; the clover yielded only a half crop of seed, the fruit was scrawny, and the ears of corn were not so full and plump as usual.

In the old man's deserted little garden there chanced to fall a single seed of Canada thistle. It grew and multiplied a thousand fold. The next year the increase was a thousand times a thousand. When the autumn winds blew from the northwest the thistle-down was scattered broadcast over the farms in the valley, and ere the farmers were aware their land was beyond redemption.

The thistles and mortgages took the farms, and their once prosperous owners moved away.

The old man returned with his bees to his mountain home. The product of his apiary was two-fold as much as ever before. But the bees gathered not the honey from the clover and the corn, but from the thistles, and Spanish-needles, and golden-rod and blackberry vines that had taken possession of the valley farms.

There should be no conflict between bee-keepers and farmers or fruit-growers, but each should welcome the other, and thus be mutually helpful. How often has it been shown that bees are almost invaluable in the fullest pollination of the blossoms that ultimately produce fruit in abundance, and which without their aid might yield but little, if any.

PERSONAL MENTION.

MR. A. H. DUFF, of Larned, Kans., is now in charge of "The Apiary" department of the *Kansas Farmer*. He makes a good sub-editor.

MR. ANDREW SNYDER, of Cooper, Mich., dropped into our office for a few moments last week. He was on his way home, having spent several weeks in traveling about the country.

MR. C. S. FRENCH, of Minnesota, when renewing his subscription lately, said: "I can't afford to do without the *American Bee Journal*, as it is my main companion in the apiary."

EDITOR HUTCHINSON, of the *Review*, attended the May meeting of the Philadelphia Bee-Keepers' Association, having had a special invitation to be present and "give them a talk on honey-production and answer such questions as they might wish to ask." Mr. H. gives a lengthy account of his trip in the June *Review*.

MRS. EFFIE BROWN, of Eau Claire, Wis., is the much-awake editor of the bee-department in the *Northwestern Agriculturist*. We recently received this kind letter from her:

EAU CLAIRE, WIS., June 25, 1896.

MR. GEO. W. YORK, *Dear Sir*:—My last copy of the *American Bee Journal* has just been opened, and though it is the busiest time in the year with us bee-keepers, I feel it my duty to stop long enough right now to tell you that every copy of your paper seems to be better than the one before. I sub-

scribe regularly for 11 different papers, magazines, etc., and I don't think any one of them is so full of meat as the *American Bee Journal*. I am trying the work of bee-editor myself on a very small scale, and now as I look your work over I can hardly see how you manage it all so well.

We are having an exceptionally good honey season this year. I never saw more white clover or better Alsike than is found all around us. Basswood is two weeks early this year, and looks as though it would yield well. Bees are bent on swarming more or less, for with such a heavy honey-flow and hot weather, some colonies will boil out in spite of anyone's managing.

Wishing you a heavy "flow" of new subscribers, I am,
Yours respectfully,
MRS. EFFIE BROWN.

Thank you, Mrs. B., for your good wishes. And success to you in all your labors.

MR. ALFRED H. NEWMAN, of Cedar Rapids, Iowa, called on us July 6. He is the manager of the successful Cedar Rapids Candy Company. But most of our readers will remember him as the junior member of the firm of Thos. G. Newman & Son, publishers of the *American Bee Journal* for 19 years prior to June 1, 1892.

REV. EMERSON T. ABBOTT, of St. Joseph, Mo., has engaged again to go next fall on the Missouri Farmers' Institute force, to talk on "Agricultural Education in Common Schools," and on bees and poultry as opportunity offers. He fears this may prevent his being at the Lincoln convention of the *North American*, but we hope not. Mr. Abbott always helps to make things lively at a bee-convention, when he can be present. He must not miss that Lincoln meeting, as it is expected to be a "whopper." Those Nebraska folks are hustlers.

MR. MARTIN BROCKMAN, of 308 Abigail St., Cincinnati, Ohio, has, we are informed, been soliciting consignments of honey. Mr. Byron Walker, after he had, as he thought, taken due precaution as to his commercial standing, filled an order for him for some \$73.00 worth of honey. Mr. Brockman, acknowledging the receipt of the honey, stated that it was very satisfactory, and ordered more. Mr. Walker, again making further inquiries, decided not to make the second shipment. After writing him a number of times regarding honey already sent, and getting no response, he received notice from the commercial agencies that Mr. Brockman was irresponsible.—Gleanings.

MR. J. S. HARTZELL, of Addison, Pa., in a letter dated July 6, says these true words about bee-keepers and the literature devoted to their interests:

Persons generally keeping a few bees are not interested as they should be in bee-literature, and, in fact, farmers not one in ten take an agricultural paper, and therefore the farming is in proportion to their own knowledge of the business, and by not keeping pace with efforts made on scientific principles of our agricultural stations and of which the majority of farmers are ignorant. The same applies to our apicultural friends. Great lessons are learned in every issue of our bee-literature, as well as agricultural periodicals, and I would not undertake to do without one or two bee-papers as long as I keep in the bee-business.

A NEW YORK SUBSCRIBER (we omit his name) who was quite a good deal in arrears on his subscription, recently paid up and in advance; and when doing so he wrote:

"MR. YORK:—We think that you must be a very patient man...or you would be after some of us with a sharp stick."

We wish that all who are behind on their subscription would imagine that a "sharp stick" is coming after them, and pay up and ahead. A great many very good people become careless, or overwork their "forgettery," and consequently the publisher of their paper has to suffer. Now, friends, if you are in arrears to the *Bee Journal*, suppose the next time you go to the post-office, you send us a couple dollars, as did the subscriber above referred to. At the same time perhaps you can send along several 40-cent subscriptions of your bee-keeping neighbors. See offer on page 463.

AMONG THE BEE-PAPERS.

Number of Pounds in a Day.

It is impossible to give a definite answer as to how much a colony of bees weighing a given amount will bring in pounds of honey per day. There are so many conditions to be taken into account, such as the weather, the kind of bees, the strength of the colony, the source of the honey-flow, and the strength of it. A good colony, however, will gather from one to five pounds of honey per day from clover in a fair flow, and from one to 10 pounds from basswood; and strong colonies have been known to store even as much as 20 pounds in a day. But such instances are exceptional.—Gleanings.

"Some Don'ts" for Honey-Buyers.

Don't buy honey that has stood in the open air, especially in a damp climate. The cappings of comb honey are very porous and affected by all strong smelling and damp surroundings; consequently, do not use honey that is kept near tobacco, salt or smoked fish or meats, candles, etc.

Don't buy honey in which any comb is immersed, for pure extracted honey does not need comb in it to deceive the eye, for it appeals to the palate as well as the eye.

Don't use strained honey, as it is squeezed from the comb in which dead bees, larvæ, pupæ, the bee-moth's larvæ, and even worse, are present.

Don't think that honey is expensive, as one quart of honey is equal to five or six pounds of butter in lasting and food results.

Don't forget that cheap syrups (and some expensive ones) bring you two unwelcome visitors—first the doctor, next the undertaker.

Don't buy honey without the label of some apiarist, producer, or reliable firm.

Don't stay without honey when you can get a pure, ripened and wholesome article at a fair price.

Don't leave your extracted or comb honey open; cover it.—Extract from a "Honey-Leaflet" published in the Bee-Keepers' Review.

The Elwood Method of Dequeening.

About the time when the colonies become so crowded with bees and honey that there is danger of their getting the swarming-fever, and, preferably, before that troublesome disorder has actually begun to make them dissatisfied, the apiarist hunts up the queen in each hive; he takes one or two combs, with some hatching brood, and adhering bees enough to make a small nucleus, and hangs them in a nucleus hive, which stands near the colony, and the queen is placed on these combs, to be kept in the nucleus until she is needed again. Nine days after this operation the dequeened hive is carefully gone over and every queen-cell removed from the combs. The colony is now *hopelessly queenless*—that is, there remains, at this time, only sealed brood in the hive, from which it is impossible for the bees to rear a queen. In this hopeless state the bees are left for a week or ten days, when the old queen is re-introduced into the hive.

During the nine days succeeding the

THE "NOVELTY" POCKET-KNIFE!



Your Name on the Knife.—When ordering, be sure to say just what Name and Address you wish put on the Knife.

The **NOVELTY KNIFE** is indeed a novelty. The novelty lies in the handle. It is made beautifully of indestructible celluloid, which is as transparent as glass. Underneath the celluloid, on one side of the handle is placed an **AMERICAN BEE JOURNAL** reminder, and on the other side, name and residence of the Subscriber.

The material entering into this celebrated knife is of the very best quality; the blades are handforged out of the very finest English razor-steel, and we warrant every blade. The bolsters are made of German silver, and will never rust or corrode. The rivets are hardened German silver wire; the linings are plate brass; the back springs of Sheffield spring steel, and the finish of handle as described above. It will last a lifetime, with proper usage.

Why purchase the Novelty Knife? In case a good knife is lost, the chances are, the owner will never recover it; but if the Novelty is lost, having name and address of owner, the finder will return it; otherwise to try to destroy the name and address, would destroy the knife. If traveling, and you meet with a serious accident, and are so fortunate as to have one of the Novelties, your pocket KNIFE will serve as an identifier; and in case of death, your relatives will at once be apprised of the accident.

How appropriate this knife is for a Christmas, New Year or birthday present! What more lasting memento could a mother give to a son, a wife to a husband, a sister to a brother, a lady to a gentleman, or vice versa, a son to a mother, a husband to a wife, a brother to a sister or a gentleman to a lady—the knife having the name of the recipient on one side?

The accompanying cut gives a faint idea, but cannot fully convey an exact representation of this beautiful knife, as the "Novelty" must be seen to be appreciated.

How to Get this Valuable Knife.—We send it postpaid, for \$1.00, or give it as a Premium to the one sending us three new Subscribers to the BEE JOURNAL (with \$3.00), and we will also send to each new name a copy of the Premium Edition of the book "Bees and Honey." We club the Novelty Knife with the BEE JOURNAL for one year, both for \$1.90.

Any Name and Address Put on the Knife.

GEORGE W. YORK & CO., CHICAGO, ILLS.

Allow about two weeks for your order to be filled.

PATENT WIRED COMB FOUNDATION

Has No Sag in Brood-Frames

Thin Flat-Bottom Foundation

Has No Fishbone in the Surplus Honey.

Being the cleanest is usually worked the quickest of any Foundation made

J. VAN DEUSEN & SONS,

Sole Manufacturers, Sprout Brook Montgomery Co., N. Y.

Mention the American Bee Journal

Dadant's Foundation in Chicago!

No other Goods kept here.

Send for Price-List,

CHAS. DADANT & SON, 118 Michigan St., CHICAGO, ILL. 13Atf Please mention the Bee Journal.



ONE MAN WITH THE UNION COMBINATION SAW

Can do the work of four men using hand tools, in Ripping, Cutting-off, Milling, Rabbeting, Grooving, Gaining, Dadoing, Edging-up, Jointing Stuff, etc. Full Line of Foot and Hand Power Machinery Sold on Trial. Catalogue Free.

SENECA FALLS MFG. CO., 46 Water St., SENECA FALLS, N. Y.

1A1y Mention the American Bee Journal.

Untested Italian Queens, 75c.

3 FOR \$2.00.

Catalogue of Apiarian Supplies Free.

I. J. STRINGHAM,

105 Park Place. NEW YORK, N. Y.

APIARY—Glen Cove, L. I.

That Queen-Clipping Device Free!

Works Like a Charm.

The Monette Queen-Clipping Device WORKS LIKE A CHARM. With it I have clipped 30 queens, all in one day, when examining my bees. WM. STOLLEY, Grand Island, Nebr.

Couldn't Do Without It.

I have clipped 19 queens, and must say the Monette Queen-Clipping Device is by far the best invention ever made, and will be welcome to many bee-keepers as it was to me. I could not do without one now.

DR. GEO. LACKE, Newburgh, Ind.

PLEASE READ THIS OFFER TO PRESENT SUBSCRIBERS:

Send us just one new name for the American Bee Journal a year (with \$1.00), and we will mail you the Queen-Clipping Device FREE of charge. Or, the Queen-Clipping Device will be sent postpaid for 30 cts. But why not get it as a Premium by the above offer? You can't earn 30 cts. any easier. Almost every bee-keeper will want this Device. See page 130 (Feb. 27) for full description of it. Complete directions accompany each one sent out. It is a most ingenious and useful article. Address,

GEORGE W. YORK & CO., 118 Michigan St., Chicago, Ill.

❖ MONEY SAVED IS MONEY GAINED. ❖

THE ROYAL UNION Life Insurance Company

DES MOINES, IOWA.

The Iowa Policy

Is one that definitely promises to keep an accurate account with you; credit your premiums and interest, charge the actual expense and mortality cost, and hold the remaining funds subject to your order. Agents Wanted.

JOHN B. KING, GENERAL AGENT.
Suite 513 First Nat'l Bank Bld'g,
20Att CHICAGO, ILL.

WARRANTED GOLDEN

ITALIAN QUEENS By return mail; bred from a Breeder tested by DoLittle out of 1,000 Queens for his own use, and valued at \$50. Queens, 50c; 6 for \$2.75; or \$5.00 per dozen.

Leather Colored Queens from Root's best imported stock same price. Bees from my Queens are excellent workers on red clover. I guarantee safe delivery. N. B.—I sent more than 200 Queens safely to California last season.

H. G. QUIRIN, Bellevue, Ohio.
23A16 Mention the American Bee Journal.

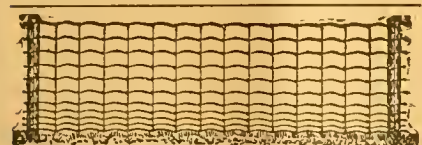

Why Did They Do It?

George H. Curtis, farmer, lives 2 1/2 miles from Adrian. Eight years ago put up Page fence along the highway. This spring he took it down and replaced it with a Page of finer mesh to match his elegant dwelling. Three times he was offered half price for the old fence, by as many different farmers, who had seen it in service all that time.

See picture in Hustler.
PAGE WOVEN WIRE FENCE CO., Adrian, Mich.
WHEN ANSWERING THIS ADVERTISEMENT, MENTION THIS JOURNAL.

IF YOU WANT THE BEE-BOOK

That covers the whole Apicultural Field more completely than any other published, send \$1.25 to Prof. A. J. Cook, Claremont, Calif., for his

Bee-Keeper's Guide.

Liberal Discounts to the Trade.

California

If you care to know of its Fruits, Flowers, Climate or Resources, send for a Sample Copy of California's Favorite Paper—

The Pacific Rural Press

The leading Horticultural and Agricultural paper of the Pacific Coast. Published weekly, handsomely illustrated, \$2.00 per annum. Sample Copy Free.

PACIFIC RURAL PRESS,
220 Market St., - SAN FRANCISCO, CAL.

TEXAS QUEENS.

If you are in need of Queens, let me have your order. Price-List Free.

8A26t J. D. GIVENS, Lisbon, Tex.
Mention the American Bee Journal.

READERS Of this Journal who write to any of our advertisers, either in ordering, or asking about the Goods offered, will please state that they saw the Advertisement in this paper.

removal of the queen, and while the construction of queen-cells goes on, there is no noticeable slacking-up in the work of the bees. They seem to work on, so far as I can see, about as contentedly as if they had their queen among them. But after the destruction of the queen-cells there is a noticeable let-up in the energies of the bees. After the queen has been re-introduced into the hive, and she has been accepted, and has commenced to lay, the bees begin to work with much more energy and vim. There being plenty of empty cells in the combs, the queen can exercise her laying powers to the fullest extent, and all desire to swarm is for the time being expunged. If some honey has accumulated in the cells from which young bees have emerged, it will be removed by the workers into the sections, to give room to the queen. As the full strength of the colony, excepting the bees taken for the nucleus, has been held together, and even constantly augmented by the hatching brood, the colony is in good condition to store honey. The season of comparative sluggishness during the hopeless period is, under natural swarming, often equaled by the sulkiness of the bees, which sometimes seem to be unable to make up their mind as to whether they want to swarm or not, during which time of indisposition they do no work.—T. H. KLOER, in Gleanings.

Starters vs. Full Sheets in Sections.

A fact that is pretty well recognized among comb-honey producers may perhaps be touched upon here by way of confirmation. When we put up supers containing sections for general stock, only small starters are used, for the reason that full sheets would not ship. Well, during the last few days during the pinch we had to use something that was right ready, and accordingly a number of these supers were used; but as soon as our employees in the factory could get at it they fixed up supers containing full sheets. It was evident that the bees accepted the latter much more readily; and it was evident, also, that partly drawn-out sections shaved down a la Taylor were much more readily accepted yet. B. Taylor's idea of using natural comb shaved down by means of a comb-leveler is all right.—Gleanings.

Sweet Clover for 1896.

Although sweet clover has, in the last few years, been spreading enormously along the highways and railroad-cuts, it seems to be making unusual spread and growth this year. The majority of people consider it as a noxious weed, notwithstanding it makes a fine hay for stock, and that it seldom if ever grows on cultivated lands. Its vigorous growth and rapid spread over the country give us hope that it will largely take the place of white clover that seems to have run out for the last four or five years. This year sweet clover follows right on after basswood. Perhaps in many localities it will enable the bees to complete some otherwise unfinished sections.—Gleanings.

Please Send Us the Names of your neighbors who keep bees, and we will send them sample copies of the BEE JOURNAL. Then please call upon them and get them to subscribe with you, and secure some of the premlums we offer.

Honey-Clovers & Buckwheat SEED FOR SALE.

We have made arrangements so that we can furnish seed of several of the Clovers and Japanese Buckwheat, by freight or express, at the following prices, cash with order:

	5lb	10lb	25lb	50lb
Alsike Clover	\$.70	\$1.25	\$3.00	\$ 5.75
Sweet Clover	.75	1.40	3.25	6.00
White Clover	1.25	2.00	4.50	8.00
Alfalfa Clover	.65	1.10	2.70	5.00
Crimson Clover	.55	.90	2.00	3.50
Jap. Buckwheat	.20	.35	.90	1.25

Prices subject to market changes.
Add 25 cents to your order, for cartage, if wanted by freight.
Your orders are solicited.

GEORGE W. YORK & CO.,
CHICAGO, ILLS.

Sweet Clover 1/4 Canada.

At the following prices:

5 lbs.	10 lbs.	25 lbs.	50 lbs.
\$1.00	\$1.60	\$3.75	\$7.25.

Also a quantity of Motherwort and Catnip seed. Prices on application.

EGGS for Hatching. Buff Leghorns, Indian Games, & Light Brahmas. Choice Birds. A breeder for 30 years. Prices on application

JOHN McARTHUR,
881 Yonge Street. - TORONTO, ONT.
15Atf Mention the American Bee Journal.



Promptness is What Counts!

Honey-Jars, Shipping-Cases, and everything that bee-keepers use. Root's Goods at Root's Prices, and the best shipping point in the country.

Dealer in Honey and Beeswax. Catalogue Free.
Walter S. Poulder
162 Mass. Ave. INDIANAPOLIS, IND.

HONEY We have a large amount of Pure No. 1 Alfalfa we will sell cheap.

Wax Wanted.

Boss bee-escape Warranted the best, simplest and quickest Escape on the market. Sent postpaid to any address for 30 cts. It can be returned at our expense if it is not as represented, or we will send the Escape on trial to any bee-keeper wishing to test it in good faith. We are agents for the Ferguson Patent Hive with double-case Super and Wicket-Gate Honey-Board, with the Escape. It is the easiest, quickest hive to handle for the production of comb honey. Address,

E. S. LOVESY & CO.,
355 6th East St., SALT LAKE CITY, UTAH.
Mention the American Bee Journal. 9Atf



Queens! Queens!

Fine Untested Queens mailed PROMPTLY at 60 cts. each, or Six for \$3.30.

Safe delivery and satisfaction guaranteed. Address,

F. GRABBE,
LIBERTYVILLE, Lake Co., ILL.

26Atf Mention the American Bee Journal

BEGINNERS.

Beginners should have a copy of the Amateur Bee-Keeper, a 70-page book by Prof. J. W. Rouse. Price 25 cents; if sent by mail, 28c. The little book and the Progressive Bee-Keeper (a live, progressive 28-page monthly journal) one year, 65c. Address any first-class dealer, or

LEAHY MFG. CO., Higginsville, Mo.

Full Colonies of Italian Bees for \$4.00. or particulars see larger ad. on page 350 of this paper. Tested Queens, a fine lot, by return mail, 50 cts. each.

Address, T. H. KLOER,
426 Willow St., TERRE HAUTE, IND.
29A4t Mention the American Bee Journal.

No. 1 Sections—Cheap.

We offer for a few weeks, a surplus stock of our one-piece No. 1 Cream Sections at the following very low prices:

1000 for \$1.50.

3000 for \$4.00.

5000 for \$6.00.

These Sections are finely finished and No. 1 in all respects save color, being, as their name indicates, of a cream color.

The stock consists of a quantity each of the following sizes:

4½x2, open 2 sides 4¼x1 15-16, open 2 sides
4¼x1 7-8, open 2 sides
4¼x1½, open 2 sides 4¼x7-10-ft., open 2 sides

G. B. LEWIS CO.

WATERTOWN, WIS.

Beautiful Golden Queens From Kan.

Let me tell you why my Golden Italians are better for comb honey than the 3-banders. Simply this—they cap their honey white like the blacks, and are splendid workers.

1 Untested Queen, 75 cents or 3 for \$2.00	
1 Tested Queen, \$1.00	Breeders 2.50
1 Breeder which I have bred from and found to be the best	4.00
1 Frame Nuclei with Queen	1.75
2 " " "	2.25
3 " " "	2.75

All orders filled promptly. Safe delivery guaranteed. **P. J. THOMAS, FREDONIA, KAN.**

Mention the American Bee Journal

Page & Lyon Mfg. Co.,

NEW LONDON, WIS., operates two saw-mills that cut, annually, eight million feet of lumber, thus securing the best lumber at the lowest price for the manufacture of bee-keepers' supplies. They have also just completed one of

The Largest Factories,

and have the latest and most improved machinery for the manufacture of Bee-Hives, Sections, etc., that there is in the State. The material is cut from patterns, by machinery, and is absolutely accurate. For Sections, the clearest and

The Whitest Basswood

is used, and they are polished on both sides. Nearness to pine and basswood forests, and possession of mills and factory equipped with best machinery, all combine to enable this firm to furnish the best goods at

The Lowest Prices. ♡

For instance, it has a job lot of 200,000 No. 2 Sections that will be sold at 50 cts. per 1,000; or 2,000 Snow-White Sections will be sold for \$4.00, and larger quantities at still lower prices. Send for Circular and see the prices on a full line of supplies. 16Atf

Mention the American Bee Journal

History of the Adels

IN CARNIOLA there are two strains of Bees—one is gray or steel-colored, the other is yellow. The natives consider the yellow strain the best, and call them "THE ADELS." Adel means superior—and they are superior to all others. The Queens are very hardy and prolific; the Bees great workers, store and cap their honey nicely, and are sure to winter in most any climate on the summer stands. The bees are gentle and seldom sting even when no smoke is used. I have had six years' experience with them, and never have had a swarm. Can ship 200 Queens by return mail. Everying guaranteed.

Our new Catalog giving way to introduce Queens, and testimonials, ready to mail.

One Queen, \$1; 2 Queens, \$1.90; 3 Queens, \$2.50; 6 Queens, \$4.50; 12 Queens, \$8.00. Tested Queens, \$1.50.

Italian Queens same prices.

HENRY ALLEY,

28A4t WENHAM, MASS.

Question-Box.

In the multitude of counsellors there is safety.—Prov. 11-14.

Fastening Foundation in Brood-Frames and Sections.

Query 22.—1. How do you fasten foundation to the top-bars of brood-frames?

2. How do you fasten foundation in sections?—TENN.

G. N. Doolittle—Both, with melted wax.

Prof. A. J. Cook—1. Wire frames. 2. With Parker fastener.

W. R. Graham—1. With melted wax. 2. With press and hot plate.

P. H. Elwood—1. With a Given press in wired frames. 2. With a hot plate.

E. Fraoce—1. With melted wax. 2. Press the foundation on with a machine.

Rev. M. Mahin—1. I have no approved plan. 2. I use melted rosin and beeswax.

W. G. Larrabee—1. By soldering with beeswax. 2. I use the Parker foundation fastener.

James A. Stone—1. With a press, during warm days, or in a warm room. 2. Same way.

Mrs. L. Harrison—1. Too long ago; I don't remember. 2. Dip in melted wax, kept over an oil-stove.

B. Taylor—1. A slotted top-bar and hot wax. 2. Hot beeswax, using a tin paddle of peculiar construction to handle the wax.

Emerson T. Abbott—1. By pressure. 2. With a Parker foundation fastener, if I have much to do. If not, with a screw-driver.

Dr. J. P. H. Brown—1. By pressing and waxing to the comb-guide. 2. Either by dipping edge of the foundation into a pan of wax, or by use of a comb fastener.

C. H. Dibbern—1. I use one-half wax and rosin, and run it melted on both sides, soldering the foundation firmly to the top-bar. 2. I use a foundation press.

J. M. Hambaugh—1. By the use of the Daisy roller foundation fastener. 2. By the use of a stiff knife warmed over a lamp. Two is preferable—one to be warming while the other is in use.

R. L. Taylor—1. With a teaspoon of melted wax and rosin, equal parts. 2. With a machine having a plate kept hot by means of a lamp. It is on the plan of Root's "Daisy," except the section is taken off right side up.

H. D. Cutting—1. I prefer a saw-cut in the center of the top-bar; place the foundation in the cut, and fasten with melted wax. 2. I have used for many years a machine that fastens the foundation with a hot iron, the iron heated by a lamp.

Dr. C. C. Miller—1. Push the edge of the foundation in a saw-kerf cut in the underside of the top-bar 5/32 wide and ¼ deep, then drop along the joint a few drops of melted wax from a burning candle made of scraps of foundation. 2. With the Daisy fastener.

G. W. Demaree—1. Sometimes I lay the frame on a rabbeted board made for the purpose, and fasten the edge of the foundation to the top-bar with melted

wax; and some times I use a putty-knife to press the wax fast, after which I run some melted wax on the opposite side of the sheet to keep it from "peeling off." 2. I use a little machine to fix the starters in the sections.

J. E. Pond—1. I use wired frames, and have no trouble in fastening, as the wires will hold it up, if the work is properly done. 2. By using some one of the various machines used for the purpose. As I keep only 4 or 5 colonies at a time, I have ample time in which to fasten the foundation securely.

Eugene Secor—1. It depends upon the style of top-bar. I do not use a machine. Sometimes I press it on with a knife or chisel, sometimes fasten with melted wax and brush. 2. Generally with a press; but if one has only a few colonies, it can be done very satisfactorily with melted wax and a feather.

Allen Pringle—1. I wire the frames and allow the foundation to touch the top-bar or go up into a groove. When necessary, I take some melted wax into a teaspoon (always at hand), and inclining the frame, top-bar downwards, let the melted wax run from end to end, cooling as it runs. That is quickly done, and is sure. 2. With fastener.

10 per ct. Off to Reduce Stock

on all kinds of SUPPLIES, except

—COMB FOUNDATION—

which will be sold in lots of 10 lbs. or more as follows: Medium, 35 cts.; Light, 36 cts.; Thin Surplus, 40 cts.; Extra Thin, 45 cts.

Queens—Warranted, 50c.; Tested, 75c.

W. J. FINCH, Jr., SPRINGFIELD ILL.

Mention the American Bee Journal

Warranted Queens

BY RETURN MAIL.

Either Golden or Leather-Colored, at \$5.00 per doz. Choice Tested Queens at \$1.00 each. I guarantee safe delivery.

F. A. CROWELL, Granger, Minn.
25A6t Mention the American Bee Journal.

\$5.25 Agent's profits per month. Will prove it or pay forfeit. New articles just out. A \$1.50 sample and terms free. Try us. 22A8t CHIDESTER & SON, 28 Bond St., N. Y.

WHEN ANSWERING THIS ADVERTISEMENT, MENTION THIS JOURNAL.

Hives & Combs For Sale.

45 10-frame Langstroth Hives, two-story, for extracting, as made and sold by T. G. Newman. These are empty—no frames—are well painted, and have been kept in the bee-house. Price, 75 cents each.

Also, 400 Brood or Extracting Combs for the above hives; they have the triangular top-bar as made by Newman. They are clean and in good condition. Price, \$15.00 per 100. I would take \$85.00 for the whole lot of Hives and Combs.

Reference—American Bee Journal.

W. C. LYMAN, DOWNER'S GROVE, ILL.

MUTH'S HONEY EXTRACTOR PERFECTION Cold-Blast Smokers,

Square Glass Honey Jars, Etc.

For Circulars, apply to CHAS. F. MUTH & SON, Cor. Freeman & Central Aves., Cincinnati, O. Send 10c for Practical Hints to Bee-Keepers.

READERS of this Journal who write to any of our advertisers, either in ordering, or asking about the Goods offered, will please state that they saw the Advertisement in this paper.

The Bee-Keepers' Guide:

Or Manual of the Apiary,

By PROF. A. J. COOK.

This 15th and latest edition of Prof. Cook's magnificent book of 460 pages, in neat and substantial cloth binding, we propose to give away to our present subscribers, for the work of getting NEW subscribers for the American Bee Journal.

A description of the book here is quite unnecessary—it is simply the most complete scientific and practical bee-book published to-day. Fully illustrated, and all written in the most fascinating style, The author is also too well-known to the whole bee-world to require any introduction. No bee-keeper is fully equipped, or his library complete, without "THE BEE-KEEPER'S GUIDE."

Given For 2 New Subscribers.

The following offer is made to PRESENT subscribers only, and no premium is also given to the two new subscribers—simply the Bee Journal for one year:

Send us Two New Subscribers to the Bee Journal (with \$2.00), and we will mail you a copy of Prof. Cook's book FREE as a premium. Prof. Cook's book alone sent for \$1.25, or we club it with the Bee Journal for a year—both together for only \$1.75. But surely anybody can get only 2 new subscribers to the Bee Journal for a year, and thus get the book as a premium. Let everybody try for it. Will you have one?

GEORGE W. YORK & CO.,
CHICAGO, ILLS.

Mention the American Bee Journal.

A Bargain—EARLY QUEENS.

119 Colonies Italian Bees in Chaff Hives: two acres land; good house; excellent well.

Early Queens—Tested, \$1.00; Untested, 50c. Sent by return mail.

E. L. CARRINGTON,
16Atf PETTUS, Bee Co., TEX.
Reference—1st National Bank of Beville.

Mention the American Bee Journal.

PURE BARRED PLYMOUTH ROCK

Eggs, \$1.25 per 14. Our P. Rocks are very large, with fine plumage. Also,

BLACK MINORCA EGGS,

a non-sitting and great laying breed. Both kinds raised upon our farm. Minorca Cockrels, \$1.00 each. Mrs. L. C. AXTELL,

16Atf ROSEVILLE, Warren Co., ILL.

Mention the American Bee Journal.

EQUAL TO X RAYS. Our strain of Italians penetrate red clover blossoms. Choice Untested Queens, 70c; 3 for \$2—by return mail. A full line of A. I. Root & Co.'s Goods on hand. 36-page Catalogue Free. JNO. NEBEL & SON, High Hill, Mo.

Mention the American Bee Journal. 4A26t

Queens and Queen-Rearing.

If you want to know how to have queens fertilized in upper stories while the old queen is still laying below; how you may safely introduce any queen, at any time of the year when bees can fly; all about the different races of bees; all about shipping queens, queen-cages, candy for queen-cages, etc.; all about forming nuclei, multiplying or uniting bees, or weak colonies, etc.; or, in fact, everything about the queen-business which you may want to know—send for Doolittle's "Scientific Queen-Rearing"—a book of over 170 pages, which is as interesting as a story. Here are some good offers of this book:

Bound in cloth, postpaid, \$1.00; or clubbed with the BEE JOURNAL for one year—both for only \$1.75; or given free as a premium for sending us three new subscribers to the BEE JOURNAL for a year at \$1.00 each.

General Items.

Fine Honey Season in Canada.

This is a fine honey season. I never saw so much basswood. Every one has lots of honey, and it is extra fine.

N. H. SMITH.

Tilbury, Ont., July 7.

Basswood and Sweet Clover.

Bees are booming on basswood and sweet clover. I never saw them fuller of blossoms.

Murrah for the "Old Reliable!"

LAWRENCE G. WARNER.

Middleburgh, N. Y., July 6.

Booming on Sweet Clover.

The bees are just booming on sweet clover. I have taken off over 100 pounds of very fine honey, and have about 500 pounds more nearly ready to take off. Swarming has been brisk for about three weeks.

G. E. NELSON.

Bishop Hill, Ill., July 3.

Bees Doing Well.

My bees are doing all that I could ask of them. There is white clover and basswood in abundance here. The basswood has just begun to bloom, and promises a splendid crop of honey. I had 21 colonies, spring, count, and have so far had 15 prime swarms.

C. S. FRENCH.

Leslie, Minn., July 6.

Great is Sweet Clover.

I have all my supers on the hives, and the way the bees are bringing in the honey makes me smile. I have taken one super off, and all the hives have two supers on, and the top ones will be ready to take off in a few days; it is all from sweet clover, and from six weeks to two months still ahead. Talk about old-time yields! If this is not one of them, I will miss my guess.

L. SYLVESTER.

Aurora, Ill., July 7.

Bees Reasoning, Etc.

I have seen several times in the Journal where some one asks if bees reason. My answer would be, that one end of them does, while at other times the other end seems very unreasonable.

I must tell a little joke on a man who is in the 60's, and has handled bees to the largest extent of any man I know of in this country. I was talking to him not long ago in regard to bees wintering and standing cold weather if kept dry. He says they cannot be frozen to death at all, and to prove it, I will tell how he knows it. He said:

"I know that my bees have staid out of their hives all winter, lots of them, and come in all right in the spring. I have moved my hives several times, in the winter, to a different place from where they were in the fall, and the first warm day that came there would come a lot of bees from the woods where they had been all winter, and fly around their old home place where it was when they left. Now, can't a child see into this, how it is?"

I said, "Mr. Ellison, do you really

ITALIAN QUEENS

Golden or Leather-Colored!
BY RETURN MAIL.

Fine Untested, 60c. each; two, \$1.00. Select Untested, 75c. Tested, \$1.00 Full Colonies cheap. No disease. Remit by express money order, payable at Barnum, Wis. Many customers send \$1.00 and \$2.00 bills. 2c. stamps taken for less than \$1.00. Safe delivery and satisfaction guaranteed.

P. S.—57 choice 2-yr.-old Queens, 25c. each while they last.

VAN ALLEN & WILLIAMS,
BARNUM, WIS.

29Atf Please mention the Bee Journal.



BINGHAM SMOKERS

Best on Earth

and Cheapest.

Doctor, 3 1/2-in. stove, by

mail, \$1.50; Conqueror,

3-in., \$1.10; Large, 2 1/2-

\$1; Plain, 2, 70c; Little

Wonder, 2, wt 10 oz, 60c

Bingham & Heberington

Honey-Knives, 80 cents.

T. F. BINGHAM,

23Dtf Farwell, Mich.

Mention the American Bee Journal.

1880 Special Offer. 1896

Warranted Queens, bred from best imported or home-bred Queens, at 60 cts. each; 1/2 doz., \$3.50. Untested, 55 cts.; 1/2 doz., \$3.15. Tested, 70 cts.; 1/2 doz., \$4.00. All Queens sent promptly by return mail.

LEININGER BROS.,

FT. JENNINGS, OHIO.

25Dtf

Mention the American Bee Journal.



Bee Supplies

Largest Stock and Greatest Variety in the West. BEST Goods at LOWEST prices. Cat. of 80 pages FREE.

E. KRETZMER, RED OAK, IOWA.

Mention the American Bee Journal. 23D9t

CARLOADS

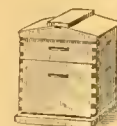

Of Bee-Hives, Sections, Shipping-Cases, Comb Foundation, and Everything used in the Bee-Industry.

I want the name and address of every Bee-keeper in America. No reason why you cannot do business with me. I have Cheap Lumber and Experienced Workmen; a good Water-Power Factory and know how to run it. I am supplying Dealers as well as consumers. Why not you? Send for Catalogues, Quotations, etc. W. H. PUTNAM, 1E RIVER FALLS, Pierce Co., WIS.

Mention the American Bee Journal.

HARDY—&—PROLIFIC QUEENS

Gray Carniolans or Golden Italians bred in separate apiaries—One Untested Queen, 65c; six for \$3.50. Tested, \$1.25. Select Tested, \$2.25. Best Imported, \$4.00

Never saw foul brood or bee-paralysis.

✓ SATISFACTION GUARANTEED. ✓

Descriptive Price-List Free.

F. A. LOCKHART & CO.,

27Dtf

LAKE GEORGE, N. Y.

Mention the American Bee Journal.

THROAT

AND LUNG DISEASES,
DR. PEIRO, Specialist
Offices: 1019, 100 State St.,
CHICAGO. Hours 9 to 4.

Mention the American Bee Journal.

think those bees staid out all winter?" "I know they did," was his answer. He is not the man who made the drone out of the working bee by it losing its sting.

I will say right here, that with all I can say to this man, I can't get him to take the Bee Journal. Of course he don't need it! If I could coax the editor to put the word "Populist" in big letters on the back of one number, and send it to him, I believe I could fool him and get him to read one number clear through before he would find his mistake.

I was in hopes some one would answer my query in regard to about how many eggs have ever been found in a queen. When some man like Dr. Miller, Doolittle, or really any one will give me a positive answer, I will then be ready to throw my whole weight (315 pounds) at them.

Pollock, Mo.

A. COTTON.

Midst of the Second Honey-Flow.

We are now in the midst of the second honey-flow for the season from sourwood, white clover, red clover, etc. May was dry, but the excessive rains of June caused clovers and many other plants to bloom in profusion, and for a week it seems that nectar has been abundant, and may continue for some days if the weather be favorable. The prospects were never better for a flow from wild asters and other wild flowers.

W. H. PRIDGEN.

Creek, N. C., June 30.

Gloomy Outlook—Bee-Paralysis.

The bee-business has a gloomy outlook—dry year—hardly enough honey to keep the bees alive. Some of us have been so unfortunate as to import bee-paralysis through those fine golden queens from Eastern breeders. My advice to bee-keepers is, Don't buy queens unless you first have the certain knowledge that the man you buy of has not, and never has had, bee-paralysis amongst his bees. I never heard of the disease in California until those lovely yellow bees were imported.

It is not the white sage which is our most valued bee-plant, as it is not a sure thing every year. The black, or ball, sage is the best, as it yields the finest honey, and is reliable.

ELLEN C. BLAND.

Fernando, Calif., July 4.

Why Did the Bees Leave?

If Dr. Miller will not be offended at my intrusion, I will help him answer the question, "Why did the bees leave the hive?" asked on page 390, by giving my own experience in that line.

About 22 years ago, I attempted to increase my bees by stimulative feeding during the winter. I succeeded as well as I expected till toward spring, when one warm day I carried the bees out to fly, and about one-half of the colonies left their own hives and went into others. The next time I set them out they did the same thing, until I only had 4 (I think it was) out of 20.

For some time I could not tell what caused them to do so, as their hives were dry and clean, and they had plenty of honey and brood. But I at last noticed that in every case the deserted hive had no pollen, and the hives where they went

in had some. As there was no exception to this rule, I concluded that the want of pollen had caused all the mischief.

Since that time, when my bees are breeding in early spring, I am careful to see that they have plenty of pollen, or a substitute, and have had no more trouble of that kind. If others have had a different experience, with no apparent cause, I would like to hear from them.

And, Doctor, please allow me to suggest the using of horse-dung for smoker fuel. It is always easily obtained, and has no disagreeable odor like cow-dung.

Grover, Colo.

I. W. BECKWITH.

Good Crop Expected.

Bees have done fairly well here so far this season, although it has been very hot and dry for two weeks until Saturday night and Sunday about 3 inches of water fell. Some of my colonies have stored 50 pounds in boxes from clover, and they have just commenced on basswood, which is going to blossom as full as I ever saw it; so with the rain we have had, we might expect a good honey crop this year.

Some of the best bee-keepers we have in the county lost over 50 per cent. of their bees last winter, but where swarming has not been prevented, they have more than doubled. One man told me he started in with one good, strong colony, and it had swarmed five times, and that he saved them all, and had 6 colonies now.

G. W. FASSETT.

Middlebury, Vt., July 6.

List of Honey and Beeswax Dealers.

Most of whom Quote in this Journal.

Chicago, Ills.

R. A. BURNETT & Co., 163 South Water Street.

New York, N. Y.

HILDRETH BROS. & SEELKEN,
120 & 122 West Broadway.

CHAS. ISRAEL & BROS., 486 Canal St.

Kansas City, Mo.

C. C. CLEMOMS & Co., 423 Walnut St.

Buffalo, N. Y.

BATTERSON & Co., 167 & 169 Scott St.

Hamilton, Ills.

CHAS. DADANT & SON.

Philadelphia, Pa.

WM. A. SELSER, 10 Vine St.

Cincinnati, Ohio.

C. F. MUTH & SON, cor. Freeman & Central avs.

Cleveland, Ohio.

WILLIAMS BROS., 80 & 82 Broadway.

St. Louis, Mo.

WESTCOTT CO. Co., 213 Market St.

Minneapolis, Minn.

S. H. HALL & Co.

North American Bee-Keepers' Association

OFFICERS FOR 1896.

PRESIDENT—A. I. Root..... Medina, Ohio.

VICE-PRES.—Wm. McEvoy..... Woodburn, Ont.

SEC.—Dr. A. B. Mason..... Sta. B, Toledo, Ohio.

TREAS.—W. Z. Hutchinson..... Flint, Mich.

Convention at Lincoln, Nebr.

National Bee-Keepers' Union.

PRESIDENT—Hon. R. L. Taylor..... Lapeer, Mich.

GEN'L MOR.—T. G. Newman..... San Diego, Cal.

HONEY and BEESWAX

MARKET QUOTATIONS.

The following rules for grading honey were adopted by the North American Bee-Keepers' Association, and, so far as possible, quotations are made according to these rules:

FANCY.—All sections to be well filled; combs straight, of even thickness, and firmly attached to all four sides; both wood and comb unsoiled by travel-stain, or otherwise; all the cells sealed except the row of cells next the wood.

No. 1.—All sections well filled, but combs uneven or crooked, detached at the bottom, or with but few cells unsealed; both wood and comb unsoiled by travel-stain or otherwise.

In addition to this the honey is to be classified according to color, using the terms white, amber and dark. That is, there will be "Fancy white," "No. 1 dark," etc.

Chicago, Ills., July 7.—We quote: Fancy white clover, 15c.; No. 1 white, 12@13c.; fancy amber, 10@11c.; No. 1 amber, 7@9c.; fancy dark, 9@10c.; No. 1 dark, 7c. Extracted, white, 5@7c.; amber, 5@5½c.; dark, 4½@5c. Beeswax, 25@27c.

Philadelphia, Pa., July 10.—No. 1 amber, 9-10c.; fancy dark, 8-9c.; No. 1 dark, 7-8c. Extracted, white, 8-10c.; amber, 5-5½c.; dark, 3½-4c. Beeswax, 25-26c.

Honey very dull. Beeswax in fair demand.

Buffalo, New York, July 1st.—We quote: Fancy white, 15@16c.; No. 1 white, 13@14c.; fancy dark, 8@9c.; No. 1 dark, 7@7½c. Beeswax, 25@28c. Trade very dull and honey not moving, except a few fancy lots; anything dark is hard to sell.

Cincinnati, Ohio, July 10.—No. 1 white, 13@14c.; fancy amber, 12@13c.; No. 1 amber, 10@12c. White, extracted, 5@7c.; amber, 5@6c.; dark, 3½-5c. Beeswax, 20-25c.

New York, N. Y., June 24th.—No demand for comb honey of any kind. New crop of Southern extracted is arriving freely, and sells fairly good at 50@52c per gallon for common, and 55@60c per gallon for better grades. Beeswax dull at 26@27c.

Kansas City, Mo., July 8th.—We quote: Fancy white comb, 15@14c.; No. 1 white, 12@13c.; fancy amber, 11@12c.; No. 1 amber, 10@11c.; fancy dark, 9@10c.; No. 1 dark, 8@9c. Extracted, white, 6@6½c.; amber, 5@5½c.; dark, 4@4½c. Beeswax, 22@25c.

Cleveland, Ohio, July 9.—We quote: Fancy white, 15@16c.; No. 1 white, 14@15c.; fancy amber, 10@11c. Extracted, white, 6@6½c.; amber, 4@5c. Beeswax, 20@25c.

Our market is nearly bare of honey. We think early shipments would meet with ready sales at about quotations.

St. Louis, Mo., July 9.—We quote: Fancy white, 11½@12c.; No. 1 white, 10½@11c.; fancy amber, 10@10½c.; No. 1 amber, 9@10c.; fancy dark, 8½@9c.; No. 1 dark, 7@8c. Extracted, white, in cases, 5c.; in barrels, 4c.; amber, 3½@4c.; dark, 3@3½c. Beeswax, 25@25½c.

This week we sold 4,700 pounds of Southern extracted in barrels at 3½c. Honey is in fair demand. Very little fancy new comb coming in, and what has been offered not well cared as yet.

Minneapolis, Minn., July 9.—We quote: Fancy white, 15c.; No. 1 white, 13@14c.; fancy amber, 10@12c.; No. 1 amber, 8@10c.; fancy dark, 7@9c.; No. 1 dark, 8c. Extracted, white, 5½@6½c.; amber, 5½@5¾c.; dark, 4½@5¼c. Beeswax, 26@28c.

Actual transactions both in comb and extracted very light. Minnesota and Wisconsin comb will commence arriving in moderate quantities about August, and will probably supply the market until cool weather, which usually stimulates a demand. Considerable extracted is now here on the spot, sufficient to supply immediate wants.

Albany, N. Y., July 10.—Fancy white, 13-14c.; fancy dark, 8-9c.; No. 1 dark, 6-7c. Extracted, dark, 4-5c.

Stock of old comb honey is reduced to a few cases of 2-pound buckwheat and some 1-pound white California, which we expect to close out before new crop arrives on market. Conditions are favorable in this section for a good crop of white honey.

Bottom Prices

**BRING US BIG TRADE.
GOOD GOODS KEEP IT.**

If you want the best supplies that can be made at a little less cost than you can buy the same goods for elsewhere, write to us for low prices. 1896 Catalogue now ready—ask for it and a free copy of **The American Bee-Keeper** (36 pages).

Address,
**THE W. T. FALCONER MFG. CO.,
JAMESTOWN, N. Y.**

Mention the American Bee Journal.

COMB FOUNDATION!

Wax always wanted for Cash or in Exchange for Fdn. or other Supplies. My trade is established on **Low Prices** and the merit of my **Foundation. Orders filled promptly.** WORKING WAX INTO FDN. BY THE L.B. A SPECIALTY. Wholesale prices to **dealers** and large consumers. Send for Prices and Samples to—**GUS DUTTMER, AUGUSTA, WIS.** Reference—Augusta Bank. 1Atf

Mention the American Bee Journal.

I ARISE



TO SAY to the readers of the **BEE JOURNAL** that **DOOLITTLE**

has concluded to sell **BEES and QUEENS**—in their season, during 1896, at the following prices:

- One Colony of Italians on 9 Gallup frames, in light shipping-box \$6.00
- Five Colonies..... 25.00
- Ten Colonies..... 45.00
- 1 untested queen. 1.00
- 6 " queens 5.50
- 12 " " 10.00
- 1 tested Queen... \$1.50
- 3 " Queens. 3.50
- 1 select tested queen 2.00
- 3 " " Queens 4.00

Select tested queen, previous season's rearing. 4.00
Extra Selected for breeding, **THE VERY BEST**. 5.00
About a Pound of **BEES** in a Two-frame Nucleus, with any Queen, \$2.00 extra.

☐ Circular free, giving full particulars regarding the Bees and each class of Queens.
Address

G. M. DOOLITTLE,
12A25t **BORODINO, Onon. Co., N. Y.**
Mention the American Bee Journal.

BEES QUEENS
Smokers, Sections, Comb Foundation, and all Apian Supplies cheap. Send for FREE catalogue. **E. T. FLANAGAN, Belleville, Ill.**
6A26t Please mention the Bee Journal.

100 QUEENS AT 50c.

This is the season of the year when the best Queens can be reared for the least money, but almost everybody has Queens and the trade is dull. For this reason it is more profitable to sell Queens even at half price, and have them move off promptly, than to hold them week after week trying to sell at a high price. My nuclei are now full of laying Queens, and I want them to move off and make room for others that are coming on, and for that reason I will sell them at 50 cts. each, let the order be big or little. Remember they are nice, young, laying, Italian Queens. I also have plenty of **TESTED** Queens at 75 cts. each.

W. Z. HUTCHINSON, FLINT, MICH.
Mention the American Bee Journal. 29A6t

19th Year Dadant's Foundation 19th Year

Is still in the lead, for we use all the latest improvements, including the

NEW WEED PROCESS,

and still make the best goods. Remember that we do not use any acid to purify our beeswax, and that is why our Foundation preserves the smell of the honey and is more acceptable to the bees, than any other. It is kept for sale by

T. H. Strickler, Solomon City, Kansas.
G. K. Hubbard, Fort Wayne, Ind.
L. Hanssen, Davenport, Iowa.
C. Theilmann, Theilmanton, Minn.
E. C. Eaglesfield, Berlin, Wis.
E. T. Abbott, St. Joseph, Mo.
J. M. Jenkins, Wetumpka, Alabama
John Rey, East Saginaw, Mich.
Vickery Bros., Evansville, Ind.

The Jennie Atchley Company, Beeville, Texas.
C. F. Muth & Son, Cincinnati, Ohio
E. Kretschmer, Red Oak, Iowa.
G. B. Lewis Co., Watertown, Wis.
James Reynolds Elevator Co., Poughkeepsie, N. Y.
Louisiana Bee-Keepers' Supply Manufactory, Donaldsonville, La.
Page & Lyon, New London, Wis.
John Nebel & Son, High Hill, Mo.

and many other Dealers. All agree in saying that no goods are better than ours.

Those of our customers who formerly bought through Thos. G. Newman can get our Foundation in **Chicago, Ill.**, by addressing us at **118 Michigan Street**. We keep no other goods there.

We make a specialty of **Veils and Veil Stuffs** of best quality, cotton and silk.

"LANGSTROTH ON THE HONEY-BEE"—Revised.

Bee-Keepers' Supplies, Smokers, Sections, Tin Pails, etc.
Samples of Foundation and Tulle FREE with Circular. Instructions to beginners with Circular. Send us your address.

CHAS. DADANT & SON,

Mention the American Bee Journal.

HAMILTON, Hancock Co., ILL.

22c Cash Paid for Beeswax!

For all the **good, pure yellow BEESWAX** delivered to our office till further notice, we will pay 22 cents per pound, cash; or 26 cents for whatever part is exchanged for the American Bee Journal, Books or Seed, that we offer. If you want **cash promptly** for wax, send it on at once. Dark or impure wax not taken at any price. Address plainly,

George W. York & Co., 118 Michigan St., Chicago, Ill.

NEW PROCESS

Weed Foundation

NOTHING LIKE IT.

Our Total Output so far this Season is Nearly 50,000 lbs., which is 10,000 lbs. More than the Best Year of the Old-Process Foundation.

We are receiving very flattering testimonials from the leading bee-keepers all over this country, and, in fact, of the world. Here is one that has just been received from the inventor of the Cowan extractor, editor of the **BRITISH BEE JOURNAL**, and author of the **British Bee-Keeper's Guide-Book**—a work that has had an enormous sale, and which has been translated into French, German, Danish, Swedish, Russian, and Spanish. Mr. Cowan, under date of June 18, gives the new foundation this high eponium:

I have had an opportunity of trying the Weed foundation. I like it very much, and certainly think it all that it is represented.

Yours very truly,
LONDON, Eng., June 18. **THOS. WM. COWAN.**

And that is not all. We have sent several very large consignments of this new process foundation to England. The British bee-keepers demanding this article all over the British Isles, just the same as American bee-keepers are demanding the same all over the United States. Our British cousins know a good thing when they see it.

We have many other fine testimonials, but we have not room to display them here.

**THE A. I. ROOT COMPANY,
MEDINA, OHIO.**

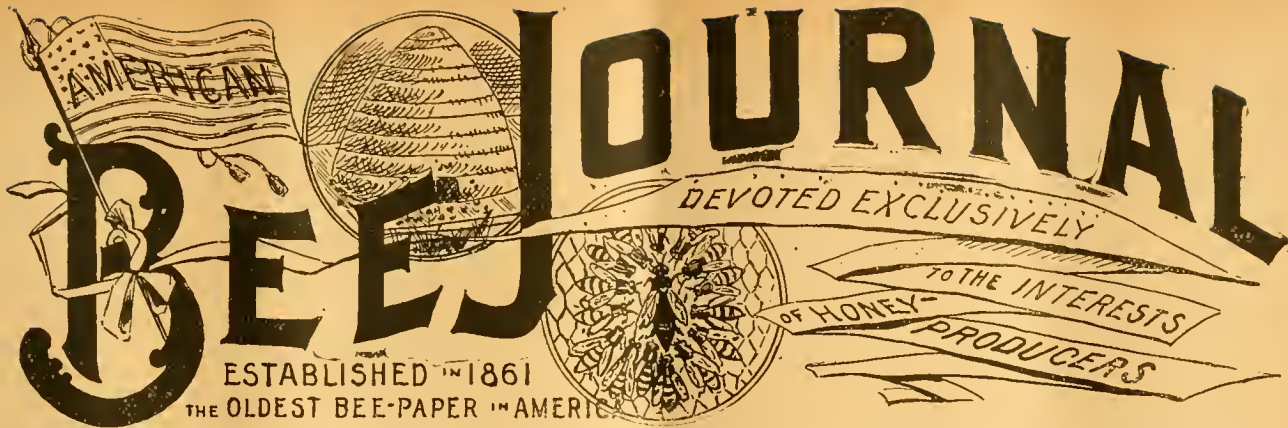

AMERICAN BEE JOURNAL

DEVOTED EXCLUSIVELY TO THE INTERESTS OF HONEY-PRODUCERS

ESTABLISHED IN 1861
THE OLDEST BEE-PAPER IN AMERICA

Published Weekly, at \$1.00 per annum.

Sample Copy sent on Application.

36th Year.

CHICAGO, ILL., JULY 23, 1896.

No. 30.

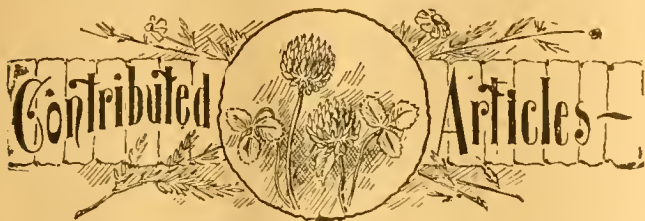

Bees Moving Eggs—Other Unsettled Questions.

BY PROF. A. J. COOK.

There are some things which are taught in our bee-literature which I think need more proof before we accept them. It is so easy for assertion—mere assertion—to be copied, and after one or two such transcriptions they are often reported as facts.

One of these cases is the common statement that worker-bees move the eggs or larvæ from one cell to another. I am aware that we often read of positive statement regarding the truth of this matter. Of course, positive evidence, if valid, counts for everything.

To one who has closely studied the bee's egg it would seem a pretty delicate operation to move it from one cell to another; nor do we find the bees possessed with any such delicate tactile organs as we would think requisite to this removal. But the student of natural history has so many strange things constantly before him that he would not place very much stress on any seeming impossibility; surely not in the face of positive proof that the thing is done.

I have tried by placing combs of eggs where the combs were old and soiled in queenless colonies void of brood and eggs, close beside clean combs in which bees are so ready to start queen-cells. I could never persuade the bees to remove any eggs. While this would prove nothing, as against positive evidence, yet it has made me skeptical. I have closely observed for years, and have never yet seen a single case. This fact has added to my skepticism.

Thus I have come to look with some question upon statements that such removal is ever practiced. There is so much of wrong conclusion in this world because of lack of care in studying the facts. I think we may say that such cases of removal are very rare, and so exceedingly exceptional if they occur at all. In case of exceptions of this kind, we should always scan very carefully all the data from which the conclusion is drawn, and see if they are not accounted for on some other supposition. In this case, who can say that a queen may not have been in the hive. Queens often attempt to go out with a swarm, and not infrequently return to the wrong hive. In case the colony of this hive was queenless, the queen might commence laying and afterwards be destroyed

by the bees. Do those who believe that they know that such removals have been made, positively know—can they know—that no queen has been in the hive? It seems to me that it would be very difficult to prove that none had been there, and until such proof was secured we are justified in keeping an after all such statements.

RANK OR POISONOUS HONEY.—Again, it is often stated that certain kinds of honey are rank in flavor because the flowers or foliage of the trees have a peculiar odor—a case in point is the so-called pepper honey of California. The beautiful pepper trees are very common, are almost always in bloom, and usually freely visited by the bees in case they can get nectar from no other source. For the past few months our pepper trees about Claremont have been alive with bees from early morn till late nightfall. They must get some nectar or they would doubtless fail to visit the bloom. As the pepper tree is diæcious, that is, the trees bear only staminate or else pistillate flowers, the bees cannot visit the pistillate bloom for pollen. As I do not see that they are producing any perceptible honey, I think they get very little nectar. I cannot find any honey that tastes like pepper, or is unwholesome. Is it not more probable that the rank honey comes from honey-dew, and not at all from the pepper? The oaks are now attracting the bees by honey-dew, I think, on their leaves. We know that this often is the source of very rank, unpleasant honey. I am more than half convinced that the pungent honey complained of is so often at least from honey-dew and not from pepper at all. Who knows positively that pepper honey is ever pungent?

As I have already stated in the American Bee Journal, because we find bees working on plants with poisonous foliage is no reason to think that the honey they would secure, as the result of such gleanings, would be poisonous. So we need not expect peppery honey because the foliage of certain honey-plants is pepper-like. There would be more reason to expect it if the flowers were peppery, as there might be in the nectar elements that produced the peculiar taste.

DRONES FROM IMPURELY-MATED QUEENS.—Another probable fallacy is that the drone progeny from a pure queen that has been impurely mated, will be impure. In this case we know that the eggs are not fecundated, and so if there is impurity it must come from the mere presence of the sperm-cells in the spermatheca of the queen. This would seem to be impossible. I have tried very extensive experiments mating pure Syrian queens with Italian drones, and yet every drone was a pure Syrian with no taint of Italian blood obvious to the vision. Thousands of such cases convinced me that there was no bases of fact in this statement. I should have to be convinced that there was no taint of blood in the queen in case any such impurity showed in the drones. In most cases

it would be very difficult to secure such proof. I fully believe that a pure queen will always produce pure drones, however she may be mated.

DO WORKER-BEES KILL OFF DRONES?—Again, it is claimed in all our literature that the worker-bees kill off the drones. Is this so? Do they actually kill them? Or do they simply drive them forth from the hive into despondency and starvation? The drones are good feeders, and must soon succumb, if kept from home and food. Are they not for the most part at least destroyed in just this way? Who has ever seen a worker-bee actually kill a drone? The latter may be very much enfeebled by being dragged forth from the hive, but are they killed?

LOW PRICE OF HONEY.—Mr. McIntyre, of Ventura county, has about 30 tons of honey stored. He is waiting for 30 cents per pound, and he ought to get it. That the law of supply and demand regulates the price of honey is apparently untrue. New honey of first quality produced in the Santa Ana country, even in this year of almost no crop, is reported as selling for 3½ cents. "My brethren, such things ought not so to be."
Claremont, Calif., June 25.



Honey from Laurel and Ivy—Bees and Fruit.

BY G. H. ALLEN.

On page 260, I notice the articles of W. Elmer and Geo. B. Hurley, on poisoning from mountain laurel, but, as in the case of bees working on strawberries, this one case of poisoning cannot be taken as an infallible rule. I wish to say that bees do not gather poisonous honey from mountain laurel here. How do I know they do not? Well, we have both laurel and ivy growing in reach of the bees, and both are worked freely, and some seasons quite a surplus is stored from this source. This honey, which, in color, resembles buckwheat, and in quality is inferior, has never caused symptoms of poisoning in any form; and one season—I believe it was 1885—this was the only surplus secured before the fall flow. This season the honey was much inferior to that of other seasons, being very dark and strong, but no symptoms of poisoning were ever developed by its use, and it being the only honey produced I ate considerable of it myself without any ill effects, further than taste, it being little if any better than common glucose syrup. This was gathered from ivy and mountain laurel, I would presume about half and half.

Like Mr. H., I do not put much faith in the cases cited as evidence that laurel does secrete poisonous honey. Who can say that this poison was not gathered from sprayed bloom? And I have known sweets to be set out for bees, containing poison, by those who were annoyed with them, real or imaginary.

As to the poison being in the comb, the idea itself seems to me preposterous, and I would almost venture the assertion that that same professor imagined that bees gather wax as they do pollen and honey. Bees may gather poisonous honey from mountain laurel—who knows?—but they didn't do it here.

BEES PUNCTURING FRUIT.—I want to say to W. S. F. (page 291) that bees do not puncture grapes nor cherries here. Why do I know they do not? Well, when grapes are over-ripe and burst from fermentation, and are toru by wasps, yellow-jackets, etc., my bees attack them like wild dogs would their prey, demolishing whole bunches; but you will find whole grapes untouched among these demolished ones, and this year our Gov. Wood cherries burst badly on the trees, and being soft and very sweet they were immediately attacked by the bees. I procured whole and fractured ones, and placed them on the hive entrance, and the fractured ones were immediately

attacked and completely demolished, while the sound ones remained untouched. I went so far as to squeeze the juice of other cherries over them; this juice was immediately taken up, when, after running around in an excited manner for awhile, they would give up the job and leave the cherry untouched. But puncture its skin, and it was attacked at once, and demolished post haste.

This I take as knock-down evidence that bees do not puncture cherries and grapes here, when whole. They may do it in other sections—who knows? Who has seen a bee tearing the rind of a sound grape or cherry? Not I, although I have tried hard to get them to do so.

Alderson, W. Va.



The Prevention of Swarming—What We Do?

Second reply to Dr. Miller's questions.

BY C. P. DADANT.

Our first aim is to give the queen plenty of breeding-room. No matter what method we pursue, if the queen is crowded or dissatisfied, we need not look for the bees to stay. We therefore want plenty of brood-chamber space, and we want it all in one story, so the queen will not have to hunt it up or go out of the cluster in cool weather. Not only a prolific queen with plenty of breeding-space makes a strong colony that harvests a large crop, but this colony also stands the inequalities of temperature best.

In the second place, we want plenty of room, and if possible plenty of empty comb for the bees to lodge their crop, especially at the opening of the honey harvest. Hence, we want a wide ceiling that may enable us to put on a large super. In our own practice, we always have supers full of empty comb, and this makes the giving of room to the bees much more practicable than when empty sections are given, for there needs be no lull in the work, no waiting on the builders, no hanging in clusters while the honey is wasting in the fields. The young bees alone, then, do the comb-building, and this is proper.

We have had swarms for want of room, in such circumstances as mentioned in my last article, even though the space occupied and not filled might have been sufficient. Bees swarm because the circumstances do not suit them, they are ill at ease and lack elbow-room. If we do not wish them to swarm, we must give them that elbow-room, and the better the seasons open the more elbow-room we should give them at the start. Towards the end of the harvest, when the queen becomes tired of the incessant egg-laying, it is of much less importance to keep them supplied with so much space; and a little crowding, so we do not make them feel uncomfortable, does them no harm. It is then that they will fill every spare cell of the brood-combs, and make the frames too heavy with honey.

Drone-rearing is a factor in swarming. In nearly every instance the colonies that swarm are those that have reared quite a large number of drones, other things being equal. The drone is stupid, he is big and noisy, and does not know how to get out of the way. See them on a warm afternoon tumble in and out over the bees, or on some cool morning lie right in the way of the workers by the handful like so many lazy dogs. Do we not see them often crowded in one corner of the super by the bees, and seemingly asleep? But come noon, and they wake up and roar and tumble. Put yourselves in the workers' place. Are not a few thousand of such fellows enough to disgust any peaceable laborer? Take out the drone-comb and replace it with worker-comb. Is that so difficult? You need not do it now, it would do no good, for the harm is done. Do it in the spring, early, when the honey is out of the combs and there is but little brood yet. We do it, and do not do it enough.

No need of being afraid of not leaving enough—there are always too many roosters.

SHADE.—Did you ever, on a hot day, see a hive in a yard painted brown—not the yard, but the hive? And did you not feel as if you should hate to live in that house? When the thermometer stands at 100° in the shade, and at . . . (how much?) in the sun, how can those bees keep their combs from melting? By forcing a current through that little hole in front. And the owner has just given them a super, and he wants me to explain to him why the bees did not fill it but swarmed. I should swarm, too, if I lived in such a place.

VENTILATION.—That was one of the hobbies of old Father Langstroth. During the honey harvest there is no need of any colony remaining idle; there is no need of "a beard" on any of the hives. Every bee that hangs in that "beard" is losing precious time, and it is not from choice that they do it, but from necessity, because the hive has not sufficient means of ventilation. There may be room, there may be space for air, there is not enough of one or the other, perhaps they need both. Their home must be commodious if we wish them to stay in it. A loose bottom enables the bee-keeper to raise the hive up whenever needed, and to give as much space for ventilation as may be necessary, especially if the hive is not composed of a pyramid of narrow stories piled three feet high. In that case I should want to give them some fire-escapes along the way.

These remarks seem perhaps superfluous to the bee-keeper who lives in a cooler atmosphere. Here we have days after days of 100° Fahrenheit weather, and the ventilation of the hive is a serious matter aside from the need of it to prevent swarming. In 1877, if I remember rightly, we lost a large number of colonies from a failure to comply with the physical laws, by placing our bees in such conditions that they might keep their combs below the melting-point. Whole rows of hives in an out-apiary five miles from home were damaged, losing from one to seven combs, and if we remember rightly, seven colonies were lost altogether by the breaking of every comb from heat.

But let us come back to the swarming question, and I am done with only a few words more: After we have taken all sorts of precautions we still have some swarms, Mr. Dadant, senior, says 3 to 5 per cent. Sometimes we have more, but sometimes less. In 1883-84 we harvested on the farm of Mr. P. Champagne—another Frenchman, Dr. Miller (not you)—25,000 pounds of honey in two years, and had two swarms in the two years. This was extracted honey, though, not comb honey; 87 colonies.

On the other hand, in 1890, on the farm of J. P. Lamont, we had an endless number of swarms. This was the best year we ever saw, and the bees got away with us. We could not keep up, as everything was full and overflowing before we knew it.

A certain percentage of colonies will swarm in spite of anything that may be done. You must bear in mind that it takes but little to induce swarming during a good honey harvest. If you introduce a strange queen in one of your strong colonies, they may accept her under protest. In this case, they will go quietly to work and rear queen-cells to replace her. Meanwhile they will let her go unmolested. If this is during a honey-flow, in nine cases out of ten they will lead her out with a swarm, even if the hive is not otherwise ready for swarming, and with plenty of spare room. For the same reason, if their queen shows signs of failing—this often happens when they become exhausted by the incessant laying—they will at once prepare to replace her, and when the young queen is reared, the swarm goes with the old queen, even though their intention, perhaps, was not to leave in the first place. Such primary swarms usually lose their queens before the end of the season, as she is old and worn. When the hive

becomes queenless from any cause, they have a good opportunity to swarm with one of the young queens. Dividing a hive that prepares to swarm usually results in the swarming of both the old colony and its divided swarm, as the swarming-fever is not ended by a division.

But, I believe Dr. Miller is smiling. I guess in all this verbiage he has found some things that he knows (I wonder), and perhaps also some that he knows aren't so. I will quit. He spoke of witchcraft, but I assure you, Doctor, even old Cotton Mather could not convict us. Hamilton, Ill.



Figwort or Carpenter's-Square.

BY MRS. J. G. BIRCHETT.

Believing that bee-keepers generally are interested in plants that afford an average supply of honey, I write in reference to one that affords not only an average supply, but a continuous one, as the number of bees thereon would prove, from morning till night, from spring until late in autumn.

Fortunately for us, and I trust equally so for some others, I was induced by having read an article published in the Bee Journal some time since, to test the merits of the honey-plant usually called "carpenter's-square." We were not as successful in finding it growing "commonly" as the article indicated, nevertheless we secured two plants, and were unnecessarily careful (as experience has proven) about transplanting them; however, they wilted comparatively none, and ere long resumed their usual vitality, sending up numerous flower-stalks to the delight of the bees, to say nothing of our own interested selves.

Had it not been for the honey-plant, our late swarms could not have survived the winter, owing to the drouth of last fall. While every flower and vegetation throughout was thoroughly exhausted, by lack of moisture, the honey-plant remained green and luxuriant, sending forth its usual supply of bloom every day until killed by late-repeated frost.

We have white clover, mustard, catnip, buckwheat and an abundance of locust, cherry, etc., all of which do well enough while they last.

The honey-plant begins blooming about the time apples cease, and continues until late autumn, as previously stated. While it grows very large upon fertile soil, it shows up equally as many flower-stalks upon thin land, so that I do not think it inferior as a honey-producing element to those grown on richer soil. I pinched out the top bud of an average plant of nine flower-stalks, about three weeks ago, and now it contains 47 racemes, each from 4 to 12 inches long. I shall continue pruning and report results later.

This wonderful bee-plant is herbaceous, and the old plant spreads, and seemingly grows more luxuriant every year. The seed should be sown in the fall, but it will not bloom the first season until July or first of August.

I should like to have the opinion of others who have given this plant attention. Shelby County, Ky.

[Prof. Cook, in his "Bee-Keepers' Guide," writes thus about the above plant:—Ed.]

Figwort, *Scrophularia nodosa*, often called rattleweed, as the seeds will rattle in the pod, and carpenter's-square, as it has a square stalk, is an insignificant looking weed, with inconspicuous flowers, that afford abundant nectar from the middle of July till frost. It is a very valuable plant to be scattered in waste places.



The McEvoy Foul Brood Treatment is given in Dr. Howard's pamphlet on "Foul Brood; Its Natural History and Rational Treatment." It is the latest publication on the subject, and should be in the hands of every bee-keeper. Price, 25 cents; or clubbed with the Bee Journal for one year—both for \$1.10.

Fifteen Years' Experience in Bee-Keeping.

BY MRS. SALLIE E. SHERMAN.

(Continued from page 452.)

It used to be a favorite pastime of mine to watch the queen come out of the observatory hive, for her bridal flight. I have often timed her to see just how long she would be gone. From 5 to 10, and on one occasion 15, minutes. Oh! what rejoicing there would be on her successful flight and safe return. It seemed to me that every bee in the little hive joined in the happy chorus. They had a regular jubilee.

I have often watched the first queen that hatched gnaw the other queen-cells open, and then insert her sting, thus killing the immature or unliberated queen. At other times I have seen them engage in mortal combat; then, of course, it was a case of "the survival of the fittest."

On one occasion the little colony took a notion to swarm, and swarm it would, and did, and would never be content in that little hive again, so I put them into a large hive, and built them up to a good, strong colony.

It was always interesting to me to watch the queen as she deposited her eggs, and see the system she used, as she would go around in a circle depositing her eggs in every alternate cell, and as she would go around the second time it was still every alternate cell.

One fall, after extracting as usual for the last time, from some (to me) unknown cause, the flowers failed in their secretion of nectar. I had sold most of my honey before I found that the bees did not have a sufficient amount in their hives to last them until spring with its flowers came again, so I bought a barrel of granulated sugar, and fed my bees for the first time (except to give a few some candy one spring before). I had two large, inside atmospheric feeders which did good work, but as I had quite a number to feed it was too slow a process for me, so I just took the empty combs and poured them full on one side and hung them in the top story. In doing this I was careful to put in as much as I thought they needed until spring, closed the hive and went to the next and did likewise, until all were gone through. Then in the spring following I bought another barrel of the same kind of sugar, and fed them just a little each evening, thus stimulating them to early brood-rearing, etc. I never lost a single colony of bees from starvation, while many throughout the country lost nearly all, and in some cases all, they had.

However, there was one objection to this feeding, and that was, nearly every queen had gone up into the top-story, which, of course, necessitated her removal to the lower story or brood-nest proper, which caused an extra amount of work. But the fine condition they were in far over-balanced the extra work and expense thus incurred.

In my early experience with bees I tried to be very systematic, and had my hives, after they had been nicely painted with two coats of paint, all numbered. Of course, both stories had to be numbered just the same, so as to correspond. I soon found, with me at least, this would not work satisfactorily, as I was frequently changing them. For the best results and greatest convenience I soon ignored the numbers altogether; and then it was so annoying to have to explain to everybody that came just why I had them numbered, and why they were mismatched, etc. The first time I repainted them I was very glad to obliterate the numbers, and thus get clear of that annoyance.

White paint was decidedly my preference for hives. I tried to give them a fresh coat once a year. It paid from a financial standpoint as well as in the pleasure it gave in seeing them so nice and uniform.

My hives all had loose bottom-boards. I wouldn't think of having them with fastened bottom-boards. When the weather became warm in the spring, and the bees began lying out, I went to all such hives and raised them from the

bottom-board, placing little wedge-shaped pieces (that came with the "Eclectic" hives) under the two front corners, thus giving them ventilation. In a few minutes the bees would all go inside, and to work, whereas, without this ventilation, they would have been idlers for days, and in some cases for weeks, and then developed the swarming fever, which would have materially diminished the amount of surplus honey gathered through the season. This is, I think, a very important item to be taken into consideration where honey and not increase is desired.

I have got this ventilation matter down so nicely that for six years I have had next to no swarming at all. This was as it should be in my case, as surplus honey and not increase was my object. If the weather turned off a little cool, it was a very easy matter to remove the little wedges, and not only let them down, but contract the entrance with the same little pieces.

The earliest swarm I ever had issue was on March 8, the latest Sept. 8.

There has never been a failure in the honey crop during my 15 years' experience—I mean an entire failure. Of course, some years have been a great deal better than others. The least yield per colony that I ever had was 11 pounds—last year, 1895. I was sick and not able to see after and attend to the bees. The greatest average yield per colony was in 1888—150 pounds. From 40 colonies, spring count, I got 6,000 pounds of honey, mostly extracted; 100 pounds of wax, and 20 colonies increase.

In the fall of 1883, when I took the frame of bees out of the observatory hive, I placed it in the brood-chamber of an American hive with two frames of sealed brood, one on each side, then a frame of honey on the outside next to the hive, and two empty drawn combs between this and the brood on each side, making nine frames in all. Over all I put a piece of new oil-cloth, in the center of which I had a round hole cut so as to fit closely around a three-pound fruit-can, in the bottom of which I had a dozen small holes punched. Inside the can was placed a thin piece of cloth double, and all fit down snug and close, not permitting the passage of a single bee. The hive being set level on a good bottom-board, I then left it in my gallery all winter for experimental purposes. About once a week I filled the can about $\frac{3}{4}$ full of warm sugar syrup and honey, about equal quantities, and then put the cap on.

Little did I think that this would be the best and most profitable colony of bees I ever owned; but such proved to be a fact. In the early spring it was literally running over with bees. The queen was young and extra-prolific. I divided, sub-divided, and increased until the outcome was eight good, strong colonies. I sold two colonies and got \$25 cash for them, and 100 pounds of extracted honey, and 50 pounds of comb honey, with six good, strong colonies after the close of the season. I, of course, gave them all either full sheets of comb foundation or ready-drawn comb.

After trying various heights for my bees, I finally settled on the ground as being the best, everything considered. I had the rear of my hives raised several inches higher than the fronts, so that all debris could work towards the front, thus materially aiding the bees in house-cleaning, etc. I had two wax-extractors—a solar and a Swiss. During the busy season I put the cappings (after having them well drained) into the solar extractor, and caked the wax into small cakes and laid them away until the rush was over; I then put them through the Swiss, and caked in large cakes, sometimes in an open-top 5-gallon can, and put two such cakes in a case for shipping. If the can has had honey in it, all the better; do not wash it. After the wax cools it will slip out so nicely. Try it once, and be convinced.

I had an uncapping stand made which I found very con-

venient, as there was no stooping or dripping of the honey, and no waste whatever. This stand, when it was closed, was flat on top, something like a table. It was a kind of box on which the lid fit, to which was four legs like a table. The top fit down snug and close; was fastened to the box part with hinges, so that when it was opened the whole lid went back, and was held by a clasp. A few inches down were cleats fastened on all around, and also a good, strong piece went across the center; on these I placed two pieces of wire screen, each reaching half way so they joined on top of the rest or center piece. Below this the box extended about 8 inches, thus giving room for several gallons of honey. I gave instructions to the workman to make the bottom slanting towards one end, and to put a faucet in it; but he just made the bottom level all the way across, so I had to dip the honey out with a dipper.

I kept this stand just at the right of my extractor in the bee-tent, during all the honey season. As I uncapped the

Comb Honey in Packages for Retailing.

BY N. T. PHELPS.

Perhaps there are some producers of comb honey who desire a better way to put it up in small packages for retail than they now use. If the plan that I will try to make plain will help them to do so I shall be pleased.

It is a most patience-trying thing to see a customer handle a section of nice comb honey like a brickbat—pinch his fingers into both sides of it after you have handled it with the utmost care. Many will do that—pinch it to see how hard it is; lay it down on its side in the buggy-seat, or push it into an overcoat pocket, and then sit down on it. They come for it afoot or on horseback, in wagons or on bicycles, put it down between their feet or anywhere they can push it in. All of these things make the careful producer's "back hair" pull. There seems to be a need for a good, cheap, and substantial way to

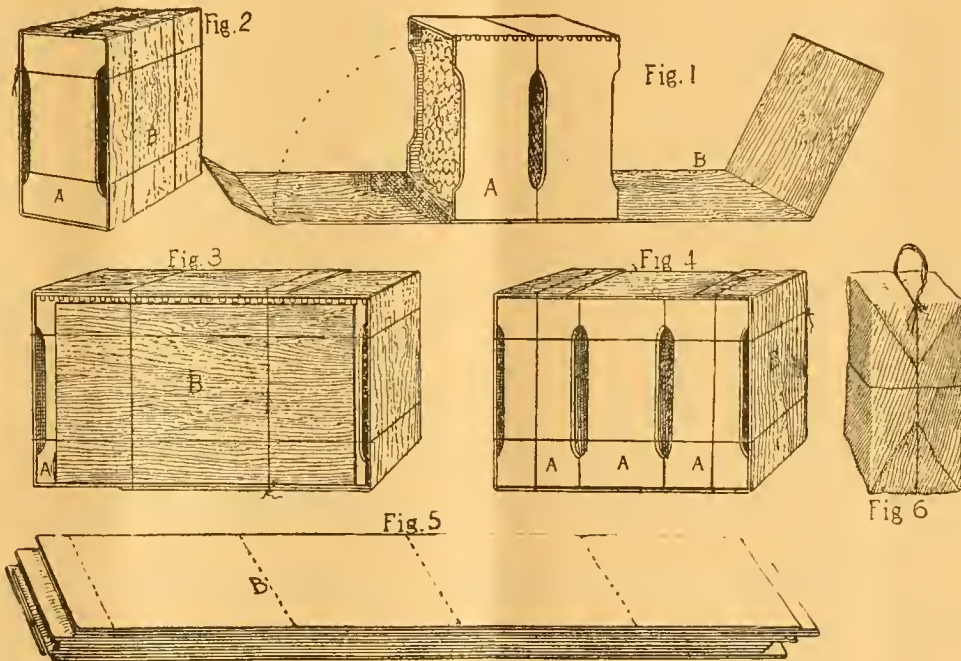

The Phelps' Basket-Splint Comb-Honey Package for Retailing.

honey ready for extracting, the cappings all fell on this heavy, wire screen, and dripped through until next morning when I would remove it to the solar extractor. At the end of the week, or at whatever time was convenient for me, I dipped the honey out and carried it into the honey-room. When the season was over, I used this stand to pack various bee-appliances in, thus making it useful all the season through.

I had a bottle of corrosive sublimate in which I saturated common cotton twine strings three or four times during the season and tied around the legs of this stand, and also around the legs of the honey and wax-extractors, which prevented ants ever crossing them or getting into the honey. A kettle of boiling water was my remedy for little ants that didn't go too deep in the ground; London purple for those that went deeper; salt on top of the hives when they got inside, or just under the hives salt would kill or move them. I used to put a table-spoonful or two or salt on the alighting-board several times during the season, more especially in the early spring and fall. They seemed to enjoy it, and I thought it was good for them.

Bell County, Tex.

[To be continued.]



See "Bee-Keeper's Guide" offer on page 476.

put up small quantities to preserve it from being broken until the purchaser can get it to his home. The plan that the writer has used for the last ten years may not be the best or cheapest ever suggested, but it may be convenient for some where the material can be got with little trouble and expense. I think almost any basket-shop will sell the material very cheaply if you will order it at a time when they are the least crowded with other work, say in the winter or early spring.

What I use is called "basket-splints" at the shops. The size I use is about 17 inches long, $4\frac{1}{4}$ inches wide, and $1\frac{1}{12}$ inch thick, made from basswood timber. These I score across with the point of a knife, so they will bend at the scored places and not break off. To score the splints in the right place, I use blocks of thin lumber cut the right size to score where I want them scored. These blocks I lay on the splints and score along each edge of the blocks with the point of a knife. The number of sections sold is set out and then the splints are scored just right for that number of sections. Then the splints are wrapped around the sections and tied with twine; then a paper is wrapped around the package and again tied with twine. This makes a good, solid package, and the customer cannot easily stick his fingers into the honey until it is untied.

Sometimes when I have a little leisure I tie up a number

of these packages so a customer does not have to wait for it to be done, and you are not hindered much when you are in a hurry. By putting up packages containing one, two, three, four, five, and six sections each, you will be able, by combining these, to give the customer the exact amount he may want. You can put it up in packages containing an exact amount, as 25-cent, 50-cent, or dollar packages, or almost any other amount, as the sections will vary a little in weight, and you can select the ones that will make it come about even for the price you may need. I sell the most 50-cent and dollar packages.

You will notice that some of the packages have a convenient handle or bail to carry them by. These are for the "foot-folks" and those on bicycles, or those who go on the train and wish to take a package to a friend. This bail is made by cutting the twine long enough to weave back and forward a few times. It pays to make it easy and convenient for a customer to handle these packages. The customer gets his honey home without breaking the cappings or having any "mess" about it, and is much more likely to want more.

I put up other combinations; but these I send are enough to illustrate the method, and each can make combinations to suit his own case. Sometimes if the sections are not well fastened in, or the customer wishes to carry it a long distance, I cut these "splints" off and make a separator between each section. Some may say this is too much trouble—let the customer take care of it after it is sold to him. I have found it to pay me to be to all this trouble.—Gleanings.

Questions AND Answers

CONDUCTED BY

DR. C. C. MILLER, MARENGO, ILL.

[Questions may be mailed to the Bee Journal, or to Dr. Miller direct.]

Maybe It is Bee-Paralysis.

What ails my bees? How can I get rid of the disease? They come out of the hive and crawl about until they die. Many are young, fuzzy ones. Many of these have imperfect wings. A few of them look shiny and a little swollen, but most of them are not. I notice the bees picking at some of them. Some have a little white worm in them. Will giving the queen of a diseased colony to a healthy one spread the disease?

Isom, Tenn.

SUBSCRIBER.

ANSWER.—I confess that I am neither able to identify the disease nor name a cure. Your description somewhat suggests bee-paralysis, but you say nothing about the trembling motion peculiar to that, and the little worm in the bees is something different. The young, fuzzy bees with imperfect wings suggest wax-worms which often burrow through the combs and injure the young bees. Knowing so little about the disease I cannot say whether the queen could communicate it, and shall be glad of light from any one.

Entrance-Guards—Dragging Out Drone-Larvæ—Sweet Clover.

1. At the beginning of the swarming season if a bee-entrance guard is placed before the entrance of a hive that will keep the queen from passing out with the swarm, what would be the final result?

2. I began keeping bees this year; I had 13 colonies, and put them into frame hives, introduced Italian queens last

month, and now these colonies that I put these queens in are all killing and dragging out the drones before they are hatched. What is the cause of it?

3. Which is the best, leather-colored Italians or 5-banded?

4. At what season would you plant sweet clover?

5. Does sweet clover bloom every year?

6. Is it a good honey-producing plant?

7. How long is it in bloom?

T. J. B.

New Berne, N. C.

ANSWERS.—1. If bee-zinc be placed at the entrance of the hive and allowed to remain there all summer, there will be no appreciable difference until the time comes for swarming. Then when the bees are ready to swarm they'll swarm just the same as if there was no guard at the entrance. If the queen cannot squeeze her way through, the bees will usually return to the hive, but sometimes they will unite with some other colony that is swarming, or go into some other hive to which a swarm is returning. But usually they will return to the hive, sometimes first clustering for a time just as if the queen were with them. A day or two later they may swarm and return again. About eight days after the first swarm issues, the first young queen will emerge, and the old queen will be killed. The bees will then swarm again, and keep swarming for several days until all the young queens but one have been killed. Then the young queen not being allowed to make her wedding flight, she will become a drone-layer if she lays at all, and when the workers die off and leave nothing but drones, the wax-worms will have a good time cleaning out the combs. That would be about the final result.

2. The killing of drones and dragging out the drone-larvæ indicates either that there is a scarcity of bee-forage, or that a young queen has been reared and gone to laying.

3. That's a matter of opinion. Some prefer one, some the other. Taken all in all, I think my leather-colored Italians do better work than the yellow ones, but I haven't so many of the 5-banded. But I confess to a liking for the looks of the very yellow ones.

4. About the time you would sow other clover.

5. Seed sown this last spring will make a growth this year without any blossoms. The next year it will grow much larger, blossom, and then die root and branch. It is a biennial, living only two years.

6. It has a fine reputation as a honey-producing plant, the honey being considered the very finest by some, but not liked by others.

7. It commences to bloom perhaps three weeks after white clover, and if kept pastured down continues blooming until freezing weather.

Knowing a Queenless Colony—Swarm Questions—Hive-Making.

1. How can you tell when a colony has no queen?

2. I drove one swarm into a new hive, and they have not done any work since. What is the trouble?

3. The first of the season I got a large swarm and put them into a hive. Soon I got another swarm, and hived them; they did not work, but came out and went into the other hive. Now they have too many, and it is a box-hive. Must I divide them? If so, how?

4. Please give a detailed plan of a good hive.

Richmond, Va.

W. S.

ANSWERS.—1. Generally, you can tell without much trouble, but sometimes it is very difficult. If you find eggs present, you may be pretty sure a queen has been in the hive within three days, but sometimes the eggs are the work of laying-workers. If laying-workers are present the eggs are generally not so regularly laid in the cells, and you will generally find drone-cells preferred, perhaps a number of eggs in a cell; and especially a queen-cell with a number of eggs. By looking carefully over the combs you can usually see the queen. By the use of a queen-excluder you can make pretty

sure of it, for often a young queen is in the hive which has not yet commenced laying, and such queens are great at hiding, and much harder to find than laying queens. Take an empty hive and put in it a brood-comb, first shaking all the bees off the comb. Put a queen-excluding honey-board over the hive and set over this another empty hive. Now brush off into this upper hive all the bees from all the combs. They will soon find their way down through the perforated zinc to the lower hive, but the queen not being able to go through will be left in the upper hive. If no queen is found in the upper hive, the supposition is that no queen is present.

2. Dear knows. Perhaps they have no queen. Possibly there is nothing for them to do, but that can't be the trouble if other colonies are doing well. Give them some young brood, and if they have no queen they will start queen-cells and be in better heart.

3. Probably the best thing is to let them alone as they are, and give them abundant room to store surplus. There might have been some advantage in dividing earlier, but by this time the bees that were in the swarms are getting pretty old, for at this time of year the life of a worker is only about six weeks, and after the first six weeks the colony will hardly be any stronger than if there had only been one swarm.

4. I might give detailed plans for several different hives, but I don't believe it would be of any value to you. You can buy them cheaper than you can make them, just as you can buy ready-made clothing cheaper than you can have it made. There's this difference, however: The ready-made clothing is not so good as that made to order, while the ready-made hives are better. Get the stuff ready cut, and nail the hives together yourself.

Inverting Sections to Fasten Combs.

Would it be practicable to invert the sections after they are nearly completed, to cause the bees to fasten the combs more securely? If not, why not? A. M. T.

ANSWER.—I think the plan has been practiced to some extent, but I doubt its advisability. It makes extra work, and there is no need of it, for by having bottom starters you can have just as solid work.

Trouble with Cedar Hives.

We have bought some new cedar hives from a Tacoma factory, and the bees will not stay in them. Is the smell of cedar the cause? If so, how can we fix them so they will do to keep bees in? Is there any preparation we can use to paint the inside? S. W. B.

ANSWER.—I should hardly think the smell of the wood at fault, still if very strong it might be offensive, especially when the hives become hot standing in the sun. As the wood becomes older and more fully seasoned, the rank odor will partially disappear, and it is possible that heating or charring them might have the same effect. Painting the inside would accomplish the desired object, but the paint must be well dried or it will be equally objectionable. It is possible that when swarms were hived in the hives they were put in the hot sun, and this alone often makes bees desert. The strong odor of the wood would make the matter worse. It may be that if the hives are allowed to stand in a cool, shady place the bees will stay in them.

What Caused the Queens' Death?

What caused the death of the queens of two of my swarms that we hived lately? They were both found dead outside, with the bees in a flurry and very cross. We put the swarms into hives that were full of old comb and some honey. The bees had died last winter in them, but I could see no reason why they were not all right. We have one swarm yet that was put in as the other two, and they are all right. We lost

the bees last February by letting them out. They flew out, and with the snow on the ground and cool atmosphere, they dropped down and chilled. S. W. B.

Kendrick, Idaho.

ANSWERS.—It is not likely that anything in the condition of the combs in the hives was at all connected with the death of the queens. If the swarms were afterswarms there would be nothing strange in finding one or more dead queens outside the hive, for a second or later swarm may have several young queens, and these are all killed but one. If the swarms were first swarms, then the case is unusual. The death of a queen might be by some accident. Sometimes, however, bees ball and kill their own queen when it isn't easy to see any reason for their doing so, but I don't think such a thing often occurs at time of swarming. Strange bees getting mixed in some way with the swarm might possibly be the cause of trouble. But without being told anything else than that a dead queen was found outside a hive just after a swarm had been hived in it, I should say it was one of the supernumerary queens in a second swarm.

Evaporating Thin Honey.

I wish to thicken some honey by running it through an evaporator. I think of getting one made like that illustrated on page 109 of the "A B C of Bee-Culture," used by L. C. Root. Will you please tell me how large the surface of this evaporator over which the honey runs should be? And at what temperature the water should be kept to secure the best results? The honey has been extracted from combs for the most part about half capped, and is not quite thick enough. Later I shall have some honey which, when fully capped, is thin, and though of a very fine quality, does not sell so well on that account. J. H. H.

Artesia, Fla.

ANSWER.—I don't think there's any rule about it. The larger the surface of course the more can be evaporated in a given time. At a guess I should say 20 to 25 inches square might answer your purpose. The less slant the more thoroughly the honey will be evaporated. It may be well not to let the surface be heated above 160°.

Swarm Leaving the Hive, Etc.

I have had a bit of experience that I cannot find in the books. One colony swarmed the middle of the afternoon; I hived them all right, and they stayed for two days in the hive, when I opened it to see what they were doing, and found that they were starting from the roof of the hive, all of the frames having starters in them. So I put in three frames full of foundation, but they swarmed shortly after that. The queen is all right. What was the matter with them? I am starting on a small scale, and I would like to know all about it, so as to be ready in the future. J. T. B.

British Columbia.

ANSWER.—I can only give a guess at the case. If I understand you rightly, instead of starting to build in the frames, the bees went up into the cover or cap which had room enough to hold them. The natural thing for bees to do is to go to the highest point they can reach in the hive, and you should have closed the hive over the frames so the bees could not get up. Then I suspect that about two days after they were hived there came a very hot day, and the hot sun shining directly on the roof close to where they were made it so hot they swarmed out. But this is only a guess, and there may have been some other reason.

The Alsike Clover Leaflet consists of 2 pages, with illustrations, showing the value of Alsike clover, and telling how to grow it. This Leaflet is just the thing to hand to every farmer in your neighborhood. Send to the Bee Journal office for a quantity of them, and see that they are distributed where they will do the most good. Prices, postpaid, are as follows: 50 for 25 cents; 100 for 40 cents; or 200 for 70 cents.

OLDEST BEE PAPER IN AMERICA ESTABLISHED IN 1844
THE AMERICAN BEE JOURNAL

GEORGE W. YORK, Editor.

PUBLISHED WEEKLY BY

GEORGE W. YORK & COMPANY,

118 Michigan St., CHICAGO, ILL.

\$1.00 a Year—Sample Copy Sent Free.

[Entered at the Post-Office at Chicago as Second-Class Mail-Matter.]

Vol. XXXVI. CHICAGO, ILL., JULY 23, 1896. No. 30.



Why Not a "Bee Day?"—There is a movement on foot to establish in the public schools of the country a national day to be called "Bird Day," in which the study of native and other kinds of birds will be taken up. The plan was suggested by Prof. C. A. Babcock, of Oil City, Pa., and is heartily endorsed by the United States Department of Agriculture. No doubt it would be a good thing, as "Arbor Day" has proven to be, but why not have a "Bee Day" also? We believe that the value of bees in the fuller production of fruit, seed, etc., together with their honey and wax, should insure them at least a *half* day's recognition, if the birds are to have a *whole* day.

There should be a "Bee Day." Who seconds the motion?

The Canadian "Pure Honey Bill."—As this Bill as finally passed is somewhat different from the one we published on page 104, we give it again, so that all can see just what Canadian bee-keepers now have in their statute books to help them in keeping down the adulteration of honey:

An Act to further amend the Act respecting the Adulteration of Food, Drugs, and Agricultural Fertilizers.

Her Majesty, by and with the advice and consent of the Senate and House of Commons of Canada, enacts as follows:

1. The Adulteration Act, Chapter 107 of the Revised Statutes, is hereby amended by adding the following section thereto, immediately after Section 21:

"21A. The feeding to bees of sugar, glucose, or any other sweet substance other than such as bees gather from natural sources, with the intent that such substance shall be used by bees in the making of honey, or the exposing of any such substance with the said intent, shall be deemed a willful adulteration within the meaning of this Act; and no honey made by bees, in whole or in part, from any such substances, and no imitation of honey or sugar-honey, so-called, or other substitute for honey shall be manufactured or produced for sale, or sold or offered for sale in Canada: Provided that this section shall not be interpreted or construed to prevent the giving of sugar in any form to bees, to be consumed by them as food."

While the foregoing is not exactly what some Canadian bee-keepers labored hard to get, still we think no one who has the best interest of pure honey production at heart will but rejoice that an additional safe-guard is thus thrown around the product of the bees. While the average bee-keeper, and the majority (as in other industries) really need no such laws

to aid them in doing right, still there no doubt are those who require just such helps to keep them from falling into temptation. We rejoice in every successful effort to make it more difficult for the wrongfully inclined to "get in their work," whether it be in bee-keeping or elsewhere.

The Amalgamation Scheme.—In response to our editorial note on page 424, Mr. Thomas G. Newman, General Manager of the National Bee-Keepers' Union, says:

FRIEND YORK:—I have just read your remarks in the Bee Journal of the 2nd inst., and am perfectly willing to call for a vote of the Union, if it is desired by the members. So far I must say, however, that while I have received several protests against incurring the expense of a vote, not one member has written to me approving the measure, and asking to have a vote taken. In such a case, therefore, it is clearly not my duty as General Manager, nor is it the duty of the Advisory Board, to order such a ballot.

When the proper steps are taken, and a request is sent by 5 members, asking to have a vote submitted, I feel sure that no time will be lost in ordering it. If the members are not sufficiently interested to ask that it be done, none can blame the officers for not doing it.

I shall be very busy for the next 10 weeks in delivering public lectures at camp-meetings in Southern California, but I have a good clerk who will attend to the clerical work necessary.

By the by, there are several "cases" looming up, in which bee-keepers are being prosecuted by envious neighbors—one of them in our grand old home (in Illinois) and one in California (our adopted home). Both now appear to be preparing for the courts. As ever, the Union will be found ready for the fray.

Best wishes for you and the Bee Journal, and all the devotees of the pursuit. I remain, yours fraternally,

THOMAS G. NEWMAN.

San Diego, Calif., July 6, 1896.

The Illinois State Fair for 1896 will be held at Springfield, Sept. 28 to Oct. 3, inclusive. In the published Premium List, and under the head of "Bees and Honey," we find the following generous premiums offered, which should call out a large number of exhibitors:

	1st.	2nd.	3rd.
Display of comb honey.....	\$25	\$15	\$10
Case of white clover comb honey, 12 to 24 lbs.	5	3	
Case of basswood comb honey, 12 to 24 lbs....	5	3	
Case comb honey from fall flowers, 12 to 24 lbs.	5	3	
Display of extracted honey.....	25	15	5
Display samples of extracted honey, named....	5	3	
Display of candied honey.....	15	10	5
Display of beeswax.....	15	10	5
One-frame observatory hive of dark Italian bees	5	3	
One-frame observatory hive of Golden Italian bees.....	5	3	
One-frame observatory hive of Carniolan bees.	5	3	
One-frame observatory hive of any other race or strain.....	5	3	
Display of queen-bees in cages.....	10	5	
Display of comb foundation.....	10	5	
Display of honey-plants, pressed, mounted and labeled.....	10	5	
Display of honey extracted on the ground....	10	5	
Honey-vinegar, one quart or over.....	3	2	

The judge will be governed by the code of rules adopted by the Illinois State Bee-Keepers' Association (2nd Annual Report, page 80).

The Premium-Lists are now being distributed throughout the Union. The offerings aggregate \$45,000, and the classification is greatly improved over that of last season.

The conveniences and accommodations of the Illinois State Fair grounds surpass those of any in this or any other country. Visitors will be gratified with the improvement made to the grounds since last Fair, and can rest assured that there will be no let up in the good work until the grounds present the appearance of a beautiful, high-grade park.

The State Board of Agriculture has spared no pains in the past in making the Illinois State Fair "the greatest

fair on earth," and will put forth every effort to make the coming fair greater than any of its 42 predecessors.

For a copy of the Premium List, or any further information, address the Secretary of the State Board of Agriculture, Mr. W. C. Garrard, Springfield, Ill.

Busy Supply Dealers.—At least some of the bee-supply manufacturers and dealers have been busy this season, as will be noted by the following:

The Leahy Mfg. Co., of Missouri, have this editorial note in the Progressive Bee-Keeper for July: "The supply business to date has been exceedingly good. We have sold more goods this season than any other one year heretofore."

The W. T. Falconer Mfg. Co., of New York State, say this of their business, in the July American Bee-Keeper: "June was a very busy month for us. Our customers did not seem to 'wake up' much until then, but they made up for lost time, and the month ended with a record of many more orders than June of last year."

The A. I. Root Co., in Gleanings for July 1, say: "We did not run on nine hours a day more than about a week before we had to increase to several hours over time in the section-box department in order to keep pace with orders. The prospect of a bountiful honey crop in very many localities reporting is very flattering where there were bees in condition to gather it. Unfortunately the repeated poor seasons for three or four consecutive years have discouraged many so that their bees have either all died off or are in such poor condition as to be unprepared for the bountiful honey harvest they might have secured this year had they been ready for it. The call for section-boxes has been almost unprecedented. During the nine months since Oct. 1, 1895, we have made 8,000,000 sections, which is equal to the total output for the whole year previous. We have made about one and a quarter millions so far during June, up to to-day, the 26th."

If any others of our advertisers would like to report as to their "busy-ness" this season, we will be glad to publish it. How has the queen-trade been?

Eucalyptus and Honey.—Mr. W. A. Pryal, of North Temescal, Calif., sends us the following account of a quack healer, taken from the San Francisco Examiner:

Mrs. Susan E. Currie sued "Dr." James McLean in the Justices' Court on a note for \$100 and an agreement to pay \$100 in cash and \$5 a week for eight weeks. The case came to an end yesterday when Justice of the Peace Barry, after hearing the evidence, gave judgment in favor of Mrs. Currie for \$35, saying that the only reason he did not award her the remainder was that according to the terms of the agreement into which she had entered it was not yet due.

Mrs. Currie testified that she had been a sufferer from what seemed to be nervous prostration when she heard of "Dr." McLean. She called upon him, and he told her that his powers were divine, and that he cured all diseases by means of a secret discovery. She believed him. Indeed, she admitted that she was very much impressed, and she took the treatment. Whether it was the divine power or hypuotic influence she couldn't say, but she admitted that she had given McLean a letter saying his treatment had benefited her. Later he had called on her and borrowed \$1,000 to build a hospital. As the hospital did not materialize, she had caused McLean to be indicted, but on his signing the agreement and note she had withdrawn her charges.

McLean insisted that the note had been given to stifle the charge against him, and was void. He tried to avoid telling what his treatment was, but on being pressed he said:

"Well, I gave her eucalyptus and honey."

"Where did you get your diploma?" was asked.

"I never had a license to practice medicine," he said, reluctantly; and then, brightening up, he added: "But I studied botany in Australia."

The case will not be appealed.

Now is the Time to work for new subscribers. Why not take advantage of the offers made on page 479?

PERSONAL MENTION.

SECRETARY JAS. A. STONE, of the Illinois State Bee-Keepers' Association has collected the first reports for 1896 from its members, which will be found on page 475 of this number of the Bee Journal. Most of them are not very flattering, to say the least.

MRS. A. L. HALLENBECK, of Nebraska, has the following paragraph in the July Progressive Bee-Keeper:

"The North American is to meet at Lincoln, Nebraska, this year. Well, we are not ashamed of our State, and I think the bee-keeping friends will find we are partially civilized, at least. I hope the many friends with whom I feel almost acquainted from reading our journals, will all attend, for with the blessing of Providence, I intend to be in some unobserved corner where I can get a look at least at those who are there."

We shall (if permitted to be present) look very carefully in all the "unobserved corners," for we want to be sure to see Mrs. Hallenbeck.

MR. G. M. DOOLITTLE, of Borodino, N. Y., in a letter dated July 5, wrote us as follows:

The American Bee Journal for June 25 did not put in an appearance, and I wish you would send that number to me. This is the first number that has failed to come on the Friday noon mail, in five years. It has been something worth noting, the regularity in the appearance of the American Bee Journal, at just such an hour on just such a day of the week for five years, while all of the other bee-papers seem to feel that they have no certain obligation to meet, but come straggling along just when it happens, or seemeth them good.

G. M. DOOLITTLE.

It is now a trifle over 12 years since we first became connected with the American Bee Journal, and in all that time we do not remember that it has ever once failed to leave the Chicago office exactly on the day it should go. It has sometimes been ahead of time, but not behind time. If ever in all those past years a subscriber failed to receive his copy of the Bee Journal on time, it was not our fault.

We still try to do our part faithfully, and if every subscriber would only pay his subscription as promptly as we issue the Bee Journal, all would be lovely. But we are looking for an improvement on the part of the subscribers in the future, as they will surely realize that it takes money to run a weekly paper like the American Bee Journal. And also, that it is too cheap at the price asked for it. But that is entirely to their interest.

SOMNAMBULIST (oh, to really know who that delightful, honey-toned writer is!), in referring to the Lincoln meeting of the North American, wrote thus in the last Progressive Bee-Keeper:

"If Bro. York has understood aright—that they propose to feed the crowd—wouldn't it be fun to overwhelm them with surprise as to the dimensions of that crowd? Really, truly, and sincerely, I feel just wicked enough to hope they may find their larders leaner at the close of the convention than at its beginning."

We are not going to worry a bit about those "larders," for we just know that "Uncle Whitcomb" and his good deal "better half," with other splendid Nebraska providers, will simply prepare for a big, hungry crowd, then they (both larders and crowd) will be well matched. We never expect to catch our good Nebraska friends "short on rations." They are not built that way—neither are their capacious larders. Hurrah for Lincoln, and the Whitcombs, the Stilsons, the Heaters, the—the—well, a whole lot more of those generous Nebraska people!

MR. N. W. SHULTZ, of Shreve, Ohio, when sending his renewal, wrote: "I do not want to keep bees without the Bee Journal."

Question-Box.

In the multitude of counsellors there is safety.—Prov. 11-14.

Honey-Plants that Have Disappeared or are on the Increase.

Query 23.—1. What wild honey-plants in your region have disappeared, or are disappearing, as a result of cultivation of the ground?

2. What honey-plants are on the increase in your region, or have increased within the past ten years?—MICHIGAN.

H. D. Cutting (Mich.)—2. Sweet clover.

G. M. Doolittle (N. Y.)—1. All. 2. None.

B. Taylor (Minn.)—1. White clover. 2. Alsike and sweet clover.

Emerson T. Abbott (Mo.)—1. Basswood. 2. None that I know of.

Prof. A. J. Cook (Calif.)—1. White sage is disappearing. 2. Eucalyptus.

W. R. Graham (Tex.)—1. Horsemint and ratan. 2. Cotton and sweet clover.

W. G. Larrabee (Vt.)—1. The basswood is being cut off. 2. Alsike and sweet clover.

E. France (Wis.)—1. Basswood is fast disappearing, and many wild flowers. 2. Nothing that I know of.

Dr. C. C. Miller (Ill.)—1. I don't know of any within 40 years. 2. Sweet clover, and perhaps Alsike.

C. H. Dibbern (Ill.)—1. Golden-rod, mints and other native plants. 2. Sweet clover, alsike, alfalfa, etc.

Allen Pringle (Canada)—1. Principally the basswood or linden tree—the maple and the sumach. 2. Alsike clover.

P. H. Elwood (N. Y.)—The wild raspberry is disappearing, and basswood more slowly. 2. The dandelion is on the increase.

J. E. Pond (Mass.)—1. None that I am aware of. 2. Having given no attention to the matter, I am unable to answer intelligently.

Chas. Dadant & Son (Ill.)—Dronth is killing more honey-plants than cultivation. A wet season would bring them all back, except the perennial.

J. M. Hambaugh (Calif.)—1. In Illinois white clover, linden, spanish-needle, and in fact most of the leading flora is being curtailed, and giving way to cultivated fields.

Mrs. L. Harrison (Ill.)—1. All plants growing in wet places, now tile-drained, such as boneset, Spanish-needle, polygonum, etc. 2. Sweet clover, white and yellow; now and then a plant of alfalfa.

Dr. J. P. H. Brown (Ga.)—1. The aster particularly. 2. Helenium tenuifolium. This has wonderfully increased, but the honey is no good for commercial purposes, as it is bitter. Good to promote breeding.

G. W. Demaree (Ky.)—1. Our main source for honey as a surplus—white clover—is disappearing before the tobacco craze in blue-grass Kentucky. 2. White aster—but the cut-worms of the spring of 1895 set this plant back two

THE "NOVELTY" POCKET-KNIFE!

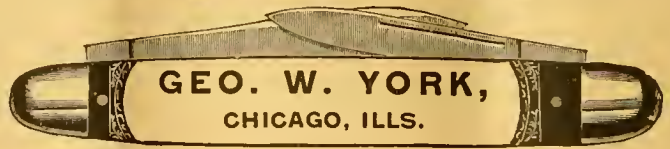

Your Name on the Knife.—When ordering, be sure to say just what Name and Address you wish put on the Knife.

The NOVELTY KNIFE is indeed a novelty. The novelty lies in the handle. It is made beautifully of indestructible celluloid, which is as transparent as glass. Underneath the celluloid, on one side of the handle is placed an AMERICAN BEE JOURNAL reminder, and on the other side, name and residence of the Subscriber.

The material entering into this celebrated knife is of the very best quality; the blades are handforged out of the very finest English razor-steel, and we warrant every blade. The bolsters are made of German silver, and will never rust or corrode. The rivets are hardened German silver wire; the linings are plate brass; the back springs of Sheffield spring steel, and the finish of handle as described above. It will last a lifetime, with proper usage.

Why purchase the Novelty Knife? In case a good knife is lost, the chances are, the owner will never recover it; but if the Novelty is lost, having name and address of owner, the finder will return it; otherwise to try to destroy the name and address, would destroy the knife. If traveling, and you meet with a serious accident, and are so fortunate as to have one of the Novelties, your pocket KNIFE will serve as an identifier; and in case of death, your relatives will at once be apprised of the accident.

How appropriate this knife is for a Christmas, New Year or birthday present! What more lasting memento could a mother give to a son, a wife to a husband, a sister to a brother, a lady to a gentleman, or vice versa, a son to a mother, a husband to a wife, a brother to a sister or a gentleman to a lady—the knife having the name of the recipient on one side?

The accompanying cut gives a faint idea, but cannot fully convey an exact representation of this beautiful knife, as the "Novelty" must be seen to be appreciated.

How to Get this Valuable Knife.—We send it postpaid, for \$1.00, or give it as a Premium to the one sending us three new Subscribers to the BEE JOURNAL (with \$3.00), and we will also send to each new name a copy of the Premium Edition of the book "Bees and Honey." We club the Novelty Knife with the BEE JOURNAL for one year, both for \$1.90.

Any Name and Address Put on the Knife.

GEORGE W. YORK & CO., CHICAGO, ILLS.

Allow about two weeks for your order to be filled.

PATENT WIRED COMB FOUNDATION

Has No Sag in Brood-Frames

Thin Flat-Bottom Foundation

Has No Fishbone in the Surplus Honey.

Being the cleanest is usually worked the quickest of any Foundation made

J. VAN DEUSEN & SONS,

Sole Manufacturers, Sprout Brook Montgomery Co., N. Y.

Mention the American Bee Journal

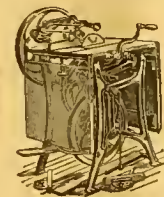

ONE MAN WITH THE UNION COMBINATION SAW

Can do the work of four men using hand tools, in Rippling, Cutting-off, Mitring, Rabbering, Grooving, Gaining, Dadoing, Edging-up, Jointing Stuff, etc. Full Line of Foot and Hand Power Machinery Sold on Trial. Catalogue Free.

SENECA FALLS MFG. CO., 46 Water St., SENECA FALLS, N. Y.

1 A1y Mention the American Bee Journal.

Dadant's Foundation in Chicago!

No other Goods kept here.

Send for Price-List.

CHAS. DADANT & SON, 118 Michigan St., CHICAGO, ILL. 13A1f Please mention the Bee Journal.

Untested Italian Queens, 75c. 3 FOR \$2.00.

Catalogue of Apiarian Supplies Free.

I. J. STRINGHAM, 105 Park Place. NEW YORK, N. Y. APIARY—Glen Cove, L. I.



That Queen-Clipping Device Free!

Works Like a Charm.

The Monette Queen-Clipping Device WORKS LIKE A CHARM. With it I have clipped 30 queens, all in one day, when examining my bees. WM. STOLLEY, Grand Island, Nebr.

Couldn't Do Without It.

I have clipped 19 queens, and must say the Monette Queen-Clipping Device is by far the best invention ever made, and will be welcome to many bee-keepers as it was to me. I could not do without one now.

DR. GEO. LACKE, Newburgh, Ind.

PLEASE READ THIS OFFER TO PRESENT SUBSCRIBERS:

Send us just one new name for the American Bee Journal a year (with \$1.00), and we will mail you the Queen-Clipping Device FREE of charge. Or, the Queen-Clipping Device will be sent postpaid for 30 cts. But why not get it as a Premium by the above offer? You can't earn 30 cts. any easier. Almost every bee-keeper will want this Device. See page 130 (Feb. 27) for full description of it. Complete directions accompany each one sent out. It is a most ingenious and useful article. Address,

GEORGE W. YORK & CO., 118 Michigan St., Chicago, Ill.



✻ MONEY SAVED IS MONEY GAINED. ✻

THE ROYAL UNION Life Insurance Company

DES MOINES, IOWA.

The Iowa Policy

Is one that definitely promises to keep an accurate account with you; credit your premiums and interest, charge the actual expense and mortuary cost, and hold the remaining funds subject to your order.
Agents Wanted.

JOHN B. KING, GENERAL AGENT,
Suite 513 First Nat'l Bank Bld'g,
20A1f **CHICAGO, ILL.**
Mention the American Bee Journal.

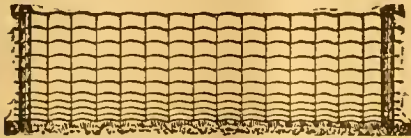

Call Next Witness!!!

Name, J. W. Dewey, residence, Cambridge, Mich., occupation, farmer. Bought 40 rods of Page in 1886—gave note payable in one year, if perfectly satisfied. Paid note before due. May 21, '96, writes "10 years to-day since put up first Page." Holds all his stock, had no repairs, and has now 500 rods in use. See copy of his note and letter in the "Hustler."

PAGE WOVEN WIRE FENCE CO., Adrian, Mich.
WHEN ANSWERING THIS ADVERTISEMENT, MENTION THIS JOURNAL.

IF YOU WANT THE

BEE-BOOK

That covers the whole Apicultural Field more completely than any other published, send \$1.25 to Prof. A. J. Cook, Claremont, Calif., for his

Bee-Keeper's Guide.

Liberal Discounts to the Trade.

Mention the American Bee Journal.

California

If you care to know of its Fruits, Flowers, Climate or Resources, send for a Sample Copy of California's Favorite Paper—

The Pacific Rural Press

The leading Horticultural and Agricultural paper of the Pacific Coast. Published weekly, handsomely illustrated, \$2.00 per annum. Sample Copy Free.

PACIFIC RURAL PRESS,
220 Market St., - SAN FRANCISCO, CAL.
Mention the American Bee Journal.

TEXAS QUEENS.

If you are in need of Queens, let me have your order. Price-List Free.

8A26t **J. D. GIVENS, Lisbon, Tex.**
Mention the American Bee Journal.

Warranted Queens

BY RETURN MAIL.

Either Golden or Leather-Colored, at \$5.00 per doz. Choice Tested Queens at \$1.00 each. I guarantee safe delivery.

F. A. CROWELL, Grainger, Minn.
25A6t *Mention the American Bee Journal.*

READERS

Of this Journal who write to any of our advertisers, either in ordering, or asking about the Goods offered, will please state that they saw the Advertisement in this paper.

or three years. Heart's-ease (smartweed) is giving away before cleaner cultivation. Our honey-resources are growing less and less all the time.

Rev. M. Mahin (Ind.)—1. Tulip tree, black gum, and several kinds of composite autumn flowers that used to grow in wet bottom-lands. 2. There is no increase of honey-producing flora, except large and small fruits.

Eugene Secor (Iowa)—1. (a) Basswood is fast disappearing. This is king of the honey-plants in this part of the country. (b) All the wild prairie flowers are becoming scarce. 2. White clover slightly; dandelion and mellilot.

R. L. Taylor (Mich.)—1. Fall flowers, on account of the drainage of swamps, basswood on account of the cutting of the timber, and white clover on account of the dry seasons late years, are all disappearing to some extent. 2. Alsike.

Jas. A. Stone (Ill.)—1. All the wild flowers that grow on prairies. 2. Sweet clover, Alsike clover, crimson clover, alfalfa, heart's-ease, and we might say white clover has come in since the wild flowers were destroyed, but not in the last ten years.

General Items.

Illinois State Members' Reports.

According to the instructions of the last convention of the Illinois State Bee-Keepers' Association, the Secretary recently mailed postal cards to the members, who up to this date (July 16) have reported as follows to these four questions:

1. How many colonies have you?
2. What are the prospects for a honey crop?
3. How much honey gathered to date?
4. Is the honey gathered No. 1 or not?

J. A. Green, Ottawa, June 30—1. 120. 2. Good. 3. None taken from hives yet; 2,500 pounds, estimated. 4. No. 1.

M. M. Baldrige, St. Charles, July 1—1. 19. 2. Fair. 3. Cannot say; none extracted yet. 4. Should be No. 1, being a combination of basswood, sweet clover and white clover.

W. C. Lyman, Downers Grove, June 29—1. 50. 2. Light crop. 3. None ready to take off. 4. Good, what there is.

E. West, Chanuahan, July 1—1. 60. 2. Very poor. 3. None to speak of. Season is good for late crop.

W. B. Blume, Norwood Park, July 3—1. 38, spring count. 2. Good. 3. 75 pounds. 4. No. 1.

J. C. Wheeler, Plano, July 3—1. 405 in five places. 2. Poor. 3. 2,500 pounds of extracted and 1,000 pounds of comb from linden and clover. 4. Extracted is amber, and comb white.

L. C. Francis, Springfield, July 11—1. 10. 2. The fall prospect appears good. 3. But very little.

Elias Robinson, Carmi, July 7—1. 65. 2. Very poor. 3. About 100 pounds. 4. Good.

Daniel E. Robbins, Payson, July 2—1. 29. 2. Not good. 3. Very little. 4. Have not taken any off, so I do not know.
Chas. Dadant & Son, Hamilton, June

Honey-Clovers & Buckwheat SEED FOR SALE.

We have made arrangements so that we can furnish seed of several of the Clovers and Japanese Buckwheat, by freight or express, at the following prices, cash with order

	5lb	10lb	25lb	50lb
Alsike Clover	\$.70	\$1.25	\$3.00	\$ 5.75
Sweet Clover	.75	1.40	3.25	6.00
White Clover	1.25	2.00	4.50	8.00
Alfalfa Clover	.65	1.10	2.70	5.00
Crimson Clover	.55	.90	2.00	3.50
Jap. Buckwheat	.20	.35	.90	1.25

Prices subject to market changes.

Add 25 cents to your order, for cartage, if wanted by freight.

Your orders are solicited.

GEORGE W. YORK & CO.,
CHICAGO, ILLS.

Sweet Clover Canada.

At the following prices:

5 lbs.	10 lbs.	25 lbs.	50 lbs.
\$1.00	\$1.60	\$3.75	\$7.25

Also a quantity of Motherwort and Catnip seed. Prices on application.

EGGS for Hatching. Buff Leghorns, Indian Games, & Light Brahmans. Choice Birds. A breeder for 30 years. Prices on application

JOHN McARTHUR,
881 Yonge Street, - TORONTO, ONT.
15A1f *Mention the American Bee Journal.*



Promptness Is What Counts!

Honey-Jars, Shipping-Cases, and everything that bee-keepers use. **Root's Goods at Root's Prices,** and the best shipping point in the country.

Dealer in Honey and Beeswax. Catalogue Free.

Walter S. Ponder
162 Mass. Ave. INDIANAPOLIS, IND.

HONEY We have a large amount of Pure No. 1 Alfalfa we will sell cheap.

Wax Wanted.

Boss bee-escape Warranted the best, simplest and quickest Escape on the market. Sent postpaid to any address for 30 cts. It can be returned at our expense if it is not as represented, or we will send the Escape on trial to any bee-keeper wishing to test it in good faith. We are agents for the **Ferguson Patent Hive** with double-case Super and Wicket-Gate Honey-Board, with the Escape. It is the easiest, quickest hive to handle for the production of comb honey. Address,

E. S. LOVESY & CO.,
355 6th East St., SALT LAKE CITY, UTAH.
Mention the American Bee Journal. 9A1f

Van Dusen Foundation!

I have some of the celebrated Van Dusen Thin Foundation in 25-pound boxes, that I will put on board cars for \$12.50 per box.

Also ITALIAN

Queens! Queens!

Fine Untested Queens mailed PROMPTLY at 55 cts. each, or Six for \$3.00.

Safe delivery and satisfaction guaranteed. Address,

F. GRABBE,
LIBERTYVILLE, Lake Co., ILL.

26A1f *Mention the American Bee Journal*

BEGINNERS.

Beginners should have a copy of the Amateur Bee-Keeper, a 70-page book by Prof. J. W. Rouse. Price 25 cents; if sent by mail, 28c. The little book and the Progressive Bee-Keeper (a live, progressive 28-page monthly journal) one year, 65c. Address any first-class dealer, or

LEAHY MFG. CO., Higginsville, Mo.

No. 1 Sections—Cheap.

We offer for a few weeks, a surplus stock of our one-piece **No. 1 Cream Sections** at the following very low prices:

1000 for \$1.50.

3000 for \$4.00.

5000 for \$6.00.

☐ These Sections are finely finished and No. 1 in all respects save color, being, as their name indicates, of a cream color.

The stock consists of a quantity each of the following sizes:

4½x2, open 2 sides 4¼x1 15-16, open 2 sides
4¼x1 7-8, open 2 sides
4¼x1½, open 2 sides 4¼x7-to-ft., open 2 sides

G. B. LEWIS CO.

WATERTOWN, WIS.

ITALIAN QUEENS

Golden or Leather-Colored!
BY RETURN MAIL.

Fine Untested, 60c. each; two, \$1.00. Select Untested, 75c. Tested, \$1.00 Full Colonies cheap. No disease. Remit by express money order, payable at Barnum, Wis. Many customers send \$1.00 and \$2.00 bills. 2c. stamps taken for less than \$1.00. Safe delivery and satisfaction guaranteed.

P. S.—57 choice 2-yr.-old Queens, 25c. each while they last.

VAN ALLEN & WILLIAMS,
BARNUM, WIS.

29Atf Please mention the Bee Journal.

Page & Lyon Mfg. Co.,

NEW LONDON, WIS., operates two saw-mills that cut, annually, eight million feet of lumber, thus securing the best lumber at the lowest price for the manufacture of bee-keepers' supplies. They have also just completed one of

The Largest Factories,

and have the latest and most improved machinery for the manufacture of Bee-Hives, Sections, etc., that there is in the State. The material is cut from patterns, by machinery, and is absolutely accurate. For Sections, the clearest and

The Whitest Basswood

is used, and they are polished on both sides. Nearness to pine and basswood forests, and possession of mills and factory equipped with best machinery, all combine to enable this firm to furnish the best goods at

The Lowest Prices. ♡

For instance, it has a job lot of 200,000 No. 2 Sections that will be sold at 50 cts. per 1,000; or 2,000 Snow-White sections will be sold for \$4.00, and larger quantities at still lower prices. Send for Circular and see the prices on a full line of supplies. 16Atf

History of the Adels

IN CARNIOLA there are two strains of Bees—one is gray or steel-colored, the other is yellow. The natives consider the yellow strain the best, and call them "THE ADELS." Adel means superior—and they are superior to all others. The Queens are very hardy and prolific; the Bees great workers, store and cap their honey nicely, and are sure to winter in 'most any climate on the summer stands. The bees are gentle and seldom sting even when no smoke is used. I have had six years' experience with them, and never have had a swarm. Can ship 200 Queens by return mail. Everything guaranteed.

Our new Catalog giving way to introduce Queens, and testimonials, ready to mail.

One Queen, \$1; 2 Queens, \$1.90; 3 Queens, \$2.50; 6 Queens, \$4.50; 12 Queens, \$8.00. Tested Queens, \$1.50.

☐ Italian Queens same prices.

HENRY ALLEY,

28A4t

WENHAM, MASS.

26—1, 325. 2. Fair. 3. About 2,000 pounds. 4. Yes.

C. C. Miller, Marengo, June 25—1. About 160. 2. Piles of clover; weather rather cool. 3. Perhaps 1,500 pounds on the hives. 4. Yes.

A. Y. Baldwin, DeKalb, June 25—1. Spring count, 64; put into cellar last fall, 104. 2. Nothing brilliant. 3. Nothing yet; just commencing a little in the supers.

S. N. Black, Clayton, June 26—1. 12. 2. Very poor; but little white clover. 3. No surplus.

A. J. Emmons, Greenfield, June 25—1. 38. 2. Poor. 3. All in hives yet. 4. Yes; white clover.

W. G. Secor, Greenfield, June 25—1. 35. 2. Not very good. 3. Have taken none off. 4. Yes; white clover.

C. A. Stewart, St. Charles, June 25—1. 15. 2. Fair. 3. None.

T. J. Ferrill, Cobden, June 26—1. 28. 2. Very poor; have had too much rain. 3. About 340 pounds. 4. About half is No. 1.

A. P. Raught, Volo, June 26—1. 8. 2. Good. 3. About 150 pounds. 4. No. 1; white clover.

S. H. Herrick, Rockford, June 27—1. 18. 2. Fair. 3. None taken off; bees working on basswood now. 4. Clover and basswood; can't tell how well it will be finished up.

M. Bevier, Bradford, June 27—1. 50—32 old and 18 new ones. 2. Good. 3. Have not taken any off yet, but sections are nearly full.

Geo. F. Robbins, Mechanicsburg, June 29—1. 41. 2. There will be no clover honey crop. 3. None; bees barely living. 4. No. 1.

R. Miller, Compton, June 28—1. 100. 2. Fair. Too cold and too wet.

W. T. Talbot, Farmingdale, June 25—1. 22. 2. Very good. 3. About 50 pounds. 4. All A 1.

Peter Blunier, Roanoke, June 29—1. 54, spring count, and about 100 now. 2. Good. 3. About 75 pounds taken off, but a good lot ready to take off. 4. I never saw prettier honey.

J. Roorda, DeMotte, Ind., July 15—1. 80. 2. Very good. 3. 30 pounds per colony. 4. All white honey.

JAS. A. STONE, Sec.

Bradfordton, Ill.

Bees Doing Splendidly.

Bees are doing splendidly here on sweet and white clover, and catnip.

D. L. DURHAM.

Kankakee, Ill., July 13.

Worst Drouth Known.

We are having the worst drouth that has ever been known in this valley. Bees are doing poorly. GEO. H. EVERSOLE.
La Plata, New Mex., July 11.

An Extra-Good Season.

This has been an extra-good season. It was dry for a short while, but we are having lots of rain now.

J. O. GRIMSLEY.

Beeville, Tex., July 14.

Bees Doing Well.

Bees here wintered fairly well last winter, and seem to be doing well at present. They have increased more than usual this summer, one bee-keeper

The Bee-Keepers' Guide:

Or Manual of the Apiary,

BY PROF. A. J. COOK.

This 15th and latest edition of Prof. Cook's magnificent book of 460 pages, in neat and substantial cloth binding, we propose to give away to our present subscribers, for the work of getting NEW subscribers for the American Bee Journal.

A description of the book here is quite unnecessary—it is simply the most complete scientific and practical bee-book published to-day. Fully illustrated, and all written in the most fascinating style. The author is also too well-known to the whole bee-world to require any introduction. No bee-keeper is fully equipped, or his library complete, without "THE BEE-KEEPER'S GUIDE."

Given For 2 New Subscribers.

The following offer is made to PRESENT subscribers only, and no premium is also given to the two new subscribers—simply the Bee Journal for one year:

Send us Two New Subscribers to the Bee Journal (with \$2.00), and we will mail you a copy of Prof. Cook's book FREE as a premium. Prof. Cook's book alone sent for \$1.25, or we club it with the Bee Journal for a year—both together for only \$1.75. But surely anybody can get only 2 new subscribers to the Bee Journal for a year, and thus get the book as a premium. Let everybody try for it. Will you have one?

GEORGE W. YORK & CO.,
CHICAGO, ILLS.

A Bargain—EARLY QUEENS.

119 Colonies Italian Bees in Chaff Hives; two acres land; good house; excellent well.

Early Queens—Tested, \$1.00; Untested, 50c. Sent by return mail.

E. L. CARRINGTON,
16Atf PETTUS, Bee Co., TEX.

Reference—1st National Bank of Beeville.
Mention the American Bee Journal.

SPECIAL OFFER!

Warranted Queens, bred from best Imported or Home-bred Queens at 55 cts. each; ¼ doz., \$3.00. Untested, 50 cts.; ½ doz., \$2.90. Tested, 70 cts.; ½ doz., \$3.70. 500 Queens ready to ship. LEININGER BROS.,
30Etf FT. JENNINGS, OHIO.

Mention the American Bee Journal.

Full Colonies of Italian Bees for \$4.00. or particulars see larger ad. on page 350 of this paper. Tested Queens, a fine lot, by return mail, 50 cts. each.

Address, T. H. KLOER,
426 Willow St., TERRE HAUTE, IND.

29A4t Mention the American Bee Journal.

WOVEN WIRE FENCE

Over 50 Styles The best on Earth. Horse high, Bull strong, Pig and Chicken tight. You can make from 40 to 60 rods per day for from 14 to 22c. a Rod. Illustrated Catalogue Free. KITSELMAN BROS., Ridgeville, - Indiana.

48Etf Mention the American Bee Journal.

ITALIAN BEES.

Untested Queens, \$1.00. Tested, \$1.25. Bees by the lb., \$1.00. Nucel—Two frame, with Queen, \$2.50; one frame, \$2.00.

Also, Banded and White Plymouth Rock Eggs for setting; \$1.00 for 15.

Mrs. A. A. SIMPSON,
18E7t SWARTS, PA.

Mention the American Bee Journal.

MUTH'S HONEY EXTRACTOR

Square Glass Honey Jars, Etc.
For Circulars, apply to CHAS. F. MUTH & SON, Cor. Freeman & Central Aves., Cincinnati, O. Send 10c for Practical Hints to Bee-Keepers.

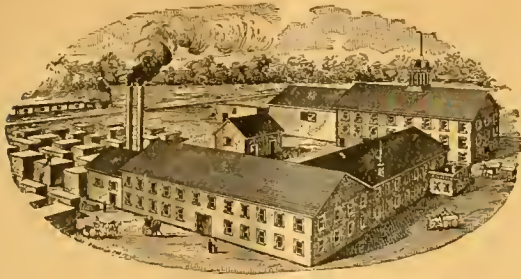

BEE-SUPPLIES!

We have the best equipped Factory in the West. Capacity—one carload a day; and carry the largest stock and greatest variety of every thing needed in the apary, assuring **BEST** goods at the **LOWEST** prices, and prompt shipment.

Illustrated Catalog, 80 pages. **Free.**

22Est Address, **E. KRETCHMER, Red Oak, Iowa.**

that only had four old colonies now has 11, and claims four or five have skipped (not by the light of the moon, but by the sun) for the woods. My eight old colonies have increased to 21, and one left without even saying "good-bye." However, I found one in the woods July 4, so I have 22 at present. Some have secured some surplus, and the hives of old colonies and early new ones are generally well filled. L. J. CLARK.
Wiscoy, Minn., July 13.

No Surplus Honey.

There is no surplus honey in these parts. I think we will be fortunate if bees get enough to carry them through the season. L. T. HARPER.
San Jacinto, Calif., July 8.

Crop Injured by Rains.

The continued hard rains have greatly injured our honey crop, but the prospects for late summer and fall are somewhat encouraging at present. J. A. GOLDEN.
Reinersville, Ohio, July 14.

Doing Fairly Well on Basswood.

Basswood is in full bloom about two weeks earlier than usual, but the bees are doing fairly well upon it. There cannot be as large a yield as at other times, for the bees are not as advanced according to the season as is vegetation. G. M. DOOLITTLE.
Borodino, N. Y., July 6.

Bees Tumbling Over Each Other.

I have 60 colonies at this writing, and they are tumbling over each other to get in and out of the hives, so eager are they to get their share of the splendid crop of clover and basswood honey. I have close to 1,000 pounds of section honey in sight now.

Of the 44 colonies put into "cold storage" Dec. 3, 1895, 44 came out all right. L. M. WILLIS.
Loyal, Wis., July 10.

Poisonous Honey.

In north Texas we have a species of *spurge* closely allied to that from which *croton-oil* is made, which yields an abundance of poisonous honey every season. There is enough of this honey, where the plant abounds, to completely ruin the market value of the fall crop gathered after Aug. 1. In some localities bees become rich in stores from this plant. It can be used for spring feeding with safety. Taken as food it produces a burning sensation in the throat and

stomach; also vomiting and purging. I have never known serious results to obtain, as the stomach throws it off too soon.

Any one wishing to test the peculiar qualities of this, may, by paying express charges, obtain a sample from me, as I have a few unfinished sections two years old.

This is my "say" on poisonous honey, from an experience of over 20 years in Texas. WM. R. HOWARD, M. D.
Fort Worth, Tex., July 10.

Very Dry Season.

The season in southern California this year is very dry. The bees in the mountains are suffering for food. In the valleys and foothills the bees are in fair condition. I took 3,000 pounds of honey from 140 colonies in the month of April. My bees are in the foothills, and are in a healthy condition by reason of good care. FRANK S. BUCHHEIM.
Santa Ana, Calif., July 5.

Basswood a Failure.

Basswood is an entire failure throughout the "great belt" of Wisconsin. It came and is gone without a drop of nectar. It blossomed more profusely than ever, but failed to secrete nectar, although the weather was the most favorable during its bloom. So now, we poor bee-keepers must report an entire failure from that source. E. A. MORGAN.
Chippewa Falls, Wis., July 10.

Doolittle's Book—Have You Read It?

Queens and Queen-Rearing.—If you want to know how to have queens fertilized in upper stories while the old queen is still laying below; how you may *safely introduce* any queen, at any time of the year when bees can fly; all about the different races of bees; all about shipping queens, queen-cages, candy for queen-cages, etc.; all about forming nuclei, multiplying or uniting bees, or weak colonies, etc.; or, in fact, everything about the queen-business which you may want to know—send for Doolittle's "Scientific Queen-Rearing"—a book of over 170 pages, which is as interesting as a story. Here are some good offers of this book:

Bound in cloth, postpaid, \$1.00; or clubbed with the BEE JOURNAL for one year—both for only \$1.75; or given free as a premium for sending us three new subscribers to the BEE JOURNAL for a year at \$1.00 each.

Bee-Keeper's Guide—see page 476.



GEORGE W. YORK & CO.,
At One Dollar a Year,

CHICAGO, ILLS.

Postage to all Countries in the Postal Union is 50 cents extra. To all others, \$1.00 more than the subscription price.

Hebblewhite & Co., 369 George Street, Sydney, New South Wales, Australia, are our authorized agents. Subscription price, 6 shillings per annum, postpaid

Important to All Subscribers.

The American Bee Journal is sent to subscribers until an order is received by the publishers for its discontinuance, and all arrearages are paid.

Always State the Post-Office to which your paper is addressed, when writing to us.

A Sample Copy of the Bee Journal will be sent FREE upon application.

How to Send Money.—Remit by Express, Post-Office Money Order, or Bank Draft on New York or Chicago. If none of these can be had, Register your Letter, affixing Stamps both for postage and registry, and take a receipt for it. Money sent thus, IS AT OUR RISK; otherwise it is not. Do not send Checks on Local Banks—we have to pay 25 cents each, to get them cashed.

Never Send Silver in letters. It will wear holes in the envelope, or may be stolen.

Money Orders.—Make all Money Orders payable at Chicago, Ill.—not at any sub-station of Chicago.

Postage Stamps of any denomination may be sent for any fraction of a dollar; or where Money Orders cannot be obtained, stamps for any amount may be sent.

Subscription Credits.—The receipt for money sent us will be given on the address-label of every paper. The subscription is paid to the end of the month indicated.

Do not Write anything for publication on the same sheet of paper with business matters, unless it can be torn apart without interfering with either part of the letter.

Lost Numbers.—We carefully mail the Bee Journal to every subscriber, but should any be lost in the mails, we will replace them if notified before all the edition is exhausted. Please don't wait a month or two, for then it may be too late to get another copy.

Emerson Binders, made especially for the American Bee Journal, are convenient for preserving each weekly Number, as fast as received. They will be sent, postpaid, for 75 cents, or clubbed with the American Bee Journal for one year—both together for \$1.00. They cannot be sent by mail to Canada.

10 per ct. Off to Reduce Stock

on all kinds of SUPPLIES, except

—COMB FOUNDATION—

which will be sold in lots of 10 lbs. or more as follows: Medium, 35 cts.; Light, 36 cts.; Thin Surplus, 40 cts.; Extra Thin, 45 cts.

Queens—Warranted, 50c.; Tested, 75c.
W. J. FINCH, Jr., SPRINGFIELD ILLS.

HONEY and BEESWAX

MARKET QUOTATIONS.

The following rules for grading honey were adopted by the North American Bee-Keepers' Association, and, so far as possible, quotations are made according to these rules:

FANCY.—All sections to be well filled; combs straight, of even thickness, and firmly attached to all four sides; both wood and comb unsoiled by travel-stain, or otherwise; all the cells sealed except the row of cells next the wood.

No. 1.—All sections well filled, but combs uneven or crooked, detached at the bottom, or with but few cells unsealed; both wood and comb unsoiled by travel-stain or otherwise.

In addition to this the honey is to be classified according to color, using the terms white, amber and dark. That is, there will be "fancy white," "No. 1 dark," etc.

Chicago, Ills., July 7.—We quote: Fancy white clover, 15c.; No. 1 white, 12@13c.; fancy amber, 10@11c.; No. 1 amber, 7@9c.; fancy dark, 9@10c.; No. 1 dark, 7c. Extracted, white, 5@7c.; amber, 5@5½c.; dark, 4½@5c. Beeswax, 25@27c.

Philadelphia, Pa., July 10.—No. 1 amber, 9-10c.; fancy dark, 8-9c.; No. 1 dark, 7-8c. Extracted, white, 8-10½c.; amber, 5-5½c.; dark, 3¼-4c. Beeswax, 25-26c. Honey very dull. Beeswax in fair demand.

Buffalo, New York, July 1st.—We quote: Fancy white, 15@16c.; No. 1 white, 13@14c.; fancy dark, 8@9c.; No. 1 dark, 7@7½c. Beeswax, 25@28c. Trade very dull and honey not moving, except a few fancy lots; anything dark is hard to sell.

Cincinnati, Ohio, July 10.—No. 1 white, 13@14c.; fancy amber, 12@13c.; No. 1 amber, 10@12c. White, extracted, 5@7c.; amber, 5@6c.; dark, 3¼-5c. Beeswax, 20-25c.

New York, N. Y., June 24th.—No demand for comb honey of any kind. New crop of Southern extracted is arriving freely, and sells fairly good at 50@52c per gallon for common, and 55@60c per gallon for better grades. Beeswax dull at 26@27c.

Kansas City, Mo., July 8th.—We quote: Fancy white comb, 15@14c.; No. 1 white, 12@13c.; fancy amber, 11@12c.; No. 1 amber, 10@11c.; fancy dark, 9@10c.; No. 1, 8@9c. Extracted, white, 6@6½c.; amber, 5@5½c.; dark, 4@4½c. Beeswax, 22@25c.

Cleveland, Ohio, July 9.—We quote: Fancy white, 15@16c.; No. 1 white, 14@15c.; fancy amber, 10@11c. Extracted, white, 6@6½c.; amber, 4@5c. Beeswax, 20@25c.

Our market is nearly bare of honey. We think early shipments would meet with ready sales at about quotations.

St. Louis, Mo., July 9.—We quote: Fancy white, 11½@12c.; No. 1 white, 10½@11c.; fancy amber, 10@10½c.; No. 1 amber, 9@10c.; fancy dark, 8½@9c.; No. 1 dark, 7@8c. Extracted, white, in cans, 5c.; in barrels, 4c.; amber, 3¼@4c.; dark, 3@3¼c. Beeswax, 25@25½c.

This week we sold 4,700 pounds of Southern extracted in barrels at 3½c. Honey is in fair demand. Very little fancy new comb coming in, and what has been offered not well cured as yet.

Minneapolis, Minn., July 9.—We quote: Fancy white, 15c.; No. 1 white, 13@14c.; fancy amber, 10@12c.; No. 1 amber, 8@10c.; fancy dark, 7@9c.; No. 1 dark, 8c. Extracted, white, 5¼@6¼c.; amber, 5¼@5½c.; dark, 4¼@5¼c. Beeswax, 26@28c.

Actual transactions both in comb and extracted very light. Minnesota and Wisconsin comb will commence arriving in moderate quantities about August, and will probably supply the market until cool weather, which usually stimulates a demand. Considerable extracted is now here on the spot, sufficient to supply immediate wants.

Albany, N. Y., July 10.—Fancy white, 13-14c.; fancy dark, 8-9c.; No. 1 dark, 6-7c. Extracted, dark, 4-5c.

Stock of old comb honey is reduced to a few cases of 2-pound buckwheat and some 1-pound white California, which we expect to close out before new crop arrives on market. Conditions are favorable in this section for a good crop of white honey.

Milwaukee, Wis., July 13.—No. 1 white, 12-13c.; No. 1 amber, 8-10c. Extracted, white, 7-7½c.; amber, 6-6½c.; dark, 5-6c. Beeswax, 20-24c.

The supply of honey is not large and nearly all old crop, as the receipts of new are extracted; quality fair. The demand is limited, as the supply of small fruits is large and the consumption of honey is small. The market will be in good condition for shipments of the new crop, both comb and extracted, and we look for a good demand later.

Detroit, Mich., July 13.—No. 1 white, 11-12½c.; fancy amber, 10-11c.; No. 1 amber, 9-10c.; fancy dark, 8-9c.; No. 1 dark, 7-8c. Extracted, white, 6-7c.; amber, 5-6c.; dark, 5c. Beeswax, 24-25c.

There is very little old honey on the market that is desirable. New honey will sell slowly in this market until October.

Boston, Mass., July 15.—Fancy white, 14-15c.; No. 1 white, 12-13c.; fancy amber, 9-10c. Extracted, white, 6-7c.; amber, 5-6c. Beeswax, 25-26c.

Fancy new white honey now in stock; demand fair. Old stock nearly closed out.

List of Honey and Beeswax Dealers.

Most of whom Quote in this Journal.

Chicago, Ills.

R. A. BURNETT & Co., 163 South Water Street.

New York, N. Y.

HILDRETH BROS. & SEGLKEN,
120 & 122 West Broadway.
CHAS. ISRAEL & BROS., 486 Canal St.

Kansas City, Mo.

C. C. CLEMOMS & Co., 423 Walnut St.

Buffalo, N. Y.

BATTERSON & Co., 167 & 169 Scott St.

Hamilton, Ills.

CHAS. DADANT & SON.

Philadelphia, Pa.

WM. A. SELSER, 10 Vine St.

Cleveland, Ohio.

WILLIAMS BROS., 80 & 82 Broadway.

St. Louis, Mo.

WESTCOTT COM. CO., 213 Market St.

Minneapolis, Minn.

S. H. HALL & Co.

Milwaukee, Wis.

A. V. BISHOP & Co.

Boston, Mass.

E. E. BLAKE & Co., 57 Chatham Street.

Detroit, Mich.

M. H. HUNT, Bell Branch, Wayne Co., Mich.

Cincinnati, Ohio.

C. F. MUTH & SON, cor. Freeman & Central avs.

North American Bee-Keepers' Association

OFFICERS FOR 1896.

PRESIDENT—A. I. Root.....Medina, Ohio.

VICE-PRES.—Wm. McEvoy.....Woodburn, Ont.

SEC.—Dr. A. B. Mason.....Sta. B, Toledo, Ohio.

TREAS.—W. Z. Hutchinson.....Flint, Mich.

Convention at Lincoln, Nebr.

National Bee-Keepers' Union.

PRESIDENT—Hon. R. L. Taylor..Lapeer, Mich.

GEN'L MGR.—T. G. Newman...San Diego, Cal.

Convention Notices.

TEXAS.—The Central Texas Bee-keepers' Association meets at Cameron, Tex., Aug. 7 and 8, 1896. No hotel bills to pay.

Chriesman, Tex. C. B. BANKSTON, Cor. Sec.

TEXAS.—The third annual convention of the Southwest Texas Bee-Keepers' Association will be held at Beeville, Tex., on Sept. 16 and 17, 1896. All are invited. No hotel bills to pay. Low rates on railroads.
Beeville, Tex. J. O. GRIMSLEY, Sec.

PLANTS TO BE NAMED.

By DR. H. S. PEPOON,

936 Belleplaine Ave., Station X, Chicago, Ill.

Day-Flower.

The plant sent by a Texas reader belongs to the same family as our common "spiderwort" or "snakeweed," and is usually known by the name of "day-flower," from the fact that its bright blue but short-lasting flowers open only during bright sunshine. It is a plant that thrives on sandy soil (the more sand the better), and could be very easily grown from cuttings, after the manner of the cultivated "wandering Jew," a near relative.

Willow-Herb or Fireweed.

I send a sample of a weed which is very plentiful around here. The bees work on it for all they are worth. It grows on sandy soil the next year after it has been burnt over. Some call it "fireweed," others "milkweed," and others something else. Please give its correct name in the Bee Journal.

I have been keeping bees six years, and have been very successful with them. C. P. C.

Boyer City, Mich.

This showy plant is known by the common names of "willow-herb," and especially by "fireweed," from its habit of growing in burned districts. It particularly delights in low grounds, choosing newly-cleared lands by preference. It is a perennial, but easily grown from seed, and belongs to the same family as the "evening primroses."

Partridge-Pea.

I send a plant to name. When abundant it is one of the most valuable honey-plants we have. It used to be very abundant in the wheat and oat fields, after harvest, but continued fallowing has about eradicated it except along the roadsides and in the low grounds that are rarely cultivated. It is a beautiful flower, and the honey it yields is second to none. One year I secured about 5,000 pounds of it. The color is almost as light as white clover honey, and in quality it is, in my opinion, fully equal to it. It is just beginning to bloom (July 4) and fits in nicely between white clover and the fall flowers. It usually grows about a foot to 20 inches high, and the color of the blossom is a beautiful yellow, with a dark center. I know of no common name for it, but call it the "locust plant," because its leaves resemble somewhat those of our common black locust, only on a smaller scale.

Belleville, Ill. E. T. F.

This plant is the "partridge pea," or *Cassia chamaecrista*, and belongs to the pea or pulse family, and is a relative of the locusts, peas, beans, clovers, etc. It flourishes especially in rather sandy soils, and doubtless could easily be grown from seed, as it is an annual plant. It is particularly at home on bottom-lands that have a dryish, sandy soil.

See the premium offers on next page.

Now for a 2-Month Campaign

Please Read All of this Page.

A Few of the Good Things to Appear in the
Bee Journal Yet This Year :

Fifteen Years' Experience in Bee-Keeping.

Mrs. Sallie E. Sherman, of Texas, began, in the first number for July, a full account of her 15 years of bee-keeping in Texas. An article from her will appear each week for a number of weeks. They will be of much interest to all, and especially so to Southern bee-keepers.

A Dozen Articles by "The Dadants."

Chas. Dadant & Son, of Illinois, are the leading extracted honey producers of this part of the country. One year they had 48,000 pounds. They will contribute during the next six months, at least a dozen articles, drawn from their experience of a third of a century of bee-keeping.

A Dozen Articles by Mr. Doolittle.

G. M. Doolittle is unquestionably one of the very ablest bee-keepers in this country, and his writings on practical bee-culture have made him famous. With his 27 years' experience, he is well equipped to write profitably for the beginner or even the expert bee-keeper.

A Half-Dozen Articles by Prof. Cook.

Prof. A. J. Cook, of California, author of "The Bee-Keepers' Guide," will contribute at least six good articles before Jan. 1, 1897. He is always interesting and helpful.

A Full Report of the North American Convention

will be published in this paper immediately after the annual meeting, which will be held in September or October next, at Lincoln, Nebr. The Secretary—Dr. A. B. Mason—is now at work on the program, which promises to be the best ever gotten up by the Association. Every American bee-keeper will be interested in the many valuable essays and discussions found in the proceedings of their great annual convention.

A Variety of Contributions by Many Others,

who are well qualified to teach modern bee-culture, will also appear during the next six months. All the foregoing in addition to the

Several Special or Regular Departments

will make the American Bee Journal almost priceless to the man or woman who desires to make a genuine success of bee-culture, and keep informed about the doings of the apiarian world.

Some Liberal Premiums to Regular Subscribers.

We want every regular reader of the American Bee Journal to go to work to secure new subscribers, which we will accept at

40 Cents for the Next Six Months.

Yes, sir; we will mail the American Bee Journal from July 1, 1896, to Jan. 1, 1897—26 numbers in all—to any one not now a subscriber, for just 40 cents. And to those of our present subscribers who will work to get the new names, we make these

Generous Premium Offers :

For sending us One New Six-Months' Subscription (with 40 cents), we will mail the sender his or her choice of one of the following list of pamphlets :

Foul Brood, by Dr. Howard.	Dr. Foote's Hand-Book of Health.
Kendall's Horse-Book.	Poultry for Market and Profit.
Rural Life.	Our Poultry Doctor.
Silo and Silage, by Prof. Cook.	Turkeys for Market and Profit.
Foul Brood, by Kohnke.	Capons and Caponizing.

For sending Two New Six-Months' Subscriptions (with 80 cents), your choice of one of the following :

Monette Queen-Clipping Device.	Winter Problem, by Pierce.
Bienen-Kultur.	Alley's 30 Years Among the Bees.
Bees and Honey (paper cover).	Queenie Jeanette (a Song.)

For sending Six New Six-Months' Subscriptions (with \$2.40), your choice of one of the following :

Novelty Pocket-Knife (with name). Prof. Cook's Bee-Keeper's Guide

\$25.00 Cash, in Addition to the Above.

Besides all the foregoing premiums, we will distribute, on Sept. 1, 1896, \$25.00 in cash to the nine having sent in the highest number of new 40-cent subscriptions before that date, (but only those having sent 10 or more new subscriptions can compete for the extra cash premiums) in these amounts : To the one sending the highest number, \$10.00. The 2nd highest, \$5.00; 3rd, 4th and 5th highest, \$2.00 each; and to the 6th, 7th, 8th and 9th highest, \$1.00 each.

Let Every One Begin NOW to Work.

We will be glad to mail free sample copies, upon request, either to a club-raiser, or direct to those you desire to solicit, if you will send in the names and addresses.

All subscriptions will begin with the first number in July.

Yours for a two-months' campaign,

GEO. W. YORK & CO., 118 Mich. St., Chicago.

"Samantha at the World's Fair."—We want to make our present readers one of the best offers ever made. All know the excellent books written by "Samantha, Josiah Allen's Wife." Well, "Samantha at the World's Fair" is probably her best, and we are enabled to offer *this book and a year's subscription to the New York "Voice"* (the greatest \$1.00 weekly temperance paper published to-day), for sending us *only three new subscribers* to the American Bee Journal (with \$3.00), provided you are *not now* a subscriber to the "Voice." Think of it—a grand book and a grand weekly temperance newspaper *given simply for sending us three new subscribers* to the Bee Journal for a year! The Samantha book is exactly the same as the \$2.50 one, only the binding is of heavy manilla instead of cloth. It is a special 100,000-copy edition, and when they are all gone, the offer will be withdrawn by the publishers. Of course, no premium will also be given to the new subscribers—*simply the American Bee Journal for one year.*

Only One Cent a Copy for copies of the American Bee Journal before Jan. 1, 1896. We have them running back for about 10 years. But you must let us select them, as we cannot furnish them in regular order, and probably not any particular copies. Just send us as many one-cent stamps as you may want old copies, and we will mail them to you.

Honey as Food and Medicine.—A new and revised edition of this 32-page pamphlet is now issued. It has 5 blank pages on which to write or paste recipes taken from other sources. It is just what its name indicates, and should be liberally distributed among the people everywhere to create a demand for honey. It contains a number of recipes on the use of honey as food and as medicine, besides much other interesting and valuable information. Prices, postpaid, are: Single copy, 5 cts.; 10 copies 30 cts.; 50 for \$1.00; 100 for \$1.75. Better give them a trial. Send all orders to the Bee Journal office.

Bottom Prices

**BRING US BIG TRADE.
GOOD GOODS KEEP IT.**

If you want the best supplies that can be made at a little less cost than you can buy the same goods for elsewhere, write to us for low prices. 1896 Catalogue now ready—ask for it and a free copy of **The American Bee-Keeper** (36 pages).

Address,
**THE W. T. FALCONER MFG. CO.,
JAMESTOWN, N. Y.**

Mention the American Bee Journal.

COMB FOUNDATION!

Wax always wanted for Cash or in Exchange for Fdn. or other Supplies. My trade is established on **Low Prices and the merit of my Foundation. Orders filled promptly.**
WORKING WAX INTO FDN. BY THE LB. A SPECIALTY. Wholesale prices to dealers and large consumers. Send for Prices and Samples to—**GUS DITTMER, AUGUSTA, WIS.**
Reference—Augusta Bank. 1Atf

Mention the American Bee Journal.

I ARISE



TO SAY to the readers of the **BEE JOURNAL** that **DOOLITTLE**

has concluded to sell—**BEEES and QUEENS**—in their season, during 1896, at the following prices:

- One Colony of Italians on 3 Gallup frames, in light shipping-box \$6.00
- Five Colonies..... 25.00
- Ten Colonies..... 45.00
- 1 untested queen. 1.00
- 6 " " queens 5.50
- 12 " " " 10.00
- 1 tested Queen... \$1.50
- 3 " " Queens. 3.50
- 1 select tested queen 2.00
- 3 " " " Queens 4.00

Select tested queen, previous season's rearing.. 4.00
Extra Selected for breeding, **THE VERY BEST.. 5.00**
About a Pound of **BEEES** in a Two-frame Nuclaus, with any Queen, \$2.00 extra.

☞ Circular free, giving full particulars regarding the Bees and each class of Queens.
Address

G. M. DOOLITTLE,
12A25t **BORODINO, Onon. Co., N. Y.**
Mention the American Bee Journal.

BEEES QUEENS
Smokers, Sections, Comb Foundation, And all Apialran Supplies cheap. Send for FREE atalogue. **E. T. FLANAGAN, Belleville, Ill.**
6A26t Please mention the Bee Journal.

100 QUEENS AT 50c.

This is the season of the year when the best Queens can be reared for the least money, but almost everybody has Queens and the trade is dull. For this reason it is more profitable to sell Queens even at half price, and have them move off promptly, than to hold them week after week trying to sell at a high price. My nuclei are now full of laying Queens, and I want them to move off and make room for others that are coming on, and for that reason I will sell them at 50 cts. each, let the order be big or little. Remember they are nice, young, laying, Italian Queens. I also have plenty of **TESTED** Queens at 75 cts. each.

W. Z. HUTCHINSON, FLINT, MICH.
Mention the American Bee Journal. 29A6t

19th Year Dadant's Foundation 19th Year

It still in the lead, for we use all the latest improvements, including the

NEW WEED PROCESS,

and still make the best goods. Remember that we do not use any acid to purify our beeswax, and that is why our Foundation preserves the smell of the honey and is more acceptable to the bees, than any other. It is kept for sale by

- T. H. Strickler, Solomon City, Kansas.
- G. K. Hubbard, Fort Wayne, Ind.
- L. Hansson, Davenport, Iowa.
- C. Theilmann, Theilmanton, Minn.
- E. C. Eaglesfield, Berlin, Wis.
- E. T. Abbot, St. Joseph, Mo.
- J. M. Jenkins, Wetumpka, Alabama
- John Rey, East Saginaw, Mich.
- Vickery Bros., Evansville, Ind.

- The Jennie Atchley Company, Beaville, Texas.
- C. F. Muth & Son, Cincinnati, Ohio
- E. Kretschmer, Red Oak, Iowa.
- G. B. Lewis Co., Watertown, Wis.
- James Reynolds Elevator Co., Poughkeepsie, N Y.
- Louisiana Bee-Keepers' Supply Manufactory, Donaldsonville, La.
- Page & Lyon, New London, Wis.
- John Nebel & Son, High Hill, Mo.

and many other Dealers. All agree in saying that no goods are better than ours.

Those of our customers who formerly bought through Thos. G. Newman can get our Foundation in **Chicago, Ill.**, by addressing us at **118 Michigan Street**. We keep no other goods there.

We make a specialty of **Veils and Veil Stuffs** of best quality, cotton and silk.

"LANGSTROTH ON THE HONEY-BEE"—Revised.

Bee-Keepers' Supplies, Smokers, Sections, Tin Pails, etc.
Samples of Foundation and Tulle FREE with Circular. Instructions to beginners with Circular. Send us your address.

CHAS. DADANT & SON,

Mention the American Bee Journal.

HAMILTON, Hancock Co., ILL.

22c Cash Paid for Beeswax!

For all the good, pure yellow **BEEESWAX** delivered to our office till further notice, we will pay 22 cents per pound, cash; or 26 cents for whatever part is exchanged for the **American Bee Journal**, Books or Seed, that we offer. If you want **cash promptly** for wax, send it on at once. Dark or impure wax not taken at any price. Address plainly,

George W. York & Co., 118 Michigan St., Chicago, Ill.



☞ To every new subscriber who sends us \$1.00, we will send him our journal,

A Large Book Free

Gleanings in Bee-Culture,

one year, and the book by A. I. Root, containing 190 pages, size 6½x9½, entitled

What to Do, and How to be Happy while Doing It,

postpaid. The regular price of this work is 50 cents.

If you prefer, the journal may be sent to a friend, and you can keep the book for yourself.

**THE A. I. ROOT COMPANY,
MEDINA, OHIO.**



AMERICAN BEE JOURNAL

DEVOTED EXCLUSIVELY
TO THE INTERESTS
OF HONEY-PRODUCERS

ESTABLISHED IN 1861
THE OLDEST BEE-PAPER IN AMERICA

Published Weekly, at \$1.00 per annum.

Sample Copy sent on Application.

36th Year.

CHICAGO, ILL., JULY 30, 1896.

No. 31.



A Method of Producing Comb Honey.

BY J. A. GOLDEN.

Men of long experience have from time to time been writing of the different methods of the production of comb honey, and thus much valuable knowledge is gained by those who read the bee-papers and practice the valuable suggestions given. However, there are thousands, perhaps, who yet claim boastfully that they know more than the bee-papers teach, and still persist in thumping the old tin pans and ringing the old preserved cowbell of a hundred years ago. My topic, then, will be how and what method I practice in the production of comb honey.

I use both 8 and 10 frame hives in the method, preferring the 10-frame, from the fact I secure two well-filled outside frames of capped honey from each colony, at the commencement of the honey-flow, which is stored away and returned to each colony for spring stores, or for winter stores, as the case demands, thus giving the queen eight frames or combs for brood-rearing instead of six with the 8-frame hive, as every one knows the more bees one has in a colony, numerically, when the flow comes on, the more honey is sure to be the result.

My first object, which is very essential, is to have my bees strong in numbers, so that they will cast a swarm when the flow comes, or soon after, and it is supposed that every locality is well understood by the apiarist occupying the same, as to the time of the flow.

Second, all supers and sections have been prepared and stored for immediate use when wanted, and all hives numbered in the diary, that queens are to be superseded during the season. Having our plans well studied for the season, we are ready to handle our work.

To fully illustrate my method, I present herewith a picture of one double super, with full instructions how it is constructed and manipulated.

Cleats $\frac{3}{8}$ thick are nailed across each end on the side of a hive-body, then a board of thin lumber nailed on flush with the bottom of the side of the body, and extending $\frac{3}{8}$ inch above, with strips nailed on top of the end boards of the body, which makes the ends flush with the outside rim or body; thus a bee-space is maintained above, also a bee-space from

the super to the outlet entrance, or *vice versa*, as shown at 1 in the illustration.

Single supers are the same. A strip of tin is folded the same as the tin rests for brood-combs, and nailed at the bottom for the inset slats to rest on. The brood body is the same, excepting the tin rests and a strip of wood is placed under the ends of the brood-frames, bringing the frames flush with the sides of the hive proper. Thus the bee-space is maintained throughout.

No. 2 is a section of comb leveled and covered on both sides with wire-cloth, containing numerous enlarged holes, so as to admit worker-bees to and from the section or cage.

The cleats on the bottom-board are tacked so that only the outside rim will rest on the cleats, giving a bee-space to the outlet from top to bottom. (See No. 1 in the picture.)

To MANIPULATE:—A colony casts a swarm, the clipped queen is picked up and put into the wire-cloth covered cage



The Double Super for Comb Honey.

(see No. 2), having a small wire loop at one corner, and hung on a small hook in the end of a pole, the cluster is jarred from their position, and the caged queen is quickly held near where the cluster was displaced, and the bees will cluster on the cage containing the queen.

A double super is placed on a suitable place, and one end raised sufficiently to admit the bees, which are shaken off in front, and the queen and cage inserted at No. 3. Cover the super, and let the bees become well settled, then remove the parent hive, placing the newly-hived swarm on its stand, and the parent brood-chamber on top, letting the super remain on top if a super had previously been put on before swarming.

On the fifth day, if you want to supersede the old queen, and you want to breed from the same colony, cut out all queen-cells but the largest and best cell; take the cage and queen out of the now pretty well filled super with honey, and insert a section in its place. Put the brood body on the bottom-board, and the double super on top, and the former super on top, and continue to tier up as the case demands. If the caged queen is to be returned, open the cage and let her run in at the entrance with a puff of smoke, and as for that colony, its swarming for that season is completed.

Some one may ask the question, What of all this extra fixing of hives, supers, and caging of queens? Why not cage the queen and return the swarm, as is the practice of many apiarists? Or, better still, hive them in a new hive, and stick to the old plan of moving the old hive day after day? My answer, then, is, that there are three principal factors in the production of comb honey that are worthy the apiarist's closest observation in these times of honey failures, namely, more surplus, or money, with less expense and less labor. My method reduces the expenses just one-half. To illustrate:

My 25 colonies, each casting a swarm and hived in 25 separate hives, my number has doubled; but if hived as in my method, we have but 25 colonies, and all who have any knowledge of bees, know that a natural swarm will build more comb and store more honey when first hived than at any other period in the same length of time; consequently, a swarm hived as per my practice, one gets all that swarm's comb and honey in surplus instead of brood-combs, besides saving the cost of 25 hives, frames, comb foundation and winter stores; besides the extra labor it would require. Therefore, it is not necessary to take up further valuable space to illustrate the other good features of the method that will prove to the producer that no other method practiced will compare with it in the one feature of comb honey production in quantity alone.

Having experimented with the two-queen system and other methods, I know that the above practice will prove a bonanza. Try it. Reinersville, Ohio, July 14.



Xenophon's "Honey-Poisoned" Army.

BY F. L. THOMPSON.

With Prof. Cook's opinion, on page 372, I am unable to agree. He says: "I much questioned this account should have the least influence in forming the opinion of any careful investigator." As he uses the expression, "the old account from Xenophon, I think," it seems he has not read the account himself.

Xenophon plainly says that *all* who ate the honey lost their senses, and did not regain them until the next day about the same hour, recovering on the third and fourth days as if from the effects of a drug. The soldiers did not come upon bee-hives only, as "Novice" seems to suppose on page 373, but encamped in many villages abounding in provisions, where there were many hives. Doubtless in many, perhaps most, cases the honey was not eaten alone, but with other food. Yet *all* were affected who ate at all. (If we accept the theory of Novice, that the pollen was poisonous, it must have been distributed with great regularity.) Besides the usual effects of indigestion, no one was able to stand upright; those who had eaten a *little* seemed very drunk; those who had

eaten much appeared crazy, and a few seemed to be dying. Such an account is imperfectly reported by saying that Xenophon's soldiers ate poisonous honey and became very sick. I never heard of delirium, much less *invariable* delirium, attending mere indigestion, however severe.

Independent evidence of Xenophon's correctness is given by several travelers quoted in the appendix of Vollbrecht's *Anabasis*, who say that the honey of that region (part of the southern coast of the Black Sea) still possesses the same properties, described as "benumbing and intoxicating," while the honey itself is known as "mad honey." The plant from which it comes is said to be the *Azalea pontica*.

It will be noticed that Prof. Cook's theory, that natural selection would prevent either the nectar or the pollen from being poisonous, at least to insects, and Mr. Parson's theory that what is poisonous to bees is poisonous to man, conflict with Novice's theory that pollen may be poisonous to man. I would like to ask, for information, whether it absolutely never happens in nature that what is one animal's meat is another's poison. At least, to imply that those poisons known as "colloids" have the same effect on all animals seems to me, though no scientist, assuming a great deal. What do our bee-keeping doctors say? Without knowing anything about it, the first thought that struck me, on reading what Mr. Parson's says about "affecting the bee's tissues," was that this could only apply to crystalloid poisons, which have the property of passing through membranes.

I thus display my ignorance in order that those who know may set us all right. Arvada, Colo.



Afterswarms—Prevention and Treatment.

BY CHAS. DADANT & SON.

MR. EDITOR:—One of your subscribers writes to ask us what we do with afterswarms, and our advice on the matter.

We consider that an afterswarm is valuable only for its queen, which is always a young one. Otherwise, in our locality, they always come too late to be of any practical use, the crop being nearly at an end when they issue, and the old adage—

"A swarm in May is worth a load of hay,
A swarm in June is worth a silver spoon,
But a swarm in July, is hardly worth a fly,"

is very true here.

A very great trouble with afterswarms is their instability. Sometimes they contain several queens, and will alight in two or three clusters, and after you have harvested one of these and congratulated yourself upon having secured *the* queen you are very much astonished to see the other clusters leave for the woods. Sometimes they will not even settle when first issuing. This is very probably owing to the fact that the young queen is not fertilized, and has gone off to mate, the bees following her. These runaway swarms give more trouble than they are worth. Very often, after you have stopped them at great exertion, by throwing a spray of cold water on them and have hived them, they unceremoniously leave the hive in which they were put, and disappear.

The only way that we know of to prevent the issue of afterswarms, is to open the hive after the departure of the first swarm, say five or six days later, and remove all the queen-cells but one. It is best, however, to examine the hive immediately after the first swarm has left, as the young queens may be hatching already. But it would be of little use to depend upon the destroying of the queen-cells at that time only, for the hive contains fresh eggs and young brood which they may use to build new cells for five or six days afterwards.

Even with all the care that one may take to destroy the superfluous queen-cells, the hive may send forth a second swarm either because some cell has been overlooked, or be-

cause they have then acquired the swarming fever to such a degree that they insist on leaving, even though the hive may be left without either a queen or the means of rearing one. We will agree that this is rather an exceptional occurrence, but it does occur occasionally.

If we have been unable to prevent the issue of an after-swarm, and do not wish to keep it, we hive it as we would any other swarm, and return it to the parent hive after 48 hours, say on the evening of the second day. The result is almost always satisfactory. Very probably the swarming-fever has abated by that time, both the parent hive and the swarm have measured their strength, and find it under average, the young queens are allowed to flight it out, and the victor remains in undisputed possession.

The returning of the swarm to the parent hive after a lapse of 48 hours has even succeeded in the case of primary swarms, but with less regularity. It is especially when a few bad days diminish the crop, or cool weather sets in, that this may be made successful with primary swarms.

We have often noticed that it takes but little to induce a secondary or afterswarm to return to the old stand. We will give an illustration of this out of our own experience:

During the summer of 1878 we had five apiaries of our own, and had engaged to care for another apiary belonging to Mr. A. Daugherty, of Rocky-Run, Mallard P. O., on the edge of the Mississippi lowlands, some 14 miles south of us. We were to furnish him with empty hives for the swarms. That year was a very good one for the bees. His bees in small hives sent forth twice as many swarms as we had expected, and the clover crop was only half over when he found himself short of hives. He sent us word at once, but we were very busy, and it was fully a week before we could take down a load. We found that he had hived secondary swarms in all sorts of recipients—boxes, kegs, barrels, old churns, cheese-boxes, etc. We thought best to immediately transfer the latest of these into the frame hives we had brought. So we transferred some 15 or 20 that had been hived less than four days, by shaking the bees out of the box they occupied to the front of the new hive. In every case but one or two they left before the day was over, and returned to the parent hive. They were evidently displeased at the liberties we had taken with them.

Hamilton, Ill.



Making Swarms Stay Put Back—Watering Bees

BY DR. E. GALLUP.

I am asked how Mr. Oderlin succeeds in making swarms that are put back stay. He cuts out queen-cells, raises the extracting super and places another one under, or if working for comb honey, raises the set of sections and places an empty set of sections under. He says in managing in that manner they almost invariably stay. He only occasionally has to put a swarm back the second time. By the above management he has an extra-strong working-force. He has had as high as 16 swarms in one day. He keeps a man in the apiary all the time (if not there himself) during swarming-time, and prefers to have his bees swarm, for they are the colonies that produce the most honey. How is that going to suit the non-swarming advocates?

Somewhere in the American Bee Journal some one tells how to water bees, but he does not tell it rightly. I have a small platform or board permanently fixed out of the wind and convenient to the apiary. Now cut a small block from a board, 4 inches square is sufficient; cut a crease out each way in the form of a cross. Fill a two-quart Mason jar with water, place the little board over the mouth of the jar, creased side down; hold it there, and reverse or tip it over, place on the platform, and you have just what the bees like. Those

creases must come outside of the jar, but not to the edge of the little block.

I keep about four jars—two with the salted, and two with fresh water. Some days the bees will use the salted water more freely than the fresh, and some days the reverse, and some days about alike. Do not make the water too salt. I find by experience that about what you take between the thumb and first two fingers is about right—not too large a pinch.

I have for years salted my bees in that manner, and have a strong belief that it is very advantageous. The water only comes down out of the jars as fast as the bees require, and you can see at a glance when the jars need replenishing. Bees that are kept salted are never seen sucking around the pigsty, urnal, or where slops are thrown out of the farmer's kitchen. It is on the same principle of the Boardman feeder, or the arrangement for watering little chicks, turkeys, etc.

This season I have fed my bees for stimulating when they could gather nothing, with just sweetened water, half a tea-cup of sugar to a two-quart jar of water; kept them breeding right along. I fed on the watering platform.

I started in with one good colony in the spring, and now have 18. I shall report in the fall, in full. A part of April, most of May, and up to the middle of June, was bad. It is good now.

Santa Ana, Calif., July 9.



Fifteen Years' Experience in Bee-Keeping.

BY MRS. SALLIE E. SHERMAN.

(Continued from page 469.)

I never saw a case of foul brood, and I hope I never will. I have had a few cases of the nameless bee-disease. I decided in every case that it was caused from the honey. The first I ever saw of it there must have been a quart of dead bees at the entrance, and others crawling out trembling and dying. Upon opening the hive and taking out all the honey in their hives, and giving different white capped honey, they ceased to die, and in a few days were all right. The honey I took from them all had a watery appearance.

In 1888 I had about a ton of honey, enough of which was gathered from milkweed, to so strongly impregnate it with that strong, fiery taste, that it could scarcely be eaten at all. By a mere accident I found that if it was exposed for some time to the atmosphere the strong, peppery taste all left it. I then put it in shallow vessels, exposing as much of it to the atmosphere as I could conveniently, covering it with thin cheese-cloth and letting it remain thus for a time. I was enabled to sell it at the usual price. This little item is worth remembering and putting into practice, should occasion require it.

Not so with comb honey. I know of no way of removing it, as it is sealed, and so of course remains hot. This is a very strong point in favor of extracted honey, in a country where such objections are liable to come up in the honey-producing flora.

All very dark and unsalable honey, together with the washings of all vessels, etc., was put into the vinegar barrel, that nothing be lost. I usually had a good market right at home for all I made. I remember, however, on one occasion that my vinegar was not quite as strong as I desired it, and having seen somewhere that yeast put into the vinegar would greatly hasten its turning, and add to its strength, I thought, "That's just the thing I have been needing. I don't see why I hadn't thought of that myself." So I fixed up my yeast, and let it get good and sour, then to the vinegar barrel I went and poured it in—a whole gallon, stirring it thoroughly all the while to get it well mixed. I sold a few gallons along as my neighbors wanted it. It was fine, too, I assure you. It beaded beautifully.

By and by a customer came who wanted at least 15 gallons, and brought his little barrel along to get it in. Imagine, if you can, my chagrin, when, after taking out about three gallons, there was no more beautiful, clear vinegar, but just a great, foaming, working mass of at least 15 gallons that I had to throw away. Don't ask me why I didn't let it settle, for it just wouldn't. I tried it until I saw it never would, so I took out the fine, thick mother, and after thoroughly washing both it and the barrel, put it back with the three gallons, and started afresh. So I want no more yeast in mine. The bad part of it was, my customer had to go elsewhere for vinegar, and hasn't since given me an order.

In 1888—the year I got 6,000 pounds of honey—I had so much work with the bees and honey that I hadn't time to put up as much fruit as I wanted to, so I thought I would try an experiment. I washed, wiped dry, and packed an eight-gallon keg full of peaches. I placed a large plate over them, and then a nice, clean, flat rock on top to hold them down, after first filling the keg full of extracted honey. This was in August; after tying a cheese-cloth over the top of the keg, I let it stand for three months, until the rush was over. I then opened, looked at, and sorted or divided them, putting all that were firm into jars, and pouring the liquid over them, finally using them as sweet pickles. Those that were soft I rubbed through a colander, put on fresh extracted honey, and cooked, calling it "peach butter." Both were fine, and were so pronounced by those who tried them at different fairs and farmers' institutes where they were on exhibition.

The liquid that was left over was also pronounced fine, though I have always been at a loss to know just what to call it. I gave some of it to a gentleman and lady this morning (Jan. 31, 1896) to sample. The lady said it was good. The gentleman said it was fine, and he didn't believe a gallon of it would make any one drunk. My father and mother liked it very much, it seems so nourishing. I regretted very much having taken a bottle of it with me to Chicago, to the bee-keepers' convention, as I think a few got the idea that it was intoxicating. You may as well disabuse your minds of its intoxicating qualities, for I assure you that there was no one attending that convention who would have been farther from recommending a beverage containing those qualities than myself. I carried it, thinking it might be something both new and useful, as I had never seen anything in print about making a beverage of this kind; and at the same time find a new use for honey, thus increasing its consumption.

Referring to the World's Fair convention, I wish to most heartily thank each and every one who did, or said, anything towards making my visit a pleasant one. That trip was the grandest one of my life, and will ever remain on memory's tablet as an oasis in the desert. Pleasant words and sweet recollections will go down with me to my grave.

A few years ago, on going out of my gate early one morning in the fall, I heard what at first seemed like a whole swarm of bees. On looking up, I saw that a post-oak near by was covered with bees. I suspected at once the cause, so I broke off a small limb and brought it to the house, examined it with a microscope, and, sure enough, on the underside of the leaves there they were in great abundance—the cause of the honey-dew.

Yes, I have seen Italian bees gathering honey from cotton. In going to a friend's house one morning, I purposely got over the fence and went through the cotton to see if the bees were getting honey or pollen from that source. I saw several dozen pure Italians, but not a single black bee (although at that time there were more blacks than Italians) gathering honey, but no pollen. They worked very earnestly at the very base, or, I might say, rather between the little folds at the base, and appeared to be well repaid for their labor, judging from their actions in hurrying to and from the

flowers. At the time I wondered why it was that I saw no blacks. Is it possible that their tongues were not long enough to reach the nectar?

I never had the opportunity of studying the honey-flora and watching the bees on various flowers as I would have enjoyed doing, from the fact that just at the time to study was the very time I was most closely confined at home, looking after and attending to the wants and demands of my bees, which were so exacting if not provided and cared for at the right time that I would be the loser thereby.

One singular thing about my keeping bees was, that more came to me than I ever lost. I could only account for it in one way, and that was absconding and starved out swarms, in passing, smelled the honey in my apiary, so concluded to stop and be a part and parcel of the same. I very much enjoyed watching the bees as they hung in festoons, building their comb. But one of the strangest things to me in the whole economy of the hive was the wonderful difference the food made, not only in the looks, use, and shape of a queen from a worker, but in her lengthened life. It is indeed marvelous.

On one occasion, when I was working with my bees, a wit being present, I showed him several queens, and the cells from which they hatched; I told him that it was the royal jelly on which they were fed that caused the difference between them and the worker-bees.

"Well," said he, "why can't you feed your son on royal jelly, and make a king out of him?" Bee County, Tex.

(To be continued.)



Nectar Secretion—Sowing Sweet Clover.

BY E. S. MILES.

On page 436, I think Mr. R. C. Aikin tells some as straight and honest truth as has been my good fortune to hear for many a day. There has been some discussion as to how we might sow sweet clover so as to make it bloom later, after white clover is gone. I believe it is like he says—you will do better to let it bloom in its season, as I doubt much if it will yield very much if it blooms out of season. But it will bloom considerably longer if sowed quite thin, instead of thick.

But speaking about planting for honey alone, he doubts if it will pay, and I think likely he is right for him and his country, but I will tell you what I know. I sowed about one-half bushel of sweet clover seed, one year ago last March, and I don't think I was over a half day harvesting the seed and sowing it, and I know it helped out the honey-flow this year enough to pay me well for that one-half day.

This was a season when white clover yielded lightly for quite a while, and the sweet clover came on and helped it out nicely. I watched closely both in the field and at the hives, when the bees were working on both white clover and mellilot. When the scale hive, with just a medium colony, would gain from two to three pounds per day, I think one-half the bees would have the sweet clover pollen as they went into the hive, and, towards evening, perhaps more than one-half. I know they had good loads of honey, too, by the way they would drop on the entrance, and they worked on sweet clover at the same time they did on basswood, which they would not do unless it yielded well. And there was as much as 50 colonies, and may be more, and only about as much sweet clover in the whole range as would come from one bushel of seed.

I don't think that a dry fall hurts sweet clover a particle. I never saw it look as nice as it does here this year, after the driest fall and winter I ever saw.

I don't believe there is such a thing as death for sweet clover, except old age. Of course, the sweet clover is all on the highways and waste ground. I don't suppose a person could sow it for honey alone except on waste ground.

Also, referring to Mr. Aikin's closing sentence on the same page—does not sacred and profane history teach us also that a land might bring forth in plenty, and yet on account of the sinfulness of the people of that land it would not do them good, but rather harm? Look at the heathen of old; was not their land "a land flowing with milk and honey?" And yet, the promise to the Israelites of that good land was God's means of destroying them. And does not *our* land *now* flow with milk and honey? The only trouble is, the energy and enterprise of this country is bottled up in pools and combines, the producer getting only the barest kind of a living out of bounteous crops, and the consumer almost starving on every hand.

Denison, Iowa, July 11.



The Honey-Guide—Bee-Keeping in the South.

BY JAMES B. DRURY.

The Youth's Companion of a recent date said there are 998 patented bee-hives. Just think of it, and out of the 998 I suppose there are about 50 in use. However, the majority stick to the standard Langstroth, which I do not think is patented. In the same paper (June 4, 1896,) is an account of a bird called the "honey-guide," under the head, "Are Animals Moral?" from which I extract the following:

"Consider the little 'honey-guide,' the *Indicator minar*, as one example, well known in South Africa. Wild honey is plentiful, and the honey-guide is well aware of its existence, but is incapable of opening up the rich store and getting what it most prefers—the grubs—found in the comb. It therefore having discovered a nest of honey, immediately seeks the aid of some human being. Fluttering restlessly about him, it utters loudly its chiding cry. Every African native knows this invitation perfectly well, and at once follows. As soon as it sees the man following, the little bird flutters delightfully through forest and bush. At length the honey-guide reaches the hollow tree in which the honey is deposited. The native, with his hatchet, or 'assegai,' opens up the nest and extracts the comb. Usually he breaks off a piece containing the larvæ, which the bird loves, and places it on the ground by way of tribute to his feathered friend."

Now, I would like to make a few remarks about this bird. What a boon it would be to bee-keepers who make it a part of their trade to hunt bees in the woods, *a la* Hutchinson's method, as per *Cosmopolitan*. Just think of the time saved in hunting for them, if there were to be a few thousand of these birds imported to this vast country. Some would say, "'Twould be like the English sparrow—soon to become a pest;" but take into consideration that the "honey-guide" cannot get at the larvæ without the aid of man. Then, again, they might (?) be tamed to find bee-trees, as the Chinese train their "cormorants to catch fish for them." Only we want bees and honey, not so much fish.

I hope our bee-keeping friend in South Africa—Mr. S. A. Deacon—may see this, and give us, if possible, some information about this wonderful bird.

In the last number of the "Old Reliable," the editor speaks of "the wonderful South" as the "bee-keepers' paradise." Well, it is so in one respect, and would be if it were not for the pests and enemies bee-keepers here have to contend with. In the North you have the foul brood and bee-diarrhea, while in the South we have a multitude of pests. First the bee-moth (the most feared of all by Southern bee-keepers), which we have all the year around. Let a colony become in any way weak, whether it be Italian or black, the bee-moth is sure to take possession.

Then the cockroach, that has a hard shell which is impossible for the bee to pierce with its sting; which lives on the sweets of the land up in the supers of the hives, daubing the sections and everything else with its excrements.

Then the small red ant, which builds its nest between the space under the sections not filled with propolis, living on

dead bees and honey. And at night, if the hives are on the ground, the toad sits in front of the alighting-board snapping up the choicest and largest bees quicker than a wink; and just at or near dusk you sometimes lose a number of late comers, by having the bee-martin snap them up as they (the martins) skim over the hives.

Bees have been doing well in this section of the country since April 1st; they are gathering lots of pollen from Cherokee rose, spiderwort and touch-me-not; and both pollen and nectar from beans, peas, niggerhead, sunflower and willow, which is still in bloom; to say nothing of the vast number of cultivated flowers in this "Garden City." White clover has been furnishing a lot of nectar, but is beginning to die out, owing to the heat.

I planted some buckwheat in the early spring, but must say that it is a failure here as a honey-plant. I did not see a single bee on it as long as it was in bloom.

When I first handled bees, if I was stung, I would puff up at once, but now I do not mind it at all. I have become "vaccinated" against stings, not with vaccine matter, however, but with formic acid by the bees.

We have here a few wild bees, some small, about $\frac{3}{8}$ inch long, the same color and markings as Italians, with wings outstretched like a fly; and some large black ones twice the size of an Italian worker, with four white, hairy bands across the abdomen, which flit from flower to flower like so many flies. I tried to capture some to send with this letter, but they were too wary and active to allow themselves to be caught.

We have an abundance of dandelion here, but I have never seen any bees of any kind working on it. It is just overflowing with pollen, but no other insect seems to like it but the "yellow-jacket."

A young friend of mine told me he had caught two swarms of bees, and wanted me to buy them. I looked at them and found that both were without queens, and in lieu had a number of drone-laying workers, rearing drones by the hundreds. I counted as many as ten or more eggs in the bottom of the worker-cells; in some the bottoms were covered with them. I would like to have caught some of the laying-workers, so as to dissect them, but it was next to impossible to distinguish them from any others.

A neighbor had me take some honey from a hive of hers; she told me that a week or two previously a swarm issued and hung in a plum-tree; and looking where they were, I saw on a thin limb a piece of comb (all worker) about the size of two hands, with quite a number of cells filled with pollen, but nary a bee or drop of honey.

Last winter was a bad one here, one man losing 15 per cent., and another about 10 per cent., of their colonies by the bee-moth. I lost one colony, and had another desert from the plagued things; but I managed to capture the deserters, and hived them on full sheets of foundation; they are now doing well—the bees, not the moths.

I saw a queer-looking bee this morning; it was just a little under the size of a black, the same shape, but its back and abdomen was a bright, glistening green; it had pollen-bags, and was gathering nectar from the sunflower, the same as any bee. I have seen a good many wild bees, but it is the first time I ever saw one like this.

I have been using the 8-frame Langstroth hive, but I find it too small for this country, so I am going to try the large Dadant hive and the 10-frame Langstroth, so as to see which is best for this locality.

What is a "V hive?" It is said, "They are self-cleaning, and the best hives for queen-rearing we have yet tried." If I understand rightly, the "V hives" are hives that have one or more V-shaped grooves in the bottom-board, for all trash to go out when it drops, but not large enough for a bee to pass through. If they are as I think, I would not use them, as

they offer extra inducements to the bee-moth to lay her eggs in the cracks and trash that is too large to drop through. They also would make more work for the bees, for bees, when they find an opening in the hive that they cannot pass through, are almost sure to block it up with propolis, which would thereby make the V useless.

I say, give your bees a one-piece bottom-board; keep them strong in bees, and you will always have clean bottom-boards, even into the very corners.

A steambot clerk told me the other day, that in 1894 he brought down from the Ouachita river (central Louisiana), for a Mr. J. C. Mann, 50 barrels of honey and 10,000 pounds of beeswax (wax selling here for 28 cents per pound), all taken from bee-trees. "Wild honey and wax," as he expressed it, all taken that summer. New Orleans, La., June 13.

Questions AND Answers

CONDUCTED BY

DR. C. C. MILLER, MARENGO, ILL.

[Questions may be mailed to the Bee Journal, or to Dr. Miller direct.]

Bees Not Storing Surplus Honey.

Why don't my bees store surplus honey? They are strong colonies, and seem to be busy; and, indeed, they seem to work in the sections, but on examination I find nothing done. I thought this was going to be an abundant honey year. One of these colonies last year cast a heavy swarm, and stored about 50 pounds of nice honey. J. E. Baldwin, Pa.

ANSWER.—I don't know. As the bees did well last year, it can hardly be that you have a lazy strain of bees. Quite possibly the fault is in the pasture. If the plants don't yield nectar, no matter how busily the bees may work for the little they can get, there will be no storing of surplus. And sometimes bloom is abundant, but nectar almost entirely absent.

Vicious Bees that are Good Workers.

Have you ever at this time of the year where bees were working with all their might, had them so vicious that they would sting any and every thing that came near them? If not, you can find 36 colonies in my apiary that would put to shame so many hives full of hornets. My bee-yard is in a quiet place, and surrounded by high board fences and grape-vines, so that the bees cannot see any one going from the house to the barn, yet as soon as any of us are on the back porch the bees are after us, and unless one is careful to keep his face covered, he is sure to get stung; and when I am working among them with a veil and smoker, they will sting my veil and clothing, and will keep up until I leave the yard.

They have been vicious all this season so far, yet they are bringing in the honey as they never have done before. They have filled the second super, and it looks as if they were good for three or four more.

With these same bees last season I could sit and read the paper in the bee-yard under the shade-trees without veil or smoker, and the bees paid no attention to it. What do you suppose makes them so vicious? They are pure-blooded Italians?

In the Bee Journal of Nov. 14, 1895, page 734, there seems to be a case mentioned like mine. Some one seems to make sport of the one who said his bees were vicious while they were gathering honey; I think if he could visit my apiary in the middle of the day, he would change his mind about vicious bees in times of plenty. If you can give any reason, or any remedy, or if any of our "big guns" can help me out, I would be pleased to have them do so. I have neighbors who

live at least 300 to 400 feet from my bee-yard, whose children were stung several times last month, and some older people. I am afraid if they keep this up that it will get me into trouble with my neighbors, but I hope not. L. S. Aurora, Ill.

ANSWER.—If any one makes fun of the idea that bees may be cross when gathering honey, he simply doesn't know what he's talking about. I've had them very much as you describe. Neither do I believe you know what you're talking about when you say you have 36 colonies of such demons. You may have an enviable reputation for truth and veracity among your neighbors, but I think there are about 34 colonies of those bees that you vilely slandered, and they could recover damages if they would sue you for slander in any court of justice. I know that the air seems full of the vicious things, and they are all over the apiary, but if you'll take the pains to examine very closely, you'll find the trouble is all confined to one or two colonies. Of course, I don't know for certain, but I'm telling you what I think.

Examine very carefully and closely, and see if you can't trace the culprits to one particular hive. Just think a minute of the number of bees in that hive, and if one out of a hundred of them should start out after you and follow you up all over the apiary and a good ways from it, it would seem as if the whole apiary had gone mad. Having found the right hive, find its queen and just decently mash her up fine, and then give them a queen of better disposition. You will expect the temper of the bees to change as soon as the old bees have died off and the young ones have taken their place, but that hasn't been my experience. Instead of waiting six weeks to find better-natured bees, the change came in a few days after the change of queens. I know it doesn't seem reasonable to believe so, and I don't know why it should be so, but I've had such cases several times, and the change of temper always seemed to come within a few days after the change of queens.

Basswood Blossoms but No Honey Gathered.

I send you a little box of basswood blossoms by mail. What is the cause that the bees don't work on them, for I can see nectar in them? P. J. K. Greenwood, Wis.

ANSWER.—I don't know. So far as the appearance of the blossoms is concerned, they appear just as good as any. And yet for some reason that I have never seen explained, there are times when a honey-plant may be profusely blooming and yet yield no nectar. Clover is sometimes guilty in this way. Perhaps it may be in the electrical conditions of the atmosphere, or something of the kind. Again, a plant may be yielding and bees do not visit it because they have all they want to do on some other plant that they prefer. Yet linden is a great yielder and a great favorite, and it would be hard to believe that when it is yielding well the bees would prefer something else. Again, a plant may not be visited by the bees because there is but little of it, whereas the bees prefer that which blooms by the acre. But in Wisconsin lindens generally grow on a large scale. On the whole, you will probably be obliged to be contented to live in ignorance upon this as well as some other points connected with bee-keeping.

Non-Swarming and Loafing Bees.

In the Bee Journal have been some articles about non-swarming bees, or breeding out the swarming habit. I wish my bees would swarm instead of loafing in great clusters on the front of the hive, not going in even when it rains. They are not doing much in the surplus department, and not many drones are flying. I have had two swarms in five years. I introduced a Carniolan queen in one colony, which I heard were great on swarming, but they hang out worse than the Italians do, but are doing a little better in the sections.

Now, I am not advertising non-swarming bees—I have no

bees or queens for sale—but I would like to get hold of a strain of bees that would swarm, for I think then they would store some surplus honey.

What can be done for a colony that hangs out all the time?

I have three colonies of bees, but have had no swarms this season.

J. T. H.

Columbus, Ohio.

ANSWER.—Loafing is worse than swarming, providing the loafing comes at a time when there's plenty of work to do. If there is nothing for the bees to do, you can't blame them for loafing. Sometimes, however, bees loaf when there's plenty for them to do in the field. Some bees are naturally more industrious than others, but there may be conditions that lead toward loafing. Possibly there isn't room enough for all the family in the house, obliging some of them to stay in the front yard. In that case, give them more surplus room. Perhaps they have too little ventilation, or the hive stands in too hot a place. Raise the hive up in the old-fashioned way by putting a block under each corner, raising the hive half an inch or an inch all around. If the hive stands out in the open sun, provide some kind of shade, if nothing but a board or two leaned up against the south side of the hive. But if you are in one of the unfortunate regions where bees have no pasture this year, no amount of effort on your part will do any good. And sometimes there are plenty of blossoms without there being any honey in them. A swarming strain of bees will hardly be of any help, for bees that do the least swarming are likely to do the least loafing, the worst loafing often being about the time of swarming.

Do Not Swarm or Store Surplus.

I bought a colony last spring in an S-frame hive, but they have not swarmed; they seem to rear plenty of brood, but whenever it has matured, it looks as if they were killing it off again. Besides, they have not stored any surplus honey.

E. C. R. R.

ANSWER.—It isn't easy to answer without knowing more of the case, but I suspect there is nothing greatly out of the way. Many colonies in good condition do not swarm before July 10, the date of your letter, and it may be that your colony is not very strong. It may be that the harvest is not good in your region, and that would account not only for the lack of surplus honey, but as well for the killing off of the brood, which may be all drone-brood.

The Weight of Natural Swarms.

About how much should an average prime swarm of bees from a one-story Langstroth hive weigh? I bought a swarm of a neighbor and furnished a hive. The hive was weighed before and after the swarm was hived, when it had increased in weight but two pounds. How many more ought there to have been to make a fair swarm?

J. M.

ANSWER.—That's a matter upon which I can give no authoritative opinion. Some have spoken of swarms weighing as much as eight or nine pounds, and others seem to think a swarm never reaches that weight. There is a great variation in the size of swarms, and I suppose there might be such a thing as a prime swarm from a Langstroth hive weighing only two pounds. At a guess I should say that a fair swarm ought to weigh four pounds, and if that is correct, it would leave your swarm about two pounds short. That is, short of average weight, although, as I said before, there might be such an exceptional thing as a complete swarm weighing only two pounds. When it comes to afterswarms, plenty of them weigh less than a pound. Now, I may be away off in my guesses, and I shall be glad to be corrected by any one familiar with the weight of natural swarms.

PERSONAL MENTION.

DR. E. GALLUP, of Santa Ana, Calif., is a firm believer in doctoring without drugs. And he has had wonderful success, too.

DR. E. SMITH, of Judd's Corners, Mich., wrote us on July 15: "We have had an early basswood flow of nectar, and the bees have done well."

MR. H. E. WILDER is now foul brood inspector for Riverside Co., Calif. J. H. Martin suggests in Gleanings that "no doubt the disease will have to seek other fields" now. We hope H. E. W. will *h-c-w* it down.

PRES. W. T. RICHARDSON, of the California Bee-Keepers' Exchange, "has so far recovered as to return to his home in Simi country," says Rambler in Gleanings. "His accident detained him at Bro. Touchton's five weeks."

MR. CHAS. A. HOLMES, of Somerville, Mass., expresses himself thus about the Bee Journal: "I have been a subscriber to the American Bee Journal a little over a year, and I can't tell how much I enjoy it. It is bright, newsy, and full of useful hints to the bee-keeper. I couldn't carry on my business without it; it keeps in touch with the whole bee-keeping country."

MR. GEO. R. MCCARTNEY, of Rockford, Ill., called on us last week, bringing with him two sections of white honey, gathered from sweet clover, white clover, and basswood. This will help to sweeten "ye editor," for which due thanks are tendered the giver. Mr. McCartney is an inventive genius, and has turned his attention toward the subject of foundation fasteners. He will soon be ready to present the result of his efforts before the bee-keeping fraternity.

MR. B. TAYLOR, of Forestville, Minn., has had a long and serious illness. To the Farm, Stock and Home for July 15 (of which he is the apiarian editor) Mr. B. sent these dictated words:

"I am yet too weak to write a line, but hope for better things soon. The bees are booming. When I am able to write I will have a most interesting and instructive story to tell. I am receiving dozens of letters from readers, to which I can at this time make no reply."

All readers of the Bee Journal will rejoice in Mr. Taylor's speedy and complete recovery.

MR. C. E. MOODY, of Asheville, N. C., called on us last Thursday. He had been visiting friends in Milwaukee, Wis. He has an apiary of about 30 colonies, and runs for both comb and extracted honey. Mr. M. kindly brought us a section of honey gathered from the sourwood, which in the South is considered very fine. While it has a rather pleasant flavor, to our taste it hardly compares with honey from white or sweet clover, or alfalfa. We doubt very much if there is any honey that can compete with what is gathered from any of the clovers.

The Names and Addresses of all your be-friends, who are not now taking the Bee Journal, are wanted at this office. Send them in, please, when sample copies will be mailed to them. Then you can secure their subscriptions, and earn some of the premiums we have offered. The next few months will be just the time to easily get new subscribers. Try it earnestly, at least.

THE OLDEST BEE PAPER IN AMERICA

THE AMERICAN BEE JOURNAL

ESTABLISHED IN 1861

GEORGE W. YORK, Editor.

PUBLISHED WEEKLY BY

GEORGE W. YORK & COMPANY,

118 Michigan St., CHICAGO, ILL.

\$1.00 a Year—Sample Copy Sent Free.

[Entered at the Post-Office at Chicago as Second-Class Mail-Matter.]

Vol. XXXVI. CHICAGO, ILL., JULY 30, 1896. No. 31.



Those 40-Cent Subscriptions, as offered on page 495, are coming in. Have you made any effort yet to win a part of the \$25 cash prizes offered? We expect to be able, during the whole of July and August, to send all the numbers from July 1st to new subscribers. Think of getting 26 copies of the Bee Journal for only 40 cents—about 1½ cents each! There's no bee-keeper, of however few colonies, that can afford not to accept our offer. Just one month left for the work of getting new subscribers, as the offer extends only to Sept. 1.

We appreciate very much any and every effort made by our present subscribers, to increase the list of readers of the American Bee Journal. We believe it is a mutual benefit all around—you help yourself, you help those whom you get to read it, and you help us. We wish to thank all who have thus aided in the effort to spread apicultural knowledge, and we trust none will grow weary in well doing, but continue in the good work.

Sweet Clover and Its Honey.—In Gleanings for July 15, Editor Root has the following on the subject of sweet clover:

A subscriber reading what I wrote editorially in our last issue—where I expressed the hope that sweet clover would take the place of white, which has apparently run out—has written a protest against Gleanings' saying so much in favor of what he calls a "noxious weed;" and he further intimates that, unless we quit talking about it, he will stop Gleanings. In that case I do not see but he will have to stop his journal, and, for that matter, all bee-publications. They all recognize that sweet clover is one of the best honey-plants in the world, and they insist, on good authority, that it is not a noxious weed—that it is easily killed out on cultivated lands, and seeks only railroad embankments, roadsides, and other waste places, where nothing else will grow. So far from being a noxious weed, it is now being cut and used as hay. While it is not equal to alfalfa, its near relative, as a forage-plant for stock, it comes the next thing to it. It is true, one experiment station has condemned it as a weed; but it is being recognized, and is now recognized by some of the best authorities in the world outside of beedom, as a forage-plant both for bees and for stock. It is true, our domestic animals have to learn to like it; but when they once acquire a taste for it they will nibble it in preference to any other plant; hence, it can never be called a weed in pasture lands.

For the first time in our experience we are getting what I firmly believe is sweet clover in sections and extracting-supers. Our bees are just fairly swarming on this plant along our railroad cuts and roadsides. They are bringing honey in

slowly from somewhere, and we cannot find that they are working on anything but this clover. White clover has been a practical failure, as usual. Basswood promised well, and made a good spurt, but dropped off rather more suddenly than we thought it would. While the sweet clover is perhaps past its height, it will probably be in bloom in our locality for at least two or three weeks, and possibly a month yet.

I notice one thing—that, after every rain, the honey-flow is increased; and when it becomes a little dry the bees work the best only nights and mornings.

Sweet clover is surely spreading all over the country, and I think Gleanings and all bee-keepers may be pardoned for speaking a little in its favor, especially since it does not, except in a few isolated localities, occupy cultivated lands; and as it grows where nothing else will grow except ragweed, it adds just so much to the wealth of the country. I, for one, cannot help shouting for sweet clover.

We want to say that we are entirely with Mr. Root in all he says about sweet clover. In this part of the country it is getting to be the honey-plant most to be relied upon. And it is spreading very rapidly.

Recently we attended our annual Sunday-school picnic, this year held in Elgin, Ill., 44 miles northwest of Chicago, and we were surprised to see such a quantity of sweet clover growing and in bloom along the Chicago & Northwestern railroad tracks, and some on adjoining land. Why, it was a beautiful sight, to see the waving plumes of rich white blossoms on their supports of living green! So much prettier than miles of noxious weeds would be.

In a "straw" in the same number of Gleanings, Dr. Miller says this, which should not discourage any one:

"Sweet clover can never, I think, take the place of white clover as a honey-plant, and we may as well know it first as last—just because sweet clover honey can never take the place of white clover honey on the market. Some will like it better than sweet clover, but others will not like it at all."

To the above, Editor Root makes this neat response: "If white clover cannot be had, sweet clover would be a most excellent substitute, at all events."

And we'd just like to suggest that if it is a fact that domestic animals learn to like the sweet clover as a forage-plant, what's to hinder people from learning to like its honey? We confess that we like sweet clover honey above all others—liked it from the very first taste we had. And we know others who are fond of it. But there will always be people who do not like any kind of honey—our next door neighbor belongs to that class. But his wife and son, who had never eaten sweet clover honey before last week, were simply profuse in praise of its excellence.

Give the people a chance, and we think the great majority of them would call sweet clover honey "licking good," as the knowing small boy would say.

Wisconsin Bee-Keepers and Foul Brood.

—Mr. N. E. France, of Platteville, Wis., who is the very active committee on foul brood for that State, has sent us the following address to Wisconsin bee-keepers, which should be read and observed by them:

SPECIAL TO WISCONSIN BEE-KEEPERS.

Wisconsin is one of the best States in the United States for bee-keeping, as has been proven by the QUANTITY and QUALITY of honey sold. To retain it in the future will require some special effort on the part of the bee-keepers. If successful, each bee-keeper must keep up to the times. I wish to call your attention to some important facts. For years I have attended our bee-conventions, and always felt well repaid. This has been the report each time of all in attendance. The Southwestern Wisconsin Bee-Keepers' Society will meet Oct. 7 and 8, 1896, in Wauzeka, Wis., and the State society on Feb. 4 and 5, 1897, in Madison, Wis. The October program is out, and promises the best meeting ever held in the State. If possible, attend one of these meetings; it will pay you.

Another important subject is the present dangerous condition of Wisconsin bee-keeping. The contagious disease—foul

brood—is in our State, and something should be done soon to prevent its spreading, and cure the disease.

Canada, Colorado and California have each a law on foul brood, and have done much good. The Canadian law has cured 5,700 cases, and letters lately received from there, inform me they now cure every case without destroying hives, etc. The bee-keepers' societies of Wisconsin made an effort at the last term of the Legislature to get a Bill passed, to cure and prevent the spread of this dreaded disease. It is a copy of the Canadian law, and includes all that is necessary to cure and prevent its spread. It would have become a law had more of the bee-keepers requested their legislators to support the Bill. The disease is contagious, and kills all young bees in the grub stage, 6 to 14 days old, so it takes but a short time to destroy the colony. I have a report of one bee-yard of 80 colonies destroyed by it.

I ask you to fill out the following blank and RETURN TO ME SOON, so I can make my report to the bee-societies of Wisconsin, as they intend to make special effort this year to get protection for their bees by this foul brood law.

We ask your assistance; all it will cost you is your personal effort in instructing your legislators after this fall election, specially requesting that they support the Bill. Minnesota, Iowa, Illinois and Indiana bee-keepers intend next winter, through their societies, to get a similar Bill passed. We certainly do not want to be behind. Yours truly,
N. E. FRANCE.

The blank referred to in the foregoing asks for the following information by Aug. 1:

1. Your name.
2. Your postoffice.
3. Your present number of colonies and pounds of honey.
4. Have your bees foul brood?
5. Do you know of the disease in your county?
6. Do you wish a law to protect your bees?
7. Will you use your influence to obtain it?
8. Do you think you will attend our convention?

We trust that every reader of the American Bee Journal residing in Wisconsin, will at once send their replies to the above questions to Mr. France, and heartily co-operate with him in securing the much-needed law against foul brood. The only way to effectually combat the disease is for every bee-keeper to do his or her part in helping to stamp it out. And that can be done in no other way so thoroughly and generally as in having the assistance of a good law.

Mr. France deserves the gratitude of all Wisconsin bee-keepers for his unselfish and undefatigable efforts in this matter. Now let every one turn in and help him push it on to success.

The Honey Market and Shipping.—Business Manager J. T. Calvert, in Gleanings for July 15, has this to say about the honey quotations of this season as compared with those of last year:

"A comparison of the quotation on honey in the different markets, with those of the same markets a year ago, shows very nearly the same prices. In not more than two or three cases are they higher now than at the same time last year, while in quite a few the price is some lower, with the general average a little below last year's quotations. A little later in the season prices improved a little last year, while by November or December there was a downward tendency, which continued until spring. Aside from the far West, from which we have but meager reports, there is undoubtedly a better crop of honey generally this year than for several years past. In view of this, and the low price of commodities generally, we shall not be surprised to see prices of honey lower than we have ever known them to be before by the time the present crop is marketed. Do not be in haste to crowd your honey into market, and prematurely crowd prices down. Strictly fancy white comb honey will always command a good price and a ready sale."

Referring to the preparation of comb honey for market, these excellent suggestions are given, and should be carefully heeded, if the best results are to be expected:

"In preparing your honey for market, bear in mind that it always pays to take great pains in grading, selecting, and packing. See that the sections are scraped clean and bright, and packed carefully into bright and clean cases, the fancy

white all by itself, and all other grades by themselves. Even if you have only a few a cases, grade it; and each grade should be so uniform that the sections placed next the glass will fairly represent the entire contents of the case. If every bee-keeper should take the necessary pains in preparing his honey properly for market before he ships it, there would be less disappointment in the returns, and less complaint of commission men. The use of cartons on comb honey is becoming more general. It is desirable, also, to use a light case, bright and clean, and as nearly uniform in weight as possible. The sale of many a lot of fancy honey is often greatly injured if not ruined by the makeshift cases improvised at home, to save a few cents in first cost. The amount lost on the sale of such lots would have more than paid for bright new cases of proper construction to pack the honey in. I could cite as proof of this a number of instances that have been brought to our attention by dealers in honey in no way interested in the sale of shipping-cases."

North American Convention—Oct. 7 and 8.

—Secretary Mason has sent us the following in regard to railroad rates and time of meeting:

STATION B, TOLEDO, O., July 25, 1896.

MR. EDITOR:—I have just this moment (3:20 p.m.) received the enclosed from Mr. Whitcomb; it will explain itself:

OMAHA, Nebr., July 22, 1896.

MR. E. WHITCOMB, Friend, Nebr., Pres. Nebraska B.-K.'s Ass'n.

Dear Sir:—I beg to advise you that we have made the following arrangements for Homeseekers' Excursions from the Missouri river and points east thereof to points in Nebraska; Kansas, South Dakota, Wyoming, Colorado and Utah on the following dates: Aug. 4 and 18, Sept. 1, 15 and 29, and Oct. 6 and 20.

The rate will be one fare plus \$2.00 for the round trip, the one-fare rate to be paid at time of purchase of ticket, and the \$2.00 to be paid at destination when certifying ticket for return. The tickets will bear transit limit of 15 days, in which stop-over will be allowed, and the final limit for return will be 21 days from the date of sale. Tickets will be good for return leaving destination only on Tuesday or Friday within the final limit. These tickets will be on sale at the Missouri river and points east thereof to the following territory:

To points in Kansas and Nebraska to which the rate from the nearest Missouri river is \$3.00 or more.

To points in Colorado on and west of a line drawn through Leadville, Salida and Alamosa.

To all points in Utah, except on the line of the Southern Pacific railroad.

To all points in South Dakota.

To points in Wyoming, at and west of Moorcroft.

If you desire any further information in regard to this matter, our local railroad agent will be glad to give you same.

Yours truly,

J. FRANCIS.

Gen. Pass. & Tkt. Agt., Burlington & Mo. River R. R. in Nebr.

P. S.—Rates will probably apply from as far east as Pittsburg, Pa., and Buffalo, N. Y. J. F.

The convention of the North American Bee-Keepers' Association will be held in one of the University buildings at Lincoln, Nebr., on Oct. 7th and 8th, next, commencing at 9 o'clock a.m., of the 7th, and closing with the evening session on the 8th.

I notice that reduced rates apply only to places east of Lincoln, and not to those west, or north, or south. I presume that our Nebraska friends will look after this matter.

I can secure tickets here, on a few days' notice, for the round trip for \$21.40 (the regular fare one way), being \$2.00 less than the Homeseekers' Excursion rate. It will be well for those intending to attend the convention, to look up the matter of railroad rates at the "cut rate" ticket offices in their own town or city near them. A. B. MASON, Sec.

Bee Journal from Jan. 1st.—We have a few complete sets of the American Bee Journal from Jan. 1, 1896—26 numbers—which we will mail, so long as they last, at 50 cents per set. Now, some of those who began to take the Bee Journal with July 1, will have a chance to get it complete for the whole of 1896. Remember, first come, first served; and there are less than 50 of the 6-month sets. Better order at once if you want one.

General Items.

Splendid Flow from Willow-Herb.

We are getting a splendid flow of honey from willow-herb at this date. I have just taken off over 4,000 pounds of as fine honey as I ever saw, and it is still coming. In fact, the crop was gathered last year after this time.

GEO. E. HILTON,
Fremont, Mich., July 23.

Bees Doing Well.

In the fall of 1895 I stored away 18 colonies, and lost two after taking out on April 16, being queenless. They worked right along from the start, not a backset of any kind, and now I have 33 colonies. I have six supers on for extracting, and the balance with comb honey supers. Some have three tiered up, some with two, and all I expect will be well filled. I have taken off some supers, and extracted some, and put on the market. I sell all my honey at home.

W. J. STEVENSON,
Guelph, Ont., July 20.

Some Good Work.

The last time I wrote I was in Florida. I am still among the bees, and my Florida colony, on my veranda there, sends me good reports, viz.: Two swarms, and \$2.00 worth of honey last spring, which, owing to no orange blossoms, is a good report.

I extracted 140 pounds of white clover honey from a swarm that came off on July 14. On July 13 the hive was full, and I took from the supers 140 pounds, actual weight. I have one colony now 8 supers high, with three entrances, and I am going to make affidavits as to yield. They have not swarmed yet. There is over 200 pounds of white honey stored now.

C. F. GREENING,
Grand Meadow, Minn., July 15.

Amalgamation—Reply to Dr. Miller.

On page 291, Dr. Miller wishes me to "take the trouble and look up the matter, and give us the names of those who advocate amalgamation who are not members of the Union." I never said those advocating amalgamation were not members of the Union. But I now do say, that, because they were members of the Union, they could speak for themselves only, and being members does not constitute them the majority. We should be willing to submit to the will of the majority, and not get the fur all turned the wrong way because some one differs from us.

He wants "the advocates of amalgamation who are not members of the Union to be named." Will the Doctor please favor us with the names of Union members who do not favor amalgamation?

Again the fur turns. The Doctor says he "wants the advocates of amalgamation" to "walk up and pay their \$1.00 like the rest of us." I did not accuse Dr. Miller of being delinquent, or any one else, but to quote my article correctly: "If any one, or any number of

THE "NOVELTY" POCKET-KNIFE!



Your Name on the Knife.—When ordering, be sure to say just what Name and Address you wish put on the Knife.

The NOVELTY KNIFE is indeed a novelty. The novelty lies in the handle. It is made beautifully of indestructible celluloid, which is as transparent as glass. Underneath the celluloid, on one side of the handle is placed an AMERICAN BEE JOURNAL reminder, and on the other side, name and residence of the Subscriber.

The material entering into this celebrated knife is of the very best quality; the blades are handforged out of the very finest English razor-steel, and warrant every blade. The holsters are made of German silver, and will never rust or corrode. The rivets are hardened German silver wire; the linings are plate brass; the back springs of Sheffield spring steel, and the finish of handle as described above. It will last a lifetime, with proper usage.

Why purchase the Novelty Knife? In case a good knife is lost, the chances are, the owner will never recover it; but if the Novelty is lost, having name and address of owner, the finder will return it; otherwise to try to destroy the name and address, would destroy the knife. If traveling, and you meet with a serious accident, and are so fortunate as to have one of the Novelties, your pocket KNIFE will serve as an identifier; and in case of death, your relatives will at once be apprised of the accident.

How appropriate this knife is for a Christmas, New Year or birthday present! What more lasting memento could a mother give to a son, a wife to a husband, a sister to a brother, a lady to a gentleman, or vice versa, a son to a mother, a husband to a wife, a brother to a sister or a gentleman to a lady—the knife having the name of the recipient on one side?

The accompanying cut gives a faint idea, but cannot fully convey an exact representation of this beautiful knife, as the "Novelty" must be seen to be appreciated.

How to Get this Valuable Knife.—We send it postpaid, for \$1.00, or give it as a Premium to the one sending us three new Subscribers to the BEE JOURNAL (with \$3.00), and we will also send to each new name a copy of the Premium Edition of the book "Bees and Honey." We club the Novelty Knife with the BEE JOURNAL for one year, both for \$1.90.

Any Name and Address Put on the Knife.

GEORGE W. YORK & CO.,
CHICAGO, ILLS.

Allow about two weeks for your order to be filled.

PATENT WIRED COMB FOUNDATION

Has No Sag in Brood-Frames

Thin Flat-Bottom Foundation

Has No Fishbone in the Surplus Honey.

Being the cleanest is usually worked the quickest of any Foundation made

J. VAN DEUSEN & SONS,

Sole Manufacturers,
Sprout Brook Montgomery Co., N. Y.

Mention the American Bee Journal



ONE MAN WITH THE UNION COMBINATION SAW

Can do the work of four men using hand tools, in Rippling, Cutting-off, Mitering, Rabbeting, Grooving, Gaining, Dadoing, Edging-up, Jointing Stuff, etc. Full Line of Foot and Hand Power Machinery Sold on Trial. Catalogue Free.

SENECA FALLS MFG. CO.,
SENECA FALLS, N. Y.

46 Water St.,

191y Mention the American Bee Journal.

Dadant's Foundation in Chicago!

No other Goods kept here.

Sent for Price-List.

CHAS. DADANT & SON,
118 Michigan St., CHICAGO, ILL.
13Atf Please mention the Bee Journal.

Untested Italian Queens, 75c.

3 FOR \$2.00.

Catalogue of Apian Supplies Free.

I. J. STRINGHAM,

105 Park Place. NEW YORK, N. Y.

APIARY—Glen Cove, L. I.

That Queen-Clipping Device Free!

Works Like a Charm.

The Monette Queen-Clipping Device WORKS LIKE A CHARM. With it I have clipped 30 queens, all in one day, when examining my bees. WM. STOLLEY, Grand Island, Nebr.

Couldn't Do Without It.

I have clipped 19 queens, and must say the Monette Queen-Clipping Device is by far the best invention ever made, and will be welcome to many bee-keepers as it was to me. I could not do without one now.

DR. GEO. LACKE, Newburgh, Ind.

PLEASE READ THIS OFFER TO PRESENT SUBSCRIBERS:

Send us just one new name for the American Bee Journal a year (with \$1.00), and we will mail you the Queen-Clipping Device FREE of charge. Or, the Queen-Clipping Device will be sent postpaid for 30 cts. But why not get it as a Premium by the above offer? You can't earn 30 cts. any easier. Almost every bee-keeper will want this Device. See page 130 (Feb. 27) for full description of it. Complete directions accompany each one sent out. It is a most ingenious and useful article. Address.

GEORGE W. YORK & CO., 118 Michigan St., Chicago, Ill.

❖ MONEY SAVED IS MONEY GAINED. ❖

THE ROYAL UNION Life Insurance Company

DES MOINES, IOWA.

The Iowa Policy

Is one that definitely promises to keep an accurate account with you; credit your premiums and interest, charge the actual expense and mortuary cost, and hold the remaining funds subject to your order.

Agents Wanted.

JOHN B. KING, GENERAL AGENT,
Suite 513 First Nat'l Bank Bld'g,
20Atf **CHICAGO, ILL.**
Mention the American Bee Journal.

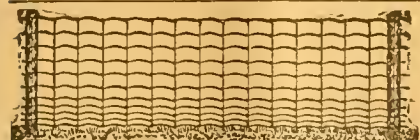

The Only Buffalo Fence.

The late Austin Corbin firmly believed it to be the Page. He used it freely on his great park in New Hampshire, and when he donated half his herd of Buffalo to the city of New York, he attended personally to having our fence enclose them. Not every farmer owns buffalo, but no one objects to a strong fence.

PAGE WOVEN WIRE FENCE CO., Adrian, Mich.

WHEN ANSWERING THIS ADVERTISEMENT, MENTION THIS JOURNAL.

IF YOU WANT THE

BEE-BOOK

That covers the whole Apicultural Field more completely than any other published, send \$1.25 to Prof. A. J. Cook, Claremont, Calif., for his

Bee-Keeper's Guide.

Liberal Discounts to the Trade.

California

If you care to know of its Fruits, Flowers Climate or Resources, send for a Sample Copy of California's Favorite Paper—

The Pacific Rural Press

The leading Horticultural and Agricultural paper of the Pacific Coast. Published weekly, handsomely illustrated, \$2.00 per annum. Sample Copy Free.

PACIFIC RURAL PRESS,
220 Market St., - SAN FRANCISCO, CAL.

TEXAS QUEENS.

If you are in need of Queens, let me have your order. Price-List Free.

8A26t **J. D. GIVENS, Lisbon, Tex.**
Mention the American Bee Journal.

BEGINNERS.

Beginners should have a copy of the Amateur Bee-Keeper, a 70-page book by Prof. J. W. Kouse. Price 25 cents; if sent by mail, 28c. The little book and the Progressive Bee-Keeper (a live, progressive 28-page monthly journal) one year, 65c. Address any first-class dealer, or

LEAHY MFG. CO., Higginsville, Mo.

New Honey For Sale.—I have a very choice lot of Basswood Extracted Honey in barrels, net 260 lbs., worth on cars here 6¼c. Also some honey in kits, net 50 lbs., at 6½c. This honey is the product of my bees, and is strictly pure. Will send sample on application. A. G. WILSON, Kickapoo, Vernon Co., Wis.
Mention the American Bee Journal.

bee-keepers, wish to avail themselves of the benefits to be derived from membership, let them walk up, etc." He should be a little more careful in quoting, and use the same words, so as not to get things twisted.

I meant just what I said in regard to expensive meetings. The object of the Union was most thoroughly accomplished without the expense of those meetings, and for those who in many instances could never attend said meetings, and still needed the protection for which it (the Union) was organized. It protected, fought the fight, and is still on a good financial footing. And if we can unite on a plan for enlarging its usefulness, I am with it, and think if a good working plan for an enlarged National organization can be presented, it will find backing by bee-keepers of the United States.

Canada can do likewise; we can work together and be of mutual benefit, but I am in for the United States first.

DR. G. A. MILLARD,
Los Angeles, Calif.

Quite a Spell.

There is a farmer who is YY
Enough to take his EE,
And study Nature with his II
And think of what he CC.
He hears the chatter of the JJ
As they each other TT,
And sees that when a tree DKK
It makes a home for BB.
—Toronto Empire.

Why Do I Keep Bees?

First, I never yet had all the honey I wanted to eat. I well remember one effort I made when a boy, back in the Empire State, to get what honey I could eat, and my failure. My mother kept a few bees, but honey was too rich for our blood—just about right for company; but if we were good children we were rewarded with what the company left, which was not enough to make us sick, for usually their appetite got the better of their manners, and we felt like the boy when he saw the last mouthful of pie go—"There, mother, goes manners and all."

My father's family was large, and the pocket-book correspondingly small, and we boys usually got 50 cents to spend at the County Fair; it took 25 of that to get in, and 25 cents won't buy everything a healthy boy can see on the fair ground.

One day, on our way to the fair, we overtook a wealthy neighbor and his boys with some cattle, sheep and colts, and he asked us to fall in and help drive the stock. We thought it was a little cheeky, and we hated to lose so much (to us) valuable time, but our mother had taught us to be obliging, so we followed along, but could not see why it needed so many boys to drive so few cattle and sheep, but when we got to the gate he called out to the gateman that these were all his boys, and told us to follow right along in, and, when once in, told us to go where we had a mind to and enjoy ourselves. (If old Mr. Slocum, of Little Valley, N. Y., should see this, he will no doubt remember the circumstance.)

The first thing that attracted my eye was a man and woman making and selling warm biscuit and honey (making the biscuit, not the honey, for that was before man learned to make "genioe bee-

Honey-Clovers & Buckwheat SEED FOR SALE.

We have made arrangements so that we can furnish seed of several of the Clovers and Japanese Buckwheat, by freight or express, at the following prices, cash with order

	5lb	10lb	25lb	50lb
Alsike Clover	\$.70	\$1.25	\$3.00	\$ 5.75
Sweet Clover	.75	1.40	3.25	6.00
White Clover	1.25	2.00	4.50	8.00
Alfalfa Clover	.65	1.10	2.70	5.00
Crimson Clover	.55	.90	2.00	3.50
Jap. Buckwheat	.20	.35	.90	1.25

Prices subject to market changes.
Add 25 cents to your order, for cartage, if wanted by freight.
Your orders are solicited.

GEORGE W. YORK & CO.,
CHICAGO, ILLS.

Sweet Clover Canada.

At the following prices:

5 lbs.	10 lbs.	25 lbs.	50 lbs.
\$1.00	\$1.60	\$3.75	\$7.25.

Also a quantity of Motherwort and Catnip seed. Prices on application.

EGGS for Hatching. Buff Leghorns, Indian Games, & Light Brahmas. Choice Birds. A breeder for 30 years. Prices on application

JOHN McARTHUR,
881 Yonge Street. TORONTO, ONT.
15Atf *Mention the American Bee Journal.*

* Extracted Honey *



Finest Quality. Basswood and Clover.

2 60-lb. cans in case, 8c. per pound. 1 60-lb. can in case, 9c. per pound. A sample by mail, 10 cts. **POUDER'S Honey-Jars and Complete Line of Supplies.** Catalogue Free.

WALTER S. POUDEUR,
162 Mass. Avenue. INDIANAPOLIS, IND.
Mention the American Bee Journal.

HONEY We have No. 1 Alfalfa, also White and Sweet Clover Honey we will sell cheap.

Honey and Beeswax Wanted.

Boss bee-escape Warranted the best, simplest and quickest Escape on the market. Sent postpaid to any address for 30 cts. It can be returned at our expense if it is not as represented, or we will send the Escape on trial to any bee-keeper wishing to test it in good faith. We are agents for the **Ferguson Patent Hive** with double-case Super and Wicket-Gate Honey-Board, with the Escape. It is the easiest, quickest hive to handle for the production of comb or extracted honey.

E. S. LOVESY & CO.,
355 6th East St., SALT LAKE CITY, UTAH.
Mention the American Bee Journal. 9Atf

Van Deusen Foundation!

I have some of the celebrated Van Deusen Thin Foundation in 25-pound boxes, that I will put on board cars for \$12.50 per box.

Also ITALIAN

Queens! Queens!



Fine Untested Queens mailed PROMPTLY at 55 cts. each, or Six for \$3.00.

Safe delivery and satisfaction guaranteed. Address.

F. GRABBE,
LIBERTYVILLE, Lake Co., ILL.

26Atf *Mention the American Bee Journal*

READERS Of this Journal who write to any of our advertisers, either in ordering, or asking about the Goods offered, will please state that they saw the Advertisement in this paper.

honey" without the aid of the bees!). I walked up to the counter and asked the man what he would ask for all the biscuit and honey I could eat, and when he said 25 cents, I planked down the quarter I had saved, and went to putting myself outside of the honey with a small amount of biscuit, and when I had disposed of eight dishes of honey, and called for more, he shoved back my quarter and told me to go. I thought that was "the most unkindest cut of all," so I resolved to own some bees as soon as I got where I could keep them, and I hope some day to have all the honey I want.

Now, Mr. Editor, if you see fit to put this in your paper, perhaps I will give you other reasons for keeping bees, but if you give me such a scorching as you did that other "illiterate, budding writer," I'll use you as I did the biscuit and honey vender—buy a paper of my own, or, better still, I'll "sick" Dr. Miller onto you—he can make you take a back seat. Suppose you give us the result of your hand-shake with him.

I have a great many questions I wanted to ask the Doctor, but fearing to annoy him with so many foolish questions, I bought an "A B C" book, and have already got into the a-b abs, and expect to find all my questions answered. *A. B. GINER.

Weeping Water, Nebr.

[We might say for A. B. Ginner's satisfaction, that the hand-shake came off all right, but "ye editor" didn't take a "back seat."

Don't be afraid to ask Dr. Miller any question you really desire answered, that cannot be found in the books. He likes to answer hard questions. It's so easy to say "I don't know"—even if it isn't exactly satisfying to the questioner.

Judging from A. B. Ginner's experience at the Fair, we think his stomach must have a regular honey-tank attachment. Not every one has such a "home market" to supply—and maybe it's a good thing they haven't, for we fear there wouldn't be much profit in it!—EDITOR.]

Large Crop—Sweet Clover Growing.

The honey crop of Nebraska promises a large one for 1896. Our surplus in this community is obtained mostly from sweet clover, heart's-ease, hoarhound, catnip, horsemint, wild cucumber and buckbush. Since it has been demonstrated that sweet clover makes good hay and pasture, many of our farmers instead of trying to exterminate it, as has hitherto been the custom, are encouraging its growth. W. H. Hudson purchased seed last spring, and sowed 30 acres on a rocky hill where neither grass nor weeds would grow; at this writing it stands on an average three feet high, and some of it is blooming. He finds his stock prefer it to any other kind of pasture. He and many of his neighbors will sow more next spring.

Louis Stalder, a prominent man and prosperous farmer living 12 miles south of this city, informs me his meadow in some way became seeded with sweet clover, and he said he did not know how to get rid of it, so he cut it, and he finds it makes a good quality of hay, as also

No. 1 Sections—Cheap.

We offer for a few weeks, a surplus stock of our one-piece No. 1 Cream Sections at the following very low prices:

- 1000 for \$1.50.
- 3000 for \$4.00.
- 5000 for \$6.00.

☐ These Sections are finely finished and No. 1 in all respects save color, being, as their name indicates, of a cream color.

The stock consists of a quantity each of the following sizes:

- 4¼x2, open 2 sides 4¼x1 15-16, open 2 sides
- 4¼x1 7-8, open 2 sides
- 4¼x1½, open 2 sides 4¼x7-to-ft., open 2 sides

G. B. LEWIS CO.

WATERTOWN, WIS.

ITALIAN QUEENS

Golden or Leather-Colored!
BY RETURN MAIL.

Fine Untested, 60c. each; two, \$1.00. Select Untested, 75c. Tested, \$1.00 Full Colonies cheap. No disease. Remit by express money order, payable at Barnum, Wis. Many customers send \$1.00 and \$2.00 bills. 2c. stamps taken for less than \$1.00. Safe delivery and satisfaction guaranteed.

P. S.—57 choice 2-yr.-old Queens, 25c. each while they last.

VAN ALLEN & WILLIAMS,
BARNUM, WIS.

29Atf Please mention the Bee Journal.

Page & Lyon Mfg. Co.,

NEW LONDON, WIS., operates two saw-mills that cut, annually, eight million feet of lumber, thus securing the best lumber at the lowest price for the manufacture of bee-keepers' supplies. They have also just completed one of

The Largest Factories,

and have the latest and most improved machinery for the manufacture of Bee-Hives, Sections, etc., that there is in the State. The material is cut from patterns, by machinery, and is absolutely accurate. For Sections, the clearest and

The Whitest Basswood

is used, and they are polished on both sides. Nearness to pine and basswood forests, and possession of mills and factory equipped with best machinery, all combine to enable this firm to furnish the best goods at

The Lowest Prices. ♡

For instance, it has a job lot of 200,000 No. 2 Sections that will be sold at 50 cts. per 1,000; or 2,000 Snow-White Sections will be sold for \$4.00, and larger quantities at still lower prices. Send for Circular and see the prices on a full line of supplies. 16Atf

History of the Adels

IN CARNIOLA there are two strains of Bees—one is gray or steel-colored, the other is yellow. The natives consider the yellow strain the best, and call them "THE ADELS." Adel means superior—and they are superior to all others. The Queens are very hardy and prolific; the Bees great workers, store and cap their honey nicely, and are sure to winter in "most any climate and seldom sting even when no smoke is used. I have had six years' experience with them, and never have had a swarm. Can ship 200 Queens by return mail. Everything guaranteed.

Our new Catalog giving way to introduce Queens, and testimonials, ready to mail. One Queen, \$1; 2 Queens, \$1.90; 3 Queens, \$2.50; 6 Queens, \$4.50; 12 Queens, \$8.00. Tested Queens, \$1.50.

Italian Queens same prices.

HENRY ALLEY,

28A4t WENHAM, MASS.

pasture. He says it is superior to alfalfa. When mixed with other hay his stock will pick it out and eat it first. Alfalfa has not proved such a success, either as a forage-plant or for honey, as we had hoped it would. After observing it for four years, I never have seen a bee on its bloom, although I am informed that bees work on it in the western part of the State. We have the white and yellow sweet clover, the yellow being two or three weeks earlier than the white. The yellow commences blooming about the last of May, and the white about the middle of June, and continues to bloom until frost. For 30 miles south of this city the roads are lined with it, and it is a delightful scene. J. L. GANDY.

Humboldt, Nebr., July 18.

A Drouth-Stricken Region.

We are in a drouth-stricken section this season. It has been extremely dry here. We had a good rain last week—the first in two months—it was dry previous to that time, so dry that bees barely gathered enough to keep up breeding. They have gathered more good honey in the last three days than in the last three months. The rain started a rank growth of cotton, which is now beginning to bloom. I now look for a good flow from that source. My wheat and oat crop was an entire failure. Corn is very short, but I have the best in this part of the country—it will yield 20 or 25 bushels per acre; I have 65 acres, so I will have some surplus.

I must say that my little advertisement in the American Bee Journal has brought me more orders than all my other advertising combined; and the Bee Journal is as regular as a clock. I have never missed a single number since I began taking it. It is bright, and full from cover to cover. Success to the American Bee Journal and it is editor.

J. D. GIVENS.

Lisbon, Tex., July 21.

Bees Puncturing Fruit.

On page 418, Mr. P. J. Schartz asks me to tell why it is that grapes and (other) fruit are punctured when there are no bees on them. The reason is that something else does the puncturing, but that is no argument that bees do not do it when they are at work on the fruit.

Mr. Schartz also says that domesticated bees never work on fruit when they have plenty of forage. No one disputes that fact, but it happens too often with us here that bee-forage is lacking just at the time when berries are ripe, and the bees work on them until, as Mr. Schartz says, they are a perfect nuisance, and I have looked in vain for the wild bees, wasps and hornets that are said to come and obligingly puncture the skin so the bees can get the juice. I never knew bees to puncture pears, but that is no evidence that they do not, and I fully agree with Mr. Schartz that wild bees and flies may puncture fruit as well as domesticated bees.

Wasps, hornets and bumble-bees have become very scarce here, and yet it is only in the past few years that bees have been destructive on fruit. When we had plenty of wasps and hornets our bees seldom touched the fruit, but we don't lay any of the blame to the want of these insects, as we know that it is the lack of forage that causes the bees to

work on the fruit, and as there is no hopes of there being any different conditions in the years to come, it is a serious question whether or not we are doing right by our fruit-growing neighbors, in keeping bees that are of no profit whatever to us, and are a detriment to them.

Mr. Schartz says, give bees plenty of forage and there won't be any trouble with their puncturing fruit. In that we perfectly agree, but will he tell us how to produce that forage in paying quantities on land that is worth \$75 per acre? We have tried buckwheat, and it is only about one year in five that it produces any honey here. We have basswood, but this year while the basswood trees were loaded with bloom our bees worked on the ripe strawberries, there being no honey in the basswood. What is it that we must plant that will produce honey and pay us for its time and labor, and the use of our land?

There is not an acre of land within reach of my bees that is not either cultivated or else pastured. Even our timber lands lack forest conditions. The mulching of leaves that characterizes timber lands in a state of nature have been burned off, and all the brush and underwood cut away, and a coat of bluegrass now occupies the ground. The dairy proved to be more profitable than the apiary, and the milk cow has crowded the honey-bee to the wall, and will eventually crowd it out of existence here.

W. S. FULTZ.
Muscatine, Iowa, July 18.

Not a Very Good Season.

I am working for comb honey only. We think it a big crop if we get as much as 50 pounds from a colony, but the majority bring only 25 pounds. But in return we get from 15 to 18 cents per pound. Home consumption has been about equal with the production. My father has been tending the bees for a number of years, and this year I was going to take charge of them, and just as I was ready to put the first supers on all the strong colonies, the doctor put me to bed, and will likely keep me there for several weeks on account of lung trouble. So father will have to take charge of the bees again.

We get our honey from wild fruit, such as gooseberries, plums, and others; also a lot of basswood, but there have been several years of drouth, which have brought no honey. Last year was a fair one—we got some 300 pounds. This year will be less, I think.

L. A. SYVERUD.
Canton, S. Dak., July 15.

Hunting Wild Bees in Louisiana.

I had never hunted bees until last winter and spring. It amuses me to read the trouble people go to to find a bee-tree. Henry Hooks, from Texas (now a resident of New Orleans), and myself found and cut last winter and spring 72 bee-trees. Every colony found was in cypress trees. Two trees had each two colonies. One hollow had the skeletons of five little squirrels, three hollows had skeletons of old squirrels, and one hollow contained nine duck eggs. In one hollow we found two large king snakes.

Our 72 trees were cut in 33 different days. The greatest number of trees we cut in any one day was six, and six trees was the greatest number I found in any

**The Bee-Keepers' Guide:
Or Manual of the Apiary,**

By Prof. A. J. Cook.

This 15th and latest edition of Prof. Cook's magnificent book of 460 pages, in neat and substantial cloth binding, we propose to give away to our present subscribers, for the work of getting NEW subscribers for the American Bee Journal.

A description of the book here is quite unnecessary—it is simply the most complete scientific and practical bee-book published today. Fully illustrated, and all written in the most fascinating style. The author is also too well-known to the whole bee-keeper to require any introduction. No bee-keeper is fully equipped, or his library complete, without "THE BEE-KEEPER'S GUIDE."

Given For 2 New Subscribers.

The following offer is made to PRESENT subscribers only, and no premium is also given to the two new subscribers—simply the Bee Journal for one year:

Send us Two New Subscribers to the Bee Journal (with \$2.00), and we will mail you a copy of Prof. Cook's book FREE as a premium. Prof. Cook's book alone sent for \$1.25, or we club it with the Bee Journal for a year—both together for only \$1.75. But surely anybody can get only 2 new subscribers to the Bee Journal for a year, and thus get the book as a premium. Let everybody try for it. Will you have one?

GEORGE W. YORK & CO.,
CHICAGO, ILLS.

A Bargain—EARLY QUEENS.

119 Colonies Italian Bees in Chaff Hives: two acres land; good house; excellent well.

Early Queens—Tested, \$1.00; Untested, 50c. Sent by return mail.

E. L. CARRINGTON,
161st PETTUS, Bee Co., TEX.
Reference—1st National Bank of Beeville.
Mention the American Bee Journal.



Bee Supplies
Largest Stock and Greatest Variety in the West. BEST Good-at-Low-EST prices. Cat. of 80 pages FREE.

E. KRETCMER, RED OAK, IOWA.
Mention the American Bee Journal. 23D9t

**HARDY—&—PROLIFIC
QUEENS**

Gray Carniolans or Golden Italians bred in separate apiaries—One Untested Queen, 65c.; six for \$3.50. Tested, \$1.25. Select Tested, \$2.25. Best Imported, \$4.00

Never saw foul brood or bee-paralysis.
SATISFACTION GUARANTEED.
Descriptive Price-List Free.

F. A. LOCKHART & CO.,
27Dtt LAKE GEORGE, N. Y.
Mention the American Bee Journal.

10 per ct. Off to Reduce Stock

on all kinds of SUPPLIES, except —COMB FOUNDATION— which will be sold in lots of 10 lbs. or more as follows: Medium, 35 cts.; Light, 36 cts.; Thin Surplus, 40 cts.; Extra Thin, 45 cts.

Queens—Warranted, 50c.; Tested, 75c.
W. J. FINCH, Jr., SPRINGFIELD ILLS.
Mention the American Bee Journal.

READERS of this Journal who write to any of our advertisers, either in ordering, or asking about the Goods offered, will please state that they saw the Advertisement in this paper.

one day. Mr. Hooks found 13 the same day.

We estimated the value of the trees cut as follows: Queens saved with bees at 50 cents; combs transferred, at 10 cents; wax at 26 to 29 cents per pound (the prices we obtained); honey at 50 cents per gallon. Our best tree figured up \$3.94. Three trees figured nothing, being young swarms that were either lost or united.

We saved 50 colonies of bees, and transferred in the swamps 261 combs. We made 152 pounds and 6 ounces of beeswax, and took 29 gallons of honey. Everything is valued at \$110.34.

These numbers and figures are taken from my record. We cut four more trees on May 11 or 12, which are transferred and still in the swamp. One tree gave us five gallons of honey, eight pounds of wax, and five transferred combs, and must have swarmed since. Mr. Hooks has since cut over a dozen trees with other parties. Of the trees cut, I found 29.

H. C. AHLERS.
Lee, La., July 20.

Best Season in 20 Years.

My bees have not done so well in 20 years in gathering honey—perhaps the best season so far in many a year. There was an abundant bloom both of white and Alsike clover, and both seemed to secrete honey plentifully. Basswood was abundant in bloom, but did not yield the honey that it does in some years. My bees commenced to swarm in May; the like I never had since I have kept bees. One of the swarms that came out in May, I have given them the fourth case of sections to fill, 24 in each case; they have filled, I think, three of them. Now the bees are busy working on buckwheat, and soon will be on wild flowers. If they do as well this fall as they did last, in gathering honey, they will bring in and store as much in the month of August and September as they have in June and July, this far; we shall be overstocked with honey.

L. ALLEN.
Loyal, Wis., July 18.

Drones Mating with Worker-Bees.

Do drones mate with worker-bees? Now some may say, why does that old Missourian ask that question? or, what does it amount to if they do or do not? I will say that it amounts to a good deal with me, and I do hope that some of our most experienced bee-men will speak up, and then I will tell what I know—not what I think, but what I know, and how I know it. This question is linked in with the question that I have asked before, in regard to the number, or supposed number, of eggs that have ever been found in a queen. It seems that this question, too, should find an answer, as thousands of queens have been killed for the purpose of requeening, and it seems to me that some one would have curiosity enough about the matter to dissect a queen, and with a good magnifying glass, such as bankers use, examine them. It is a very easy matter to count every egg in a laying queen. I have examined five this season. Try it, and you may be surprised. I was. And you may be when, sometime, through the columns of the Bee Journal you see my discovery on those two questions.

I have been an invalid for several years, and I spend hours after hours in

my apiary, though at present a small one, but it is my heart's delight to watch and work with my bees. I sometimes have a hearty laugh at some one's experience in handling and hiving bees. I will describe a device of my own that has in time caused me not to climb a tree and saw off a limb to get a swarm down when it clusters out of reach.

I get a pole or a plank that will reach to where the swarm is; if a plank I tie a brushy limb to the end of it with the leaves on; if a pole, I leave a brush on the end. I run that into the cluster, getting as many bees as I can get on it. Then with another pole I have some one give the limb a punch, jarring all the cluster off. They will then settle to the bees that you have on the pole, if you will hold it for a bit close to where they were clustered. After they begin going on the pole all right, you can lean it against something and prepare the hive. When well settled, carry them carefully to the hive, shake them off, and lay the pole away for further use.

The article by Mr. Zigler, on page 454, is the nearest my method of getting the start of a line of any bee-hunter I have read about, only I never use a box. I merely cut off a small bunch of the flowers with the honey on, and carry it carefully with the bees on it. I shall always think that if he had cross-lined his course, or line, he would have found the bees before he went 4 miles. Go back, Mr. Zigler, put out the bait, and find the tree you passed.

Pollock, Mo. ANDREW COTTON.

Did Fairly Well.

Bees did fairly well this season. The white clover was everywhere plentiful, but for excessive rains the first half of the season, the honey crop would have been bountiful. The bees have plenty for winter, and we shall hope for better rewards next season. W. N. KING.

Ebenezer, Mo., July 21.

Convention Notices.

TEXAS.—The Central Texas Bee-keepers' Association meets at Cameron, Tex., Aug. 7 and 8, 1896. No hotel bills to pay.
C. B. BANKSTON, Cor. Sec.
Chrlesman, Tex.

TEXAS.—The third annual convention of the Southwest Texas Bee-keepers' Association will be held at Beeville, Tex., on Sept. 16 and 17, 1896. All are invited. No hotel bills to pay. Low rates on railroads.
Beeville, Tex. J. O. GRIMSLEY, Sec.

ILLINOIS.—The annual meeting of the Northern Illinois Bee-keepers' Association will be held at the residence of B. Kennedy, 3 miles northeast of New Milford, Ill., on Tuesday, Aug. 18, 1896. All are cordially invited, and I will meet any one at the train in New Milford if they will drop me a card.
New Milford, Ill. B. KENNEDY, Sec.

Missing Number Wanted.—Wm. Wilson, of Bardstown, Ky., would like to have the Bee Journal for Nov. 3, 1892, No. 19, Vol. XXX, in order to complete his file. Will some one who can spare that number please write Mr. Wilson?

MUTH'S HONEY EXTRACTOR
PERFECTION
Cold-Blast Smokers,
Square Glass Honey Jars, Etc.
For Circulars, apply to CHAS. F. MUTH & SON,
Cor. Freeman & Central Aves., Cincinnati, O.
Send 10c for Practical Hints to Bee-Keepers.

HONEY and BEESWAX

MARKET QUOTATIONS.

The following rules for grading honey were adopted by the North American Bee-keepers' Association, and, so far as possible, quotations are made according to these rules:

FANCY.—All sections to be well filled; combs straight, of even thickness, and firmly attached to all four sides; both wood and comb unsoiled by travel-stain, or otherwise; all the cells sealed except the row of cells next the wood.

No. 1.—All sections well filled, but combs uneven or crooked, detached at the bottom, or with but few cells unsealed; both wood and comb unsoiled by travel-stain or otherwise.

In addition to this the honey is to be classified according to color, using the terms white, amber and dark. That is, there will be "fancy white," "No. 1 dark," etc.

Chicago, Ills., July 7.—We quote: Fancy white clover, 15c.; No. 1 white, 12@13c.; fancy amber, 10@11c.; No. 1 amber, 7@9c.; fancy dark, 9@10c.; No. 1 dark, 7c. Extracted, white, 5@7c.; amber, 5@5½c.; dark, 4½@5c. Beeswax, 25@27c.

Philadelphia, Pa., July 10.—No. 1 amber, 9-10c.; fancy dark, 8-9c.; No. 1 dark, 7-8c. Extracted, white, 8-10c.; amber, 5-5½c.; dark, 3½-4c. Beeswax, 25-26c.

Honey very dull. Beeswax in fair demand.

Buffalo, N. Y., July 24.—Fancy comb, 1-pound, 12-14c.; No. 2, 9-10c.; No. 3, 4-8c. Extracted, 3-5c., as to quality. It is folly to ship honey unless properly packed. Good results depend on it and quality.

Cincinnati, Ohio, July 10.—No. 1 white, 13@14c.; fancy amber, 12@13c.; No. 1 amber, 10@12c. White, extracted, 5@7c.; amber, 5@6c.; dark, 3½-5c. Beeswax, 20-25c.

New York, N. Y., June 24th.—No demand for comb honey of any kind. New crop of Southern extracted is arriving freely, and sells fairly good at 50@52c per gallon for common, and 55@60c per gallon for better grades. Beeswax dull at 26@27c.

Cleveland, Ohio, July 9.—We quote: Fancy white, 15@16c.; No. 1 white, 14@15c.; fancy amber, 10@11c. Extracted, white, 6@6½c.; amber, 4@5c. Beeswax, 20@25c.

Our market is nearly bare of honey. We think early shipments would meet with ready sales at about quotations.

St. Louis, Mo., July 9.—We quote: Fancy white, 11½@12c.; No. 1 white, 10½@11c.; fancy amber, 10@10½c.; No. 1 amber, 9@10c.; fancy dark, 8½@9c.; No. 1 dark, 7@8c. Extracted, white, in casks, 5c.; in barrels, 4c.; amber, 3½@4c.; dark, 3@3½c. Beeswax, 25@25½c.

This week we sold 4,700 pounds of Southern extracted in barrels at 3½c. Honey is in fair demand. Very little fancy new comb coming in, and what has been offered not well cured as yet.

Minneapolis, Minn., July 9.—We quote: Fancy white, 15c.; No. 1 white, 13@14c.; fancy amber, 10@12c.; No. 1 amber, 8@10c.; fancy dark, 7@9c.; No. 1 dark, 8c. Extracted, white, 5½@6½c.; amber, 5¼@5½c.; dark, 4¼@5¼c. Beeswax, 26@28c.

Actual transactions both in comb and extracted very light. Minnesota and Wisconsin comb will commence arriving in moderate quantities about August, and will probably supply the market until cool weather, which usually stimulates a demand. Considerable extracted is now here on the spot, sufficient to supply immediate wants.

Albany, N. Y., July 10.—Fancy white, 13-14c.; fancy dark, 8-9c.; No. 1 dark, 6-7c. Extracted, dark, 4-5c.

Stock of old comb honey is reduced to a few cases of 2-pound buckwheat and some 1-pound white California, which we expect to close out before new crop arrives on market. Conditions are favorable in this section for a good crop of white honey.

Kansas City, Mo., July 20.—Fancy white comb, 15c.; No. 1 white, 13@14c.; fancy amber, 12-13c.; No. 1 amber, 11-12c.; fancy dark, 10-11c.; No. 1, 8-10c. Extracted, white, 6-6½c.; amber, 5-5½c.; dark, 4-4½c. Beeswax, 22-25c.

Milwaukee, Wis., July 13.—No. 1 white, 12-13c.; No. 1 amber, 8-10c. Extracted, white, 7-7½c.; amber, 6-6½c.; dark, 5-6c. Beeswax, 20-24c.

The supply of honey is not large and nearly all old crop, as the receipts of new are extracted; quality fair. The demand is limited, as the supply of small fruits is large and the consumption of honey is small. The market will be in good condition for shipments of the new crop, both comb and extracted, and we look for a good demand later.

Detroit, Mich., July 13.—No. 1 white, 11-12½c.; fancy amber, 10-11c.; No. 1 amber, 9-10c.; fancy dark, 8-9c.; No. 1 dark, 7-8c. Extracted, white, 6-7c.; amber, 5-6c.; dark, 5c. Beeswax, 24-25c.

There is very little old honey on the market that is desirable. New honey will sell slowly in this market until October.

Boston, Mass., July 15.—Fancy white, 14-15c.; No. 1 white, 12-13c.; fancy amber, 9-10c. Extracted, white, 6-7c.; amber, 5-6c. Beeswax, 25-26c.

Fancy new white honey now in stock; demand fair. Old stock nearly closed out.

San Francisco, Calif., July 15.—White comb, 9½-11c.; amber, 5-7½c. Extracted, white, 5-5½c.; light amber, 4½-4¾c.; amber colored and candied, 3¼-4c.; dark tulle, 2½-3c.

With this year's crop in California almost a total failure, there will be little chance for business this season. Prices now existing are too high for any export trade.

Beeswax, fair to choice, 22-26c. Not much offering, neither is demand brisk.

List of Honey and Beeswax Dealers.

Most of whom Quote in this Journal.

- Chicago, Ills.**
R. A. BURNETT & Co., 163 South Water Street.
New York, N. Y.
HILDRETH BROS. & SEOLKEN,
120 & 122 West Broadway
CHAS. ISRAEL & BROS., 486 Canal St.
Kansas City, Mo.
O. C. CLEMOMS & Co., 423 Walnut St.
Buffalo, N. Y.
BATTERSON & Co., 167 & 169 Scott St.
Hamilton, Ills.
CHAS. DADANT & SON.
Philadelphia, Pa.
WM. A. SELSER, 10 Vine St.
Cleveland, Ohio.
WILLIAMS BROS., 80 & 82 Broadway.
St. Louis, Mo.
WESTCOTT COM. CO., 213 Market St.
Minneapolis, Minn.
S. H. HALL & Co.
Milwaukee, Wis.
A. V. BISHOP & Co.
Boston, Mass.
E. E. BLAKE & Co., 57 Chatham Street
Detroit, Mich.
M. H. HUNT, Bell Branch, Wayne Co., Mich
Cincinnati, Ohio.
C. F. MUTH & SON, cor. Freeman & Central avs.

North American Bee-keepers' Association

OFFICERS FOR 1896.

PRESIDENT—A. I. Root..... Medina, Ohio.
VICE PRES.—Wm. McEvoy..... Woodburn, Ont.
SEC.—Dr. A. B. Mason..... Sta. B. Toledo, Ohio
TREAS.—W. Z. Hutchinson..... Flint, Mich
Convention at Lincoln, Nebr.

National Bee-keepers' Union.

PRESIDENT—Hon. R. L. Taylor...Lapeer, Mich.
GEN'L MOR—T. G. Newman...San Diego, Cal.

Bee-keeper's Guide—see page 476.

Now for a 2-Month Campaign

Please Read All of this Page.

A Few of the Good Things to Appear in the Bee Journal Yet This Year :

Fifteen Years' Experience in Bee-Keeping.

Mrs. Sallie E. Sherman, of Texas, began, in the first number for July, a full account of her 15 years of bee-keeping in Texas. An article from her will appear each week for a number of weeks. They will be of much interest to all, and especially so to Southern bee-keepers.

A Dozen Articles by "The Dadants."

Chas. Dadant & Son, of Illinois, are the leading extracted honey producers of this part of the country. One year they had 48,000 pounds. They will contribute during the next six months, at least a dozen articles, drawn from their experience of a third of a century of bee-keeping.

A Dozen Articles by Mr. Doolittle.

G. M. Doolittle is unquestionably one of the very ablest bee-keepers in this country, and his writings on practical bee-culture have made him famous. With his 27 years' experience, he is well equipped to write profitably for the beginner or even the expert bee-keeper.

A Half-Dozen Articles by Prof. Cook.

Prof. A. J. Cook, of California, author of "The Bee-Keepers' Guide," will contribute at least six good articles before Jan. 1, 1897. He is always interesting and helpful.

A Full Report of the North American Convention

will be published in this paper immediately after the annual meeting, which will be held in September or October next, at Lincoln, Nebr. The Secretary—Dr. A. B. Mason—is now at work on the program, which promises to be the best ever gotten up by the Association. Every American bee-keeper will be interested in the many valuable essays and discussions found in the proceedings of their great annual convention.

A Variety of Contributions by Many Others,

who are well qualified to teach modern bee-culture, will also appear during the next six months. All the foregoing in addition to the

Several Special or Regular Departments

will make the American Bee Journal almost priceless to the man or woman who desires to make a genuine success of bee-culture, and keep informed about the doings of the apianian world.

Some Liberal Premiums to Regular Subscribers.

We want every regular reader of the American Bee Journal to go to work to secure new subscribers, which we will accept at

40 Cents for Six Months.

Yes, sir; we will mail the American Bee Journal from July 1, 1896, to Jan. 1, 1897—26 numbers in all—to any one not now a subscriber, for just 40 cents. And to those of our present subscribers who will work to get the new names, we make these

Generous Premium Offers :

For sending us One New Six-Months' Subscription (with 40 cents), we will mail the sender his or her choice of one of the following list of pamphlets :

Foul Brood, by Dr. Howard.	Dr. Foote's Hand-Book of Health.
Kendall's Horse-Book.	Poultry for Market and Profit.
Rural Life.	Our Poultry Doctor.
Silo and Silage, by Prof. Cook.	Turkeys for Market and Profit.
Foul Brood, by Kohnke.	Capons and Caponizing.

For sending Two New Six-Months' Subscriptions (with 80 cents), your choice of one of the following :

Monette Queen-Clipping Device.	Winter Problem, by Pierce.
Bienen-Kultur.	Alley's 30 Years Among the Bees.
Bees and Honey (paper cover).	Queenie Jeanette (a Song.)

For sending Six New Six-Months' Subscriptions (with \$2.40), your choice of one of the following :

Novelty Pocket-Knife (with name). Prof. Cook's Bee-Keeper's Guide

\$25.00 Cash, in Addition to the Above.

Besides all the foregoing premiums, we will distribute, on Sept. 1, 1896, \$25.00 in cash to the nine having sent in the highest number of new 40-cent subscriptions before that date, (but only those having sent 10 or more new subscriptions can compete for the extra cash premiums) in these amounts: To the one sending the highest number, \$10.00. The 2nd highest, \$5.00; 3rd, 4th and 5th highest, \$2.00 each; and to the 6th, 7th, 8th and 9th highest, \$1.00 each.

Let Every One Begin NOW to Work.

We will be glad to mail free sample copies, upon request, either to a club-raiser, or direct to those you desire to solicit, if you will send in the names and addresses.

☞ All subscriptions will begin with the first number in July.

Yours for a two-months' campaign,

GEO. W. YORK & CO., 118 Mich. St., Chicago.

"Samantha at the World's Fair."—We want to make our present readers one of the best offers ever made. All know the excellent books written by "Samantha, Josiah Allen's Wife." Well, "Samantha at the World's Fair" is probably her best, and we are enabled to offer *this book and a year's subscription to the New York "Voice"* (the greatest \$1.00 weekly temperance paper published to-day), for sending us *only three new subscribers* to the American Bee Journal (with \$3.00), provided you are *not now* a subscriber to the "Voice." Think of it—a grand book and a grand weekly temperance newspaper *given simply for sending* us three new subscribers to the Bee Journal for a year! The Samantha book is exactly the same as the \$2.50 one, only the binding is of heavy manilla instead of cloth. It is a special 100,000-copy edition, and when they are all gone, the offer will be withdrawn by the publishers. Of course, no premium will also be given to the new subscribers—*simply the American Bee Journal for one year.*

Only One Cent a Copy for copies of the American Bee Journal before Jan. 1, 1896. We have them running back for about 10 years. But you must let us select them, as we cannot furnish them in regular order, and probably not any particular copies. Just send us as many one-cent stamps as you may want old copies, and we will mail them to you.

Honey as Food and Medicine.—A new and revised edition of this 32-page pamphlet is now issued. It has 5 blank pages on which to write or paste recipes taken from other sources. It is just what its name indicates, and should be liberally distributed among the people everywhere to create a demand for honey. It contains a number of recipes on the use of honey as food and as medicine, besides much other interesting and valuable information. Prices, postpaid, are: Single copy, 5 cts.; 10 copies 30 cts.; 50 for \$1.00; 100 for \$1.75. Better give them a trial. Send all orders to the Bee Journal office.

Bottom Prices

**BRING US BIG TRADE.
GOOD GOODS KEEP IT.**

If you want the best supplies that can be made at a little less cost than you can buy the same goods for elsewhere, write to us for low prices. 1896 Catalogue now ready—ask for it and a free copy of **The American Bee-Keeper** (36 pages).

Address,
THE W. T. FALCONER MFG. CO.,
JAMESTOWN, N. Y.
Mention the American Bee Journal.

COMB FOUNDATION!

Wax always wanted for Cash or in Exchange for Fdn. or other Supplies. My trade is established on **Low Prices** and the merit of my **Foundation. Orders filled promptly.**
WORKING WAX INTO FDN. BY THE LB. A SPECIALTY. Wholesale prices to dealers and large consumers. Send for Prices and Samples to—**GUS DITTMER, AUGUSTA, WIS.**
Reference—Augusta Bank. 1Atf
Mention the American Bee Journal.

I ARISE



TO SAY to the readers of the **BEE JOURNAL** that **DOOLITTLE** has concluded to sell—**BEEES and QUEENS**—in their season, during 1896, at the following prices:
One Colony of Italians on 9 Gallup frames, in light shipping-box \$6 00
Five Colonies.... 25 00
Ten Colonies..... 45 00
1 untested queen. 1 00
6 " queens 5 50
12 " " 10 10
1 tested Queen... \$1 50
3 " Queens. 3 50
1 select tested queen 2 10
3 " Queens 4 00

Select tested queen, previous season's rearing . 4 00
Extra Selected for breeding, THE VERY BEST.. 5 00
About a Pound of BEEES in a Two-frame Nucleus, with any Queen, \$2.00 extra.

☛ Circular free, giving full particulars regarding the Bees and each class of Queens.
Address

G. M. DOOLITTLE,
12A 25t BORODINO, Onon. Co., N. Y.
Mention the American Bee Journal.

BEEES QUEENS
Smokers, Sections, Comb Foundation, And all Apilairn Supplies cheap. Send for FREE catalogue. E. T. FLANAGAN, Belleville, Ill.
6A 26t Please mention the Bee Journal.

100 QUEENS AT 50c.

This is the season of the year when the best Queens can be reared for the least money, but almost everybody has Queens and the trade is dull. For this reason it is more profitable to sell Queens even at half price, and have them move off promptly, than to hold them week after week trying to sell at a high price. My nuclei are now full of laying Queens, and I want them to move off and make room for others that are coming on, and for that reason I will sell them at 50 cts. each, let the order be big or little. Remember they are nice, young, laying, Italian Queens. I also have plenty of **TESTED** Queens at 75 cts. each.

W. Z. HUTCHINSON, FLINT, MICH.
Mention the American Bee Journal. 29A 6t

19th Year Dadant's Foundation 19th Year

It still in the lead, for we use all the latest improvements, including the

NEW WEED PROCESS,

and still make the best goods. Remember that we do not use any acid to purify our beeswax, and that is why our Foundation preserves the smell of the honey and is, more acceptable to the bees, than any other. It is kept for sale by

- T. H. Strickler, Solomon City, Kansas.
- G. K. Hubbard, Fort Wayne, Ind.
- L. Hansen, Davenport, Iowa.
- C. Theissann, Theilmantou, Minn.
- E. C. Eaglesfield, Berlin, Wis.
- E. T. Abbott, St. Joseph, Mo.
- J. M. Jenkins, Wetumpka, Alabama
- John Rey, East Saginaw, Mich.
- Vickery Bros., Evansville, Ind.

- The Jennie Atchley Company, Beeville, Texas.
- C. F. Muth & Son, Cincinnati, Ohio
- E. Kretschmer, Red Oak, Iowa.
- G. B. Lewis Co., Watertown, Wis.
- James Reynolds Elevator Co., Poughkeepsie, N. Y.
- Louisiana Bee-Keepers' Supply Manufactory, Donaldsonville, La.
- Pape & Lyon, New London, Wis.
- John Nebel & Son, High Hill, Mo.

and many other Dealers. All agree in saying that no goods are better than ours.

Those of our customers who formerly bought through Thos. G. Newman can get our Foundation in **Chicago, Ill.**, by addressing us at **118 Michigan Street.** We keep no other goods there.

We make a specialty of **Veils and Veil Stuffs** of best quality, cotton and silk.

"LANGSTROTH ON THE HONEY-BEE"—Revised.

Bee-Keepers' Supplies, Smokers, Sections, Tin Pails, etc.
Samples of Foundation and Tulle FREE with Circular. Instructions to beginners with Circular. Send us your address.

CHAS. DADANT & SON,

HAMILTON, Hancock Co., ILL.

Mention the American Bee Journal.

22c Cash Paid for Beeswax!

For all the good, pure yellow **BEEESWAX** delivered to our office till further notice, we will pay 22 cents per pound, cash; or 26 cents for whatever part is exchanged for the American Bee Journal, Books or Seed, that we offer. If you want **cash promptly** for wax, send it on at once. Dark or impure wax not taken at any price. Address plainly,

George W. York & Co., 118 Michigan St., Chicago, Ill.

NEW PROCESS

Our Total Output so far this Season is Nearly **50,000 lbs.,** which is **10,000 lbs. More than the Best Year of the Old-Process Foundation.**

Weed Foundation

We are receiving very flattering testimonials from the leading bee-keepers all over this country, and, in fact, of the world. Here is one that has just been received from the inventor of the Cowan extractor, editor of the **BRITISH BEE JOURNAL**, and author of the **British Bee-Keeper's Guide-Book**—a work that has had an enormous sale, and which has been translated into French, German, Danish, Swedish, Russian, and Spanish. Mr. Cowan, under date of June 18, gives the new foundation this high encomium:

I have had an opportunity of trying the Weed foundation. I like it very much, and certainly think it all that it is represented.
Yours very truly,
London, Eng., June 18. **THOS. WM. COWAN.**

And that is not all. We have sent several very large consignments of this new process foundation to England. The British bee-keepers demanding this article all over the British Isles, just the same as American bee-keepers are demanding the same all over the United States. Our British cousins know a good thing when they see it.

We have many other fine testimonials, but we have not room to display them here.

THE A. I. ROOT COMPANY,
MEDINA, OHIO.

NOTHING LIKE IT.

AMERICAN BEE JOURNAL

DEVOTED EXCLUSIVELY TO THE INTERESTS OF HONEY PRODUCERS

ESTABLISHED IN 1861
THE OLDEST BEE-PAPER IN AMERICA

Published Weekly, at \$1.00 per annum.

Sample Copy sent on Application.

36th Year.

CHICAGO, ILL., AUGUST 6, 1896.

No. 32.

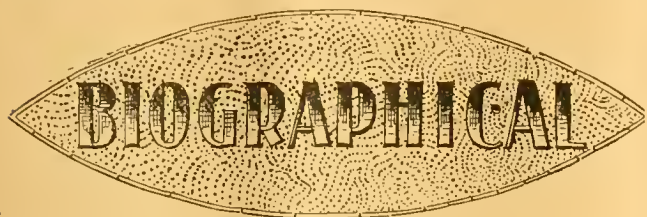

MR. H. E. HILL.

The subject of this sketch was born at Port Burwell, Ont., Canada, Aug. 8, 1865. His interest in bees dates back to early childhood days, his father being a progressive bee-keeper of that time, making and using sections holding about two pounds each as early as 1868. Bleak lake winds and winter losses, or, rather, spring losses, rendered the business unprofitable in that locality, and it was accordingly abandoned a few years later, but the admiration and keen interest awakened so early in life still clung to him, and his father's books and papers, and all other available literature relating to bee-culture afforded a favorite pastime, while those throughout the surrounding country who possessed several colonies of bees, and "knew all about them," were objects of envy, and young Hill lost no opportunity to be around in their way and bore them with questions; his delight was to be given some kind of a job to do about the bee-work, and after more than 20 years of study and practice there is now no part of the work with bees that does not give him the same pleasure and fascination.

Mr. Hill's actual bee-keeping began in 1880, when his father presented him with two colonies and a year's subscription to the American Bee Journal, since which time he has been a constant student of apiculture, and a reader and admirer of the "Old Reliable."

With four years' work as an amateur, came a keener realization of the depths of mystery and consequent necessity of knowledge in order to become proficient.

In 1884, with his parents, Mr. H. moved to Pennsylvania, taking two colonies of bees to test the new field, which were increased to six that year; but little honey was taken, as the locality afterwards proved to be one of the poorest in the State.

In 1885 arrangements were made by which he was to spend the entire season in the Woodstock (Ont., Canada) apiary, and he returned to Canada in April, giving his time for the following six months in exchange for instruction under Mr. J. B. Hall, and the proudest moment of his life, probably, was when he received a certificate of his ability as an apiarist from Canada's comb-honey king.

The following spring, with 30 colonies in nondescript

hives, after transferring them to uniform frames, he secured one ton of section honey, 700 pounds of extracted, and increased to 83 good, strong colonies, which he wintered without loss—at Titusville, Pa.

Mr. Hill's anxiety to familiarize himself with the honey-resources of the whole country, led him to apply for a position in reply to an advertisement for an apiarist to establish an apiary in the West Indies, and his recommendation from Mr. Hill was instrumental in securing the job, against nearly 100 other applicants, and he accordingly sailed for Cuba on Oct. 16, 1886, returning to Pennsylvania the following April, and resuming charge of his little apiary; but four successive failures of the honey crop in that field caused him to dispose of his bees.

In 1887 he received a letter from his Spanish employer in Cuba, saying that he desired him to return and take charge



H. E. Hill.

of his bee-business, in this language: "Knowing your disposition to do right, I leave you to make your own terms; but I want you to resume charge of the business." This letter, in 1891, which was sent with an application for a position to Wheeler & Hunt, of Redlands, Calif., doubtless had some influence in Mr. Hill's favor, as he secured a very good place with them, which gave him an insight into California re-

sources and methods during the seven months which he remained on the Pacific Coast, as this firm were probably the largest owners of bees at that time in the United States, operating about 2,000 colonies; the management of several apiaries devolving upon Mr. Hill. Circumstances which necessitated leaving the employ of these gentlemen were a source of regret to himself as well as to employers, as evinced by letters from both members of the firm requesting his return.

On Dec. 28, 1889, Mr. Hill was married to Miss Kate A. Nelson, of Titusville, Pa., and on Dec. 2, 1890, a son came to cheer and brighten their home; but the joy of his presence was cut off by death seven months later, while the father was away in California; this shock, added to the already ill-health of Mrs. Hill, rendered his return to her side imperative, as her health continued to decline; and in order to remain at home until she might be restored to health, he secured a few colonies of bees and re-engaged as salesman and frame-maker in an art store, with a former employer whom he had served during a part of the four years of failure of the honey crop referred to in the foregoing, prior to his California pilgrimage. Continuing for two years in this capacity, he then, in partnership with his employer, established a job printing office, to which was added, a few months later, the necessary equipment for the publication of a 6-column folio newspaper, issuing the first number Dec. 22, 1892, which was continued weekly until January, 1894, with a good subscription list and liberal advertising patronage, when Mr. Hill sold his interest, and, on Feb. 1, started South to look up the honey-producing prospects in Florida. After spending several weeks traveling in the State, being satisfied with the outlook as a future location, he returned to Pennsylvania, interested his present partners, and organized the "South Florida Apiary Company."

October 1st found Mr. Hill again in the "Land of Flowers," and there (for the little company) he purchased 70 colonies of common stock and 50 nuclei of 5-banders, to which he added two colonies of fine 3-banded Italians at very "fancy" prices; selected a location at New Smyrna for an apiary, but had not yet taken all the bees to their new home when the unprecedented freeze of 1894 blasted every hope of a honey crop for several years. While yet undecided as to a future course, by feeding several hundred pounds of honey they were carried along with slight loss until July, when cabbage-palm bloom came to their rescue, and in August were moved south to the St. Lucie river, to await the blooming of pennyroyal in January, and there left in charge of a resident bee-keeper while Mr. H. returned to Pennsylvania, to earn expenses in the old "print shop."

Mr. Hill returned to Florida last January to take charge of the business again, but his courage to "stem" the tide of obstacles which beset the industry on the East Coast since the great freeze, took a drop to several degrees below zero when he found foul brood in two colonies. To these, however, he promptly applied the Sir John Moore method (burial at the dead of night), with highly satisfactory results, as that was several months ago, and not a sign of the malady has developed in any of the others; hence, newly awakened hope and determination, assisted somewhat by a small crop of honey already secured, with some prospects of getting more at their apiary in Indian river narrows, from mangrove.

The management of the company affairs devolves entirely upon Mr. Hill.

Being one of a large family, reared upon a dairy farm, and the poor health of his father, rendered it quite necessary that the elder children (H. E. being the second) assist in the farm work, so that the education which he coveted, ended in a common country school; that which he has since acquired being the result of diligent application to private study at every opportunity. When but 10 years of age, it fell to him to herd cattle on his father's farm, before fences could be con-

structed; this he continued to do for three summers, which afforded ample time for a thorough perusal of Thomas' textbook of bee-keeping, and other study. Twenty years have elapsed since those days, and in a practical way he is still studying bees, realizing to-day that he has yet more to learn than seemed to confront him then, yet with his rather wide range of experience—from the Georgian bay to the Carribean sea, and from the Atlantic to the Pacific, aggregating over 20,000 miles of travel wholly in the interest of bee-keeping; observing various methods in different lands, his contact with hundreds of bee-keepers, and almost every race of bees known in America, and some practical experience with varieties of which but little is generally known; with *Apis dorsata* and *Florea* in "pickle" in his private collection; having observed the busy workers on 16 Quinby frames in a glass hive which occupied a corner of his dining-room for years, and roughed it in the mountains and wilds of the South, and loaded cars with



Master Lowell G. Hill.

comb and extracted honey—he begins to regard himself as tolerably familiar with the various phases of honey-production. And if you can furnish him with the address of another man in America, of his years, who has had a more diversified bee-keeping experience, you would thereby incur his lasting obligation, as he might then condole with a co-victim of the bee-fever.

On March 4, 1893, another baby boy—Master Lowell—came to occupy the vacant chair in their bereaved home; so, to paraphrase Mr. Choat, as Mr. Hill's parents are yet both spared to him, there is no man whom he envies, and the only one he would wish to be, if he were not himself, would be the present Mrs. Hill's second husband. A FRIEND.

A New Binder for holding a year's numbers of the American Bee Journal, we propose to mail, postpaid, to every subscriber who sends us 15 cents. It is called "The Wood Binder," is patented, and is an entirely new and very simple arrangement. Full printed directions accompany each Binder. Every reader should get it, and preserve the copies of the Bee Journal as fast as they are received. They are invaluable for reference, and at the low price of the Binder you can afford to get it yearly.

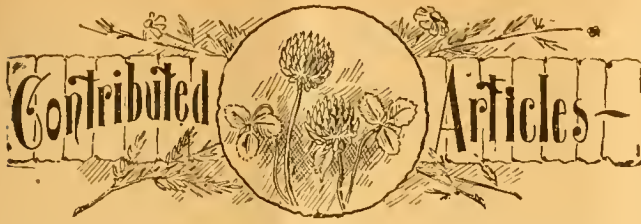

Bees to Go with Queens in Shipping.

BY G. M. DOOLITTLE.

A correspondent wishes me to tell something about the bees which should be placed in the shipping-cages with queens which are to be sent through the mails, as he is about to embark in the queen-business, and wants to know whether there is any difference as to the age of the bees, or whether an indiscriminate taking of them will answer every purpose; and ends his letter by saying, "Please tell about these things in the American Bee Journal."

As I have made the sending of queens by mail a study for many years, sending queens to all parts of the United States and Canada, as well as to many foreign countries, where they were from 12 to 50 days enroute, I will say that there is a difference in regard to the bees that go with the queen, as I have proven by the reports coming back to me.

I have used bees that were all old, with very poor results. Why these old bees were used was because in certain cases where a colony had been some time queenless, and the brood from the then laying queen had not hatched out, I was obliged to use such bees as were in the colony at the time of taking away the queen. In almost every instance where bees that were over 30 days old were used, a report of "both bees and queen were all dead, or "queen came alive, but all of her attendants were dead," was the result.

With very young bees I have had very little better success than with old ones, the reasons for using these young, white, fuzzy things being that at the time of the shipment of the queen, her bees had only just begun emerging from their cells, and being afraid to take the few very old bees which remained in the hive, I used those just hatching.

To illustrate more fully: A bee-keeper ordered three queens, and after believing I had found out where the trouble of loss in shipment occurred, I placed in one of the cages all old bees to go with the queen. This cage was marked with a private mark. My circular stated that I guaranteed the safe arrival of all queens, on the condition that when the cage arrived, the bees were to be carefully examined through the wire cloth, and if the queen was dead, the cage was to be returned to me with contents unmolested, when I would send another queen. I made it thus, partly to guard against fraud, but mainly so I could look into any failure on my part in meeting the right requirements for perfect shipment, as I could often find the clew to the failure, in the returned cage. The candy part was the main trouble in former years; but that has been pretty much overcome by the queen candy now made by mixing honey and powdered sugar together until a right consistency is reached, so that the candy will neither harden nor become so soft that it will "run" in the cage. From this digression, by way of explanation, let us return to the three cages.

One was reported as arriving dead, and was returned, while the other two came "without a dead bee." When the returned cage arrived it had the private mark on it.

Again, in early spring, I often have to use old bees, as there is no choice left me when sending queens soon after the bees have been put from the cellar, unless I take bees to go with queens from hives which were wintered on the summer stands, they having bees of right age. As it is some trouble

to get these bees from another hive, and as such bees sometimes have a desire to worry a strange queen, I have sometimes taken the bees which have wintered over from the cellared hives and sent them along; but the loss has been so great that I have resolved never to do it again.

In cases of forming a nucleus with only young bees to receive a queen (as such very young bees will nearly always accept any queen given them), and having an order for a queen at about the same time, I have taken these young bees to go with the queen, as well as in cases spoken of above, and cages so sent with young bees and marked, have gone with many dead bees, where they were not returned as altogether dead. In this way I have watched results until I have found that bees from 6 to 15 days old are the ones which stand the journey best, especially if a long one, like going to California, Washington, Northwest Canada, the West Indies, Sweden, New Zealand, Australia, etc. Having learned what bees to select, I now rarely lose more queens in going to these distant points, unless I except New Zealand and Australia, than I did when the distance was 500 miles or less.

In selecting bees I take those which have flown once or more, and which are small and slim, and not those whose bodies are distended with excrement, as all young bees that have never flown are extended to a greater or less extent, with the pollen consumed in their larval state. By a little careful watching of bees as the days go by, after they emerge from their cells, it is not difficult to tell the age of a bee, very nearly at least, by its movement and color; and in addition to this we can be guided in our selection, on account of the bees of about the right age to use in sending queens being the first to thrust their heads into the cells of unsealed honey when the frame on which they stand is being removed from the hive. Beside this helping us to know which bees to select, bees in this position are very easily picked off the combs, as the wings stand out from the body.

The item of having queens reach their destination in good order every time is quite an important one to all who ever think of sending or receiving a queen. So far this year, out of the hundreds sent, I have not had a single report of one going dead.



Cure for Robbing—Laying Workers, Etc.

BY S. A. DEACON.

I don't know who it was that suggested some time ago in the Bee Journal, painting about the flight-board and front of the hive to stop robbing; but whoever he was, he has proved himself a benefactor of his species, and deserves the thanks of the fraternity. I have just tried it with marked success. Will others please report results of the application of this cure for one of our worst ills? for—and it is unaccountably strange—what seems to succeed with one often fails with another.

GETTING RID OF LAYING WORKERS.—The circumvention of that curse—the laying worker—has hitherto been considered—judging from bee books and journals—a consummation so difficult of attainment as to lead us to believe that the game is hardly worth the candle. She—the laying worker—is said to be non-amenable to any of the arts, dodges and devices of the most skillful apiarist. We are told that laying workers determinedly refuse to accept either queens or cells, once they have seized the reins of government. Heddon—in his "Bee-Culture"—tells us that he has found an easy way of disposing of them, viz.: "Insert two combs of hatching bees. Two days after, give a frame of eggs and larvæ, and on the following day introduce a queen, or give a queen-cell." Now, I think I may say I have discovered a slightly more easy and expeditious method of restoring the monarchical system; it is this: Dredge the "republic" well with flour, scented with—well

with peppermint, or anything else; I scented mine with a few drops of Grimshaw's apifuge, because it happened to be handy, but I fancy peppermint would do as well. Then dredge the queen, drop her in, and—all's well! At least so I have found it. Will the brethren please report results on this matter, too?

MIDBAR IN LANGSTROTH FRAMES.—I was lately a party to the following discussion, and which became a very warm one, bets being freely offered on both sides. The matter at issue was as follows:

One party happened casually to suggest dividing Langstroth frames midway by a thin, narrow bar, similar in dimensions to the bottom-bar; he did not claim any very great advantage therefrom, other than safety in traveling, for which purpose, of course, wiring is usually resorted to. Anyway, his suggestion was met with the statement, and very confident assertion, that, assuming the upper half to be full of comb—right down to this dividing bar—the bees, instead of continuing their comb in the same direction downward, *i. e.*, on exactly the same vertical plane as that part already completed, will divert the same, and construct the lower half in a different or irregular direction, and *not* as a direct downward continuation of the upper half, building combs perhaps on the lower half right across the frames. This central bar is to have no guide or starters.

Now, it would be interesting to know what the opinion would be of a select few of our experienced "old hands." Of course it could be easily decided, a few days would suffice for the purpose; but that's not the thing—we would like to hear of opinions off hand; hereabout opinions are about equally divided. As to the *utility* of the suggestion, we will put that aside, though I do not see why such extra rigidity should not be given to large frames.

Don't let's have any wagering on the matter—betting's sinful, but *opinions* are "respectfully solicited."

And now, while we are on this subject of giving extra rigidity to deep frames, I might say that Mr. J. E. Earle had, in the Australian Bee-Bulletin of Sept. 24, 1895, page 150, an article in favor of small hives, and, in particular, of one he has adopted, measuring 12x12x12 inches. This should help greatly to settle the matter so long under discussion—the battle of the hives. For my part, I believe Mr. Earle is right; such deep, narrow brood-chambers would naturally concentrate the heat so essential to the rapid production of honey, sending up a constant stream of it as through a big pipe or chimney, and more nearly approaching to the arrangement in a colony's natural state where a big hollow tree is selected for its domicile.

I think there is a great deal of common sense in Mr. Earle's "cube-foot" or "pillar" hive, as I would take the liberty of naming it, and I fancy the time is not far off when it will become popular. In such deep frames the idea of a middle bar might be utilized to advantage if—but let us first hear the opinions on this matter, and also on Mr. Earle's "cube-foot" idea, of our greater lights. These "pillar" hives would be the return in a measure to the very satisfactory old Stewarton hive.

DO HENS CATCH AND EAT BEES?—Were this made a leading question in the Bee Journal, I wonder how many replies—from Dr. Miller's downward—would be couched in the all too familiar words, "I don't know."

Well, I *do* know. Some hens *do* contract this disgraceful habit; nor did I become aware of it until to-day. A good 12-month since, on the recommendation of some writer in either a bee-book or in the Bee Journal, I began to combine *poultry* with *bee-keeping*. My fowls have always had the run of the apiary, and I have frequently seen them picking up *dead* bees, but never until to-day did I notice that some of them shamefully take up their stand in front of a hive and

boldly snap the *live* bees off the flight-board. I have just been watching one; she would make a dab, retreat a yard or so with her capture, rub it in the ground and then swallow it; this she would repeat perhaps a dozen times, then take a stroll, and in time come back for another feed. Has this propensity been noticed by others of the brethren who combine poultry and bee-keeping? South Africa.



Methods of Securing and Managing Swarms.

BY HON. R. L. TAYLOR,

Superintendent of the Michigan Experiment Apiary.

The season of 1896, in point of swarming, has been a remarkable one. The bees lightly set at naught all the accepted canons of bee-keepers respecting that function. Lack of great strength had little restraining influence, and abundance of room, even in the brood-nest, none at all.

Swarming began the last of May, continuing just a month, during a very moderate flow of nectar, ending abruptly when that flow was at its best at the height of basswood bloom, though even then the secretion of nectar was very light. Not more than one or two per cent. of the colonies did anything at all in the supers before casting swarms, and many did not wait to fill the combs in the brood-nest. Under such circumstances it is safe to say that it would not be wise to cease efforts to determine the best methods of securing and managing swarms, on account of any bright prospect of speedy success in breeding out the swarming instinct, or even of any satisfactory invention that will practically allay it. Indeed, it is a very serious question whether, if this object could be secured in either of these ways, it would be satisfactory to more than a very small percentage of apiarists.

There are always more or less losses from various causes to be made good, and there is no cheaper or more satisfactory way of doing this than through the increase by swarming. The loss of even a few colonies each winter during a series of unfavorable years, where there is little or no swarming, with occasional failure of queens and lack of stores, often best met by the uniting of colonies, sometimes makes the aggregate reduction in numbers rather startling. Then the serious item of the rearing of queens comes in, which must be done artificially if increase is secured without swarming. No doubt as good queens can be secured in this way as those obtained from cells built and cared for under the swarming impulse, but how few, comparatively, are the apiarists who have the aptitude, skill and punctuality required to do it. Nineteen out of twenty, for one reason or another, would fail, and in these times of financial stringency and uncertain honey crops, they cannot afford to purchase. Besides, it can hardly yet be safely denied that bees receive an impetus to work by finding themselves in their newly-pitched tent, destitute of brood and provisions.

That there are some weighty objections to swarming, if it could be safely repressed, is not to be denied, but these may be reduced to two, namely, the time and labor required for watching and hiving swarms, and the danger of loss from swarms absconding. Some may hold that undesirable increase is another and a more serious one still, but one should be easily able to obviate that, and indeed thereby reap a decided advantage. It is only a question of the disposal of the brood in the hive from which the swarms issue, and that is generally, especially in early swarming, very valuable. To accomplish this, it is not necessary, as might be inferred from some discussions of the subject, that the brood, when hatched or before, should be returned to the identical colony that produced it; indeed, it may usually be used with decidedly greater advantage in other ways. There are always at the opening of the honey season some colonies that are not up to the strength required for the best work in the supers. Let

the hives full of rapidly-hatching brood be distributed among such deficient colonies as fast as they can be obtained, first driving out of each all the bees left behind, in the hive which with its swarm is, or is to be, put on the stand. Thus, in a few days, if swarming continues, all may be got into excellent condition.

Frequently, also, there are colonies out of condition on account of being possessed of superannuated or otherwise worthless queens. Destroy such queens as fast as hives of brood can be obtained, and place one on each now queenless colony, and in a few days it will be rejuvenated both in its strength and its queen. In some of these operations the advantages of a horizontally-divisible brood-chamber are especially apparent, for if one wishes to help two colonies with the brood of one it can be done without extra labor, or if one wishes to rear a few surplus queens to meet emergencies, without driving out the bees remaining after the swarm issues, by simply dividing the brood-chamber, he may secure two queens as easily and as cheaply as one.

Other ways of disposing of the brood thus obtained through swarming will occur to every one in practice, so that soon instead of deploring its abundance one will be likely to wish for more.

There is one principle that is valuable in this connection which I should recall before passing, and that is, that a colony having a laying queen of the current year's rearing can be pretty surely relied upon not to desire to swarm, no matter how strong it may be made within any reasonable bounds; and the same rule holds if it has a virgin queen, if there be not also occupied queen-cells in the hive. This fact may be taken advantage of to safely make some of the strongest possible colonies, and at the same time the most profitable ones, notwithstanding the notion which some cherish (but without good reason, I believe) that the possession of a virgin queen renders a colony unprofitable for comb honey.

How best to minimize the disadvantages of swarming which give rise to the other objections I have mentioned, is a somewhat more difficult matter. The absconding of prime swarms can be almost certainly prevented by having had the wings of the queens previously clipped, which is most conveniently done about the first of May preceding, but, though I have hitherto been strongly in favor of it, and would take as a choice of evils in the absence of the queen-trap, I find it liable in an apiary of any considerable extent where there is little danger of swarms clustering out of convenient reach, to one valid objection, and that is, that swarms usually remain a tantalizingly long time in the air, giving an unnecessarily pressing invitation to other swarms, and perhaps virgin queens, to join them, thus complicating the matter of successful hiving. In small apiaries this objection would not have the same validity, but in any case there is first the danger of the loss of valuable queens, and then in nine or ten days, in the absence of the apiarist, the loss of powerful swarms with virgin queens, so I now consider the queen-trap indispensable unless one is willing to watch his bees continually during the swarming season, and even then it is a great convenience.

For this purpose, the trap should be so made that the queen once in it cannot return to the hive. This enables the apiarist to determine, with the exercise of a very little attention, whether a swarm has issued during his absence from any given hive or not, by the conduct of the bees and the greater or less cluster remaining with the queen in the trap. If a swarm has issued and returned, usually the trap is found full of bees, or nearly so; in such case I return the queen and bees to the hive and readjust the trap with the expectation that in a day or two I shall discover them making their next attempt, or, if I had no such expectation, I would shake out enough bees to make a good swarm and hive them with the queen in the ordinary way.

A trap full of bees at the entrance of a hive from which the prime swarm, or at least the old queen, has been taken, indicates that the young queen has attempted to issue; if the trap has but few bees, it shows that the young queen has attempted to take her mating flight, or perhaps sometimes that she has got into the trap in endeavoring to escape from a rival. In either case, swarming is over, and the trap should be removed and the queen returned, unless it is certain the colony still has one.

It is best then, I think, to keep traps on all colonies likely to swarm, removing them as soon as the danger is over, being particularly careful on this point in the case of those having virgin queens. When a swarm is discovered issuing, remove the trap, thus allowing the queen to go with the swarm, which induces speedy and perfect clustering, when it may be secured in a moment in a basket.

A light pole to which a basket is attached near the farther end, serves both to shake out and secure most swarms that cluster out of reach of the hand.

For the highest success in the production of comb honey, strong swarms are desirable, and hiving swarms on the old stand not only conduces to their strength, but has also a strong tendency, often almost prohibitive, to prevent after-swarms. However, with the methods I use there is a limit to the profitable strength of swarms. If they exceed seven or eight pounds in weight, there is apt to be discontent and an early preparation to swarm again, even if they do not persist in attempting to abscond. This determination to abscond is a difficulty which I have had to encounter very frequently during swarming seasons, owing principally, no doubt, to the small size of the brood-chamber which I feel compelled to give swarms. After testing different plans, I have at last been almost entirely successful in meeting this difficulty by giving the swarm at first a double brood-chamber and removing the lower section in two days. This plan has proved a decided relief in the management of swarms.

Little need be said in addition to meet the objection made against swarming on account of the time required for attending to it. Most prime swarms issue between 9 o'clock a.m. and 12 o'clock m., so that, with the traps, three hours a day answers very well. In case of necessity, even less time may be made to serve without serious loss, even to so little as three hours every third day.

It is possible that there may be a little danger of swarms going away with virgin queens on their mating flight, but it is not great, for such queens are distasteful to prime swarms, though any laying queen is acceptable.

If a prime swarm and an afterswarm with their queen unite, the young queen will usually be found balled, and it is seldom worth while to separate them because there will almost certainly be sufficient of the prime swarm with the young queen to destroy her or break up the colony.

Some complaint is made that queens escape through the perforated zinc of the queen-trap. The perforation in my traps are $5/32$ of an inch, and no queens escape.—Review.

Lapeer, Mich., July 7.



Non-Swarming in Large Hives.

BY DR. C. C. MILLER.

I have been very much interested in what has been said about the lack of swarming in large hives as used by the Danants, and while it may partly explain why bees should swarm more with 16 Langstroth frames in two stories there are still some mysteries in the case. The reason given for the swarming with me is that the queen is loth to go from one story to the other, and with the large Quinby frame there is no such difficulty in the way. That looks reasonable, and yet under

the circumstances I can hardly feel that it fully explains all. Let me explain a little more as to my two-story hives: When the one story was well filled I added a second story, putting half the brood in the upper story directly over the other half in the lower story. The queen seemed to go readily from one story to the other, as was shown by the fact that always young brood, and perhaps eggs, could be found in either story. But supposing the going from one story to another did make any trouble, there were the empty frames in each story right beside the brood—why didn't the queen occupy them instead of swarming?

It is only fair to add that for years I have each year kept a few colonies in hives three to five stories high, and in these piles of hives I have never known a colony to swarm. Some of them have been immense colonies, keeping 14 frames filled with brood, but with no offer to swarm. I don't understand why these should refrain from swarming, even though sometimes fairly crowded, and yet the colonies in two stories swarm with plenty of empty comb. But then there are lots of things I don't understand about bees. Marengo, Ill.



Fifteen Years' Experience in Bee-Keeping.

BY MRS. SALLIE E. SHERMAN.

(Continued from page 484.)

The study of bee-culture opens wide the book of Nature, bids us look in, quaff, and want more. Ah! what a precious study it has been to me. It has opened avenues of thought never before dreamed of. Life is more to me than it ever could have been without the little, busy bees. But, alas! all things earthly have an end. So I and the precious, little, God-given, nectar-gathering honey-bees have separated. They are gone—all gone. Alas! it is true, I own not a single bee. They have gone to a new home, and I, too, will very soon have to leave this dear, sweet, little home. A few weeks more, and I, too, will leave for Dallas, my future home.

In the fall of 1895, the Gordon sisters, two estimable maiden ladies (one of them born on my birthday, seven years later), being tired of the dress-making business, and still wanting something out of which to earn a living for themselves and be able to care for their aged mother in her declining years, hearing that my bees and fine poultry were for sale, came to see me, and purchased my whole outfit. So that is the way the Texas Bee and Poultry Yards came to be located 1½ miles north of Belton. I wish to say now and here that they are thoroughly reliable and trustworthy, and orders sent to them for anything in their line will receive careful and prompt attention. They guarantee safe arrival and full satisfaction in every instance.

Oh! but didn't they have a good time getting every thing moved. There were 56 colonies of bees, quite a number of them in hives three stories high; lots of empty hives, extractors, etc., too numerous to think of itemizing; 80 chickens, most of them full bloods. It took seven two-horse wagon-loads—not a single frame of which was broken. Mr. Jones, the brother-in-law of the Gordon sisters, did all the packing and moving except one wagon-load. All he had to do to get people to give him the road was to call out, "Bees, live bees!" then he could keep right in the center of the road without either turning to the right or left.

One day, on his trip home, one of the hive-covers slipped a little, and quite a lot of bees got out before he noticed them, and not having the smoker with him, as he should have had, he could not get them back; so, after closing the hive so that no more of them could escape, he proceeded on his journey with, he said, "a small swarm hovering over the wagon." Just then he met a buggy full of negro, "which," he said, "was all, only one"—a fat woman weighing about 300

pounds. He yelled, "Live bees!" She threw up her hands, frightened half out of her wits, saying, "Oh, Lordy, massa, what'll I do? Oh, Lordy, massa, don't let 'em kill me! Git up, here, you old hoss! Git up, here!" Away she went, I suppose rejoicing that her life had been thus miraculously saved by the speed of her "hoss." Mr. Jones reported not having been at all crowded on the streets of Belton, as he passed through.

A few summers back, little "Gordon," Mr. Jones' youngest son, went out with broom in hand to shoo the bees in, as it was raining, and he thought they oughtn't get wet. After shooing them a few times, and they wouldn't go in, he proceeded to push them with the broom. Several stung him; but nothing daunted, he went into the house to tell mamma they wouldn't mind him and go in out of the rain. He wanted her to help him get them in, but warned her that they had "pins that would stick" her!

In my early experience using a smoker, I often found just at the time I needed it most it would be out. By some means I one day set it down so the nozzle was up. When I wanted to use it I found it was all right. The smoker problem was then solved—no more relighting, etc.

I decidedly prefer a hot-blast smoker. If I, or any one, was stung by the bees, we just scraped the sting out and puffed the warm smoke on for a few puffs, and that was the last of the pain, and no swelling followed, provided the sting did not stay in too long.

I once had a colony of hybrids the most vicious I ever owned. They were near where I had to pass frequently, so it was very annoying, as they would come out in full force on the warpath without any provocation whatever, every time I passed. I soon became tired of that, so I just kept the smoker lighted, and at times all through the day, for several days. I would give them a good smoking. In less than a week I could pass as often as I pleased without smoking them or being molested.

I once had several frames standing by a hive that I was looking through. Suddenly the wind blew up briskly and blew my dress, which had a ruffle on the bottom of it, against those frames, which infuriated the bees to such an extent as I had never before seen, and hope never again to see. I tried to, and did finally succeed, after being severely stung, in getting the hive closed. Not so in quieting the bees. I smoked them vigorously, which seemed only to madden instead of quieting them. I had a pen in which were two large, fat hogs, about 30 steps from these infuriated little monsters. To them they went and began such a war as I have never read of, and hope never again to witness. The strange part of it was, it seemed that their anger was contagious, and that every colony in the yard was on the warpath, all making for the hogs. As the moments passed, matters grew from bad to worse. Well, what I did is much easier asked than answered, for I did a little of everything I could think of in the way of using an abundance of smoke and water, but it did no good at all. If it hadn't been that two negro women came to my relief, and helped me raise the pen so the hogs could get out, I don't know when or where the catastrophe would have ended. I am satisfied that each of the hogs had received more than a hundred stings. It looked as if there were a half-dozen good-sized swarms in and around that hog-pen. My! my! what a terrible time it was. I failed utterly to see any poetry in that whole performance, or even in bee-keeping that particular afternoon.

As for ruffles on my dress, well, after that exhibition I failed to see their utility, so discarded them altogether for bee-dresses.

Hold on, the scene is not yet closed. There is another act in the drama. After the pen was raised, and the hogs liberated, where do you think they went? Well, you'd hardly

gness, so I'll tell you. They made just as straight for the bee-yard as their feet could carry them. My! my! but didn't we have a time. After finally getting them away from the bee-yard or apiary, with my father's assistance, we two managed to keep them away until the two colored women moved the pen about 100 yards from its former location, then we finally managed to get them in, as it was then about feeding time, so we persuaded them to go into the pen with corn. Night soon coming on, the bees quieted down, and by the next morning were all right. The hogs, however, showed where they had been stung for quite awhile, although there didn't appear to be any unfavorable results occurring after the excitement was all over.

At another time in my early experience, wanting some eggs from which to rear fine queens, I went to a colony of very fine Italians for this purpose, hoping to find some in the top or upper story. Not finding them, I replaced all the frames, then removed the top story entire, and proceeded to go through the brood-nest frame by frame, looking closely all the while for the fresh-laid eggs. The last frame rewarded my search, for on it was not only the eggs, but the queen as well, thus showing that they were the ones most to be desired. After removing this frame and replacing most of the others, by some awkwardness of mine I dropped a frame with adhering bees. This angered them terribly, so at me they came to have their revenge. You may be sure they had it, too. This occurred about 2 o'clock p.m. Off and on until 10 that night, I tried to replace those few frames and close the hive, but all to no purpose. Every time they could get sight of me, here they came, still bent on revenge. So I will acknowledge I was defeated.

I was up by daylight the next morning. The first thing on the program was to replace those frames and close that hive. But if you will believe it, it looked as if the whole colony was ready for battle. At me they came. I went to my son's room, woke him, and told him if he would get up immediately and close that hive of bees for me I would give him a silver dollar. Out of bed he bounced, dressed, putting his pants' legs inside his boots, put on a rather heavy coat, bee-hat, veil, gloves, etc. I tied his gauntlets tightly around his coat-sleeves. In a word, he was bee-sting proof. With smoker in hand he went and closed it all up nicely in less than five minutes. Of course he got his dollar. He still enjoys telling this on me, and laughs about how easily he made that dollar.

One other bee-episode and I will then be through along this line: About two years ago, my brother, who was a colporteur for the American Bible and Tract Society, came to see me. He owned and was driving a very large Norman and Clydesdale horse. After spending a day and night with me, he had occasion to go back the way he had come for a few miles, and wanting to make a good drive that afternoon, I prevailed on him just to take my horse and phaeton rather than his back, and let his horse rest. To this proposition he readily agreed.

The horse was in an adjoining lot to where I had my bees. There were two gates open so he could go through another lot into a pasture. I never knew just where he was, or just how it happened (I mean just in exactly what part of the lot), but a bee stung him. Of all the rearing, snorting and pitching, I certainly never saw anything to compare with it. He seemed perfectly frantic. He was like a maniac. The terrible part of it was he seemed determined to break down the fence and come into the yard amongst the bees. There was no one to help me. The only thing I could get hold of was a calf rope with which to keep him from breaking down the fence—I on one side and he on the other! Here we had it up and down that fence, the great monster, as he was, throwing himself, so to speak, up in the air, he looked to my frightened eyes as

big as a camel. He would just rear upon his hind feet, and then kick up his heels, looking for all the world as if he was going to turn a summersault backwards.

My! my! what a time we did have, both the horse and I. I don't believe I was ever scared so badly in my life. I am quite sure I never wanted to see a man come as badly as just then, but come they would not. The only human being I could see was a frail little woman who kept hollowing for me to open the gate so as to let him into another pasture. This I finally succeeded in doing, but failed to get the infuriated animal to see it. He finally, however, did see both the other gates open, and through them he went. Instead of going further, he ran around this time, being nearer the bees than at first, but I finally succeeded in getting him away.

I was indeed glad when brother came. I told him of the terrible episode through which I had just passed, his horse being the chief actor in the scene. I told him that we had had a regular circus with only one spectator, and she at a distance. He just laughed heartily, which vexed me, for I knew he didn't realize the great danger I was in. I am now satisfied that not more than three bees had stung the horse—at least that was all we could find any sign of.

Bell County, Tex.

[To be continued.]

Causes of Low Price of Honey.—Skylark, in Gleanings for July 1, has the following to say about the causes of the present low price of honey:

There are five causes apparent to me for the low price of honey:

1. The stoppage of the wheels of industry, and the consequent inability of the poor man to buy any luxury.
2. The glittering of the large city markets, which rule the prices.
3. The perfect helplessness of large producers who are entirely at the mercy of the commission men.
4. The entire lack of union or combination among bee-keepers.
5. Adulteration, that has disgusted people with honey, or, rather, with the foul imitation.

Four of these causes of low prices can all be removed by union among bee-keepers—a national union and exchange. Let it be broad in its scope of defense and protection to bee-keepers. Let defense and protection mean from anything that will injure a bee-keeper's interests in his calling. Make it representative, with annual or semi-annual meetings, the commercial or exchange part of it to be run by a board of directors and a manager. Organize unions or exchanges in each State, on the same plan, to be subordinate to the National, and send representatives thereto. Each State exchange should prosecute adulterators and protect bee-keepers within its own borders, the National Union standing ready to help any State exchange in case of any extraordinary outlay, such as carrying a case up to the Supreme Court of the United States. Each State should distribute its own honey throughout its own borders, and send its surplus wherever the National might direct. This plan would preserve the social character of the meetings, protect bee-keepers from all wrong, kill adulteration, distribute the honey properly over the country, and give large producers as good a chance to sell as small ones.

The Student's Standard.—The "Student's Standard Dictionary," now in preparation by Funk & Wagnalls Company, will contain upward of 50,000 words, and from 800 to 900 pages.

The volume, which will be issued under the supervision of Prof. F. A. March, has been edited by the Rev. James C. Fernald, editor of the department of Synonyms, Autonyms, and Prepositions of the Funk & Wagnalls Standard Dictionary, assisted by a staff of skilled workers formerly engaged on the same undertaking.

The chief feature, one not attempted in any school dictionary, is the incorporation in the "Students' Standard" of the meanings of every word used in the sixty volumes of English Classics, selected by the Commission of Colleges for study preparatory to admission to the chief colleges of the United States.

The type is clean cut and clear, the paper will be of superior quality, and the binding attractive and durable.

OLDEST BEE PAPER IN AMERICA ESTABLISHED IN 1861

THE AMERICAN BEE JOURNAL

GEORGE W. YORK, Editor.

PUBLISHED WEEKLY BY

GEORGE W. YORK & COMPANY,
118 Michigan St., CHICAGO, ILL.

\$1.00 a Year—Sample Copy Sent Free.

[Entered at the Post-Office at Chicago as Second-Class Mail-Matter.]

Vol. XXXVI. CHICAGO, ILL., AUG. 6, 1896. No. 32.



Bee-Association Secretaries are invited to send us notices for their meetings for announcement in these columns. Also, immediately after the conventions are held, forward condensed reports for publication. We shall be glad to co-operate in making your meetings successful.

Who'll Be At Lincoln Oct. 7 and 8? We would like to publish the names of all who expect to go, and the States they hail from. We just wonder what State, outside of Nebraska, will have the greatest number of representatives there. Let us know whether you intend being present, if all is well, and we will begin to make up a list for publication.

Bee-Keeping in Arizona.—The Bee-Keepers' Association of Maricopa county, says the Phoenix Republican, has thus far shipped five carloads (24,000 pounds each) of extracted honey eastward, while in the hands of the Association members there is remaining fully as much more ready for shipment. The price has been thus far but 3½ cents per pound—lower than ever before known, owing to the fact of a fair crop in the East. The California crop, however, is light, and prices for the next shipment are expected to show a material advance. The quality is all that can be desired.

The season has been a peculiar one in many respects. Up to some two months ago the bees had stored scarcely a pound of honey, and bee-men were anticipating a flat failure; but much warmer weather came on, and the bees commenced to work as they have never worked before, and every bee-keeper for the last six weeks has been kept busy. Not only have the bees been filling the combs with honey from the second crop of alfalfa bloom, but they have been swarming to an extent that has almost baffled the attempts of the bee-men to provide the new swarms with quarters. "Considering the number of swarms in the valley," observed Mr. Broomell, of the Association, "I believe a record of 10 carloads of honey in a month is one that has never before been approached."

Despite the extremely and abnormally warm weather there has been no trouble from melting comb, and the bees are free from disease.

It is anticipated that by fall time, another 10 carloads will have been produced, giving the valley its top record for production.

The Sale of Honey in Belgium.—The Farmers' Advocate—a Canadian periodical—says that other countries besides Canada realize the need of a law similar to Canada's "Pure Honey Bill," which was passed recently. A Belgian decree, which was to take effect from July 1, 1896, defines what is to be considered as honey, and regulates the sale of this commodity in the following manner:

"Under this law the name 'honey' is to be applied solely to the substance produced by bees from the nectar of flowers or other juices gathered from plants. Honey produced by bees fed with other substances (excepting such as are supplied to them as provision for winter) must bear a name indicating the material given to the bees, as, for instance, 'honey from sugar,' 'honey from glucose,' or 'mixed honey.'

"Honey substitutes and mixtures of honey with such substitutes, or with other foreign substances, must be denoted 'artificial honey,' or honey mixed with such and such substances, or some term not involving the word honey must be used.

"The sale of honey containing more than one per cent. of pollen, wax or other substances insoluble in water, or more than 0.5 per cent. of mineral matter, and all spoilt honey, is prohibited. Vessels containing honey, or mixture of honey, etc., must be labeled in such manner as to specify the exact nature of the contents, as defined by the decree."

Good for old Belgium. After awhile may be the United States will awake from her long sleep, and give her people an anti-adulteration law that will protect not only the producers of genuine bees' honey, but also the honest products of other industries. We must keep up the agitation until we get all needful and just laws.

North American at Lincoln.—We have received the following letter from Mr. L. D. Stilson, of York, Nebr., referring to an editorial in a previous number:

FRIEND YORK:—On page 473, I see you are not worrying about the larders of the Nebraska people. That is right; we have enough and to spare. We want to see you Eastern bee-keepers come here and "GET FULL" once, and so we propose to "set up" free, something for the North American, or the visiting members outside our State. But let me say to you, right here, that before any can have a free lunch in Lincoln, they must settle their little yearly dues with the Secretary.

You see, I am a little interested in getting membership into the society, and a good deal interested in the protection of the larders of Lincoln.

Respectfully,
L. D. STILSON.

Yours is a good idea, Mr. Stilson, to allow only those who pay their annual membership dues (\$1.00), to participate in the fun of emptying those famous "Lincoln larders." Our dollar is ready, and, all being well, we'll try to do justice when we come to the "larder act."

But the idea of such a staid old temperance man as yourself, wanting to see Eastern bee-keepers "get full" when they come to Nebraska! Of course, if those "larders" are free from anything like "Whitcomb's celebrated metheglin"—that we imagine is more productive of "tipsiness" than old "forty-rod" is said to be—if you mean you want us to "get full" of just good eatables, and not questionable drinkables, why, it's all right. "Barkis is willin'."

New Bee-Papers.—One of the most ridiculous ideas recently published, is that put out by a fellow who accuses us of a jealous feeling because the Southland Queen was started about a year ago. Why, bless you, this is a free country, and if people want to sink any money in publishing, or subscribing for, new bee-papers, that's *their* business, not *ours*. But we feel that it is our affair to protect our subscribers, and save them from throwing away their money on something that is issued principally to boom a private business, or to gratify a desire to have a medium in which to show off the publishers' egotism and desire for notoriety.

Those who start new bee-papers seem not to know that during the past 20 years there have been perhaps 50 new

apiarian papers launched in this country, less than a half-dozen having survived, and scarcely one of them proving at all a financial success, aside from a means of furthering a bee-supply business. One reason for this is the fact that the field of bee-culture is limited, and there is neither the need nor the demand for a host of publications.

Again, we wish to say that if our permission is desired for the starting of a hundred new bee-papers, it will be freely given; but their publishers must not expect us to turn around and give them a lot of free advertising so that they can hope to live. We are here to make the American Bee Journal what it should be, and not for the purpose of aiding superfluous enterprises that some people make, and who have failed to "count the cost" before venturing.

By the way, the Southland Queen probably would not have been started had it not been for our dropping the Atchley folks from our columns. And as it was begun *immediately afterward*, it showed very plainly that they had been using the Bee Journal simply as a stepping-stone, for previous to their prominent appearance in our columns they were but little known, though having a bee-keeping experience. We have never objected to the starting of the Southland Queen, for that is none of our affair; but we dropped its publishers as Bee Journal correspondents and advertisers, for good and sufficient reasons, that are well known to those most interested.

Stray Staws, in Gleanings, are still trying to "show which way the wind blows." These appeared recently:

A good scratcher to scratch the surface of sealed honey so as to get the bees to empty it out is made of a piece of heavy wire cloth, three meshes to the inch. Possibly five to the inch would be better. Take a piece three or four inches square, and you'll find the edge where it is cut off just the thing to rake the surface.

Cases are reported in which swarms have issued with no sign of a queen-cell in the hive. I'm inclined to be mildly skeptical about this; at least, I have some doubt about such a case occurring unless the bee-keeper had baffled the intentions of the bees by previously removing queen-cells. The more bees are thwarted as to swarming, the more determined they sometimes are; and I can imagine their getting mad enough to swarm with no sign of a queen-cell. I've had many a case in which there was nothing further than an egg in a queen-cell.

A Very Neat Program is that issued by the Southwest Texas Bee-Keepers' Association, for their meeting at Beeville, on Sept. 16 and 17, 1896. Any one near enough to attend should send for a copy, to the Secretary, J. O. Grimsley, Beeville, Tex.

PERSONAL MENTION.

MR. CHAS. DADANT, of the firm of Chas. Dadant & Son, the well known comb foundation makers, made us a very pleasant call on Tuesday, July 28. He was on his way to Sturgeon Bay, Wis., where he goes annually for a month or so, in order to avoid an attack of hay-fever were he to remain at his home in Hancock county, Illinois.

Mr. Dadant says they have 325 colonies of bees now, and that they had extracted about 5,000 pounds of honey so far, with more to follow. One year they had 45,000 pounds from about the same number of colonies as they now have.

In speaking of beeswax, Mr. D. mentioned a very simple

test to detect adulteration. 'Have a vial partly filled with water, into which is put a small piece of beeswax of known purity. Then pour in alcohol until the piece of beeswax sinks to the bottom of the vial. Now put in a piece of the beeswax you wish to test—if it floats it is adulterated; if it goes to the bottom it is all right.

When Mr. Dadant first came to this country, from France—over 30 years ago—he found on the bank of the Mississippi river a single, small plant of sweet clover. It was quite a distance from his home, but when it was time for the seed to be ripe, he went after it, and scattered it so that it might spread. Later he also gave some seed to a friend near Keokuk, across the river. By following up the practice he soon had a great deal of sweet clover growing, and in fact now it is pretty well spread over a good share of the States bordering on the Mississippi, and Mr. Dadant believes that much of it is the result of the one plant which he watched so carefully, and in due time scattered its seed. He values sweet clover very highly as a honey-plant.

Upon reaching the United States, Mr. Dadant and family were almost penniless. So both he and his good wife (who departed this life about a year ago) had to work hard in order to get along. They picked and sold blackberries about the first season, and from the money thus made, Mr. D. paid \$5.00 for an Italian queen—and she was not even a warranted one. Mrs. Dadant disapproved paying \$5.00 thus, but said very little. But the next year Mr. D. sold some queens reared from her for \$10.00 each! He began with two colonies, and increased from year to year until the bees became his main source of revenue.

For a man 79 years of age, Mr. Dadant is remarkably well-preserved. In fact, we do not remember ever seeing him looking better than now. We wish him yet many happy years, in which we are sure the thousands who have read his practical and helpful articles in the Bee Journal will most heartily unite.

While this is rather a lengthy "personal mention," we think no one will object to it, or even feel slighted if they do not receive one of equal length when "their turn" comes.

MR. L. D. STILSON, of York, Nebr., in a letter dated July 27, says: "We have just had a two-days' session of the State Horticultural Society here at York. It was decidedly the best attended meeting ever held by the Society." That's good. We hope the same can be said of the North American convention at Lincoln, Oct. 7 and 8. Mr. Stilson will do his part to make it so, depend upon that.

MR. G. M. DOOLITTLE had two practical articles in the July American Bee-Keeper. What a prolific writer that man Doolittle is, anyway! Wonder when he finds time to work with the bees. It is surprising how much work one can "turn off" when accustomed to it. Shouldn't be surprised if Mr. D. has everything systematized, and, besides, writes a good deal at night.

MR. HASTY—the Review's "Reviewer"—says that he thinks "the foundation-cutting arrangement given on page 337 [of this paper] is one of the best that has been brought out." By the way, Mr. Hasty keeps up a very entertaining department in the Review.

HON. R. L. TAYLOR's interesting article on the subject of swarming, as reported in the July Review, will be found on page 500 of this number of the Bee Journal. Read it.

MR. GEO. E. HILTON, of Michigan, when writing on July 23, said: "My trade in hives, sections, foundation and shipping-cases is double any previous year at this date."

Questions AND Answers

CONDUCTED BY

DR. C. C. MILLER, MARENGO, ILL.

[Questions may be mailed to the Bee Journal, or to Dr. Miller direct.]

Cage for Hatching Queens.

Has there ever been anything in the way of a queen-cage to hatch queens from the cells about four days before the time for them to hatch, and keep them there until ready to be removed? If not, I have constructed one which is a success. If it is of any benefit to bee-keepers, they are welcome to it. Those that want to Italianize will find it very useful, and also to queen-breeders.

J. B. N.

ANSWER.—Yes, such things have been in use for some years. Some use compartments for the cells in the hive, each cell being enclosed separately at any time after being sealed. The queen-nursery is also used, the sealed cells being hatched by artificial heat.

Frame Crossbar Instead of Wiring.

If a frame 12 $\frac{1}{2}$ inches square inside has a triangular crossbar put through the center of it horizontally, would it be a hindrance or impediment to the queen in laying? The edge only would come to the outside of the comb, the balance being covered with comb. If this bar would not hinder the queen, wouldn't it be an improvement on that size of frame by stiffening it and holding the comb so there would be no necessity for wiring?

L. J. C.

ANSWER.—I doubt if it would make any difference to the queen. I think, however, I'd rather have the wire. A given number of bees could cover just that much less brood with the stick in the center, while the wire doesn't make any difference.

Lysol as a Cure for Foul Brood.

I saw in the Bee Journal something about lysol as a cure for foul brood. How can I find out about the treatment? and where will I find it?

J. B.

ANSWER.—Lysol is one of the many things that have been reported as successful in curing foul brood, but in this country drugs are not in favor as foul brood cures. Indeed, I think the Roots and others who have had much experience with foul brood, insist that no drug will effect a cure, any drug strong enough to kill the bacilli being strong enough to kill the bee. Lysol is a coal-tar product, and your druggist ought to be able to get it for you. I think it is used mixed with the food given to the bees, but I don't know the proportions. Some time ago it was mentioned as a cure in the German bee-journals, but lately I've seen nothing about it.

Saving Bees from Brimstoning.

My uncle is going to kill some of his colonies of bees for their honey. Is there any way I can work my two colonies to get extra stores to put some of his on? No. 1 is a strong colony, but is not in a dovetailed hive, but I can put a dovetailed hive on top. No. 2 is in a dovetailed hive, but will store only enough honey for their own use, if that. How would you do under the same conditions? No. 2 is the colony that I asked about on page 295. They were queenless.

Belleville, Mich.

C. C.

ANSWER.—Yes, if honey is yielding so that bees are laying up a surplus, there need be no difficulty in getting frames filled ready to put in the bees from your uncle's hives. People that kill bees in the fall to get the honey generally put it off too long. Unless in a place where the fall yield is good, more honey will be got by killing the bees now than by waiting till

all the honey-plants are frozen up. Of course you would have a better chance to get the bees in good shape for winter—if any one objects to the word "shape," please see definition 7 in Standard Dictionary—if you can have them early. If you can get the bees to fill up some of the frames in the dovetailed hive, then you can keep them in readiness for the doomed bees. If honey doesn't yield, you can still get the frames filled by feeding. Put the dovetailed hive over your colony, use the crock-and-plate method, and you can have the frames nicely filled. Of course, if you want the best kind of combs you'll use worker foundation in the frames. If you should get the bees early enough you might get them to fill their own frames by feeding, but it may be the safest thing to have them ready in advance. By feeding you can also get the weaker colony to help in the work.

Moths—Clipped Queen—Mustard Honey.

1. I raise my hive from the bottom and block it up when the bees are slow in going up into the supers. Now, would not the moth have a better chance at this raised hive?

2. Suppose a colony is swarming, and the queen's wing is clipped, and you don't watch it closely, wouldn't the queen be liable to be lost?

3. Do the bees gather any honey from wild mustard, or such as grows in the grain-fields? What flavor is it? We also get some honey from golden-rod when favorable.

Canton, S. Dak.

L. A. S.

ANSWERS.—1. On the contrary, with a strong colony the moth wouldn't have so good a chance to get in her work. When the hive is down on the bottom-board, the moth has a good chance to lay eggs in the cracks left under the hive, and they also make a good hiding-place for the worms. If a colony is weak enough, raising the hive might leave the lower edges of the combs unprotected by bees, but such weak hives do not generally have supers given them.

2. Generally the queen will go back into the hive, but part of them will be lost. But in a case where the swarm would come out unobserved, and the queen be lost, if the queen were not clipped both queen and swarm would be lost.

3. Yes, the bees get both honey and pollen from it. It's much the same as rape, which is a great honey-plant in Europe, bee-keepers often taking their bees to the rape-fields. I don't know the quality of the honey, but think it is dark and not of the best quality.

Position of Supers—Making a Swarm Stay.

1. When you put on the supers with enclosed sections, do you set it directly on top of the brood-frames, or do you raise it a little?

2. When you have a swarm do you pull off the surplus boxes, and get a frame of brood each and every time? I may be asking foolish questions, but I have been told that when I have a swarm, that in order to be sure that they won't leave, to take a frame of brood and then they won't leave. I had a swarm issue this spring, and I hived them twice the day they came out, and once the second day, and then the third day they came out and went to the woods. Do you know what made them leave? I had them hived in a new chaff hive with starters in the brood-frames.

W. J. E.

ANSWERS.—1. A space of one-fourth inch is left between the top-bars and the sections. You can set the sections directly on the top-bars, but in that case the bees will glue the two together, and you will have trouble in getting off the sections as well as having them daubed with glue.

2. I so seldom have a natural swarm that my own practice counts for little. A. I. Root says a frame of brood is a sure preventive of desertion, and if I am correct G. M. Doolittle says a frame of brood is pretty sure to make the swarm leave. I don't know just how it is, but I suspect there is truth mixed up on both sides, and that under some circumstances brood will have a tendency to make bees leave. In the great majority of cases heat is probably to blame for the desertion of swarms. If you have a swarm in a hive standing in a shady place, no surplus boxes on for two or three days, with the hive well ventilated, you will stand a good chance of having the swarm stay. Don't be satisfied with ordinary ventilation. Besides seeing that the hive is open below, let it be partly uncovered on top.

General Items.

Did Well This Year.

Bees have done well here this year; I will send my report later. I could not get along without the Bee Journal.

W. A. SAUL.

Denison, Iowa, July 24.

Report for the Season So Far.

My bees have increased from 40 colonies, spring count, to 100 now. I have taken 5,000 pounds of honey. I like the Bee Journal very much.

MARK G. WILLIAMS.

Corbetton, Ont., July 27.

Bees Did Well.

Bees have done well, and the honey crop for 1896 is about over. I had 12 colonies, spring count, and increased four. I have extracted from 13 colonies an average of 65 pounds, almost all basswood, which blossomed about 12 days. I lost one colony last winter. The Bee Journal is a great help to me. There are about 250 colonies of bees in this part of the country.

AUG. F. KRUEGER.

Salter, Wis., July 27.

Has a Fine Location for Bees.

It will soon be three years since I first began to take the American Bee Journal, and I have every number but one. I am glad to say that the American Bee Journal is my favorite, and the only paper that always gets here on time. I have only five colonies of bees, but I will soon increase my stock. This is one of the finest locations for bee-keeping in Oregon, and I am satisfied I can make it pay here, with the great help I get out of the Bee Journal.

P. RUDDIMAN.

Mist, Oreg., July 24.

Poisonous Honey—Wild Parsnip.

Referring to my article on poisonous honey (page 245), in regard to the plant, called wild parsnip, which grows in this section in great profusion, it has, on investigation, proven not to be the poisonous species, but is said to have originated from the common or table parsnip, it having a yellow blossom, while the poisonous one has a white blossom. I have mailed a specimen to the United States Department of Agriculture, Division of Botany, Washington, D. C., and requested a report.

Reinersville, Ohio. J. A. GOLDEN.

Expect a Fair Crop.

Our season is very late this year, and although our bees could not work at all on the fruit-bloom, on account of the wet weather, I think we will get a fair crop, as I never saw so much white clover as I have seen this year. Up to June 11 it was wet and cold, but after that fair weather came, and all green fields began to whiten until some of the pastures were actually white, and on the glorious Fourth the bees had filled up everything below, and were sending out swarms about as fast as I could

THE "NOVELTY" POCKET-KNIFE!

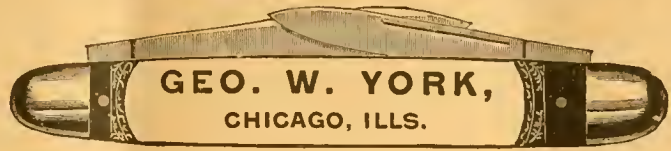

Your Name on the Knife.—When ordering, be sure to say just what Name and Address you wish put on the Knife.

The NOVELTY KNIFE is indeed a novelty. The novelty lies in the handle. It is made beautifully of indestructible celluloid, which is as transparent as glass. Underneath the celluloid, on one side of the handle is placed an AMERICAN BEE JOURNAL reminder, and on the other side, name and residence of the Subscriber.

The material entering into this celebrated knife is of the very best quality; the blades are handforged out of the very finest English razor-steel, and we warrant every blade. The bolsters are made of German silver, and will never rust or corrode. The rivets are hardened German silver wire; the linings are plate brass; the back springs of Sheffield spring steel, and the finish of handle as described above. It will last a lifetime, with proper usage.

Why purchase the Novelty Knife? In case a good knife is lost, the chances are, the owner will never recover it; but if the Novelty is lost, having name and address of owner, the finder will return it; otherwise to try to destroy the name and address, would destroy the knife. If traveling, and you meet with a serious accident, and are so fortunate as to have one of the Novelties, your pocket KNIFE will serve as an identifier; and in case of death, your relatives will at once be apprised of the accident.

How appropriate this knife is for a Christmas, New Year or birthday present! What more lasting memento could a mother give to a son, a wife to a husband, a sister to a brother, a lady to a gentleman, or vice versa, a son to a mother, a husband to a wife, a brother to a sister or a gentleman to a lady—the knife having the name of the recipient on one side?

The accompanying cut gives a faint idea, but cannot fully convey an exact representation of this beautiful knife, as the "Novelty" must be seen to be appreciated.

How to Get this Valuable Knife.—We send it postpaid, for \$1.00, or give it as a Premium to the one sending us three new Subscribers to the BEE JOURNAL (with \$3.00), and we will also send to each new name a copy of the Premium Edition of the book "Bees and Honey." We club the Novelty Knife with the BEE JOURNAL for one year, both for \$1.90.

Any Name and Address Put on the Knife.

GEORGE W. YORK & CO.,

CHICAGO, ILLS.

Allow about two weeks for your order to be filled.

PATENT WIRED COMB FOUNDATION

Has No Sag in Brood-Frames

Thin Flat-Bottom Foundation

Has No Fishbone in the Surplus Honey.

Being the cleanest is usually worked the quickest of any Foundation made

J. VAN DEUSEN & SONS,
Sole Manufacturers,
Sprout Brook Montgomery Co., N. Y.

Mention the American Bee Journal



ONE MAN WITH THE UNION COMBINATION SAW

Can do the work of four men using hand tools, in Ripping, Cutting-off, Mitring, Rabbeting, Grooving, Gaining, Dadoing, Edging-up, Jointing Stuff, etc. Full Line of Foot and Hand Power Machinery Sold on Trial. Catalogue Free.

SENECA FALLS MFG. CO.,
SENECA FALLS, N. Y.

46 Water St.,

1A1y Mention the American Bee Journal.

Dadant's Foundation in Chicago!

No other Goods kept here.

Send for Price-List,

CHAS. DADANT & SON,
118 Michigan St., CHICAGO, ILL.
13A1f Please mention the Bee Journal.

Untested Italian Queens, 75c.

3 FOR \$2.00.

Catalogue of Apian Supplies Free.

I. J. STRINGHAM,

105 Park Place. NEW YORK, N. Y.

APIARY—Glen Cove, L. I.

That Queen-Clipping Device Free!

Works Like a Charm.

The Monette Queen-Clipping Device WORKS LIKE A CHARM. With it I have clipped 30 queens, all in one day, when examining my bees. WM. STOLLEY, Graud Island, Nebr.

Couldn't Do Without It.

I have clipped 19 queens, and must say the Monette Queen-Clipping Device is by far the best invention ever made, and will be welcome to many bee-keepers as it was to me. I could not do without one now.

DR. GEO. LACKE, Newburgh, Ind.

PLEASE READ THIS OFFER TO PRESENT SUBSCRIBERS:

Send us just one new name for the American Bee Journal a year (with \$1.00), and we will mail you the Queen-Clipping Device FREE of charge. Or, the Queen-Clipping Device will be sent postpaid for 30 cts. But why not get it as a Premium by the above offer? You can't earn 30 cts. any easier. Almost every bee-keeper will want this Device. See page 130 (Feb. 27) for full description of it. Complete directions accompany each one sent out. It is a most ingenious and useful article. Address,

GEORGE W. YORK & CO., 118 Michigan St., Chicago, Ill.

❖ MONEY SAVED IS MONEY GAINED. ❖

THE ROYAL UNION Life Insurance Company

DES MOINES, IOWA.

The Iowa Policy

Is one that definitely promises to keep an accurate account with you; credit your premiums and interest, charge the actual expense and mortuary cost, and hold the remaining funds subject to your order.

Agents Wanted.

JOHN B. KING, GENERAL AGENT,
Suite 513 First Nat'l Bank Bld'g,
20Atf CHICAGO, ILL.

Our New 4-page Catalog

Contains testimonials from F. A. Gemmill, Wm. McEvoy, Inspector of foul brood for Canada; also many others from those who have tested the Adel bees. All testimonials came in since June 1, 1896. I challenge any queen-dealer in the world to produce such large, fine Queens as I am now sending my customers. "WE GET THE BEST QUEENS FROM YOU," so say a large majority of our patrons. I cannot supply 50-cent Queens—I do not rear that kind. Every one of my Queens is worth \$5.00. But I sell one for \$1.00; 3 for \$2.50; 6 for \$4.50; and 12 for \$8.00. No swarming, no stinging, and no disease among the Adels. A. I. Root Co. have six of as fine Adel Queens as any man can boast of. Can ship by return mail. Send for Catalog.

HENRY ALLEY, Wenham, Mass.
32Atf Mention the American Bee Journal.

IF YOU WANT THE

BEE-BOOK

That covers the whole Apicultural field more completely than any other published, send \$1.25 to Prof. A. J. Cook, Claremont, Calif., for his

Bee-Keeper's Guide,

Liberal Discounts to the Trade.

California

If you care to know of its Fruits, Flowers Climate or Resources, send for a Sample Copy of California's Favorite Paper—

The Pacific Rural Press

The leading Horticultural and Agricultural paper of the Pacific Coast. Published weekly, handsomely illustrated, \$2.00 per annum. Sample Copy Free.

PACIFIC RURAL PRESS,
220 Market St., - SAN FRANCISCO, CAL.

TEXAS QUEENS.

If you are in need of Queens, let me have your order. Price-List Free.

8A26t J. D. GIVENS, Lisbon, Tex.

BEGINNERS.

Beginners should have a copy of the Amateur Bee-Keeper, a 70-page book by Prof. J. W. Rouse. Price 25 cents; if sent by mail, 28c. The little book and the Progressive Bee-Keeper (a live, progressive 28-page monthly journal) one year, 65c. Address any first-class dealer, or

LEAHY MFG. CO., Higginsville, Mo.

SPECIAL OFFER

Warranted Queens, bred from best Imported or Home-bred Queens at 55 cts. each; 1/2 doz., \$3.00. Untested, 50 cts.; 1/2 doz., \$2.90. Tested, 70 cts.; 1/2 doz., \$3.70. 500 Queens ready to ship. LEININGER BROS., 30Etf FT. JENNINGS, OHIO.

handle them, with the mercury 80° in the shade. Although this would seem late for swarming in the East, it doesn't cut so much of a figure in this section of the country, as the season continues until September, usually, and I have had a swarm come out in the middle of August and gather enough to winter on, but of course we do not depend entirely upon white clover, as we have lots of fireweed for the latter part of the season.

F. M. LITTLE,
Junction City, Wash., July 21.

Doing Fairly Well—Big Yield.

Bees are doing fairly well here, but not nearly so well as last season, when I got 263 pounds of honey per colony, spring count, two-thirds extracted and one-third comb honey. A. J. WEST.
Paxton, Ill., July 20.

Must Feed to Save the Bees.

I shall have to feed from 5,000 to 10,000 pounds of sugar to save my bees this year. I have already fed 2,000 pounds. I do not shed any tears, but rejoice with those who have some honey, that there will be a sale for it.

Acton, Calif., July 20. F. J. FARR.

Not a Good Season.

I don't expect much honey this year, as we have had no honey season. April and May were very dry—we had no rain at all. June gave us rain nearly every day, consequently there was an extreme every time. There was plenty of locust bloom, but owing to dry weather bees did not work on it. There has not been much swarming here, and our swarming-season is over for this year. We are having plenty of rain now, and I hope we will get some honey yet, before the summer ends. When I have gathered my honey harvest, I will report again. I cannot keep bees without the American Bee Journal. C. H. MAY.
Grove Hill, Va., July 22.

Good Prospects for a Large Crop.

I had promised last fall to report again this season how my bees were doing. I had in my yard 35 colonies last fall, in good condition; some were rather weak in bees on account of their late swarming, the old bees mostly all having gone with the swarms, and by the time the young queens were ready to lay the honey-flow was about over, and very few young bees were reared, which accounts for some of the winter losses I had. All had enough honey and some to spare.

I had about half of the 5-banded goldeo Italian stock, and the rest were 3-banded and hybrids. Of the 5-banded kind I had the pleasure of finding one colony alive this spring, and the queen of that colony came from Canada, and her chances last fall were mighty slim for successful wintering. Some of the other 5-banded did not live to celebrate Christmas, and one after the other passed away until only one remained.

Of the 3-banded kind, I found all alive this spring but one colony, which became queenless in December, and the bees, hunting for the queen, flew out of the hive and were chilled, never to get back into the hive.

The hybrids winter as well as the 3-

Honey-Clovers & Buckwheat SEED FOR SALE.

We have made arrangements so that we can furnish seed of several of the Clovers and Japanese Buckwheat, by freight or express, at the following prices, cash with order:

	5lb	10lb	25lb	50lb
Alsike Clover	\$.70	\$1.25	\$3.00	\$ 5.75
Sweet Clover	.75	1.40	3.25	6.00
White Clover	1.25	2.00	4.50	8.00
Alfalfa Clover	.65	1.10	2.70	5.00
Crimson Clover	.55	.90	2.00	3.50
Jap. Buckwheat	.20	.35	.90	1.25

Prices subject to market changes.

Add 25 cents to your order, for cartage, if wanted by freight.

Your orders are solicited.

GEORGE W. YORK & CO.,
CHICAGO, ILLS.

Sweet Clover 1/4 Canada.

At the following prices:

5 lbs.	10 lbs.	25 lbs.	50 lbs.
\$1.00	\$1.60	\$3.75	\$7.25.

Also a quantity of Motherwort and Catnip seed. Prices on application.

EGGS for Hatching. Buff Leghorns. Indian Games, & Light Brahmas. Choice Birds. A breeder for 30 years. Prices on application

JOHN MCARTHUR,
881 Yonge Street, - TORONTO, ONT.
15Atf Mention the American Bee Journal.

* Extracted Honey *

Finest Quality. Basswood and Clover.

2 60-lb. cans in case, 8c. per pound. 1 60-lb. can in case, 9c. per pound. A sample by mail, 10 cts. **POUDER'S Honey-Jars and Complete Line of Supplies.** Catalogue Free.

WALTER S. POUDER,
162 Mass. Avenue, INDIANAPOLIS, IND.
Mention the American Bee Journal.

HONEY We have No. 1 Alfalfa, also White and Sweet Clover Honey we will sell cheap.

Honey and Beeswax Wanted.

Warranted the best, simplest and quickest Escape on the market. Sent postpaid to any address for 30 cts. It can be returned at our expense if it is not as represented, or we will send the Escape on trial to any bee-keeper wishing to test it in good faith. We are agents for the Ferguson Patent Hive with double-case Super and Wicket-Gate Honey-Board, with the Escape. It is the easiest, quickest hive to handle for the production of comb or extracted honey.

E. S. LOVESY & CO.,
355 6th East St., SALT LAKE CITY, UTAH.
Mention the American Bee Journal. 9Atf

Van Deusen Foundation!

I have some of the celebrated Van Deusen Thin Foundation in 25-pound boxes, that I will put on board cars for \$12.50 per box.

Also ITALIAN

Queens!

Queens!



Fine Untested Queens mailed PROMPTLY at 55 cts. each, or Six for \$3.00.

Safe delivery and satisfaction guaranteed. Address,

F. GRABBE,
LIBERTYVILLE, Lake Co., ILL.

26Atf Mention the American Bee Journal

READERS Of this Journal who write to any of our advertisers, either in ordering, or asking about the Goods offered, will please state that they saw the Advertisement in this paper.

No. 1 Sections—Cheap.

We offer for a few weeks, a surplus stock of our one-piece No. 1 Cream Sections at the following very low prices:

1000 for \$1.50.

3000 for \$4.00.

5000 for \$6.00.

These Sections are finely finished and No. 1 in all respects save color, being, as their name indicates, of a cream color.

The stock consists of a quantity each of the following sizes:

4½x2, open 2 sides 4¼x1 15-16, open 2 sides
4¼x1 7-8, open 2 sides
4¼x1½, open 2 sides 4¼x7-to-ft., open 2 sides

G. B. LEWIS CO.

WATERTOWN, WIS.

ITALIAN QUEENS

Golden or Leather-Colored!
BY RETURN MAIL.

Fine Untested, 60c. each; two, \$1.00. Select Untested, 75c. Tested, \$1.00 Full Colonies cheap. No disease. Remit by express money order, payable at Baroum, Wis. Many customers send \$1.00 and \$2.00 bills. 2c. stamps taken for less than \$1.00. Safe delivery and satisfaction guaranteed.

P. S.—57 choice 2-yr.-old Queens, 25c. each while they last.

VAN ALLEN & WILLIAMS,

BARNUM, WIS.

29Atf Please mention the Bee Journal.

Page & Lyon Mfg. Co.,

NEW LONDON, WIS., operates two saw-mills that cut, annually, eight million feet of lumber, thus securing the best lumber at the lowest price for the manufacture of bee-keepers' supplies. They have also just completed one of

The Largest Factories,

and have the latest and most improved machinery for the manufacture of Bee-Hives, Sections, etc., that there is in the State. The material is cut from patterns, by machinery, and is absolutely accurate. For Sections, the clearest and

The Whitest Basswood

is used, and they are polished on both sides. Nearness to pine and basswood forests, and possession of mills and factory equipped with best machinery, all combine to enable this firm to furnish the best goods at

The Lowest Prices. ♥♥

For instance, it has a job lot of 200,000 No. 2 Sections that will be sold at 50 cts. per 1,000; or 2,000 Snow-White sections will be sold for \$4.00, and larger quantities at still lower prices. Send for Circular and see the prices on a full line of supplies. 16Atf

WOVEN WIRE FENCE

Over 50 Styles The best on Earth. Horse high, Bull strong, Pig and Chicken tight. You can make from 40 to 60 rods per day for from 14 to 22c. a Rod. Illustrated Catalogue Free. KITSSELMAN BROS., Ridgeville, - Indiana.

48EtF Mention the American Bee Journal.

10 per ct. Off to Reduce Stock

on all kinds of SUPPLIES, except

—COMB FOUNDATION—

which will be sold in lots of 10 lbs. or more as follows: Medium, 35 cts.; Light, 36 cts.; Thin Surplus, 40 cts.; Extra Thin, 45 cts.

Queens—Warranted, 50c.; Tested, 75c.

W. J. FINCH, Jr., SPRINGFIELD ILLS.

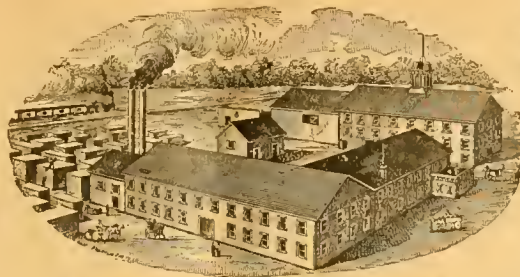

22Est

Address,

E. KRETCHMER, Red Oak, Iowa.

banded, but are too cross; I can't handle them—must Italianize them.

White clover was very scarce here this year, but my bees had several fields of alsike which yielded well. Basswood is scarce, but it yielded very much honey; also the chestnut did well. Now comes buckwheat, and the prospects are good for a large crop of honey. I now have in my yard 37 colonies, ready for business. I winter them out-doors. Last winter was an extra hard one, killing nearly all the clover and wheat in this section. PAUL WHITEBREAD.

Hobbie, Pa., July 24.

Good Fall Crop Expected.

The prospects are good for a fall crop of honey. Sweet clover is in full bloom, and bees are working on it in good shape. White clover was quite plentiful this year, but yielded very little honey—just enough to get bees in good condition for sweet clover and golden-rod. R. E. QUICK.

Clare, Iowa, July 24.

Adulteration—Foul Brood.

I have read with much interest the program of the North American convention, especially that part relating to amalgamation and the adulteration of honey. This is one of the great questions, in fact, I might say, the principal one, that is agitating the minds of many bee-keepers. Supply and demand cut very little figure as long as this fraud of adulteration is allowed to be practiced on the bee-keepers, or the producers, and the consumers. I have received reliable information that it is continually practiced; it runs down the price of pure honey out of sight for the producer. Then when the glucose mixer gets in his work, who can figure out to us the total collected from the consumers? Is there no end to this abuse? Must we always grin and bear it? If so, why could not, and should not, every State have a law for the protection of the bee industry and public? I am pleased to see this part of the program in good hands, and I hope to see our grand old American Bee Journal keep up this fight until the rascals are crowded out, and honest people get their just due.

There are two very important subjects which I fail to see on the program, namely, Foul Brood and the Spraying of Fruit-Trees. Both of these have been, and are, causing much loss to bee-keepers. I have had much experience on these questions in the past four or five years. While there have been many foul brood laws framed, I believe that more good can be accomplished in the matter by educating bee-keepers. Too

BEE-SUPPLIES!

We have the best equipped Factory in the West. Capacity—one carload a day; and carry the largest stock and greatest variety of every thing needed in the apian, assuring **BEST** goods at the **LOWEST** prices, and prompt shipment.

Illustrated Catalog, 80 pages, Free.

many bee-keepers do not know what foul brood is. I have known bee-keepers actually to divide foul brood colonies! Others will let the ants destroy their bees, and not know of it until it is too late. It is also the same with fruit-tree spraying. They only realize it when the hives are empty. Among the many experiments that I have been trying for foul brood is one that I hope to prove a success. It is a mixture of salt and other ingredients. While I do not care to get laughed at, if I prove anything reliable in this matter, I will be pleased to give the information.

E. S. LOVESY.

Salt Lake City, Utah.

The Hive Discussion.

It seems to me that as interesting and valuable topic as could be desired is the bee-hive, its size and shape of brood-chamber, etc. While this topic received a great deal of attention from most of the prominent apiarists of the country, I, for one, shall consider the discussion incomplete so long as the standard Langstroth frame remains standard. I have experimented enough with this frame and hive to know whereof I speak, and my experiments are confirmed by hundreds of practical and observing apiarists all over the land.

There are many who think that locality has so much to do with the hive used. This is, to quite an extent, a mistake, if a good hive is adopted. For instance, where did the Dadant hive ever fail? I could also refer to a couple others equally good, but there name is not "standard Langstroth." The manufacturers and our authors are the ones that raised the Langstroth hive and frame to such a high standard, but most of these people received quite an unexpected shock the past season, and many are beginning to realize their mistakes, but they do not seem in haste to speak out. There is one, however, for whom I have always had great respect, and who, I believe, is still riding the fence-rail. He is also well known to the readers of the American Bee Journal, or any other journal pertaining to apiculture. He is Dr. C. C. Miller.

Right here I want to say that I heartily endorse the first paragraph of Mr. C. P. Dadant's article, on page 433, concerning the Doctor's motto, etc. Now, who can tell what made the Doctor ask Messrs. Dadant & Son the questions he there asks, if he is not losing some faith in his hive? And also notice how the Doctor answered the 4th question of W. S., on pages 470-71.

It is to the editor's interest, to the manufacturers' interest, and to the interest of all who wish to see our frater-

nity and our favorite pursuit prosper, to go on and advise and use only the best regardless of expense.

I hope that this important question will be allowed more space and attention. Findlay, Ohio. JOSEPH THIRY.

P. S.—I would be glad to hear from Dr. Miller, through the Bee Journal, concerning his present opinion of the hive discussion. J. T.

Question-Box.

In the multitude of counsellors there is safety.—Prov. 11-14.

Proper Space from Center to Center of Brood-Frames.

Query 24.—What is the proper bee-space in the brood-chamber, allowing and using 1-inch wide frame for brood comb? Or, what is the proper spacing from center to center of such frames to obtain the best results?—GARDEN CITY.

W. G. Larrabee— $1\frac{3}{8}$ inches.

Chas. Dadant & Son— $1\frac{1}{2}$ inches.

G. M. Doolittle—1 use $1\frac{1}{2}$ inches.

B. Taylor— $\frac{1}{4}$ inch. I use $1\frac{3}{8}$ inches.

W. R. Graham—Not quite $1\frac{1}{2}$ inches.

E. France—From center to center, $1\frac{1}{2}$ inches.

Mrs. L. Harrison— $1\frac{1}{2}$ inches from center to center.

Prof. A. J. Cook—1 use $1\frac{1}{2}$ inches from center to center.

C. H. Dibbern— $1\frac{3}{8}$ inches is the proper bee-space.

James A. Stone— $1\frac{1}{2}$ inches from center to center, I think.

R. L. Taylor— $1\frac{3}{8}$ inches from center to center—less, rather than more.

Eugene Secor—Slightly less than $1\frac{1}{2}$ inches from center to center of frame.

H. D. Cutting—1 $\frac{5}{16}$ to $1\frac{3}{8}$ makes a good distance from center to center of frames.

J. M. Hambaugh—I have used $1\frac{1}{2}$ inches from center to center, and believe it to be the best.

Dr. J. P. H. Brown—1 $\frac{7}{16}$ inches from the center of one frame to the center of the next is nearly right.

P. H. Elwood—The tendency seems to be toward $1\frac{3}{8}$ inches from center to center. The larger part of ours are $1\frac{1}{2}$ inches.

Emerson T. Abbott— $\frac{1}{4}$ inch is the proper bee-space between the frames, above the frames, and at the end of the frames.

Dr. C. C. Miller— $1\frac{3}{8}$ seems to be the standard from center to center, and it's certainly good; but $1\frac{1}{2}$ may be just as good.

Rev. M. Mahin—Do you mean to ask one question, or two? I space my frames $1\frac{1}{2}$ inches from center to center. As the frames are movable, there is not exact uniformity in the spacing.

J. E. Pond—With a one-inch wide frame, I should give about $\frac{1}{8}$ inch space between the top-bars; by so doing, and spacing evenly, the filled combs will be as nearly "bee-space" apart as possible, and which spacing I consider correct.

G. W. Demaree—From $1\frac{3}{8}$ to $1\frac{1}{2}$

The Bee-Keepers' Guide:

Or Manual of the Apiary,

BY PROF. A. J. COOK.

This 15th and latest edition of Prof. Cook's magnificent book of 460 pages, in neat and substantial cloth binding, we propose to give away to our present subscribers, for the work of getting new subscribers for the American Bee Journal.

A description of the book here is quite unnecessary—it is simply the most complete scientific and practical bee-book published today. Fully illustrated, and all written in the most fascinating style. The author is also too well-known to the whole bee-world to require any introduction. No bee-keeper is fully equipped, or his library complete, without "THE BEE-KEEPER'S GUIDE."

Given For 2 New Subscribers.

The following offer is made to PRESENT subscribers only, and no premium is also given to the two new subscribers—simply the Bee Journal for one year:

Send us Two New Subscribers to the Bee Journal (with \$2.00), and we will mail you a copy of Prof. Cook's book FREE as a premium. Prof. Cook's book alone sent for \$1.25, or we club it with the Bee Journal for a year—both together for only \$1.75. But surely anybody can get only 2 new subscribers to the Bee Journal for a year, and thus get the book as a premium. Let everybody try for it. Will you have one?

GEORGE W. YORK & CO.,
CHICAGO, ILLS.

A Bargain—EARLY QUEENS.

119 Colonies Italian Bees in Chaff Hives: two acres land; good house; excellent well.

Early Queens—Tested, \$1.00; Untested, 50c. Sent by return mail.

E. L. CARRINGTON,
16 Atf PETTUS, Bee Co., TEX.
Reference—1st National Bank of Beeville.
Mention the American Bee Journal.

DO NOT ORDER UNTIL YOU HAVE WRITTEN US FOR PRICES ON

The "Boss" One-Piece Section



Also D. T. Hives, Shipping-Crates and Other Supplies.

We have completed a large addition to our Factory, which doubles our floor room; we are therefore in better shape than ever to fill orders on short notice. Send for Price-List

J. FORNCROOK,

WATERTOWN, Jeff. Co., Wis., Jan. 1st, 1896.

Barnes' Foot-Power Machinery.

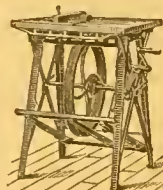

Free. Address, W. F. & JOHN BARNES,
45 Ctr No. 995 Bndy St., Rockford, Ill.
Mention the American Bee Journal.

The RURAL CALIFORNIAN

Tells all about Bees in California.

The Yields and Price of Honey; the Pasturage and Nectar-Producing Plants; the Bee-Ranches and how they are conducted. In fact the entire field is fully covered by an expert bee-man. Besides this, the paper also tells you all about California Agriculture and Horticulture. \$1.50 per year; Six Months, 75 cents. Sample Free.

THE RURAL CALIFORNIAN,
218 N. Main St., LOS ANGELES, CALIF.

inches, from center to center of the brood-frames. To be exact is not material. If you use fixed frames (I don't like them), plump $1\frac{3}{8}$ is nearly right for brood-combs. $1\frac{1}{2}$ is better for taking honey with the honey-extractor.

CARLOADS



Of Bee-Hives, Sections, Shipping-Cases, Comb Foundation, and Everything used in the Bee-Industry.

I want the name and address of every Bee-keeper in America. No reason why you cannot do business with me. I have Cheap Lumber and Experienced Workmen; a good Water-Power Factory and know how to run it. I am supplying Dealers as well as consumers. Why not you? Send for Catalogues, Quotations, etc. W. H. PUTNAM, 1E RIVER FALLS, Pierce Co., Wis.

Mention the American Bee Journal.

MUTH'S HONEY EXTRACTOR PERFECTION Cold-Blast Smokers,

Square Glass Honey Jars, Etc.

For Circulars, apply to CHAS. F. MUTH & SON, Cor. Freeman & Central Aves., Cincinnati, O. Send 10c for Practical Hints to Bee-Keepers.

Mention the American Bee Journal.

Convention Notices.

TEXAS.—The Central Texas Bee-keepers' Association meets at Cameron, Tex., Aug. 7 and 8, 1896. No hotel bills to pay.

C. B. BANKSTON, Cor. Sec.
Chriesman, Tex.

TEXAS.—The third annual convention of the Southwest Texas Bee-keepers' Association will be held at Beeville, Tex., on Sept. 16 and 17, 1896. All are invited. No hotel bills to pay. Low rates on railroads.

Beeville, Tex. J. O. GRIMSLEY, Sec.

MINNESOTA.—The annual meeting of the Southern Minnesota Bee-keepers' Association will be held in Winona, on September 24 and 25, 1896, at 9 o'clock, a.m. All that feel in any way interested in bees or honey are cordially invited to attend.

Winona, Minn. E. C. CORNWELL, Sec.

ILLINOIS.—The annual meeting of the Northern Illinois Bee-keepers' Association will be held at the residence of B. Kennedy, 3 miles northeast of New Milford, Ill., on Tuesday, Aug. 18, 1896. All are cordially invited, and I will meet any one at the train in New Milford if they will drop me a card.

New Milford, Ill. B. KENNEDY, Sec.

Doolittle's Book—Have You Read It?

Queens and Queen-Rearing.—

If you want to know how to have queens fertilized in upper stories while the old queen is still laying below; how you may safely introduce any queen, at any time of the year when bees can fly; all about the different races of bees; all about shipping queens, queen-cages, candy for queen-cages, etc.; all about forming nuclei, multiplying or uniting bees, or weak colonies, etc.; or, in fact, everything about the queen-business which you may want to know—send for Doolittle's "Scientific Queen-Rearing"—a book of over 170 pages, which is as interesting as a story. Here are some good offers of this book:

Bound in cloth, postpaid, \$1.00; or clubbed with the BEE JOURNAL for one year—both for only \$1.75; or given free as a premium for sending us three new subscribers to the BEE JOURNAL for a year at \$1.00 each.

HONEY and BEESWAX

MARKET QUOTATIONS.

The following rules for grading honey were adopted by the North American Bee-Keepers' Association, and, so far as possible, quotations are made according to these rules:

FANCY.—All sections to be well filled; combs straight, of even thickness, and firmly attached to all four sides; both wood and comb unsoiled by travel-stain, or otherwise; all the cells sealed except the row of cells next the wood.

No. 1.—All sections well filled, but combs uneven or crooked, detached at the bottom, or with but few cells unsealed; both wood and comb unsoiled by travel-stain or otherwise.

In addition to this the honey is to be classified according to color, using the terms white, amber and dark. That is, there will be "fancy white," "No. 1 dark," etc.

Chicago, Ills., Aug. 1.—We quote: Fancy; white clover, 15c.; No. 1 white, 12@13c.; fancy amber, 10@11c.; No. 1 amber, 7@9c.; fancy dark, 9@10c.; No. 1 dark, 7c. Extracted, white, 5@7c.; amber, 5@5½c.; dark, 4¼@5c. Beeswax, 25@27c.

The month closes with some offerings of new comb honey, for which 14-15c. is asked for best lots—but there are no sales of consequence to report. There is usually a good deal of it moved in August, thus establishing the early market.

Philadelphia, Pa., July 10.—No. 1 amber, 9-10c.; fancy dark, 8-9c.; No. 1 dark, 7-8c. Extracted, white, 8-10c.; amber, 5-5½c.; dark, 3¼-4c. Beeswax, 25-26c. Honey very dull. Beeswax in fair demand.

Buffalo, N. Y., July 24.—Fancy comb, 1-pouced 12-14c.; No. 2, 9-10c.; No. 3, 4-8c. Extracted, 3-5c., as to quality. It is folly to ship honey unless properly packed. Good results depend on it and quality.

Cincinnati, Ohio, July 10.—No. 1 white, 13@14c.; fancy amber, 12@13c.; No. 1 amber, 10@12c. White, extracted, 5@7c.; amber, 5@6c.; dark, 3¼-5c. Beeswax, 20-25c.

New York, N. Y., June 24th.—No demand for comb honey of any kind. New crop of southern extracted is arriving freely, and sells fairly good at 50@52c per gallon for common, and 55@60c per gallon for better grades. Beeswax dull at 26@27c.

Cleveland, Ohio, July 9.—We quote: Fancy white, 15@16c.; No. 1 white, 14@15c.; fancy amber, 10@11c. Extracted, white, 6@6½c.; amber, 4@5c. Beeswax, 20@25c. Our market is nearly bare of honey. We think early shipments would meet with ready sales at about quotations.

St. Louis, Mo., July 9.—We quote: Fancy white, 11½@12c.; No. 1 white, 10¼@11c.; fancy amber, 10@10½c.; No. 1 amber, 9@10c.; fancy dark, 8¼@9c.; No. 1 dark, 7@8c. Extracted, white, in cans, 5c.; in barrels, 4c.; amber, 3¼@4c.; dark, 3@3¼c. Beeswax, 25@25½c.

This week we sold 4,700 pounds of Southern extracted in barrels at 3¼c. Honey is in fair demand. Very little fancy new comb coming in, and what has been offered not well cured as yet.

Minneapolis, Minn., July 9.—We quote: Fancy white, 15c.; No. 1 white, 13@14c.; fancy amber, 10@12c.; No. 1 amber, 8@10c.; fancy dark, 7@9c.; No. 1 dark, 8c. Extracted, white, 5¼@6¼c.; amber, 5¼@5½c.; dark, 4¼@5¼c. Beeswax, 26@28c.

Actual transactions both in comb and extracted very light. Minnesota and Wisconsin comb will commence arriving in moderate quantities about August, and will probably supply the market until cool weather, which usually stimulates a demand. Considerable extracted is now here on the spot, sufficient to supply immediate wants.

San Francisco, Calif., July 22.—White comb, 11-12½c.; amber, 7½-10c. Extracted, white, 5-5½c.; light amber, 4¼-4½c.; amber colored and candied, 3¼-4c.; dark tulle, 2¼-3c.

Stocks in this center are small, and a considerable proportion of the honey now here is of the crop of 1895. There will be little California honey this season; but with an absence of export demand, supplies may prove ample.

Beeswax, fair to choice, 22-26c. There is a tolerably wide range in values and a correspondingly wide range in the quality of the offerings.

Milwaukee, Wis., July 13.—No. 1 white, 12-13c.; No. 1 amber, 8-10c. Extracted, white, 7-7½c.; amber, 6-6½c.; dark, 5-6c. Beeswax, 20-24c.

The supply of honey is not large and nearly all old crop, as the receipts of new are extracted; quality fair. The demand is limited, as the supply of small fruits is large and the consumption of honey is small. The market will be in good condition for shipments of the new crop, both comb and extracted, and we look for a good demand later.

Albany, N. Y., Aug. 1.—Fancy white, 13-14c.; No. 1, 12-13c.; No. 1 amber, 11-12c. We have received a number of consignments of new comb honey, mostly white, and a great many letters from producers, asking if they should forward their honey as soon as it was ready. There is but very little demand for honey during hot weather and it creates an unfavorable impression on the trade to see a large stock of honey standing around. September 1 is time enough to forward comb honey. We look for a large crop of white honey and prices lower than last season.

Detroit, Mich., July 13.—No. 1 white, 11-12½c.; fancy amber, 10-11c.; No. 1 amber, 9-10c.; fancy dark, 8-9c.; No. 1 dark, 7-8c. Extracted, white, 6-7c.; amber, 5-6c.; dark, 5c. Beeswax, 24-25c.

There is very little old honey on the market that is desirable. New honey will sell slowly in this market until October.

Indianapolis, Ind., July 23.—Fancy white 15-16c.; No. 1 white, 13-14c. Extracted, white, 6-7c. Beeswax, 25-27c.

No demand at all for off grades of either comb or extracted honey. Large fruit crop and warm weather are opponents to the demand for honey at present.

Boston, Mass., July 15.—Fancy white, 14-15c.; No. 1 white, 12-13c.; fancy amber, 9-10c. Extracted, white, 6-7c.; amber, 5-6c. Beeswax, 25-26c.

Fancy new white honey now in stock; demand fair. Old stock nearly closed out.

Kansas City, Mo., July 20.—Fancy white comb, 15c.; No. 1 white, 13@14c.; fancy amber, 12-13c.; No. 1 amber, 11-12c.; fancy dark, 10-11c.; No. 1, 8-10c. Extracted, white, 6-6½c.; amber, 5 5½c.; dark, 4 4½c. Beeswax, 22-25c.

List of Honey and Beeswax Dealers.

Most of whom Quote in this Journal.

Chicago, Ills.

R. A. BURNETT & Co., 163 South Water Street.

New York, N. Y.

HILDRETH BROS. & SEELKEN,
120 & 122 West Broadway
CHAS. ISRAEL & BROS., 486 Canal St.

Kansas City, Mo.

C. C. CLEMOMS & Co., 423 Walnut St.

Buffalo, N. Y.

BATTERSON & Co., 167 & 169 Scott St.

Hamilton, Ills.

CHAS. DADANT & SON.

Philadelphia, Pa.

WM. A. SELSER, 10 Vine St.

Cleveland, Ohio.

WILLIAMS BROS., 80 & 82 Broadway.

St. Louis, Mo.

WESTCOTT COM. Co., 213 Market St.

Minneapolis, Minn.

S. H. HALL & Co.

Milwaukee, Wis.

A. V. BISHOP & Co.

Boston, Mass.

E. E. BLAKE & Co., 57 Chatham Street

Detroit, Mich.

M. H. HUNT, Bell Branch, Wayne Co., Mich

Indianapolis, Ind.

WALTER S. POWDER, 162 Massachusetts Ave.

Albany, N. Y.

CHAS. McCULLOCH & Co., 380 Broadway.

Cincinnati, Ohio.

C. F. MUTH & SON, cor. Freeman & Central avs.



BEE JOURNAL
PUBLISHED WEEKLY BY
GEORGE W. YORK & CO.,
At One Dollar a Year,
CHICAGO, ILLS.

Postage to all Countries in the Postal Union is 50 cents extra. To all others, \$1.00 more than the subscription price.

Hebblewhite & Co., 369 George Street, Sydney, New South Wales, Australia, are our authorized agents. Subscription price, 6 shillings per annum, postpaid

Important to All Subscribers.

The American Bee Journal is sent to subscribers until an order is received by the publishers for its discontinuance, and all arrearages are paid.

Always State the Post-Office to which your paper is addressed, when writing to us.

A Sample Copy of the Bee Journal will be sent FREE upon application.

How to Send Money.—Remit by Express, Post-Office Money Order, or Bank Draft on New York or Chicago. If none of these can be had, Register your Letter, affixing Stamps both for postage and registry, and take a receipt for it. Money sent thus, IS AT OUR RISK; otherwise it is not. Do not send Checks on Local Banks—we have to pay 25 cents each, to get them cashed.

Never Send Silver in letters. It will wear holes in the envelope, or may be stolen.

Money Orders.—Make all Money Orders payable at Chicago, Ill.—not at any sub-station of Chicago.

Postage Stamps of any denomination may be sent for any fraction of a dollar; or where Money Orders cannot be obtained, stamps for any amount may be sent.

Subscription Credits.—The receipt for money sent us will be given on the address-label of every paper. The subscription is paid to the end of the month indicated.

Do not Write anything for publication on the same sheet of paper with business matters, unless it can be torn apart without interfering with either part of the letter.

Lost Numbers.—We carefully mail the Bee Journal to every subscriber, but should any be lost in the mails, we will replace them if notified before all the edition is exhausted. Please don't wait a month or two, for then it may be too late to get another copy.

Emerson Binders, made especially for the American Bee Journal, are convenient for preserving each weekly Number, as fast as received. They will be sent, postpaid, for 75 cents, or clubbed with the American Bee Journal for one year—both together for \$1.00. They cannot be sent by mail to Canada.

North American Bee-Keepers' Association OFFICERS FOR 1896.

PRESIDENT—A. I. Root, Medina, Ohio.
VICE-PRES.—Wm. McEvoy, Woodburn, Ont.
SEC.—Dr. A. B. Mason, Sta. B, Toledo, Ohio
TREAS.—W. Z. Hntehinson, Flint, Mich
Convention at Lincoln, Nebr., Oct. 7 & 8.

National Bee-Keepers' Union.

PRESIDENT—HOB. R. L. Taylor, Lancaster, Mich.
GEN'L. MOR.—T. G. Newman, San Diego, Cal.

Bottom Prices

**BRING US BIG TRADE.
GOOD GOODS KEEP IT.**

If you want the best supplies that can be made at a little less cost than you can buy the same goods for elsewhere, write to us for low prices. 1896 Catalogue now ready—ask for it and a free copy of **The American Bee-Keeper** (36 pages).

Address,
**THE W. T. FALCONER MFG. CO.,
JAMESTOWN, N. Y.**
Mention the American Bee Journal.

COMB FOUNDATION!

Wax always wanted for Cash or in Exchange for Fdn. or other Supplies. My trade is established on **Low Prices** and the merit of my **Foundation. Orders filled promptly.**

WORKING WAX INTO FDN. BY THE LB. A SPECIALTY. Wholesale prices to dealers and large consumers. Send for Prices and Samples to—**GUS DITMER, AUGUSTA, WIS.** Reference—Augusta Bank. 1Atf
Mention the American Bee Journal.

I ARISE



TO SAY to the readers of the **BEE JOURNAL** that **DOOLITTLE** has concluded to sell **—BEES and QUEENS—** in their season, during **1896**, at the following prices:

- One Colony of Italians on 9 Gallup frames, in light shipping-box \$6 00
- Five Colonies..... 25 00
- Ten Colonies..... 45 00
- 1 untested queen. 1 00
- 6 " queens 5 50
- 12 " " 10 00
- 1 tested Queen... \$1 50
- 5 " Queens. 3 50
- 1 select tested queen 2 00
- 3 " Queens 4 00

Select tested queen, previous season's rearing. 4 00
Extra Selected for breeding, **THE VERY BEST.** 5 00
About a Pound of **BKES** in a Two-frame Nuclens. with any Queen, \$2.00 extra.

☞ Circular free, giving full particulars regarding the Bees and each class of Queens.
Address

G. M. DOOLITTLE,
12A25t BORODINO, Onon. Co., N. Y.
Mention the American Bee Journal.

THROAT AND LUNG DISEASES,
DR. PEIRO, Specialist
Offices: 1019, 100 State St.,
CHICAGO. Hours 9 to 4.

Mention the American Bee Journal.

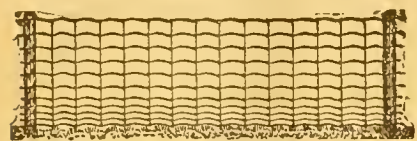

Counter Attractions.

Some farmers claim that State Fairs have degenerated into mere "Agricultural boss trots," with attendant demoralizing influences. The P. W. W. F. Co. comes to the rescue with a free exhibition of native wild animals, such as Deer, Elk, Buffalo, etc., securely enclosed with the only park fence. Send for particulars.

PAGE WOVEN WIRE FENCE CO., Adrian, Mich.
Mention the American Bee Journal.

19th Year Dadant's Foundation 19th Year

Is still in the lead, for we use all the latest improvements, including the

NEW WEED PROCESS,

and still make the best goods. Remember that we do not use any acid to purify our beeswax, and that is why our Foundation preserves the smell of the honey and is more acceptable to the bees, than any other. It is kept for sale by

T. H. Strickler, Solomon City, Kansas.
G. K. Hubbard, Fort Wayne, Ind.
L. Hanssen, Davenport, Iowa.
C. Theilmann, Theilmanton, Minn.
E. C. Eaglesfield, Berlin, Wis.
E. T. Abbott, St. Joseph, Mo.
J. M. Jenkins, Wetumpka, Alabama
John Rey, East Saginaw, Mich.
Vickery Bros., Evansville, Ind.

The Jennie Atchley Company, Beeville, Texas.
C. F. Muth & Son, Cincinnati, Ohio
E. Kretzmer, Red Oak, Iowa.
G. B. Lewis Co., Watertown, Wis.
James Reynolds Elevator Co., Poughkeepsie, N. Y.
Louisiana Bee-Keepers' Supply Manufactory, Donaldsonville, La.
Page & Lyon, New London, Wis.
John Nebel & Son, High Hill, Mo.

and many other Dealers. All agree in saying that no goods are better than ours.

Those of our customers who formerly bought through Thos. G. Newman can get our Foundation in **Chicago, Ill.**, by addressing us at **115 Michigan Street.** We keep no other goods there.

We make a specialty of **Veils and Veil Stuffs** of best quality, cotton and silk.

"LANGSTROTH ON THE HONEY-BEE"—Revised.

Bee-Keepers' Supplies, Smokers, Sections, Tin Pails, etc.
Samples of Foundation and Tulle FREE with Circular. Instructions to beginners with Circular. Send us your address.

CHAS. DADANT & SON,

Mention the American Bee Journal.

HAMILTON, Hancock Co., ILL.

No. 1 4x4 Snow-White Sections \$2.00 per 1,000.



For the purpose of introducing our One-Piece Section to the bee-keepers generally, we have concluded to make the price \$2.00 per 1,000 for the season. Now is the time to get your Sections cheap. We have a choice lot of Section Lumber, gotten out of young timber, and we can furnish you the nicest Section to be had. Write for Sample Section Free.

32Atf

Mention the American Bee Journal.

The Marshfield Mfg. Co., MARSHFIELD, Wood Co., WIS.

The Bee Journal to New Suscribers July 1 to Jan. 1, only 40 cts.

A Large Book Free

☞ To every new subscriber who sends us \$1.00, we will send him our journal,

Gleanings in Bee-Culture,

one year, and the book by A. I. Root, containing 190 pages, size 6½x9½, entitled

What to Do, and How to be Happy while Doing It,

postpaid. The regular price of this work is 50 cents.

If you prefer, the journal may be sent to a friend, and you can keep the book for yourself.

**THE A. I. ROOT COMPANY,
MEDINA, OHIO.**

AMERICAN BEE JOURNAL

DEVOTED EXCLUSIVELY TO THE INTERESTS OF HONEY-PRODUCERS

ESTABLISHED IN 1861
THE OLDEST BEE-PAPER IN AMERICA

Published Weekly, at \$1.00 per annum.

Sample Copy sent on Application.

36th Year.

CHICAGO, ILL., AUGUST 13, 1896.

No. 33.

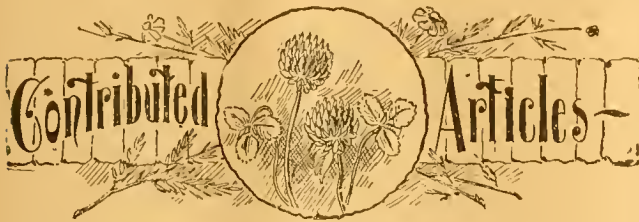

Mrs. N. L. Stow and Her Apiary.

BY GEORGE W. YORK.

About three weeks ago we received a very cordial letter from Mrs. N. L. Stow, inviting Mrs. York and myself to visit her home and apiary in Evanston, Ill., 11 miles north of Chicago. I replied that all being well we would be pleased to accept the generous invitation on Saturday afternoon, Aug. 1.

The day came, and with it threatening clouds, but we took the train, and soon were at the station where Mrs. Stow's son, "Harry," met us with a two-seated carriage. Unbeknown to us, Mr. Stow and daughter were on the same train (as they both are employed in the city); so we all rode over to the Stow home and plantation, a good half mile, where we found Mrs. Stow and her apiary of some 80 colonies of Italian bees.

In conversation with Mrs. Stow before going to the beeyard, I learned that she began to keep bees in the spring of 1884, buying two colonies in 10-frame Langstroth hives from a bee-keeper in an adjoining town, and paying \$10 per colony for them. Mrs. Stow, though entirely ignorant about bees, was compelled to do her own selecting of the colonies out of about a dozen, and how was she to judge, never having seen the inside of a bee-hive? Well, she looked carefully at the hive-entrances, and thought she saw rather more bees flying at some than others, and so she chose those that seemed to have the most bees passing out and in. To show the wisdom of her choice, or luck, I may say that by fall she had increased to 8 colonies by natural swarming, and had about 70 pounds of honey.

Upon asking Mrs. Stow how she happened to begin to keep bees, she said that she and Mr. Stow were very fond of animal pets—birds, for instance, and she has quite a little aviary—and they thought they would also like a few bees, more for the pleasure to be found in caring for them than for pecuniary profit. But with the pleasure there also came quite a little profit, as some years she has had as high as 1,200 pounds of comb honey, which she invariably sold to local grocers at a good price.

After chatting awhile in-doors, we repaired to the apiary, which is slightly to one side at the rear of the house. The hives, all neatly painted white and numbered, were set in

rows—9 in each—north and south, facing the east, and all well protected by small willow and basswood trees at the west, and various kinds of low-growing trees, corn, etc., on the east. The rows were about 10 feet apart, and a space of about 3 inches between the hives in each row. The hives are of the portico style, and at the front of each row there was a board platform about 18 inches wide, upon which the bees drop as they return laden with pollen or honey.

Mrs. Stow has had some 30 natural swarms this year—in fact, one issued just as we were examining another colony, and alighted on a small willow tree about 10 rods away. It had a clipped queen, which Mrs. Stow had no difficulty in quickly finding just outside the hive and catching in a small cage; she removed the old hive, put an empty one in its place,



Mrs. N. L. Stow, Evanston, Ill.

and laid the queen (still in the cage) immediately in front. Soon the swarm came pouring back, and began to enter the empty hive, when Mrs. Stow liberated the queen, and saw that she entered the hive along with the bees. Thus that swarm was easily hived.

The reason for placing the hives thus in rows, was for

convenience in preparing them for winter. This is done by having a long box made of portable sides and ends, fastened together by means of iron rods, something like the sides and ends of a wagon-box are held together, excepting that these winter boxes have an extra iron rod in the center to prevent spreading when packed. The front side of this winter box is about 8 inches higher than the rear, and then a short-board roof is put on. Within, it is packed with straw, hay or leaves, preferably the latter, which are used over and over. The packing is put all around the hives, to the depth of about 6 inches, except between them, which is, as before mentioned, about 3 inches.

A winter entrance is made by putting say half-inch cleats across the ends of a board the length of the hive entrance, and about 6 inches wide. This is then inverted and pushed up to the hive at the entrance, when the bees can easily pass out under it, as the cleats raise it sufficiently. The front side of the long packing box rests right down on the cleated entrance-board, and thus does not interfere with the bees passing out and in.

I should say, further, that before putting the leaves into the outer box, a Hill's device is put over the brood-frames of of each colony, then a 10-inch super in which is a chaff-cushion.

Mrs. Stow finds the above a very successful and convenient way to winter bees.

Towards evening Mr. and Mrs. Stow took us out riding, showing us the various points of interest in the town, among them the Illinois Girls' Industrial School, where are found about 100 orphan children, cared for by State appropriation; also two of the finest school buildings in the State, each costing \$45,000. One was built last year, and the other, which we explored, just being completed. They certainly are the most beautiful and commodious school buildings I ever saw, or expect to see. Mr. Stow is President of their school board, as well as one of the 14 aldermen of the city of Evanston.

Before leaving, and "on the quiet," I succeeded in getting Mrs. Stow's photograph, with which to give her a little surprise. You have seen the picture on the previous page. Mr. Stow, a few days afterward, kindly furnished the following notes concerning his "better half," for which "kindness" Mrs. Stow will now no doubt "settle with him:"

MR. YORK:—I hardly know what would be of interest to your readers regarding Mrs. Stow's history, so I must leave you to say what seems best regarding her bee-industry. She was born in Milford, Conn., her family from good puritan stock; educated in the best schools there, married, and came to Chicago in 1863, coming to Evanston in 1872. We moved to our present home in the spring of 1867.

Being naturally a lover of Nature, she has always given much care and attention to the cultivation of flowers. Twelve years ago she became interested in the study of bees and their habits. She sent for Root's "A B C of Bee-Culture," which, with other publications in this line, gave her a very complete idea of what could be accomplished with bees when rightly and scientifically handled; and believing it was one of the industries in which women can engage with honor and profit, she decided not only to study, but put her knowledge into practice with two colonies, for which she paid \$10 each.

She increased from year to year, sending to several points for the best imported Italian queens, and adopting the most modern appliances. She has never worked for extracted honey, but for comb honey exclusively, which has mostly been taken by local grocers at from 18 to 20 cents per pound. She gets this price because great care is used in cleaning all sections of every particle of propolis, and making it very attractive in appearance.

Mrs. Stow has given the subject of bees attention not so much for the profit as for the pleasure she has always derived from the study of these wonderful objects as a part of God's wonderful creation.

From 40 colonies, last year, the product was about 900 pounds, mostly fall honey, but of very fine quality. It is a little early to estimate for this year, but the prospect is good for a fair crop.

N. L. Stow.

Mr. and Mrs. Stow have five children—three daughters and two sons, one son and two daughters being at home.

After having tea, Mr. and Mrs. Stow drove to the station with us, and soon we were at home again, after having spent a very delightful afternoon with one of the most extensive lady bee-keepers near Chicago.



Golden Italian Bees—More Experience.

BY A. NORTON.

On page 387, Mr. Edwin Bevins stings away at the reputation of the golden Italians with almost hybrid viciousness; and any one reading his vigorous assault, and the facts whereon he bases it, may well be tempted to wonder whether Mr. Bevins never had but one colony of golden Italians, or whether he never had but one colony of any kind of bees to winter-kill—which?

In the very same article he tells us naively how, among his prosperous colonies, he has sundry poor ones that he has been feeding because of light stores; and, in one case, he was too late, as the bees had already perished of starvation. Were these bees "golden beauties?" I opine not; for if they had been, doubtless he would not have mentioned it so briefly. And the protected colony that died with plenty of stores furnished a parallel case to that of his golden Italians. He charitably supposes that the colony went into winter quarters without a queen; but he does not say whether the golden colony might perhaps have had the same trouble.

Well, I do not advance my own experience with golden, or 5-band, Italians as at all conclusive; because I have tried only a few of them, as yet. But, since my experience is several times as extensive as that of Mr. Bevins, and as it is incomparably more favorable, I will now set it forth for the sake of "helping out the other side."

I have some 5-band stock from Duvall, and some from Laws; both strains prove about equally good in all respects. One colony of the latter strain, however, chanced to have had an exactly even chance with a colony of the 3-band stock; and I therefore quote it more particularly. I had two colonies of black bees, obtained from bee-trees, which were so nearly even in numbers, combs, stores and young brood, that it was hardly possible to distinguish any difference. I gave one a 5-band queen from Laws, and the other a leather-colored queen from another reliable Eastern breeder, both being tested queens.

The queens commenced laying within 24 hours of each other; and the transition from black to yellow kept about even pace in the two colonies. During the fall, which is generally a barren season here with merely a few nectar-yielding flowers, the golden Italians rather gained on the others in the quantity of honey laid by, though both were necessarily rather poor. Through the winter (a drier and colder one than the average Californian winter) the goldens held their own better than the leather-colored ones. Toward February the goldens had the more honey and covered the more frames of the two. There was no doubt about their coming through, while, with the 3-banders it began to be almost hopeless without feeding, which I began to do. However, the month of February was the warmest known for years; and manzanita and ceanothus blooms gave them a chance to recuperate.

To cut the account short, the 5-banders have led all through the present season. The 3-banders revived and bred up into a pretty good colony, however; but they took the swarming-fever before filling their hive with either brood or honey. I have obtained some section honey from them, and rather more from the golden colony. This has been a dry year in California; but my golden Italians of both strains are holding their own right through it remarkably well.

Now, while they have done better than the leather-colored

bees thus far, I would be just as unwise to become filled with the sanguine idea that they are vastly superior to the latter in all cases, as I think Mr. Bevins is, in condemning them so strongly because just one colony died. Mr. B. admits that they built up well from a 2-pound nucleus. Some claim that they don't build up well. In fact, all sorts of sins are laid upon them; and I think that with very many (I am not charging Mr. Bevins, however) condemnation of 5-banders is becoming as much of a fad as the fault-finders claim that breeding them is. For my part, I would not expect them to be so very much better in point of profit; but mine have proved fully as good, or better, in every point, not excepting gentleness, which is truly remarkable.

Now, if the golden Italians are as good as the 3-banders in practical results, I shall continue to prefer them on account of looks. For they actually are "golden beauties;" and I arise to explain that the reason why this term is never likewise applied to a yellow dog, is precisely the same as why it may be applied to a gold watch, but never to a brass monkey. Give me "Wall Street" Italians! Monterey, Calif.



Value of Drawn Combs for Surplus Honey Production and Controlling Swarming.

BY ERNEST R. ROOT.

I am becoming more and more convinced of the great value of drawn combs. Supers containing sections with full sheets of foundation do very well; but it is plainly evident that those supers containing drawn combs are entered more quickly, and filled with honey, and capped over. My attention was especially called to this by noting how much more readily the bees would fill and cap over supers containing half-depth drawn combs for extracting. In the case of colonies of equal strength, the extracting-combs will be filled and capped over before the bees have begun to draw out a full sheet of foundation in the comb-honey supers—at least, that is our experience. For experiment, where some of the colonies were holding off and didn't seem to draw out the starters, I put on a super containing drawn combs, and, presto! the bees went into them immediately, and in a few days they were filled with honey and capped over.

I feel hopeful—yes, almost confident—that we can, to a very great extent at least, control swarming, even in the production of comb honey, providing that the drawn combs are used in the sections. So far, at least at our out-yard, we have had no swarms that have had plenty of drawn comb. But we have plenty of swarming from colonies having supers on them of foundation not yet even touched.

You see, the point is right here: Such a colony—that is, one having a super containing full sheets of foundation on top, and which the bees have not yet touched, is, in one sense of the word, a colony cramped for room—that is, it takes *pressure* to get the bees once started to drawing out the foundation. The brood-nest must be literally crammed full of honey; and even then this condition may exist for several days, and the probabilities are that queen-cells will be started, and that the bees will begin to loaf and make ready to swarm; and by the time sections are beginning to be drawn out a little, these same loafing bees have got into the habit of loafing, and the consequence is, that the colony does not begin to do what it might have done had it had drawn combs. In the production of comb honey under our present method, it takes *pressure* to force the bees out of the brood-nest into the sections.

It takes a great deal of their strength and honey, and the *pressure* must be great enough to excite swarming before they will actually commence. In a wild state, except in the case of swarms, bees have to build comparatively little new comb every year; and as soon as honey comes they simply store it away in space already provided. Now, it is not true that, in

the production of *comb* honey, we are asking the bees to do very much more than Nature asks them to do in their natural environments!

The Dadants run for extracted honey, and, of course, give the bees combs already drawn. It is well known that they have little or no swarming. While their large hives in a measure check natural increase, I believe that the drawn combs, empty and all ready for the incoming surplus, have more to do with it.

"But," you say, "how are we going to have drawn combs in sections?" Well, I would save all that are unfinished, and level them down by the B. Taylor method. But, then, you urge those unfinished sections left over would not begin to be enough. Perhaps not. Well, what then? I believe that, in the near future, from present indications, a foundation will be made having cell-walls and bases, natural thickness, the walls being $\frac{3}{8}$, $\frac{1}{2}$ inch, or deeper. But for the present I will not say anything more.

LATER.—After writing the foregoing on the value of drawn combs, I find the following in the American Bee-Keeper from the pen of G. M. Doolittle:

"Some have the idea that foundation is preferable to frames full of comb. This I think a mistaken idea, for the bees must consume some time in getting the foundation worked out to full combs, to say nothing of the expense of buying it, or the work of putting it into the frames. Foundation is good in its place, and I use very much of it, but I have it all fitted in frames, and drawn into combs by the bees, or have frames filled with nice worker combs by the bees building the same. I cannot see any sense in melting it up, or allowing the moth to consume it."

Mr. Doolittle expresses what hundreds of other practical bee-keepers believe. If drawn combs are valuable in *extracted* honey, why may they not be equally valuable in the production of *comb* honey? But, of course, such combs should be thin, and as perfect as natural combs.

[The foregoing is taken from Gleanings, and in the following number we find this letter from Mr. L. A. Ressler, of Indiana, who thus comments on what Mr. Root wrote above:—EDITOR.]

When reading what you have to say of "drawn combs for the production of surplus honey," I was moved to write a few lines. I have in former years read articles wherein the writer claimed that foundation was better than drawn combs. This statement surprised me, as my experience was quite to the contrary. I think if I could have all drawn combs for the sections, to supply all my bees, it would add at least 100 per cent. to my honey crop. I use a Given press to make foundation, and have been loing for one with which I could make foundation with cells $\frac{1}{2}$ inch deep. I hope (as you say) that the time may not be far distant when such foundation can be made. Give me drawn combs for brood-frames or sections, every time. Of course, for sections they must be clean and white; but for brood I care not if they are 20 years old.

L. A. RESSLER.

[Mr. Root then follows with this in further reference to the subject of the value of drawn combs in honey-production:—EDITOR.]

A good deal was said in the last July Review, indorsing drawn combs also. The editor, in commenting on what I said, gives this substantial indorsement:

"Full sheets of foundation are accepted more readily than starters; and partly drawn combs, leveled down *a la* Taylor, more quickly still. So says Gleanings, and Gleanings is right."

Mr. Ressler thinks he could add 100 per cent. to his comb-honey crop providing his bees did not have to draw-out foundation. When I said I thought we could add a *half* to the honey crop, I thought I was putting it strong enough so that some would challenge the statement; but I am not sure that Mr. Ressler's estimate is very far out of the way.

For some time I have known that the Germans were using a much deeper foundation than we do here in America. One of our customers in that country particularly specifies that his

mills shall turn out cell-walls at least $\frac{1}{8}$ of an inch deep. This made the whole thickness, including both sides and the base, from $\frac{1}{4}$ to $\frac{3}{8}$ inch. We tried some of this wax, and found that the bees accepted it very readily; but at that time, owing to the large amount of wax wasted, I came to the conclusion it was a rather expensive way to get comb; but, as I said before, I have confidence to believe that some of our native-born inventors will get up a foundation having very light side-walls $\frac{1}{4}$ or $\frac{1}{2}$ inch deep, with a base as thin as the natural. When the problem is once solved, we shall be making one of the greatest steps in advance in the production of comb honey that has ever been made. In the meantime it goes without saying, that Taylor's comb leveler—a device for leveling down partly drawn-out sections—is a big thing, and should be used by every comb-honey producer.



Fifteen Years' Experience in Bee-Keeping.

BY MRS. SALLIE E. SHERMAN.

(Continued from page 503.)

The winter of 1894-95 being unusually cold, the flowers were later than common in putting out in the spring. (I suppose this must have been the cause.) Upon going to the feed stable (I mean where I kept my cow feed), I found what seemed to me to be thousands of bees in my cotton-seed meal barrel, loading up with artificial pollen. This was the first time I ever saw anything like it. It was to me wonderful to see the amount they thus used each day for about 10 days, when natural pollen came on, and they never more visited the cotton-seed meal. During that 10 days, however, I think they averaged fully a gallon each day. I imagine those who are accustomed to use artificial pollen, or a substitute for the real article, would do well to give this cotton-seed meal a trial, and then report results through the Bee Journal. I think its superior for that purpose would be hard to find.

The best way to put a stop to robbing, that I ever found or practiced, was, after locating the colony that was the chief actor in the scene, just to exchange places with the robbing and robbed colony.

About the best way that I ever found to determine the colony that was doing the robbing, was to carry the robbed hive into the bee-tent, and let it remain say 15 minutes with the tent all closed, then go on the outside and open one corner so that the bees that had left the robbed hive would then be at liberty to go to their own hive; just watch a few moments, and you will find (or at least I always did) that most of them came from one colony; then just exchange places, and the robbing was at an end.

Once I had quite a troublesome time with bees in my honey-room. It was this way: Being alone and much in need of help, I had made arrangements with a neighbor to let their little boy come over and help me so many hours each day. After he had been here a few days so I had him pretty well drilled as to finding things that I wanted, I being some distance from the house wanted something in the honey-room, so after cautioning him to be sure that he fasten the door well after coming out, I sent him for the desired articles. It so happened that I was away from the house for a full hour. When I came near I heard a terrible furor, or uproar, amongst the bees. I hastened on to find that the small boy had left the honey-room door open, and it looked like a half-dozen swarms inside having a general jollification. You may be sure I had a hard time getting those bees out and quieted down. It occurred just at a time when there was no honey coming in, which made it so much worse for me. They had gotten a taste and found just where honey abounded, so they seemed determined to have it. They would knot up on the door-knob in great bunches, going in at the key-hole, and also a small space under the door, etc. The truth is, it took two weeks to

get them to forget that room. The whole apiary seemed to have partaken of the feast and general pandemonium. Well, I just then and there decided that I could dispense with the assistance of the small boy—in a word, get along without better than with his help; hence, one reason why so much of my time was spent alone. In bee-keeping, it seems to me, that it is harder to get good help than in any avocation I know of.

Rocks are very abundant here. I used them to tell me the condition my bees were in, instead of writing it in a book or on a slate, as many do. You see, it was this way: My bees were set in four long rows, so many in a row, facing east, then seven feet and another row facing west, then another 14 feet facing east, and the last seven feet, facing west. Through this wide alley, or street, we went to the barn and cow-shed. At any time when I wanted to know whether the bees had enough stores to last them until honey came again, or to see if there were any that needed to be extracted from, I commenced at one end of the row and tilted the hive forward, which was easily done, for you remember I had them all raised a few inches higher at the back than the front; thus I could tell what they needed from the weight, yet without any heavy lifting, just tilting forward. We will now start say March first:

The first hive we come to seems to be rather light; upon this I put one little rock, or pebble, if you prefer calling it thus; this shows that it needs a frame or two of honey. The next one appears all right; it has plenty, so I will just leave it as it is, which shows that it is all right. Upon tilting the next one, I find it very heavy, so I put two rocks on it, which shows that it has more than is needed. May be the next one I come to is not only light in stores, but I find that the bees appear weak—that is, they are not so plentiful on the alighting-board as they should be, so three rocks are put on top of this one, showing that it must be looked into, for more than likely it is queenless, and must be looked after. Thus I go to every hive in the whole apiary. When I get around, a glance will show the condition of every colony in the yard.

Then I begin to equalize them. I go to a hive that has two rocks, throw them down, open the hive and take out one, two or three frames of honey, just owing to how much it can spare, then close it without replacing any rocks. This shows that it is all right. I then take this, or these frames, as the case may be, to one of the hives that has one rock upon it, exchange the full frame or frames for empty ones, and leave the rock off, thus showing that it, too, is all right. Of course, the hive with three rocks had to be gone through with, so to speak, to see just what the trouble was, etc. After remedying it, the rocks were left off, unless I had to give it eggs from which to rear queens, in which event instead of removing the rocks one more was added, thus making four. These I let remain until the queen had not only been reared, but fertilized and laying. Thus you see, a good portion of the time during the working season there were rocks on some of the hives, thus telling me the condition of things on the inside.

As for planting something for the bees, I have had quite a good deal of experience on a small scale. I have tried mignonette, sunflower, both silverhull and common buckwheat, sweet clover, Simpson honey-plant, and lucern. The last named I gave rather an extensive trial, having planted two acres of it at one time, and about $\frac{1}{4}$ acre at another. The alfalfa, or lucern, in the first trial came up beautifully and grew splendidly until it was about eight inches high, then the drouth coming on, it ceased to grow, and finally died out altogether, which, of course, gave me no chance whatever to test its honey producing or yielding properties. The second trial, however, was a greater success, so far as growth was concerned. It bloomed profusely, but the bees paid very little attention to it, as, at the time it was in bloom there was an abundance of wild flowers which they seemed to prefer. Thus

it was with everything I planted, when the weather was favorable for the things I planted, it was also favorable for the wild or native plants and flowers; so I finally decided that with me at least it did not, would not, pay to plant anything for honey.

I haven't had a comb to melt down in 10 years. This, no doubt, was partly due to having old combs mostly, and partly to the good ventilation and shade. I used shade-boards for such hives as were in the sunshine and needed them.

I had a great many inquiries and calls for queens, but had so much other work I only reared queens for my own use—not always all I needed, as I bought quite a good many from different breeders.

Bell County, Tex.

(To be continued.)



Rendering Beeswax—Wax-Extractors.

BY C. G. FERRIS.

This is usually accompanied with many disagreeable features, and there are many different ways of doing the job. One way is to take a large wash-boiler or kettle and put in a quantity of water, and, when boiling, the combs designed for rendering are put in, the sediment going to the bottom of the boiler and burning, many times melting the bottom off and the contents running over the stove, accompanied by great danger of burning the building.

Another very harmless and mild way, that is recommended by some bee-keepers that never have many old combs, or much wax to make, is the solar system. By concentrating the sun's rays with the force necessary to take photographs through a two-inch plank—or as strong as the Cathode rays—it may be

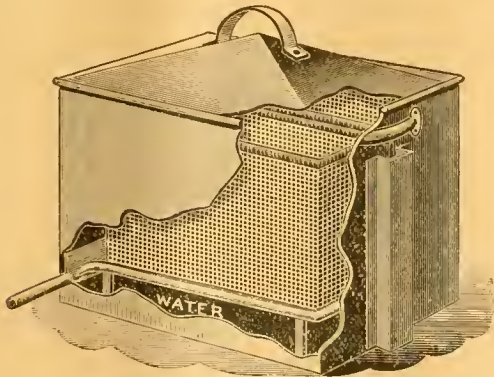

The Ferris Wax-Extractor.

possible to melt old combs, but the pollen and cocoons will absorb most of the wax.

Steam is the only practical agent that will do the work, as it condenses more or less and penetrates every portion of the cell structure, replacing the wax by water. The Ferris' wax-extractor, as shown herewith, is so constructed that there is no danger of burning the wax or refuse, as the direct heat from the stove comes in contact with the water, and as long as the water supply is kept up, there is no danger in any form. These extractors are made with one, two and three baskets, and the baskets are to be filled by putting five or six Langstroth frames of comb, or any similar size frame, into them without any cutting out, and no loss of wax by bits adhering to the frames. Those whose bees have foul brood, and wish to preserve their frames, will find this method effective, as the steam will kill the germs, and the frames can be preserved.

In using, as soon as one nest of combs is melted out, another should be put in, pressing down firmly as long as the top can be put on. When the refuse accumulates to such an extent as to hinder in putting on the top, shovel with a ladle from one basket to another until one is quite empty, which continue to fill as before. The basket of refuse should be

stirred up occasionally so that the steam can get in its work to get the best results.

Old combs containing candied honey can be rendered, and the honey all saved and fed back to the bees, or otherwise disposed of, as the honey and wax run out together and separate in cooling. Honey from cappings also can all be saved, and in this way save many times the cost of the extractor.

I claim for this extractor that it will practically get all the wax from old combs, and that, as the wax does not come in direct contact with the dry heat, the wax is of a superior quality; that there is no remelting of the wax to make it salable; that it will, in the saving of wax and honey, prove itself invaluable to bee-keepers; also, with the new improved arrangement, the steam and bad odors are drawn off in the stove and up the chimney, making it so that the heretofore disagreeable task of making wax can be done in the parlor without any muss or unpleasantness.

CONVENTION PROCEEDINGS

Cortland Co., N. Y., Bee-Keepers' Convention.

The regular spring meeting of the Cortland County Bee-Keepers' Association was held at the home of Miles Morton, in Groton. Early in the day the beautiful home of our host began to fill with the families of the bee-keepers from far and near, while the bee-keepers themselves were to be found in the workshop, honey-house and apiary, all eagerly examining and praising the products of Mr. Morton's skill. Soon came the welcome call to dinner, which proved the old saying, "All the bee-keepers' wives are good cooks." That the dinner was a merry one goes without saying, for were not some of the best story-tellers in the Association located near the center of the long table?

After the last story and the last sigh of contentment over the departed dinner, the formal meeting was called to order by the President, M. R. Wood. One of the regular features is an address by the President. In the course of his remarks, he said that one of the things which was astonishing even to the old bee-keepers, is the sight of Mr. Morton opening hive after hive without the use of a veil, while a dense circle of spectators stood about, and no one was stung. It seemed as if the bees must know of his love for them, and repay it in kind. He closed by quoting the words of Mr. W. L. Cogshall, who said, "I am glad to come to the Association; I can make more gleanings from others here than I can working with my bees."

The question-box proved to contain several questions of interest.

HOW TO TRANSFER BEES.

Mr. Cogshall preferred to cut out the combs during apple bloom. If he could not do it then, he would use the Heddon method.

Another method named was to drum the bees into an empty hive, then place the brood above with a queen-excluder between, taking it off after the worker-brood had all hatched.

DIFFERENCE AND AVERAGE OF COLONIES.

"Why will one colony do better than another equally strong?"

It was thought to be on account of their getting a "run"

in some special direction, or on some special field, which the other did not find.

In the discussion of the question, "How much will a colony average?" the best yield reported was 200 pounds per colony, in 1881.

Mr. Miles Morton had had workers live eight months from August.

The colonies represented by the Association were 1,941; the average loss in wintering, 12½ per cent. The bees were generally reported in fair condition.

A resolution of thanks was given to Mr. and Mrs. Morton for the splendid way in which they had entertained the convention, after which the meeting adjourned, subject to the call of the Secretary.

HARRY L. HOWE, Sec.

Questions AND Answers

CONDUCTED BY

DR. C. C. MILLER, MARENGO, ILL.

[Questions may be mailed to the Bee Journal, or to Dr. Miller direct.]

Getting Queens Fertilized.

I have a colony of bees that is rearing queens now. They commenced the queen-cells July 14. I would like to know the best way to get them fertilized. W. S. G.
Verona, Ont., July 16.

ANSWER.—Don't give yourself the least uneasiness about your queens being fertilized. Unless there's something extremely unusual about your surroundings, you furnish the queens and the bees will do the rest. For wherever there are bees to rear queen-cells, there will be found drones to meet the queens. But you may do something toward getting your queens mated to drones of good blood by keeping down as much as possible all drones except from one or more of your best colonies, of course not having the queens and drones reared in the same colony. Cut out drone-comb wherever you don't want drones, and put patches of worker-comb in place of the drone-comb. The plan of G. M. Doolittle is to leave a small patch of drone-comb in each hive, not more than three or four square inches, and that will satisfy the bees so they'll not be building a few drone-cells in every available corner. Having the drone-comb in one spot, you can always know just where to look for it, and once in three weeks you can shave off the heads of the drones in their cells.

Stopping Bees from Robbing.

What can I do when bees are robbing each other? I have tried Mr. Root's plan; I have shnt them up and put them down cellar, but when they get out they go at it again. H. R.

ANSWER.—Prevention is much easier than cure. Keep all colonies so strong that robbers cannot easily get a start. One very important factor in the way of prevention of robbing is to have a good laying queen in each colony. With such a queen a very weak nucleus can defend itself, especially if you do your part toward making defense easy. Don't have entrances too large for nuclei. If the nucleus occupies one-half of the hive, don't have the entrance directly into the part occupied by the bees, but have the direct entrance to the bees closed, a division-board toward the middle, and the entrance into the empty part. A robber doesn't like the idea of trav-

ersing that dark space, but wants to get directly in to the honey. But when by any means robbing has actually begun, then you must be prompt in action, if action is to be taken at all. For in many cases it may be just as well if you never find out any robbing is going on until all the honey is robbed out. If robbers get at a weak, queenless nucleus, perhaps infested with laying workers, there's hardly any better thing than just to let them alone. Whatever you do, don't take away the hive without leaving anything in its place. For in that case the robbers will immediately pounce upon the nearest hive or hives, and it will need a strong colony to stop them after they have once got fairly started on a defenceless colony. So when you take away a hive, if you think best to do so, put in its place another hive of the same appearance. Put in it some scraps of honey for the bees to work on, and as soon as they finish what honey is present, they'll stop without making any strong attempt on neighboring colonies.

If robbing has commenced on a colony that is weak but has a good queen, you may often stop it by making the matter of entrance too difficult. Pile straw or hay all around the hive loosely, making the straw come up to the top of the hive. Now keep the straw thoroughly drenched with water. It will be too much for the robbers, although the bees of the colony will work their way through. If the colony is queenless, the straw may help out, providing a queen is at the same time given. Possibly the giving a frame of brood would help, if no queen can be given.

Who Can Help Him Out?

A swarm of bees issued three weeks ago, or on the 4th of July. This colony did very well in all ways, but the pupæ, when nearly fully formed, die in the cell. The appearance of these is snow-white, with dark streaks where the eyes form, and in from one to three days the pupæ gradually dry up, but do not change in color, and when about the size of a common fly they are removed by the bees. There are no sunken cells, no putrid odor, and no dark, stringy matter, such as described by Root under "Foul Brood." About one-half of the cells are entirely uncapped, and affected in this way; the balance seem all right, and the young bees are coming all right. Please give the cause, or disease, and treatment. P. H. S.
Lanark, Ill., July 28.

ANSWER.—I'm sorry to say I can't give the least bit of light. Who can help us out?

Comb Leveler—Bee Journal Index—Rietsche Foundation Press.

1. Can you give us some idea as to what sort of a device, tool or instrument, B. Taylor's "comb leveler" is? How is it manipulated?

2. And would you mind suggesting to Editor York that he give us an index every half year, instead of at the end of every year? Like many others, I bind my American Bee Journal in half-yearly volumes, and having only one index to the two volumes is very inconvenient. And while I am about it I would take the liberty of suggesting another change—next year—in the size of the American Bee Journal. Formerly it was too small; its present shape is a very convenient one—as a paper; but it makes an awkward sized volume when bound. I should like to see it uniform with Gleanings, and this I think would be found to be the happy medium, and form a very handy volume when bound. But by all means let every half-yearly volume have its index. And if I may venture the remark without giving our worthy editor offence, there's some little room for improvement in the indexing. We frequently want to refer to back numbers in a hurry, as I did the other day. I was being troubled with moths in empty combs, and I knew there was a *brine* remedy somewhere in the 1895 volume, but the index did not help me. After many hours' hunt, I found it *under* Mr. Golden's name, and if I didn't bless the man who compiled that index! On page 147 (1895), fourth paragraph from the bottom, is a good plan for uniting, but being a portion of an article on different matters, it does not

appear in the index. I trust Editor York won't take this, or any other suggestion, amiss.

3. More information is greatly needed regarding the Rietsche press. Can you help? If I could only get the maker's address, I would not trouble you. It is frequently alluded to in praiseworthy terms in the American Bee Journal—"7,000 in use in Germany," etc., but we can get no details as to the price, *modus operandi*, maker's address, or anything else. Is information withheld in the interests of the big foundation manufacturers? Hardly.

SOUTH AFRICA.

ANSWERS.—1. B. Taylor's "Handy comb leveler" is what its name implies, and is excellent for its purpose. It is made of tin, placed over a lamp, and a sort of tin box is just large enough to let a section slip down over it; the hot tin surface rapidly melts away the comb until a stop stops the wood of the section from going further down. The stop is adjustable, so it can be made to level off a very small part of the surface,

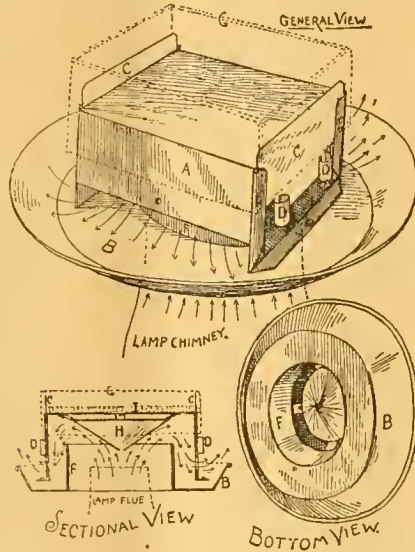

The Taylor "Handy Comb Leveler."

or to melt it down to the septum. A receptacle catches the melted wax, and when sufficient has accumulated it is poured off. It's a fine implement.

2. As to the size of the paper and its index, that's for the editor and publishers. Having had quite a little experience, however, myself in the matter of indexing, I may be allowed to say that it's a very easy thing to find failures in indexes, but an exceedingly difficult thing to avoid all failures. I know it's very tantalizing to remember there's something you want to look at again, and to find no hint of it in the index, but just try making an index and see if you don't omit a good deal more. Especially when things are as much mixed up as they sometimes are, where "size of journal" and "indexing" may be found under the head of "comb leveler."

It is possible that all would not be agreed as to the best size of the Bee Journal. And if it's of good size for reading when unbound, why isn't it as good when bound? The change in size involves trouble and expense. The Ladies' Home Journal—one of the most popular and largely circulated papers in the world—clings to its old and objectionable size of about 16x12 inches just because of the trouble and expense of changing. And when less than two cents is charged for a single number of such a paper as the American Bee Journal, perhaps we ought to be slow about asking expensive changes.—[We might say for "S. D.'s" information, that the American Bee Journal for 1895 consisted of only one volume of 52 numbers. It seems he did not notice that. Of course, the index would appear at the end of the volume, and not in the middle. It is an exceedingly difficult matter to get up an errorless index. We have been at it for 12 years, but never

expect to attain perfection in that line. We are always thankful that it has not more mistakes. Oh, yes, it's just lots of fun to make three indexes of over 800 pages of matter, and get *everything* straight! We have been all through that many times. There ought to be room enough in South Africa for a paper the size of the Bee Journal. Which would you prefer, 16 pages the present size of the Bee Journal, or 16 pages the size of Gleanings, for \$1.00? To print 32 pages the size of Gleanings, would cost double for presswork, binding, etc. Please remember that it doesn't pay to double up much on expenses when it comes to a *weekly* paper—unless the subscription price is also doubled.—EDITOR.]

3. B. Rietsche, Biberach, Baden, Germany, is the manufacturer of the Rietsche press. Just now I don't know where to turn for price, but I think it is less than \$10. Did you ever see waffles baked? Well, the Rietsche press works somewhat like waffle-irons. The two parts of the press are hinged together, melted wax is poured into the lower half, the upper half is shut down upon it, and the wax is thus pressed into foundation without any sheeting. I don't think information has been withheld with any wrong motives, and indeed all the information has been given that has been asked for, and more, too. So far as I know, no one has ever tried the Rietsche press in England, and only one press has ever been tried in this country. The A. I. Root Co. got one, but it seemed too slow work for them to think it worth while to attempt its introduction. While I give them credit for good intention in the matter, I think it possible that the small bee-keeper, in some cases at least, might be pleased with the Rietsche press. It may be well to mention, however, that one condition in Germany makes quite a difference: Adulteration affects foundation there, so that complaint is made of the difficulty of getting foundation made of pure wax, and if a bee-keeper wants to make sure of having the unadulterated article he can do so by having a Rietsche press. On the other hand, in this country, adulteration in foundation is practically unknown, and foundation can be bought cheaper than the bee-keeper can make it for himself, and of better quality.

An Experience with a Swarm.

I had a swarm come off July 10, I caught the queen and clipped her, and found she was not mated. The third day she came out and tried to fly, but could not; what became of her I can't tell, but in a couple of days I looked for her and could not find any queen. So I sent for a queen, but they would not accept her—they killed her. Then I sent for another, with the same result as the first. Then in a few days they commenced making queen-cells; they made three, which hatched, and they killed the queens; now they have three more capped. I want to know where they get the eggs to rear the queens, for they have no eggs whatever. Also, what is the cause of their killing the queens? They are a strong colony, but are dwindling away slowly now. J. D. L.

ANSWER.—Quite likely the virgin queen that you clipped was still in the hive when the bees killed the queens you gave them. It's no proof there was no queen in the hive because you could not find her. The most expert bee-keeper is often baffled in searching for a virgin queen. The eggs found may be the work of laying workers, or it is possible the virgin queen may have laid a few eggs. In either case, the result would be a failure, as nothing but drones could come of such eggs. If you had given the colony a frame of unsealed brood, or rather a frame of brood having in it some eggs or very young larvæ, they would then have reared a young queen from the brood given. It's not a bad plan to give unsealed brood in all cases to a colony whose queen is not yet laying. If the queen is all right they needn't start any cells, and if they are queenless it gives them a chance to supply the deficiency. It is also thought that the presence of a frame of brood helps to hurry up a young queen to lay.

OLDEST BEE PAPER IN AMERICA ESTABLISHED IN 1861

THE AMERICAN BEE JOURNAL

GEORGE W. YORK, Editor.

PUBLISHED WEEKLY BY

GEORGE W. YORK & COMPANY,

118 Michigan St., CHICAGO, ILL.

\$1.00 a Year—Sample Copy Sent Free.

[Entered at the Post-Office at Chicago as Second-Class Mail-Matter.]

Vol. XXXVI. CHICAGO, ILL., AUG. 13, 1896. No. 33.

EDITORIAL COMMENT

The Honey Season of 1896 has been an exceptionally good one in the greater part of the United States and Canada, if we may judge by what reports have come in from bee-keepers. Under the heading—"A Queer but a Good Season"—Gleanings had this to say in its issue for Aug. 1:

The season is peculiar in several respects. To begin with, every thing started out much earlier than usual. Fruit-bloom showed up quite perceptibly in the brood-nests—something it has not done for some years. Basswood came on almost a month earlier, with great promise. It did, in fact, begin to yield nectar before white clover (it usually follows); but the quantity of blossoms was a very imperfect index of the amount of honey. Then we waited for white clover; but instead of honey from that source, there was a fair flow from sweet clover. Now, that this is going to seed, white clover near the latter part of this month (a month late), owing to these copious rains, is beginning to show itself everywhere. Honey is coming in again, and being stored. How long this will last, or what we may expect next in this season of contraries, it is hard to say. During this month we have drouths, as a rule; but now the ground is as wet and soaked as in the spring. The roads are muddy, and the bicycle is at a standstill. This is almost unheard of in Rootville during summer.

We think there'll be no trouble on the part of bee-keepers to stand a few such "queer" seasons if they'll only prove to be "good" ones. Most of them can put up with the unusualness of a season, if only the same unusualness will also be found in the honey crop—*unusually large*, preferred, of course!

The Lincoln Convention, to be held Oct. 7 and 8, promises to be a good one, if we may judge from the program the Secretary, Dr. Mason, is building. It won't need much "doctoring" when he gets through with it. If all respond, as indicated by the list of papers arranged for, it will be worth going a good ways to see and hear. Better lay your plans to be there. Let's simply astound the Nebraska people with numbers. We'd like to see the Lincoln affair out-number the World's Fair convention. We hope it will, for we believe it is to be the most important meeting held by the bee-keepers of this country in a long time. We expect to see something done "along the line" of improving the organization, that will be of great value to every bee-keeper in the land. Be present yourself, and "have a hand" in the thing.

See "Bee-Keeper's Guide" offer on page 527.

Scarlet or Crimson Clover.—The following we take from one of the best seed catalogs issued:

SCARLET OR CRIMSON CLOVER (*Trifolium incarnatum*).—This is most valuable crop for green manuring, soiling, hay, pasture and silage. It is purely an annual, and must be sown every year. It will make a good growth on land which is too poor and sandy to grow red clover or any grasses at all, and will make an enormous growth on good land. It will improve worn out and poor soils more rapidly and permanently than any other plant in existence; therefore, the cheapest and best fertilizer, also the cheapest food for all kinds of stock. Its use solves a great problem in economical farming. It grows and matures its crop when other crops are dormant, furnishing the very best of feed, and still permanently improving the soil. Being a winter crop it should be sown in August and September, from which the spring following it can be cut for soiling early in the season, from the middle of April to the middle of May; for ensilage and hay from first to last of May, and for seed crop early in June. It will produce on ordinary soil eight to ten tons of green food per acre, one-half to two and a half tons of hay per acre; plowed under as a manural crop it is worth as a fertilizer \$24 per acre. Experiments at the Delaware Experiment Station have shown that \$1.00 invested in seed per acre added 24 bushels of corn, while \$1.00 worth of nitrate soda per acre increased the yield of corn only six bushels. It can be sown in fields of growing corn, in open ground after some other crop is harvested, in apple, peach, pear, plum and cherry orchards, in vineyards, also with buckwheat, to keep down weeds and to be plowed under as manure, also for binding drift soils and for preventing washing on hillsides, with most excellent results; can be pastured some in early spring without injury to either hay or seed crop. Ten to fifteen pounds are necessary to seed an acre properly, and after sowing the seed it should be covered by a light harrowing.

Crimson clover is considered by some as a very fine honey-plant, as are all the clovers. It may require some careful experimenting before it becomes a complete success in far northern latitudes, but the attempt will have been worth making, if it should succeed. Try it on a small scale first.

LATER.—In Gleanings for Aug. 1, we find the following about crimson clover:

Some readers may have wondered why The Rural New-Yorker stands by crimson clover in the face of so many reports of partial or complete failures. One reason is that we have often observed the marvelous ability of this plant to stool or spread out when once started in the spring. We have seen half a dozen fields that seemed, on April 1, to be entirely killed out, start suddenly into such a rapid growth that, by the middle of May, the ground was well covered. Last week, Mr. L. D. Gale, of Chautauqua County, N. Y., made a quite unfavorable report as to crimson clover. Here is his final report, which we print here in full, as it is in line with the position The Rural has often taken:

"I must admit that a few straggling crimson-clover plants will make a wonderful showing if left to do their best. They can spread out equal to a bantam hen on a sitting of eggs. Where I thought there was scarcely any left, the ground is covered. It is a surprise to every one seeing the field, to know where the clover came from. May 16 I hitched up the horse and drove over to the field with Mrs. Gale; she thought the blossoms so handsome that they would add beauty to the bouquet, so we gathered some and put them with other flowers. What was our surprise to find, in four or five days, that the clover had grown so as almost to hide the other flowers! Very few honey-bees were seen at this time. A fine rain had come on the Monday following (it had been rather too dry here). I did not see the field again until May 21, five days later, when I went to the field to plow it. I was surprised again; some of it was so thick and heavy that it bothered me to turn it under. The blossoms were alive with bees, and I almost believe that the whole working force of my 100 colonies of bees were upon the field; they fairly tumbled over each other. I never saw them thicker upon basswood bloom. After going a few times around, I stopped the teams, went to the apiary, and found the bees capping the section honey. I put the teams at work in another field; and as long as it yields honey at that rate, it can stand there. I think the rain caused the flow of honey. The medium clover is keeping up. I feel certain that, where crimson has proved a failure, the medium will be a success. I do not intend to have any more bare floor in my cornfield when I can carpet them so cheaply with

clover. I shall give my preference to the red clovers—crimson second place."

The above was printed in *The Rural New-Yorker* for June 6, 1896, to which that paper adds this sentence: "Our opinion is that some of our friends who plowed up the clover in disgust, a month ago, would have had a similar statement to make if they had let it alone."

Crimson clover is a success in Indiana also, as shown by this letter, which also appeared in *Gleanings*, with Mr. Root's comments following it:

We can grow the choicest crimson clover in Indiana. September 18, 1895, I sowed a small patch 10x3½ rods. I pastured it when it was 6 inches high, and kept it pastured down all the fall and this spring, and then left it for seed. I got 1¼ bushels of seed, and the ground is a perfect mat today, without plowing or harrowing, and, oh, how the bees work on it! They just hum from morning till night. It was in bloom 17 days. I had 9 colonies, spring count; now 14, and about 75 pounds of honey, while most of them around here have nothing.

SAMUEL RICKEL.

Fulton, Ind., July 20.

The above certainly gives encouragement for sowing this plant later than we had supposed advisable. If it was pastured down during both fall and spring, then the report is still more astonishing. I cannot make out whether the abundant rain caused the old stalks to send up another growth after the seed was cut and sown, or whether the seed rattled off enough to make the lot green again by the 20th of July, the day on which the letter was written.

While on the subject of crimson clover, permit me to call attention to a bulletin issued by the United States Department of Agriculture. This utters a warning to farmers and others, that it is unsafe to feed crimson clover to horses after the blossoms are matured; and still more unsafe to let them have access to the crimson-clover straw from which the seed has been thrashed. Quite a number of valuable horses have been killed by the formation of balls in the intestines. These balls proved to be made up of hairs or spines of the head of the mature plant of the clover. Where hay properly made by cutting the clover when it is just in full bloom (not later) is fed to horses, no harm results. It is only necessary to beware of letting them get hold of the over-ripe plant, either before or after the seed has been thrashed out.

Minnesota State Fair, Etc.—Minnesota will be "at home" to all the people of her sister States during the week commencing Monday, Aug. 31, and ending Saturday, Sept. 5. During this time, the National Encampment of the Grand Army of the Republic will occur in St. Paul, an Encampment of the Knights of Pythias will be held in Minneapolis, and upon the grounds of the State Agricultural Society, midway between these cities, the State Fair will provide entertainment for everybody. Low passenger rates, available for every one, are announced upon all railways, and the number of visitors is expected to be very large. For this reason the scope of the Fair is being materially widened. Not only will the products of Minnesota be lavishly displayed, but Washington, Oregon, Idaho, Montana and the Dakotas will make comprehensive exhibits of their agricultural, forestry and mineral wealth as well. Visitors will be richly entertained, and will find spread out before them for inspection there, sources of this wonderful section of the country.

Dark Honey and Home Market.—The California "Skylark"—who "picks" things "by the way," for *Gleanings*—has several "picks" at us in the last number of that paper. One is in reference to this sentence of ours, which appeared in the *Bee Journal* some time ago:

"If at all possible, dispose of all dark grades of honey in the home market."

Now, we are willing to leave it to any sensible city commission man, if our advice wasn't good, though Skylark seems to enjoy poking fun at it. When in nearly all the markets white honey, both comb and extracted, is slow sale, it is almost impossible to dispose of dark grades at all. But in the home

market many customers will just as soon have the dark as the white honey, and, in fact, some prefer it. Especially comb honey is sold upon its appearance, in cities, and the whiter and neater the better; but dark *comb* honey (which we had more in mind at the time of writing the above quoted sentence) often must go a-begging for buyers, and sometimes finds it a hopeless task.

We see no reason to change our former advice.

"By the way," may be Skylark's honey is *all* dark, hence his "pick." Very likely so "dark" this year that he can't see any of it at all!

PERSONAL MENTION.

MR. ALLEN PPINGLE, we have just learned (Aug. 5), passed away July 22nd. We received the following letter from his daughter, who affectionately tells of the circumstances attending her father's unexpected death:

SELBY, Ont., Canada, Aug. 1, 1896.

DEAR MR. YORK.—I received to-night a list of queries addressed to father, showing me that you have not yet heard of the terrible, terrible loss my mother and myself have sustained by the death of my dear father. Oh, Mr. York, it all seems a terrible dream; it seems that I must awaken and find dear father with us as of old. When I see his letters and papers and all the work he had to do, and was so interested in, I cannot realize that he is gone, gone. Oh, what a dreary world this is when Death steps in and snatches from us a beloved one.

Father had not a strong constitution, and although he took remarkable care of himself, he was too energetic, too ambitious, for his strength. Night and day he toiled, sitting up till 12, 1 and 2 o'clock, many and many a night—writing on some important question of the day.

About two months ago father had a severe attack of the grippe—it affected his eyes so that he was nearly blind for about two weeks. When recovering he would go out and work in the bee-yard as he felt able, but was overcome with the heat, and then the same old trouble—couldn't eat. He could not take any nourishment, excepting half a teaspoonful of the thinnest gruel every other day or so. Of course he became very weak, and was taken to his bed on July 10. The following week he seemed about the same, so mother and I did not think seriously of his case, because he had been subject to them for the past four or five years, ever since he had the sunstroke, and had always treated himself successfully. On Monday, July 20, he was taken with cramps, and suffered dreadfully. Tuesday he was easier, and we hoped there was a change for the better, but Wednesday he was not so well, and in the afternoon, at 1:30 o'clock, he passed away as peacefully as a little child going to sleep.

It is a terrible blow for mother and me—there were just the three of us—and father had worked so hard, and was just getting things in a shape so he could take it easier. But Death claimed him early, he being but 55 years old. Hard as it is, I shall try to take comfort in doing the work and business which has fallen upon me, in such a manner as I think would have met the approval of my dear father.

Yours sincerely, GRACE PRINGLE.

Realizing the emptiness of mere words at such a time as this, we feel that we can only extend to the bereaved ones our sympathy, and assure them they have that of the whole bee-keeping fraternity, of which Mr. Pringle was an honored and helpful member.

In a near issue of the *Bee Journal* we hope to have something in regard to Mr. Pringle's life and labors, particularly in the line of apiculture.

EDITOR HUTCHINSON, of the *Review*, will tell "How to Secure Comb Honey," at the Lincoln convention.

BEE-BOOKS

SENT POSTPAID BY

George W. York & Co.,
Chicago, Ills.

Bees and Honey, or Management of an Apiary for Pleasure and Profit, by Thomas G. Newman.—This edition has been largely re-written, thoroughly revised, and is "fully up with the times" in all the improvements and inventions in this rapidly-developing pursuit, and presents the apiarist with everything that can aid in the successful management of an apiary, and at the same time produce the most honey in an attractive condition. It contains 250 pages, and 245 illustrations—is beautifully printed in the highest style of the art, and bound in cloth, gold-lettered. Price, \$1.00.

Langstroth on the Honey-Bee, revised by Dadant.—This classic in bee-culture, has been entirely re-written, and is fully illustrated. It treats of everything relating to bees and bee-keeping. No apiarian library is complete without this standard work by Rev. L. L. Langstroth—the Father of American Bee-Culture. It has 520 pages; bound in cloth.

Price, postpaid, \$1.25.

Bee-Keepers' Guide, or Manual of the Apiary, by Prof. A. J. Cook, of the Michigan Agricultural College.—This book is not only instructive and helpful as a guide in bee-keeping, but is interesting and thoroughly practical and scientific. It contains a full delineation of the anatomy and physiology of bees. 400 pages; bound in cloth and fully illustrated.

Price, postpaid, \$1.25.

Scientific Queen-Rearing, as Practically Applied, by G. M. Doolittle.—A method by which the very best of Queen-Bees are reared in perfect accord with Nature's way. 175 pages, bound in cloth, and illustrated. Price, \$1.00.

A B C of Bee-Culture, by A. I. Root.—A cyclopaedia of 400 pages, describing everything pertaining to the care of the honey-bees. It contains 300 engravings. It was written especially for beginners. Bound in cloth. Price, \$1.25.

Advanced Bee-Culture, Its Methods and Management, by W. Z. Hutchinson.—The author of this work is too well known to need further description of his book. He is a practical and entertaining writer. You should read his book. 90 pages, bound in paper, and illustrated. Price, 50 cts.

Rational Bee-Keeping, by Dr. John Dzierzon.—This is a translation of his latest German book on bee-culture. It has 350 pages; bound in cloth, \$1.25; in paper covers, \$1.00.

Biene-Kultur, by Thomas G. Newman.—This is a German translation of the principal portion of the book called BEES OF HONEY. 102 page pamphlet. Price, 40 cts.

Convention Hand-Book, for Bee-Keepers, by Thomas G. Newman.—It contains the parliamentary law and rules of order for Bee-Conventions—also Constitution and By-Laws, with subjects for discussion, etc. Cloth, gold-lettered. Price, 25 cts.

Amerikanische Bienenzucht, by Hans Buschbauer.—Printed in German. A hand-book on bee-keeping, giving the methods in use by the best American and German apiarists. Illustrated; 138 pages. Price, \$1.00.

Thirty Years Among the Bees, by Henry Alley.—Gives the results of over a quarter-century's experience in rearing queen-bees. Very latest work of the kind. Nearly 100 pages. Price, 50c.

Why Eat Honey?—This Leaflet is intended for FREE distribution, to create a Local Market. 100 copies, by mail, 40 cts.; 500 for \$1.50; 1000, \$2.50. If 500 or more are ordered at one time, your name and address will be printed on them FREE.

How to Keep Honey and preserve its richness and flavor. Price same as Why Eat Honey.

Apiary Register, by Thos. G. Newman.—Devotes two pages to a colony. Leather binding. Price, for 50 colonies, \$1.00; for 100 colonies, \$1.25.

Preparation of Honey for the Market, including the production and care of comb and extracted honey. A chapter from BEES AND HONEY. Price, 10 cents.

Bee-Pasturage a Necessity.—This book suggests what and how to plant. It is a chapter from BEES AND HONEY. Price, 10 cents.

The Hive I Use, by G. M. Doolittle. It details his management of bees, and methods of producing comb honey. Price, 5 cents.

Dr. Howard's Book on Foul Brood.—Gives the McEvoy Treatment and reviews the experiments of others. Price, 25 cts.

Dictionary of Apiculture, by Prof. John Phin. Gives the correct meaning of nearly 500 apicultural terms. Price, 50 cts.

Winter Problem in Bee-Keeping, by G. R. Pierce. Result of 25 years' experience. 50 cts.

Handling Bees, by Chas. Dadant & Son.—A Chapter from Langstroth Revised. Price, 8 cts.

Bee-Keepers' Directory, by H. Alley.—Latest methods in Queen-Rearing, etc. Price, 50c.

Foul Brood Treatment, by Prof. F. R. Cheshire.—Its Cause and Prevention. Price, 10 cts.

Foul Brood, by A. R. Kohnke.—Origin, Development and Cure. Price, 25 cts.

History of Bee-Associations, and Brief Reports of the first 20 conventions. Price, 15 cts.

Honey as Food and Medicine, by T. G. Newman.—A 32-page pamphlet: just the thing to create a demand for honey at home. Should be scattered freely. Contains recipes for Honey-Cakes, Cookies, Puddings, Foam, Wines, and uses of honey for medicine.

Prices, prepaid—Single copy, 5 cts.; 10 copies, 35 cts.; 50 for \$1.50; 100 for \$2.50; 250 for \$5.50; 500 for \$10.00; or 1000 for \$15.00.

When 250 or more are ordered, we will print the bee-keeper's card (free of cost) on the front cover page.

Bee-Keeping for Profit, by Dr. G. L. Tinker.—Revised and enlarged. It details the author's "new system, or how to get the largest yields of comb or extracted honey." 80 p.; illustrated. 25c.

Emerson Binders, made especially for the BEE JOURNAL, are convenient for preserving each number as fast as received. Not mailable to Canada. Price, 75 cts.

Commercial Calculator, by C. Ropp.—A ready Calculator, Business Arithmetic and Account-Book combined in one. Every farmer and business man should have it. No. 1, bound in water proof leatherette, calf finish. Price, 40 cts. No. 2, in fine artificial leather, with pocket, silicate slate, and account-book. Price, 60 cts.

Green's Four Books, by Chas. A. Green.—Devoted to, 1st, How We Made the Old Farm Pay; 2nd, Peach Culture; 3rd, How to Propagate Fruit-Plants, Vines and Trees; 4th, General Fruit Instructor. Nearly 120 pages. Fully illustrated. 25 cts.

Green's Six Books on Fruit-Culture, by Chas. A. Green.—Devoted 1st, to Apple and Pear Culture; 2nd, Plum and Cherry Culture; 3rd, Raspberry and Blackberry Culture; 4th, Grape Culture; 5th, Strawberry Culture. 129 pp.; illustrated. 25 cts.

Garden and Orchard, by Chas. A. Green.—Gives full instructions in Thinning and Marketing Fruits; Pruning, Planting and Cultivating; Spraying, Evaporation, Cold Storage, Etc. 94 pages, illustrated. Price, 25 cts.

Kendall's Horse-Book.—35 pictures, showing positions of sick horses, and treats on all their diseases. English or German. Price, 25 cts.

Silo and Silage, by Prof. A. J. Cook.—It gives the method in operation at the Michigan Agricultural College. Price, 25 cts.

Lumber and Log-Book.—Gives measurements of lumber, logs, planks; wages, etc. 25c.

Maple Sugar and the Sugar Bush, by Prof. A. J. Cook.—Full instructions. Price, 35 cts.

Grain Tables, for casting up the price of grain, produce, hay, etc. Price, 25 cts.

Caponis and Caponizing, by Dr. Sawyer, Fanny Field, and others.—Illustrated. All about caponizing fowls, and thus how to make the most money in poultry-raising. 64 pages. Price, 30 cts.

Our Poultry Doctor, or Health in the Poultry Yard and How to Cure Sick Fowls, by Fanny Field.—Everything about Poultry Diseases and their Cure. 64 pages. Price, 30 cts.

Poultry for Market and Poultry for Profit, by Fanny Field.—Tells everything about the Poultry Business. 64 pages. Price, 25 cts.

Turkeys for Market and Turkeys for Profit, by Fanny Field.—All about Turkey-Raising. 64 pages. Price, 25 cts.

Rural Life.—Bees, Poultry, Fruits, Vegetables, and Household Matters. 100 pages. 25 cts.

Potato Culture, by T. B. Terry.—It tells how to grow them profitably. Price, 40 cts.

Hand-Book of Health, by Dr. Foote.—Hints about eating, drinking, etc. Price, 25 cts.

Alsike Clover Leaflet.—Full directions for growing. 50 for 25 cts.; 100 for 40 cts.; 200, 70c.

Book Clubbing Offers.

(Read Carefully.)

The following clubbing prices include the American Bee Journal one year with each book named. Remember, that only ONE book

can be taken in each case with the Bee Journal a year at the prices named. If more books are wanted, see postpaid prices given with the description of the books on this page. Following is the clubbing-list:

1. Langstroth on the Honey-Bee.....	\$2.00
2. A B C of Bee-Culture.....	2.00
3. Bee-Keeper's Guide.....	1.75
4. Bees and Honey [Cloth bound].....	1.65
5. Scientific Queen-Rearing.....	1.75
6. Dr. Howard's Foul Brood Book.....	1.10
7. Advanced Bee-Culture.....	1.30
8. Amerikanische Bienenzucht [Germ.].....	1.75
9. Biene-Kultur [German].....	1.25
10. Rational Bee-Keeping [Cloth bound].....	2.00
11. Rational Bee-Keeping [Paper bound].....	1.75
12. Thirty Years Among the Bees.....	1.30
13. Bee-Keeping for Profit.....	1.15
14. Convention Hand-Book.....	1.15
15. Poultry for Market and Profit.....	1.10
16. Turkeys for Market and Profit.....	1.10
17. Capons and Caponizing.....	1.10
18. Our Poultry Doctor.....	1.10
19. Green's Four Books.....	1.15
20. Green's Six Books on Fruit-Culture.....	1.15
21. Garden and Orchard.....	1.15
22. Rural Life.....	1.10
23. Emerson Binder for the Bee Journal.....	1.60
24. Commercial Calculator, No. 1.....	1.25
25. Commercial Calculator, No. 2.....	1.40
26. Kendall's Horse-Book.....	1.10
27. Strawberry Culture.....	1.20
28. Potato Culture.....	1.20
29. Hand-Book of Health.....	1.10
30. Dictionary of Apiculture.....	1.35
31. Maple Sugar and the Sugar Bush.....	1.20
32. Silo and Silage.....	1.10
33. Winter Problem in Bee-Keeping.....	1.30
34. Apiary Register (for 50 colonies).....	1.75
35. Apiary Register (for 100 colonies).....	2.00
36. Bee-Keepers' Directory.....	1.30

Convention Notices.

TEXAS.—The third annual convention of the Southwest Texas Bee-Keepers' Association will be held at Beville, Tex., on Sept. 16 and 17, 1896. All are invited. No hotel bills to pay. Low rates on railroads.
Beville, Tex. J. O. GRIMSLEY, Sec.

MINNESOTA.—The annual meeting of the Northern Minnesota Bee-Keepers' Association will be held in Winona, on September 24 and 25, 1896, at 9 o'clock, a.m. All that feel in any way interested in bees or honey are cordially invited to attend.
Winona, Minn. E. C. CORNWELL, Sec.

ILLINOIS.—The annual meeting of the Northern Illinois Bee-Keepers' Association will be held at the residence of B. Kennedy, 3 miles northeast of New Milford, Ill., on Tuesday, Aug. 18, 1896. All are cordially invited, and I will meet any one at the train in New Milford if they will drop me a card.
New Milford, Ill. B. KENNEDY, Sec.

Doolittle's Book—Have You Read It?

Queens and Queen-Rearing.—If you want to know how to have queens fertilized in upper stories while the old queen is still laying below; how you may safely introduce any queen, at any time of the year when bees can fly; all about the different races of bees; all about shipping queens, queen-cages, candy for queen-cages, etc.; all about forming nuclei, multiplying or uniting bees, or weak colonies, etc.; or, in fact, everything about the queen-business which you may want to know—send for Doolittle's "Scientific Queen-Rearing"—a book of over 170 pages, which is as interesting as a story. Here are some good offers of this book:

Bound in cloth, postpaid, \$1.00; or clubbed with the BEE JOURNAL for one year—both for only \$1.75; or given free as a premium for sending us three new subscribers to the BEE JOURNAL for a year at \$1.00 each.

Bee-Keeper's Guide—see page 527.

PLANTS TO BE NAMED.

By DR. H. S. PEPOON,

936 Belleplaine Ave., Station X, Chicago, Ill.

Bush or Rock Honeysuckle.

I send a flower on which my bees work some. It grows in clumps and anywhere from 12 to 15 inches high. It grows on a ledge, and also around some old rotten logs where there was once a mill-yard.

Bradford, Vt., July 11. H. M. H.

ANSWER.—This is a member of the honeysuckle family, having the scientific name *Diervilla trifida*, and known by the common names "bush honeysuckle" or "rock honeysuckle." It has a very near relative in the Weigela, a showy, pink-flowered shrub of our lawns.

Its proper home is in cool, rocky hill-sides, in the shade of larger bushes and trees. It probably has the same honey-producing qualities that the proper honeysuckles (*honeiera*) have, evidenced by their common name.

Woodsage—Sow Thistle.

I send two plants to be named. One is a honey-plant, growing from one to two feet high, with branched stems. The other, some say, is the Canada thistle. It grows about two feet high.

R. T. R.

Sugar Lake, Mo., July 22.

ANSWER.—No. 1, the honey-plant, has the common names of woodsage and American germander (*Teucrium Canadense*), and belongs to the mint family. It grows abundantly in rather low grounds, and remains in bloom for a long time. It is a perennial plant.

No. 2 is not the Canada thistle, but a perfectly harmless member of the same family (composite), and known by the common name of "sow thistle" (*Louhus asper*)—an annual weed of gardens and roadsides.

A Boneset Relative.

I send a sample of a weed which is plentiful in this locality. It is a biennial, blooming but little the first year. Its bloom resembles that of boneset, the stalk is somewhat red, commences blooming about the middle of August, and blooms until frost. It sends up one stalk the first year, but sends up from two to six the next; it branches almost from the ground, and grows from two to five feet high. It is one of the best, if not the best, honey-plants we have some seasons. Bees gather large quantities of very light honey from it—almost white. It will grow on almost any kind of soil. We have it on the roadside, in vacant lots, on pasture-land, and on old, worn-out land, but it grows more profusely on newly-cleared lands. It is called by some "August flower."

Cherry, Ky., July 24. J. C. H.

ANSWER.—This plant is known botanically as *Eupatorium serotinum*, having, so far as I know, no generally prevalent

THE "NOVELTY" POCKET-KNIFE!



Your Name on the Knife.—When ordering, be sure to say just what Name and Address you wish put on the Knife.

The NOVELTY KNIFE is indeed a novelty. The novelty lies in the handle. It is made beautifully of indestructible celluloid, which is as transparent as glass. Underneath the celluloid, on one side of the handle is placed an AMERICAN BEE JOURNAL reminder, and on the other side, name and residence of the Subscriber.

The material entering into this celebrated knife is of the very best quality; the blades are handforged out of the very finest English razor-steel, and we warrant every blade. The bolsters are made of German silver, and will never rust or corrode. The rivets are hardened German silver wire; the linings are plate brass; the back springs of Sheffield spring steel, and the finish of handle as described above. It will last a lifetime, with proper usage.

Why purchase the Novelty Knife? In case a good knife is lost, the chances are, the owner will never recover it; but if the Novelty is lost, having name and address of owner, the finder will return it; otherwise to try to destroy the name and address, would destroy the knife. If traveling, and you meet with a serious accident, and are so fortunate as to have one of the Novelties, your pocket KNIFE will serve as an Identifier; and in case of death, your relatives will at once be apprised of the accident.

How appropriate this knife is for a Christmas, New Year or birthday present! What more lasting memento could a mother give to a son, a wife to a husband, a sister to a brother, a lady to a gentleman, or vice versa, a son to a mother, a husband to a wife, a brother to a sister or a gentleman to a lady—the knife having the name of the recipient on one side?

The accompanying cut gives a faint idea, but cannot fully convey an exact representation of this beautiful knife, as the "Novelty" must be seen to be appreciated.

How to Get this Valuable Knife.—We send it postpaid, for \$1.00, or give it as a Premium to the one sending us three new Subscribers to the BEE JOURNAL (with \$3.00), and we will also send to each new name a copy of the Premium Edition of the book "Bees and Honey." We club the Novelty Knife with the BEE JOURNAL for one year, both for \$1.90.

Any Name and Address Put on the Knife.

GEORGE W. YORK & CO., CHICAGO, ILLS.

Allow about two weeks for your order to be filled.

PATENT WIRED COMB FOUNDATION

Has No Sag in Brood-Frames

Thin Flat-Bottom Foundation

Has No Fishbone in the Surplus Honey.

Being the cleanest is usually worked the quickest of any Foundation made

J. VAN DEUSEN & SONS,

Sole Manufacturers, Sprout Brook Montgomery Co., N. Y.

Mention the American Bee Journal

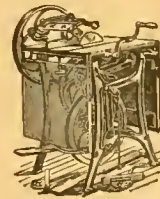

ONE MAN WITH THE UNION COMBINATION SAW

Can do the work of four men using hand tools, in Rippling, Cutting-off, Mitring, Rabbeting, Grooving, Gaining, Dadoling, Edging-up, Jointing Stuff, etc. Full Line of Foot and Hand Power Machinery Sold on Trial. Catalogue Free.

SENECA FALLS MFG. CO.,

46 Water St., SENECA FALLS, N. Y.

1A1y Mention the American Bee Journal.

Dadant's Foundation in Chicago!

No other Goods kept here.

Send for Price-List,

CHAS. DADANT & SON, 118 Michigan St., CHICAGO, ILL.

13A1f Please mention the Bee Journal.

Untested Italian Queens, 75c.

3 FOR \$2.00.

Catalogue of Apiarlan Supplies Free.

I. J. STRINGHAM,

105 Park Place. NEW YORK, N. Y.

APIARY—Glen Cove, L. I.

That Queen-Clipping Device Free!

Works Like a Charm.

The Monette Queen-Clipping Device WORKS LIKE A CHARM. With it I have clipped 30 queens, all in one day, when examining my bees. WM. STOLLEY, Grand Island, Nebr.

Couldn't Do Without It.

I have clipped 19 queens, and must say the Monette Queen-Clipping Device is by far the best invention ever made, and will be welcome to many bee-keepers as it was to me. I could not do without one now.

DR. GEO. LACKE, Newburgh, Ind.

PLEASE READ THIS OFFER TO PRESENT SUBSCRIBERS:

Send us just one new name for the American Bee Journal a year (with \$1.00), and we will mail you the Queen-Clipping Device FREE of charge. Or, the Queen-Clipping Device will be sent postpaid for 30 cts. But why not get it as a Premium by the above offer? You can't earn 30 cts. any easier. Almost every bee-keeper will want this Device. See page 130 (Feb. 27) for full description of it. Complete directions accompany each one sent out. It is a most ingenious and useful article. Address,

GEORGE W. YORK & CO., 118 Michigan St., Chicago, Ill.

❖ MONEY SAVED IS MONEY GAINED. ❖

THE ROYAL UNION Life Insurance Company

DES MOINES, IOWA.

The Iowa Policy

Is one that definitely promises to keep an accurate account with you; credit your premiums and interest, charge the actual expense and mortality cost, and hold the remaining funds subject to your order.

Agents Wanted.

JOHN B. KING, GENERAL AGENT,
Suite 513 First Nat'l Bank Bld'g,
20Atf CHICAGO, ILL.

Our New 4-page Catalog

Contains testimonials from F. A. Gemmill, Wm. McEvoy, Inspector of foul brood for Canada; also many others from those who have tested the Adel bees. All testimonials came in since June 1, 1896. I challenge any queen-dealer in the world to produce such large, fine Queens as I am now sending my customers. "WE GET THE BEST QUEENS FROM YOU," so say a large majority of our patrons. I cannot supply 50-cent Queens—I do not rear that kind. Every one of my Queens is worth \$5.00. But I sell one for \$1.00; 3 for \$2.50; 6 for \$4.50; and 12 for \$8.00. No swarming, no stinging, and no disease among the Adels. A. I. Root Co. have six of our fine Adel Queens as any man can boast of. Can ship by return mail. Send for Catalog.

HENRY ALLEY, Wenham, Mass.
32Atf Mention the American Bee Journal

IF YOU WANT THE BEE-BOOK

That covers the whole Apicultural Field more completely than any other published, send \$1.25 to Prof. A. J. Cook, Claremont, Calif., for his

Bee-Keeper's Guide.

Liberal Discounts to the Trade.

California ❖❖

If you care to know of its Fruits, Flowers Climate or Resources, send for a Sample Copy of California's Favorite Paper—

The Pacific Rural Press

The leading Horticultural and Agricultural paper of the Pacific Coast. Published weekly, handsomely illustrated, \$2.00 per annum. Sample Copy Free.

PACIFIC RURAL PRESS,
220 Market St., - SAN FRANCISCO, CAL.

TEXAS QUEENS.

If you are in need of Queens, let me have your order. Price-List Free.

8A26t J. D. GIVENS, Lisbon, Tex.

BEGINNERS.

Beginners should have a copy of the Amateur Bee-Keeper, a 70-page book by Prof. J. W. Rouse. Price 25 cents; if sent by mail, 28c. The little book and the Progressive Bee-Keeper in five progressive 28-page monthly Journal one year, 65c. Address any first-class dealer, or

LEAHY MFG. CO., Higginsville, Mo.

MUTH'S HONEY EXTRACTOR PERFECTION Cold-Blast Smokers,

Square Glass Honey Jars, Etc.
For Circulars, apply to CHAS. F. MUTH & SON,
Cor. Freeman & Central Aves., Cincinnati, O.
Send 10c for Practical Hints to Bee-Keepers.

common name. It is closely related to the boneset, *E. perfoliatum*; the Joe Pye weed, *E. purpureum*; and the white snake-root, *E. ageratoides*. All are perennial plants, and at least one or two species are usually abundant in every locality. The species sent by Mr. H. is one of the most vigorous, producing a great number of flowers, and could easily be grown by planting the roots in the fall. A patch once started would need no further attention except to keep down weeds. This would be following the proper course for every bee-keeper to pursue, where it is possible, viz., to devote a portion of land to the growing of our best native honey-producing plants. The huge family (composite) to which this plant belongs, would furnish many of value, especially for the late summer and autumn.

General Items.

Good Fall Flow Expected.

Bees are working lively. The fall flow promises a good yield.

F. G. WILKE.

Wilcox, Nebr., Aug. 4.

Doing Very Nicely with Bees.

My wife has four colonies of bees, and is doing very nicely with them. The Bee Journal is assisting her very much.

JOHN KILL.

Seattle, Wash., July 30.

Poorest Season in Years.

This has been one of the poorest seasons for honey for many years. I have not taken a pound of honey yet, and some of my bees are starving.

JOHN V. EMMERT.

Lebanon, Ind., Aug. 1.

Quite Another Spell.

The farmer cannot rest with EE
Until some plan he can DVII.
To rob ye BB, add to his VV.
Or fill his "tank" with their supplies.
About 1 a.m. he dons his clothes.
And for the B-tree off he IIII.
No honey; gets stings on II and NOO.
And CU he's not so very YY.

Weeping Water, Nebr. A. B. GINNER.

Bees in the Pine Tree State.

Bees here in the good old Pine Tree State are storing more honey than for many years. The Alsike and white clovers were in abundance, and now they are at work on the fireweed and yellowweed. Swarming in most cases was very late; some have swarmed four times, and the swarms have swarmed. The old colonies are swarming quite often, as late as July 29. They stored a lot of honey from the white mustard, which is in the grain-fields here, with an abundance of pollen. I found a large swarm on a large oak tree beside the road July 30, and hived them the next day; they are now doing nicely.

Last winter I had five colonies and

Honey-Clovers & Buckwheat SEED FOR SALE.

We have made arrangements so that we can furnish seed of several of the Clovers and Japanese Buckwheat, by freight or express, at the following prices, cash with order

	5lb	10lb	25lb	50lb
Alsike Clover	\$.70	\$1.25	\$3.00	\$ 5.75
Sweet Clover	.75	1.40	3.25	6.00
White Clover	1.25	2.00	4.50	8.00
Alfalfa Clover	.65	1.10	2.70	5.00
Crimson Clover	.55	.90	2.00	3.50
Jap. Buckwheat	.20	.35	.90	1.25

Prices subject to market changes.

Add 25 cents to your order, for cartage, if wanted by freight.

Your orders are solicited.

GEORGE W. YORK & CO.,
CHICAGO, ILLS.

Sweet Clover ¹/₄ Canada.

At the following prices:

5 lbs.	10 lbs.	25 lbs.	50 lbs.
\$1.00	\$1.60	\$3.75	\$7.25.

Also a quantity of Motherwort and Catnip seed. Prices on application.

EGGS for Hatching. Buff Leghorns. Indian Games, & Light Brahmas. Choice Birds. A breeder for 30 years. Prices on application

JOHN McARTHUR,
881 Yonge Street, - TORONTO, ONT.
15Atf Mention the American Bee Journal.

Extracted Honey ❖

Finest Quality. Basswood and Clover.

2 60-lb. cans in case, 8c. per pound. 1 60-lb. can in case, 9c. per pound. A sample by mail, 10 cts. **POUDER'S Honey-Jars and Complete Line of Supplies.** Catalogue Free.

WALTER S. POUDER,
162 Mass. Avenue, INDIANAPOLIS, IND.
Mention the American Bee Journal.

HONEY We have No. 1 Alfalfa, also White and Sweet Clover Honey we will sell cheap.

Honey and Beeswax Wanted.

Boss bee-escape Warranted the best, simplest and quickest Escape on the market. Sent postpaid to any address for 30 cts. It can be returned at our expense if it is not as represented, or we will send the Escape on trial to any bee-keeper wishing to test it in good faith. We are agents for the Ferguson Patent Hive with double-case Super and Wicket-Gate Honey-Board, with the Escape. It is the easiest, quickest hive to handle for the production of comb or extracted honey.

E. S. LOVESY & CO.,
355 6th East St., SALT LAKE CITY, UTAH.
Mention the American Bee Journal. 9Atf

Van Deusen Foundation!

I have some of the celebrated Van Deusen Thin Foundation in 25-pound boxes, that I will put on board cars for \$12.50 per box.

Also ITALIAN

Queens!

Queens!

Fine Untested Queens mailed PROMPTLY at 55 cts. each, or Six for \$3.00.

Safe delivery and satisfaction guaranteed. Address.

F. GRABBE,
LIBERTYVILLE, Lake Co., ILL.

26Atf Mention the American Bee Journal

READERS Of this Journal who write to any of our advertisers, either in ordering, or asking about the Goods offered, will please state that they saw the Advertisement in this paper.



RAILROAD LANDS

For Sale at Low Prices and on Easy Terms.

The Illinois Central Railroad Company offers for sale on easy terms and at low prices, 150,000 acres of choice fruit, gardening, farm and grazing lands located in

SOUTHERN ILLINOIS.

They are also largely interested in, and call especial attention to the 600,000 acres of land in the famous

YAZOO VALLEY OF MISSISSIPPI

lying along and owned by the Yazoo & Mississippi Valley Railroad Company, and which that company offers at low prices and on long terms. Special inducements and facilities offered to go and examine these lands, both in Southern Illinois and in the "Yazoo Valley," Miss. For further description, map, and any information, address or call upon E. P. SKENE, Land Commissioner, No. 1 Park Row, Chicago, Ill. 33D6t

Mention the American Bee Journal.



Bee Supplies
Largest Stock and Greatest Variety in the West. **BEST** Good at Lowest prices. Cat. of 80 pages FREE.

E. KRETCHMER, RED OAK, IOWA.

Mention the American Bee Journal. 23D9t

HARDY & PROLIFIC QUEENS

Gray Carniolans or Golden Italians bred in separate apiaries—One Untested Queen, 65c.; six for \$3.50. Tested, \$1.25. Select Tested, \$2.25. Best Imported, \$4.00

Never saw foul brood or bee-paralysis.

SATISFACTION GUARANTEED. Descriptive Price-List Free.

F. A. LOCKHART & CO.,
27Dtf LAKE GEORGE, N. Y.

Mention the American Bee Journal.

10 per ct. Off to Reduce Stock

on all kinds of SUPPLIES, except

—COMB FOUNDATION—

which will be sold in lots of 10 lbs. or more as follows: Medium, 35 cts.; Light, 36 cts.; Thin Surplus, 40 cts.; Extra Thin, 45 cts.

Queens—Warranted, 50c.; Tested, 75c.

W. J. FINCH, Jr., SPRINGFIELD ILLS.

Mention the American Bee Journal.

North American Bee-Keepers' Association

OFFICERS FOR 1896.

PRESIDENT—A. I. Root.....Medina, Ohio.
VICE-PRES.—Wm. McEvoy.....Woodburn, Ont.
SEC.—Dr. A. B. Mason.....Sta. B, Toledo, Ohio
TREAS.—W. Z. Hutchinson.....Flint, Mich
Convention at Lincoln, Nebr., Oct. 7 & 8.

National Bee-Keepers' Union.

PRESIDENT—Hon. R. L. Taylor.....Lapeer, Mich.
GEN'L MGR.—T. G. Newman.....San Diego, Cal.

lost all of them with diarrhea; but I purchased some more last spring. The hives I use are the 8-frame Langstroth and box-hive. I find the Langstroth the best and most convenient. My bees are golden Italians and Carniolan mixed with one colony of blacks. There is an abundance of honey-plants here this season, although nearly half the weather is rainy or foggy, and has been so for four or five weeks. The bees will store from three to five supers of nice honey, of 28 sections each. J. M. HARDING.
Burkettsville, Maine, Aug. 2.

Have Not Done Well.

Our bees have not done very well this year. In fact, it is the general complaint in this vicinity. We began the season with 33 colonies, and had eight swarms; and have taken off a little over 300 pounds of surplus honey (mostly basswood) at this date.

CATHERINE R. SMITH.

Canandaigua, N. Y., Aug. 3.

Bees Doing Well in Nebraska.

Bees are doing well on alfalfa. Sweet clover is making its appearance in many localities all over the country. Last night's heavy rain gives us promise of an abundant honey crop. Irrigation is making rapid progress in the Loup and Platte valleys, which will make this region, in the near future, the paradise of the world for the honey-bee.

I. C. NIEMOLLER.

Tarnov, Nebr., July 28.

Bees in North Carolina.

I believe this to be a good place for bees. In some localities there are a great many kept, but there are but few improved hives in use. A great many use the old log-hives that were in use in the North 50 years ago. I never hear of any disease of any kind here among the bees, and it is equally as healthy for people. We are 2,750 feet above sea-level, and this is fast becoming one of the great health resorts of the country.

Asheville, N. C. J. W. HAYMOND.

May Italianize Cyprians.

I bought two colonies in the spring of 1895, called "Cyprian" bees. I have five colonies now. I am not struck on their fighting quality, but I have a smoker that I use on them when they get too cranky. I have just received a gold-dust queen, and if her bees are any easier to handle, I will "doctor" all of them.

C. W. HARRIS.

Pawnee Co., Nebr., Aug. 3.

Not a Good Year for Bees.

I send a photograph of my honey-extractor. I have not seen one that can beat it in doing good work. It is capable of taking out 1,000 pounds an hour, and a boy 10 or 12 years old could turn it all day. I have used mine over 18 years, and it is good for as many years more.

This has not been a good year for bees, but I am now taking out honey, as the bees are beginning to do well on the lima-bean blossoms. I have bees in different places; in one place I started last spring with only 10 colonies, and now I

No. 1 Sections—Cheap.

We offer for a few weeks, a surplus stock of our one-piece No. 1 Cream Sections at the following very low prices:

1000 for \$1.50.

3000 for \$4.00.

5000 for \$6.00.

These Sections are finely finished and No. 1 in all respects save color, being, as their name indicates, of a cream color.

The stock consists of a quantity each of the following sizes:

4 1/4 x 2, open 2 sides 4 1/4 x 1 15-16, open 2 sides
4 1/4 x 1 7-8, open 2 sides
4 1/4 x 1 1/2, open 2 sides 4 1/4 x 7-to-11, open 2 sides

G. B. LEWIS CO.

WATERTOWN, WIS.

ITALIAN QUEENS

Golden or Leather-Colored!
BY RETURN MAIL.

Choice Untested, 50c.; Tested, 75c. Full Colonies cheap. No disease. Remit by express M. O. payable at Barnum, Wis. Many customers send \$1.00 and \$2.00 bills. 2c. stamps taken for less than \$1.00. Safe delivery and satisfaction guaranteed.

VAN ALLEN & WILLIAMS,
BARNUM, WIS.

29Atf Please mention the Bee Journal.

Page & Lyon Mfg. Co.,

NEW LONDON, WIS., operates two saw-mills that cut, annually, eight million feet of lumber, thus securing the best lumber at the lowest price for the manufacture of bee-keepers' supplies. They have also just completed one of

The Largest Factories,

and have the latest and most improved machinery for the manufacture of Bee-Hives, Sections, etc., that there is in the State. The material is cut from patterns, by machinery, and is absolutely accurate. For Sections, the clearest and

The Whitest Basswood

is used, and they are polished on both sides. Nearness to pine and basswood forests, and possession of mills and factory equipped with best machinery, all combine to enable this firm to furnish the best goods at

The Lowest Prices. ♡

For instance, it has a job lot of 200,000 No. 2 Sections that will be sold at 50 cts. per 1,000; or 2,000 Snow-White sections will be sold for \$4.00, and larger quantities at still lower prices. Send for Circular and see the prices on a full line of supplies. 16Atf

Mention the American Bee Journal.

A Bargain—EARLY QUEENS.

119 Colonies Italian Bees in Chaff Hives: two acres land; good house; excellent well.

Early Queens—Tested, \$1.00; Untested, 50c. Sent by return mail.

E. L. CARBINGTON,

16Atf PEPPIUS, Bee Co., TEX.

Reference—1st National Bank of Beeville.

Mention the American Bee Journal.

Bee-Keepers' Photograph.—We have now on hand a limited number of excellent photographs of prominent bee-keepers—a number of pictures on one card. The likeness of 49 of them are shown on one of the photographs, and 121 on the other. We will send them, postpaid, for 30 cents each, mailing from the 121 kind first; then after they are all gone, we will send the 49 kind. So those who order first will get the most "faces" for their money. Send orders to the Bee Journal office.

have 40, and from them I have taken 500 pounds of honey, without using any foundation, and I shall keep an account of what I take from them this season.

I sent to the World's Fair a fine beehive, and samples of honey stored in many different things and shapes, such as Abalona and other shells, gourds, and many different shapes in glass. My honey was put in with the exhibits of three counties, which did not make as good a showing as it would have done had it been put all together in one place. I am now making a few more samples.

DR. J. ARCHER.

Ventura Co., Calif., July 26.

[Thank you, Doctor, for the nice photo of your extractor. We should think it would be much more expensive to make than the ordinary metal ones.—EDITOR.]

Bees Not Doing Much.

Bees are not doing much now, for the grasshoppers have cut all of the bloom off of the alfalfa, so that there is nothing for them to work on but cleome and golden-rod. They commenced to drive out the drones July 20. C. C. ZINN.

Windsor, Colo., Aug. 3.

A Good Report.

My bees have done well this season. I have taken 600 one-pound sections from 9 colonies, spring count, and I now have 23 colonies. There are probably about 200 sections finished on the hives, and the prospect is good for a medium fall flow. I have three colonies storing in the fifth super of 32 sections each, four filled already, but those colonies have not swarmed. The honey is of fine quality, from clover. There is some Alsike clover about here. Long live the "old reliable" American Bee Journal!

WM. RENNE.

Poplar Grove, Ill., Aug. 1.

Nectar Secretion—Swarming.

I am very much interested in Dr. Miller's reply to P. J. K., on page 486; also in the report of L. Allen (page 493). Mr. K. lives just west of the west line of Loyal; Mr. Allen 2 miles east of Mr. K. I live 4 miles east of Mr. Allen, in the same town. Now, I have some splendid basswood honey, in sections and extracted; I also have some white clover honey. There is but little Alsike here, and I never have seen a bee on it yet, but the basswood trees were alive with bees during the bloom, and now the white clover is teeming with them. This is one of the very strange things (to us). Can there be so great a difference in the atmosphere in localities so near each other?

My first swarm issued on May 27. I hived them on eight frames, with 2-inch starters. Those bees filled the body half full of honey, 16 shallow frames in supers, with inch starters, and 43 one-pound sections, and cast a prime swarm on June 30; that prime swarm has filled 40 sections, and are working busily on a super of shallow frames. I use a super of shallow frames on the hive as a bait, the next super will contain sections. I sometimes have brood in the shallow frames, but not always.

Just tell Dr. Miller, for me, that the double body of eight frames don't stop

the swarms from issuing this season, but the swarms are very large, and some later. Neither will moving the old colony to a new stand always prevent after-swarms. Two colonies of mine swarmed twice each, after removal. In fact, they cut up all sorts of pranks this season. Prime swarms would leave a comb of brood and start for timber, even when thoroughly shaded and ventilated. Putting supers partly filled on the hives containing new swarms, is another inducement for them to skip out. I have found an entrance-guard, or a queen-cage, a very necessary article some times. L. M. WILLIS.

Loyal, Wis., July 31.

A Great Bee and Farming Country.

My 9-year-old boy is taking a great interest in the bees. I have made him an observation hive, set on a shelf in the wood-house, so the bees pass out and in at, or through, a knot-hole. What would I have given, at his age, if I could have had such a chance? I now have 26 colonies, 4 of them are only 3-frame nuclei, with mature queen-cells, yet I shall make full colonies of them in short order. Bees are doing splendidly. I am working for increase only, this season, and can keep on increasing up to the 1st or middle of October.

Here in the valley bees have a large variety of honey-plants to gather from. There are numerous small patches of alfalfa allowed to blossom, and stray roots along the irrigating ditches; acres of wild sunflowers; lemon trees are in bloom at all times; acres of corn bloom, pumpkins, squash, melons, cucumbers; 40 acres of lima beans just across the street from me; 600 acres within 2½ miles in limas; 65 acres of alfalfa raised for seed within 1½ miles, etc. We do not expect rain, and can get along without it. The trees are green, and growing corn, pumpkins, beans, etc., all are green without irrigation. Our soil here is made on purpose to stand drouth. The 600 acres of limas, and several thousand acres of corn, never have been irrigated, and still the growth is enormous. The 65 acres of alfalfa, spoken of above, with 300 or 400 acres cut for hay, never were irrigated. Only think, this alfalfa is cut from five to six times a year for hay—about 1½ tons per acre at a cutting—and then pastured two months in winter—seven months without rain, and no irrigation. How is that for high?

DR. E. GALLUP.

Santa Ana, Calif., July 25.

Getting All Honey in the Sections.

Since I suggested in the American Bee Journal of March 12, 1896, that I had a method of inducing the bees to store all the honey in the sections, I have received a great many letters from bee-keepers requesting me to give the plan. To some of these I stated that I would send it to the American Bee Journal. Owing to ill-health, and the fact that I undertook to do more than I was able, I was not able to get the article ready in time to be of any use in this year's operations. I will send it in sometime during this year.

On the first day of May, 1896, I was at one of my out-apiaries, consisting of 150 colonies, located 12 miles from home. I had been there a week, working 16 hours per day, putting on surplus

cases to receive the great honey-flow that was coming in, two weeks ahead of time. I engaged a boy to watch the swarms, and contemplated the pleasure of a ride home in the afternoon. I stood in the doorway of my ranch house and listened to the music of the bees. I took one long, exultant view of the blessed bees, as they poured into the hives, laden with precious sweets that give to the practical apiarist the crown of inspiration.

The inimitable thunderings of an approaching storm turned my eyes westward. The Storm King approached—40 minutes passed, the leaves and the flowers of the forest had disappeared, the many birds that, just before, so sweetly sang, were then writhing in pain, or cold in death; the farmer's crops were gone, his orchards, the result of many years of toil and care, were then ruined. The ground was hidden beneath the hail that had fallen several inches deep. "Thy will be done."

C. C. PARSONS.

Jefferson Co., Ala., July 27.

Question-Box.

In the multitude of counsellors there is safety.—Prov. 11-14.

Keeping Bees in a House in a City.

Query 25.—In starting a house-aplary in a city of the first class, where one has a large house with upper rooms—1st. Is it best to have the bees in an upper or lower room?

2. Would it be advisable to have the bees in regular hives, or would it be better to make a small room, say four feet square, with large frames, and put in two or three swarms, and then let them have their own sweet will?—KANS.

G. M. Doolittle—I have no experience.

W. R. Graham—I know nothing about a house-aplary.

Dr. J. P. H. Brown—I have no experience with house-aplaries.

R. L. Taylor—1. Yes, in an upper room. 2. Ordinary hives.

Dr. C. C. Miller—1. Perhaps upper. 2. Have them in regular hives.

C. H. Dibbern—1. I should prefer an upper room. 2. I should use regular hives.

Chas. Dadant & Son—Ask C. F. Muth, of Cincinnati. He has tried this for 30 years or more.

Mrs. L. Harrison—1. Upper room, as it would take them up out of harm's way. 2. In hives.

W. G. Larrabee—1. I would as soon have an upper room as a lower one. 2. Have them in regular hives.

J. M. Hambaugh—1. Upper room. 2. Use hives with separate entrances and exits for each colony of bees.

E. France—1. I should say the upper rooms. 2. Put the bees in hives; 4 feet square is too big for a single hive.

B. Taylor—1. I should prefer a lower room. 2. Regular hives. The right style of hive is a necessity in a house-aplary.

H. D. Cutting—1. It will make but little difference. 2. If you want to produce honey with any satisfaction use regular hives.

G. W. Demaree—I would prefer to have them in a second-story room, and

keep them in separate hives, by all means; and be sure that each queen has her wing clipped, so as to bring the swarms back without bothering your neighbors. See?

Rev. M. Mahin—1. I judge that an upper room would be preferable. 2. By all means have the bees in regular hives. The plan you suggest would not work at all.

Allen Pringle—1. The bees would be much more liable to give annoyance and make trouble in the lower room in a city. Put them up. 2. I would have proper hives.

P. H. Elwood—I should prefer them in an upper room and in hives. It would be better to locate them in the country, and go out and take care of them as often as necessary.

J. E. Pond—I don't know by experience the first thing about a "house-apary," but judging from the experience of others, I conclude they are not as yet a profitable manner of working.

Prof. A. J. Cook—1. If you mean a dwelling-house—hardly a house-apary—then I should say in upper room. 2. In regular hives, always. Bees are not communists to the extent you suggest.

Eugene Secor—1. In a large city I doubt if it would be advisable to keep bees anywhere except on the house-top. 2. I would keep them in hives of a large pattern to prevent swarming if possible.

James A. Stone—1. I would say the upper room, as bees naturally desire a high place. 2. If you prefer to have them swarm, keep them in hives. If you put them in the four-foot-square room you name, you need look for no swarms. If you put three or four swarms into the room, they will soon be one, with but one queen.

Emerson T. Abbott—1. I should put the bees in the upper rooms. 2. Put them in hives the same as out-doors, and make small openings in the side of the house for entrances. Fix it so the bees cannot get out into the room unless the hives are opened. Make provision for the bees to escape from the room when the hives are opened.

The Bee-Keepers' Guide: Or Manual of the Apiary,

BY PROF. A. J. COOK.

This 15th and latest edition of Prof. Cook's magnificent book of 460 pages, in neat and substantial cloth binding, we propose to give away to our present subscribers, for the work of getting new subscribers for the American Bee Journal.

A description of the book here is quite unnecessary—it is simply the most complete scientific and practical bee-book published to-day. Fully illustrated, and all written in the most fascinating style. The author is also too well-known to the whole bee-world to require any introduction. No bee-keeper is fully equipped, or his library complete, without "THE BEE-KEEPER'S GUIDE."

Given For 2 New Subscribers.

The following offer is made to PRESENT subscribers only, and no premium is also given to the two new subscribers—simply the Bee Journal for one year:

Send us Two New Subscribers to the Bee Journal (with \$2.00), and we will mail you a copy of Prof. Cook's book FREE as a premium. Prof. Cook's book alone sent for \$1.25, or we club it with the Bee Journal for one year—both together for only \$1.75. But surely anybody can get only 2 new subscribers to the Bee Journal for a year, and thus get the book as a premium. Let everybody try for it. Will you have one?

HONEY and BEESWAX

MARKET QUOTATIONS.

The following rules for grading honey were adopted by the North American Bee-Keepers' Association, and, so far as possible, quotations are made according to these rules:

FANCY.—All sections to be well filled; combs straight, of even thickness, and firmly attached to all four sides; both wood and comb unsoiled by travel-stain, or otherwise; all the cells sealed except the row of cells next the wood.

No. 1.—All sections well filled, but combs uneven or crooked, detached at the bottom, or with but few cells unsealed; both wood and comb unsoiled by travel-stain or otherwise.

In addition to this the honey is to be classified according to color, using the terms white, amber and dark. That is, there will be "fancy white," "No. 1 dark," etc.

Chicago, Ills., Aug. 1.—We quote: Fancy: white clover, 15c.; No. 1 white, 12@13c.; fancy amber, 10@11c.; No. 1 amber, 7@9c.; fancy dark, 9@10c.; No. 1 dark, 7c. Extracted, white, 5@7c.; amber, 5@5½c.; dark, 4½@5c. Beeswax, 25@27c.

The month closes with some offerings of new comb honey, for which 14-15c. is asked for best lots—but there are no sales of consequence to report. There is usually a good deal of it moved in August, thus establishing the early market.

Philadelphia, Pa., July 10.—No. 1 amber, 9-10c.; fancy dark, 8-9c.; No. 1 dark, 7-8c. Extracted, white, 8-10c.; amber, 5-5½c.; dark, 3½-4c. Beeswax, 25-26c. Honey very dull. Beeswax in fair demand.

Buffalo, N. Y., July 24.—Fancy comb, 1-pound, 12-14c.; No. 2, 9-10c.; No. 3, 4-8c. Extracted, 3-5c., as to quality. It is folly to ship honey unless properly packed. Good results depend on it and quality.

Cincinnati, Ohio, July 10.—No. 1 white, 13@14c.; fancy amber, 12@13c.; No. 1 amber, 10@12c. White, extracted, 5@7c.; amber, 5@6c.; dark, 3½-5c. Beeswax, 20-25c.

New York, N. Y., June 24th.—No demand for comb honey of any kind. New crop of southern extracted is arriving freely, and sells fairly good at 50@52c per gallon for common, and 55@60c per gallon for better grades. Beeswax dull at 26@27c.

Cleveland, Ohio, July 9.—We quote: Fancy white, 15@16c.; No. 1 white, 14@15c.; fancy amber, 10@11c. Extracted, white, 6@6½c.; amber, 4@5c. Beeswax, 20@25c.

Our market is nearly bare of honey. We think early shipments would meet with ready sales at about quotations.

St. Louis, Mo., July 9.—We quote: Fancy white, 11½@12c.; No. 1 white, 10½@11c.; fancy amber, 10@10½c.; No. 1 amber, 9@10c.; fancy dark, 8½@9c.; No. 1 dark, 7@8c. Extracted, white, in cans, 5c.; in barrels, 4c.; amber, 3½@4c.; dark, 3@3½c. Beeswax, 25@25½c.

This week we sold 4,700 pounds of Southern extracted in barrels at 3½c. Honey is in fair demand. Very little fancy new comb coming in, and what has been offered not well cured as yet.

Minneapolis, Minn., July 9.—We quote: Fancy white, 15c.; No. 1 white, 13@14c.; fancy amber, 10@12c.; No. 1 amber, 8@10c.; fancy dark, 7@9c.; No. 1 dark, 8c. Extracted, white, 5¼@6¼c.; amber, 5¼@5½c.; dark, 4¼@5¼c. Beeswax, 26@28c.

Actual transactions both in comb and extracted very light. Minnesota and Wisconsin comb will commence arriving in moderate quantities about August, and will probably supply the market until cool weather, which usually stimulates a demand. Considerable extracted is now here on the spot, sufficient to supply immediate wants.

San Francisco, Calif., July 29.—White comb, 11-12½c.; amber, 7½-10c. Extracted, white, 5-5½c.; light amber, 4½-4¾c.; amber colored and candied, 3¼-4c.; dark tulle, 2¾-3c.

Not much offering, and as the crop is a comparative failure, stocks will be light throughout the season. The demand at current rates is confined almost wholly to local requirements.

Beeswax, fair to choice, 22-26c. Market in a somewhat unsettled condition, owing to much of this product having been lately adulterated. Foreign buyers now insist on a guarantee as to purity before making further purchases.

Milwaukee, Wis., July 13.—No. 1 white, 12-13c.; No. 1 amber, 8-10c. Extracted, white, 7-7½c.; amber, 6-6½c.; dark, 5-6c. Beeswax, 20-24c.

The supply of honey is not large and nearly all old crop, as the receipts of new are extracted; quality fair. The demand is limited, as the supply of small fruits is large and the consumption of honey is small. The market will be in good condition for shipments of the new crop, both comb and extracted, and we look for a good demand later.

Albany, N. Y., Aug. 1.—Fancy white, 13-14c.; No. 1, 12-13c.; No. 1 amber, 11-12c. We have received a number of consignments of new comb honey, mostly white, and a great many letters from producers, asking if they should forward their honey as soon as it was ready. There is but very little demand for honey during hot weather and it creates an unfavorable impression on the trade to see a large stock of honey standing around. September 1 is time enough to forward comb honey. We look for a large crop of white honey and prices lower than last season.

Detroit, Mich., July 13.—No. 1 white, 11-12½c.; fancy amber, 10-11c.; No. 1 amber, 9-10c.; fancy dark, 8-9c.; No. 1 dark, 7-8c. Extracted, white, 6-7c.; amber, 5-6c.; dark, 5c. Beeswax, 24-25c.

There is very little old honey on the market that is desirable. New honey will sell slowly in this market until October.

Indianapolis, Ind., July 28.—Fancy white, 15-16c.; No. 1 white, 13-14c. Extracted, white, 6-7c. Beeswax, 25-27c.

No demand at all for grades of either comb or extracted honey. Large fruit crop and warm weather are opponents to the demand for honey at present.

Boston, Mass., July 15.—Fancy white, 14-15c.; No. 1 white, 12-13c.; fancy amber, 9-10c. Extracted, white, 6-7c.; amber, 5-6c. Beeswax, 25-26c.

Fancy new white honey now in stock; demand fair. Old stock nearly closed out.

Kansas City, Mo., July 20.—Fancy white comb, 15c.; No. 1 white, 13@14c.; fancy amber, 12-13c.; No. 1 amber, 11-12c.; fancy dark, 10-11c.; No. 1, 8-10c. Extracted, white, 6-6½c.; amber, 5 5/8c.; dark, 4-4½c. Beeswax, 22-25c.

List of Honey and Beeswax Dealers.

Most of whom Quote in this Journal.

Chicago, Ills.

R. A. BURNETT & Co., 163 South Water Street.

New York, N. Y.

HILDRETH BROS. & SOELKEN,
120 & 122 West Broadway
CHAS. ISRAEL & BROS., 486 Canal St.

Kansas City, Mo.

C. C. CLEMOMS & Co., 423 Walnut St.

Buffalo, N. Y.

BATTERSON & Co., 167 & 169 Scott St.

Hamilton, Ills.

CHAS. DADANT & SON.

Philadelphia, Pa.

WM. A. SELSER, 10 Vine St.

Cleveland, Ohio.

WILLIAMS BROS., 80 & 82 Broadway.

St. Louis, Mo.

WESTCOTT COM. Co., 213 Market St.

Minneapolis, Minn.

S. H. HALL & Co.

Milwaukee, Wis.

A. V. BISHOP & Co.

Boston, Mass.

E. E. BLAKE & Co., 57 Chatham Street

Detroit, Mich.

M. H. HUNT, Bell Branch, Wayne Co., Mich

Indianapolis, Ind.

WALTER S. POWDER, 162 Massachusetts Ave.

Albany, N. Y.

CHAS. McCULLOCH & Co., 380 Broadway.

Cincinnati, Ohio.

C. F. MUTH & SON, cor. Freeman & Central avs.

Bottom Prices

**BRING US BIG TRADE.
GOOD GOODS KEEP IT.**

If you want the best supplies that can be made at a little less cost than you can buy the same goods for elsewhere, write to us for low prices. 1896 Catalogue now ready—ask for it and a free copy of *The American Bee-Keeper* (36 pages).

Address,
THE W. T. FALCONER MFG. CO.,
JAMESTOWN, N. Y.
Mention the American Bee Journal.

COMB FOUNDATION!

Wax always wanted for Cash or in Exchange for Fdn. or other Supplies. My trade is established on **Low Prices** and the merit of my **Foundation**. Orders filled promptly.

WORKING WAX INTO FDN, BY THE LB. A SPECIALTY. Wholesale prices to dealers and large consumers. Send for Prices and Samples to—**GUS DITTMER, AUGUSTA, WIS.** Reference—Augusta Bank. 1 Atf
Mention the American Bee Journal.



Oh! Oh!! Oh!!! I stubbed my toe, hurrying so, to keep up with orders for Queens which are pouring in. But never, never mind, Doolittle is all right and he can go, so send on your orders as per page 512, of Aug. 6th Am. Bee Journal. Hi, Ho!

The reason orders pour in so, is because purchasers go, and tell their neighbors about Doolittle's Queens.

Here is what Mr. Chas. H. Peck, Bridgeport, Conn., tells of them:

"I bought one of your Queens and have requeened all my colonies from her. One colony with a young Queen from her gave me 143 lbs. of surplus last year, and I have one that will do almost as well this year. I have tried Queens from*** and other places, but yours beat them all, and, I want no better."

Mention the American Bee Journal.

THROAT AND LUNG DISEASES,
DR. PEIRO, Specialist
Offices: 1019, 100 State St.,
CHICAGO. Hours 9 to 4.

Mention the American Bee Journal.

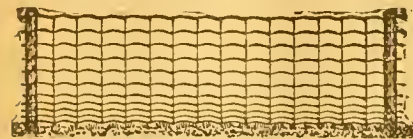

BUFFALO HUNTING.

Everybody can now indulge in this pastime. Here are a few hints: Buy excursion tickets to your State Fair! Take the whole family along. The "kids" can watch the deer and fawns while you keep your eye on the big game. Once inside the grounds, lay low and watch the crowd till you locate our exhibit, then charge on it with a wild whoop. Send for pictures.

PAGE WOVEN WIRE FENCE CO., Adrian, Mich.
Mention the American Bee Journal.

19th Year Dadant's Foundation 19th Year

Is still in the lead, for we use all the latest improvements, including the

NEW WEED PROCESS,

and still make the best goods. Remember that we do not use any acid to purify our beeswax, and that is why our Foundation preserves the smell of the honey and is more acceptable to the bees, than any other. It is kept for sale by

T. H. Strickler, Solomon City, Kansas.
G. K. Hubbard, Fort Wayne, Ind.
L. Hanssen, Davenport, Iowa.
C. Theilmann, Theilmanton, Minn.
E. C. Eaglesfield, Berlin, Wis.
E. T. Abbott, St. Joseph, Mo.
J. M. Jenkins, Wetumpka, Alabama
John Rey, East Saginaw, Mich.
Vickery Bros., Evansville, Ind.

The Jennie Atchley Company, Beeville, Texas.
C. F. Muth & Son, Cincinnati, Ohio
E. Kretzmer, Red Oak, Iowa.
G. B. Lewis Co., Watertown, Wis.
James Reynolds Elevator Co., Ponghkeepsle, N. Y.
Louisiana Bee-Keepers' Supply Manufactory,
Donaldsonville, La.
Page & Lyon, New London, Wis.
John Nebel & Son, High Hill, Mo.

and many other Dealers. All agree in saying that no goods are better than ours.

Those of our customers who formerly bought through Thos. G. Newman can get our Foundation in **Chicago, Ill.**, by addressing us at **118 Michigan Street**. We keep no other goods there.

We make a specialty of **Veils and Veil Stuffs** of best quality, cotton and silk.

"LANGSTROTH ON THE HONEY-BEE"—Revised.

Bee-Keepers' Supplies, Smokers, Sections, Tin Pails, etc.
Samples of Foundation and Tulle FREE with Circular. Instructions to beginners with Circular. Send us your address.

CHAS. DADANT & SON,
Mention the American Bee Journal. **HAMILTON, Hancock Co., ILL.**

No. 1 4 1/4 x 4 1/4 Snow-White Sections \$2.00 per 1,000.



For the purpose of introducing our One-Piece Section to the bee-keepers generally, we have concluded to make the price \$2.00 per 1,000 for the season. Now is the time to get your Sections cheap. We have a choice lot of Section Lumber, gotten out of young timber, and we can furnish you the nicest Section to be had. Write for Sample Section Free.

32A4t
Mention the American Bee Journal.

The Marshfield Mfg. Co., MARSHFIELD, WOOD CO., WIS.

The Bee Journal to New Subscribers July 1 to Jan. 1, only 40 cts.

Good Prices on Your Comb Honey!

Then you want our latest

NON-DRIP SHIPPING-CASES.

Our trade was never so large in these as now; and Commission Men tell us that Comb Honey in our Cases brings

BETTER PRICES

than some of the Cases made by competitors. The fact is, we know the demands of the trade, and are prepared to supply them. Remember, home-made or poorly made Cases are dear at any price. Honey in such Cases always brings several cents below the market price.

If you wish to get **GILT-EDGE PRICES** on **GILT-EDGE HONEY** put it up in

Root's Non-Drip Shipping-Cases.

THE A. I. ROOT COMPANY,

Factory and Main Office, **MEDINA, O.**

BRANCH OFFICES:

118 Michigan St., Chicago, Ill.
1024 Miss. Str., St. Paul, Minn.

Syracuse, N. Y.
Mechanic Falls, Maine.

AMERICAN BEE JOURNAL

ESTABLISHED IN 1861
THE OLDEST BEE-PAPER IN AMERICA

DEVOTED EXCLUSIVELY
TO THE INTERESTS
OF HONEY-PRODUCERS

Published Weekly, at \$1.00 per annum.

Sample Copy sent on Application.

36th Year.

CHICAGO, ILL., AUGUST 20, 1896.

No. 34.

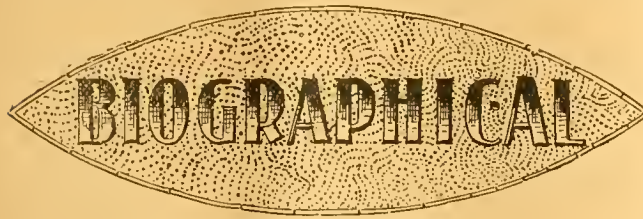

MR. ALLEN PRINGLE.

In last week's issue of the Bee Journal we announced the sad news of the unexpected death of one of Canada's most prominent bee-keepers—Mr. Allen Pringle, of Selby, Ont.—on July 22, 1896. We are glad to be able, this week, to present to our readers not only the excellent and latest picture of our departed friend, but also something about his life, particularly as a bee-keeper.

In the American Bee Journal for May 18, 1893, we published a biographical sketch of Mr. Pringle (in connection with his portrait) and from it we glean some things that will be of special interest now.

At the age of 10 young Pringle might have been seen on a wood sleigh one fine morning in April, accompanying his father to a neighboring house three miles off to get their first "skep" of bees. The colony was in what is now called "the old box-hive," and they got it home in good condition on the sled. Thus commenced the young lad's experience in bee-keeping.

Up to the age of 15 he attended the local school in winter and assisted with the bees and farm work in summer. By that time he had acquired all the learning the average country school pedagogue could impart, besides quite a fund of antiquated bee-lore. He now began to think of doing something for himself on his own account. Accordingly one morning in May, bright and early, the self-reliant and ambitious youth started off on foot and alone to a neighboring town several miles away to attend an examination of candidates for teachers' certificates. He was successful, and duly received his certificate of qualification to teach any common school in the county.

Soon after, at the age of 15, he took a situation as teacher without assistant, and there ended his own schooling with the exception of a subsequent term or two in a high school. His education was acquired for the most part outside of schools and colleges. For several years the winters were spent teaching the "young idea how to shoot" in some of the largest and most difficult schools to manage in the whole county, and with every success; while the summers were mostly spent on the farm and amongst the bees, which, under

skillful management, had increased from the original old box-hive to over half a hundred prosperous colonies.

Having readily absorbed the bee-lore possessed by all the wisecracks of the neighborhood, and hearing that a great book had been published on bees, he sent for it and got it in due course by mail. It was Quinby's "Mysteries of Bee-Keeping Explained." From this he got new hints and valuable information, and rapidly came to the front in the science and art of bee-culture as practiced in those days. He discarded the box-hive and used a movable frame, from which he extracted the honey with an old-fashioned extractor, getting the nearest blacksmith to make him an uncapping-knife from an old file, which he used ever afterward, and which, during a quarter of a century, has shaved the caps off many tons of honey

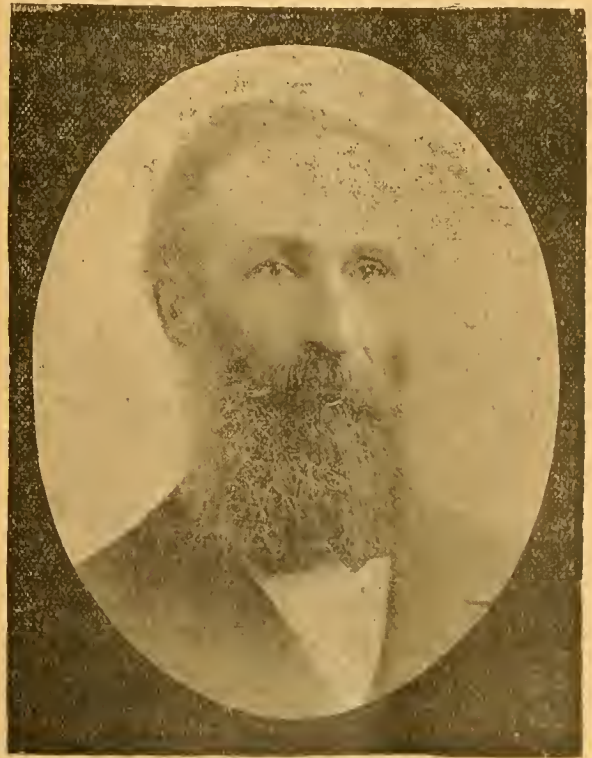

Allen Pringle.

Through a strong love of bees, and a natural adaptation to the handling and management of them, supplemented by a long experience, Mr. Pringle became one of the most skillful apiarists in America, and was looked to as an authority on bee-culture by all who knew him. Though never seeking office, the office sought him, and he served as President and

Director of the Ontario Bee-Keepers' Association for several years, doing the Association important service while its President.

Mr. Pringle was a worker in the fullest sense of that term—working with both hands and head with equal facility and effectiveness. He could turn his hand to many things, and his head and pen to many subjects. He was known as a clear, cogent and forcible writer, not only in the daily press, but the monthly magazines. Prof. Cavanaugh, the expert phrenologist of Toronto, in a published work, spoke of Mr. Pringle as "one of the ablest writers in America." His style was clear, critical and logical, and the man who entered the controversial arena with him might well make up his mind beforehand to come out with a demoralized quill and with his feathers flying. In the field of polemics Mr. Pringle carried the heaviest kind of guns. He was one of the few men who were thoroughly practical and utilitarian, as well as theoretical and philosophical.

He made his bee-culture and farming pay in dollars and cents; handled his large apiary alone, doing all the work; put up and marketed his honey, worked on his farm, and found time (at night) to write for bee-papers, agricultural journals, magazines and newspapers, besides conducting a large correspondence, including in it some of the most eminent literateurs and scientists of the day.

Mr. Pringle was held in high esteem by all who knew him as a man whose word was his bond, and whose honor and moral life were above reproach.

As all remember, Mr. Pringle was the able Superintendent of the splendid Ontario apiarian exhibit at the World's Fair here in Chicago in 1893. It was while there that we had the pleasure of making his acquaintance, as well as that of his accomplished daughter, Miss Grace Pringle, who assisted him in preparing the exhibit. Mr. Pringle had for years been one of the American Bee Journal's best contributors, and those having the older volumes, as well as the more recent ones, will find many valuable articles from his practical pen. All will still recollect his long and interesting essay, which he read at the Toronto convention of the North American last September, entitled, "The Mistakes of Bee-Keepers and Bee Journals," and which was published in full in these columns.

The Napanee Express (a local newspaper) for July 24, in giving the announcement of Mr. Pringle's death, said:

Allen Pringle was one of Nature's noblemen, and it is hard to realize that he has passed out of our sphere, through the Valley of the Shadow, and solved the great problem veiled to mortal eyes.

Deceased was delicately constituted, and fully recognized that his hold on life was not as strong as falls to the lot of the average man. He carefully abstained from everything that had a tendency to endanger his health, and with his extensive knowledge of hygiene, might have prolonged his life to a ripe old age had he not contracted a sunstroke while in New York last summer. Mr. Pringle never fully recovered from this stroke. About a month ago his eyes became affected, and his last communication to the Express, just prior to the general elections, was written under great difficulties, as he was partially blind from the effects of his illness. A few weeks afterwards he recovered his sight and rallied somewhat, but about two weeks ago his health again began to fail, and he gradually grew weaker until tired nature gave up the struggle on Wednesday afternoon, and he passed peacefully away to that bourne from whence no traveller e'er returns. His wonderful vitality kept up to the last, and deceived his family and relatives, who, up to the hour of his death, imagined that he was improving.

Allen Pringle was born in Richmond, Ont., on April 1, 1841. He studied medicine for a time, but abandoned it to pursue the calling of an agriculturist and apiarist. He was fully conversant with all branches of agriculture, and a thorough and successful farmer. His farm in the township of Richmond is a model of neatness and cleanliness in keeping with the orderly character of the man.

Mr. Pringle was a scientist and a scholar, and his articles of economic and social questions brought him into great prominence. As a controversialist he was recognized as a

clean, fair, and manly antagonist; who never misrepresented an opponent, or hit below the belt. He was a deep thinker and a logical reasoner, and as a writer of clear, forcible English, will take rank with the foremost writers in Canada today. He was a voluminous writer, and a contributor to many of the leading magazines and newspapers both in Canada and the United States. Deceased was in close touch with many of the ablest thinkers on this continent, including Prof. Goldwin Smith and others.

Mr. Pringle held views peculiar to himself on religion. His position on this subject was often misunderstood. He was an earnest and truthful man, and while he fully appreciated that the pronouncement of his views on religion detracted from his influence and popularity, he never shirked the responsibility of them. It cannot be said that he obtruded his views on people, as unless approached he was very reticent on the subject.

Mr. Pringle was an ardent bimetalist, and said that he "held himself in readiness to answer fairly and squarely any argument in fact, figures, history or science that might be presented decently in favor of the gold standard and against bimetalism. He felt in saying this that it was neither egotism nor fanaticism, but the confidence that comes from the consciousness that one is right in a great cause." He believed that with a fair field and no favor he could successfully meet all comers on the subject of bimetalism; and that this was the great question, compared with which questions of tariffs, free trade and protection dropped into insignificance.

Mr. Pringle was a man of sterling honesty and integrity, and of a kindly disposition. He was esteemed and respected by friends and opponents alike. He was 55 years, 3 months and 22 days of age, and leaves a wife and one daughter, Miss Grace Pringle, to mourn the loss of a faithful husband and a loving father.



Queen-Rearing Questions Answered

BY G. M. DOOLITTLE.

A list of questions have been sent me, mainly on queen-rearing, with the request that I answer them in the American Bee Journal; and as the most of them are of interest to all bee-keepers, I have concluded to do as requested. To simplify matters I have numbered each question, and its answer follows:

QUES. 1.—Will a queen reared from an old queen about to be superseded, be as good as when reared from the same queen in her prime?

ANS.—Yes; and I would add that some of the best queens I ever had in my apiary were reared by this superseding process, the old queen living from one day to one year after the young queen, or the queen-cell for her, was started. The answer to question 7 will hold good here. I have never seen any difference in queens or workers reared from queens about to cease life, as compared with the same from the same queen when in her prime. Has any one else? If so, will he please tell us about it?

QUES. 2.—What is the least number of day after hatching, the weather being favorable, required before a young queen will leave the hive for fertilization?

ANS.—Five days after maturity is the least number that I ever knew to elapse before the queen went out to meet the drones. But a queen does not always hatch on her maturity, for very many are held in their cells from one to five days by the worker-bees, after they would have gnawed off the cap-pings to their cells and come out could they have had their own way. Queens are more often held in their cells in this way

than is generally supposed. In one instance I opened a hive and found a young queen piping away with a vehemence I had never known before. After looking the colony over I found a queen-cell with a queen in it, which I had over-looked when cutting out cells from this hive before. As there were plenty of bees in this hive, I took the frame having this cell upon it, bees and all, and set it in an empty hive, together with a frame of honey, thus forming a nucleus. The queen from this cell took her wedding flight successfully the next day; and in two days more (or three days in all from the time I set the sealed cell in the hive), she was laying worker-eggs regularly in the comb which her cradle was on. This is a fact, and is as I have it down in one of my diaries. I told it to a bee-convention once, not explaining the aforesaid maturity part, and no one would believe it. Thus, it will be seen that the days from *hatching* and the days from *maturity* are two different things.

QUES. 3.—Will there be any difference in the time of leaving the hive for fertilization between a queen hatched in 10 and one hatched in 16 days?

ANS.—Yes; the queen hatched in 10 days will, as a rule, be slower in going out. In round numbers, three days in the egg form, six days in the larva form, and seven days in the sealed state, is the rule for all queens from a colony in a normal condition. Thus it will be seen that the queen which hatches in 10 days must have been fed for a worker for three days of its larval life, or, in other words, the larva must have been three days old when the bees commenced to change it from a worker to a queen. Nine-day queens are very slow in becoming fertile, while, out of a lot of queens which once hatched in 8½ days, only two became fertile at all; one being fertilized after she was 20 days old. These queens could scarcely be told from a worker, and neither lived to be over three months old.

QUES. 4.—How many days after hatching before the worker-bee leaves the hive for labor?

ANS.—They can be forced out at three to four days old; but when the colony is in a normal condition, 16 days is the rule. Much has been given along this line in the bee-papers during the past to corroborate the above.

QUES. 5.—In what does their first out-door labor consist—gathering honey, pollen, water, or propolis?

ANS.—Either, or all, just according to the wants of the colony, and according to the supply to be had from the fields.

QUES. 6.—If we make a colony queenless, removing all the eggs and brood, and give this queenless colony a comb containing 500 eggs, not nearly as many queen-cells and cells of capped brood will be found on the tenth day as we gave eggs. What becomes of the eggs? If destroyed, why? If used in the jelly given the queen-larvæ, would the eggs of a black queen affect the coloring of the young queens reared from Italian larvæ?

ANS.—Some of the eggs are removed to give place to the larger and more commodious queen-cells. Why more than these are removed I do not know, unless it is because the colony is thrown into an abnormal condition. As to what becomes of the eggs, I have no hesitation in saying that the bees eat them, for I have repeatedly seen bees eat eggs as they came from the queen. Because the bees eat eggs, it does not necessarily follow that they in any way enter into the food given to the young queen-larvæ; for, according to my observations, thousands of eggs are eaten by the bees when they have no idea of rearing a queen. And if they did enter into the royal jelly, they could only form so small a part of the whole that little or no chance as to coloring could be given. But if, as nearly all claim, this royal jelly is an animal secretion, how could it possibly affect the color of the young queens, even if the royal jelly was formed wholly from a diet of eggs from black queens? I had supposed that this old theory, put forth by Kirby in the 60's, was exploded long

ago. From many years of experience, I have failed to find that black nurse-bees, or eggs or larvæ from a black queen, in a hive from which Italian queens were being reared, had anything to do with the coloring of such queens.

QUES. 7.—Will the eggs and larvæ of a queen two months old produce as good queens as if she were one or two years old? If not, why not?

ANS.—According to the prevailing opinion of many, no; but according to the most careful observation on my part, yes. After years of careful watching along this line, I fail to see any difference between a queen reared from the very first eggs laid by any queen and those laid by the same queen two years later; and I do not believe there is any difference. Will those who doubt this fact tell us where the difference lies, giving proof to support their conclusions? Has any one noticed that the first workers hatched from any queen were in the least inferior to those produced by the same queen later on in life, everything otherwise being in a normal condition? The size of the cradle and the amount of food given govern this matter, it seems to me, rather than the age of the queen.

QUES. 8.—Why do not all the progeny of a black queen, mated with an Italian drone, or an Italian queen mated with a black drone show the same markings?

ANS.—For the same reason that no "blood" of two different colorings can be mixed and have the progeny of that mixture show a uniform coloring. Take any of our animals, the horse, the dog, the cat, the sheep, etc.; birds of all colors as to feathering, or the vegetable kingdom, and we find the same laws governing them in this matter of coloring just the same as we find regarding the bees. Plant Hubbard and Marblehead squashes side by side, so that the bees can mix the pollen in the blossoms of each, and see what a mixture of color you will secure as a result. If the progeny of a mated queen should show a uniformity of coloring, bees would be an exception to the laws governing the most of animated creation.

Borodino, N. Y.



Exhibiting Honey at Fairs—Marketing.

BY HON. GEO. E. HILTON.

The time is now at hand when we should begin to arrange for our exhibits at the county fairs, and I hope every county fair will have a honey exhibit. Space can be secured by applying to the Manager now, and although there may be no premiums offered, if you make a good exhibit this fall you will have no trouble in getting premiums another year. I feel like urging these exhibits strongly because there is no better way to advertise and sell your honey.

You can probably get permission to sell the last day, and perhaps all through the fair, providing you don't sell your exhibit until the last. To sell successfully you need hundreds of small packages that you can either give away or sell for five cents each.

At the Canadian fairs and shows you will find little tin receptacles that hold one ounce. They are given away, but they invariably bring one or more customers for a five or ten-pound pail.

Then to introduce their comb honey they have plates with one-pound sections upon them, cut from corner to corner, dividing the section of honey into four equal parts, and leaving each piece stuck fast to the piece of section; and these they sell for five cents each, thus realizing 20 cents per pound for their comb honey, and sending out the best advertisement in the world, to attract attention. They cry "Honey on a stick five cents a lick." I don't know that it has ever been tried in the States, but I see no reason why it will not work. In fact, I know it will, and it makes a much more healthful sweet for the children than the poisonous candies offered for sale at such places.

Now, there are localities where fairs will not be held close enough to attend. In such localities it is a most excellent plan to take a team with a light spring wagon and a load of honey, and go right through the country and small villages. Get acquainted with your more distant neighbors, and you will be surprised to find how much you can sell, and how much pleasure you will receive. I like to get all the pleasure I can out of my work; it shortens the hours and lessens the burden very materially.

Perhaps some of you will object to this latter plan because it savors too much of peddling; but after trying it you will find it a real pleasure and a rest from the regular routine of work. You are doing good in teaching the people the uses of honey, and at the same time are disposing of your honey at home and at remunerative prices, and every year you will find the demand for your product increasing.

By the time this is read the heavier part of the honey-flow will be over, and you should begin to crowd the bees down by removing all the finished sections from each of the two supers you now have on the hives, and putting all the unfinished ones into one super with a view of getting them finished, and avoid carrying over too many unfinished sections. I should prefer not to have any, and begin each spring with new sections and new foundation. I once thought these unfinished sections just the thing to entice the bees into the supers in the spring, and while they may be induced to enter sooner with them, I find they will draw new foundation, ripen the honey, and cap it sooner than they will these old combs; and then its color and general appearance is much superior to that stored in the drawn combs.

This crowding the bees down also has a tendency to cause them to store abundance in the brood department of the hive for their consumption during the coming winter and spring months, or until honey comes in again. It may seem a little early, but my experience is, that it is the only safe way, as we are liable to get early frosts, and unless the winter stores are well ripened and capped over, your bees are not likely to winter well, and unless you have full combs in reserve in case your colonies are short of stores, it is an unpleasant job to feed for winter.

There are a few bee-keepers who extract all the honey, then feed sugar syrup for winter stores, but I cannot endorse this plan. If I find, on preparing my colonies for winter (which I do early), they are short of supplies, they are fed extracted honey or given full frames of honey that have been set aside for this purpose. If sugar syrup never came nearer the apiary than the kitchen or dining-room, I am confident we should hear less about adulterated honey.—Michigan Farmer.
Newaygo Co., Mich.



Fifteen Years' Experience in Bee-Keeping.

BY MRS. SALLIE E. SHERMAN.

(Continued from page 517.)

I had my comb foundation made, never having purchased a mill of my own. I furnished the wax, and had all my heavy foundation made from it, by a man in Austin, Tex., but he could not make the thin to compare to the Dadants, so for all the section honey I produced, I purchased the Dadant thin foundation.

I had at one of our county fairs 87 pounds of bright, beautiful wax of my own making, built up in a pyramidal shape. It attracted a great deal of attention and favorable comment. I always captured the premiums on wax at all the fairs at which I exhibited.

There were a great many droll questions asked me about the various bee-implements I had on exhibition. For instance, one asked me if that was the shape it was in when I extracted it? Another wanted to know if I put the extractor inside of

the hive? Seeing a crowd of dusky maidens examining my large 4-frame extractor, I walked over and asked them how they liked the new-fashioned washing machine? Taking hold of the handle I turned it rapidly, showing them how fast it would sling the dirt out of the soiled clothes, then opening the faucet to show how the dirty suds could be drawn off, and fresh, clean water poured in at the top. By this time there was quite a crowd around the new-fangled "washing machine," to which I had to explain that it was all a joke, and no washing machine at all, but a honey-extractor instead. You may be sure I had lots of questions to answer, and explanations to make. It seemed to attract more attention than anything in the hall.

A nice way to make a small cake of wax for exhibition purposes is to save all the bright cappings by themselves, and when you have enough to make about a four-pound cake just melt and cool it in a cake-pan with ridged or scalloped sides, with a good-sized stem in the middle, which, of course, leaves a hole in the center. If you will first put extracted honey in the pan and see that it is covered all over, then turn bottom upwards to drain, this will cause the wax to come out nicely. Mould two cakes in the same pan and let them cool slowly, so there will be no cracks in the wax, then have a smooth, large tin pan on the stove, warm, put first one and then the other of these cakes, large side down, until they are warm, then place them together, being very exact about getting the ridges or scallops to fit and match nicely. Then just rub with the fingers around where they join, so as to make a nice job. If you are careful, you can join them so nicely that it looks as if it was all in one mould—you cannot tell where they join. I have been asked dozens of questions about how I moulded the wax in that shape, etc.

Then have a small pan to mould a little one, that just fits nicely over the top of the hole, which gives it a nice finish, unless you want to put a little flag on top; if so, just insert the staff in the hole, and it is there to stay.

In Georgia, when I was a child, I used to help my mother bleach wax that we used in making wax-flowers. We had large moulds made on purpose for sheeting the wax preparatory to bleaching, but after a thorough trial they were discarded in favor of common, long-handled gourds that we used for drinking purposes. The moulds would get warmed through, and could not be so readily cooled as the gourds, for the reason that we could dip them full of cold water, as well as let them remain in it, which, of course, caused them to cool much more rapidly, and the wax would slip off them much better than off the wooden moulds. We had to have the wax melted just right, for if it was a little too hot it would not stick properly, and if a little too cool the sheets were too thick, and it would not bleach so readily. The gourds, of course, had been well soaked beforehand, then dip them first in the water and then into the wax and back again into the water, when it would slip off nicely. Oh! such fun as we children did have, sheeting the wax!

It was then laid on nice, clean sheets, and put out to bleach. Of course, if we saw that a shower of rain was coming up, it had to be brought in, that is, if it was put out on the ground or grass to bleach, as mother preferred and thought best; but some times she had it put on top the piazza, in which event the rain did no harm, as, of course, there was no dirt that could beat upon it as it would out on the ground. It, of course, had to be watched and turned occasionally, so the yellowest part would be towards the sunshine. In favorable weather it only took a few days and nights (for the dew seemed to be as essential as the sunshine) to bleach it to snowy whiteness.

After two seasons' trial of queen-excluding honey-boards, I discarded them as a nuisance. I didn't care to be bothered with them.

I greatly prefer wood to tin separators, as the bees seem to enter and work much better in the sections with wood than tin.

In making up the sections I usually wrapped a towel around 75 or 100, and then poured boiling hot water at the joints (I used and preferred the one-piece section holding two pounds), being careful to keep the ends dry. I let them remain say a half hour, then bent and joined them rapidly, giving them a light tap on each side of the joint. This was beautiful work. Having the joints thus damp, it was very rare that a section was spoiled.

After using various kinds of brushes to get the bees off with, I finally decided upon, and for years have used, the wing-feather of a goose. If I failed to have them on hand a turkey-wing feather was used. I don't want a bunch, but simply one large feather.

While working with the bees on one occasion, all at once a swarm began settling on my bee-hat, which was on my head. I stood still and laughed at their selection, when all of a sudden I felt them crawling in my hair on top of my head. There was a little rent in the hat that I was not aware of before, through which they were crawling, all the while keeping up their joyful hum. I very cautiously and carefully lifted the hat off my head and set it on a three-story hive near by. They continued to settle until they were all on the hat, when I carried them to a prepared hive and put them in, where they went to work nicely. They were not from any of my hives, but a swarm that came to me.

For several years I had a certain hive that I called my "drone hive." They were the finest drones I ever saw, and in the greatest abundance, yet it was very strong in workers. That particular queen seemed to take delight in piping or making a very peculiar noise, which could be heard from almost any part of the apiary. It was indeed pitiful to see the drones from this hive in the fall, after they had no more use for them. The workers would drive them out and keep guard to see that none could re-enter. In front of the entrance, on the alighting-board, they would crawl around crying so pitifully, begging so meekly to be allowed to go inside their home where there was an abundance and to spare; yet the heartless little workers were relentless—could not be prevailed upon to share their sweet stores with their big brothers, but actually let them starve to death.

My experience in the swarming of bees is, that the queen never leads a swarm. She generally comes out about midway, sometimes even later.

I have sometimes united weak colonies in the fall, but in the spring I usually give eggs from which to rear a queen, thus building them up to good, strong colonies, by adding frames of brood from such as can spare a frame or two. By strengthening and encouraging the weak ones in this way, I think more than pays for the time and trouble thus gone to.

In getting my supplies, of course a soldering outfit was one of the essentials. Well, I got so I could do quite a neat job along this line. But, presto! the first thing I knew, from various directions, buckets, cups and pans came to be mended. I only got clear of this gratuitous work by telling the parties that I was not running a free soldering shop.

Salado, Bell Co., Tex.

[To be continued.]



Honey as Food and Medicine.—A new and revised edition of this 32-page pamphlet is now issued. It has 5 blank pages on which to write or paste recipes taken from other sources. It is just what its name indicates, and should be liberally distributed among the people everywhere to create a demand for honey. It contains a number of recipes on the use of honey as food and as medicine, besides much other interesting and valuable information. Prices, postpaid, are: Single copy, 5 cts.; 10 copies 30 cts.; 50 for \$1.00; 100 for \$1.75. Better give them a trial. Send all orders to the Bee Journal office.

Notes from Virgil—Something Historical.

BY EMERSON T. ABBOTT.

Some years ago there came into my hands a copy of a translation, with notes, of Virgil's works, made in 1653, by one John Ogilby. His notes on the Fourth Georgic cannot fail to be of interest to bee-keepers, as showing what was known about this industry over 200 years ago. I give the notes as they appear, spelling and all, with some few remarks.

The annotation on the Argument is suggestive. It reads as follows:

"The fourth Book comprehends the choicest rules of the ancients concerning Bees, which suit so well with ours that I have heard an Honorable Lady of Great Judgment (the late Countess of Kent) profess that she made an incredible increase of Bees, confining her servants who attended them precisely to observance of this Book."

On the line,

"Next to Aetherial Honey I'll proceed,"

the translator remarks:

"The poet (saith La Cerda) excellent in Natural Philosophy, subverts the common opinion implying that the bees do not make Honey, but only gather it together and compact it, and therefore calls it Aerial and Celestial. To this assents Aristotle. That Bees make not Honey, but carry only away the falling Dew, may be argued from hence, that in one or two days a Hive may be found full; Besides, if you take away their Honey in Autumn, they cannot recruit it, notwithstanding there are flowers at that time of year. And Pliny, 'Whether it be the Sweat of Heaven, or Spittle of the Stars, or Moisture of the Air purging itself, I wish it were as pure and natural as it first descends; Whereas now falling from so great height, it contracts much of impurity by the way, yet retains much of the pleasantness of its Celestial nature.'"

This was before the days of glucose. Pliny seems to have had some idea of the adulteration craze, even in his time; but he does not tell us whether he thought it done by men or the gods.

"Wars, Labors, Manners, Nations, I'll recite."

"Aristotle," says the translator, "numbers bees amongst civil people. 'For the uses of life (says Pliny) they labor, work, ordain a commonwealth, have their private Councils, their public Warlike Actions, and, which is strangest of all, they have Morality.'"

This looks as though they had rather a high idea of the little workers in early times.

"For your Bee-hives fitting Stations find."

"The Station of Bees must be, according to Varro and Columella, in an open, Sunshiny place, little subject to the injuries of the Weather, far from noise of Men or Cattle, particularly of sheep, because (says Pliny) they cannot easily disengage themselves out of their Wool; He adds that the Hive should open towards the East, if it may be, but by no means to the North. Mr. Butler's rules for a Bee-garden are these: It should be near home; fenced from Cattle and Winds; the East and North fences high, the South (on which side of the house they should set) and West fences good, but not so high, by no means to shadow the South Sun, nor from Sun-Setting; The place Sweet; not very cold in Winter, nor hot in Summer; grassy, but not suffered to grow up too high; beset with Trees and Bushes."

This man had made some progress in solving the "winter problem."

"But their abodes near Chrystal Fountains place
Where purling Streams glide gently through the grass."

"Varro and Columella advise the same as most necessary, that there be Water near the Hives, and, if possible, to run by them, clear for them to drink. So they order Stone and Wood to be thrown into the Water, so as some part may appear out of it for the Bees to sit upon and drink with more ease."

It seems, too, that they began to discuss the question of hives at a very early period. In proof of which note the following:

"Whether of hollow Bark thou dost contrive,
Or else with limber Twigs compose the Hive.
Make straight the Gate."

"Collumella gives a reason why Hives of Bark are best. 'Hives,' saith he, 'are to be made according to the condition of the Country, whether it abound with Bark (doubtless we make most beneficial Hives of Bark, for they are not cold in Winter nor hot in Summer) or whether there be store of Reeds, which being near the nature of Bark, are very proper for this use; if neither of these may be had, they may be woven of Willows; and for want of all a piece of hollow Tree.'"

The translator says, "With us there are but two sorts in use, made of straw and wicker, the first preferred by Mr. Butler."

It is probably needless for me to say again that I have followed the translator in the use of capitals, punctuation, etc.

"Next, when bright Sol makes Winter's cold retreat
Behind the Earth, and opens Heaven with Heat,
Straight they draw out and wander Groves and Woods."

"They go not forth, to work in the beginning of the Spring, but in the midst, or rather, as Pliny observes, in the latter end thereof."

It is of interest to note the idea these people had of the influence of sound upon bees, and also how old is the custom of making a noise to prevent the bees from decamping when they swarm.

"Make a brazen sound,
And beat the Cymbals of the Goddess round:
They on charmed Boughs will stay, or else retreat,
As is the Custom, to their Parents' Seat."

"Bees at the sound of Brass, or other Metals, are so afraid that they light upon the next place. Aristotle ascribes this to the delight they take in the Sound: La Cerda proves the contrary from the same effect at the noise of Thunder.

"The Cymbals of Rhea us'd by the Corybantes at her bringing forth Jupiter, to conceal the cries of the child from Saturn; though Germans observes that Cymbals were likewise us'd in the Orgies of Bacchus. Pliny saith, That bees delight in the tinkling of Brass, and by that means are called together: whereby it is manifest that they have the sense of Hearing. But Aristotle makes a doubt of it whether they stop through delight or fear."

There was no doubt in the minds of these early writers as to bees being able to hear.

"Oft between Two Kings great discord and sad wars have been."

The annotator remarks, "The occasions whereof, according to Aristotle and Pliny, are four, Want of sustenance, Love of the Flowers, Hate of their Neighbors, Pride of their Kings."

Virgil had not gotten away from the idea of a "King Bee."

"The Kings amidst the Train in Armor shine,
And mighty souls in narrow breasts confine."

"That the Kings are eminently distinguished from the rest, is confessed by all that write upon this subject. Pliny saith, 'By their more exact form, as big again as the rest, their Wings shorter, their Thighs straighter, their Walk more erect, amidst their forehead a white spot like a Diadem: Much likewise differ they from the ordinary sort by their Whiteness.'"

St. Joseph, Mo.

(To be continued.)



A New Binder for holding a year's numbers of the American Bee Journal, we propose to mail, postpaid, to every subscriber who sends us 15 cents. It is called "The Wood Binder," is patented, and is an entirely new and very simple arrangement. Full printed directions accompany each Binder. Every reader should get it, and preserve the copies of the Bee Journal as fast as they are received. They are invaluable for reference, and at the low price of the Binder you can afford to get it yearly.

Questions AND Answers

CONDUCTED BY

DR. C. C. MILLER, MARENGO, ILL.

[Questions may be mailed to the Bee Journal, or to Dr. Miller direct.]

Where Did the Eggs Come From?

Some time ago there was about one pint of bees on my honey-house which had no queen, and after trying three days they succeeded in getting through into the house, and soon found some old combs which I had carried into the house nine days previous to the bees finding them. They went to work to rear a queen, and in two days they had two queen-cells started, and I watched them until one of them hatched out, and she was a very fine looking queen. Where did they get the eggs from which to rear these queens? J. L. N.
Cocoa, Fla., July 27.

ANSWER.—It is possible those bees had some kind of a queen after all. A bunch of queenless bees would hardly stick together as these did, but try to enter some hive with other bees. The queen may have been so poor that she laid scarcely any, and the bees at once tried to rear a successor. Strangely enough bees may rear from such a poor queen one that is good.

Wintering Bees—Basswood Trees—Sweet Clover—Borage—Keeping the Women Folks Sweet.

1. Your description was a pretty good one about moving bees in rows to pack for wintering, as you let me know through the Bee Journal. I had packed all except two, and these two wintered better than any of the rest, with the same amount of stores, and we had a severe winter. Bees had a very few flights, and the mercury was from two to ten degrees below zero in the mornings, when I put my ear at the entrance of those two; at such times they were fanning or buzzing at a great rate. They were in single-walled hives, made of $\frac{1}{2}$ lumber. I will not move one hive to pack the coming winter, although I put a half dozen colonies on the south side of a rocky hill to see how they will winter. I wish to see what you have to say, or think. The packed ones were very strong in the fall of 1895, and dwindled away during the winter. Is it the sun during the day? But how then about such cold nights?

2. A year ago last spring I bought two basswood trees; they are now about $1\frac{1}{2}$ inches thick at the ground, and about 10 feet high. I trimmed the roots and cut off all the limbs when planted. How soon will these bloom? Also, I can buy the rest (35) of these same size trees for \$6.00 from a nurseryman. Do you think they are cheap, or not? Would you cut all the limbs off when planting? If so, how close? If I am right, you prefer spring for planting. Will they grow better in low, wet land, than where it is not so wet? Would you advise me to buy the 35 trees? If so, how far apart should I set them?

3. Why is it that I can't get sweet clover seed to come up by scattering it here and there? If I work the land well it comes up. I haven't tried it in the fall. I now have a neighbor farmer, or rather manager of the Elizabeth farms, to fence off a few acres and sow sweet clover in the fall on pasture land. How long would we have to keep 100 sheep on 2 or 4 acres? Would it be best to keep them in and feed them, or would you let them (100 or more) run over it occasionally?

4. I keep about 20 colonies in a yard of 5,000 square feet; would it be worth while to put this yard in catnip, or would you rather have it put in borage? I find bees on borage wet or dry. The yard is of a rich soil.

5. I put on the sections and took them off empty; the season was so wet and cool that bees just made a living, no swarming. What would you do with your women folks, if they were to "jump on your back" for feeding 500 pounds of sugar to the bees in September, if they have all the

sugar they want to put into their coffee, for preserving, baking pies, etc., but no honey? Would you buy honey some place and sweeten them up, or would you just laugh at them? I get my women to read the Bee Journal occasionally.

Brickerville, Pa.

E. B. K.

ANSWERS.—1. It might be a good plan to experiment more than one winter before settling down. Sometimes conditions are reversed, and the results are reversed. Next winter may be so different in some way from the past winter that the two unpacked ones may die and all the rest live. You may do well, however, to leave most of them next winter prepared in the same way as those which wintered best last winter. It's hard to tell very much of the "why" as to wintering. Possibly the few times that bees flew last winter were improved more by the two unprotected colonies than by the others. Suppose a few hours came one day when the sun shone out very hot; the thin walls of the unprotected hives allowed the heat to penetrate, giving the bees a chance to fly, while the thick coatings of the other hives didn't allow the hives to warm through until too late for the bees to fly. But suppose a mild time came, lasting two or three days, barely warm enough for bees to fly; the hives would warm up through the air coming in at the entrance, and not through the shining of the sun. It's just possible that in such a case the bees being warmer in the protected hives might have a flight, while the unprotected ones would not warm up enough. It may be, as you have guessed, that the sun shining on the hives through the day gave the thin-walled hives an advantage which was not offset by the cold nights. Bees will stand a great degree of cold, day or night, if they can have spells of warming up. It isn't so much the severity of the cold as its long continuance that kills bees.

2. Quite uncertain when the two trees will blossom, possibly next year. They will probably bloom younger than they would have done had they not been transplanted, as the root-pruning got at transplanting hastens the fruitage of any tree. Whether it is desirable to pay \$6.00 for the 35 trees depends somewhat upon circumstances. If you have a place where you want a fine row of trees for shade or ornament, it may be a good bargain. Not so certainly if you merely want the trees for honey. For if you don't buy them some one else within a mile or less may get them, and your bees will get just as much from them as if they were on your own ground. How close the limbs should be pruned depends upon how much is left of the roots. If the roots are nearly all cut off, as they too often are, so that the tree can be set in a common water-pail without bending any roots, then better cut the tree back to a straight pole. But that's no civilized way to treat a tree. Get all the roots you can, and in planting spread them out in their natural position, and then you need cut off limbs only to balance the roots lost. Only cut off more of the limbs than you think necessary, for more of the fine roots are lost than you probably suppose. Better cut off too much than not enough. Don't prune the roots at all, only cutting smooth the bruised ends. Plant one or two rods apart.

3. You've probably given the reason yourself why the sweet clover seed scattered didn't come up. You sowed it in spring or summer, and nothing put it under the surface, and it was perhaps picked up by birds. Scatter it in fall, let it be tramped in the mud, and see if it doesn't come. I can't say how long 100 sheep could be kept on 2 to 4 acres, but in the West they would finish up 2 acres in about half the time they would 4. If some one of experience can tell us anything about it I wish he would. Perhaps it might be safe to count on sweet clover as about like red clover, and whatever the farmers in your neighborhood say for red clover might be all right for sweet. And yet it must be borne in mind that stock that has not been accustomed to it will not readily eat sweet clover. Likely it would be best to keep changing instead of keeping stock on it continuously.

4. After trying it, I doubt whether you'd continue to occupy your yard with either catnip or borage. I saw one piece of catnip kept cultivated for bees, but I think it was not considered a paying investment. I think borage is of no value except for its honey, although a few plants are often kept in the flower garden under the name of "Star of Bethlehem."

5. Some women folks are hardly worth the trouble to keep sweet, but such are very scarce. The kind you have, those that read the Bee Journal every now and then, are worth taking a world of trouble for, and if you haven't honey of your own producing, you'd better buy some, even if you have to do as I did last year, get some from another State. I wouldn't give much for your chance if you get those women down on you. Nothing braces a man up like the good opinion of the wingless angels that live in the same house with him.

Brood-Frame Ends—Chaff Cushions—Cleaning Sections of Bee-Glue.

DR. MILLER:—1. I have noticed several of your articles in the American Bee Journal on the subject of spacing frames. In one of them you spoke of cutting off the ends of the top-bars to prevent their being stuck to the hive with propolis. I have found the following plan to work well, and would like you to give it a trial, and report through the papers if you think it a success:

Bevel off the ends of the top-bars on the upper side, so that the ends which come in contact with the hive are shaped like a blunt chisel. This preserves the correct length, and is simpler than anything I have seen suggested. With a sharp pocket-knife it will take only a few minutes to prepare a set of frames for experiment.

2. Should the chaff cushions used for winter packing, as described in Root's "A B C of Bee-Culture," fit in the hive bee-tight on all sides?

3. I find that sections while in the hive become dark on top (I use section holders with a $\frac{1}{4}$ inch bee-space above the sections), while the other three sides remain clean and white. Can they be scraped clean and white again? If so, what is the best implement?

R. B. H.

ANSWERS.—1. I can hardly see that making a chisel edge of the end of the top-bar would take away all the trouble, although it may be an improvement. It will still leave the line of glue over the top, and the angle being acute it would make a little more glue filled in. Still, if you know from actual trial that it's an improvement, that ought to settle it for you. But when you go at the whittling business, why not make the sharp edge up and down, making it wedge-shaped?

2. As nearly bee-tight as possible, otherwise bees will get through and not find their way back.

3. Yes, you can make good work scraping them clean with a common steel case-knife. Keep the knife pretty sharp on a rather rough stone, so as to have a sort of saw edge, then scrape with the edge of the knife held at right angles to the surface of the section. Don't take a hot day for it, or you'll wish you were in some other business. When cool, the bee-glue is brittle, and will scrape off easily. Don't leave the sections on a day after the flow of honey ceases. Then's the time the gluers get in their work. More glue will be daubed on in a day in August than in a week in June.

Only One Cent a Copy for copies of the American Bee Journal before Jan. 1, 1896. We have them running back for about 10 years. But you must let us select them, as we cannot furnish them in regular order, and probably not any particular copies. Just send us as many one-cent stamps as you may want old copies, and we will mail them to you.

The McEvoy Foul Brood Treatment is given in Dr. Howard's pamphlet on "Foul Brood; Its Natural History and Rational Treatment." It is the latest publication on the subject, and should be in the hands of every bee-keeper. Price, 25 cents; or clubbed with the Bee Journal for one year—both for \$1.10.

OLDEST BEE PAPER IN AMERICA ESTABLISHED IN 1861

THE AMERICAN BEE JOURNAL

GEORGE W. YORK, Editor.

PUBLISHED WEEKLY BY

GEORGE W. YORK & COMPANY,

118 Michigan St., CHICAGO, ILL.

\$1.00 a Year—Sample Copy Sent Free.

[Entered at the Post-Office at Chicago as Second-Class Mail-Matter.]

Vol. XXXVI. CHICAGO, ILL., AUG. 20, 1896. No. 34.

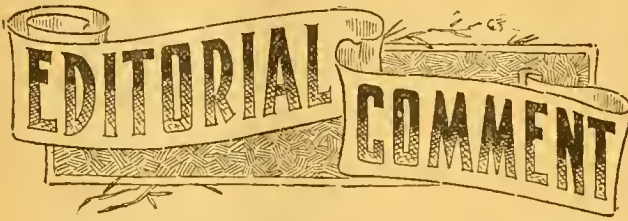

Bee-Sting Specific.—It is stated in the scientific papers that quinine dissolved in ammonia is a much better specific for the sting of a bee than is ammonia alone.

The Union and Canada.—Mr. H. Miller, of Canada, wishes this question answered in the American Bee Journal:

MR. YORK:—If I become a member of the National Bee-Keepers' Union, do I enjoy the same benefits as a citizen of the United States, i. e., does its good offices cover Canada? Please answer in the Bee Journal, as some of us have been debating the question. H. MILLER.

Yes, according to the present Constitution of the Union, Canadian members are entitled to the same benefits as those residing in the United States. But it may not always be so. We should think it would be a good thing for Canada to have a "Canadian Bee-Keepers' Union" all their own, as doubtless the laws of both countries are quite different, and there might be some difficulty in operating such an organization in a country foreign to where it was formed. We believe no case has ever been defended by the present Union in Canada—neither have more than two or three of its members been Canadians.

Without desiring to meddle with the business of our good friends "over the line," we would suggest that the Canadian Bee Journal might find an opportunity in this matter to render great service to its constituency, should it inaugurate some plan whereby the bee-keepers of that country could become members of an organization having for its object a similar one to our National Bee-Keepers' Union. We think a very strong one could be maintained in a land so famous for its excellent honey as well as for its progressive bee-keepers.

The California Honey Crop for this year has often been reported as being almost an entire failure, but this from Gleanings for Aug. 1, by Mr. W. A. H. Gilstrap, dated July 10, rather seems to contradict the failure report:

"The honey season in California, we are told, is practically a failure all along the line. Eastern honey will have little if any competition from the Pacific Coast." So reads an editorial in Gleanings for July 1. This mistake is pardonable in an Eastern editor when a California writer (Rambler) says on page 487 of the American Bee Journal for 1895, that California honey is produced before the Eastern markets are established.

To enlighten the above, let me say that we have a place

in the Golden State that we call the San Wau-keen Valley (spelled, or, rather misspelled, "San Joaquin"). This part of the State is not considered in the above, and yet we produce honey every year. The king of honey-producers in this valley is Mr. Daugherty, of Bakersfield, with only 1,400 colonies, I am told. I know perhaps 20 men who produced over 8 tons each last year. Bees are now fairly started on storing surplus, which was not true one year ago. What I mean by "fairly started," is for all colonies to be at work and surplus being removed from the stronger ones. The season closes anywhere from Aug. 30 to Oct. 5, depending on season and locality. Perhaps you will see from 20 to 40 carloads of our honey beyond the Rockies later in the season, which would keep California in the ring until the southern part of the State gets another crop. W. A. H. GILSTRAP.

Let's see, there are something like 24,000 pounds in a carload of honey; and 40 carloads would be about 960,000 pounds—quite enough to sweeten a good many pancakes. Surely, California is still "in the ring" so far as honey is concerned. But we yet contend that if all the honey were evenly distributed, there would never be enough to supply the demand for the pure article.

The Preparation of Honey for Market is a subject that cannot be harped upon too much. We have not forgotten some of the unsightly sights that we saw last year in some of the honey commission houses in this city, in the line of honey supposed to have been put up for a respectable market.

In these times of closest competition, it behooves every one to put up honey in as neat and attractive a manner as possible. When it comes to receptacles for extracted honey, or shipping-cases for comb honey, only the very best must be used. It will not pay to try to save a few cents in this, and run the risk of losing dollars when your honey reaches the market.

The trade in various cities or localities often varies in its requirements as to style and size of package. Hence, it will be wise to first learn just what is demanded, and then comply therewith as nearly as possible. If your dealer's customers want comb honey in 24-pound single-tier shipping-cases, see to it that they are accommodated. Some people are whimsical, and yet if they are willing to pay for being so, no one need object.

Another thing—and it has been spoken of so often—whatever you do, be sure to clean every section of honey of every particle of bee-glue, scraping them thoroughly, if necessary, in order to attain the object. A little time spent in this will not be lost.

Also, grade your comb honey when putting it into shipping-cases; and let the sections next to the glass front be fair samples of those further back.

Some dealers object to the producer's post office address being on each case or section, but we think none will care if only the name appears. We believe it would be a good idea for every bee-keeper to put his name upon every section of nice honey that leaves his apiary. This can be done easily and rapidly with a rubber stamp. Then the consumer can call for more of Mr. So-and-So's honey, and a demand will thus be created.

Other ideas will no doubt suggest themselves to every wide-awake producer of honey who reads this. As in most other things, it will pay well to use brains in the preparation of honey for the market.

Improvements in Bee-Culture.—Referring to this subject, Editor Root gives the following paragraph in Gleanings:

Some time ago it was asserted that no very great improvements might be expected in the line of bee-culture; that we had about attained perfection. If I am any judge of apicultural progress, there are still some great advances yet to be

made over our old methods. Just as soon as we drop into that rut, with the feeling that we have "got there," and don't need to try to better ourselves, just so soon shall we fail to make progress. I cannot think we have reached perfection in anything relating to bee-keeping yet. I believe, first of all, we need and shall have foundation with deep cell-walls and thin base; that along with this improvement will come at least partial control of swarming. I believe still that there is a chance for improvement in styles of brood-frames; and there is still something yet to learn as to the best size of hive.

No doubt Mr. Root is correct in his opinion on this subject, but we wish to suggest, to those who may think of attempting the invention of some apiarian article, to be sure they know what has already been invented. So many "go it blind," as it were, and find in the end that they have simply "re-hatched" something that perhaps has been tried and discarded long ago. It will pay first to ascertain what has been invented, before wasting valuable time, and may be money, also.

Another thing: Nearly every one-year-old beginner is apt to think that he can invent a good deal better hive than Langstroth, Dadant, Root, or any one else ever dreamed of! Well, may be he can, but more than likely he can't. So our advice would be, to keep bees at least five years before attempting to patent a new hive; by that time, or 10 years later, you may discover that it has never paid to patent a hive—that the best general hives are mainly unpatented; and that there is much that every beginner has to learn before he aspires to lead the veterans.

Minnesota Fair and Apiarian Exhibit.—

We have received the Premium List of the Minnesota State Fair, from the Superintendent of the apiarian exhibit, Mr. J. P. West, of Hastings, Minn. The fair will be held at Hamline, Aug. 31 to Sept. 5, and the liberal cash premiums offered on bees, honey, and apiarian supplies, are as follows:

	1st.	2nd.	3rd	4th.
Most attractive display and best quality of white clover honey.....	\$12	\$10	\$5	\$3
Most attractive display and best quality of basswood or linden comb honey.....	12	10	5	3
Most attractive display and best quality of extracted white clover honey.....	12	10	5	3
Most attractive display and best quality of extracted basswood or linden honey.....	12	10	5	3
Most attractive display and best quality of fall comb honey.....	12	10	5	3
Most attractive and finest display of comb honey.....	8	5	3	2
Most attractive and finest display of extracted honey.....	8	6	5	4
Most attractive and finest display of comb honey, not less than 20 lbs., and the manner of putting up for market considered..	8	5	3	2
Nucleus of Italian bees and queen.....	6	4	3	2
Collection of different races of queens.....	6	4	3	2
Beeswax, not less than 10 lbs., soft, bright-yellow to have the preference.....	5	3		
Honey-vinegar, not less than one gallon, to be exhibited in glass.....	3	2		
Display of apiarian supplies and implements	12	5		
Largest and best variety of uses that honey may be applied to; illustrated by individual samples of different things into which it enters: cakes, pastry, meats, etc.....	10	5		

GRAND SWEEPSTAKES.

Largest, best and most attractive exhibition in this department, all things considered..	15	8
--	----	---

For copy of the Premium List of the whole fair, containing rules governing exhibits, etc., write to Mr. West, as above. All apiarian exhibits should be addressed to "E. R. Randall, Minnesota Transfer, Minn., State Fair Exhibit, Div. H."

Every Present Subscriber of the Bee Journal should be an agent for it, and get all others possible to subscribe for it. See Great Campaign Book offer on page 538.

PERSONAL MENTION.

MR. J. B. RAMAGE, of Whatcom Co., Wash., wrote in a letter dated July 27: "Tell Dr. Miller to come to Washington to get dandelion bloom in September and October."

MR. B. TAYLOR, of Forestville, Minn., we are pained to announce, died Sunday, Aug. 9. Just as we were closing the forms for this issue, we received the following letter telling us the sad news:

FORESTVILLE, Minn., Aug. 10, 1896.

DEAR MR. YORK:—After a long illness, our father (B. Taylor) passed from all earthly suffering last Sunday morning. Yours respectfully, JEWELL TAYLOR.

Our sincerest sympathy is extended to all the bereaved ones. We hope soon to be permitted to publish a biographical sketch and portrait of our departed brother.

MESSRS. VAN ALLEN & WILLIAMS, of Wisconsin, report that their trade has been very satisfactory this season, especially the queen-trade, having sold a large number of queens, and orders still continue to come in. With them this year has been the best season for queen-rearing that they ever experienced; they say the conditions have been very favorable for rearing the best of queens at the least expense. They make a specialty of rearing queens from cells built under the swarming impulse, because they believe they give better satisfaction than queens reared in any other way.

DR. MILLER reported in Gleanings that on July 15 he had "4,439 finished sections in the house, and more to follow." We feel like extending our congratulations, as we presume he means they are sections filled with honey, though he doesn't say so. After having so many poor honey seasons, we would think that the Doctor would feel like telling the whole thing, and not leave his readers to infer so much. "Finished sections" are one thing, and "finished sections of honey" are quite another. Any one with the money can get plenty of the former at any time, but money won't always procure the latter.

Hurrah for the Doctor and his "finished sections" of honey! We hope by this time he can report a full 10,000 of them.

In another "straw" Dr. M. tells of his "honey-shower" thus:

"This year keeps up its record as a fast one. I took off my first finished super of sections June 20—two or three weeks earlier than ever before. July 15 I took the fifth super from one hive."

In commenting on this, Editor Root lets himself loose in this kind of a style:

"Whew-ation, Doctor! (Excuse slang; but as I can't throw my hat up high enough for you so that every one can see it, I had to use something else than common English.) I have several times advised you to 'pull up stakes' in view of your repeated yearly failures of the honey crops; but if you had followed my advice it would have been just your luck to drop into some locality where there was no honey, not even this year. Notwithstanding my foolish advice to you, I have repeatedly advised bee-keepers to stay where they are, and the wisdom in such advice has been demonstrated again and again by a final onslaught of honey, such as you have just been having. There is no reason why you should not have a lot more such good seasons. The spell is broken; the seasons of drouths are being replaced by copious rains, so necessary to the growth of white clover. As I write, it's raining hard, and we have been getting from one to two good rains a week."

LATER.—In a letter to us, dated Aug. 13, Dr. Miller says:

"The season here is holding out remarkably. Although honey is coming in slowly it is still coming in, and we are kept busy taking out sections and putting back the unfinished ones to be finished. Nearly all colonies are now reduced to one super each, whereas in the height of the season some had as high as five or six, and needed them, too."

THE GREAT CAMPAIGN

—OR:—

Political Struggles of Parties, Leaders and Issues

COMPRISING

Biographies of the Republican, Democratic,
Populistic, Prohibition and National
Nominees for President and Vice-President
of the United States.

—ALSO—

The Platforms, Principles and Leaders of All Parties

DISCUSSING

ALL VITAL QUESTIONS OF THE DAY

HAVING AS ITS OBJECT

The Enlightenment and Education of American

—VOTERS—

Upon the Living Issues of the Hour.

The Gold Standard of Currency, Bi-Metalism, Free Coinage of Silver, High Protective Tariff, Tariff for Revenue Only, Prohibition, Licensed Liquor Traffic, the Doctrine of Reciprocity, the Monroe Doctrine, Laws Governing Our Relations with Other Nations, the Venezuelan, Armenian and Cuban Questions. Containing also Lives and Portraits of former Presidents, with a Review of their Administrations and the Political Lessons gleaned from them; together with a Portrait Gallery of Statesmen and Political Celebrities comprising 100 accurate Phototypes and other Portraits, embracing the most active and prominent statesmen in our Nation. The whole forms a Voter's Hand-Book of Political Information, thoroughly practical, enjoyable and instructive, enabling him to vote intelligently upon those vital subjects which constitute the living issues of the present great campaign.

This book embodies the views and opinions of the great leaders from the various party points of view, clearly explaining all the momentous questions now before the people. It is planned upon the broad principles of non-partisan national patriotism, and attacks no man's creed, and upholds the ban-



McKinley.



Bryan.

ner of no party; but placing every party and its principles, with its leaders upon its own platform, and bringing the several parties, platforms and champions in their true light before the mind of the reader, the intelligent citizen will, in this book, be enabled to view and compare them side by side and judge of their respective claims upon his vote as an

American citizen. It is a vast storehouse of truth, plain, simple and unvarnished, which makes this work an unequalled source of information upon the great issues of this campaign, suited to the wants of every voter irrespective of party and without partisan bias.

Our Country calls for thirteen million volunteers. "I do love my country's good with a respect more tender, more holy



Levering.



Bentley.

and profound than mine own life," is the language which Shakespeare puts into the mouth of an ideal patriot. May this sentiment find a universal echo in the hearts of the voters of the United States of America who go to the polls in November, 1896.

Great questions are to be settled; a mighty battle is to be fought; a battle of ballots such as this country has never witnessed, which, in its far-reaching effects, will accomplish on the field of American suffrage, at the Ballot Box, next November, results as potential for good or evil to our Nation, revolutions as radical, and effects as lasting upon our institutions, as were ever wrought upon the field where sword and bullet, grape and canister settled the issue of the hour.

An impartial view of the situation reveals the fact that our Country never needed more broad-minded wisdom and unselfish patriotism in all her history than she requires to guide her through the present crisis.

Since the rising war cloud of 1859-60 which deluged our Country in the blood of brothers, our Nation has not been so agitated, divided and excited as it is to-day from ocean to ocean—North, South, East and West, on the great financial question, which is a vital issue of this campaign; and its settlement is fraught with threatenings and omens indicating political combinations, upheavals and surprises which our shrewdest politicians seem unmindful of or unwilling to recognize.

Since 1873 the mutterings of discontent have been growing louder between the advocates of Gold and Bi-metal standards. During the past three years, these mutterings have grown into clamorous shouts and peremptory demands on both sides. Statesmen never thought so diligently or more deeply on any subject; and the whole country never was so eager to have all sides of this momentous question presented in a clear, lucid and intelligible manner which the common reader can understand—the money question.

The Doctrine of Reciprocity is also treated at length from a broad, patriotic and non-partisan point of view.

This volume contains about 600 pages, is printed on super-calendered paper, and bound in beautifully lithographed board covers. The pictures of the four principal Presidential candidates shown herewith appear on the front outside cover, and the Vice-Presidential candidates on the back cover.

How to Get the Above Book.

Send \$1.00 and receive it postpaid. Or, send us two new subscribers for the Bee Journal at \$1.00 each, and we will mail you the book free as a premium. Or, for \$1.75, we will mail you the book and the Bee Journal for one year. Address,

GEORGE W. YORK & CO.,

118 Michigan Street, CHICAGO, ILL.

General Items.

An Old-Time Honey-Year.

We have had as fine a flow of honey this year as could be asked for, from basswood. This is an old-time honey-year. I started with ten colonies, increased to 22, and have taken 500 pounds of honey so far, part taken off, and the rest all ready to be taken off. There is a fine prospect for a fall flow.

The Bee Journal is better than ever. Success to it. F. M. POLAND.
Freedom, Maine, Aug. 5.

Half a Crop Promised.

I have 100 colonies of bees, located ten miles from the mountains, in a small valley where alfalfa is the staple product. As few leave their alfalfa to mature seed, the bees get a brief benefit. The hay-makers begin cutting before the bloom is fully out. Greasewood yields a clear honey of excellent quality. May and June were drouthy months here in southeast Colorado, and bees swarmed but little—not more than one swarm from ten colonies. The yield of honey promises to be half a normal crop. Bees are healthy. S. W. DEBUSK.
Downing, Colo., Aug. 10.

Salt for Bee-Paralysis.

Who knows that salt is not an antidote for bee-paralysis? For years I have given my bees salted water, and never have had the disease in my apiary. And now comes a Mr. Williams—quite a prominent bee-keeper—and says that he always cures the bees of that disease by sprinkling them and the inside of the hive, combs and all, with quite strong salted water. He makes it so strong with salt that it shows on top of the frames when dry. He has sprayed colonies at night, that were very bad with the disease, and in the morning they were all right. When I was a boy, the rule was to wash the inside of the hive with strong brine, in order to make the bees stay in the hive. Of course we rattled tin pans, rang bells, and as a last resort fired off the old musket, to make them cluster. We lose all of that fun now. Santa Ana, Calif. DR. E. GALLUP.

Foul Brood.

I send you sample of foul brood. I do not know what condition it will be in when you receive it, but when I took it out of the hive the day that I sent it to you it was as fine a looking piece of brood as you generally find, but it is foul brood of the worst kind, all the same. Although this brood apparently looked perfect when taken out of the hive, not more than one in 20 of our bee-keepers would know or even believe it to be foul brood, but if you will examine the brood-cells carefully you will find half or more of the larvæ to be what is called the wrong or backward presentation. At this stage of the disease, although it has been in the hive for three weeks, all with the head or proper presentation will hatch out, but as the disease progresses, in time all or nearly all, of the young larvæ become affected by it. I have often found this a sure symptom or

THE "NOVELTY" POCKET-KNIFE!

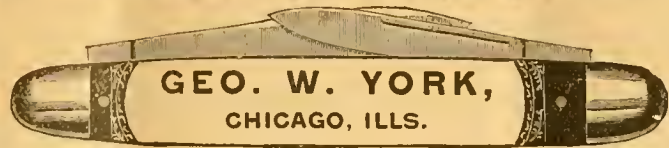

Your Name on the Knife.—When ordering, be sure to say just what Name and Address you wish put on the Knife.

The NOVELTY KNIFE is indeed a novelty. The novelty lies in the handle. It is made beautifully of indestructible celluloid, which is as transparent as glass. Underneath the celluloid, on one side of the handle is placed an AMERICAN BEE JOURNAL reminder, and on the other side, name and residence of the Subscriber.

The material entering into this celebrated knife is of the very best quality; the blades are hand-forged out of the very finest English razor-steel, and we warrant every blade. The holsters are made of German silver, and will never rust or corrode. The rivets are hardened German silver wire; the linings are plate brass; the back springs of Sheffield spring steel, and the finish of handle as described above. It will last a lifetime, with proper usage.

Why purchase the Novelty Knife? In case a good knife is lost, the chances are, the owner will never recover it; but if the Novelty is lost, having name and address of owner, the finder will return it; otherwise to try to destroy the name and address, would destroy the knife. If traveling, and you meet with a serious accident, and are so fortunate as to have one of the Novelties, your pocket KNIFE will serve as an identifier; and in case of death, your relatives will at once be apprised of the accident.

How appropriate this knife is for a Christmas, New Year or birthday present! What more lasting memento could a mother give to a son, a wife to a husband, a sister to a brother, a lady to a gentleman, or vice versa, a son to a mother, a husband to a wife, a brother to a sister or a gentleman to a lady—the knife having the name of the recipient on one side?

The accompanying cut gives a faint idea, but cannot fully convey an exact representation of this beautiful knife, as the "Novelty" must be seen to be appreciated.

How to Get this Valuable Knife.—We send it postpaid, for \$1. , or give it as a Premium to the one sending us three new Subscribers to the BEE JOURNAL (with \$3.00), and we will also send to each new name a copy of the Premium Edition of the book "Bees and Honey." We club the Novelty Knife with the BEE JOURNAL for one year, both for \$1.90.

Any Name and Address Put on the Knife.

GEORGE W. YORK & CO.,
CHICAGO, ILLS.

Allow about two weeks for your order to be filled.

PATENT WIRED COMB FOUNDATION

Has No Sag in Brood-Frames
Thin Flat-Bottom Foundation
Has No Fishbone in the Sorplus Honey.
Being the cleanest is usually worked the quickest of any Foundation made
J. VAN DEUSEN & SONS,
Sole Manufacturers,
Sprout Brook, Montgomery Co., N. Y.



ONE MAN WITH THE UNION COMBINATION SAW

Can do the work of four men using hand tools, in Rippling, Cutting-off, Mitring, Rabbeting, Grooving, Gaining, Dadoing, Edging-up, Jointing Stuff, etc. Full Line of Foot and Hand Power Machinery Sold on Trial. Catalogue Free.

SENECA FALLS MFG. CO.,
46 Water St., SENECA FALLS, N. Y.
1 A1y Mention the American Bee Journal.

WARRANTED GOLDEN ITALIAN QUEENS By return mail; bred from a Breeder tested by DoLittle out of 1,000 Queens for his own use, and valued at \$50. Queens, 50c; 6 for \$2.75; or \$5.00 per dozen.
Leather Colored Queens from Root's best imported stock same price. Bees from my Queens are excellent workers on red clover. I guarantee safe delivery. N. B.—I sent more than 200 Queens safely to California last season. **H. G. QUIRIN, Bellevue, Ohio.**
34A9 Mention the American Bee Journal.

Untested Italian Queens, 75c.

3 FOR \$2.00.
Catalogue of Apiarian Supplies Free.

I. J. STRINGHAM,
105 Park Place. NEW YORK, N. Y.
APIARY—Glen Cove, L. I.

That Queen-Clipping Device Free!

Works Like a Charm.

The Monette Queen-Clipping Device WORKS LIKE A CHARM. With it I have clipped 30 queens, all in one day, when examining my bees. **WM. STOLLEY, Grand Island, Nebr.**

Couldn't Do Without It.

I have clipped 19 queens, and must say the Monette Queen-Clipping Device is by far the best invention ever made, and will be welcome to many bee-keepers as it was to me. I could not do without it now.
DR. GEO. LACKE, Newburgh, Ind.

PLEASE READ THIS OFFER TO PRESENT SUBSCRIBERS:

Send us just our new name for the American Bee Journal a year (with \$1.00), and we will mail you the Queen-Clipping Device FREE of charge. Or, the Queen-Clipping Device will be sent postpaid for 30 cts. But why not get it as a Premium by the above offer? You can't earn 30 cts. any easier. Almost every bee-keeper will want this Device. See page 130 (Feb. 27) for full description of it. Complete directions accompany each one sent out. It is a most ingenious and useful article. Address,

GEORGE W. YORK & CO., 118 Michigan St., Chicago, Ill.

✦ MONEY SAVED IS MONEY GAINED. ✦

THE ROYAL UNION Life Insurance Company DES MOINES, IOWA.

The Iowa Policy

Is one that definitely promises to keep an accurate account with you; credit your premiums and interest, charge the actual expense and mortality cost, and hold the remaining funds subject to your order. Agents Wanted.

JOHN B. KING, GENERAL AGENT,
Suite 513 First Nat'l Bank Bld'g,
20A1f **CHICAGO, ILL.**

Our New 4-page Catalog

Contains testimonials from F. A. Gemmill, Wm. McEvoy, Inspector of foul brood for Canada; also many others from those who have tested the Adel bees. All testimonials came in since June 1, 1896. I challenge any queen-dealer in the world to produce such large, fine Queens as I am now sending my customers. "WE GET THE BEST QUEENS FROM YOU," so say a large majority of our patrons. I cannot supply 50-cent Queens—I do not rear that kind. Every one of my Queens is worth \$5.00. But I sell one for \$1.00; 3 for \$2.50; 6 for \$4.50; and 12 for \$8.00. No swarming, no stinging, and no disease among the Adels. A. I. Root Co. have six of as fine Adel Queens as any man can boast of. Can ship by return mail. Send for Catalog.

HENRY ALLEY, Wenham, Mass.
32A1f *Mention the American Bee Journal.*

IF YOU WANT THE BEE-BOOK

That covers the whole Apicultural Field more completely than any other published, send \$1.25 to Prof. A. J. Cook, Claremont, Calif., for his

Bee-Keeper's Guide.

Liberal Discounts to the Trade.

California

If you care to know of its Fruits, Flowers, Climate or Resources, send for a Sample Copy of California's Favorite Paper—

The Pacific Rural Press

The leading Horticultural and Agricultural paper of the Pacific Coast. Published weekly, handsomely illustrated, \$2.00 per annum. Sample Copy Free.

PACIFIC RURAL PRESS,
220 Market St., - SAN FRANCISCO, CAL.

MUTH'S HONEY EXTRACTOR PERFECTION Cold-Blast Smokers,

Square Glass Honey Jars, Etc.
For Circulars, apply to CHAS. F. MUTH & SON,
Cor. Freeman & Central Aves., Cincinnati, O.
Send 10c for Practical Hints to Bee-Keepers.

CARLOADS



Of Bee-Hives, Sections, Shipping-Cases, Comb Foundation, and Everything used in the Bee-Industry.

I want the name and address of every Bee-Keeper in America. No reason why you cannot do business with me. I have

Cheap Lumber and Experienced Workmen; a good Water Power Factory and know how to run it. I am supplying Dealers as well as consumers. Why not you? Send for Catalogues, Quotations, etc. **W. H. PUTNAM,**
1E RIVER FALLS, Pierce Co., Wis.

Mention the American Bee Journal.

proof of foul brood in bees five or six weeks before this brown, stinking, sticky, coffee-colored appearance would develop in the hive.

Sometimes through ignorance, and often from an over-desire to save all the nice-looking brood till it hatches out, the disease is nursed along by some bee-keepers till the whole becomes a rotten mass. Is it any wonder that the disease spreads under such conditions? If this matter was written up more by our bee-papers, and if it was more a subject of discussion in our bee meetings or conventions, it would have a tendency to educate our bee-keepers in the matter, and it would also assist materially in checking and obliterating the disease from among the bees. We find it is very hard to get a good law on foul brood, because you cannot get the legislators to view the matter in the light that the bee-keepers do, therefore a law of education is absolutely necessary.

E. S. LOVESY.

Salt Lake City, Utah, July 2.

[The specimen of foul brood was received all right. We showed it to an old bee-keeper who has had experience with foul brood of the worst kind, and he was inclined to think that the sample was not so very bad. Yes, there cannot be too much information scattered around concerning the disease.—EDITOR.]

Keeps Bees in Mexico.

At the present time I am 450 miles from a railroad. I have 5 colonies of bees. I captured a fine swarm over two years ago, and with little or no attention I have honey the year through.

JAMES G. SAMPLE.

Chihuahua, Mexico.

Marketing Honey.

Referring to the editorial in the Bee Journal of July 2, on the marketing of honey, I would say that I make the most by selling to the consumers. I put up the honey in 2½, 5, and 10 pound buckets, and get 8½ to 10 cents a pound for all my honey.

W. H. NALL.

Motz, Ark.

Some Hens Eat No Bees.

Mr. S., A. Deacon, on page 500, asks if bees do catch bees. I would say no, as I have kept from 100 to 150 pure-bred Leghorns, and from 20 to 160 colonies of bees side by side, and for the last eight years, and never have seen a hen or chick eat a worker-bee. They once in a while will pick up one, but shake their heads and drop it again; but they do eat drones, and will pick up brood which the bees throw out from the entrance.

C. F. LANG.

La Crosse, Wis.

Figwort and Sweet Clover.

Please inform me where I can get a few seeds of the honey-plant "figwort." I see that we must raise bee-fore here before we can succeed with bees. I obtained some sweet clover seed two years ago, which I scattered out along the roads in several directions for a mile or more; last fall I did the same, but I have never seen a sprig of it, except a

Honey-Clovers & Buckwheat SEED FOR SALE.

We have made arrangements so that we can furnish seed of several of the Clovers and Japanese Buckwheat, by freight or express, at the following prices, cash with order

	5lb	10lb	25lb	50lb
Alsike Clover	\$.70	\$1.25	\$3.00	\$5.75
Sweet Clover	.75	1.40	3.25	6.00
White Clover	1.25	2.00	4.50	8.00
Alfalfa Clover	.65	1.10	2.70	5.00
Crimson Clover	.55	.90	2.00	3.50
Jap. Buckwheat	.20	.35	.90	1.25

Prices subject to market changes.

Add 2 cents in your order, for cartage, if wanted by freight.

Your orders are solicited.

GEORGE W. YORK & CO.,
CHICAGO, ILLS.

Sweet Clover & Canada.

At the following prices:

5 lbs.	10 lbs.	25 lbs.	50 lbs.
\$1.00	\$1.60	\$3.75	\$7.25.

Also a quantity of Motherwort and Catnip seed. Prices on application.

EGGS for Hatching. Buff Leghorns, Indian Games, & Light Brahmas. Ch. Ice Brds. A breeder for 30 years. Prices on application

JOHN HEARTHUR,

881 Yonge Street, - TORONTO, ONT.
15A1f *Mention the American Bee Journal.*

Extracted Honey



Finest Quality. Basswood and Clover.

2 60-lb. cans in case 8c. per pound. 1 60-lb. can in case, 9c. per pound. A sample by mail, 10 cts. **POUDER'S Honey-Jars and Complete Line of Supplies.** Catalogue Free.

WALTER S. POUDEF,

162 Mass. Avenue, INDIANAPOLIS, IND.

Mention the American Bee Journal.

HONEY We have No. 1 Alfalfa, also White and Sweet Clover Honey we will sell cheap.

Honey and Beeswax Wanted.

Boss bee-escape Warranted the best, simplest and quickest Escape on the market. Sent postpaid to any address for 30 cts. It can be returned at our expense if it is not as represented, or we will send the Escape on trial to any bee-keeper wishing to test it in good faith. We are agents for the **Ferguson Patent Hive** with double-case Super and Wicket-Gate Honey-Board, with the Escape. It is the easiest, quickest hive to handle for the production of comb or extracted honey.

E. S. LOVESY & CO.,

355 6th East St., SALT LAKE CITY, UTAH.

Mention the American Bee Journal. 9A1f

Van Deusen Foundation!

I have some of the celebrated Van Deusen Thin Foundation in 25-pound boxes, that I will put on board cars for \$12.50 per box.

Also ITALIAN

Queens!

Queens!



Fine Untested Queens mailed PROMPTLY at 55 cts. each, or Six for \$3.00.

Safe delivery and satisfaction guaranteed. Address.

F. GRABBE,

LIBERTYVILLE, Lake Co., ILL.

26A1f *Mention the American Bee Journal*

READERS Of this Journal who write to any of our advertisers, either in ordering, or asking about the Goods offered, will please state that they saw the Advertisement in this paper.

No. 1 Sections—Cheap.

We offer for a few weeks, a surplus stock of our one-piece No. 1 Cream Sections at the following very low prices:

1000 for \$1.50.

3000 for \$4.00.

5000 for \$6.00.

These Sections are finely finished and No. 1 in all respects save color, being, as their name indicates, of a cream color.

The stock consists of a quantity each of the following sizes:

4½x2, open 2 sides 4¼x1 15-16, open 2 sides

4¼x1 7-8, open 2 sides

4¼x1½, open 2 sides 4¼x7-to-ft., open 2 sides

G. B. LEWIS CO.

WATERTOWN, WIS.

ITALIAN QUEENS

Golden or Leather-Colored!
BY RETURN MAIL.

Choice Untested, 50c.; Tested, 75c. Full Colonies cheap. No disease. Remit by express M. O. payable at Barnum, Wis. Many customers send \$1.00 and \$2.00 bills. 2c. stamps taken for less than \$1.00. Safe delivery and satisfaction guaranteed.

VAN ALLEN & WILLIAMS,
BARNUM, WIS.

29Atf Please mention the Bee Journal.

Page & Lyon Mfg. Co.,

NEW LONDON, Wis., operates two saw-mills that cut, annually, eight million feet of lumber, thus securing the best lumber at the lowest price for the manufacture of bee-keepers' supplies. They have also just completed one of

The Largest Factories,

and have the latest and most improved machinery for the manufacture of Bee-Hives, Sections, etc., that there is in the State. The material is cut from patterns, by machinery, and is absolutely accurate. For Sections, the clearest and

The Whitest Basswood

is used, and they are polished on both sides. Nearness to pine and basswood forests, and possession of mills and factory equipped with best machinery, all combine to enable this firm to furnish the best goods at

The Lowest Prices. ♡♡

For instance, it has a job lot of 200,000 No. 2 Sections that will be sold at 50 cts. per 1,000; or 2,000 Snow-White sections will be sold for \$4.00, and larger quantities at still lower prices. Send for Circular and see the prices on a full box of supplies. 16Atf

Mention the American Bee Journal.

A Bargain—EARLY QUEENS.

119 Colonies Italian Bees in Chaff Hives; two acres land; good house; excellent well.

Early Queens—Tested, \$1.00; Untested, 50c. Sent by return mail.

E. L. CARRINGTON,

16Atf PETTUS, Bee Co., TEX.

Reference—1st National Bank of Beeville.

Mention the American Bee Journal.

Bee-Keepers' Photograph.—We have now on hand a limited number of excellent photographs of prominent bee-keepers—a number of pictures on one card. The likeness of 49 of them are shown on one of the photographs, and 121 on the other. We will send them, postpaid, for 30 cents each, mailing from the 121 kind first; then after they are all gone, we will send the 49 kind. So those who order first will get the most "faces" for their money. Send orders to the Bee Journal office.

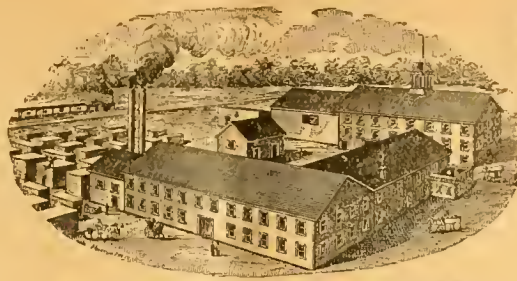

22Est

Address,

E. KRETCHMER, Red Oak, Iowa.

BEE-SUPPLIES!

We have the best equipped Factory in the West. Capacity—one carload a day; and carry the largest stock and greatest variety of every thing needed in the apiary, assuring **BEST** goods at the **LOWEST** prices, and prompt shipment.

Illustrated Catalog, 80 pages, **Free.**

few that I planted in my garden and cultivated, that is, hoed it in and tramped the ground. This grew six to seven feet high last year, but no blooms; this year it grew still longer, and has bloomed all summer, during the terrible drought we had, and still it blooms. In this section the sandy lands produce finely, but clover will not catch unless it is raked or harrowed in. W. G. NORTHCTR.

Gregg Co., Tex., Aug. 5.

[Whenever anybody wants some kind of seed, and is not sure where it is to be found, simply write to some one of the many seedsmen who advertise every year in all the papers, especially from Jan. 1 to April 1.—EDITOR.]

This "Cotton" Honey Leads.

Bees are doing better here than they have for several years. I have some colonies that gave three swarms each, and the last swarms are now storing honey in the supers. I put my first honey on the market here a few days ago, and, for a fact, the first that has ever been in this market in pound sections. It goes as fast as that man's honey did on the Fair ground, mentioned by A. B. Ginner lately. I put the price to 12½ cents a pound. I might just as well have asked 15 or 20, and could have gotten it just as readily. There has been honey brought in since, in the old-fashioned way, and went back to the country as it came. Those producers have come to me to learn how I fixed my honey so nice in the little square boxes. I would now as soon think of going back to the old shuck collar for a horse, or the wooden moldboard plow, as to think of putting a swarm of black bees into a box-hive for profit.

I have a splendid range here for bees, and wild flowers are just beginning to open. I expect to make more clear cash from my few bees this season than I have made, all told, in 20 years.

I was preparing to take some honey to our county fair, but as A. B. Ginner is in the habit of attending fairs, I believe I shall stick to the retail market.

ANDREW COTTON.

Pollock, Mo., Aug. 1.

Bees that are Great Swarmers.

I placed in the cellar, in November, 1895, 69 colonies of bees, having sold the previous spring 60 colonies. I sell every spring more or less, but did not last spring, as my reduced number the spring before only left me 36 colonies after selling, and although the season was very unfavorable for bees, mine about doubled in number.

There was not one pound of white

honey in this section last season. My bees wintered very well last winter, consequently they were strong in numbers, and with plenty of old honey from daisy and buckwheat, gathered the season before.

My bees commenced work April 18, earlier than I expected after so cold a winter and spring. They worked well about every day throughout the spring. I reduced the number of colonies, by uniting, to 60, and some were even short of bees then, but the best colonies were ready to swarm by May 21, and they kept right on, so I had out about 30 in the month of May. In all my experience with bees for the past 60 years, I never saw the like before; 12 first swarms the first day (May 30), but later I had out 16 in one day, but not all first swarms; and so they kept on swarming. One had been hived 15 days, and they came out; another 17, another 19, and so on. I have had from the old colonies 130 swarms, and from the young ones about 40, making in all about 170. Haven't we had to hustle, though, my wife and self, for people of our ages—I am almost 69, my wife almost 64? She has prepared all the boxes ready for use, besides considerable other work connected with the business, while I have done all the work among the bees.

I have a peculiar kind of bees—they swarm about ¼ the year. Last season they began to swarm June 4, and the last swarm issued September 2. They are on the third month now. They store some honey, but I cannot tell how much we shall get. I have had on some 3,000 sections, but as they swarmed so much, we do not get the honey we otherwise should, perhaps. H. F. NEWTON.

Whitney Crossing, N. Y., Aug. 3.

Several Co(e)gent Suggestions.

Bees are doing well this year. The lower frames are all full, and they are making a fine run in the supers. I am making an extra effort to procure all the new colonies I possibly can this year. I furnish the empty hives, and outside apiaries put new swarms into them for me. I am working entirely for nice, white comb honey. There is no money in extracted honey for me.

I have four different styles of hives in my apiary—the "I. X. L.," Goodrich, Langstroth, and the Danzenbaker. By another year I will select the best hive for white comb honey, and adopt it entirely, and lay all others aside.

To help stop cross bees from stinging while working in the apiary, take a block 4x4 inches, and 12 inches long, and set it on a hive 10 feet from the cross colony, then put an empty hat and veil on it, and after Miss Cross Bee has given the hat and veil a half

dozen of her best efforts at stinging, she will be ashamed of herself, thinking there is no chance to get up a fight, and in the excitement of the moment, and in the greatest agony of mind, start for home, or to the field.

I went to one of our skilled workmen in steel, and had tongs made to lift brood-frames from the hive. The tongs are 13 inches long, and the clasping part is 2 inches wide, and drawn down at the end to 1 1/16 inch; is made to clasp 3/8 and 1 3/8 inch frames. The clasping part is cut crosswise with a cold-chisel, to hold to the frames nicely.

Take the tongs in the left hand, and smoker in the right, loosen each end of the frame with a thin, pointed chisel, clasp the frame in the center, letting the clasps down the sides of the frame 1/2 inch, and after lifting out the frames and brood, if you find some work to be done, slip a small link over the ends of the handles to hold it solid, and then proceed with your work. I think the tongs are an indispensable tool in the apiary, as you do not touch the frames with your hands. It is a clean, nice piece of work in handling frames, and I can take a frame out, and return it, and disturb the bees but very little.

I have had quite an experience in artificial swarming, and nuclei colonies being robbed from some of the strong colonies. I had the robbing stopped at once by using a door screening 4 feet long, and the center of one side of the screen being nailed in three places, 5 inches above the entrance to the hive. I then let the screen drop down so as to leave a 2-inch entrance to the hive. I then gave the screen a curve up in front to 18 inches above the entrance to the hive. Then I drove 2 stakes 2 1/2 feet apart, and nailed screening to the stakes. I then pressed the screening down on each side of the hive and nailed it to the bottom, and the simple "fort" is completed. The apiarist can go about his work, as the nucleus colony can protect itself, since the fort has been built over them. The fort tells the story in the robbing business correctly.

T. H. COE.

Clintonville, Ohio, Aug. 5.

WOVEN WIRE FENCE

Over 50 Styles The best on Earth. Horse high, Bull strong, Pig and Chicken tight. You can make from 40 to 60 rods per day for from 14 to 22c. a Rod. Illustrated Catalogue Free. KITSELMAN BROS., Ridgeville, - Indiana.

48 Etf Mention the American Bee Journal.

BEGINNERS.

Beginners should have a copy of the Amateur Bee-Keeper, a 70-page book by Prof. J. W. Rouse. Price 25 cents; if sent by mail, 28c. The little book and the Progressive Bee-Keeper (a live, progressive 28-page monthly journal) one year, 65c. Address any first-class dealer, or

LEAHY MFG. CO., Higginsville, Mo.

500 Queens Ready to Ship!

For the next 60 days we will sell Queens bred from best imported stock or from one of Doollittle's best Queens, at the following low prices: Warranted Queens, each, 45 cents; 1/2 doz., \$2.60. Untested, each, 40 cts.; 1/2 dozen, \$2.40. Tested, each, 55 cts.; 1/2 doz., \$3.20. All Queens promptly sent by return mail.

Leininger Bros., Ft. Jennings, O.

34 Etf Mention the American Bee Journal.

HONEY and BEESWAX

MARKET QUOTATIONS.

The following rules for grading honey were adopted by the North American Bee-Keepers' Association, and, so far as possible, quotations are made according to these rules:

FANCY.—All sections to be well filled; combs straight, of even thickness, and firmly attached to all four sides; both wood and comb unsoiled by travel-stain, or otherwise; all the cells sealed except the row of cells next the wood.

No. 1.—All sections well filled, but combs uneven or crooked, detached at the bottom, or with but few cells unsealed; both wood and comb unsoiled by travel-stain or otherwise.

In addition to this the honey is to be classified according to color, using the terms white, amber and dark. That is, there will be "fancy white," "No. 1 dark," etc.

Chicago, Ills., Aug. 1.—We quote: Fancy; white clover, 15c.; No. 1 white, 12@13c.; fancy amber, 10@11c.; No. 1 amber, 7@9c.; fancy dark, 9@10c.; No. 1 dark, 7c. Extracted, white, 5@7c.; amber, 5@5 1/2c.; dark, 4 1/2@5c. Beeswax, 25@27c.

The month closes with some offerings of new comb honey, for which 14-15c. is asked for best lots—but there are no sales of consequence to report. There is usually a good deal of it moved in August, thus establishing the early market.

Philadelphia, Pa., Aug. 14.—Extracted, white, 8-10c.; amber, 4-5c.; dark, 3-4c. Beeswax, 25c.

No new comb in this market yet. Old comb cleaned out.

Buffalo, N. Y., July 24.—Fancy comb, 1-pound, 12-14c.; No. 2, 9-10c.; No. 3, 4-8c. Extracted, 3-5c., as to quality. It is folly to ship honey unless properly packed. Good results depend on it and quality.

Cincinnati, Ohio, July 10.—No. 1 white, 13@14c.; fancy amber, 12@13c.; No. 1 amber, 10@12c. White, extracted, 5@7c.; amber, 5@6c.; dark, 3 1/2-5c. Beeswax, 20-25c.

San Francisco, Calif., July 29.—White comb, 11-12 1/2c.; amber, 7 1/2-10c. Extracted, white, 5-5 1/2c.; light amber, 4 1/2-4 3/4c.; amber colored and candied, 3 1/2-4c.; dark tulle, 2 1/2-3c. Not much offering, and as the crop is a comparative failure, stocks will be light throughout the season. The demand at current rates is confined almost wholly to local requirements.

Beeswax, fair to choice, 22-26c. Market in a somewhat unsettled condition, owing to much of this product having been lately adulterated. Foreign buyers now insist on a guarantee as to purity before making further purchases.

Albany, N. Y., Aug. 1.—Fancy white, 13-14c.; No. 1, 12-13c.; No. 1 amber, 11-12c. We have received a number of consignments of new comb honey, mostly white, and a great many letters from producers, asking if they should forward their honey as soon as it was ready. There is but very little demand for honey during hot weather and it creates an unfavorable impression on the trade to see a large stock of honey standing around. September 1 is time enough to forward comb honey. We look for a large crop of white honey and prices lower than last season.

Indianapolis, Ind., July 28.—Fancy white, 15-16c.; No. 1 white, 13-14c. Extracted, white, 6-7c. Beeswax, 25-27c.

No demand at all for off grades of either comb or extracted honey. Large fruit crop and warm weather are opponents to the demand for honey at present.

New York, N. Y., Aug. 8.—No. 1 white, 12@13c.; fancy amber, 11@12c.; No. 1, 10@11c. Extracted, white, 5 1/2@5 3/4c.; amber, 5c.; dark, 50c. per gallon. Beeswax, 25c.

Our market has not opened up as yet and we would not advise shipping comb honey before Sept. 1, or latter part of this month. Extracted is selling fairly well at prices quoted. Beeswax very dull and declining.

St. Louis, Mo., Aug. 8.—Fancy white, 13@14c.; No. 1 white, 12@12 1/2c.; fancy amber, 11@11 1/2c.; No. 1 amber, 10@10 1/2c.; fancy dark, 8@9c.; No. 1 dark, 7@7 1/2c. Extracted, white, in cans, 5c.; in barrels, 4@4 1/2c.; amber, 3@3 1/2c.; dark, 2 1/2@3c. Beeswax, 19@20c.

Very little honey coming in at present, and the weather is too warm to handle to advantage if it were here.

Milwaukee, Wis., Aug. 8.—Fancy white, 14-15c.; No. 1, 12-13c.; No. 1 amber, 8-10c. Extracted, white, 6-7c.; amber, 5-6c.; dark, 4-5c. Beeswax, 22-24c.

New crop of honey begins to come forward. The demand is very poor and quotations at most nominal. Weather is very warm and the consumption of honey is very small. Plenty of fruit, and hence the appetite is satisfied with same in preference. Later on we expect an improved demand for honey of all kinds.

Minneapolis, Minn., Aug. 8.—Fancy white, 12 1/2c.; No. 1 white, 10@11c.; fancy amber, 9@10c.; No. 1 amber, 8@9c.; fancy dark, 7@8c.; No. 1 dark, 6-8c. Extracted, white, 5 1/2@6 1/2c.; amber, 5@5 1/2c.; dark, 4@5c. Beeswax, 23@26c.

The demand for both comb and extracted is very quiet, and for the latter, nominal. The hot weather of the past week or so has checked demand for comb honey.

Cleveland, Ohio, Aug. 8.—Fancy white, 14 1/2@15c.; No. 1 white, 12 1/2@13c. Extracted, white, 6@7c.; amber, 4 1/2@5 1/2c. Beeswax, 22@25c.

There is not very much honey in our market. Selling rather slow. Demand beginning to be a little better. Think trade will be fair in this line this fall.

Kansas City, Mo., Aug. 8.—Fancy white comb, 15c.; No. 1 white, 13@14c.; fancy amber, 12-13c.; No. 1 amber, 11-12c.; fancy dark, 10-11c.; No. 1, 8-10c. Extracted, white, 6-6 1/2c.; amber, 5 1/2c.; dark, 4-4 1/2c. Beeswax, 22-25c.

Boston, Mass., Aug. 10.—Fancy white, 14-15c.; No. 1, 12-13c.; fancy amber, 9-10c. Extracted, white, 6-7c.; amber, 5-6c. Beeswax, 25c.

Good supply of new honey, but demand is light this very hot weather.

Detroit, Mich., Aug. 8.—No. 1 white, 12-12 1/2c.; fancy amber, 10-11c.; No. 1 amber, 9-10c.; fancy dark, 8-9c. Extracted, white, 5 1/2-6c.; amber, 5-5 1/2c.; dark, 4-5c. Beeswax, 24-25c.

List of Honey and Beeswax Dealers.

Most of whom Quote in this Journal.

Chicago, Ills.

R. A. BURNETT & Co., 163 South Water Street.

New York, N. Y.

HILDRETH BROS. & SEELKEN,
120 & 122 West Broadway
CHAS. ISRAEL & BROS., 486 Canal St.

Kansas City, Mo.

C. C. CLEMOMS & Co., 423 Walnut St.

Buffalo, N. Y.

BATTERSON & Co., 167 & 169 Scott St.

Hamilton, Ills.

CHAS. DADANT & SON.

Philadelphia, Pa.

WM. A. SELSER, 10 Vine St.

Cleveland, Ohio.

WILLIAMS BROS., 80 & 82 Broadway.

St. Louis, Mo.

WESTCOTT COM. CO., 213 Market St.

Minneapolis, Minn.

S. H. HALL & Co.

Milwaukee, Wis.

A. V. BISROP & Co.

Boston, Mass.

E. E. BLAKE & Co., 57 Chatham Street

Detroit, Mich.

M. H. HUNT, Bell Branch, Wayne Co., Mich

Indianapolis, Ind.

WALTER S. POWDER, 162 Massachusetts Ave.

Albany, N. Y.

CHAS. McCULLOCH & Co., 380 Broadway.

Cincinnati, Ohio.

C. F. MUTH & SON, cor. Freeman & Central avs.

Bee-Keeper's Guide—see page 527.

BEE-BOOKS

SENT POSTPAID BY

George W. York & Co.,
Chicago, Ills.

Bees and Honey, or Management of an Apiary for Pleasure and Profit, by Thomas G. Newman.—This edition has been largely re-written, thoroughly revised, and is "fully up with the times" in all the improvements and inventions in this rapidly-developing pursuit, and presents the apiarist with everything that can aid in the successful management of an apiary, and at the same time produce the most honey in an attractive condition. It contains 250 pages, and 245 illustrations—is beautifully printed in the highest style of the art, and bound in cloth, gold-lettered. Price, \$1.00.

Langstroth on the Honey-Bee, revised by Dadaut.—This classic in bee-culture, has been entirely re-written, and is fully illustrated. It treats of everything relating to bees and bee-keeping. No apiarian library is complete without this standard work by Rev. L. L. Langstroth—the Father of American Bee-Culture. It has 620 pages; bound in cloth. Price, \$1.25.

Bee-Keepers' Guide, or Manual of the Apiary, by Prof. A. J. Cook, of the Michigan Agricultural College.—This book is not only instructive and helpful as a guide in bee-keeping, but is interesting and thoroughly practical and scientific. It contains a full delineation of the anatomy and physiology of bees. 460 pages; bound in cloth and fully illustrated. Price, postpaid, \$1.25.

Scientific Queen-Rearing, as Practically Applied, by G. M. Doolittle.—A method by which the very best of Queen-Bees are reared in perfect accord with Nature's way. 176 pages, bound in cloth, and illustrated. Price, \$1.00.

A B C of Bee-Culture, by A. I. Root.—A cyclopedic of 400 pages, describing everything pertaining to the care of the honey-bees. It contains 300 engravings. It was written especially for beginners. Bound in cloth. Price, \$1.25.

Advanced Bee-Culture, Its Methods and Management, by W. Z. Hutchinson.—The author of this work is too well known to need further description of his book. He is a practical and entertaining writer. You should read his book. 90 pages, bound in paper, and illustrated. Price, 50 cts.

Rational Bee-Keeping, by Dr. John Dzierzon.—This is a translation of his latest German book on bee-culture. It has 350 pages; bound in cloth, \$1.25; in paper covers, \$1.00.

Biene-Kultur, by Thomas G. Newman.—This is a German translation of the principal portion of the book called BEES OF HONEY. 10 page pamphlet. Price, 40 cents.

Convention Hand-Book, for Bee-Keepers, by Thomas G. Newman.—It contains the parliamentary law and rules of order for Bee-Conventions—also Constitution and By-Laws, with subjects for discussion, etc. Cloth, gold-lettered. Price, 25 cts.

Amerikanische Bienenzucht, by Hans Buschbauer.—Printed in German. A hand-book on bee-keeping, giving the methods in use by the best American and German apiarists. Illustrated; 138 pages. Price, \$1.00.

Thirty Years Among the Bees, by Henry Alley.—Gives the results of over a quarter-century's experience in rearing queen-bees. Very latest work of the kind. Nearly 100 pages. Price, 50c.

Why Eat Honey?—This Leaflet is intended for FREE distribution, to create a Local Market, 100 copies, by mail, 40 cts.; 500 for \$1.50; 1000, \$2.50.

If 500 or more are ordered at one time, your name and address will be printed on them FREE.

How to Keep Honey and preserve its richness and flavor. Price same as Why Eat Honey.

Apiary Register, by Thos. G. Newman.—Devotes two pages to a colony. Leather binding. Price, for 50 colonies, \$1.00; for 100 colonies, \$1.25.

Preparation of Honey for the Market, including the production and care of comb and extracted honey. A chapter from BEES AND HONEY. Price, 10 cents.

Bee-Pasturage a Necessity.—This book suggests what and how to plan. It is a chapter from BEES AND HONEY. Price, 10 cents.

The Hive I Use, by G. M. Doolittle. It details his management of bees, and methods of producing comb honey. Price, 5 cents.

Dr. Howard's Book on Foul Brood.—Gives the McEvoy Treatment and reviews the experiments of others. Price, 25 cts.

Dictionary of Apiculture, by Prof. John Phil. Gives the correct meaning of nearly 500 apicultural terms. Price, 50 cts.

Winter Problem in Bee-Keeping, by G. R. Pierce. Result of 25 years' experience. 50 cts.

Handling Bees, by Chas. Dadant & Son.—A Chapter from Langstroth Revised. Price, 5 cts.

Bee-Keepers' Directory, by H. Alley.—Latest methods in Queen-Rearing, etc. Price, 50c.

Foul Brood Treatment, by Prof. F. R. Cheshire.—Its Cause and Prevention. Price, 10 cts.

Foul Brood, by A. R. Kohnke.—Origin, Development and Cure. Price, 25 cts.

History of Bee-Associations, and Brief Reports of the first 20 conventions. Price, 15 cts.

Honey as Food and Medicine, by T. G. Newman.—A 32-page pamphlet; just the thing to create a demand for honey at home. Should be scattered freely. Contains recipes for Honey-Cakes, Cookies, Puddings, Fonn, Wines, and uses of honey for medicine.

Prices, prepsaid—Single copy, 5 cts.; 10 copies, 35 cts.; 50 for \$1.50; 100 for \$2.50; 250 for \$5.50; 500 for \$10.00; or 1000 for \$15.00.

When 250 or more are ordered, we will print the bee-keeper's card (free of cost) on the front cover page.

Bee-Keeping for Profit, by Dr. G. L. Tinker.—Revised and enlarged. It details the author's "new system, or how to get the largest yields of comb or extracted honey." 80 p.; illustrated, 25c.

Emerson Binders, made especially for the BEE JOURNAL, are convenient for preserving each number as fast as received. Not mailable to Canada. Price, 75 cts.

Commercial Calculator, by C. Ropp.—A ready Calculator, Business Arithmetic and Account-Book combined in one. Every farmer and business man should have it. No. 1, bound in water proof leatherette, calf finish. Price, 40 cts. No. 2 in the artificial leather, with pocket, silicate slate, and account-book. Price, 60 cts.

Green's Four Books, by Chas. A. Green.—Devoted to, 1st, How We Made the Old Farm Pay; 2nd, Peach Culture; 3rd, How to Propagate Fruit-Plants, Vines and Trees; 4th, General Fruit Instructor. Nearly 120 pages. Fully illustrated. 25 cts.

Green's Six Books on Fruit-Culture, by Chas. A. Green.—Devoted 1st, to Apple and Pear Culture; 2nd, Plum and Cherry Culture; 3rd, Rasp, Berry and Blackberry Culture; 4th, Grape Culture; 5th, Strawberry Culture. 129 pp.; illustrated. 25 cts.

Garden and Orchard, by Chas. A. Green.—Gives full instructions in Thinning and Marketing Fruits; Pruning, Planting and Cultivating; Spraying, Evaporation, Cold Storage, Etc. 94 pages, illustrated. Price, 25 cts.

Kendall's Horse-Book.—35 pictures, showing positions of sick horses, and treats on all their diseases. English or German. Price, 25 cts.

Silo and Silage, by Prof. A. J. Cook.—It gives the method in operation at the Michigan Agricultural College. Price, 25 cts.

Lumber and Log-Book.—Gives measurements of lumber, logs, planks; wages, etc. 25c.

Maple Sugar and the Sugar Bush, by Prof. A. J. Cook.—Full instructions. Price, 35 cts.

Grain Tables, for casting up the price of grain, produce, hay, etc. Price, 25 cts.

Capons and Caponizing, by Dr. Sawyer, Fanny Field, and others.—Illustrated. All about caponizing fowls, and thus how to make the most money in poultry-raising. 64 pages. Price, 30 cts.

Our Poultry Doctor, or Health in the Poultry Yard and How to Care Sick Fowls, by Fanny Field.—Everything about Poultry Diseases and their Cure. 64 pages. Price, 30 cts.

Poultry for Market and Poultry for Profit, by Fanny Field.—Tells everything about the Poultry Business. 64 pages. Price, 25 cts.

Turkeys for Market and Turkeys for Profit, by Fanny Field.—All about Turkey-Raising. 64 pages. Price, 25 cts.

Rural Life.—Bees, Poultry, Fruits, Vegetables, and Household Matters, 100 pages. 25 cts.

Potato Culture, by T. B. Terry.—It tells how to grow them profitably. Price, 40 cts.

Hand-Book of Health, by Dr. Foote.—Hints about eating, drinking, etc. Price, 25 cts.

Alsike Clover Leaflet.—Full directions for growing. 50 for 25 cts.; 100 for 40 cts.; 200, 70c.

Book Clubbing Offers.

(Read Carefully.)

The following clubbing prices include the American Bee Journal one year with each book named. Remember, that only ONE book

can be taken in each case with the Bee Journal a year at the prices named. If more books are wanted, see postpaid prices given with the description of the books on this page. Following is the clubbing-list:

1. Langstroth on the Honey-Bee.....	\$2.00
2. A B C of Bee-Culture.....	2.00
3. Bee-Keeper's Guide.....	1.75
4. Bees and Honey [Cloth bound].....	1.65
5. Scientific Queen-Rearing.....	1.75
6. Dr. Howard's Foul Brood Book.....	1.10
7. Advanced Bee-Culture.....	1.30
8. Amerikanische Bienenzucht [Germ.].....	1.75
9. Biene-Kultur [German].....	1.25
10. Rational Bee-Keeping [Cloth bound].....	2.00
11. Rational Bee-Keeping [Paper bound].....	1.75
12. Thirty Years Among the Bees.....	1.30
13. Bee-Keeping for Profit.....	1.15
14. Convention Hand-Book.....	1.15
15. Poultry for Market and Profit.....	1.10
16. Turkeys for Market and Profit.....	1.10
17. Capons and Caponizing.....	1.10
18. Our Poultry Doctor.....	1.10
19. Green's Four Books.....	1.15
20. Green's Six Books on Fruit-Culture.....	1.15
21. Garden and Orchard.....	1.15
22. Rural Life.....	1.10
24. Emerson Binder for the Bee Journal.....	1.60
25. Commercial Calculator, No. 1.....	1.25
26. Commercial Calculator, No. 2.....	1.49
27. Kendall's Horse-Book.....	1.10
30. Potato Culture.....	1.20
32. Hand-Book of Health.....	1.10
33. Dictionary of Apiculture.....	1.35
34. Maple Sugar and the Sugar Bush.....	1.20
35. Silo and Silage.....	1.10
36. Winter Problem in Bee-Keeping.....	1.30
37. Apiary Register (for 50 colonies).....	1.75
38. Apiary Register (for 100 colonies).....	2.00
39. Bee-Keepers' Directory.....	1.30

10 per ct. Off to Reduce Stock
on all kinds of SUPPLIES, except

—COMB FOUNDATION—

which will be sold in lots of 10 lbs. or more as follows: Medium, 35 cts.; Light, 36 cts.; Thin Surplus, 40 cts.; Extra Thin, 45 cts.

Queens—Warranted, 50c.; Tested, 75c.
W. J. FINCH, Jr., SPRINGFIELD ILLS.
Mention the American Bee Journal.

Convention Notices.

TEXAS.—The third annual convention of the Southwest Texas Bee-Keepers' Association will be held at Beeville, Tex., on Sept. 16 and 17, 1896. All are invited. No hotel bills to pay. Low rates on railroads.
Beeville, Tex. J. O. GRIMSLEY, Sec.

MINNESOTA.—The annual meeting of the Southern Minnesota Bee-Keepers' Association will be held in Winona, on September 24 and 25, 1896, at 9 o'clock, a.m. All that feel in any way interested in bees or honey are cordially invited to attend.
Winona, Minn. E. C. CORNWELL, Sec.

WISCONSIN.—The annual meeting of the Northwestern Wisconsin Bee-Keepers' Association will be held at Wauzeka, Wis., Oct. 7 and 8, 1896. All that are interested in apiculture are invited to attend, and especially those that want a foul brood law to protect their bees from this dread disease. Our committee is working hard to get every bee-keeper interested, and we should all feel it is for our interest to help get a State law to protect our bees. Many of our prominent bee-keepers of the State have promised to be at our meeting, and no one can afford to miss it.
Boscobel, Wis. M. M. RICE, Sec.

North American Bee-Keepers' Association

OFFICERS FOR 1896.
PRESIDENT—A. J. Root..... Medina, Ohio.
VICE PRES.—Wm. McEvoy..... Woodburn, Ont.
SEC.—Dr. A. B. Mason..... Sta. B. Toledo, Ohio.
TREAS.—W. Z. Hutchinson..... Flint, Mich.
Convention at Lincoln, Neb., Oct. 7 & 8.

National Bee-Keepers' Union.

PRESIDENT—Hon. R. L. Taylor, Lancaster, Mich.
GEN'L MGR.—T. G. Newman, San Diego, Cal.

See the premium offer on page 538!

Bottom Prices

**BRING US BIG TRADE.
GOOD GOODS KEEP IT.**

If you want the best supplies that can be made at a little less cost than you can buy the same goods for elsewhere, write to us for low prices. 1896 Catalogue now ready—ask for it and a free copy of **The American Bee-Keeper** (36 pages).

Address,
**THE W. T. FALCONER MFG. CO.,
JAMESTOWN, N. Y.**

Mention the American Bee Journal.

COMB FOUNDATION!

Wax always wanted for Cash or in Exchange for Fdn. or other Supplies. My trade is established on **Low Prices** and the merit of my **Foundation**. Orders filled promptly.

WORKING WAX INTO FDN. BY THE LB. A SPECIALTY. Wholesale prices to dealers and large consumers. Send for Prices and Samples to—**GUS DITMER, AUGUSTA, WIS.** Reference—Augusta Bank. 1A1f

Mention the American Bee Journal.

Why am I down flat on my back? Well, this is why: Cole & Lowers have been telling this, and sent it right to Doolittle, too:

"The Tested Queen purchased of you produced 125 lbs. of comb honey, well finished, and the colony was overhauled every other day all through the honey season for brood for queen-rearing, we rearing nearly 300 queens from her, selling all but 8, as our customers would pick these queens in preference to any other. The next year, her daughters gave an average of two pounds of honey to one from any other strain of bees which we have, and we have six different strains, all from different breeders. The Doolittle bees do the best of all."

This brought a "rush" from the Pacific Coast which floored ME. But Doolittle is all right, filling orders every day. For prices see page 512. Am. Bee Journal for Aug. 6.

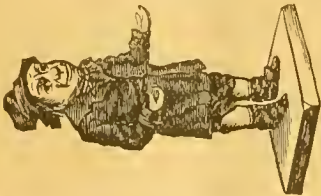

Mention the American Bee Journal.

THROAT AND LUNG DISEASES,
DR. PEIRO, Specialist
Offices: 1019, 100 State St.,
CHICAGO. Hours 9 to 4.

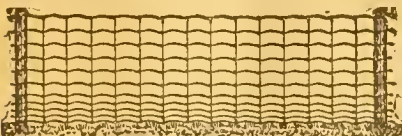

The Cream, Please! Thanks!

We sell fence for the best railways in the country, hundreds of miles each, in many cases. Sell the National, State and City Governments for parks, etc. Have also a long list of millionaire customers with game preserves, and country residences, yet more than **two thirds** of our immense output goes to practical every day farmers. Through no fault of ours, they are of the more intelligent and successful class. Write for evidence.

PAGE WOVEN WIRE FENCE CO., Adrian, Mich.

Mention the American Bee Journal.

19th Year Dadant's Foundation 19th Year

Is still in the lead, for we use all the latest improvements, including the

NEW WEED PROCESS,

and still make the best goods. Remember that we do not use any acid to purify our beeswax, and that is why our Foundation preserves the smell of the honey and is more acceptable to the bees, than any other. It is kept for sale by

T. H. Strickler, Solomon City, Kansas.
G. K. Hubbard, Fort Wayne, Ind.
L. Hanssen, Davenport, Iowa.
C. Theilmann, Theilmantown, Minn.
E. C. Eaglesfield, Berlin, Wis.
E. T. Abbott, St. Joseph, Mo.
J. M. Jenkins, Wetumpka, Alabama
John Rey, East Saginaw, Mich.
Vickery Bros., Evansville, Ind.

The Jennie Atchley Company, Beeville, Texas.
C. F. Muth & Son, Cincinnati, Ohio
E. Kretschmer, Red Oak, Iowa.
G. B. Lewis Co., Watertown, Wis.
James Reynolds Elevator Co., Poughkeepsie, N. Y.
Louisiana Bee-Keepers' Supply Manufactory,
Donaldsonville, La.
Page & Lyon, New London, Wis.
John Nebel & Son, High Hill, Mo.

and many other Dealers. All agree in saying that no goods are better than ours.

We make a specialty of **Veils and Veil Stuffs** of best quality, cotton and silk.

Langstroth on the Honey-Bee, Revised

Bee-Keepers' Supplies, Smokers, Sections, Tin Pails, etc.

Samples of Foundation and Tulle FREE with Circular. Instructions to beginners with Circular. Send us your address.

CHAS. DADANT & SON,

Mention the American Bee Journal.

HAMILTON, Hancock Co., ILL.

See Campaign Book Offer on page 538! Better Have It!

No. 1 4x4! Snow-White Sections \$2.00 per 1,000.



For the purpose of introducing our One-Piece Section to the bee-keepers generally, we have concluded to make the price \$2.00 per 1,000 for the season. Now is the time to get your Sections cheap. We have a choice lot of Section Lumber, gotten out of young timber, and we can furnish you the nicest Section to be had. Write for Sample Section Free.

32A4t

Mention the American Bee Journal.

The Marshfield Mfg. Co., MARSHFIELD, Wood Co., WIS.

Good Prices on Your Comb Honey!

Then you want our latest

NON-DRIP SHIPPING-CASES.

Our trade was never so large in these as now; and Commission Men tell us that Comb Honey in our Cases brings

BETTER PRICES

than some of the Cases made by competitors. The fact is, we know the demands of the trade, and are prepared to supply them. Remember, home-made or poorly made Cases are dear at any price. Honey in such Cases always brings several cents below the market price.

If you wish to get **GILT-EDGE PRICES** on **GILT-EDGE HONEY** put it up in

Root's Non-Drip Shipping-Cases.

THE A. I. ROOT COMPANY,

Factory and Main Office, MEDINA, O.

BRANCH OFFICES:

**118 Michigan St., Chicago, Ill.
1024 Miss. Str., St. Paul, Minn.**

**Syracuse, N. Y.
Mechanic Falls, Maine.**

AMERICAN BEE JOURNAL

DEVOTED EXCLUSIVELY TO THE INTERESTS OF HONEY PRODUCERS

ESTABLISHED 1861
THE OLDEST BEE-PAPER IN AMERICA

Published Weekly, at \$1.00 per annum.

Sample Copy sent on Application.

36th Year.

CHICAGO, ILL., AUGUST 27, 1896.

No. 35.



Mr. J. D. Everett and His Apiary.

BY THE EDITOR.

Early in the season we were invited by Mr. J. D. Everett, of Oak Park, Ill., to visit his home and apiary, and finally, on Aug. 8, we found time to accept the kindly invitation.

Well, before we reached our home, 6 miles north of Chicago, we had almost wished we had waited for a cooler day. But with that exception we had a very enjoyable time, both at Mr. Everett's, and Miss Marchant's, whose apiary we mention on page 558.

Mr. Everett has a delightful home—a regular mansion to live in, and a “queen”-ly wife to preside over all. His lot is 70x300 feet, so the bees are a sufficient distance from the street never to cause any trouble, being on the further end of the 300 feet. Between the bee-yard (which we are permitted to show herewith) and the house is the horse-barn, in the upper part of which Mr. Everett has a complete shop for making hives and all needful bee-appliances except sections and comb foundation. He has a Barnes' saw with which to cut the material. His work is remarkably neat and well done.



Apiary of Mr. J. D. Everett, Oak Park, Ill.—All Heddon Divisible-Brood-Chamber Hives.

Oak Park is about 10 miles directly west of Chicago, in the midst of a sweet clover region. It is one of Chicago's most beautiful suburbs. The streets are wide, and on either side are rows of grand trees that make a delightful shade—especially so the day we were there, when the thermometer indicated 100° in the shadiest kind of a shade. Was it hot?

Mr. Everett takes much pride in having everything made in an exact manner, doing all this work himself, and he is never so happy as when at work in his shop or with the bees.

He also has a \$75 camera, and complete photographic outfit, including the dark room and all necessary chemicals for developing the pictures. By the way, the one of the apiary

here shown was taken by himself. He was not quite sure it was a first-class picture, as the camera failed to work satisfactorily, we believe. As this, of course, is being written before this number of the Bee Journal can be printed, we cannot say just how well the picture will look after taken from the press. We hope it will be clear and good, for we have never seen a neater apiary than is Mr. Everett's, and we desire all to have a good view of it.

Mr. E. shows much taste in painting his hives. The hive-stand is white, the hive bottom-board red, the brood-chamber white, the wood-zinc queen-excluder red, the supers blue, and the hive-cover and shade-board white. Thus it is red, white and blue—giving the apiary a very patriotic appearance.

We wish to call attention to the clean ground upon which Mr. Everett's apiary stands. It is a sort of fine gravel or



Mr. J. D. Everett.

sand, and scarcely a blade of grass or weed grows upon it. His chickens roam at will over the yard, and perhaps help to keep down the little grass. He says they never eat any of the bees, so far as he knows.

At the east and west ends of the bee-yard there are shallow tubs of water—perhaps 6 inches deep and 2 feet in diameter, in which are put pieces of wood upon which the bees can stand to sip. Both tubs were well patronized, as shown by their "living rim" of bees, and also many on the wood pieces. The water is changed often.

Mr. Everett was born Jan. 5, 1849, on the banks of the upper Tennessee river, in Sullivan county, and during the period from 1859 to 1866, he lived in Lee county, Va. He first became interested in bees while a child, his grandfather and father both keeping them in a small way. He left the South in 1866, coming to Chicago, where he lived until 1888, when he moved to Oak Park. Mr. Everett had always had a desire to keep bees, but the opportunity did not present itself until he moved to Oak Park.

In 1893 he sent to Michigan, and purchased two colonies from Mr. James Heddon. He has experimented quite extensively with them, and now has 65 colonies, although he intends to double them up before putting them into winter quarters.

He uses the Heddon double brood-chamber hive, hives all swarms in a half brood-chamber, and pushes them into the supers as fast as possible. When the honey season is about over, he puts two of the half brood-chambers together, and puts on next to the bees a honey-board, with blanket of wool lined with cotton-duck. For wintering he also uses a three-inch tray for each hive, which has three one-inch auger-holes on the sides and back, covered with wire netting; this tray has the upper edge all around rabbeted out one-half inch deep, so the hive taken off of the bottom-board telescopes into it one-half inch, leaving a space of $2\frac{1}{2}$ inches between the bottom of the frames and the bottom of the tray. In the front end of the tray the lower half is movable, so that it can be taken out to remove dead bees. However, he has never had occasion to remove any, as they have so much room below the frames that they do not seem to give any trouble. He put away 31 colonies last fall, in the cellar, piling the hives up like empty boxes, and every colony came out alive last spring.

Mr. Everett's bees have done fairly well this season, as he thinks he will secure about 1,200 pounds of beautiful comb honey, besides the increase of colonies. He doesn't make any effort to control swarming, as he believes Nature's way the best, although a little troublesome at times. After July 1st he forces the swarms into the weakest colonies.

Mrs. Everett takes great interest in the apiary, and oversees the putting away of honey, and naturally a fair share of the returns. Mrs. E. was born in Henry county, Illinois. They were married Oct. 15, 1871, one week after the great Chicago fire, by candle light.

We may say further that though Mr. Everett is successful with bees, of course he does not depend at all upon them for an existence—not much—for he has been with the well-known Chicago wholesale dry-goods firm, John V. Farwell Company, for about 30 years, and holds a responsible position at a deservedly good salary. But his highest ambition is some day to own a nice little farm of 40 acres somewhere in the rich agricultural portion of northern Illinois, there to live surrounded with bees, poultry, and various kinds of pets. We hope he may soon have his heart's desire.



Season's Record—Observations and Reflections

BY EDWIN BEVINS.

We have been having some rainy days, and the bees are taking a rest, and that gives me an opportunity to record some of the work done, some of the observations made, and some of the reflections to which these operations and observations give rise in this year of our Lord, 1896.

Just before the rains came I noticed a colony of bees that seemed to have suspended work, although the other colonies in the yard were all in a state of great activity. This was a colony that built up so late that I did not think it would do much work in the sections, so I put on another hive-body filled with empty comb and frames of foundation, placing bee-zinc between the two stories, and left the bees to do what they would. To-day (July 24) I looked in to see if I could find out the reason for their inactivity. I found the frames of the upper story all well filled with comb, which was nearly filled with sealed honey. In the center of the lower half of each frame there was a patch of empty cells. This patch was in the shape of a half-moon. All the other cells were filled and sealed clear up to the edges of this half-moon, but there were no signs that the bees intended doing anything with those empty cells. Did they leave them unfilled with the expectation that the queen below would come up and fill them with eggs? or was it an invitation to the bee-keeper to put a queen in the upper story? I took out two frames, giving them to nuclei that were not strong enough in workers to

gather much honey for themselves, and replaced with frames having starters only.

I determined last spring that I would keep such close watch over the yard this season that no swarm should issue unobserved. But the very first one that issued got away. I had been expecting some swarms, and was careful to be around where they could be seen or heard, but one day about 11 o'clock somebody who was canvassing for something or other came along, and my attention was drawn from the bees. Than the canvasser wanted some dinner. When we went out from dinner a big swarm was just rising above an apple-tree, where it had clustered, and taking its departure for some hollow tree in the forest to the southward. I would have refused ten dollars for the queen that went with the swarm. Then I wished a murrain might take the whole canvassing tribe, and all its relations near and remote.

The next day I watched until getting hot and tired I went into the house for a few moment's rest. When I went out again a swarm having at its head a daughter of the queen lost the day before had gone to the southward, too. Then I concluded that watching for swarms was a failure, and began to think that I should have to resort to the clipping of queens' wings, and the use of swarm-guards and queen-traps, but I must confess that I would rather not.

One of my big colonies in one of the big hives swarmed unexpectedly, and the swarm was a big one. I resolved to utilize it for the production of comb honey. I hived it on nine frames with starters, in a hive 12 inches deep, and put on a super filled with 28 sections. The old colony has filled and sealed 20 such frames as are used in the Dadant hive for extracted honey, and have 10 more half filled. The swarm seems likely to fill the 28 sections besides filling the nine frames in the brood-chamber.

I have given my bees in both the small hives and large hives unlimited room this season, and have had but two or three second swarms, and not many prime ones. A good many of the colonies in the little hives have not swarmed at all, though the season has been the best one for honey I have known. One colony in an 8-frame dovetailed hive has completed 72 sections, and will fill 24 more. This colony was not stimulated. Another colony in the same kind of hive was fed frequently in order that I might see what kind of a record it would make. This is its record up to date:

Before the honey-flow began two frames of brood were taken from it to strengthen other colonies. Two supers were put on the hive early, and partly filled. Then the colony swarmed, the swarm was hived on the old stand, and the old hive moved to another stand. Since then 48 completed sections have been taken from the swarm, and it has 48 more nearly completed. The old colony had a super of 24 sections placed on it, and it looks as if the bees would fill and seal them all.

I wish to take this public way of asking "The Dadants" if the objection, that is made on page 240 of Langstroth Revised, to the use of dividing hives—or what amounts to the same thing, dividing colonies in half, leaving one-half without a queen—is not greatly modified, if not removed altogether, by the use of comb foundation. The objection is that the queenless half will build cells too large for the rearing of workers. Well, if the practice is heretical, then I am a heretic. I divided a colony in half that got very strong long before there was any work to do in the fields, and filled up the hives with frames of foundation. The work of the half having the queen will amount to about a hundred sections; the work of the queenless half to 24, and as these 24 are about completed, I shall take two or three frames of brood from the hive to start another colony, of course buying a queen for it, and helping it with frames from other colonies. I have not had so much swarming as I would like to have had, but honey will buy bees.

I will not close without a word on the "use and abuse of comb foundation." I shall never forgive Mr. Hutchinson for the trouble he gave me in trying to find out where the abuse comes in. After laboring laboriously to show when it may profitably be dispensed with in the brood-frames, he gave the whole case away when he says that if we would be sure of straight combs in the brood-chamber we *must* use full sheets of foundation. We can sometimes get straight combs when full sheets are not used, but then we cannot be sure of them. Without straight combs we might as well not have movable frames. In the absence of foundation, Mr. Langstroth's invention would not be nearly so valuable as it is.

I know that straight combs can be secured by hiving swarms on a reduced number of frames with starters only, but that is a practice I would not care to follow to any great extent.

In the use of foundation I give the preference to the heavy grade. I know that Mr. E. R. Root pronounces it too expensive, but there is a satisfaction in using it that the use of the lighter grades does not give, and which goes far to compensate for the additional cost. Besides, where the honey-flow comes, as with me, almost wholly from white clover, I believe it pays in dollars and cents to use the heavy foundation.

While writing the above I thought of one other incident of my bee-keeping experience this season. One of my colonies swarmed June 14; I expected another swarm to issue eight days after, but none came out. Three or four more days passed and then a swarm came out, lit on a tree, and then returned to the hive. Two or three days more passed and then the swarm issued again, and again returned to the hive. This performance was repeated the same day. The next day the swarm came out and staid out. The day after another swarm issued from the same hive. Then I thought I would find out if possible what the rumpus was all about. I went to the hive and took out a frame of brood having on it ten queen-cells. Three of these were empty. The rest were sealed, but the cappings of three of them could be seen to move. I took the frame to another colony which I thought might be queenless, and cut out some cells to put in the supposed queenless hive. While doing this one queen issued and flew away. I cut out the other cells, using them where I thought they were needed, and returned the frame to the hive. Then I took out another frame having on it three queen-cells, which I gave frame and all to a queenless nucleus. Since making these manipulations that colony which swarmed so much has behaved very respectably.

When the weather began to get up into the 90's, some of my hives developed a "beard" of considerable size with great rapidity. I "shaved it off" promptly by placing $\frac{1}{2}$ to $\frac{3}{8}$ inch blocks between the hive and bottom-board in front.

Leon, Iowa.



Fifteen Years' Experience in Bee-Keeping.

BY MRS. SALLIE E. SHERMAN.

(Continued from page 533.)

I never tried sulphuring combs but once. That experience satisfied me. I tiered the hives up six stories high, having the bottom one empty. Into it I put the skillet in which was the fire and sulphur. I took every precaution possible that I knew of to keep from inhaling the fumes, but, unhappily for me, my olfactory organs are so well developed that I could not help smelling the terrible scent. My! my! but it almost took my breath away. It seemed that I was near Gehenna. It reminded me very much of the time that I slyly took a sulphur match and run out behind the negro house and struck it, and took a good sniff just to see how it smelt. It almost took my breath away. That was when I was a little child away

back in Old Georgia, and was the first match I had ever seen. I was all curiosity to find out the whys and wherefores of things. I couldn't see how in the world it was that a little square stick not larger than a broom-stem with a little something on the end of it could have fire in it and not burn without being struck against something. And then the scent—I had a great desire to smell of one. I assure you it only took *one* to satisfy me. The funny part of it is that in telling it a few years ago I found that my sister tried exactly the same experiment at the same place with the same results.

The whole winter through, when I went anywhere near those combs, I could smell the sulphur. I next tried to keep the combs free from the moth-worms by the use of spiders. I got large spiders and put them into the hive-caps in which I had the empty frames of comb. This succeeded fairly well, but was too much worry and trouble looking after them, so my next and last trial proved not only to be much the best, but was also the least trouble. I just let the bees take care of them, even though I had to tier the hives up three stories. This, of course, could not be done up North so successfully as here, where we have such mild winters. The winter problem is an unknown quantity here in this sunny clime.

A sight that was always intensely interesting to me was to watch the bees just before a shower of rain during the working season. Oh! how they would come in, helter-skelter, pell-mell, tumbling, as it were, over one another in their haste to get home with their gathered sweetness. When they come in thus is the best sign that I know of that rain will follow very soon.

Kerosene oil is decidedly the best thing that I ever used to loosen and clean both propolis and wax, either from the hands or any vessel to which it is adhering. Of course, both soap and water must be freely used in finishing up the job.

Just how far bees can work successfully I do not pretend to say, but mice have been known to go three miles in a direct line. It was when I had the only Italians in this part of the country that a gentleman found them at work three miles east of my apiary. They were working in such force that he thought there certainly must be a bee-tree close by, so he baited, lured and traced them to my apiary on three different occasions. This satisfied me that they could work successfully that distance. How much further than this they could work profitably, I am sure I do not know.

On two different occasions I had fine Italian queens to take wing and fly from the hive several days after successful introduction. The first one never returned, though I sat near the hive and watched impatiently for her until it was too dark to see a bee on the wing. Oh! how blank and badly I felt can only be realized by those who have had a like experience.

The second one I actually caught in my hands after she had gotten several feet from the hive. I put her back and closed the hive so that not a bee could leave. I let it remain closed until dark, then opened the entrance. After this she remained satisfied, and proved to be a very prolific and fine queen.

Along about this time I came to the conclusion that I lost rather than gained by opening the hive so often. I also learned from outside appearances to tell pretty well what was on the inside without so much manipulation. I soon learned from the peculiar movement of the bee to know when they had lost their queen, without opening their hive. I think that the novice loses a great deal by opening the hive too often, yet, it seems that they can learn their habits and peculiarities in no other way. Experience, after all, is the best teacher.

I had a good-sized bee-proof tent in which to do all necessary work, with a large wire-cloth window in the south side, through which I could not only get plenty of air, but could also see every colony in the yard, together with four gates, so I could see if any one was coming, which was at least a relief

to me. Were I again going to establish an apiary here, I should most certainly pattern after the one I had, in almost if not quite every detail. I had things, to my way of thinking, at least, so *very* conveniently arranged. The only change of any importance that I would make, would be that I would have my honey-room floor on the ground, so that I would not have to carry the honey up so many steps as I had to do.

When I saw that rubber gloves were advertised and recommended, I, of course, wanted a pair. The amusing part of it was the directions said that they were not numbered as other gloves, but just open the hand out and mark around it, and send the measure this way. Well, out I spread my hand, and took an ordinary lead pencil and marked around each finger and thumb thus spread out. Well, I guess you would have laughed to have seen those gloves. The measure was returned with the words, "*Small hand*," on it. I was mortified and ashamed of my stupidity; so much so that I never returned them to have them exchanged for a smaller pair. I could put both hands into one glove with quite a lot of spare room. Of course, they did me no good on account of their immense size.

The kind of gloves that I liked best and used most (when I used any at all), were made of a pair of thin cotton-socks, with a nick at the heel through which to put my thumb, with the toes cut off convex for the back of my hand, so as to cover the whole hand and fingers; concave on the inside, so that I could have free use of my whole hand. See?

By far the best fuel I have ever used was not "dead live-oak," but rotten elm. It is white, and breaks off in great layers—is easily broken into small enough pieces to fill into the smoker. Just put a live coal in first, and then the rotten elm, give a few puffs, set the smoker nozzle up, and it will continue to burn for hours, or as long as the fuel lasts, and oh! such a smoke as you will have! When I would be riding out for any purpose I was on the lookout for rotten elm, or cotton-wood, which was about as good as the elm.

Salado, Bell Co., Tex.

(Concluded next week.)



Supplying the Home Honey Market.

BY F. A. SNELL.

In about five weeks after my first visit is made to town No. 1, I again take a trip to the same place, with a supply of honey. On arrival I first call at the grocery where I left my honey to be sold on commission. The grocer informs me that he has sold quite a large part of my honey, and would like to have a new supply. This time he is ready to buy, and I sell him quite a lot of the comb, and also some of the extracted. After this time I sold him hundreds of pounds each year so long as he remained in the business, and, later, to his successor.

The others with whom I dealt on my first trip were next seen, and found ready for a new supply. When room would permit, and a number of cases of honey were taken, I would place the cases three or four deep, the small at the top, which we all know presents a very neat view of the honey-combs through the glass in the side of the case. One case was set to one side, from which to retail.

The grocers have, without exception, been pleased with my arrangement of the honey when so placed. Pails or cans are also placed where they may attract attention, the label being always placed in full view of those entering the stores.

I have found it very useful to give each grocer some hints as to where the honey should be kept during cool weather in fall and winter, so that it may not deteriorate. I have found that, nine times out of ten, if I say nothing about the matter, the honey will be put in the coldest part of the store, or in a back room, except the one case from which to retail; and in

one instance the larger part of the purchase was put into a damp cellar, and nearly ruined. The same I have found to be true in selling to private parties.

The bee-keeper must do a great deal of talking along this line of instruction. To old customers I do not now have much of this to do; but with new ones it seems as necessary as ever.

Right here is a very important point for all bee-keepers to consider. As good honey as can be produced may be nearly ruined by unwise handling; and when such deteriorated honey is consumed, it disgusts the consumer, nearly ruins future sales, and, where hundreds of pounds could have been sold, only tens are disposed of.

After supplying with the honey all the dealers named, and a few minutes spent in pleasant conversation, I take my leave, with the understanding that I will supply them so long as my stock of honey lasts; or, if no more is on hand, to call on them the next season if a crop is secured. And so I have aimed to keep my trade in all these towns by keeping them supplied when I have had any honey to sell, always aiming to make our deal as pleasant for my patrons as for myself. The honey should be well ripened, kept later in a hot, dry honey-room, put up for sale in the neatest way possible, and each package labeled with the name of the producer, etc., and sold for just what it is. If the honey is No. 1, sell it as such; if not, or only No. 2, use no deception, but deal honestly. In complying with the above, trade once gained will be held, and a clear conscience also.

Town designated as No. 3 is distant from my apiary 13 miles, and had at one time within its borders, and near by, fully 500 colonies of bees. Owing to the large number of bees kept, and over-supplying this market, the price of honey ruled low. If some of the honey produced there had been marketed in adjoining towns, paying prices might have been maintained; for the amount of honey produced in or near the other towns was slight. Many times the low prices realized for honey are our own fault, and are caused by the unwise or foolish distribution of our honey in marketing, as indicated above. Bee-keepers should consider this matter thoroughly from the Atlantic to the Pacific. We see some of our large cities overstocked with honey nearly every year, while other good markets are hardly considered. At present the town mentioned above has within its borders but few bees; but the people have come to think that they should not pay over 10 or 12 cents for the finest comb honey in section-boxes; or a large portion seem to at least. I never sold, or attempted to sell, any honey in that town until recent years, for two reasons, viz.: First, the market belonged to my bee-keeping friends living there; and, second, the prices did not suit me. Having a little other business, I thought to supplement it by taking along a few cases of comb honey and a few cans of extracted on this my first visit as a honey-seller.

On my arrival I drove up to a grocery, and tied my horse. The grocer was just placing some newly-arrived peaches out in front of his store. After a little conversation as to the fruit, I told him I had brought some honey to town, and would like to have him look at it. I took a case of comb honey from the buggy, and placed it near him where it could be inspected. The honey through the glass looked tempting. I removed the cover, then took out a few boxes for his inspection. He said he had never seen any neater honey than that, and it was well put up. Three or four townsmen came up and looked at the honey. He asked me what I was selling it at. I told him 15 cents per pound. He said he had no fault to find with the honey; but when honey had to be retailed at over 12 or 15 cents, it was slow selling in their town.

I informed him that, in the other towns, I was selling at 15 cents, and no complaint. He declined to take any. I then had him sample the extracted. He thought it fine. I gave him the price, stating that no one should find fault with

the price he could sell this at; but my efforts with him were apparently in vain.

Right here I wish to say that, in this town, those new in the extracting business had, years before, taken unripe honey from their bees and sold it, which had nearly ruined the sale of honey in this form, as it fermented, and was not fit to sell as honey.

I next called at grocery No. 2. Finding them busy, I waited until they had a little leisure. I noticed an old case containing, perhaps, 25 one-pound sections, all daubed with propolis, sections and combs dark, looking as if they had been in use many years. The combs were only partially filled with honey, and, of course, not capped. At a leisure moment I made my business known, and I secured their permission to bring in a case of my honey. It was viewed through the glass readily. I removed the cover, and took out some of the boxes for their inspection. The honey suited them. My price was asked and given.

"We have some comb honey over here," showing that first noticed by me on entering their store. I asked who produced it, and learned that he was an old friend, and a man of intelligence quite above the average. I knew him to be, as the reader knows well, not made for a bee-keeper. At first I sold them one case of the honey. I stated that I should not be in with honey that season again, and would think they could readily sell more, but that they were to be the judges in that matter. They took one more case, thinking also that they could do so. As they had a supply of extracted, I made no sale, but let them sample my own. The price was 15 cents per pound for the two cases. I left, with the encouragement of probable future sales.

The next grocery was visited, and I found it unsupplied with honey; so I effected a small sale of comb and extracted, and shall try to supply that store with honey in the future, if I am so fortunate as to get a crop of honey.

A few cans of the extracted were sold before leaving town, to private parties, for home use.

Where I have made sales of any consequence of extracted honey at the stores, I have not retailed; but if no honey could be sold at the stores, I have felt free to retail it in any such town, either in or out of the comb. The results of the day in selling honey were limited, but the start had been made in opening up what may prove to be a fair market for honey near home at fair prices.—Gleanings.

Milledgeville, Ill.



Notes from Virgil—Something Historical.

BY EMERSON T. ABBOTT.

(Continued from page 534.)

They also seem to have begun early the study of the question of color, and in the days of our annotator, a few at least had begun to recognize the fact that the so-called ruler of the hive is a female.

"One shines with Gold, whom glorious Colors grace."

"The Queen (for Mr. Butler will have it a Feminine Monarchy) is a fair, stately Bee, differing from the rest in shape and color; her Back a bright Brown, her Belly a sad yellow; her tongue and spear shorter than the other Bees, who both provide and fight for her.

"Two sorts they are,"

says Virgil; upon which the annotator remarks, "This plurality of Kings is observed by Aristotle. 'One,' saith he, 'is red, which is the better, the other black and spotted, twice as big as the rest.' Varro seems to make three Kinds, the black, red, and spotted; These are observed to be in the higher part of the Hive, and if there be any division among them, they destroy all but that one which is the best. This two sorts of

bees Mr. Butler disproved, only distinguishing them into tame and wild.

"Columella following the authority of Aristotle and Virgil most approves the small, long, light, shining with gold, distinguishing evenly with spots, and most gentle."

They also had an idea in early times of planting for bees.

"Set Thyme about their Roofs."

"With this Bees are observed to be much delighted, and to prefer it before all Flowers. Thence the *Attick* Honey is commended by *Galen*, and the *Sicilian* by *Varro*, both of these places abounding with that Herb."

They had weather prophets in that age, as well as this, and it seems they got their information from the bees.

"Nor from their Hives they stir when Rain is nigh."

"And when they perceive that either or both of these (Rain or Cold) are near, they fly not far from their Hive, but flying about the Hive they set upon them as upon Flowers. From these things the keepers of Bees foretell Tempests to the Husbandmen."

Here follows a theory as startling and revolutionary as that of "Spontaneous Generation" in this age:

"Tis strange that Bees such Customs should maintain,
Venus to scorn, in wanton Lust disdaine
To waste their strength; and without throws they breed,
But cull from Leaves and various Flowers their Seed."

"This is one of those questions with which Philosophy hath been puzzell'd. Aristotle and Pliny deliver nothing certain upon it. Amongst several Opinions, our Author chooseth theirs, who affirm, That in Flowers and Herbs there is something corresponding to seed, which is by the Bees gathered, carried into their Hives, and cherish'd into Life."

They also began the discussion as to the age of bees.

"Though soon the term of their short Life doth glide,
(For the seventh Summer a full period gives)
Yet their Immortal Race forever lives."

"About the age of Bees (saith Mr. Butler) there are divers opinions, some thinking they may live four or five years, some six or seven, Aristotle speaks of a longer time, nine or ten: but the truth is, a Bee is but a years Bird, with some advantage; For the bees of the former year which until Gemini in the next year look so youthfully that you cannot discern them from their grown Nymphs, do from thenceforth change with manifest difference, wither'd, rough, whitish, ragged, etc."

They learned early the importance of the queen to the colony, but thought her a *ruler* instead of a *mother*. However, some have not gotten far from that idea yet.

"They honour him, and with a Martial sound,
Circle about, and strongly guard him round."

"If their Queen go forth, they attend her with a Guard before and behind; they which go before ever and anon returning, and looking back make signs of extraordinary Joy; in which manner they bring her home; if by her voice she bid them go, they swarm: Whil'st she cheereth them to Battel, they fight; if she droop and dye, they either languish and dye too, or yield to the Robbers, and fly away with them."—*Butler*.

St. Joseph, Mo.

[Concluded next week.]

Only One Cent a Copy for copies of the American Bee Journal before Jan. 1, 1896. We have them running back for about 10 years. But you must let us select them, as we cannot furnish them in regular order, and probably not any particular copies. Just send us as many one-cent stamps as you may want old copies, and we will mail them to you.

The McEvoy Foul Brood Treatment is given in Dr. Howard's pamphlet on "Foul Brood; Its Natural History and Rational Treatment." It is the latest publication on the subject, and should be in the hands of every bee-keeper. Price, 25 cents; or clubbed with the Bee Journal for one year—both for \$1.10.

Questions AND Answers

CONDUCTED BY

DR. C. C. MILLER, MARENGO, ILL.

[Questions may be mailed to the Bee Journal, or to Dr. Miller direct.]

Bees from the South.

By getting a queen from the South, can I get a good working class of bees?
E. E.

ANSWER.—Just as in the North, you may get from the South an excellent strain of bees, or you may get some of the poorest. I suppose the mere fact of bees being in the South makes no difference in their character. Perhaps bees that had been for years wintered in a very severe climate might have a greater percentage of good winterers among them, from the fact that the poorer winterers would be killed out. But just as good winterers might be among the Southern bees. One advantage in Southern-bred bees is that they can be had earlier in the season than those in the North.

Showing Bees and Honey at Fairs.

Our county fair will open the first week in September, and they wish me to take a few colonies of my bees there. Now, I would like to hear what you would do. I have not one pound of comb honey in sections to show—nothing but about 50 pounds of extracted. How would it be to cage a queen and show cell-building, dipping cells, and transferring royal jelly and larvæ; also melting combs with the sun extractor? There has never been a colony of bees brought to our county fair, and if I bring one or two I will be the only one. I always get 25 cents for one-pound sections of comb honey, or five sections for one dollar, but not one to show, or sell. Would you bother about it, or not? Give me your good advice, and do not say "I don't know."
E. B. K.

ANSWER.—You're on the right track. It is hardly possible for you to show anything in the line of bees or bee-keeping that will not be of interest to the fair-going public. Be very careful, however, about having live bees at large at a fair on account of the danger of the bees stinging people and horses. Probably you can show nothing of more general interest than a single-frame hive with glass on both sides, so the people can see brood, worker and drone comb, queen, drones and workers. Couldn't you give them an object lesson in extracting honey? Have a few frames of honey to extract, keeping a sharp lookout for robber bees, or perhaps it would answer the purpose to have some empty combs, filling them by sprinkling water over them, then extracting the water. It's a very hard matter to get people to understand exactly what extracted honey is, but when the extractor is at work before their eyes the matter is easily understood. Of course the greater variety the better.

Killing a Colony of Bees.

I have had a colony of bees now three years, and it never stored any surplus honey. So I want to kill it. How can I do it?
G. S.

ANSWER.—The quickest way, perhaps, would be to blow them up with dynamite. A lot of small boys might be got to stone them. An objection to either of these plans is that the combs would be somewhat injured, and in the latter case, while it would give the small boys unbounded delight as well as a few stings, it would cultivate in them an undesirable spirit of cruelty. So it may be better to use the orthodox method of destroying them by brimstone. Dig a little pit in the ground, put into it some lighted rolls of rags and sulphur, and after dark, when all the bees have entered the hive, set fire to the rolls and set the hive over, putting rags around the bottom of the hive so that no bee may escape its proper doom.

But now are you sure those poor bees deserve death? Is it not just possible that they have done the best they could?

If there wasn't enough honey in the flowers to support them and give a surplus besides, it seems unjust to punish them so severely. I had a lot of bees that behaved the same as yours. In the year 1894 they not only gave no surplus, but they didn't even get their own living, and to get them through the winter and spring I had to feed them an even ton of granulated sugar.

The next year, 1895, although they got their own living, they gave me no surplus. Now, if at the beginning of the year 1896 I had said to them that they were doomed to die because they had been a loss instead of a profit to me for two years, I would have made a mistake, for this year they have given enough surplus to pay back the ton of sugar and leave me several hundred dollars besides. If no other bees around you are getting surplus, then you may be pretty sure it is not the fault of the bees, but next year may reward your patience. If other bees are getting honey and yours none, then the best thing is to give them another queen so as to change the breed. But please don't kill the poor little creatures for what they can't help.

How to Make Honey-Vinegar.

Please tell us in the American Bee Journal how honey-vinegar is made. Please give the whole process, and how long it takes to make it. J. F. K.

ANSWER.—You can hardly miss in making vinegar of honey. All that's necessary is to have some water with the honey, keep it reasonably warm, and let the air get to its surface. The stronger it is the longer it will take to make, and the cooler it is kept the slower will be the acetous fermentation. Probably most of the honey-vinegar is made from the washings of cappings, in which case it would be hard to say how much honey is used to a gallon, and different persons make it of different strength. In the chapter on vinegar in Root's "A B C of Bee-Culture," E. France says it takes two pounds of honey to make a gallon of vinegar, and it takes two years to make it. "To know when the water is sweet enough, put in a good, fresh egg, and make the water sweet enough to float the egg so there will be a patch of the shell out of the water about as big as a silver 10-cent piece; then it is about right. We keep ours standing in barrels, with one head out, to give it air: for air it must have to make vinegar. Tie a square yard of cheese-cloth over the top of the barrel, to keep out dirt and flies and other insects. Keep under cover out of the rain, in a warm, dry, airy place."

G. D. Black says: "One pound of honey will make one gallon of vinegar, as good as most of the cider and white-wine vinegar that is sold; but to make strong, No. 1 vinegar, it requires two pounds of honey to the gallon."

H. A. Palmer says: "One pound of honey will make three gallons of better vinegar than one can buy."

Probably you can have vinegar in the course of a summer season if you keep it in the hot sun, with plenty of surface to the air, and not more than a pound of honey to the gallon.

Swarming Bees—Weight of Swarms—Changing Depth of Cells—Honey from Corn.

J. T. H., of Columbus, Ohio, asks on page 486, about non-swarming bees. If he was near here, I could let him have bees that would swarm enough to suit him. I had 43 colonies last spring, and 40 of them swarmed, and two of the swarms swarmed, after they had filled two supers of 24 sections each. I secured 72 swarms in all, three of which "pulled out" for the woods. I doubled some up, some doubled themselves up, and I have now 65 colonies, and have secured over 1,200 pounds of basswood honey. I tried to keep them from swarming, too; some had one super on, and some two, and they were all working in them, too. They had them from one-third to two-thirds filled with comb, and some had begun to seal some of the sections. So I think my bees could satisfy J. T. H. in swarming.

J. M. asks on page 487 about the weight of prime swarms. I weighed all my swarms for two years, and they averaged 6 pounds; that is, the prime swarms, and the second swarms 3 pounds. The heaviest prime swarm weighed 8 pounds, and the lightest 5½ pounds. I have the 8-frame hive.

Now, I would like to ask a few questions, but I have not the "cannon" loaded quite as heavily as a year ago.

1. When a prime swarm is hived on starters or empty frames, they rear brood close to the top-bars, but when that brood hatches they lengthen the cells along the top-bars for 2 or 3 inches down, or more, and fill them with honey. Now,

do they shorten those cells the next year, and rear brood in them again, or do they leave the cells long? I rather think they shorten them the next spring, as some of mine had worker-brood clear up to the top-bars, and drone-brood on the side of the V of the top-bars this spring, but I am not sure whether those frames had longer cells than brood-cells last year, or not.

2. How long after a prime swarm is hived on empty frames with one-inch starters, does the queen begin laying? This summer I had a weak queenless colony that I wanted to put a prime swarm in with, so I hived a prime swarm in a box and stood them quietly, in the evening, on top of the queenless one, and in 36 hours they had not gone down, so I smoked them down, and in that time they had comb built and some eggs in it, so I know they will lay in 36 hours, but I don't know how much sooner.

3. Do bees gather honey from corn blossoms? Last year I got a lot of amber honey between basswood and golden-rod, and the bees were thick on the corn, but they seemed to all have pollen. This year they were not as thick on the corn, and I am not getting so much amber honey. There are lots of pumpkins, squash, melons, cucumbers and smart-weed in range of my bees.

4. Do bees gather both honey and pollen at the same time? Chanhassen, Minn. J. M. S.

ANSWERS.—1. You will find the same depth of cells always for worker-brood, and always the same for drone-brood. If bees lengthen out the cells when storing honey, as they may do no matter in what part of the frame, whenever those cells are to be used again for breeding purposes they are cut down to the regular size before an egg is laid in them. Put into the middle of a brood-nest a comb of sealed honey two inches thick, at a time when bees are anxious to rear brood, and you will find that the bees will commence at the lower part, emptying out the cells and cutting them down to the proper depth, and sometimes you will find the deep cells at the upper part, still sealed over, and immediately adjoining the shallow cells with eggs and brood. A waste of wax and work, of course, but what better can they do?

2. I cannot answer with authority, but I suppose in much less than 36 hours, for the queen is often found dropping eggs immediately after the swarm is hived, one of the ways of telling whether the queen is with the swarm being to put a blackboard under so that the white eggs dropped on it will show plainly. Now just as soon as the bees can get the foundation drawn out to the depth of a quarter of an inch or less, the queen will lay in the shallow cells, and that may be in 12 hours, possibly in half that time. After you have made some careful observations in the matter as you have regarding the weight of swarms—for which please accept thanks—will you kindly give us the result of your observations?

3. I don't know. I have some doubts whether corn-tassels yield anything but pollen. Bees sometimes gather something in the line of nectar from the joints of the leaves of the corn.

4. The principal honey-plants yield both honey and pollen. Of the remaining larger number, some yield honey only, and some only pollen. When working on plants that yield both honey and pollen, some bees gather only honey, and some both honey and pollen. I doubt whether a bee ever gathers only pollen from a blossom that contains nectar at the time the bee visits it. I think you will generally find the heaviest loads of pollen early in the day, and perhaps the same is true of honey, but toward the middle of the day you will find the larger number of bees entering the hive with honey only.

The Alsike Clover Leaflet consists of 2 pages, with illustrations, showing the value of Alsike clover, and telling how to grow it. This Leaflet is just the thing to hand to every farmer in your neighborhood. Send to the Bee Journal office for a quantity of them, and see that they are distributed where they will do the most good. Prices, postpaid, are as follows: 50 for 25 cents; 100 for 40 cents; or 200 for 70 cents.

The Names and Addresses of all your bee-friends, who are now taking the Bee Journal, are wanted at this office. Send them in, please, when sample copies will be mailed to them. Then you can secure their subscriptions, and earn some of the premiums we have offered. The next few months will be just the time to easily get new subscribers. Try it earnestly, at least.

OLDEST BEE PAPER IN AMERICA

THE AMERICAN BEE JOURNAL

ESTABLISHED IN 1861

GEORGE W. YORK, Editor.

PUBLISHED WEEKLY BY

GEORGE W. YORK & COMPANY,
118 Michigan St., CHICAGO, ILL.

\$1.00 a Year—Sample Copy Sent Free.

[Entered at the Post-Office at Chicago as Second-Class Mail-Matter.]

Vol. XXXVI. CHICAGO, ILL., AUG. 27, 1896. No. 35.



Beginners and Bee-Books.—It seems strange that any beginners in bee-keeping will think of getting along without a good book on the subject. It would save them asking many simple questions, and especially from pestering older bee-keepers, one of whom (who is in our Question-Box corps, and who lives east of Illinois) says this in a private letter:

MR. EDITOR:—I find in my own experience, that if I would write to all the querists who write me (and don't even send stamps for reply), that I would have quite a handful. It surprises me that there are so many who say to me (and I of course get but a few of them), "Why, you can tell me this at once, with no trouble." They don't think, I suppose, that I had to be at the trouble to learn it, or that my time is of any value. Well, I say to them all, "Get a bee-book, study it, and you will then know."

I get six or eight letters a week, now—sometimes I have had 20 or more—asking foolish questions. You, as publisher of the American Bee Journal, have to use some consideration in the matter, but even in that case, why should any one suppose a bee-paper is a treatise on bee-keeping?

I have written three letters to-day in answer to those who ask me why the bee-papers don't give more information to beginners. My only reply can be, that beginners are supposed to know first principles, and that *bee-papers* are published to keep their subscribers in touch with the bee-world, and to post them on new ideas and new theories as they are advanced.

I am pleased to know from week to week, that the American Bee Journal, in your hands, is fulfilling its mission; that it is of great value to bee-keepers in that it treats of the subject calmly and dispassionately; that it lets in the ideas of its writers without fear or favor, and dares at all times to comment on those ideas, as to your mind they seem to need.

Now, we submit the above to all beginners, feeling assured that they will easily see that it is not right to annoy older bee-keepers with a lot of simple questions, whose answers can be found in any of the standard text-books. A good bee-book is to the new bee-keeper what a needful tool is to the mechanic. No one should think of starting with bees without getting a book in addition to the papers.

Again, beginners must remember that there are those who have taken the papers for years, and they do not wish to read A B C matter all the time. Neither would it be right for the papers to devote their space entirely to primary bee-keeping, any more than the great daily newspapers should teach people how to read, or how to solve simple problems in arithmetic.

By all means, Mr. Beginner, get a good book on bee-culture, read it in connection with the bees themselves, and thus gain knowledge for yourself. All questions that cannot be answered by the books, are proper ones to send to a bee-paper. But please excuse publishers if they do not tell over and over the first principles of bee-keeping in their papers.

The Lincoln Convention, Oct. 7 and 8.—We have received the following further notice concerning the next North American meeting, from the Secretary, Dr. A. B. Mason:

STATION B, TOLEDO, Ohio, Aug. 18, 1896.

MR. EDITOR:—As you already know, the next meeting of the North American Bee-Keepers' Association is to be held in Lincoln, Nebr., in one of the University buildings, on the 7th and 8th of next October, commencing at 9 o'clock a.m. of the 7th, and closing with the evening session on the 8th.

The securing of railroad rates, and all arrangements at Lincoln, have been left by the Executive Committee with the Nebraska bee-keepers, and my correspondence has been mostly with Mr. L. D. Stilson, editor of the Nebraska Bee-Keeper, and Secretary of the Nebraska State Bee-Keepers' Association, and through his efforts arrangements have been made by which the railroad rate will be one fare plus \$2.00 for the round trip, tickets to be bought on Oct. 6, but I learn that the Lake Shore and Michigan Southern railroad has not yet entered into the agreement, but probably will do so before the time of meeting.

The way for bee-keepers east of Lincoln to take advantage of the Homeseekers' Excursion rates is, to purchase their tickets to a point beyond Lincoln, then stop off at Lincoln for the convention, and afterward go on to the point to which the tickets were purchased, pay the extra \$2.00 there, and start on the return trip. But your local railroad agent should be able to give you definite information about this.

In addition to the above it is possible that a rate of a fare and a third on the certificate plan will also be made to accommodate those who cannot take advantage of the Homeseekers' Excursion rate. Watch the bee-papers for further announcements as to rates.

The Wabash railroad will sell tickets on the above date for one fare for the round trip, which, from here, is \$21.40. As yet, I have received no information about rates from north, south, or west of Lincoln.

The Nebraska bee-keepers have promised to entertain free all members of the Association who live outside of Nebraska, and any one interested in bee-culture can become a member by the payment of one dollar to the Secretary. It seems to me that Nebraska bee-keepers have taken a good-sized contract, and I hope we shall have the largest convention the Association has ever held, but the Nebraska bee-keepers are said to be "hustlers," and there need be no fears about their filling their part of the bill, even if hundreds of bee-keepers "try their mettle."

That all may know something of what to expect, the following program has been provided:

Honey Commission—Men and Adulteration—George W. York, of Chicago, Ill.

Improvements in Bee-Culture—Ernest R. Root, of Medina, Ohio.

Bee-Keepers' Exchange—Prof. A. J. Cook, of Claremont, Calif.

The Past and Future of Bee-Keeping—Mrs. J. N. Heater, of Columbus, Nebr.

The Union and Amalgamation—Thomas G. Newman, of San Diego, Calif.

How to Secure Comb Honey—W. Z. Hutchinson, of Flint, Mich.

Importance of Water in the Apiary—Hon. E. Whitcomb, of Friend, Nebr.

Economic Value of Bees and their Products—C. P. Dadant, of Hamilton, Ill.

Some of the Conditions of Nebraska—L. D. Stilson, of York, Nebr.

The Honey-Producer and Supply-Dealer—Rev. Emerson T. Abbott, of St. Joseph, Mo.

The Wild Bees of Nebraska—Prof. Lawrence Bruner, of Lincoln, Nebr.

Artificial Heat and Pure Air, Properly Applied in Wintering—R. F. Holtermann, of Brantford, Ont.

An original poem by Hon. Eugene Secor, of Forest City, Iowa.

Sweet Clover as a Honey-Producing Plant—Wm. Stolley, of Grand Island, Nebr.

How to Winter Bees Successfully—Hon. Geo. E. Hilton, of Fremont, Mich.

The Production of Extracted Honey—Two brief papers, one by N. E. France, of Platteville, Wis.; and one by J. C. Balch, of Bronson, Kans.

—Mrs. J. M. Null, of Miami, Mo.

President A. I. Root will give an address on some subject that will be of interest to all.

It is the present intention to devote the first evening's

session to addresses of welcome by Gov. Holcomb, in behalf of the State, and by the Chancellor, Hon. Geo. E. McLean, in behalf of the State University. Responses will be made by Hon. Eugene Secor, of Iowa, and others who will be named later. Ex-Gov. Saunders, an old-time bee-keeper, will also address the convention; and at some session Prof. Chas. E. Besse will tell us something about "Botany as Related to the Honey-Flora."

I am informed that there will be from 1,500 to 1,700 students at the State University, and it is probable, if time will admit, that from 600 to 800 of them will desire to listen to one or more brief addresses on apiarian subjects that will be of interest to them.

It is possible that too many papers and addresses have been provided for, but it is fair to presume that the Nebraska bee-keepers are "hustlers," and we know that those whose names are on the program are also "hustlers," or they would not have been put there, for this is to be a meeting of "hustlers."

Mr. E. Whitcomb, President of the Nebraska State Bee-Keepers' Association, writes me that "No pains will be spared to make the meeting the most pleasant ever enjoyed, and Lincoln. . . . will be yours on that occasion;" and the editor of the American Bee Journal says, "Let's simply astound the Nebraska people with numbers."

It is expected that the Amalgamation Committee will make a report that will be of interest to every bee-keeper on the continent, and it is hoped as many will be present as possible. A. B. MASON, Sec.

Judging from the above list of papers, with the exception of the first, we are looking forward to a very profitable convention, especially when we consider the other attractions mentioned by Dr. Mason. It seems to us that every bee-keeper who possibly can go, should be present. Then think of the heretofore unknown generous hospitality to be extended by those Nebraska bee-keepers! Why, that's simply wonderful.

If this convention is not the largest and best ever held, it won't be the fault of the Nebraska bee-keepers.

Next week we hope to be able to say something about railroad rates from Chicago. We would like to arrange to have those from the East, and those near Chicago, all go together from here. It would make a pleasant company—a sort of preparatory meeting for the greater convention after reaching Lincoln.

PERSONAL MENTION.

PRES. A. I. ROOT will be at the Lincoln convention, nothing preventing.

DR. MILLER writes us: "If all is well I expect to be at Lincoln." Good.

EDITOR ERNEST R. ROOT, of Gleanings in Bee-Culture is "booked" for the North American convention in October, at Lincoln, Nebr. That's all right.

MR. T. F. BINGHAM, of Farwell, Mich., writing Aug. 15, said: "The honey season has been good." A good many tell the same good story this year. Good enough!

REV. EMERSON T. ABBOTT, of St. Joseph, Mo., expects to be at the Lincoln convention, Providence permitting. We would be glad if others, who fully intend being there, would let us know, so that we can announce it.

PROF. A. J. COOK writes: "The entire failure of the honey crop in California will result in the starvation of many colonies, unless bee-keepers are keenly alive to the necessity of feeding." Surely, no real bee-keeper will allow his bees to starve!

PROF. COOK, in a recent number of the Bee Journal, was made to say that Mr. McIntyre was holding his last year's honey crop to get 30 cents per pound. It should have been 6 cents per pound, and not 30. The latter figure would be rather steep, these days.

MR. R. MCKNIGHT, of Owen Sound, Ont., contributed to the Toronto Saturday Globe for August 1, a lengthy article on "Bees and Honey," which is illustrated with 12 large and

beautiful half-tone engravings. Mr. McKnight has in this rendered a distinct service to Canadian apiculture, which will help in popularizing honey as well as in conveying correct and helpful information about bees and their habits. It were well for the whole people if more such valuable work could be done in other places. Mr. McKnight deserves the thanks of all lovers of the honey-bee, for his excellent effort.

MR. WM. MCEVOY—the Foul Brood Inspector of Ontario—we have secured to take the place of the late Allen Pringle in replying to the questions in our "Question-Box" department. Mr. McEvoy is well and favorably known in Canada, and no doubt our subscribers there will be pleased to know that he will "keep up Canada's end" of the "Question-Box."

MR. R. C. AIKIN expects to drive through from Colorado to the Lincoln convention, according to this letter received from him last week:

FRIEND YORK:—in a week or so we will start by wagon, and expect to travel in Colorado, Kansas, and Nebraska, reaching Lincoln for the convention. R. C. AIKIN.

HON. J. M. HAMBAUGH, of Escondido, Calif., was recently visited by the "Skylarking" contributor of Gleanings. As most of our readers know, Mr. Hambaugh was formerly a resident and legislator of Illinois. He, with Mr. Jas. A. Stone, had charge of the large Illinois State honey exhibit at the World's Fair, in 1893. Mr. Hambaugh was also the hard-working President of our State bee-keepers' association, and is greatly missed at its meetings as well as elsewhere.

MR. JOHN M. SMITH, Secretary of the East Tennessee Bee-Keepers' Association, writes:

"Bee-keeping is now on a higher plane than ever before in East Tennessee. Almost everybody is discarding the box-hives and log-gums, and taking up modern bee-culture. I wish the American Bee Journal success."

Let the good work go on until all shall see that in order to be successful the old methods of bee-keeping must give way to the new.

MR. WM. F. CLARKE, of Guelph, Ont., who has been for years a writer on general farm topics in the Montreal Weekly Witness, had this good word to say for the American Bee Journal, in reply to a questioner, in the issue for Aug. 4:

"I am asked to say which, in my opinion, is the best practical bee-publication? I answer without a moment's hesitation, the American Bee Journal, of Chicago, Ill. It is a weekly, a marvel of cheapness, being only a dollar a year, and its contributors are among the best bee-keepers on the continent. What they do not know about the pursuit is not worth knowing."

Our thanks are hereby tendered for the expression of appreciation.

MISS ANNA C. MARCHANT, of Oak Park, Ill., is one of the new lady bee-keepers. (We don't necessarily mean by this that she's one of the "new women" people read about.)

We had the pleasure of calling on Miss Marchant, on Saturday, Aug. 8. By the way, she is one of the teachers of drawing in the Chicago public schools. She also spends a part of her time now in "drawing" beautiful squares of comb honey out of her hives!

Miss M. began with one colony in May, 1895. By dividing, she had three colonies by fall, and had taken 170 finished sections of honey! Talk about helpless and inferior woman! We'd like to know the name of the man that can equal that result in his first season with bees!

The three colonies wintered nicely, and when we called on Miss M. she had nine colonies, and had taken nearly 100 pounds of comb honey from one of the old colonies. The increase was all made by dividing. She gets a good price for her honey, and is very enthusiastic about her growing apiary, located about eight miles west of Chicago, in the midst of acres upon acres of sweet clover, which was blooming in all its beauty when we were there.

Miss Marchant wintered her bees successfully on the summer stands, with a special winter case for each hive, about six inches larger than the hive, and having a gable cover.

Her apiary is under a nice group of large willow trees at the rear of the house, which make a delightful shade, but not too much, as the lowest limbs are quite high above the ground.

We wish Miss Marchant continued success with her bees.

Question-Box.

In the multitude of counsellors there is safety.—Prov. 11-14.

Late-Reared Bees for Strong Colonies for Wintering.

Query 26.—What would you do in order to obtain a large number of late-reared bees to insure strong colonies in the fall for safe wintering?—**COLO.**

Dr. C. C. Miller—Have no old queens.

W. G. Larrabee—A late honey-flow is the best way.

Wm. McEvoy—Feed the colonies in the evenings.

G. M. Doolittle—I let the bees take care of this matter to suit themselves.

Dr. J. P. H. Brown—Feed in proper quantity and at regular time to keep up brood-rearing.

Chas. Dadant & Son—Leave the hive with plenty of honey, and let the bees take care of that part.

J. A. Green—See that the queen has room for laying in the brood-chamber, and feed regularly.

Prof. A. J. Cook—Late stimulative feeding in case there is no fall honey crop would help, but I doubt if it pays.

Eugene Secor—I have never found it necessary to do anything in this locality. If necessary, I know of no way except to feed.

R. L. Taylor—If the bees were getting no nectar I would feed each colony regularly every day, from a pint to a quart of thin granulated sugar syrup.

Mrs. L. Harrison—In a locality where there is a fall flow of honey, do nothing; where there is none, feed according to locality; feed while yet there is pollen to be gathered.

Mrs. J. N. Heater—Nothing need to be done if natural stores are coming in so that brood-rearing is kept up in September; the queen can be stimulated by feeding if brood is desired later.

Emerson T. Abbott—I would let the bees have their own way about it, if located where there is a fall flow. Otherwise I do not know anything to do but feed; and this may pay, and it may not.

Jas. A. Stone—Don't be too greedy to get surplus honey and put on the cases for the same until the brood-chamber is well provided for. If you should commit this blunder (?), then feed your bees.

E. France—Here in southwestern Wisconsin we are never troubled with colonies not strong enough to winter. If you have a harvest of honey late, so the queen is crowded, or is short of space to lay, extract the combs and put them in the brood-nest.

C. H. Dibbern—If honey is coming in, after the usual season in June and July, I should just let them alone. If there was no honey being gathered during August, with a fair prospect for fall honey in September, I should feed a little thin sugar syrup during the time bees were gathering nothing from the fields.

Rev. M. Mahin—The only way I know to obtain a large number of bees at any time is to stimulate by feeding, if forage is scarce. My experience teaches me that there is little if any advantage in

THE "NOVELTY" POCKET-KNIFE!



Your Name on the Knife.—When ordering, be sure to say just what Name and Address you wish put on the Knife.

The NOVELTY KNIFE is indeed a novelty. The novelty lies in the handle. It is made beautifully of indestructible celluloid, which is as transparent as glass. Underneath the celluloid, on one side of the handle is placed an AMERICAN BEE JOURNAL reminder, and on the other side, name and residence of the Subscriber.

The material entering into this celebrated knife is of the very best quality; the blades are handforged out of the very finest English razor-steel, and we warrant every blade. The bolsters are made of German silver, and will never rust or corrode. The rivets are hardened German silver wire; the linings are plate brass; the back springs of Sheffield spring steel, and the finish of handle as described above. It will last a lifetime, with proper usage.

Why purchase the Novelty Knife? In case a good knife is lost, the chances are, the owner will never recover it; but if the Novelty is lost, having name and address of owner, the finder will return it; otherwise to try to destroy the name and address, would destroy the knife. If traveling, and you meet with a serious accident, and are so fortunate as to have one of the Novelties, your pocket KNIFE will serve as an identifier; and in case of death, your relatives will at once be apprised of the accident.

How appropriate this knife is for a Christmas, New Year or birthday present! What more lasting memento could a mother give to a son, a wife to a husband, a sister to a brother, a lady to a gentleman, or vice versa, a son to a mother, a husband to a wife, a brother to a sister or a gentleman to a lady—the knife having the name of the recipient on one side?

The accompanying cut gives a faint idea, but cannot fully convey an exact representation of this beautiful knife, as the "Novelty" must be seen to be appreciated.

How to Get this Valuable Knife.—We send it postpaid, for \$1.00, or give it as a Premium to the one sending us three new Subscribers to the BEE JOURNAL (with \$3.00), and we will also send to each new name a copy of the Premium Edition of the book "Bees and Honey." We club the Novelty Knife with the BEE JOURNAL for one year, both for \$1.90.

Any Name and Address Put on the Knife.

GEORGE W. YORK & CO.,
CHICAGO, ILLS.

Allow about two weeks for your order to be filled.

PATENT WIRED COMB FOUNDATION

Has No Sag in Brood-Frames

Thin Flat-Bottom Foundation

Has No Fishbone in the Sharples Honey.

Being the cleanest is usually worked the quickest of any Foundation made

J. VAN DEUSEN & SONS,
Sole Manufacturers,
Sprout Brook Montgomery Co., N. Y.

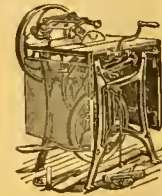

ONE MAN WITH THE UNION COMBINATION SAW

Can do the work of four men using hand tools, in Ripping, Cutting-off, Mitering, Rabbeting, Grooving, Gaining, Dadoing, Edging-up, Jointing Stuff, etc. Full Line of Foot and Hand Power Machinery Sold on Trial. Catalogue Free.

SENECA FALLS MFG. CO.,
46 Water St., SENECA FALLS, N. Y.
1A1y Mention the American Bee Journal.

WARRANTED GOLDEN

ITALIAN QUEENS By return mail; bred from a Breeder tested by Doolittle out of 1,000 Queens for his own use, and valued at \$50. Queens, 50c; 6 for \$2.75; or \$5.00 per dozen.

Leather Colored Queens from Root's best imported stock same price. Bees from my Queens are excellent workers on red clover. I guarantee safe delivery. N. B.—I sent more than 200 Queens safely to California last season. **H. G. QUIRIN, Bellevue, Ohio.**

34A9 Mention the American Bee Journal.

Untested Italian Queens, 75c.

3 FOR \$2.00.

Catalogue of Apiarian Supplies Free.

I. J. STRINGHAM,
105 Park Place. NEW YORK, N. Y.
APIARY—Glen Cove, L. I.



That Queen-Clipping Device Free!

Works Like a Charm.

The Monette Queen-Clipping Device WORKS LIKE A CHARM. With it I have clipped 30 queens, all in one day, when examining my bees. **WM. STOLLEY, Grand Island, Nebr.**

Couldn't Do Without It.

I have clipped 19 queens, and must say the Monette Queen-Clipping Device is by far the best invention ever made, and will be welcome to many bee-keepers as it was to me. I could not do without one now.

DR. GEO. LACKE, Newburgh, Ind.

PLEASE READ THIS OFFER TO PRESENT SUBSCRIBERS:

Send us just one new name for the American Bee Journal a year (with \$1.00), and we will mail you the Queen-Clipping Device FREE of charge. Or, the Queen-Clipping Device will be sent postpaid for 30 cts. But why not get it as a Premium by the above offer? You can't earn 30 cts. any easier. Almost every bee-keeper will want this Device. See page 130 (Feb. 27) for full description of it. Complete directions accompany each one sent out. It is a most ingenious and useful article. Address,

GEORGE W. YORK & CO., 118 Michigan St., Chicago, Ill.



having a large number of late-reared bees for winter. I have not room here, however, to discuss the question. [Suppose you write an article, elaborating your ideas on this subject. We should be pleased to publish it.—EDITOR.]

G. W. Demaree—I would keep up breeding by feeding just enough thin honey or sugar syrup to keep the bees busy rearing brood. But if there is some honey in the fields for the bees to gather, I would leave the breeding to the instinct of the bees. I have never known my bees to make a mistake along this line, if they can get a good supply of honey and pollen.

J. E. Pond—I find if bees are properly cared for during the season, that they will take care of themselves in this respect. For myself, I don't care to have my bees breed very late in the season, and never attempt to force them so to do. They should be kept breeding during late summer by feeding, if there is not sufficient forage for them. Any other thing being done, as a rule, I think is labor thrown away.

General Items.

Good Year for Bees.

I put my bees out on April 18. I then had 75 colonies, but before the honey season came on they dwindled down to 65. I have secured 5,000 pounds of extracted honey from clover, linden, buckwheat and golden-rod, and have increased to 100 colonies, by natural swarming. The bees are still working on buckwheat and golden-rod. This has been a very good year for bees around here.

MRS. TOMPKINS.

Billings Bridge, Ont., Aug. 17.

Plenty of Rain and Honey.

Plenty of rain means plenty of honey. We had a fine flow from clover this summer, which is coming into bloom again this fall. I have gotten about 1,500 pounds of clover honey, and if I get some fall honey yet, I oughtn't to "kick." Blackheart, weeds and golden-rod, buckwheat and Spanish-needle are all just beginning to bloom. There was about 40 acres of flax within one mile of my bees, but I never saw a bee on it.

Hurrah for the American Bee Journal!
Long may it live! JACOB WIRTH.
Rickel, Ills., Aug. 17.

Keeping Bee-Eggs—Killing Drones.

On page 442 the question is asked, "How long will a bee-egg keep?" I do not know anything about a worker-egg, but a drone egg, or eggs, will hatch and mature after they have been out of the hive 30 hours and flung into the pile of other old combs, and I suppose a queen-egg will hatch the same, or any other egg, as all worker-eggs could produce queens if so desired. Queen-cells capped or uncapped can be kept from the hive long enough to go 1,500 miles, but I should prefer not to send them by mail, and warrant them all right.

On page 466, in regard to bees killing drones, it is suggested that the bees worry them and drive them out of the hive. I have seen workers this year

—An Extra-Fine Grade of— Comb Honey!

Any one wishing something very nice in
**White Clover or Basswood
Comb or Extracted
HONEY**

for Exhibition or any purpose where a gilt-edge article is desired, should write for prices and particulars to,

JEWELL TAYLOR,
35A4t FORESTVILLE, MINN.
Mention the American Bee Journal.

What They All Say!

The Queen you sent me is the finest I ever had, and I have bought them all over the country. I am glad I can get the best right at home. Find \$1.00 for another.

MASON E. MARVEL,
Aug. 16, 1896. Oakland, Mass.

The above Queen was an Adel. I have 300 more just like her. Hardy, prolific, great honey-gatherers and practically non-swarming and non-stinging. New 4-page Catalog, giving history of the Adels and safest method of introducing Queens, sent free.

HENRY ALLEY, Wenham, Mass.
35Atf *Mention the American Bee Journal.*

RAIL ROAD LANDS

For Sale at Low Prices and
on Easy Terms.

The Illinois Central Railroad Company offers for sale on easy terms and at low prices, 150,000 acres of choice fruit, gardening, farm and grazing lands located in

SOUTHERN ILLINOIS.

They are also largely interested in, and call especial attention to the 600,000 acres of land in the famous

YAZOO VALLEY OF MISSISSIPPI

lying along and owned by the Yazoo & Mississippi Valley Railroad Company, and which that company offers at low prices and on long terms. Special inducements and facilities offered to go and examine these lands, both in Southern Illinois and in the "Yazoo Valley," Miss. For further description, map, and any information, address or call upon E. P. SKENE, Land Commissioner, No. 1 Park Row, Chicago, Ill. 33D6t

Mention the American Bee Journal.

HARDY—&—PROLIFIC QUEENS

Gray Carniolans or Golden Italians bred in separate apiaries—One Untested Queen, 65c.; six for \$3.50. Tested, \$1.25. Select Tested, \$2.25. Best Imported, \$4.00

Never saw foul brood or bee-paralysis.

✓ SATISFACTION GUARANTEED. ✓
Descriptive Price-List Free.

F. A. LOCKHART & CO.,
27Dtf LAKE GEORGE, N. Y.
Mention the American Bee Journal.

dragging drones from the hive that seemed and looked all right, but before they got through with them they lay on the ground on their side or back, kicking, and never left the spot where the workers left them.

I have kept bees and helped to handle them for five years, and I think that I have had as much experience in that length of time as a great many would have in 10 years, for after carefully reading Father Langstroth's book of 1856, I and my brother (who had lessons from an old, experienced bee-keeper of 30 years, and up to the times, and ahead, for all that) went around transferring bees from box-hives into all sorts of movable-frame hives that people had, that had been sold to them for the best, and some who had put a swarm in and had never looked into them since the swarm went in.

STRANGER.

Northfield, Conn.

No Honey-Flow Yet.

The bees are doing well in Kearney, and along the Platte river, but five or six miles north, where I live, there is no honey-flow yet.

J. C. KNOLL.

Kearney, Nebr., Aug. 11.

No Rain and Hot Winds.

Bees have done no good here this year, and are on the verge of starvation now. We have had no rain for many weeks, and the hot winds are blowing every day. Our cotton crop, instead of from 2 to 3 acres as usual, it will require from 15 to 20 acres to make a bale on the uplands.

H. C. BRALEY.

Greenwood, Ark., Aug. 17.

Still a Protracted Drouth.

We are still in a protracted drouth. The rain we had on July 10 gave us but little relief. It has been so hot and not a drop of rain since, and no rain for two months before. Bees gathered a little surplus extracted honey from cotton, but they are idle now. Could we have a good rain any time this month—enough to put cotton to growing and blooming—we could get some honey yet.

J. D. GIVENS.

Lisbon, Tex., Aug. 18.

Mailing Queens—Important Matter.

I would like to say a few words in regard to mailing queens. On page 376 it is said that in a small cage six bees are sufficient. I had a number of queens sent to me last season, from Arkansas, and I find the cage ought to be well filled with bees. I will give my reasons, as I am speaking for this part of the country. It is at long distance, and in transit bees and queens have to come in contact with quite a cool atmosphere en route. I never had a queen arrive dead where there were plenty of bees with her, but I have had them come so where there were but a few bees in the cage.

I sent to Massachusetts last season for a queen, and she arrived dead; the dealer sent me another, and she came in the same way. He then sent another, and she came alive, but very weak, and died before the bees released her. I wrote to the dealer and told him he did not put bees enough in the cage. The reply was: "It is laughable to have

you fellows give the reasons why my queens are received dead." It was not very laughable to me to have my colony queenless for two or three months, and no queen after all.

I think it does not matter about the size of the cage. I have had them come in all sizes, and come all right if there were plenty of bees. I saw five or six last season that were sent to a neighbor of mine, and they all came dead. I don't think the five or six bees mentioned on page 376 will work. I had about 40 or 50 queens come from Arkansas, and I did not have one arrive dead. That dealer always filled his cage well with bees.

I would like to see this subject brought up in the American Bee Journal. It is not very pleasant to have queens arrive dead, when you have to send so far for them. I think it would be a good thing for the one that sends queens, and also for the one that receives them, to have all get through safely. I would like Mr. Doolittle's opinion on the matter.

H. GALLOWAY.

Olympia, Wash., Aug. 12.

A Connecticut Report.

I have 3 colonies now, and have taken about 50 pounds of honey in sections. I expect to have more next year.

R. WARREN HALL.

Bridgeport, Conn., Aug. 18.

Bees Doing Well—Big Yields.

Bees are doing excellently. We have extracted 200 pounds per colony, and think we will have 50 pounds more from buckwheat, which is now in bloom, and the bees have just to step over the fence for it.

J. T. BETTRIDGE.

St. Marys, Ont., Aug. 12.

A Model Home.

MR. EDITOR:—We thank you very much for the rich treat you spread for us in your visit to the Stows, which creates a desire for more good things. Please visit them again, and serve us another course.

While in attendance at one of our National conventions at Chicago, Mrs. Stow invited me to accompany her home, which I did, and which was followed by many more invitations. These visits will always be a bright spot in my memory, and my life will always be happier by having made them.

You must return, and "on the quiet" get the photographs of Mr. Stow and the younger members of the family; and usually there is a girl there from the Industrial School, that she may learn something of home life in a Christian family; when her visit is over another enjoys the treat.

Your picture will not be complete without the pets—Dolly, the horse, that carries them to and from trains; Daisy, the cow, upon whose head there once clustered a swarm of bees, and who came nearly losing her ears by reason of their stings, and the dog and house cat—pussy, whose home is at the barn, and who is admitted in the storm enclosure, that he may dine without molestation; bees, rabbits, pigeons, and those thoroughbred fowls, receive the same loving care.

But this is not all, for companionship is made of trees, shrubs and flowers. After Mr. Stow's return from the city,

Honey-Clovers & Buckwheat SEED FOR SALE.

We have made arrangements so that we can furnish seed of several of the Clovers and Japanese Buckwheat, by freight or express, at the following prices, cash with order

	5lb	10lb	25lb	50lb
Alsike Clover	\$.70	\$1.25	\$3.00	\$ 5.75
Sweet Clover	.75	1.40	3.25	6.00
White Clover	1.25	2.00	4.50	8.00
Alfalfa Clover	.65	1.10	2.70	5.00
Crimson Clover	.55	.90	2.00	3.50
Jap. Buckwheat	.20	.35	.90	1.25

Prices subject to market changes.

Add 25 cents to your order, for cartage, if wanted by freight. Your orders are solicited.

GEORGE W. YORK & Co.,
CHICAGO, ILLS.

Sweet Clover ¹/₂ Canada.

At the following prices:

5 lbs.	10 lbs.	25 lbs.	50 lbs.
\$1.00	\$1.60	\$3.75	\$7.25.

Also a quantity of Motherwort and Catnip seed. Prices on application.

EGGS for Hatching. Buff Leghorns, Indian Games, & Light Brahmans. Choice Birds. A breeder for 30 years. Prices on application

JOHN MCARTHUR,

881 Yonge Street, TORONTO, ONT.
15Atf *Mention the American Bee Journal.*

*** Extracted Honey ***



Finest Quality. Basswood and Clover.

2 60-lb. cans in case, 8c. per pound. 1 60-lb. can in case, 9c. per pound. A sample by mail, 10 cts. **POUDER'S Honey-Jars and Complete Line of Supplies.** Catalogue Free.

WALTER S. POUDER,

162 Mass. Avenue, INDIANAPOLIS, IND.

Mention the American Bee Journal.

HONEY We have No. 1 Alfalfa, also White and Sweet Clover Honey we will sell cheap.

Honey and Beeswax Wanted.

Boss bee-escape Warranted the best, simplest and quickest Escape on the market. Sent postpaid to any address for 30 cts. It can be returned at our expense if it is not as represented, or we will send the Escape on trial to any bee-keeper wishing to test it in good faith. We are agents for the Ferguson Patent Hive with double-case Super and Wicket-Gate Honey-Board, with the Escape. It is the easiest, quickest hive to handle for the production of comb or extracted honey.

E. S. LOVESY & Co.,

355 6th East St., SALT LAKE CITY, UTAH.
Mention the American Bee Journal. 9Atf

Van Deusen Foundation!

I have some of the celebrated Van Deusen Thin Foundation in 25-pound boxes, that I will put on board cars for \$12.50 per box.

Also ITALIAN

Queens! Queens!

Fine Untested Queens mailed PROMPTLY at 45 cts. each, or Six for \$2.40.

Safe delivery and satisfaction guaranteed. Address.

F. GRABBE,

LIBERTYVILLE, Lake Co., ILL.

26Atf *Mention the American Bee Journal*

READERS Of this Journal who write to any of our advertisers, either in ordering, or asking about the Goods offered, will please state that they saw the Advertisement in this paper.

in the evening, he goes all over the place to say "How d'ye do?" to all his pets; and if darkness comes on, he takes a lantern. A friend remarked, that if Mr. Stow was away, his old, easy shoes took the rounds, "allee samee."

This family have solved the problem, how to be happy. They are all as busy as bees in a hive, at some useful employment. They have taken the New Testament, of our Lord and Savior, as their rule and guide, and do all the good they can, to as many people as they can, as often as they can.

Peoria, Ill. MRS. L. HARRISON.

[Yes, Mrs. Harrison, we should like to have all see the family and home of those who be-Stow such genuine kindness on every body and every thing they possibly can. But we don't know about doing anything more "on the quiet," for we haven't been assured that we are entirely "out of the woods" on the last "quiet" work we did. Still, we are not worrying much about it.—EDITOR.]

Management for Swarming.

It does me good to hear of Dr. Miller getting a crop of honey this year. He will probably remember me asking him if I could expect any surplus from sweet clover, where it grew thick along the roadsides for three or four miles. I can say that I have a nice lot from sweet clover, of as pretty honey as I ever saw, and it kept the bees swarming for over a month.

I will tell how I manage swarms when I run out of hives. As soon as the swarm is out I open the hive and take out all the frames that have sealed cells, and all the rest I bruise and put back. The frames that had cells sealed I put into nucleus hives, fill out the old hive with new frames, and return the bees, and they go right to work in the sections and fill them in a few days. None of them reswarmed. If you are troubled with swarming, try this method on a few and report. G. E. NELSON.

Bishop Hill, Ill., July 27.

Sweet-Corn Honey—A New Potato.

Did you ever get any honey from sweet-corn? We have a fine lot of it. We had about eight acres of sweet-corn, that came into bloom just as the linden failed. The bees worked on it for 10 days. Through mistake, an early corn was mixed with a late "Evergreen" in the same field, so the mixture held bloom a long time, the weather being propitious. Some of the strongest colonies filled a super, each 28 pounds. The comb and cappings are beautifully white, and the honey is—not amber, unless it is amber verging on pink or very light red. It is pleasant, smooth honey, with a slight maple flavor.

The linden did better than for many years, averaging about 20 pounds per colony, spring count.

In 1892 I visited friends in Warren county, Pa. In one garden I saw a compact row of potatoes, so thrifty looking, but with small tops. On inquiry I learned that they were from Scotland, grown that year for the first time in American soil. A touch of sentiment had caused them to be transplanted from the ancestral home of the Eddys, so we call them the "Eddy potato." I

received four by mail the fall of 1892, and I have raised them ever since with increasing favor. We planted them this year on April 20; they were in bloom May 30, and on June 11 we had new potatoes as large as pullet's eggs. On July 1 they were ripe. They are smooth, white-meated, and in every way desirable.

If any of the American Bee Journal readers would like to try a few in their garden next spring, I will send them by mail for the postage and cost of cloth for little bags— $\frac{1}{2}$ pound would be 4 cents postage; a pound 8 cents. The cloth for new, strong bags would be about one cent for $\frac{1}{2}$ -pound, so that would make half a pound of seed for a nickel, or 10 cents a pound. I sent Dr. Miller a pound of them two years ago. I hope after two seasons' trial that he likes them as well as he did at first. I will mail "ye editor" a pound in a day or two, and hope he has soil enough somewhere to grow them.

MRS. B. J. LIVINGSTON.
Center Chalm, Minn., Aug. 13.

[No, we have never heard of bees getting surplus honey from sweet-corn, or any other kind of corn, but supposed they got mostly pollen from that source. But your bees seem "to know a good thing when they see it."

Thanks for the potatoes, Mrs. L. They are very nice. As we have no convenient place to grow them, we will hand them to some neighbors who will be glad to test them.—EDITOR.]

Too Much Rain.

We have been having the most rain in my locality that has ever been known. It has rained more or less for the past four weeks. Bees have gathered no honey during this time, and in these four weeks catnip, sweet clover, and some other honey-plants, were in their height of bloom, but I am still hoping to get a good fall flow, if it only stops raining. The large amount of moisture has started all kinds of flowers to bloom. Smartweed is just opening up; big or mammoth clover is blooming nicely, and, O, yes, white clover, that I thought would be no more, is poking its head up all over and everywhere by the thousand. There was no white clover in my locality in the spring, and now it looks as if we are to have a white clover honey-flow in the fall. Have you ever heard anything of the kind before? I have not. "It's an ill-wind that blows no one any good." The farmers have been injured quite seriously by the recent floods, most of them having all their grain out in shock. We had such an inundation one day that shocks stood in water up to the bands.

H. G. QUIRIN.

Bellevue, Ohio, Aug. 14.

A Great Swarming Season.

For the last few years it has been out of the question to keep up my bee-yard by natural swarming, for the lack of honey in the field caused a lack of honey in the hive: but this year is just the reverse, and we have more bees than we know what to do with. The last three days I have had three swarms come off, and as the "swarm in July is not worth a fly," what are these August swarms

PROF. A. J. COOK'S BOOK FREE!

The Bee-Keeper's Guide

OR

MANUAL OF THE APIARY.

This 15th and latest edition of Prof. Cook's magnificent book of 460 pages, in neat and substantial cloth binding, we propose to give away to our present subscribers, for the work of getting new subscribers for the American Bee Journal.

A description of the book here is quite unnecessary—it is simply the most complete scientific and practical bee-book published today. Fully illustrated, and all written in the most fascinating style. The author is also too well-known to the whole bee-world to require any introduction. No bee-keeper is fully equipped, or his library complete, without "THE BEE-KEEPER'S GUIDE."

Given For 2 New Subscribers.

The following offer is made to PRESENT subscribers only, and no premium is also given to the two new subscribers—simply the Bee Journal for one year:

Send us Two New Subscribers to the Bee Journal (with \$2.00), and we will mail you a copy of Prof. Cook's book FREE as a premium. Prof. Cook's book alone sent for \$1.25, or we club it with the Bee Journal for a year—both together for only \$1.75. But surely anybody can get only 2 new subscribers to the Bee Journal for a year, and thus get the book as a premium. Let everybody try for it. Will you have one?

GEORGE W. YORK & CO., 118 Mich. St., CHICAGO, ILL.

worth? But my opinion is they will fill the hive if we have no unusually early frost.

Who can give a better record of one colony than this? On May 27, No. 40, in a 9-frame hive, cast a swarm; No. 20, an 8-frame hive, received it; July 17 No. 20 cast a swarm, and No. 34 received them; July 23 No. 20 cast a second swarm, and hive No. 3 received them; August 13 No. 40 cast a large swarm, and No. 52 received them; August 14 No. 34 cast a large swarm that had to go into a box, as everything was full, and I should not be astonished if the whole yard takes the fever the first fine day. All except No. 40 are in 8-frame hives. I have taken off about 50 pounds of honey from No. 40, the remaining nine having nothing finished yet. I think it will be safe to say they will complete 50 pounds more. If any of the readers of this, or any other journal, can tell a bigger bee-story, I shall read it with pleasure. E. B. ELLIS.
Cooksville, Ill., Aug. 14.

Page & Lyon Mfg. Co.,

NEW LONDON, Wis., operates two saw-mills that cut, annually, eight million feet of lumber, thus securing the best lumber at the lowest price for the manufacture of bee-keepers' supplies. They have also just completed one of

The Largest Factories,

and have the latest and most improved machinery for the manufacture of Bee-Hives, Sections, etc., that there is in the State. The material is cut from patterns, by machinery, and is absolutely accurate. For Sections, the clearest and

The Whitest Basswood

is used, and they are polished on both sides. Nearness to pine and basswood forests, and possession of mills and factory equipped with best machinery, all combine to enable this firm to furnish the best goods at

The Lowest Prices. ♡

For instance, it has a job lot of 200,000 No. 2 Sections that will be sold at 50 cts. per 1,000; or 2,000 Snow-White Sections will be sold for \$4.00, and larger quantities at still lower prices. Send for Circular and see the prices on a full line of supplies. 16Atf

READERS

Of this Journal write to any of our advertisers, either in ordering, or asking about the Goods offered, will please state that they saw the Advertisement in this paper.

✦ MONEY SAVED IS MONEY GAINED. ✦

THE ROYAL UNION Life Insurance Company

DES MOINES, IOWA.

The Iowa Policy

Is one that definitely promises to keep an accurate account with you; credit your premiums and interest, charge the actual expense and mortality cost, and hold the remaining funds subject to your order.

Agents Wanted.

JOHN B. KING, GENERAL AGENT,
Suite 513 First Nat'l Bank Bld'g,
20Atf CHICAGO, ILL.

Mention the American Bee Journal

IF YOU WANT THE

BEE-BOOK

That covers the whole Apicultural Field more completely than any other published, send \$1.25 to Prof. A. J. Cook, Claremont, Calif., for his

Bee-Keeper's Guide.

Liberal Discounts to the Trade.

BEGINNERS.

Beginners should have a copy of the Amateur Bee-Keeper, a 70-page book by Prof. J. W. Rouse. Price 25 cents; if sent by mail, 28c. The little book and the Progressive Bee-Keeper (a live, progressive 28-page monthly journal) one year, 65c. Address any first-class dealer, or

LEAHY MFG. CO., Higginsville, Mo.

California

If you care to know of its Fruits, Flowers Climate or Resources, send for a Sample Copy of California's Favorite Paper—

The Pacific Rural Press

The leading Horticultural and Agricultural paper of the Pacific Coast. Published weekly, handsomely illustrated, \$2.00 per annum. Sample Copy Free.

PACIFIC RURAL PRESS,
220 Market St., - SAN FRANCISCO, CAL.

MUTH'S HONEY EXTRACTOR

PERFECTION
Cold-Blast Smokers,

Square Glass Honey Jars, Etc.
For Circulars, apply to CHAS. F. MUTH & SON,
Cor. Freeman & Central Aves., Cincinnati, O.
Send 10c for Practical Hints to Bee-Keepers.

HONEY and BEESWAX

MARKET QUOTATIONS.

The following rules for grading honey were adopted by the North American Bee-Keepers' Association, and, so far as possible, quotations are made according to these rules:

FANCY.—All sections to be well filled; combs straight, of even thickness, and firmly attached to all four sides; both wood and comb unsoiled by travel-stain, or otherwise; all the cells sealed except the row of cells next the wood.

No. 1.—All sections well filled, but combs uneven or crooked, detached at the bottom, or with but few cells unsealed; both wood and comb unsoiled by travel-stain or otherwise.

In addition to this the honey is to be classified according to color, using the terms white, amber and dark. That is, there will be "fancy white," "No. 1 dark," etc.

Chicago, Ills., Aug. 1.—We quote: Fancy: white clover, 15c.; No. 1 white, 12@13c.; fancy amber, 10@11c.; No. 1 amber, 7@9c.; fancy dark, 9@10c.; No. 1 dark, 7c. Extracted, white, 5@7c.; amber, 5@5½c.; dark, 4½@5c. Beeswax, 25@27c.

The month closes with some offerings of new comb honey, for which 14-15c. is asked for best lots—but there are no sales of consequence to report. There is usually a good deal of it moved in August, thus establishing the early market.

Philadelphia, Pa., Aug. 14.—Extracted, white, 8-10c.; amber, 4-5c.; dark, 3-4c. Beeswax, 25c.

No new comb in this market yet. Old comb cleaned out.

Buffalo, N. Y., July 24.—Fancy comb, 1-pound, 12-14c.; No. 2, 9-10c.; No. 3, 4-8c. Extracted, 3-5c., as to quality. It is folly to ship honey unless properly packed. Good results depend on it and quality.

Cincinnati, Ohio, July 10.—No. 1 white, 13@14c.; fancy amber, 12@13c.; No. 1 amber, 10@12c. White, extracted, 5@7c.; amber, 5@6c.; dark, 3½-5c. Beeswax, 20-25c.

Albany, N. Y., Aug. 1.—Fancy white, 13-14c.; No. 1, 12-13c.; No. 1 amber, 11-12c. We have received a number of consignments of new comb honey, mostly white, and a great many letters from producers, asking if they should forward their honey as soon as it was ready. There is but very little demand for honey during hot weather and it creates an unfavorable impression on the trade to see a large stock of honey standing around. September 1 is time enough to forward comb honey. We look for a large crop of white honey and prices lower than last season.

Indianapolis, Ind., July 28.—Fancy white, 15-16c.; No. 1 white, 13-14c. Extracted, white, 6-7c. Beeswax, 25-27c.

No demand at all for off grades of either comb or extracted honey. Large fruit crop and warm weather are opponents to the demand for honey at present.

New York, N. Y., Aug. 8.—No. 1 white, 12@13c.; fancy amber, 11@12c.; No. 1, 10@11c. Extracted, white, 5½@5¾c.; amber, 5c.; dark, 50c. per gallon. Beeswax, 25c.

Our market has not opened up as yet and we would not advise shipping comb honey before Sept. 1, or latter part of this month. Extracted is selling fairly well at prices quoted. Beeswax very dull and declining.

St. Louis, Mo., Aug. 8.—Fancy white, 13@14c.; No. 1 white, 12@13c.; fancy amber, 11@11½c.; No. 1 amber, 10@10½c.; fancy dark, 8@9c.; No. 1 dark, 7@7½c. Extracted, white, in cans, 5c.; in barrels, 4@4½c.; amber, 3@3½c.; dark, 2½@3c. Beeswax, 19@20c.

Very little honey coming in at present, and the weather is too warm to handle to advantage if it were here.

San Francisco, Calif., Aug. 12.—White comb, 11-12½c.; amber, 7½-10c. Extracted, white, 5-5½c.; light amber, 4½-4¾c.; amber colored and candied, 3¾-4c.; dark tulle, 2¾-3c.

Not much honey on market, either new or old. The crop on this coast is exceedingly light, and a large portion of it has already passed into second hands. Market is firm at the quotations, but business is confined wholly to small transfers on local account.

Beeswax, fair to choice, 22-25c. Stocks are light. While demand is not active, desirable qualities can be readily placed at current rates.

Milwaukee, Wis., Aug. 8.—Fancy white, 14-15c.; No. 1, 12-13c.; No. 1 amber, 8-10c. Extracted, white, 6-7c.; amber, 5-6c.; dark, 4-5c. Beeswax, 22-24c.

New crop of honey begins to come forward. The demand is very poor and quotations almost nominal. Weather is very warm and the consumption of honey is very small. Plenty of fruit, and hence the appetite is satisfied with same in preference. Later on we expect an improved demand for honey of all kinds.

Minneapolis, Minn., Aug. 8.—Fancy white, 12½c.; No. 1 white, 10@11c.; fancy amber, 9@10c.; No. 1 amber, 8@9c.; fancy dark, 7@8c.; No. 1 dark, 6-8c. Extracted, white, 5½@6½c.; amber, 5@5½c.; dark, 4@5c. Beeswax, 23@26c.

The demand for both comb and extracted is very quiet, and for the latter, nominal. The hot weather of the past week or so has checked demand for comb honey.

Cleveland, Ohio, Aug. 8.—Fancy white, 14½@15c.; No. 1 white, 12½@13c. Extracted, white, 6@7c.; amber, 4½@5½c. Beeswax, 22@25c.

There is not very much honey in our market. Selling rather slow. Demand beginning to be a little better. Think trade will be fair in this line this fall.

Kansas City, Mo., Aug. 8.—Fancy white comb, 15c.; No. 1 white, 13@14c.; fancy amber, 12-13c.; No. 1 amber, 11-12c.; fancy dark, 10-11c.; No. 1, 8-10c. Extracted, white, 6-6½c.; amber, 5 5/8c.; dark, 4-4½c. Beeswax, 22-25c.

Boston, Mass., Aug. 10.—Fancy white, 14-15c.; No. 1, 12-13c.; fancy amber, 9-10c. Extracted, white, 6-7c.; amber, 5-6c. Beeswax, 25c.

Good supply of new honey, but demand is light this very hot weather.

Detroit, Mich., Aug. 8.—No. 1 white, 12-12½c.; fancy amber, 10-11c.; No. 1 amber, 9-10c.; fancy dark, 8-9c. Extracted, white, 5½-6c.; amber, 5-5½c.; dark, 4-5c. Beeswax, 24-25c.

List of Honey and Beeswax Dealers.

Most of whom Quote in this Journal.

Chicago, Ills.

R. A. BURNETT & Co., 163 South Water Street.

New York, N. Y.

HILDRETH BROS. & SEIGELKEN,
120 & 122 West Broadway
CHAS. ISRAEL & BROS., 486 Canal St.

Kansas City, Mo.

O. C. CLEMOMS & Co., 423 Walnut St.

Buffalo, N. Y.

BATTERSON & Co., 167 & 169 Scott St.

Hamilton, Ills.

CHAS. DADANT & SON.

Philadelphia, Pa.

WM. A. SELSER, 10 Vine St.

Cleveland, Ohio.

WILLIAMS BROS., 80 & 82 Broadway.

St. Louis, Mo.

WESTCOTT COM. CO., 213 Market St.

Minneapolis, Minn.

S. H. HALL & Co.

Milwaukee, Wis.

A. V. BISHOP & Co.

Boston, Mass.

E. E. BLAKE & Co., 57 Chatham Street

Detroit, Mich.

M. H. HUNT, Bell Branch, Wayne Co., Mich

Indianapolis, Ind.

WALTER S. POWDER, 162 Massachusetts Ave.

Albany, N. Y.

CHAS. MCCULLOUGH & Co., 380 Broadway.

Cincinnati, Ohio.

C. F. MUTH & SON, cor. Freeman & Central ave.

Bee-keeper's Guide—see page 557.

Convention Notices.

TENNESSEE.—The next annual meeting of the East Tennessee Bee-Keepers' Association will be held at Sneedville, Tenn., on September 18, 1896. All persons interested in bee-culture are cordially invited to attend.
Luther, Tenn. JOHN M. SMITH, Asst. Sec.

TEXAS.—The third annual convention of the Southwest Texas Bee-Keepers' Association will be held at Beeville, Tex., on Sept. 16 and 17, 1896. All are invited. No hotel bills to pay. Low rates on railroads.
Beeville, Tex. J. O. GRIMSLEY, Sec.

MINNESOTA.—The annual meeting of the Southern Minnesota Bee-Keepers' Association will be held in Winona, on September 24 and 25, 1896, at 9 o'clock, a.m. All that feel in any way interested in bees or honey are cordially invited to attend.
Winona, Minn. E. C. CORNWELL, Sec.

WISCONSIN.—The annual meeting of the Southwestern Wisconsin Bee-Keepers' Association will be held at Wauzeka, Wis., Oct. 7 and 8, 1896. All that are interested in apiculture are invited to attend, and especially those that want a foul brood law to protect their bees from this dread disease. Our committee is working hard to get every bee-keeper interested, and we should all feel it is for our interest to help get a State law to protect our bees. Many of our prominent bee-keepers of the State have promised to be at our meeting, and no one can afford to miss it.
Boscobel, Wis. M. M. RICE, Sec.

North American Bee-Keepers' Association

OFFICERS FOR 1896.

PRESIDENT—A. J. Root..... Medina, Ohio.
VICE-PRES.—Wm. McEvoy.... Woodburn, Ont.
SEC.—Dr. A. B. Mason.... Sta. B, Toledo, Ohio
TREAS.—W. Z. Hutchinson..... Flint, Mich
Convention at Lincoln, Nebr., Oct. 7 & 8.

National Bee-Keepers' Union.

PRESIDENT—Hon. R. L. Taylor, Laneer, Mich
GEN'L MGR.—T. G. Newman, San Diego, Cal.

Queens and Queen-Rearing.

If you want to know how to have queens fertilized in upper stories while the old queen is still laying below; how you may safely introduce any queen, at any time of the year when bees can fly; all about the different races of bees; all about shipping queens, queen-cages, candy for queen-cages, etc.; all about forming nuclei, multiplying or uniting bees, or weak colonies, etc.; or, in fact, everything about the queen-business which you may want to know—send for Doolittle's "Scientific Queen-Rearing"—a book of over 170 pages, which is as interesting as a story. Here are some good offers of this book:

Bound in cloth, postpaid, \$1.00; or clubbed with the BEE JOURNAL for one year—both for only \$1.75; or given free as a premium for sending us three new subscribers to the BEE JOURNAL for a year at \$1.00 each.



Bee Supplies

Largest Stock and Greatest Variety in the West. BEST Good at LOWEST prices. Cat. of 80 pages FREE.

E. KRETCHMER, RED OAK, IOWA.

Mention the American Bee Journal. 23D9t

10 per ct. Off to Reduce Stock

on all kinds of SUPPLIES, except

—COMB FOUNDATION—

which will be sold in lots of 10 lbs. or more as follows: Medium, 35 cts.; Light, 36 cts.; Thin Surplus, 40 cts.; Extra Thin, 45 cts.

Queens—Warranted, 50c.; Tested, 75c.

W. J. FINCH, Jr., SPRINGFIELD ILLS.

Mention the American Bee Journal.

THE GREAT CAMPAIGN

—OR—

Political Struggles of Parties, Leaders and Issues

COMPRISING

Biographies of the Republican, Democratic, Populistic, Prohibition and National Nominees for President and Vice-President of the United States.

—ALSO—

The Platforms, Principles and Leaders of All Parties

DISCUSSING

ALL VITAL QUESTIONS OF THE DAY

HAVING AS ITS OBJECT

The Enlightenment and Education of American

—VOTERS—

Upon the Living Issues of the Hour.

The Gold Standard of Currency, Bi-Metalism, Free Coinage of Silver, High Protective Tariff, Tariff for Revenue Only, Prohibition, Licensed Liquor Traffic, the Doctrine of Reciprocity, the Monroe Doctrine, Laws Governing Our Relations with Other Nations, the Venezuelan, Armenian and Cuban Questions. Containing also Lives and Portraits of former Presidents, with a Review of their Administrations and the Political Lessons gleaned from them; together with a Portrait Gallery of Statesmen and Political Celebrities comprising 100 accurate Phototypes and other Portraits, embracing the most active and prominent statesmen in our Nation. The whole forms a Voter's Hand-Book of Political Information, thoroughly practical, enjoyable and instructive, enabling him to vote intelligently upon those vital subjects which constitute the living issues of the present great campaign.

This book embodies the views and opinions of the great leaders from the various party points of view, clearly explaining all the momentous questions now before the people. It is planned upon the broad principles of non-partisan national patriotism, and attacks no man's creed, and upholds the ban-



McKinley.



Bryan.

ner of no party; but placing every party and its principles, with its leaders upon its own platform, and bringing the several parties, platforms and champions in their true light before the mind of the reader, the intelligent citizen will, in this book, be enabled to view and compare them side by side and judge of their respective claims upon his vote as an

American citizen. It is a vast storehouse of truth, plain, simple and unvarnished, which makes this work an unequalled source of information upon the great issues of this campaign, suited to the wants of every voter irrespective of party and without partisan bias.

Our Country calls for thirteen million volunteers. "I do love my country's good with a respect more tender, more holy

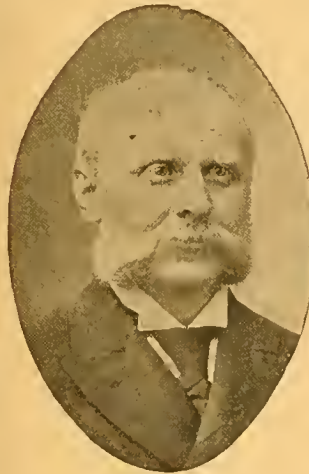

Levering.



Bentley.

and profound than mine own life," is the language which Shakespeare puts into the mouth of an ideal patriot. May this sentiment find a universal echo in the hearts of the voters of the United States of America who go to the polls in November, 1896.

Great questions are to be settled; a mighty battle is to be fought; a battle of ballots such as this country has never witnessed, which, in its far-reaching effects, will accomplish on the field of American suffrage, at the Ballot Box, next November, results as potential for good or evil to our Nation, revolutions as radical, and effects as lasting upon our institutions, as were ever wrought upon the field where sword and bullet, grape and canister settled the issue of the hour.

An impartial view of the situation reveals the fact that our Country never needed more broad-minded wisdom and unselfish patriotism in all her history than she requires to guide her through the present crisis.

Since the rising war cloud of 1859-60 which deluged our Country in the blood of brothers, our Nation has not been so agitated, divided and excited as it is to-day from ocean to ocean—North, South, East and West, on the great financial question, which is a vital issue of this campaign; and its settlement is fraught with threatenings and omens indicating political combinations, upheavals and surprises which our shrewdest politicians seem unmindful of or unwilling to recognize.

Since 1873 the mutterings of discontent have been growing louder between the advocates of Gold and Bi-metal standards. During the past three years, these mutterings have grown into clamorous shouts and peremptory demands on both sides. Statesmen never thought so diligently or more deeply on any subject; and the whole country never was so eager to have all sides of this momentous question presented in a clear, lucid and intelligible manner which the common reader can understand—the money question.

The Doctrine of Reciprocity is also treated at length from a broad, patriotic and non-partisan point of view.

This volume contains about 600 pages, is printed on super-calendered paper, and bound in beautifully lithographed board covers. The pictures of the four principal Presidential candidates shown herewith appear on the front outside cover, and the Vice-Presidential candidates on the back cover.

How to Get the Above Book.

Send \$1.00 and receive it postpaid. Or, send us two new subscribers for the Bee Journal at \$1.00 each, and we will mail you the book free as a premium. Or, for \$1.75, we will mail you the book and the Bee Journal for one year. Address,

GEORGE W. YORK & CO.,

118 Michigan Street,

CHICAGO, ILL.

Bottom Prices

**BRING US BIG TRADE.
GOOD GOODS KEEP IT.**

If you want the best supplies that can be made at a little less cost than you can buy the same goods for elsewhere, write to us for low prices. 1896 Catalogue now ready—ask for it and a free copy of **The American Bee-Keeper** (36 pages).

Address,
**THE W. T. FALCONER MFG. CO.,
JAMESTOWN, N. Y.**

Mention the American Bee Journal.

COMB FOUNDATION!

Wax always wanted for Cash or in Exchange for Fdn. or other Supplies. My trade is established on **Low Prices** and the merit of my **Foundation. Orders filled promptly.**

WORKING WAX INTO FDN. BY THE LB. A SPECIALTY. Wholesale prices to dealers and large consumers. Send for Prices and Samples to—**GUS DITTMER, AUGUSTA, WIS.** Reference—Augusta Bank. 1 Atf

Mention the American Bee Journal.

CHIPPEWA FALLS, Wis., July 8, 1896.
The 11 colonies having daughters from the Queen I got of you are grand. I have taken 100 pounds surplus, white clover comb honey from each of them, one having finished 135 pounds, and it is now working in three supers. I have 120 full colonies working for comb honey and only 3 out of this number are doing as well as daughters from your stock. For prolificness and honey-gathering qualities they cannot be excelled. For piling up the honey they "get there"
E. A. MORAN.



As Mr. Morgan is one of those who has kept bees for years and produced many large crops of honey, this unsolicited testimonial upset me; but Deelittle is still filling orders for Queens, as per page 512, Aug. 6th American Bee Journal.

Mention the American Bee Journal.

A Bargain—EARLY QUEENS.

119 Colonies Italian Bees in Chaff Hives: two acres land; good house; excellent well.
Early Queens—Tested. \$1.00; Untested, 50c. Sent by return mail.

**E. L. CARRINGTON,
16 Atf PETTUS, Bee Co., TEX.**
Reference—1st National Bank of Beeville.

Mention the American Bee Journal.

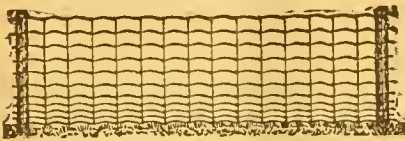

A PRACTICAL TEST.

At Adrian we have a park enclosed with over a mile of Page fence, on posts four rods apart. Inside are eight Buffalo, seventeen Elk and thirty Deer and Fawns. With public roads on three sides, there are thousands of visitors, accompanied by hundreds of dogs. Here is the record for over two years: no animal has gotten through, over or under, in or out, and not a cent for repairs.

PAGE WOVEN WIRE FENCE CO., Adrian, Mich.

Mention the American Bee Journal.

19th Year Dadant's Foundation 19th Year

Is still in the lead, for we use all the latest improvements, including the

NEW WEED PROCESS,

and still make the best goods. Remember that we do not use any acid to purify our beeswax, and that is why our Foundation preserves the smell of the honey and is more acceptable to the bees, than any other. It is kept for sale by

T. H. Strickler, Solomon City, Kansas.
G. K. Hubbard, Fort Wayne, Ind.
L. Hanssen, Davenport, Iowa.
C. Theilmann, Theilmanton, Minn.
E. C. Baglesfield, Berlin, Wis.
E. T. Abbott, St. Joseph, Mo.
J. M. Jenkins, Wetumpka, Alabama
John Rey, East Saginaw, Mich.
Vickery Bros., Evansville, Ind.

The Jennie Atchley Company, Beeville, Texas.
C. F. Muth & Son, Cincinnati, Ohio
E. Kretschmer, Red Oak, Iowa.
G. B. Lewis Co., Watertown, Wis.
James Reynolds Elevator Co., Poughkeepsie, N. Y.
Louisiana Bee-Keeper's Supply Manufactory, Donaldsonville, La.
Page & Lyon, New London, Wis.
John Nebel & Son, High Hill, Mo.

and many other Dealers. All agree in saying that no goods are better than ours.

We make a specialty of **Veils and Veil Stuffs** of best quality, cotton and silk

Langstroth on the Honey-Bee, Revised

Bee-Keeper's Supplies, Smokers, Sections, Tin Pails, etc.

Samples of Foundation and Tulle FREE with Circular. Instructions to beginners with Circular. Send us your address.

CHAS. DADANT & SON,

Mention the American Bee Journal.

HAMILTON, Hancock Co., ILL.

See Campaign Book Offer on page 559! Better Have It!

No. 1 4x4 1/2 **Snow-White Sections \$2.00 per 1,000.**



For the purpose of introducing our One-Piece Section to the bee-keepers generally, we have concluded to make the price \$2.00 per 1,000 for the season. Now is the time to get your Sections cheap. We have a choice lot of Section Lumber, gotten out of young timber, and we can furnish you the nicest Section to be had. Write for Sample Section Free.

32A4t
Mention the American Bee Journal.

The Marshfield Mfg. Co., MARSHFIELD, Wood Co., WIS.

Good Prices on Your Comb Honey!

Then you want our latest

NON-DRIP SHIPPING-CASES.

Our trade was never so large in these as now; and Commission Men tell us that Comb Honey in our Cases brings

BETTER PRICES

than some of the Cases made by competitors. The fact is, we know the demands of the trade, and are prepared to supply them. Remember, home-made or poorly made Cases are dear at any price. Honey in such Cases always brings several cents below the market price.

If you wish to get **GILT-EDGE PRICES** on **GILT-EDGE HONEY** put it up in



THE A. I. ROOT COMPANY,

Factory and Main Office, **MEDINA, O.**

BRANCH OFFICES:

118 Michigan St., Chicago, Ill.

1024 Miss. Str., St. Paul, Minn.

Syracuse, N. Y.

Mechanic Falls, Maine.

AMERICAN BEE JOURNAL

DEVOTED EXCLUSIVELY TO THE INTERESTS OF HONEY-PRODUCERS

ESTABLISHED 1861
THE OLDEST BEE-PAPER IN AMERICA

Published Weekly, at \$1.00 per annum.

Sample Copy sent on Application.

36th Year.

CHICAGO, ILL., SEPTEMBER 3, 1896.

No. 36.

BIOGRAPHICAL

MR. BARNETT TAYLOR.

Little did we think, when preparing the biographical sketch of the late lamented Allen Pringle, that so soon would we be called upon to do the same for another prominent worker in the ranks of bee-culture.

Just previous to learning the sad news of his death, we had heard that Mr. Taylor was convalescing; that he soon expected to be among his bees, and that shortly he would have some interesting things to write about for the bee-papers, as a result of this season's experiments which he had begun to make before his last sickness. So our great surprise can be imagined, when we received the brief letter from the son, telling us that his beloved father had departed this life.

We had the great pleasure of seeing Mr. Taylor at the World's Fair convention, though we presume few who attended that meeting were aware of his presence—he was so modest and retiring, so unassuming. But all of our readers knew full well his great ability as a practical bee-keeper, from his many helpful articles contributed to the leading bee-papers of America.

We believe among his claimed inventions were, a divisible brood-chamber hive; wire-end frames; slotted separators; a swarm catcher; and last, but far from least, his section comb-leveter, which was recently illustrated and mentioned with unstinted praise in these columns.

The whole of modern beedom will greatly miss the wise counsels and instruction that both Mr. Taylor and Mr. Pringle were ever ready and so able to impart. But their works will follow them, and as the years roll on, their names will shine out with no lustreless radiancy in the constellation of apicultural leaders and teachers of the nineteenth century.

In a biographical sketch of Mr. Taylor, published in the American Bee Journal for Jan. 5, 1893, we find that he was born in Green county, Pennsylvania, May 8, 1830. His father died when he was two years old, and he remained with his mother until his 16th year, when they moved to Quincy, Ill. There he lived nearly three years, one of which was spent in the army raised by Gov. Tom Ford to disperse the mob that killed Joe Smith in the spring of 1845, and drove the Mormons from their homes at Nauvoo in the fall of that year. Here it was he worked in a printing and book-binding

office. Afterwards he moved to Green county, Wisconsin, in the fall of 1848. At the age of 17 years he had mechanical skill enough to do the inside finishing for a Methodist church, which, when completed, gave entire satisfaction.

In the spring of 1849 he secured his first swarm of bees, which increased to many colonies in a few years.

Mr. Taylor remained in Wisconsin until 1856, when he moved to Forestville, Fillmore county, Minn. Immediately he purchased a colony of bees, which he increased to six the first season, and to 31 the second, and he sold \$175 worth of surplus honey. His bee-keeping up to this time had been with box-hives, in the old style. At this point he secured "Langstroth on the Honey-Bee," and also obtained the agency for Langstroth's movable-comb hive, and began bee-keeping in a more scientific manner.

He at once became dissatisfied with the guess-work of the spacing frames, and being of an inventive turn of mind, invented the wire-end frame as now used in his hive, which



Barnett Taylor.

he considered the most practical frame and hive in use since 1857.

During all these years he gave bee-keeping his best thoughts, and doing the (to him) delightful work with his own hands. He increased his colonies until he produced 26,000 pounds of fine comb honey in one season, and his intense interest in his apicultural work continued up to the time of his recent illness.

At the Taylor homestead there is to be found one of the

best equipped apiaries in the West. There may be larger apiaries, but perhaps none so complete. There is everything with which to do, and harmony and cleanliness go hand in hand. It is a most lovely spot, nestling at the foot of the hill on the Forestville road, and surrounded on three sides by fine, old trees, not forgetting the massive pines which fringe the road leading to the place. From the apiary can be seen the north branch of Root river, winding in and out, leaping onward over the stones and through the willows.

Here, endowed with Nature's best gifts to man—grass, wood and water—is situated the Taylor apiary. Scattered upon the hillside are to be seen hundreds of Mr. Taylor's hives. One can see the handsome machine shop complete with steam power and cunning machinery; the wintering cellar, built upon honor, thoroughly painted, and strong as a castle; also the curing house, and the much-talked-of apiary, all thoroughly painted and kept in excellent order. This order and harmony pervades everywhere and everything, even to his swarm-catcher.

His handiwork is to be seen in everything, including a bee-escape. We spoke of the cunning machinery. This was all invented and made by his own hands, and is so perfect in workmanship and finish as to cause remark by all who examine it.

Across from the apiary on the left are acres of as fine fruit as is grown in the great State of Minnesota. Apples there are many varieties, and the evergreens and flowers go to prove that Mr. Taylor was an enthusiastic horticulturist, as well as a scientific bee-keeper, and did much to advance the growing of fruit and the adorning of homes in his section with ornamental trees.

Mr. Taylor was one of the assistants to Hon. O. C. Gregg, in preparing the "Farmers' Institute Annual," issued once a year, and was the editor of the bee-department, as also the "Apiary" in *Farm, Stock and Home*, and for years contributed valuable information to several bee-periodicals.

In conclusion, Mr. Barnett Taylor was a good, plain, everyday man, honest from the ground up, and thoroughly trusted by all who knew him. He would scorn to do a wrong, and had a pure heart and clean hands, honored by all, and admired by many.



The Observing Bee-Hive as an Educator.

BY CHAS. DADANT & SON.

One of the best educators of beginners is the observing hive. Yet the many questions often asked by them through the bee-papers show that very few use the observing hive as a means of acquiring a fair knowledge of the habits of the bee. Books are good, but what you read is easily forgotten, and nothing will impress facts upon your mind as readily as witnessing them. Not only does the bee-keeper gain much from his observing hive, but he also interests his neighbors and all who visit him, for very few sciences are as old and as little known as bee-culture.

The rearing of a queen from a worker, her development, the different stages of the metamorphosis of bees, from the egg to the perfect-winged insect, the difference in drone and worker combs, the shape of the cells, the harvesting of pollen, the production of wax, the difference in appearance between

old and young bees, their behavior towards robbers—a thousand little things which are absolutely needed to be known if one desires to succeed—all this can be made clear, by the use of an observing hive.

Such a hive is inexpensive. One bottom-board 6 inches wide and of the length of the hives in your apiary; two upright pieces for the ends, 2 inches wide and of the same height as the brood-chamber of your hives, with a rabbet in each for the shoulder of the frame; one glass on each side, fastened by a light frame, two tight blinds made of light wood, and a narrow board for the top, and your hive is complete. Make a small auger-hole for the entrance. Then take a frame of brood and bees, young brood mixed with hatching brood, so you may have hatching bees and young larvae to rear a queen. Take this from your best colony, Italians if possible, as they are so much quieter than other races. A hive like this may be kept even in an apartment by a window all summer. The bees become used to seeing you, and never sting, if the proper precautions are taken to handle them with the greatest care at first. The blinds should be so arranged that they may be put on and removed without jar. Some people, instead of blinds, use only a black cloth thrown over the hive.

It is indispensable that there be but one frame in such a hive, for every part of the hive must be so placed as to be subject to our inspection, otherwise we may lose the sight of the most interesting of their performances when we most desire it. One has no idea of the pleasure that such a hive will give, when you can exhibit the bees rearing a queen, or the queen in the act of laying, or the respectful behavior of the little workers towards their mother. There is no end to the discoveries that are made, many of which you will think are original with you, and of which you will be very proud, as a new addition to the world's knowledge, until you find out that some one had already discovered it two hundred years ago. But, nevertheless, it is quite a good thing for you, for probably you would never have heard of it, had you not seen it yourself.

Outside of its advantage as a means of education, the observing hive may be made to pay its way, yes, twice over, if properly managed. Its actual cost, if you are, as usual, somewhat of a carpenter (all bee-keepers are carpenters, jacks of all trades), will be only a few cents, the glass being the most expensive part of it, but even if you have to have your hive made by a mechanic, it will not cost you to exceed a dollar. The frame of brood and bees taken in June from one of your good colonies will hardly be noticed. With this you may, if successful, rear three or four queens during the summer, and these can be used to make artificial swarms or replace missing queens in an apiary, or they may be sold and repay the cost of the hive several times over. At the end of the season, the comb and the bees may be united to a weak colony of bees, and help to strengthen it, and the observing hive laid away for another summer.

To those who keep bees in the city, this hive is a source of endless amusement. One cannot conceive the lack of knowledge on the subject of bee-culture among the masses till one shows the observing hive to all comers. The most startling question we ever heard was by an old maid: "Do all those little bees go to bed in those little holes every night?"

Hamilton, Ill.



Honey as Food and Medicine.—A new and revised edition of this 32-page pamphlet is now issued. It has 5 blank pages on which to write or paste recipes taken from other sources. It is just what its name indicates, and should be liberally distributed among the people everywhere to create a demand for honey. It contains a number of recipes on the use of honey as food and as medicine, besides much other interesting and valuable information. Prices, postpaid, are: Single copy, 5 cts.; 10 copies 30 cts.; 50 for \$1.00; 100 for \$1.75. Better give them a trial. Send all orders to the Bee Journal office.

Disposing of the Surplus Honey Crop.

BY HON. GEO. E. HILTON.

The time of year is now approaching for the bee-keeper to rejoice if he has been successful in securing a good crop of honey for the market, and if we have done our duty in an earnest effort to secure the crop and have experienced a failure, then we have nothing to reproach ourselves for. But judging from the amount of supplies sold, and the reports that I am getting from different parts of the State, especially the central and northern parts, the bee-keeper has no reason to complain, but on the other hand, will be well paid for his efforts, providing he uses the same tact in disposing of his crop that he has in securing it.

I have learned from experience that it is one thing to secure a crop of honey and quite another to dispose of it to the best advantage. And first I feel like insisting that every bee-keeper leave no stone unturned to dispose of his crop, or as much of it as possible, in his home market, even though the price may seem low compared with prices quoted in the city markets. I urge this for two reasons: First, you are educating your community to the uses of honey, and as the education spreads your sales of honey will increase. The more places your honey is kept on sale the more will be sold, especially if you put it in nice, clean, attractive packages. And I would recommend that you make, or buy, a medium-sized, upright show-case, and have your name and address plainly painted on each glass; place one of them in each grocery or butcher's shop that will handle your honey, then see to it that nothing but the best is put into this case. This will make a little expense, but they will more than pay the first season. I know for I have tried it.

Then tell the salesmen that you want to mark the price of your honey on each section. They will be pleased to have you do this, as it saves them that much trouble and musing. I have a scale called the "Family Favorite," that I can set a section of honey on, and it will indicate instantly how many ounces it weighs, and I mark as many cents on the section as it weighs ounces. This gives you a good round price for your honey, and your patron gets just what he pays for. If you do not do this, many salesmen will sell by the section, and the purchasers will select all the choicest, and the last purchaser must take the smaller packages, or they are palmed off on some poor unsuspecting child. I fear children are too often taken advantage of in this manner. May God help us to deal honestly with our fellowmen, especially the children.

By pursuing the plan I have recommended, you avoid the glut of the city markets, and the consequent low prices. Then it costs more time and money to prepare honey for the city market than it does for the home market, and you have the freight, cartage and commission to pay, the risk of breakage in transit, and also the risk of its falling into the hands of dishonest commission men, for I have learned that commission men are not more honest than the general run of men.

I will give you an illustration of the truth of what I have said: Last fall a friend of mine had about a ton of very good honey, and sent for me to buy it. I looked it over, and told him I would give him 10 cents per pound for the lot just as it came from the hives, I to furnish my own shipping-cases and crates, and do my own packing and shipping. He said he had been offered 17 cents in Chicago for it, and hoped to realize more than 10 cents net, and I told him I certainly hoped that he would.

So he bought the shipping-cases, spent several days in scraping and preparing for market, and shipped to Chicago. After waiting about three months, and failing to get replies to inquiries, he appealed to me again, and stated the case and asked my advice. I told my friend I would make an effort to get his pay. So I wrote the commission man, stating the facts, and told him unless he remitted to my friend at once,

or gave some satisfactory reason why he did not, I should feel it my duty to publish the facts in the leading bee-journals of the United States. Account sales were at once rendered, and my friend realized 8 cents a pound for his honey. Now, this does not prove that all commission men are dishonest, but I have learned that some of them are, and that a home market is much more safe than "the markets of the world" that we have had open to us the past three years.—Michigan Farmer.

Newaygo Co., Mich.



Fifteen Years' Experience in Bee-Keeping.

BY MRS. SALLIE E. SHERMAN.

(Continued from page 548.)

After getting and trying different kinds of bee-hats and veils, I finally settled upon, and still like best, a large-brimmed white-straw hat, lined with a light quality of straw-colored linen, with strings from the crown inside to fasten under the chin, and also an extra pair on the outer edge of the brim, so that I can also draw that down, too, when I so wish. The veil I want of the very finest black silk net, with a slight greenish cast, just long enough to come down well over the face. The rest of it I prefer made of something very thin and open, of a light color, with a string run in the hem so that it will work very easily. This can best be done by having the hem wide. When not in use I just throw the veil up over the hat out of the way. If any angry bees came buzzing around, I could instantly pull the veil down, and was thus secure from their attack.

In making cake, jelly, jam, preserves, and vinegar, I used honey instead of sugar for exhibition purposes at the fairs, thus advertising new uses for honey, and bringing it into more general use. I also distributed hundreds of the "Honey Almanacs" with my advertisement on them. In this way, and the free use of printer's ink, I worked up a good trade in honey, many times not being able to fill all the orders I got. I even received a letter from Paris, France, soliciting consignments of honey to that far-away, sunny clime. [The "Honey Almanac" referred to by Mrs. Sherman, is no longer printed.—EDITOR.]

Methinks I hear you ask if I ever had any experience in peddling. Well, yes, considerable. I tried never to go to town without something to sell. You see, town people have to eat as well as look pretty, dress finely, and show their accomplishments. We must cater to the eye as well as to the taste, so I have found that it paid well to fix up everything that was for sale in the most attractive style possible. I had nice labels printed and put upon the new tin buckets, varying in size from one pint to one, two and three gallons; Mason jars from one quart to half gallon; then a vessel for sampling. I also usually took nice golden butter molded in one-pound molds, beautifully stamped; each pound was wrapped separately in nice butter-paper; and a bottle of honey-vinegar as a sample from which to take orders. When I had comb honey of course I took it also.

Well, it was but a few houses that I would go to, if they had any money, that didn't want something that I had. Once I secured an order they didn't forget me, but as I would call again the children would go running into the houses to tell their mothers that the "honey-woman" or "sweet lady" was coming, and begin begging her to buy some more.

On one occasion, however, the lady said that she didn't want any honey, as her family cared very little for it. She made her own butter, and had a supply of vinegar on hand. It seemed to amuse her to think that I had so many things for sale. She inquired if I had anything else to sell. "Yes," said I, "lots of other things. Fancy chickens of some half dozen different breeds, and eggs from the same." She wanted to know if that was all? "Oh, no," said I; "we have some

nice cows, and over a thousand acres of land to sell." She and I both laughed heartily. She then said that would do, and apologized to me the next time she saw me, for what she called her rudeness. I told her that there was no apology due at all, for I enjoyed it no doubt more than she did. Variety, you know, is the spice of life, and I enjoyed the change from the usual routine of monotonous questions and answers.

I was troubled more last year by birds eating my bees than ever before. It was redbirds. They had their nests in the poultry yard and orchard, and appeared in the apiary a number of times through the day for a fresh supply of bees. They were the most voracious feeders, it seemed to me, that I ever saw, considering their size. One day I found a nest full of young birds, so I told a little negro boy that was doing my chores, that he might go at night and catch the mother-bird on the nest, and kill her, and then get the young ones. He was very anxious for night to come, so he could have some fun. When he started, I told him to be very careful, and not let her get away. "No," said he, "she will not get away 'ceptin' I die." In a few moments I heard the bird, and then Jim came. He at first denied seeing her, but I told him that that wouldn't do, for I heard the bird, and so of course knew that she was there. Then he owned up, and showed me where she bit him. He was badly whipped, for I could not again prevail on him to go to the nest that night. The next day, however, he went and brought the nest of young birds, which my little rat-terrier dog (Frisk) killed.

My husband taught me how to use a gun. Having a very fine laminated-steel double-barrel shot-gun, I had used it effectually all these years when occasion required. Just imagine, if you can, my chagrin and disappointment, after repeated trials to kill those annoying little redbirds, that I verily do believe ate up as many as a full colony of my bees. When the truth finally dawned upon me, I found that it was my eyes that caused the trouble. I had been taking digitalis for my heart-trouble, until I could not see rightly, hence the over or under shot.

I have had several chickens at different times that learned to know the difference between a worker-bee and a drone. They would soon learn to know at about what time to go to a hive for a feast. They would stand and catch them as they came out for their regular flight. If a worker got on and stung them, which they seldom did, they would run off a little from the hives, pick it off and drop it, and back to the hive they would go for more drones. I noticed this more last year than ever before. I suppose the reason of this was that I was sick, and not able to attend to my bees last spring, so, of course, there were more drones than usual.

I have many times kept a queen in a cage laid on top of frames in a hive that had a queen and was working all right, for from a few days to two weeks. I had a double purpose in this; sometimes I would get a queen, may be from a distance, and not have a colony prepared for her reception. Then, again, I wanted to learn all I could about bees, so kept her there for experimental purposes. I have kept them on the alighting-board in front of the entrance, or rather at the side instead of exactly in front, for several days. In both cases the bees fed and cared for her all right.

Mr. N. D. West's coil-wire cell-protectors are very valuable in keeping queen-cells. I found them indispensable after once giving them a trial.

Bee-stings for rheumatism—have I ever given it a trial? Yes. Last winter my wrists were very much swollen, and the most excruciating pain imaginable. It was said to be rheumatism. Well, I suffered until it just seemed to me that I could not bear it any longer. I thought of the bees, so I determined to give them a trial. At first I must acknowledge I was a little timid about getting them to sting me, but, nevertheless, I decided to give them a trial. I caught a bee, put

her on, but somehow failed on several trials. I, however, finally succeeded, and found that I was greatly relieved. After thus succeeding, and finding relief, it was very little trouble to get them to sting. If you could have seen me with lantern in hand at 2 a.m., with five bees on one wrist, and four on the other at the same time, I guess you would have thought that I was either a fit subject for the mad house, or that there certainly was some virtue in formic acid applied epidermically through the agency of the honey-bee. I have sat oftentimes with a bee, sometimes several at the same time, on my wrist with a good magnifying glass first over one and then another watching them pump the poison into my flesh. Poor little things, I have felt sorry for them, well knowing that in their giving me relief, they were sacrificing their own lives.

Phitalacta, taken internally eight drops at a time, three times each day for four months, however, is the remedy that finally cured me of rheumatism. This is a preparation made from polk-root.

In the long ago, about the beginning of the war, I was sick nigh unto death. The attending physician pronounced my ailment gravel. After vainly trying all the remedies at his command, yet without giving me relief, he thought of bees, and asked my father if he had any. To which (fortunately for me) he replied, "Yes." He told my parents to get 48 bees, and pour a pint of boiling water over them. Let it stand a few minutes, then give me one tablespoonful every 10 minutes until it was all gone. This remedy, though you may think it a strange one, gave me the first relief that I had had for many hours. The Doctor sat by my bedside all that long night through, with small hope of recovery. But for the bee-tea I certainly would not have survived, and now be penning these lines. Who, then, can blame me for being a bee-enthusiast? Not the bee-keepers, I am quite sure, for they, too, love and appreciate the bee and its products.

Salado, Bell Co., Tex.

[The End.]



A "Model Cellar" for Bees.

BY JACOB DICKMAN.

What are the proper conditions? It may not be amiss to give a description of my cellar, in which I have successfully wintered my bees since 1884, having never lost a colony during the 12 years.

The cellar is under the kitchen part of our dwelling-house. The soil is a very stiff blue-clay, which I believe is far superior to one built in yellow sand. There seems to be a dampness in a cellar located in yellow sand that is not to be found in one that is dug in clay. We find it so in this locality, at least.

A cellar in yellow sand is the place to set milk to raise the largest amount of cream and make good, solid butter, even while the thermometer registers in the nineties. However, it is almost useless to try to make butter in warm weather, in my cellar, but we find it just the place to winter bees. My cellar is 15x22 feet, enclosed by a wall 18 inches thick, with the bottom and part way up the sides well cemented with the best of Portland cement, with the hope that no drain would be needed. I wintered my bees the first winter very nicely with the thermometer varying very little from 33° Fahr. This is considered entirely too cold, yet there was no dampness, and the bees came through in very fine condition.

In less than a week from the time the bees were taken from the cellar, rains came, and water to the depth of nearly three feet soon gathered in the cellar, and I was obliged to put in a drain. I went down a foot below the cellar-wall and placed a tile on the inside of the cellar six inches from the wall, digging through the cement and burying the tile about 12 inches deep. This keeps the cellar perfectly dry.

The flue into which the pipe from the kitchen stove en-

ters, extends down to the cellar, and the usual sized hole for stove-pipe is left in the cellar also. The draft is so strong that I often close this hole, in order to have the kitchen stove draw better. The heat from the kitchen stove creates a tremendous draft, and the air in the cellar to-day is seemingly as pure as the outside atmosphere, though there are perhaps two gallons of dead bees on the floor. Before setting bees in the cellar, we always close both ventilators as tightly as possible, also the window is well filled in with hay on the outside, to exclude every particle of light; in fact, when the door is closed there is darkness, sure enough.

We have at this writing (Jan. 9) 60 colonies in the cellar. They were put in on Nov. 28, and we expect them to remain there until the latter part of March, or perhaps until the first days of April. The thermometer stands almost steadily at 45°, and varies but very little; if necessary we open the outside door during cool nights to keep the bees from getting too warm. I removed dead bees from the cellar floor six times during the winter.

WHEN TO PUT BEES OUT OF THE CELLAR.

One year I set my bees out of the cellar the first warm spell that came. They then had patches of brood-larvæ and eggs. Extremely bad weather set in and I again put them into the cellar. When good weather came again, I put them on the summer stands, and found upon examination that all brood-larvæ and eggs had been destroyed, not even the sign of a queen.

I therefore decided that had they been left in the cellar until settled warm weather these young bees would have been well cared for, and the hive filled with more brood, etc. I have since waited until I thought the weather was fairly settled, and when outside bees were gathering pollen, then some warm morning when the thermometer was at 65° or 70° I go quietly into the cellar and, with smoker, drive the bees into their hives and close the entrances; then we can let in the light and open the door and proceed to place them on the summer stands, paying no attention to how they were the previous fall. After all are put out we open the entrances, and they have a grand, glorious flight. Then I call my wife out and ask her to listen to that "heavenly music." Her reply usually is: "You better enjoy it as well as you can, as that is perhaps as near heaven as you will ever get."—Ohio Farmer.

Defiance Co., Ohio.



Notes from Virgil—Something Historical.

BY EMERSON T. ABBOTT.

(Continued from page 550.)

The following suggests some strong superstitions in connection with bees:

"From these examples some there are maintain,
That Bees derive from a Celestial strain,
And Heavenly Race;"

"Upon this Pythagorean opinion, thus Servius: 'This place (saith he) the Poet more fully prosecutes in the sixth Book of the Aeneids, which he here briefly toucheth at, to prove that Bees also have some part of the Divinity. For that creatures consist of the four Elements, and the Divine Spirit is manifest. This high conceit is confirmed by their Prophetic presages of extraordinary events, especially of Learning and Eloquence, as in Plato, Pindar, Lucas, and St. Ambrose, in whose mouths, when they were infants, they are said to have made honey.'"

The annotator's note shows that Virgil had learned to recognize some at least of the enemies of bees. He says:

"Virgil speaks of the enemies of bees. According to Aristotle, Pliny and Butler, the enemies of bees are, the Mouse, Woodpecker, Sparrow, Titmouse, Swallow, Hornet, wasp, Moth, Snail, Emmet, Spider, Toad and Frog."

"How much by Fortune they exhausted are."

"Aristotle likewise affirms that if too much Honey be left in the Hive, it makes the Bees idle; and on the contrary, if they have little, they will be the more diligent."

It seems that they had not had very much experience with bee-diseases, and they mistook some of the natural workings of the hive for disease.

"Their bodies languish in a sad Disease."

"Bees, by reason of their temperance, are never subject to sickness, the causes of their death being only Hunger and Cold; the Prognosticks of whose general decay and death are three: 1. their hollow hanging down, one at another's heels. 2. Their continual keeping in. 3. A general extraordinary and continued noise."—Butler.

One more note on the method of increase and the production of bees by a mechanical process, and I will close:

"Th' Arcadian's rare invention we must here
Remember, who with the Blood of a slain Steer
Oft Bees restored."

"Aristaeus, who, as Justine affirms, reigned in Arcadia, and first found out the use of Bees, Honey, Milk and Cheese. Hear Geopon upon this subject: 'Build a House ten Cubits high, and ten broad, with the other sides equal to one another; let there be one Dore, four Windows, on each side one. Bring an Oxe into it thirty months old, fleshy and fat. Set young fellows to kill him with Clubs, and break the bones in pieces; but let them be sure they make him not anywhere bloody, for a Bee is not bred of Blood; and let them not strike too hard at first. Let his Eyes, Ears, Nostrils, Mouth, and the other passages for evacuation, be presently stopped with clean, fine Linnen dipped in Pitch. Lay him on his Back over a great quantity of Thyme, and let the Dores and Windows be stopped with Clay, that the House be not perspirable with Wind or Air. Three weeks after open the Windows on every side, but that whereon the Wind blows. When it is sufficiently aired, close it up as before. Eleven daies after, when you open it, you shall find it full of Bees and Clusters, and nothing left of the Oxe except Horns, Bones and Hair. The Kings are bred (they say) of the Brains, the others of the flesh; and those that are of the Brain are fairest and strongest."

This is surely materialistic enough to satisfy the materialist of the rankest type. St. Joseph, Mo.

Questions AND Answers

CONDUCTED BY

DR. C. C. MILLER, MARENGO, ILL.

[Questions may be mailed to the Bee Journal, or to Dr. Miller direct.]

Why Did the Swarms Leave?

Why did my bees abscond? I have lost several swarms. They swarmed under the natural impulse, were hived in clean, new hives, and would stay a day or two, and even longer, then come out and simply go. They were Italian bees.

Essexville, Mich.

M. P.

ANSWER.—It's hard to account for all the vagaries of bees, for sometimes they do things without any reason apparent, but without any more particulars of the case the safest guess is to say they left on account of the heat. That's the cause of desertions, probably, in the very great majority of cases. Heat that a settled colony doesn't seem to pay much attention to, will promptly drive out a new swarm. The old colony says, "We've got all our worldly possessions right here, and we can't afford to leave them; we've just got

to grin and bear this hot spell. It hasn't generally been so hot as this, and probably this will not last." But in the empty hive it's different. The bare walls perhaps allow the heat to be more keenly felt, and the reasoning may be something like this: "Why, this is awful! We never had anything like this in our old home, and the sooner we get out of here the better. Better leave now, while we can carry all our stores with us than to wait until we have a lot of babies we don't like to desert." So off they go.

It is of importance that a newly-hived swarm be kept comfortable. Let there be plenty of room for ventilation below, and let the hive be partly uncovered for two or three days. Don't set the hive right out in the broiling sun with nothing to shade it. Many practice giving a frame of brood, the idea being that the bees will not be willing to desert this. Doolittle says that a frame of brood will hasten desertion, and I suspect there are differences in conditions that make a frame of brood desirable in some cases and not in others.

Won't Work in the Super.

Why don't my bees work in the super? Their hive is full. They seem to keep going lively. J. S. Beebe, Mich.

ANSWER.—Hard to tell without knowing more about the case. Sometimes honey comes in slowly, and the bees keep crowding the brood-nest rather than to take a fresh start anywhere else. It will help no little if you put in the super a section with drawn comb in it, or a piece of brood.

Rearing Queens—Bees in Winter.

There was considerable of interest to me in the question asked by W. S. G., and your answer to same, on page 518, regarding the fertilization of queens. Your answer was satisfactory to me as far as it goes, but the particular difficulty with me is to keep the queens separated during the time required to become fertilized.

1. Is it necessary to use a full colony of bees and divide them into as many nuclei as you wish to rear queens? I have 20 colonies, purchased last spring, with the exception of one, and have had all my bee-experience since that time. I have one colony of black bees, about five hybrids, and the rest Italians. I wish to Italianize these. I concluded to do this by rearing queen-cells in a nucleus, and inserting the cells in the hives I wish to Italianize, after taking out the queens. Would this be a good plan? I have made a nucleus for this purpose, of from a pint to a quart of bees; they are just one week old, but refuse to build cells. What can be the trouble? I am sure they have no queen.

2. Would cell-protectors be of any use in inserting cells, to keep them from being torn open?

3. There is a theory prevalent here that during an extremely cold winter bees lie in a more dormant state than during a mild winter, and consume much less honey, hence are more likely to starve in a mild winter than in a cold one. If there is any truth in this, why would bees not winter better in a single hive, on the summer stand, than in a double hive filled in with chaff, which latter method I had thought I would adopt?

The Bee Journal is very much appreciated in our home. Globe, Kans. J. M. S.

ANSWERS.—1. Your experience is somewhat like my own. In the early part of my bee-keeping I said it wasn't worth while to have a whole colony at work rearing queen-cells, for only a few bees could have anything to do with it. So I made a nucleus like yours, and in the course of time I got queens that were about like yours will be. No matter what you and I may reason about what the bees ought to do, the fact remains that you can't have good queens by having the cells reared in a hive with only a few bees. So don't think of such thing at all, but have your cells reared in a full colony. Not only a full colony, but a strong colony. After the cells are sealed, if the weather is warm, then the cells can be put in nuclei. The nucleus you formed was probably taken from colonies with laying queens, and all the bees went back to their old home except those so young they had never taken a flight. No honey was brought in, and the poor babies were probably too discouraged to do much in the way of rearing queen-cells. There are cases, however, in which bees seem stubborn about rearing cells, even when in good numbers.

2. Yes, the protector secures the cell against the freaks of bees, but if nuclei are formed from a queenless colony they

generally respect queen-cells given them. A much larger proportion of bees will stay put in a nucleus if the bees are taken from queenless colony than if taken from a colony having a queen.

3. If bees can fly out often through the winter they will consume more than if they staid contentedly in their hives, because every flight means an extra feed. But it doesn't follow from this that colder hives would be better for them, for it's the frequent flights that cause a greater consumption, and when the weather becomes warm enough to warm up a colony through thick walls, it would warm them up all the sooner through thin walls. Still, if I lived where bees could fly every week, I wouldn't care for thick walls.

Difference in Queen-Cells for Swarming and for Superseding.

What is the difference, if any, in the appearance of a queen-cell reared for swarming and one reared for superseding a queen? J. W.

ANSWER.—I don't know of any difference. Neither do I know of any way you can tell for certain by looking at the combs whether the cells are meant for superseding or for swarming. In either case they are started from the egg in the same kind of cell. Generally more cells will be started for swarming, whereas only one or two will be started for superseding, but there's no fixed rule about it. I don't believe the bees themselves can tell the difference, and sometimes cells that are started for swarming are used for superseding, and vice versa. Suppose they say, "Mother's getting old; guess we'd better supersede her," and cells are started for that purpose. Then a honey-flow starts in, and some adventurous worker says, "Say, girls, say we swarm," and off they go. On the other hand, if preparations for swarming are made rather late, and about the time the cells are sealed, the idea of swarming is abandoned, a young queen may be allowed to mature and take the place of the old one. Taking advantage of this, Doolittle says put a sealed cell in a hive at the close of the honey-harvest, and the queen will be superseded. But I've tried the same thing earlier in the season, and although the young queen might be at first tolerated in the hive she was always killed within a day or two.

Hives—Closed-End Frames—Placing Hives—Comb-Guides and Starters.

1. The standard hive calls for 20 inches long, and 8 frames, $1\frac{3}{8}$ inches from center to center, which takes 11 inches. What fills up the other 9 inches, or is the 20 inch hive necessary? I am a carpenter, and would like to make my own hives.

2. In using closed-end frames is it necessary to have any space between the end of the frame and the side of the hive?

3. Is there any objection to placing hives close together? If so, how close can they be placed without damage?

4. How is a comb-guide made? What is it made of?

5. Is a comb-guide used when starters are used?

6. Is the starter used all around the frame, or just at the top? How wide is it, and how is it fastened? W. L. S.

ANSWERS.—1. I suppose you refer to the dovetail hive, whose outside length is 20 inches. But its inside length is $18\frac{1}{4}$ inches, and its inside width $12\frac{3}{8}$ inches. The frames run the length of the hive, so in figuring how much space there is to be filled by the width of the frames, not 20 but $12\frac{3}{8}$ is to be considered. Eight frames spaced at $1\frac{1}{2}$ will occupy $11\frac{1}{4}$ inches—you must allow $\frac{1}{4}$ inch space for one side—and a thin dummy is put in to fill up the remaining space. If you use Hoffman frames you'll find that bee-glue will very soon make your frames spaced more than $1\frac{3}{8}$ inches from center to center.

2. Yes, in most cases the same space is used as without closed ends, but some have barely enough space to allow the frames to enter easily.

3. That depends somewhat on how they are placed. If you put them in a straight row at equal distances apart, and there are no surrounding objects by which the bees can mark their hives, you ought to put them at least five or six feet apart. But you can place a group of four hives and have them touching, and you may have as many of these groups as you please, if you allow five or six feet between the groups. In the group of four, two hives are set side by side, then two others set back to back to the first two.

4. Comb-guides are not as much in favor as formerly, and

I haven't seen one for some time. A sharp edge of wood worked on the under side of the top-bar, or a thin strip nailed on the under side, running lengthwise at the center is the usual thing for a comb-guide. You can make them if you want, but I wouldn't have one in the way. If foundation is not to be had, then they might be of some use.

5. I think not generally.

6. Like many others, I never use starters, but always full sheets in brood-frames, but those who use only starters have them only attached to the top-bar. Some fasten them with melted wax, and some by pressure. I think if I were using starters I would fasten them to the top-bar the same as I do full sheets. Have a saw-kerf on the under side of the top-bar $5/32$ of an inch wide and $1/4$ inch deep, and slide the starter into this kerf. If there is any danger of its dropping out before the bees fasten it, make it secure by dropping a few drops of melted wax so that the drops shall hold both the starter and the wood. [A good bee-book would be a grand thing for W. L. S. It would help him wonderfully. In fact, no one should think of beginning to keep bees without one or more of the best books on the subject.—EDITOR.]

PERSONAL MENTION.

MR. W. C. FRAZIER, of Atlantic, Iowa, writes: "You can count me in at the convention at Lincoln." All right, sir. We'll "count you in."

MR. N. E. FRANCE, of Platteville, Wis., the Committee on Foul Brood, appointed by the Wisconsin State Bee-Keepers' Association, received 80 replies to the notice published in the American Bee Journal some time ago, reporting 6,050 colonies of bees, and 350,000 pounds of honey; with foul brood in 9 counties. Mr. France says he has 80 promises of attendance at the meeting of the Southwestern Wisconsin Bee-Keepers' Association to be held at Wauzeka, Oct. 7 and 8.

MRS. SALLIE E. SHERMAN finishes in this number her series of practical articles on "Fifteen Years' Experience in Bee-Keeping." They certainly should be an encouragement to the "sistering" to "go and do likewise." Shouldn't wonder if it would be a good thing if Mrs. Sherman would issue those ten articles in pamphlet form, including also her poultry experience. Might be the very means of helping many a struggling woman from dependence into independence, and also good health besides.

MR. GEO. McCULLOUGH, of Iowa, wrote us as follows, Aug. 18:

"I greatly enjoy reading every number of the American Bee Journal. I have last year's volume neatly bound in one of your excellent Emerson binders, and this year's volume up to July 1 in another. The American Bee Journal, when bound, makes a very convenient volume for reference to any subject in bee-culture treated on, by turning to its magnificent index in the last pages of the last number in December."

MR. E. TIPPER, editor of the Australian Bee-Bulletin, of West Maitland, N. S. W., wrote a fraternal letter to the editor of Gleanings, on May 15, in which he says that the previous year had been a bad one for bees in that country, on account of drouths and cold, westerly winds, with resultant bush-fires. Besides the honey-crop failure, there have been such losses of bees that, should there be a good flow the present year, there will not be a third of the bees to gather it. A good white clover flow was expected, as the continued drouth was being broken by a mild rain at the time Mr. Tipper wrote. We trust our far-away Australian friends may soon be having another good honey season.

DR. MILLER, in reply to our criticism on page 537, writes thus clearly:

MR. EDITOR:—I thank you for supplying the needed information on page 537. Of course I meant "sections filled with honey," and it was very careless in me not to say so. The only wonder is that you should have so much discernment to know at first guess just what I meant. Without doubt others thought I meant sections of pie or something else.

Wonderful what an amount of carelessness there is in this respect. Now there's my good friend, Hon. Geo. E. Hilton—a man who stands high in the community where he

lives—and yet, in this same last number of the American Bee Journal, he is guilty of the same carelessness no less than four times in a single article. He talks about "finished sections" and "unfinished sections," and will be understood as referring to 640 acres of land when he really means sections filled with honey.

You say, Mr. Editor, that any one with money can get finished sections any time. I suppose you mean "section honey-boxes," but wouldn't it be better to say so? Then you wouldn't be misunderstood.

I can't quite come up to your wish to report 10,000 finished sections of honey, or rather, sections filled with honey, but at this date (Aug. 21) the number has reached 9,072, and not much more to be heard from.
C. C. MILLER.

P. S.—On the page opposite to the one on which you straighten me out, you say, "let the sections next to the glass front be fair samples of those further back." I presume you mean "sections filled with honey," and should think you would feel like telling the whole thing, and not leave your readers to infer so much.
C. C. M.

Doctor, let's change the subject. We really didn't say anything at all. But now we'd like to congratulate you on those 9,072 "finished sections."

MR. JOS. E. POND, of Massachusetts, has kindly sent us an excellent photograph of himself for our apiarian album. In the letter accompanying it, Mr. Pond says:

"We old fellows are fast going on to our last home, and our places are being filled by those who, while they cannot do more than we *tried* to do, may, with the better light they have, be able to do more than we have done... I send it to you not for any particular value it may have, but as an assurance that I am pleased with your work in the American Bee Journal, and to assure you further, that I am in sympathy therewith."

Thank you, Mr. Pond, both for the picture and for the assurances—all of which we duly appreciate.

SKYLARK AND SOMNAMBLIST ought to "amalgamate," if there's no real impediment further than appears on the surface. Do you ask why we think so? Well, the former has been *dreaming* that he lived in the year A. D. 3,000, and tells in Gleanings about wingless and stingless bees and queens—both wings and stings having been bred entirely off in the 1,100 years beyond this. Now if such a fantastic dreamer isn't a proper person to amalgamate with such a skillful sleep-walker as Sommy, we don't know anything about the eternal fitness of things. As there could be no objections on "international" grounds, we think perhaps the California folks would be willing that *this* amalgamation should proceed. But if there are any objections to it, speak out now, or "forever after hold your peace."

MR. HENRY ALLEY, of Massachusetts, who is one of our regular advertisers, and who for some years published the American Apiculturist, wrote us as follows on Aug. 17:

FRIEND YORK:—Do all bee-keepers take the American Bee Journal? It seems to me a great majority do, as nearly every one who orders queens and calls for a circular says: "I saw your advertisement in the American Bee Journal."

My bees have had about 10 days of honey-gathering, and all during the hot days. The heat was terrible hereabouts. The Boston Ice Co. lost 60 horses in 10 days, all owing to the heat.
HENRY ALLEY.

No, Mr. Alley, we regret to say that we fear not nearly all the bee-keepers take the American Bee Journal, but we sometimes think they all ought to take it. We believe they would be the gainers by so doing. It would seem that almost any live bee-keeper could save, or make, at least ten dollars a year by investing one dollar in any one of the best bee-papers.

A New Binder for holding a year's numbers of the American Bee Journal, we propose to mail, postpaid, to every subscriber who sends us 15 cents. It is called "The Wood Binder," is patented, and is an entirely new and very simple arrangement. Full printed directions accompany each Binder. Every reader should get it, and preserve the copies of the Bee Journal as fast as they are received. They are invaluable for reference, and at the low price of the Binder you can afford to get it yearly.

OLDEST BEE PAPER IN AMERICA ESTABLISHED IN 1861

THE AMERICAN BEE JOURNAL

GEORGE W. YORK, Editor.

PUBLISHED WEEKLY BY

GEORGE W. YORK & COMPANY,
118 Michigan St., CHICAGO, ILL.

\$1.00 a Year—Sample Copy Sent Free.

[Entered at the Post-Office at Chicago as Second-Class Mail-Matter.]

Vol. XXXVI. CHICAGO, ILL., SEPT. 3, 1896. No. 36.

EDITORIAL COMMENTS.

The Nom-de-Plume Business, we believe, is being a little overworked these days. We know we were recently somewhat indulgent "along that line," but we think we have now nearly reformed. Of course, few value what is written thus as much as when over the real name, particularly when it comes to a technical matter like bee-keeping. A *nom-de-plume* will do very well for story or novel writing, where a knowledge of the author's special abilities are not necessarily required to give proper value to his pen production, but in class literature the author's name often adds much weight to what he writes. For instance, Doolittle's articles on bee-keeping would probably be given but little attention if signed "Doonothing." But Doolittle's name, experience, and reputation, give added value to what he writes on the subject of apiculture.

Index Improvements.—Editor E. R. Root gives our annual index quite a high compliment in last Gleanings. After saying that "a correspondent suggests that there is room for improvement in the indexing of the American Bee Journal," Mr. Root adds:

"I have consulted the files of that periodical not a little, and rarely have trouble in finding what I want. If I could feel that our index was always as good, I should feel satisfied."

If those who think it is an easy job to get up an infallible index to over 800 pages of matter, could only have the chance to try their hand at it, they'd discover that it is no easy matter. This particular writer has indexed the American Bee Journal for years, and has always *tried* to do it carefully, but never expects to see it entirely free from errors. Of course the "trying" for perfection will be continued, but it is well nigh a hopeless task.

The Vote on Amalgamation.—We have received the following from the General Manager of the National Bee-Keepers' Union, concerning the proposed vote on amalgamation:

SAN DIEGO, Calif., Aug. 20, 1896.

MR. EDITOR:—I have submitted for decision by the Advisory Board of the National Bee-Keepers' Union, as to whether a vote on amalgamation shall now be called for, as advised in the bee-periodicals. The result is that but one of the Board is in favor of holding a special election for submitting the question. It will, therefore, have to lay over until the annual election in January next.

THOMAS G. NEWMAN,
General Manager.

Perhaps it is just as well to wait now until after the Lincoln convention of the North American, before voting on amalgamation, for at that meeting there may be some action

taken that will tend to harmonize those in favor of amalgamation and the anti-amalgamationists. We are not so very particular about the plan finally adopted to unite the two organizations, only that bee-keepers may *get together* into one strong body, so that their efforts shall be made more effective. "In union there is strength," but in division and separation there can only be weakness.

Sweet Clover.—In a recent number of this paper, Mr. J. L. Gandy, of Nebraska, made this remark about sweet clover:

"Since it has been demonstrated that sweet clover makes good hay and pasture, many of our farmers, instead of trying to exterminate it, as has hitherto been the custom, are encouraging its growth."

Editor Root offers the following emphatic comment upon the above, in Gleanings:

"This is a good point. Let us keep them circulating. I expect to say, and keep on saying, until I do not have to say it any more, that sweet clover is not a noxious weed, but is one of the best honey-plants in the world; that it yields nectar everywhere, and that its flow is prolonged, not days, but weeks and weeks; that if it grows anywhere it grows in waste places; is easily exterminated; that cattle learn to eat it in preference to many other kinds of green forage, and it makes a fairly good hay. I have said these same things before; but it seems it must be repeated in different ways in order to make people believe it."

This is a subject upon which we are in entire agreement with Mr. Root, for we reside right in the midst of a sweet clover region. Does it yield honey?—well, we should think so. It yields for a long time, and, to our taste, its honey is the finest of all.

Selling the Honey Crop.—During the next four months nearly the whole of the honey of 1896 will be sold. Already some thousands of pounds have been placed upon the Chicago market, and the new comb honey is fine. But thus early some large producers have made a mistake, which we fear will tend to lower the prices here, and keep them down for the rest of the selling season.

Last week we had occasion to go over on South Water street—where nearly all the large commission dealers do business—and we found that one firm, who are almost new in the honey-business, had received a number of thousands of pounds of nice, white comb honey which they were offering at 11 cents per pound. Just a few doors away, and at the same time, honey dealers who have been long in the business, and understand it, and who try to keep up the market prices, were holding the same grade of honey at 13 cents per pound. Now, why the two cents difference in price? Simply for this reason: The new firm were only anxious to get their commission on the sales, not caring a straw how much, or how little, the honey would net the producer.

What surprises us is, that large producers are so careless as to ship to such firms, for really they lose on their own crops, and also cause others to lose. Such actions certainly do not show good business sense, nor is it just to other honey-producers.

We should think that after the "Horri-ble" experiences of last year, our older readers would be smart enough to keep out of the claws of the vulture-like commission men, and ship only to those who are satisfied to deal honestly.

We want to repeat what we said last year—it is this: Bee-keepers are discouraging honest honey commission men by shipping their honey to new and untried firms who will sell the same honey to neighboring honest dealers at a less price than bee-keepers would think of selling the same honey to the aforesaid honest dealers. Do you see the point? Let us explain:

Suppose we were old and tried honey dealers here, and

were quoting in the bee-papers 13 cents per pound for fancy comb honey—the correct market price. Along come a new firm—who may appropriately be called Snide & Co.—who privately quote the same grade of honey at 15 cents per pound. A bee-keeper ships to them 10,000 pounds. The honey arrives, and Snide & Co. take it to their store. We happen along just after it is unloaded, and Mr. Snide offers to sell us the honey for 11 or 12 cents per pound. We buy it, of course, for it is one or two cents less per pound than the shipper would have thought of letting us have it for.

Well, what does the shipper get for his honey from Snide & Co.? He gets probably a net price of 9 or 10 cents per pound—perhaps in some cases not so much, and sometimes "gets left" entirely—is simply euchred out of the whole thing.

Who is to blame that the producer didn't realize more for his honey? Why, the bee-keeper himself. He lacked sense. He was foolish enough to think that a *new* firm could secure better prices than an *old* and established one that quotes actual market prices.

And thus are the toiling bee-keepers swindled by various firms, all of whom should be compelled to wear the name of "Snide & Co.," so that bee-keepers would know, after a few expensive experiences, that all firms by that name are really *snides*, and are to be avoided as one would shun the smallpox.

But will honey-producers ever be wise in these matters? Yes, some will, but many will plod on and fall into the same old snares, time after time. Yet there is little excuse now for any reader of a good bee-paper being "caught," for the best firms generally either quote the market prices in the papers, or their names are found therein, and all others should be avoided, unless you wish to take your chances, or are acquainted with them, and know that they will deal fairly. Of course, the honey-shipper who doesn't take and read any of the bee-papers ought to get swindled, and deserves no sympathy if he meets with a loss that might have been avoided had he been a subscriber to one or more of the best bee-papers.

The Honey Crop for 1896 is thus commented upon by Editor Root in Gleanings for Aug. 15:

So far as we can ascertain by correspondence, the honey-flow in the central and northern States has been good—much better than for several years back. In the East it is not as good, and in some sections it has been almost a failure. In California there has been little or no honey except in the San Joaquin valley. In a letter from B. F. Brooks, one of the leading commission men of that State, he says the California crop of honey is almost a failure. Arkansas reports an entire failure of honey. This is as definite as we can make out up to date, from a large number of letters as they have come into our office.

California Notes are contributed to the monthly Rural Californian, by Prof. Cook, and from those in the July number we take the following:

HOLDING TONS OF HONEY.—It is reported that Mr. J. F. McIntyre, of Ventura county, has 30 tons of first-class honey in a fire-proof building. Mr. McIntyre does not propose to sell his honey until he can secure 6 cents a pound. This is none too much, and we hope the time will soon come when every apiarist will receive no less for his extracted product.

HONEY-DEW FROM OAK TREES.—We have noticed the last few days that the bees seem very busy about the oak trees. They are undoubtedly in quest of honey-dew. The honey from this source is of poor quality, but will undoubtedly serve a good purpose in sustaining the bees through the season of drouth. In California, where bees can fly every week of the year, there is little danger of mortality through the fact of inferior honey.

CROSS BEES WHEN NOT BUSY.—Bees are much like people. It is hard for them to be good-natured when things do not go well. Thus, in this season of no honey-production we may look for cross bees unless they are handled with extraordinary care. When bees are very active, and the honey is

being produced rapidly, we can often handle ours with safety without either veil or smoke. It will not do, however, at such times as these, when bees are almost idle, to handle them without the greatest precaution. It is better at such times not to handle the bees at all. It not unfrequently occurs that working with the bees at such times as the present makes them intolerably cross, so that they are positively dangerous if they are at all near the house or roadside.

HONEY FROM PEPPER TREES.—The bees for the last two weeks have been busy on the pepper tree. As they are only working on pistillate flowers, they are, of course, not after pollen; they must be getting a little nectar. Yet, so far as I can see, they are storing very little if any honey. I do not find the least peppery taste. I am strongly of the opinion that the strong honey often complained of and accredited to pepper blossoms, comes from honey-dew.

THE BEE-KEEPERS' EXCHANGE NEEDED.—We see by the papers that a little first-class honey has been produced in Orange county and sold in Santa Ana for $3\frac{1}{2}$ cents per pound. We talk of the regulation of price by the law of supply and demand—it need hardly be said that this law is entirely inoperative in California in respect to honey. This season almost no honey will be produced, and yet we see no advance in price. Who will say that the Bee-Keepers' Exchange is not sorely needed?

Freight Rates on Extracted Honey.—Mr. W. S. Hart, of Hawk's Park, Fla., sent the following letter to Gleanings, on this subject:

Kindly announce that, through the efforts of Mr. W. J. Jarvis, of the Florida East Coast Line, the committee appointed at Atlanta, "to secure a reduction of freight rates on honey," have succeeded in securing a reduction of the rate on extracted honey to that of 6th class, which is the rate charged for syrup, over all lines in Florida. I feel quite confident that this reduction could have been secured over all the lines of the Eastern States had both the committee and bee-keepers generally brought more pressure to bear at the meeting in Washington, as suggested by me. As it is, it will be quite a boon to honey-producers of this State, and stand as one good result of the Atlanta Bee-Keepers' Congress.

W. S. HART, *Chairman of Com.*

In an editorial comment on the above, Mr. Root says:

As Mr. Hart intimates, I see no reason why the North American or the Union, when it shall be reorganized, may not be able, by continual hammering, to get as good legislation for the whole country. If there is any place where the trite but old adage applies, "If at first you don't succeed, try, try again," it is here. There is no reason in the world why honey should not be classed as syrup. Of late years it has been sold at nearly the same price—so near it that it ought to go at the same rate.

Yes, when we get bee-keepers united in *one* grand body, then, we believe, such reforms as the one mentioned by Mr. Hart, will not be so difficult to obtain throughout the whole country; but so long as we have no association that can number at least 500 members, we do not look for very much success in any effort, no matter how worthy it may be. *Bee-keepers must get together!*

Foreign Bee-Papers.—Several bee-papers printed in German, French, or Italian, have been coming to us for some time, but as we read only the English, of course such foreign papers are quite useless to us. Our price for the American Bee Journal to foreign countries (except Canada and Mexico) is \$1.50 a year, and all in such countries who desire our paper must send that amount *in advance* in every case, for, as a rule, such foreign subscriptions are stopped promptly at the end of the time paid for.

The Great Campaign Book offered on page 559, ought to be in the hands of every voter. It shows all sides of the political questions of the day. Better send for a copy of it. Orders filled by return mail.

BEE-BOOKS

SENT POSTPAID BY

George W. York & Co.,
Chicago, Ills.

Bees and Honey, or Management of an Apiary for Pleasure and Profit, by Thomas G. Newman.—This edition has been largely re-written, thoroughly revised, and is "fully up with the times" in all the improvements and inventions in this rapidly-developing pursuit, and presents the apiarist with everything that can aid in the successful management of an apiary, and at the same time produce the most honey in an attractive condition. It contains 250 pages, and 245 illustrations—is beautifully printed in the highest style of the art, and bound in cloth, gold-lettered. Price, \$1.00.

Langstroth on the Honey-Bee, revised by Dadant—This classic in bee-culture, has been entirely re-written, and is fully illustrated. It treats of everything relating to bees and bee-keeping. No apiarian library is complete without this standard work by Rev. L. L. Langstroth—the Father of American Bee-Culture. It has 520 pages; bound in cloth. Price, \$1.25.

Bee-Keepers' Guide, or Manual of the Apiary, by Prof. A. J. Cook, of the Michigan Agricultural College.—This book is not only instructive and helpful as a guide in bee-keeping, but is interesting and thoroughly practical and scientific. It contains a full delineation of the anatomy and physiology of bees. 400 pages; bound in cloth and fully illustrated. Price, postpaid, \$1.25.

Scientific Queen-Rearing, as Practically Applied, by G. M. Doolittle.—A method by which the very best of Queen-Bees are reared in perfect accord with Nature's way. 176 pages, bound in cloth, and illustrated. Price, \$1.00.

A B C of Bee-Culture, by A. I. Root.—A cyclopedia of 400 pages, describing everything pertaining to the care of the honey-bees. It contains 300 engravings. It was written especially for beginners. Bound in cloth. Price, \$1.25.

Advanced Bee-Culture, Its Methods and Management, by W. Z. Hutchinson.—The author of this work is too well known to need further description of his book. He is a practical and entertaining writer. You should read his book. 90 pages, bound in paper, and illustrated. Price, 50 cts.

Rational Bee-Keeping, by Dr. John Dzierzoz.—This is a translation of his latest German book on bee-culture. It has 350 pages; bound in cloth, \$1.25; in paper covers, \$1.00.

Bienen-Kultur, by Thomas G. Newman.—This is a German translation of the principal portion of the book called *BEES AND HONEY*. 10. page pamphlet. Price, 40 cents.

Convention Hand-Book, for Bee-Keepers.—Thomas G. Newman.—It contains the parliamentary law and rules of order for Bee-Conventions—also Constitution and By-Laws, with subjects for discussion, etc. Cloth, gold-lettered. Price, 25 cts.

Thirty Years Among the Bees, by Henry Alley.—Gives the results of over a quarter-century's experience in rearing queen-bees. Very latest work of the kind. Nearly 100 pages. Price, 50c.

Why Eat Honey?—This leaflet is intended for FREE distribution, to create a Local Market. 100 copies, by mail, 40 cts.; 500 for \$1.50; 1000, \$2.50. If 500 or more are ordered at one time, your name and address will be printed on them FREE.

How to Keep Honey and preserve its richness and flavor. Price same as Why Eat Honey.

Apiary Register, by Thos. G. Newman.—Devotes two pages to a colony. Leather binding. Price, for 50 colonies, \$1.00; for 100 colonies, \$1.25.

Preparation of Honey for the Market, including the production and care of comb and extracted honey. A chapter from *BEES AND HONEY*. Price, 10 cents.

Bee-Pasturage a Necessity.—This book suggests what and how to plant. It is a chapter from *BEES AND HONEY*. Price, 10 cents.

The Hive I Use, by G. M. Doolittle. It details his management of bees, and methods of producing comb honey. Price, 5 cents.

Dr. Howard's Book on Foul Brood.—Gives the McEvoy Treatment and reviews the experiments of others. Price, 25 cts.

Dictionary of Apiculture, by Prof. John Phil. Gives the correct meaning of nearly 500 apicultural terms. Price, 50 cts.

Winter Problem in Bee-Keeping, by G. R. Pierce. Result of 25 years' experience. 50 cts.

Handling Bees, by Chas. Dadant & Son.—A Chapter from Langstroth Revised. Price, 8 cts.

Bee-Keepers' Directory, by H. Alley.—Latest methods in Queen-Rearing, etc. Price, 50c.

Foul Brood Treatment, by Prof. F. R. Cheshire.—Its Cause and Prevention. Price, 10 cts.

Foul Brood, by A. R. Kohnke.—Origin, Development and Cure. Price, 25 cts.

History of Bee-Associations, and Brief Reports of the first 20 conventions. Price, 15 cts.

Honey as Food and Medicine, by T. G. Newman.—A 32-page pamphlet: just the thing to create a demand for honey at home. Should be scattered freely. Contains recipes for Honey-Cakes, Cookies, Fudings, Foam, Wines, and uses of honey for medicine. Prices, prepaid—Single copy, 5 cts.; 10 copies, 35 cts.; 50 for \$1.50; 100 for \$2.50; 250 for \$5.50; 500 for \$10.00; or 1000 for \$15.00.

When 250 or more are ordered, we will print the bee-keeper's card (free of cost) on the front cover page.

Bee-Keeping for Profit, by Dr. G. L. Tinker.—Revised and enlarged. It details the author's "new system, or how to get the largest yields of comb or extracted honey." 80 p.; illustrated, 25c.

Emerson Binders, made especially for the BEE JOURNAL, are convenient for preserving each number as fast as received. Not mailable to Canada. Price, 75 cts.

Commercial Calculator, by C. Ropp.—A ready Calculator, Business Arithmetic and Account-Book combined in one. Every farmer and business man should have it. No. 1, bound in water proof leatherette, calf finish. Price, 40 cts. No. 2, in fine artificial leather, with pocket, silicate slate, and account-book. Price, 60 cts.

Green's Four Books, by Chas. A. Green.—Devoted to, 1st, How We Made the Old Farm Pay; 2nd, Peach Culture; 3rd, How to Propagate Fruit-Plants, Vines and Trees; 4th, General Fruit Instructor. Nearly 120 pages. Fully illustrated. 25 cts.

Green's Six Books on Fruit-Culture, by Chas. A. Green.—Devoted 1st, to Apple and Pear Culture; 2nd, Plum and Cherry Culture; 3rd, Raspberry and Blackberry Culture; 4th, Grape Culture; 5th, Strawberry Culture. 129 pp.; illustrated. 25 cts.

Garden and Orchard, by Chas. A. Green.—Gives full instructions in thinning and Marketing Fruits; Pruning, Planting and Cultivating; Spraying, Evaporation, Cold Storage, etc. 94 pages, illustrated. Price, 25 cts.

Kendall's Horse-Book.—35 pictures, showing positions of sick horses, and treats on all their diseases. English or German. Price, 25 cts.

Silo and Silage, by Prof. A. J. Cook.—It gives the method in operation at the Michigan Agricultural College. Price, 25 cts.

Lumber and Log-Book.—Gives measurements of lumber, logs, planks; wages, etc. 25c.

Maple Sugar and the Sugar Bush, by Prof. A. J. Cook.—Full instructions. Price, 35 cts.

Grain Tables, for casting up the price of grain, produce, hay, etc. Price, 25 cts.

Capons and Caponizing, by Dr. Sawyer, Fanny Field, and others.—Illustrated. All about caponizing fowls, and thus how to make the most money in poultry-raising. 64 pages. Price, 30 cts.

Our Poultry Doctor, or Health in the Poultry Yard and How to Cure Sick Fowls, by Fanny Field.—Everything about Poultry Diseases and their Cure. 64 pages. Price, 30 cts.

Poultry for Market and Poultry for Profit, by Fanny Field.—Tells everything about the Poultry Business. 64 pages. Price, 25 cts.

Turkeys for Market and Turkeys for Profit, by Fanny Field.—All about Turkey-Raising. 64 pages. Price, 25 cts.

Rural Life.—Bees, Poultry, Fruits, Vegetables, and Household Matters. 100 pages. 25 cts.

Potato Culture, by T. B. Terry.—It tells how to grow them probably. Price, 40 cts.

Hand-Book of Health, by Dr. Foote.—Hints about eating, drinking, etc. Price, 25 cts.

Alsike Clover Leaflet.—Full directions for growing. 50 for 25 cts.; 100 for 40 cts.; 200, 70c.

Book Clubbing Offers.

(Read Carefully.)

The following clubbing prices include the American Bee Journal one year with each book named. Remember, that only ONE book can be taken in each case with the Bee Journal a year at the prices named. If more books are wanted, see postpaid prices given with

the description of the books on this page. Following is the clubbing-list:

1. Langstroth on the Honey-Bee.....	\$2.00
2. A B C of Bee-Culture.....	2.00
3. Bee-Keeper's Guide.....	1.75
4. Bees and Honey [Cloth bound].....	1.65
5. Scientific Queen-Rearing.....	1.75
6. Dr. Howard's Foul Brood Book.....	1.10
7. Advanced Bee-Culture.....	1.30
9. Bienen-Kultur [German].....	1.25
10. Rational Bee-Keeping [Cloth bound].....	2.00
11. Rational Bee-Keeping [Paper bound].....	1.75
12. Thirty Years Among the Bees.....	1.30
13. Bee-Keeping for Profit.....	1.15
14. Convention Hand-Book.....	1.15
15. Poultry for Market and Profit.....	1.10
16. Turkeys for Market and Profit.....	1.10
17. Capons and Caponizing.....	1.10
18. Our Poultry Doctor.....	1.10
19. Green's Four Books.....	1.15
20. Green's Six Books on Fruit-Culture.....	1.15
21. Garden and Orchard.....	1.15
23. Rural Life.....	1.10
24. Emerson Binder for the Bee Journal.....	1.60
25. Commercial Calculator, No. 1.....	1.25
26. Commercial Calculator, No. 2.....	1.40
27. Kendall's Horse-Book.....	1.20
30. Potato Culture.....	1.20
32. Hand-Book of Health.....	1.10
33. Dictionary of Apiculture.....	1.35
34. Maple Sugar and the Sugar Bush.....	1.20
35. Silo and Silage.....	1.10
36. Winter Problem in Bee-Keeping.....	1.30
37. Apiary Register (for 50 colonies).....	1.75
38. Apiary Register (for 100 colonies).....	2.00
39. Bee-Keepers' Directory.....	1.30

Convention Notices.

TENNESSEE.—The next annual meeting of the East Tennessee Bee-Keepers' Association will be held at Sneedville, Tenn., on September 18, 1896. All persons interested in bee-culture are cordially invited to attend. Luther, Tenn. JOHN M. SMITH, Asst. Sec.

TEXAS.—The third annual convention of the Southwestern Texas Bee-Keepers' Association will be held at Beeville, Tex., on Sept. 16 and 17, 1896. All are invited. No hotel bills to pay. Low rates on railroads. Beeville, Tex. J. O. GRIMSLEY, Sec.

MINNESOTA.—The annual meeting of the Southern Minnesota Bee-Keepers' Association will be held in Winona, on September 21 and 23, 1896, at 9 o'clock, a.m. All that feel in any way interested in bees or honey are cordially invited to attend. Winona, Minn. E. C. CORNWELL, Sec.

WISCONSIN.—The annual meeting of the Southwestern Wisconsin Bee-Keepers' Association will be held at Wauzeka, Wis., Oct. 7 and 8, 1896. All that are interested in apiculture are invited to attend, and especially those that want a foul brood law to protect their bees from this dread disease. Our committee is working hard to get every bee-keeper interested, and we should all feel it is for our interest to help get a State law to protect our bees. Many of our prominent bee-keepers of the State have promised to be at our meeting, and no one can afford to miss it. M. M. RICE, Sec. Boscobel, Wis.

North American Bee-Keepers' Association

OFFICERS FOR 1896.
PRESIDENT—A. I. Root..... Medina, Ohio.
VICE PRES.—Wm. McEvoy..... Woodburn, Ont.
SEC.—Dr. A. B. Mason..... Sta. B. Toledo, Ohio
TREAS.—W. Z. Hutchinson..... Flint, Mich.
Convention at Lincoln, Nebr., Oct. 7 & 8.

National Bee-Keepers' Union.

PRESIDENT—Hon. R. L. Taylor, Laneer, Mich
GEN'L MGR.—T. G. Newman... San Diego, Cal



INCUBATION

is the first step in the poultry business and much of future success depends upon its completeness. There is no failure where **RELIABLE INCUBATOR** is used. It is fully warranted and is the product of twelve years of experience. It has never been beaten in a Show. It is not like its competitors—it is better. We tell why in new book on poultry. Send for it. **RELIABLE INCUBATOR AND BROODER CO., QUINCY, ILL.**

36E17t Please mention the Bee Journal.

Question-Box.

In the multitude of counsellors there is safety.—Prov. 11-14.

How About Superseding Queens

Query 27.—Do you practice giving young queens to old colonies, or do you allow them to do the superseding themselves?—"OUT WEST."

R. L. Taylor—I leave the matter almost entirely to the bees.

G. M. Doolittle—I allow the bees to do the superseding, generally.

J. A. Green—I generally allow them to do their own superseding.

Eugene Secor—I usually let them attend to the matter themselves.

Prof. A. J. Cook—I am more and more in favor of letting the bees manage affairs.

Dr. J. P. H. Brown—I usually grant the bees the privilege of doing their own superseding.

Emerson T. Abbott—I have a notion that the bees will look after this matter better than I can.

Wm. McEvoy—Yes. Every colony in my apiary will have a young queen before the season closes.

W. G. Larrabee—Sometimes one and sometimes the other, I think, but not to let the queens get too old.

Jas. A. Stone—When the honey crop is good, the former will pay—but when it is not, I practice the latter.

Chas. Dadant & Son—we let them do it themselves, except in cases where we notice the failure of the queen.

E. France—we let our queens remain as long as they do good work. We kill old, worthless queens when we find them, and give the bees brood to rear another.

Mrs. L. Harrison—I let them usually do their own superseding. I heard Father Langstroth say that "Colonies that supersede their queens rear the best ones."

G. W. Demaree—I now leave superseding to the instincts of all good, strong colonies. Sometimes I take the matter in my own hands when a weak colony indulges an old queen too long, and is on that account losing in bees.

Rev. M. Mahin—I do not give young queens to old colonies unless there is some manifest reason for change. I have found that, as a rule, the bees perceive the necessity for change as quickly as I can, and I have found no advantage in removing old queens.

Dr. C. C. Miller—Generally I have left the bees to their own sweet will. But I have found that in some cases they supersede early in the spring, resulting in loss of brood. In other cases an old queen will be retained when a younger one might do better work.

J. E. Pond—Unless a queen is an extra-good one I usually supersede once in two years. By thus doing I insure having good queens all the time, except in those cases where something out of the usual run turns up, and in such case I treat it as the circumstances seem to require.

Mrs. J. N. Heater—When a queen is old and fails to keep the colony in good

THE "NOVELTY" POCKET-KNIFE!

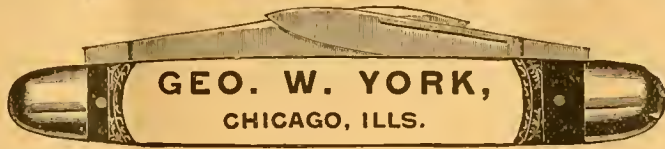

Your Name on the Knife.—When ordering, be sure to say just what Name and Address you wish put on the Knife.

The **NOVELTY KNIFE** is indeed a novelty. The novelty lies in the handle. It is made beautifully of indestructible celluloid, which is as transparent as glass. Underneath the celluloid, on one side of the handle is placed an AMERICAN BEE JOURNAL reminder, and on the other side, name and residence of the Subscriber.

The material entering into this celebrated knife is of the very best quality; the blades are handforged out of the very finest English razor-steel, and we warrant every blade. The bolsters are made of German silver, and will never rust or corrode. The rivets are hardened German silver wire; the linings are plate brass; the back springs of Sheffield spring steel, and the finish of handle as described above. It will last a lifetime, with proper usage.

Why purchase the Novelty Knife? In case a good knife is lost, the chances are, the owner will never recover it; but if the Novelty is lost, having name and address of owner, the finder will return it; otherwise to try to destroy the name and address, would destroy the knife. If traveling, and you meet with a serious accident, and are so fortunate as to have one of the Novelties, your pocket KNIFE will serve as an identifier; and in case of death, your relatives will at once be apprised of the accident.

How appropriate this knife is for a Christmas, New Year or birthday present! What more lasting memento could a mother give to a son, a wife to a husband, a sister to a brother, a lady to a gentleman, or vice versa, a son to a mother, a husband to a wife, a brother to a sister or a gentleman to a lady—the knife having the name of the recipient on one side?

The accompanying cut gives a faint idea, but cannot fully convey an exact representation of this beautiful knife, as the "Novelty" must be seen to be appreciated.

How to Get this Valuable Knife.—We send it postpaid, for \$1.00, or give it as a Premium to the one sending us three new Subscribers to the BEE JOURNAL (with \$3.00), and we will also send to each new name a copy of the Premium Edition of the book "Bees and Honey." We club the Novelty Knife with the BEE JOURNAL for one year, both for \$1.90.

Any Name and Address Put on the Knife.

GEORGE W. YORK & CO.,
CHICAGO, ILLS.

Allow about two weeks for your order to be filled.

PATENT WIRED COMB FOUNDATION

Has No Sag in Brood-Frames

Thin Flat-Bottom Foundation

Has No Fishbone in the Surplus Honey.

Being the cleanest is usually worked the quickest of any Foundation made

J. VAN DEUSEN & SONS,
Sole Manufacturers,
Sprout Brook Montgomery Co., N. Y.



ONE MAN WITH THE UNION COMBINATION SAW

Can do the work of four men using hand tools. In Rippling, Cutting-off, Milling, Rabbeting, Grooving, Gaining, Dadoing, Edging-up, Jointing Stuff, etc. Full Line of Foot and Hand Power Machinery Sold on Trial. Catalogue Free.

SENECA FALLS MFG. CO.,
46 Water St., SENECA FALLS, N. Y.
1Aly Mention the American Bee Journal.

WARRANTED GOLDEN

ITALIAN QUEENS By return mail; bred from a Breeder tested by Doolittle out of 1,000 Queens for his own use, and valued at \$50. Queens, 50c; 6 for \$2.75; or \$5.00 per dozen.

Leather Colored Queens from Root's best imported stock same price. Bees from my Queens are excellent workers on red clover. I guarantee safe delivery. N. B.—I sent more than 200 Queens safely to California last season.

H. G. QUIRIN, Bellevue, Ohio.
34A9 Mention the American Bee Journal.

Untested Italian Queens, 75c.

3 FOR \$2.00.

Catalogue of Apiarian Supplies Free.

I. J. STRINGHAM,
105 Park Place. NEW YORK, N. Y.

APIARY—Glen Cove, L. I.



That Queen-Clipping Device Free!

Works Like a Charm.

The Monette Queen-Clipping Device WORKS LIKE A CHARM. With it I have clipped 30 queens, all in one day, when examining my bees. WM. STOLLEY, Grand Island, Nebr.

Couldn't Do Without It.

I have clipped 19 queens, and must say the Monette Queen-Clipping Device is by far the best invention ever made, and will be welcome to many bee-keepers as it was to me. I could not do without one now.

DR. GEO. LACKE, Newburgh, Ind.

PLEASE READ THIS OFFER TO PRESENT SUBSCRIBERS:

Send us just one new name for the American Bee Journal a year (with \$1.00), and we will mail you the Queen-Clipping Device FREE of charge. Or, the Queen-Clipping Device will be sent postpaid for 30 cts. But why not get it as a Premium by the above offer? You can't earn 30 cts. any easier. Almost every bee-keeper will want this Device. See page 130 (Feb. 27) for full description of it. Complete directions accompany each one sent out. It is a most ingenious and useful article. Address,

GEORGE W. YORK & CO., 118 Michigan St., Chicago, Ill.



condition when nectar is coming in, take her head off, and give them a young queen. As a rule, the bees will supersede the queen themselves, and I believe they do this many times before it is necessary.

General Items.

Drawn-Out Combs—An Old Idea.

I see by the bee-papers that Mr. E. R. Root is very much interested in having drawn-out combs for section honey, and that he would like to secure a machine that would produce such combs. Well, this drawn-out comb idea is very good, but it is nothing new to the bee-men on Fox river. The fact is, we, here on Fox river, have known a "heap" about the value of such an idea for the past 10 years, at least. And it may surprise Mr. Root, and perhaps others, to learn that we have machines here that will make just such combs, and of any thickness desired—from one-fourth to one inch in depth, and of no greater weight than the natural comb itself. Twelve years ago I filled more than 50 supers with just such comb.

M. M. BALDRIDGE.

Kane Co., Ill., Aug 26.

Wayside Notes—Bees a Specialty.

If Mr. Aikin, of Loveland, Colo., would kindly consent to furnish notes by the way, as he travels by wagon down the Arkansas valley and through several States, he could not fail to interest the great army of Bee Journal readers.

Mr. F. L. Thompson, of Arvada, Colo., recently advocated bee-keeping as a specialty. His argument seemed to me conclusive in favor. If he would consent to publish both debit and credit pages of his ledger for the year 1896, with reference to the pursuit as one's sole occupation, his views would be gladly received.

In the opinion of many, division of labor must be carried much farther among the American people than at present. Instead of one individual following half a dozen occupations, and reaching thoroughness in none of them, each individual must study more to be a master in one industry.

Downing, Colo. S. W. DEBUSK.

The Locality and the Bees.

Some say that one locality is all right, but that their bees do not gather any surplus, while others claim their bees are all right, and that there is no surplus to be gathered. So they do not blame their bees for "loafing." Now here is my experience, and gain:

Last spring, as soon as fruit-bloom opened, I gave each one of my colonies 28 sections, and they seemed in need of them. The hives were crowded with bees, and great quantities of brood coming on, all looked prosperous, and bid fair to give good results. I gave them the room more to keep them from swarming than with the expectation of getting honey stored at that time. Only two colonies cast swarms, which were hived on empty brood-combs, and sections put on at once, so as to have the bother over with; they afterwards

—An Extra-Fine Grade of— Comb Honey!

Any one wishing something very nice in
**White Clover or Basswood
Comb or Extracted
HONEY**

for Exhibition or any purpose where a gilt-edge article is desired, should write for prices and particulars to,

JEWELL TAYLOR,
35A4t FORESTVILLE, MINN.
Mention the American Bee Journal.

What They All Say!

The Queen you sent me is the finest I ever had, and I have bought them all over the country. I am glad I can get the best right at home. Find \$1.00 for another.

MASON E. MARVEL,
Aug. 16, 1896. Oakland, Mass.

The above Queen was an Adel. I have 300 more just like her. Hardy, prolific, great honey-gatherers and practically non-swarming and non-stinging. New 4-page Catalog, giving history of the Adels and safest method of introducing Queens, sent free.

HENRY ALLEY, Wenham, Mass.
35Atf *Mention the American Bee Journal.*

**DO NOT ORDER UNTIL YOU HAVE
WRITTEN US FOR PRICES ON**

The "Boss" One-Piece Section



**Also D. T. Hives, Shipping-Crates
and Other Supplies.**

We have completed a large addition to our Factory, which doubles our floor room; we are therefore in better shape than ever to fill orders on short notice. **Send for Price-List**

J. FORNCROOK,

WATERTOWN, Jeff. Co., Wis., Jan. 1st, 1896.
Mention the American Bee Journal.

Barnes' Foot-Power Machinery.



Read what J. I. PARENT, of CHARLTON, N. Y., says—"We cut with one of your Comb-Machines, last winter 50 chaff hives with 7-in. cap, 100 honey-racks, 500 broad frames, 2,000 honey-boxes and a great deal of other work. This winter we have double the amount of bees-hives, etc. to make and we expect to do it with this Saw. It will do all you say it will. Catalogue and Price-List

Free. Address, W. F. & JOHN BARNES,
45Ctff No. 995 Rnby St., Rockford, Ill.
Mention the American Bee Journal.

The RURAL CALIFORNIAN

Tells all about Bees in California.

The Yields and Price of Honey; the Pasturage and Nectar-Producing Plants; the Bee-Ranches and how they are conducted. In fact the entire field is fully covered by and expert bee-man. Besides this, the paper also tells you all about California Agriculture and Horticulture. \$1.50 per Year; Six Months, 75 cents. Sample Free.

THE RURAL CALIFORNIAN,
218 N. Main St., LOS ANGELES, CALIF.

READERS Of this Journal who write to any of our advertisers, either in ordering, or asking about the Goods offered, will please state that they saw the Advertisement in this paper.

swarmed the second time, making four swarms out of 12 colonies. So much toward reducing the swarming-fever.

Now, from all my 15 colonies I have not secured a single section of honey, on account of locality, as the bees were just as strong as any, and just as many in each colony. But from the one, I to-day removed 56 sections of as fine white honey as any one would ask for. This colony did not swarm, nor has it cast a swarm since I have owned it—three years. One-half of this yield was secured by my wishing to experiment. I saw that they had finished the first super of 28 sections solid, while all the rest had idled around and done nothing, so, being in a great hurry, I asked an old bee-keeper if he would put any more on, seeing that the honey-flow was over. His advice was to remove the full crate and let them store the balance for winter stores. I thought differently, so I secured more sections, put them in a super, and simply set the empty ones on top of the finished sections. This was done on the morning of July 4, and to-day I removed it with every section filled to the very edge. I used separators between all sections, and 10-frame hives. I placed in position another super, and I am going to see if they will continue to store surplus through the golden-rod bloom, which will soon be on.

All the while this colony has been storing a good crop, others equally as strong have never done anything more than tear down the starters in the sections, and loaf around the hive, or try to sting some one when passing by. Now my question is, if they could and did secure honey, why did not others in the same yard, or some of my neighbors', get at least a little surplus? They are a poor variety of hybrids, so blood had nothing to do with the working of the bees.

N. T. SMITH.
Weston, Ohio, Aug. 1.

Thinks It a Bad Year.

This has been a very bad honey year in this part of California. I won't secure more than one ton of comb honey, and about the same amount of extracted, from 54 colonies.

DAN CLUBB.
Monson, Calif., Aug. 17.

"Washington Cedar" Hives.

On page 471, S. W. B., of Kendrick, Idaho, speaks of having trouble with new swarms in cedar hives bought of a Tacoma manufacturer. We believe these hives came from our factory, though not sold to him direct. He wrote us regarding it, however.

Now we know the trouble is not with the cedar lumber. For the past few years, at least, the "Washington Cedar" hives that have been put into use annually can be numbered by the thousands, and we have never before received reports of any one having this trouble. We ourselves have had as many as 128 in use in our own yard at one time. Bees have been kept in boxes made of this lumber ever since there have been bees in Washington. We transferred some for a rancher, a couple of years since, that had been there for 15 years. He observed no trouble. Bees are found in cedar trees, and if the scent were offensive they would never have gone there. Besides, the scent of decayed

cedar in a hollow tree is far more rank than that of sound lumber.

Dr. Miller's first reason probably has a great deal to do with the case; after having a swarm it should be set in a cool place. This should hardly need to have been mentioned, as it is so commonly known among bee-keepers. Upon having a swarm, they should also have plenty of ventilation; if the day is hot and the swarm is large, raise the hive from the bottom-board.

If the above rules are observed in hiving swarms, provided the swarm is accompanied with a good laying queen, we will guarantee there will be no trouble with the "Washington Cedar" hives.
C. E. P. & B.

Can't Make Bees Pay.

Bees do not pay in this locality. Basswood is scarce and white clover has about played out. I commenced last spring with 10 colonies, and will not average 20 pounds apiece; the most I will get from a single colony will be about 40 pounds. I will not pay expenses, and never have yet, but I have been hoping that I would. If I were the only one in this locality that did not get much, I would think it was my fault, but I get double the honey of any of them. But a few miles from here honey is plentiful. Bees and honey are not my business—farming is my trade, and it takes all of my time to make it a success.

I think the American Bee Journal the best bee-paper I have seen. Well may it prosper, and long may it live!

FRED C. CARD.

Burns, Mich., Aug. 25.

A Bee-Bite—Queen-Laying Story.

I have two little neighbor boys that bother me considerably; it seems that they watch my apiary as closely as you ever saw a bee-martin do it—and as soon as I would go to do anything with my bees, here they come. The busier I would be, the faster their questions would come. I often left my apiary when I would see them coming, to get rid of the little, barefooted fellows. But one day, rather to my delight and long past wishes, a bee took a notion to help me get rid of my pests. The first I saw was little Jimmy pop up and whirl as he jumped, and give a few tall leaps toward home, some 10 rods distant, and screaming at the top of his voice. The bee had gotten under his waist. He would stop occasionally and listen, to hear the bee, then another leap into the air and a whirl towards home. You ought to have seen my fat sides shake!

His mother came to my house that evening. I turned my back to her to ask her if Jimmy got stung. She said, "No, it didn't sting him. It only bit him a little on the ear." I tell you that has been an awful relief to me.

Since that time they will venture about half way and hollow, "Mr. Cotton, is the bees mad?" I always say, "Yes," and this is all the question I have to answer these days.

Now for something I learned to-day from a man that claims to be the most extensive bee-man of our county—in fact, the first man that got Italian bees in the county. He was on a short call at my house this morning. Hearing that I took the American Bee Journal, he wished to get the addresses of some

Honey-Clovers & Buckwheat SEED FOR SALE.

We have made arrangements so that we can furnish seed of several of the Clovers and Japanese Buckwheat, by freight or express, at the following prices, cash with order

	5lb	10lb	25lb	50lb
Alsike Clover	\$.70	\$1.25	\$3.00	\$5.75
Sweet Clover	.75	1.40	3.25	6.00
White Clover	1.25	2.00	4.50	8.00
Alfalfa Clover	.65	1.10	2.70	5.00
Crimson Clover	.55	.90	2.00	3.50
Jap. Buckwheat	.20	.35	.90	1.25

Prices subject to market changes.
Add 25 cents to your order, for cartage, if wanted by freight.
Your orders are solicited.

GEORGE W. YORK & CO.,
CHICAGO, ILLS.

Mention the American Bee Journal.

THROAT AND LUNG DISEASES, DR. PEIRO, Specialist
Offices: 1019, 100 State St., CHICAGO. Hours 9 to 4.

Mention the American Bee Journal.

Sweet Clover & Canada.

At the following prices:

5 lbs.	10 lbs.	25 lbs.	50 lbs.
\$1.00	\$1.60	\$3.75	\$7.25

Also a quantity of Motherwort and Catnip seed. Prices on application.

EGGS for Hatching. Buff Leghorns, Indian Games, & Light Brahmas. Choice Birds. A breeder for 30 years. Prices on application

JOHN McARTHUR,
881 Yonge Street. TORONTO, ONT.
15Atf Mention the American Bee Journal.

Van Deusen Foundation!

I have some of the celebrated Van Deusen Thru Foundation in 25-pound boxes, that I will put on board cars for \$12.50 per box.

Also ITALIAN

Queens! Queens!



Fine Untested Queens mailed PROMPTLY at 45 cts. each, or Six for \$2.40.

Safe delivery and satisfaction guaranteed. Address,

F. GRABBE,
LIBERTYVILLE, Lake Co., ILL.

26Atf Mention the American Bee Journal

HONEY We have No. 1 Alfalfa, also White and Sweet Clover Honey we will sell cheap.

Honey and Beeswax Wanted.

Boss bee-escape Warranted the best, simplest and quickest Escape on the market. Sent postpaid to any address for 30 cts. It can be returned at our expense if it is not as represented, or we will send the Escape on trial to any bee-keeper wishing to test it in good faith. We are agents for the

Ferguson Patent Hive with double-case Super and Wicket-Gate Honey-Board, with the Escape. It is the easiest, quickest hive to handle for the production of comb or extracted honey.

E. S. LOVESY & Co.,
355 6th East St., SALT LAKE CITY, UTAH.
Mention the American Bee Journal. 9Atf

WOVEN WIRE FENCE
Over 50 Styles The best on Earth. Horse high, Bull strong, Pig and Chicken tight. You can make from 40 to 60 rods per day for from 14 to 22c. a Rod. Illustrated Catalogue Free. **KITSELMAN BROS.,** Ridgeville, - Indiana.

48Etf Mention the American Bee Journal.

men that had queens for sale. I entered into conversation with him in regard to the laying capacity of a queen. He said he could not tell the number of eggs or supposed number, that a queen would lay, but said one thing he did know, that he had tried, and that was, to take a window glass and smear it evenly and thin with honey, and put a queen on it, and she would start across the glass and lay a string of eggs as she went, faster than 10 men could count them. I said, "Mr. Curl, wouldn't you like to take the Bee Journal a year? It is full of information, and all men that are well posted on the bee-question have free access to its columns." He took a back number to peruse, and went on to his appointment to preach to-day.

Now, Mr. Editor, if you should happen to get Mr Curl's subscription before you publish this letter, please omit the part referring to him, for I sometimes hate to see facts in print, even on preachers. But "let her rip," as I have my wife for a witness to the facts as given.

Pollock, Mo. ANDREW COTTON.

P. S.—How well I would like to see answers to my two queries as to eggs found in a queen, and drones mating with workers. Come on boys, the water is not deep. A. C.

Cedar Hives All Right.

For the benefit of one of the Washington State subscribers, and also for the benefit of others who may have gotten the same notion in regard to bees leaving cedar hives on account of their odor, I wish to say that I have at the present time 125 prosperous colonies, all in cedar hives with the exception of about 10, which are in fir hives, and I have never yet had a swarm leave the hive after having been properly hived, so I do not think there can be anything at all wrong with cedar for hives. I write this because I have been asked very many times if cedar would do to make hives of, and I think it the best wood for the purpose which grows in these parts.

So far this has been one of the poorest seasons for honey in many years, although it looks very favorable for a good fall flow.

F. M. LITTLE.
Junction City, Wash., Aug. 17.

500 Queens Ready to Ship!

For the next 60 days we will sell Queens bred from best Imported stock or from one of Doolittle's best Queens, at the following low prices: Warranted Queens, each, 45 cents; 1/2 doz., \$2.60. Untested, each, 40 cts.; 1/2 dozen, \$2.40. Tested, each, 55 cts.; 1/2 doz., \$3.20.

All Queens promptly sent by return mail.
Leininger Bros., Ft. Jennings, O.
34Etf Mention the American Bee Journal.

CARLOADS

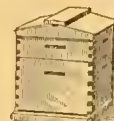

Of Bee-Hives, Sections, Shipping-Cases, Comb Foundation, and Everything used in the Bee-Industry.

I want the name and address of every Bee-keeper in America. No reason why you cannot do business with me. I have Cheap Lumber and Experienced Workmen; a good Water-Power Factory and know how to run it. I am supplying Dealers as well as consumers. Why not you? Send for Catalogues, Quotations, etc. **W. H. PUTNAM,** 1E RIVER FALLS, Pierce Co., Wis.

Mention the American Bee Journal.

PROF. A. J. COOK'S BOOK FREE!

The Bee-Keeper's Guide

OR

MANUAL OF THE APIARY.

This 15th and latest edition of Prof. Cook's magnificent book of 460 pages, in neat and substantial cloth binding, we propose to give away to our present subscribers, for the work of getting new subscribers for the American Bee Journal.

A description of the book here is quite unnecessary—it is simply the most complete scientific and practical bee-book published today. Fully illustrated, and all written in the most fascinating style. The author is also too well-known to the whole bee-world to require any introduction. No bee-keeper is fully equipped, or his library complete, without "THE BEE-KEEPER'S GUIDE."

Given For 2 New Subscribers.

The following offer is made to PRESENT subscribers only, and no premium is also given to the two new subscribers—simply the Bee Journal for one year:

Send us **Two New Subscribers** to the Bee Journal (with \$2.00), and we will mail you a copy of Prof. Cook's book FREE as a premium. Prof. Cook's book alone sent for \$1.25, or we club it with the Bee Journal for a year—both together for only \$1.75. But surely anybody can get only 2 new subscribers to the Bee Journal for a year, and thus get the book as a premium. Let everybody try for it. Will you have one?

GEORGE W. YORK & CO., 118 Mich. St., CHICAGO, ILL.

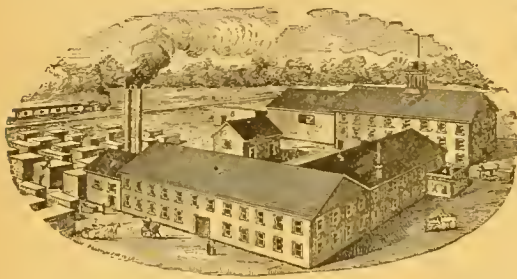

BEE-SUPPLIES!

We have the best equipped Factory in the West. Capacity—one carload a day; and carry the largest stock and greatest variety of every thing needed in the apiary, assuring **BEST** goods at the **LOWEST** prices, and prompt shipment.

Illustrated Catalog, 80 pages. Free.

Address, **E. KRETCHMER, Red Oak, Iowa.**

❖ MONEY SAVED IS MONEY GAINED. ❖

THE ROYAL UNION

Life Insurance Company

DES MOINES, IOWA.

The Iowa Policy

Is one that definitely promises to keep an accurate account with you; credit your premiums and interest, charge the actual expense and mortality cost, and hold the remaining funds subject to your order.

Agents Wanted.

JOHN B. KING, GENERAL AGENT,
Suite 513 First Nat'l Bank Bld'g.

20Atf CHICAGO, ILL.
Mention the American Bee Journal

IF YOU WANT THE

BEE-BOOK

That covers the whole Apicultural Field more completely than any other published, send \$1.25 to Prof. A. J. Cook, Claremont, Calif., for his

Bee-Keeper's Guide.

Liberal Discounts to the Trade.

California ❄️❄️

If you care to know of its Fruits, Flowers Climate or Resources, send for a Sample Copy of California's Favorite Paper—

The Pacific Rural Press

The leading Horticultural and Agricultural paper of the Pacific Coast. Published weekly, handsomely illustrated, \$2.00 per annum. Sample Copy Free.

PACIFIC RURAL PRESS,
220 Market St. - SAN FRANCISCO, CAL.
WHEN ANSWERING THIS ADVERTISEMENT, MENTION THIS JOURNAL.

Page & Lyon Mfg. Co.,

► New LONDON, WIS., operates two saw-mills that cut, annually, eight million feet of lumber, thus securing the best lumber at the lowest price for the manufacture of bee-keepers' supplies. They have also just completed one of

The Largest Factories,

► and have the latest and most improved machinery for the manufacture of Bee-Hives, sections, etc., that there is in the State. The material is cut from patterns, by machinery, and is absolutely accurate. For Sections, the clearest and

The Whitest Basswood

► is used, and they are polished on both sides. Nearness to pine and basswood forests, and possession of mills and factory equipped with best machinery, all combine to enable this firm to furnish the best goods at

The Lowest Prices. ❄️❄️

► For instance, it has a joblot of 200,000 No. 2 Sections that will be sold at 50 cts. per 1,000; or 2,000 Snow-White sections will be sold for \$4.00, and larger quantities at still lower prices. Send for Circular and see the prices on a full line of supplies. 16Atf

BEGINNERS.

Beginners should have a copy of the Amateur Bee-Keeper, a 70-page book by Prof. J. W. Rouse. Price 25 cents; if sent by mail, 28c. The little book and the Progressive Bee-Keeper (a live, progressive 28-page monthly journal) one year, 65c. Address any first-class dealer, or

LEAHY MFG. CO., Higginsville, Mo.

MUTH'S HONEY EXTRACTOR

PERFECTION
Cold-Blast Smokers,

Square Glass Honey Jars, Etc.
For Circulars, apply to CHAS. F. MUTH & SON,
Cor. Freeman & Central Aves., Cincinnati, O.
Send 10c for Practical Hints to Bee-Keeper.

AMONG THE BEE-PAPERS.

Suggestion from a Commission Man.

As you will remember, we have advocated the use of small sections for honey for some years, and now small sections are the standard size—so much so that any sections weighing over $\frac{3}{4}$ to one pound have to be sold at a discount, and are about out of style entirely. We are advocating now the use of a wood-pulp board wrapper, or cheap carton, for we find the trade calls for honey without glass, but wants some protection from breaking in shipping. These cartons, or wrappers, can be procured at a low price, or about one-half per pound what honey sells for, thereby affording a profit, as dealers do not object to the weight of these wrappers as they do to glass.

We look for a good demand for honey; but the days of high prices are gone by; and the bee-keepers' honey that is the most attractive and most desirable will sell first and for the best price, always, and the consumer is more fastidious every season.

A word about shipping-cases: Don't use a case holding over 24 combs (single tier), nor less than 20 combs.—H. R. WRIGHT, of New York, in Gleanings.

Scanty Stores for Winter.

If I remember right, the quantity of honey needed to carry a colony of bees safely through the winter, has been estimated at different times by different writers at amounts ranging from 5 to 40 pounds. This question is surely of some importance to bee-keepers, for if an average colony of bees may be wintered safely on 5 pounds of honey, it is of no use to let them consume any more, and we might as well save the 35 pounds of the higher estimate. But I very much fear that a thorough investigation into the details will evidence the fact that scanty stores are a nuisance.

In the first place, I believe that it would be a mistake to set down a stated amount as absolutely and exactly sufficient, for the reason that, not only colonies differ in numbers, age of their bees, etc., but winters also differ in duration, in suddenness of changes, and the number of sunny days, or stormy days, even, has some influence upon this question.

Colonies which are wintered in the cellar consume less honey than those wintered out-of-doors, but in localities where the winters are comparatively mild, if the bees are strong in the fall, the difference between out-door and in-door wintering is slight. Most bee-keepers agree that a comparatively weak colony will consume more stores than a very powerful one, owing to the necessity of producing heat by eating. For this reason it is undoubtedly better to winter the weak colonies in the cellar, and the populous ones out-of-doors.

But all things being equal, it is best to leave to a strong average colony a large amount of honey, say 30 to 40 pounds, or should we compel them to winter on the least possible amount? I hold for the large supply, even though the quantity left in excess might constitute a sufficient amount to pay for one season's management of the apiary.

If we stint our bees, we compel them

to reduce their breeding. A colony which has not a great plenty will be much less prone to breed early, and the swarm will be much more likely to dwindle during the early spring. The bee-keeper who is so fond of his bees that he will not pass three days without examining them, may be able to remedy any shortage in good time, and feed when he sees it necessary, but to those who make bee-culture a matter of earnings, and who have also other things to occupy their minds, or their hands, it is more preferable to leave the supply sufficient, and trust in the little creature's wisdom as to the consumption of the food. I do not believe that the bees will waste any of this food, and with each warm day their breeding will increase, and they will furnish a much stronger army for the honey season than if their board is controlled and scantily supplied by the stingy apiarist.—C. P. DADANT, in Bee-Keepers' Review.

Marketing Honey—Its Price.

As to the best method of selling, sell as much as possible in your home market. Peddling will do if only a small crop is to be disposed of, and if the apiarist has nothing better to do. As a rule, it takes too much time in proportion to the amount sold. For my part, I should prefer to keep more bees, and work in the apiary, instead of spending most of my time in peddling out a smaller crop.

To avoid unnecessary expenses, sell directly to the grocers of your nearest cities. Do not sell too much to any one until you find out whether he is reliable, unless, of course, it be a cash sale. In the beginning you will have, in most cases, to begin by leaving a few pounds to be sold on trial, and returned to you if not found satisfactory. After a line of customers is established, it will be as easy to dispose of a large crop that way as it would be to send it to a commission merchant; and you will not only save the commission, but probably get a little above the market price, provided, of course, your honey is not too bad, or badly put up.

The question has been asked lately why the price of honey is now almost invariable, no matter whether the crop is large or small. The answer is not hard to give. Glucose (or, rather, corn syrups) are now produced in enormous quantities, and sold at a close margin. As they can be produced in unlimited quantities, their price cannot vary, even if the demand should increase. The result is, that the price of honey is governed by the price of the corresponding quality of the corn syrup. I say "corresponding quality," because there are different qualities of corn syrup as well as different qualities of honey. As the honey is decidedly superior, it will always sell a little above the corn syrup, but not much; for if the difference were too great, people would rather buy the somewhat inferior substitute. On the other hand, should the production of honey increase considerably, it would not decrease the price materially, but simply displace a corresponding quantity of syrup, from the fact that at equal or even slightly superior prices, people will take honey in preference.—ADRIAN GETAZ, in Gleanings.

HONEY and BEESWAX

MARKET QUOTATIONS.

The following rules for grading honey were adopted by the North American Bee-Keepers' Association, and, so far as possible, quotations are made according to these rules:

FANCY.—All sections to be well filled; combs straight, of even thickness, and firmly attached to all four sides; both wood and comb unsoiled by travel-stain, or otherwise; all the cells sealed except the row of cells next the wood.

NO. 1.—All sections well filled, but combs uneven or crooked, detached at the bottom, or with but few cells unsealed; both wood and comb unsoiled by travel-stain or otherwise.

In addition to this the honey is to be classified according to color, using the terms white, amber and dark. That is, there will be "fancy white," "No. 1 dark," etc.

Chicago, Ills., Aug. 31.—Fancy white clover, 13c.; No. 1 white, 11@12c.; fancy amber, 9@10c.; No. 1 amber, 6@8c.; fancy dark, 8@9c.; No. 1 dark, 7c. Extracted, white, 5@7c.; amber, 5@5½c.; dark, 4½@5c. Beeswax, 25@27c.

The month closes with some offerings of new comb honey, for which 14-15c. is asked for best lots—but there are no sales of consequence to report. There is usually a good deal of it moved in September, thus establishing the early market.

Philadelphia, Pa., Aug. 14.—Extracted, white, 8-10½c.; amber, 4-5c.; dark, 3-4c. Beeswax, 25c.

No new comb in this market yet. Old comb cleaned out.

Detroit, Mich., Aug. 8.—No. 1 white, 12-12½c.; fancy amber, 10-11c.; No. 1 amber, 9-10c.; fancy dark, 8-9c. Extracted, white, 5½-6c.; amber, 5-5½c.; dark, 4-5c. Beeswax, 24-25c.

Cincinnati, Ohio, July 10.—No. 1 white, 13@14c.; fancy amber, 12@13c.; No. 1 amber, 10@12c. White, extracted, 5@7c.; amber, 5@6c.; dark, 3½-5c. Beeswax, 20-25c.

Indianapolis, Ind., July 28.—Fancy white 15-16c.; No. 1 white, 13-14c. Extracted, white, 6-7c. Beeswax, 25-27c.

No demand at all for old grades of either comb or extracted honey. Large fruit crop and warm weather are opponents to the demand for honey at present.

New York, N. Y., Aug. 8.—No. 1 white, 12@13c.; fancy amber, 11@12c.; No. 1, 10@11c. Extracted, white, 5½@5¾c.; amber, 5c.; dark, 50c. per gallon. Beeswax, 25c.

Our market has not opened up as yet and we would not advise shipping comb honey before Sept. 1, or latter part of this month. Extracted is selling fairly well at prices quoted. Beeswax very dull and declining.

St. Louis, Mo., Aug. 8.—Fancy white, 13@14c.; No. 1 white, 12@12½c.; fancy amber, 11@11½c.; No. 1 amber, 10@10½c.; fancy dark, 8@9c.; No. 1 dark, 7@7½c. Extracted, white, in cans, 5c.; in barrels, 4@4½c.; amber, 3@3½c.; dark, 2½@3c. Beeswax, 19@20c.

Very little honey coming in at present, and the weather is too warm to handle to advantage if it were here.

Albany, N. Y., Aug. 25.—Fancy white, 14-15c.; No. 1, 12-13c.; fancy amber, 11-12c.; No. 1 amber, 10-11c.; fancy dark, 9-10c.; No. 1 dark, 8½-9c.

Receipts of comb honey are quite large, and there is some demand, but we think producers make a mistake in urging immediate sales, as it tends to lower prices. There is quite a demand for comb honey put up in paper cartons.

San Francisco, Calif., Aug. 19.—White comb, 11-12½c.; amber, 7½-10c. Extracted, white, 5-5½c.; light amber, 4½-4¾c.; amber colored and candled, 3½-4c.; dark tulle, 2¾-3c.

Small quantities of new crop are coming forward, mainly from the San Joaquin valley, where most of this season's honey was produced. The best districts in the southern coast counties, usually large producers, are this year turning out little or nothing. Market is firm at the quotations, but only on local account are current figures obtainable. Letters were received here this week from Europe, offering Austrian honey at \$1.80 per 100 pounds, ex-duty, laid down in New York.

Beeswax, fair to choice, 22-25c. Not much arriving, and only a small proportion is of fine quality. Buyers are not numerous, however, and market is rather easy in tone.

Milwaukee, Wis., Aug. 8.—Fancy white, 14-15c.; No. 1, 12-13c.; No. 1 amber, 8-10c. Extracted, white, 6-7c.; amber, 5-6c.; dark, 4-5c. Beeswax, 22-24c.

New crop of honey begins to come forward. The demand is very poor and quotations almost nominal. Weather is very warm and the consumption of honey is very small. Plenty of fruit, and hence the appetite is satisfied with same in preference. Later on we expect an improved demand for honey of all kinds.

Minneapolis, Minn., Aug. 8.—Fancy white, 12½c.; No. 1 white, 10@11c.; fancy amber, 9@10c.; No. 1 amber, 8@9c.; fancy dark, 7@8c.; No. 1 dark, 6-8c. Extracted, white, 5½@6½c.; amber, 5@5½c.; dark, 4@5c. Beeswax, 23@26c.

The demand for both comb and extracted is very quiet, and for the latter, nominal. The hot weather of the past week or so has checked demand for comb honey.

Cleveland, Ohio, Aug. 8.—Fancy white, 14½@15c.; No. 1 white, 12½@13c. Extracted, white, 6@7c.; amber, 4½@5½c. Beeswax, 22@25c.

There is not very much honey in our market. Selling rather slow. Demand beginning to be a little better. Think trade will be fair in this time this fall.

Kansas City, Mo., Aug. 8.—Fancy white comb, 15c.; No. 1 white, 13@14c.; fancy amber, 12-13c.; No. 1 amber, 11-12c.; fancy dark, 10-11c.; No. 1, 8-10c. Extracted, white, 6-6½c.; amber, 5-5½c.; dark, 4-4½c. Beeswax, 22-25c.

Boston, Mass., Aug. 10.—Fancy white, 14-15c.; No. 1, 12-13c.; fancy amber, 9-10c. Extracted, white, 6-7c.; amber, 5-6c. Beeswax, 25c.

Good supply of new honey, but demand is light this very hot weather.

Buffalo, N. Y., Aug. 28.—Fancy comb, 1-pound, quiet, 11-12c.; No. 2, quiet, 8-10c.; No. 3, 4-6c.

Old honey is almost unsalable, as well as lots in poor order. Too early for much demand. Don't advise shipments before September to Buffalo and then classify according to actual value.

List of Honey and Beeswax Dealers.

Most of whom Quote in this Journal.

Chicago, Ills.

R. A. BURNETT & Co., 163 South Water Street.

New York, N. Y.

HILDRETH BROS. & SEGELKEN,
120 & 122 West Broadway
CHAS. ISRAEL & BROS., 486 Canal St.

Kansas City, Mo.

C. C. CLEMONS & Co., 423 Walnut St.

Buffalo, N. Y.

BATTERSON & Co., 167 & 169 Scott St.

Hamilton, Ills.

CHAS. DADANT & SON.

Philadelphia, Pa.

WM. A. SELSER, 10 Vine St.

Cleveland, Ohio.

WILLIAMS BROS., 80 & 82 Broadway.

St. Louis, Mo.

WESTCOTT COM. Co., 213 Market St.

Minneapolis, Minn.

S. H. HALL & Co.

Milwaukee, Wis.

A. V. BISHOP & Co.

Boston, Mass.

E. E. BLAKE & Co., 57 Chatham Street

Detroit, Mich.

M. H. HUNT, Bell Branch, Wayne Co., Mich

Indianapolis, Ind.

WALTER S. POWDER, 162 Massachusetts Ave.

Albany, N. Y.

CHAS. McCULLOCH & Co., 380 Broadway.

Cincinnati, Ohio.

C. F. MUTH & SON, cor. Freeman & Central avs.

Bottom Prices

**BRING US BIG TRADE.
GOOD GOODS KEEP IT.**

If you want the best supplies that can be made at a little less cost than you can buy for the same goods for elsewhere, write to us for low prices. 1896 Catalogue now ready—ask for it and a free copy of **The American Bee-Keeper** (36 pages).

Address,
THE W. T. FALCONER MFG. CO.,
JAMESTOWN, N. Y.
Mention the American Bee Journal.

COMB FOUNDATION!

Wax always wanted for Cash or in Exchange for Fdn. or other Supplies. My trade is established on **Low Prices** and the merit of my **Foundation**. Orders filled promptly.

WORKING WAX INTO FDN. BY THE LB. A SPECIALTY. Wholesale prices to dealers and large consumers. Send for Prices and Samples to—**GUS DITTMER, AUGUSTA, WIS.** Reference—Augusta Bank. 1Atf
Mention the American Bee Journal.

UP AGAIN!

And when I brush away that tear I'll be as bright and smiling as ever. What makes me smile? This second letter from E. A. Morgan, of Chippewa Falls, Wis., which reads:



"Your strain of bees prove themselves to be the most energetic honey-gatherers, besides being unusually prolific and long-lived; and again, they go into the sections as readily as the Carniolans—something that Italian bees have never before been free to do with me. I have now taken 168 lbs. white clover comb honey, from the colony spoken of before, and the hive-body weighed to day 84 lbs. If you have all such bees as these, it is no wonder you can get honey. I feel very lucky in getting hold of such a strain. They are so much superior to anything I ever had before. July 24, 1896."

For prices, etc., see Doolittle's advertisement on page 512, Aug. 6th number Am. Bee Journal.

A Bargain—EARLY QUEENS.

119 Colonies Italian Bees in Chaff Hives: two acres land; good house; excellent well
Early Queens—Tested, \$1.00; Untested, 50c. Sent by return mail.

E. L. CARRINGTON,
16Atf PRTTUS, Bee Co., TEX.
Reference—1st National Bank of Beeville.
Mention the American Bee Journal.

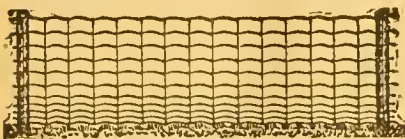

PAGE FENCE HOLDS BEARS!

"Haint got any bears, don't want any, so what do I care?" Simply this: It's another proof of the benefit of elasticity. Owing to his weight, strength, persistency and ability to climb, bruin can discount all the bulls creation testing wire fence, and none but Page can hold him. Read particulars in July "Hustler."

PAGE WOVEN WIRE FENCE CO., Adrian, Mich
Mention the American Bee Journal.

19th Year Dadant's Foundation 19th Year

Is still in the lead, for we use all the latest improvements, including the

NEW WEED PROCESS,

and still make the best goods. Remember that we do not use any acid to purify our bees-wax, and that is why our Foundation preserves the smell of the honey and is more acceptable to the bees, than any other. It is kept for sale by

T. H. Strickler, Solomon City, Kansas.
G. K. Hubbard, Fort Wayne, Ind.
L. Hanssen, Davenport, Iowa.
C. Theilmann, Theilmanton, Minn.
E. C. Eaglesfield, Berlin, Wis.
E. T. Abbott, St. Joseph, Mo.
J. M. Jenkins, Wetumpka, Alabama
John Rey, East Saginaw, Mich.
Vickery Bros., Evansville, Ind.

The Jennie Atchley Company, Beeville, Texas.
C. F. Muth & Son, Cincinnati, Ohio
E. Kretschmer, Red Oak, Iowa.
G. B. Lewis Co., Watertown, Wis.
James Reynolds Elevator Co., Poughkeepsie, N. Y.
Louisiana Bee-Keepers' Supply Manufactory, Donaldsonville, La.
Page & Lyon, New London, Wis.
John Nebel & Son, High Hill, Mo.

and many other Dealers. All agree in saying that no goods are better than ours.

We make a specialty of **Veils and Veil Stuffs** of best quality, cotton and silk.

Langstroth on the Honey-Bee, Revised

Bee-Keepers' Supplies, Smokers, Sections, Tin Pails, etc.

Samples of Foundation and Tulle FREE with Circular. Instructions to beginners with Circular. Send us your address.

CHAS. DADANT & SON,

Mention the American Bee Journal.

HAMILTON, Hancock Co., ILL.

See Campaign Book Offer on page 559! Better Have It!

10 per ct. Off to Reduce Stock

on all kinds of **SUPPLIES**, except

—COMB FOUNDATION—

which will be sold in lots of 10 lbs. or more as follows: Medium, 35 cts.; Light, 36 cts.; Thin Surplus, 40 cts.; Extra Thin, 45 cts.

Queens—Warranted, 50c.; Tested, 75c.
W. J. FINCH, Jr., SPRINGFIELD ILLS.

Mention the American Bee Journal.

* Extracted Honey *



Finest Quality. Basswood and Clover.

2 60-lb. cans in case, 8c. per pound. 1 60-lb. can in case, 9c. per pound. A sample by mail, 10 cts. **POUDER'S Honey-Jars and Complete Line of Supplies.** Catalogue Free.

WALTER S. POUDER,
162 Mass. Avenue, INDIANAPOLIS, IND.

Mention the American Bee Journal.

Good Prices on Your Comb Honey!

Then you want our latest

NON-DRIP SHIPPING-CASES.

Our trade was never so large in these as now; and Commission Men tell us that Comb Honey in our Cases brings

BETTER PRICES

than some of the Cases made by competitors. The fact is, we know the demands of the trade, and are prepared to supply them. Remember, home-made or poorly made Cases are dear at any price. Honey in such Cases always brings several cents below the market price.

If you wish to get **GILT-EDGE PRICES** on **GILT-EDGE HONEY** put it up in

Root's Non-Drip Shipping-Cases.

THE A. I. ROOT COMPANY,

Factory and Main Office, **MEDINA, O.**

BRANCH OFFICES:

118 Michigan St., Chicago, Ill.
1024 Miss. Str., St. Paul, Minn.

Syracuse, N. Y.
Mechanic Falls, Maine.

AMERICAN BEE JOURNAL

ESTABLISHED 1861
THE OLDEST BEE-PAPER IN AMERICA

DEVOTED EXCLUSIVELY TO THE INTERESTS OF HONEY-PRODUCERS

Published Weekly, at \$1.00 per annum.

Sample Copy sent on Application.

36th Year.

CHICAGO, ILL., SEPTEMBER 10, 1896.

No. 37.



A New Bee-Disease—Pickled Brood or White Fungus.

BY DR. WM. R. HOWARD.

My attention was called to this disease nearly two years ago. I had two colonies to die during the winter, and when examined in the spring, I found the combs very moldy, especially those containing pollen. These combs were given to other colonies, and everything went off nicely, till the brood was about ready to seal, when much of it was found to be dead; careful watch was kept, and it was noted that the dead brood did not decay like "foul brood." Again, much of that

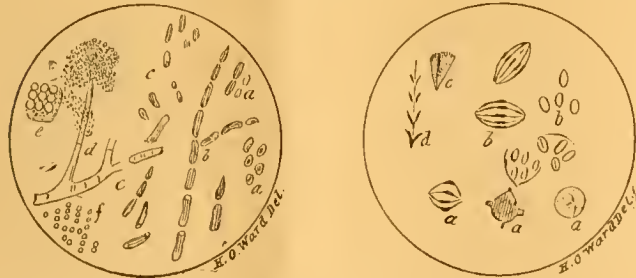

Fig. 1.

Fig. 2.

Fig. 1—Bacillus alvei and other germs—600 diameters.
Fig. 2—Pollen-grains, etc.—600 diameters.
[Both Figures from the Author's "Foul Brood."]

which was sealed never hatched, and was found to be dead and shriveled, without becoming rotten. The season was a poor one, little honey coming in, the bees seemed discouraged, uneasy, and often the dead white larvæ would be carried out; on examining the combs the dying larvæ were noticed to be wriggling out of the cells, some were only half way out, but fell out while under observation.

The larvæ when dead have a swollen appearance, neither end touching the sides of the cell is a common position (Fig. 5, a). In some cases, when left 5 or 6 days, the brood settles down like "foul brood" (Fig. 5, b), and changes to a dark-brownish mass; which, on examination, is found to be watery, and not "ropy" like "foul brood;" entirely void of the offensive odor, in fact no odor at all.

A microscopical investigation showed, in addition to *Penicillium glaucum* (Fig. 1, d), other molds in the pollen and on the combs; from these and the dead brood was isolated as the cause of the trouble a species of *aspergillus*, a white fungus, or mold. Several experiments were made during the summer, which fully satisfied me that my conclusions were correct.

This suggested to my mind, that, perhaps, this was the kind of "foul brood," of which so many had written; the kind which had been treated by the *starvation method*, the *drug method* (?), and the kind which always disappears as soon as *fresh pollen* comes in; and possibly the kind mentioned by Mr. N. W. McLain (Author's "Foul Brood," page



Fig. 3.

Fig. 4.

Fig. 3—Infected pollen—600 diameters. a, globular and polyhedral pollen-grains. b, resting spores found in bee-bread and in larvæ. c, growth 3 days' old, as found on proper culture media, also in the body of the larvæ. d, division of the resting spores. b, when growth first starts.

Fig. 4—The mature mold—600 diameters. e, the network of the base (mycelium) of the mold. f, the resting spores. g, the thread-like filament, running and branching in every direction, containing spores within the threads as well as outside.

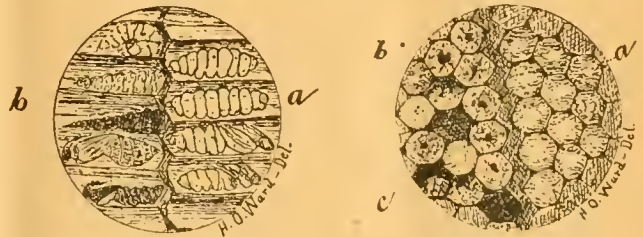

Fig. 5.

Fig. 6.

Fig. 5—Contrast between the White Fungus disease and Foul Brood—profile, natural size. a, dead or pickled brood from the white fungus. b, dead brood from foul brood.

Fig. 6—Difference between normal caps, or those over the white fungus, and foul brood—surface, natural size. a, white fungus, or normal. b, caps with the ragged hole near the center as found in foul brood. c, partially removed cap exposing mass within.

34), which he found to attack the brood when the first feeding of pollen takes place. This trouble has been mentioned by many writers in the bee-papers, and many questions propounded by my correspondents regarding its nature and cure.

I have recommended, with successful results, placing the bees on full sheets of foundation, confining them for three days (giving them plenty of water) in order to consume all of the infected material, that none of it might be deposited in the new combs to be covered with new pollen or honey. The disease is infectious and may be carried by robbers having access to infected combs.

Pollen is a favorable medium, and the warm, damp, dark cellars, in which bees are wintered, in the Northern climate, give the proper conditions for the growth, and moldy combs result.

When pollen is added to the liquid food, which occurs late in larval life, there being a sweet semi-liquid mixture, the proper medium is present for the growth of the fungus, which at once starts a ferment in the alimentary canal of the larva, breaking through and permeating the entire liquids of the body, giving an acid reaction (chemical analysis proves the presence of acetic acid, or vinegar). This growth takes place generally within three days, the brood dies slowly, keeping up for some time a wriggling motion.

When no more food (sweets) is taken, the medium is soon exhausted and the fungus ceases to grow; the acid condition of the brood prevents the growth of putrefactive germs from the air, so that decomposition does not take place, hence no foul odor, the brood is *pickled in its own liquids*.

It has been the earnest endeavor of the writer to throw as much light on the natural history of this disease as possible with the facts before him; and to give it in plain language so that all may understand that read; hoping that those who are in trouble may devise some practical means of escape.

Mr. J. W. Stahmann, of Weaver, Minn., has just sent combs containing specimens of this disease, from which the drawings (Figs. 3 and 4) were made. He has been asked to contribute his experience with this disease to the readers of the American Bee Journal.

Below will be found the differential diagnosis of this disease and that of "foul brood:"

FOUL BROOD—CAUSE, *Bacillus Alvei*.

"Introduced from without to the healthy brood; the food provided by the nurse-bees, being a nutrient medium (proper soil for growth,) active growth at once takes place; poisonous compounds result, and death of the brood may result from these, the germs themselves, or their combined action." (Author's "Foul Brood," page 10.)

SYMPTOMS AND COURSE.—Brood is attacked at all ages from two or three days up to after being sealed. McEvoy says, "More brood dies of foul brood at the ages of 6, 7, 8 and 9 days than at any other age." (Author's "Foul Brood," page 46.) As much brood dies before the feeding of pollen begins as afterward. The dead brood is attacked by the putrefactive germs from the atmosphere, causing rapid decomposition, producing a ropy, brownish-black mass, and giving off a very foul odor. The cap in sealed brood is nearly always ruptured near the center (Fig. 6, *b, c*) by the accumulation of the foul gases generated within the cell; the rotten brood lies in a shapeless mass at the lower side of the cell. (Fig. 5, *b*.) When the mass dries it becomes harder and tougher than the wax (Prop. IV, Author's "Foul Brood," page 18), and cannot be detached, without injury to the comb.

When *bacillus alvei* (Fig. 1, *a, b, c*) is planted on nutrient gelatine, or a cooked potato, and placed in a moist chamber, growth at once takes place, forming a viscid, ropy liquid, slightly alkaline in reaction, giving off an offensive odor resembling that of "foul brood," and when exposed to the air, putrefactive germs attack the culture and soon over-run it.

WHITE FUNGUS—*Aspergillus Pollini*.

A mold introduced to a healthy colony from moldy combs or pollen (Fig. 3), which when mixed with the liquid food

composed mostly of honey and water, a ferment takes place and vinegar is formed in the stomach of the bee, the combined action of the mold and the ferment destroys the life, as above mentioned.

SYMPTOMS AND COURSE.—Brood is attacked only after the pollen is mixed with the liquid food, and dies just before arriving at the pupa stage, generally; sometimes passes into this stage and is sealed. No brood dies before the age of feeding mixed food arrives. The dead brood being in an acid or pickled condition, it is not attacked by the putrefactive germs from the atmosphere. No decomposition takes place, there is a watery (not ropy) condition of the brood when broken up, sometimes of a light-brown color, generally white, giving off *no odor*. The cap in sealed brood is not ruptured (Fig. 6, *a*). The dead brood has a swollen appearance (Fig. 5, *a*), and when dry does not stick to the comb or cell, and often does not lose its shape.

When *Aspergillus pollini* (Figs. 3 and 4) is planted with the combs in water, or the brood on plates partially submerged in sweetened water mixed with starch or wheat-bran, placed in a moist chamber in a dark room, growth at once takes place, and in 3 to 4 days covers the medium, converting it into an acid solution. When exposed to the air putrefactive germs do not attack the culture. Ft. Worth, Tex.

[Dr. Howard's book on "Foul Brood" we mail for 25 cents, or club it with the Bee Journal for a year—both together, for \$1.10. Every bee-keeper ought to have that little book.

For further reference to "Pickled Brood," see editorial on page 584.—EDITOR.]



Shipping Comb Honey Safely by Freight.

BY W. Z. HUTCHINSON.

The season for the shipping of comb honey is upon us, and great is the sorrow when the honey reaches the market in a broken condition. Much can be done by the shipper to avert this dreaded catastrophe. The advice given in the following editorial copied from the Pacific Bee Journal, is most excellent:

"The loss of our beautiful comb honey by breakage in shipment and the ruined condition of the home market caused by the damaged condition of our honey-packages has led me to try to better the method of handling this tender article, comb honey. I have often witnessed the forced sale of damaged honey, and in almost every store that I visited last summer I found a quantity of this leaky, case-daubed comb honey.

"Brother bee-keepers, arouse yourselves and put up your honey right. The first step is to produce the article in correct shape by having the combs built solid to all four sides of the section, and to do this to a certainty, two strips of starters must be used. One large strip at the top of the section and a small one at the bottom, perfectly fastened to the section, and there to stay. The Daisy foundation fastener is the best machine for fastening foundation in sections that has yet come to my notice.

"Secondly, to get evenly built combs, we should use the slotted-wood sawed separators, and then the cappings of the honey will not scrape off in shipping. I hope that there is no such thing as the packing of broken honey, but I am oftentimes tempted to think there is, for the reason that there is so much damaged honey on the market.

"Extreme care should be exercised in packing, to see that the honey is all of a thick, ripe grade, in perfect condition, and strongly built. If there is any unfit to ship long distances, use it at home, put it back in the hive, or dispose of it in the home market. Don't allow it to get mixed with the long-distance honey, for this damaged honey means low prices for all, and the ultimate refusal of the dealers to handle it.

"To gain the best results in shipping comb honey, it should be well cured, and to gain this end it may be kept in a very warm, dry, well-ventilated room for at least four weeks. The temperature nearest 100° will do the best curing.

"Shipping-crates should be made to hold four or five 20-pound cases to insure the most care in handling by freightmen. The practice of shipping comb honey in single 24-

pound cases, that can be easily thrown about, is a mistake, especially in small or less than carload shipments. The crate is made much the style of a one-piece section crate, of light lumber, but in such a way as to be strongly nailed and large enough to allow of packing of straw or shavings, which will surely give a spring jar instead of a thump when the case is handled. The head of the crate is made of two thick boards just the size of the lid of the honey-case. If you use a 24-pound case, which shows four sections through the glass, the size of these head-boards are 12 by 18 inches and one inch thick. One of these boards is laid on the floor and on it is placed a layer of straw, then five 24-pound cases of comb honey are set on it and the other head-board goes on top of all, with a little packing underneath. Now the thin crate strips are nailed to the head-boards at each of the four corners, making your crate complete.

"The crate is then marked with a request to place it lengthwise in the car. Now this crate gets a better handling on account of its size and weight, because it is too heavy for one man to lift, and is either handled by two men or by hand-truck."

I think that the editor of the Pacific Bee Journal is correct in thinking that much honey is shipped that is not in a fit condition to stand a long shipment, and that it better be sold in the home market. I would use a larger crate than he does, one that would require the strength of two men to lift and handle it. If handles are furnished they will be used. A crate holding about 200 pounds is the size I have used, and would ask for nothing better. It is possible that a smaller crate would work just as well, but there is nothing like actual experience.—Review.



The Proper Amount of Stores for Winter.

BY G. M. DOOLITTLE.

I have concluded to take the following from a correspondent's letter, which has just come to hand, as a text for an article in the American Bee Journal, as it comes at a time when we should be preparing our bees for winter.

"How much food does each colony of bees require, in order to winter successfully? I notice that some claim that good, strong colonies can be wintered with as little as from 6 to 10 pounds, while some of the 'doctors' in bee-culture say that 50 pounds in a hive is better than anything less. Which am I to believe? and what am I to understand by this great difference of opinion?"

The above questions remind me of my early days in bee-keeping, and how perplexed I used to be to know what was right and what was wrong, in that which I read in the different papers on bees. These things are often very confusing to a beginner, and I do not wonder at it; but, as a rule we can find grounds for charity when we come to understand that the writer of an article in any of our periodicals cannot well go into all of the minutia connected with his or her subject, because it would make too long an article for one number or issue of such periodical; and "continued stories" do not seem to be just the thing for a bee-paper. That none need be thus confused, my advice to all beginners would be, that they purchase one or more of our valuable books on bee-culture, and in these they will find the most, if not all they want to know about spoken of at length, and the reason for the writer's opinion given, so that they can form an opinion at once whether the writer's views are correct or not. With these words of explanation, I will proceed to answer as best I can.

While I do not think that 50 pounds of honey should be required to winter a colony of bees, under any condition, yet the amount required depends very largely upon the location, whether the bees are wintered in the cellar or on the summer stand, and upon what is meant by "winter." It will be plain to all, that more stores would be required to winter a colony where winter held its sway from the middle of October to the middle of April, as it does in some of our most extreme North-

ern localities where bees are kept, then would be required in some Southern localities where winter does not last over two months. If I understand aright those writers who claim only a small amount of honey for winter, their idea is to give only enough honey during the winter months *proper* to supply the "fuel" required to keep the colony warm, and not to supply them food for brood-rearing in the spring. They argue that this scanty supply of food tends to make the bees retrench, and so they would use this supply *only* for fuel, and thus early brood-rearing, which is considered by many to be of no advantage, would be done away with, thus wintering our bees at little cost, and at the same time place them in a condition which is most conducive to their prosperity. But these persons did not calculate that the supply given them in the fall was to last them till honey was gotten from the fields in the spring, for they generally tell us that they have a supply reserved, to fall back on when the supply given in the fall becomes exhausted.

The only thing which I see against this "short-store" plan, as put forth by its advocates, is, that in our locality the bees might run out of supplies at a time when it would be impossible, on account of protracted cold, to supply their wants, thus increasing the probability of loss to those who are a little inclined to be careless with their bees.

Years ago, when I first began to keep bees, I thought that each colony wintered on the summer stand should have at least 30 pounds of honey to carry them from the first of October to the first of May; but after repeated trials I am fully satisfied that 20 pounds is just as good as 30, and I find that not one colony in 25 will consume 15 pounds during this time. The only reason for giving the 20 pounds instead of 15, lies in the fact that the bees will retrench when their stores are becoming low, just as the advocates of the scant-store plan tell us; and if this retrenching comes when the bees ought to be rearing brood in the spring, then we are losing largely by not having honey enough in the hive to keep brood-rearing prospering as it should.

I claim that all colonies wintered on the summer stands should have at least 10 pounds of honey in their hives the middle of April, in this locality, to give them the confidence they need to start out aright for the season; for with this amount of stores they will not feel the need of retrenching, but will push brood-rearing on rapidly. If they can be wintered on five pounds up to this time, so much the better; but, if at this time they do not have plenty of honey it should be supplied to them in some shape.

For cellar-wintering I allow five pounds less honey than for out-door wintering, finding that, as a rule, 1½ pounds of stores per month is the average amount consumed by the bees while in the cellar.

Now where we feed our bees, no matter how done, I find that it can be done to better advantage in the spring than in the fall, for the bees will go to brood-rearing with renewed vigor where fed; and for this reason I would say, give the bees only enough to safely carry them through to May, then supply their wants by feeding the amount you would otherwise have given them in the fall. The amount which I think right in this locality, I have given above.

In feeding in the spring, care should be used not to feed so plentifully that the combs will be filled with the feed instead of with brood, for it is brood we are after at this time of the year, not stores.

Borodino, N. Y.



The McEvoy Foul Brood Treatment is given in Dr. Howard's pamphlet on "Foul Brood; Its Natural History and Rational Treatment." It is the latest publication on the subject, and should be in the hands of every bee-keeper. Price, 25 cents; or clubbed with the Bee Journal for one year—both for \$1.10.

The Flat-a-Top Comb Honey Super System.

BY S. A. DEACON.

DR. MILLER:—I believe that some difference of opinion exists between Mr. E. R. Root and yourself, concerning the fixing up of sections in the supers. You favor the T tin rest; Mr. Root the section-holder. In an eager desire for improving our fixtures, and for facilitating our operations, it has always seemed to me that we show too much proneness to renounce simple, *though heretofore perfectly satisfactory devices*, for something more complicated, and too frequently overshoot the mark; it seems to be in the nature of most of us to be always desirous of exercising and exhibiting our ingenuity in connection with our pursuit. Some new devices do certainly "catch on" at least for a time; the majority of the fraternity that is to say, if the new device has any merit in it at all adopt it, and perhaps like it immensely for a time, till objections to it, one by one, on this point or on that, manifest themselves, and in the end the pile of obsolete bee-keeping furniture in the backyard grows sensibly bigger; the whim for trying something new has been indulged, and without venting vain regrets on the loss of time and cash expended on its indulgence, we gladly return to the more simple old methods, and with a mind more appreciative of their efficiency than we had when, in our conceit and desire for fame, we contemptuously turned our back upon them. Am I not right? Let me give one instance, in my own experience, and in connection with this matter of fixing sections in the supers.

Like most beginners, I was decidedly ardent, sanguine, and enthusiastic. I made my own hives, and then ordered some thousands of 2-inch sections. But my own made hives were far from satisfactory, so hearing of the dovetailed hive and its very moderate cost, I decided to drop amateur carpentering, and so ordered a lot of these. From various causes, drouthy and otherwise, my 2-inch sections remained for a deplorably long time unpacked. One fine day it dawned on me that the dovetailed hives only accommodate $1\frac{3}{8}$ -inch sections. Here was a dilemma! With very slender means I could not afford to waste my 2-inch ones, so I boldly determined to cut them down. Reducing their general width by $\frac{1}{2}$ inch with a plane was easy work enough, but this narrowed the slots, and after rasping and cutting some 300 of these open with a knife, I gave the task up in despair, and recklessly ordered some thousands of sections to fit the section-holders, *i. e.*, $1\frac{3}{8}$ inch, and relegated the now useless 2-inch ones to the lumber loft.

As I and my bees were kept in idleness for months (waiting not for "the clouds to roll by," but for them to *roll up*), after these narrower sections reached me, I had nothing much to do beyond studying the theoretical part of the business in which I had so enthusiastically embarked, and I had not gotten very far with my books and papers ere I made the discovery that wide sections were quite disapproved by the more experienced old hands, and that no sensible bee-keeper should ever think of using sections wider than "7 to the foot." Of course! I saw it at once; a section full of honey is a section full of honey, and will fetch about one price whether it holds 13 ounces or 16. So having still a few dollars left, and fully seeing the advantages to be derived by the bee-keeper from mulcting the honey-consuming portion of the public of two or three ounces per section, I at once (quite regardless of the rather important fact that the section-holders would not accommodate them) sent off an order for several thousand sections "7 to the foot." Only when I came to fit them in the "holders" did it occur to me that I had *again* made a donkey of myself, and with rueful face I saw my little capital diminishing, and this new lot of sections sent to keep company with their bigger brothers in the lumber loft, and where they would about *average* the right width, $1\frac{1}{2}$, though that didn't help me much.

When at last the clouds did roll up, and the longest drouth known to the oldest man began to look like becoming a memory, and my resources were so attenuated as to render the purchase of more sections (to fit these wretched section-holders, and commensurate with the expected honey-flow) quite an impossibility, I devoted many long hours and sleepless nights trying to devise some plan whereby, having only the "holders" for $1\frac{3}{8}$ inch sections, I might utilize these thousands of obsolete 2-inch and much belauded 7-to-the-foot ones. I once thought I had solved the matter, when I read your statement that the T rest had, amongst other advantages over the "holder"—that with the T rest *any* size of section could be used. I moodily opened my purse and took stock of the few coins hiding about in its folds and corners, and was on the eve of shaking them all out and investing them in T tin rests, when it struck me that Root's supers "weren't built that way," and that if I substituted T tin rests for holders I should have to cut them down half an inch or more, and so spoil them for extracting some day with the shallow frames; so I was foiled again!

I then started wondering in what way sections were fixed in supers before the restless ingenuity of the honey-producer conceived these tin rests and holders. I called to mind certain wood-cuts of sections in crates, both in books and in illustrated price catalogues. A pile of these was soon before me, and my joy was unbounded, and my troubles at an end, when my gaze rested on a wood-cut in "A Modern Bee-Farm," by S. Simmins—of "Simmins' Simple Rack;" and when I read on page 90, as follows—"This rack is very simple, has no bottom rests at all, and allows the sections to stand close upon the frames, and upon each other. Nothing can excel the simplicity, and, at the same time, the efficiency of this arrangement. Practice absolutely confirms the fact that by dispensing with these useless passages, the surplus stored above the brood-nest is largely augmented"—"Eureka!" I cried; and now 2-inch, $1\frac{3}{8}$ and 7-to-the-foot are all ready in these simple racks for the coming flow; and I don't care a two-penny bit if I never see a holder or a tin rest again—I've no use for them myself.

I must tell you, though, that I didn't make my racks quite as shown in Simmins' sketch. I have the presumption to think that I very decidedly improved on Mr. Simmins' plan. What I did (and, *with your approval*, would advise others to do, who wish to try various widths of sections, as also to test the correctness of Mr. Simmins' assertion about more honey being gotten by placing the sections right flat on top of the brood-frames, and the next tier right flat on top of that)—I say what I did was this: I made—let us call it a box without top or bottom; it takes just 3 sections crosswise (*i. e.*, $12\frac{3}{4}$ inches wide, inside measurement), and $19\frac{1}{2}$ inches long—also inside measurement. Its height is just that of the sections— $4\frac{1}{4}$ inches. The ends are of $\frac{1}{2}$ -inch deal, and the sides $\frac{3}{8}$, and it weighs—nothing—or nothing to speak of. One end-piece has two thumb-screws. (One can buy a "screw-box" for a dollar, and make one's own screws—they often come in wonderfully handy.)

This rack holds 33 7-to-the-foot sections, and a $\frac{3}{8}$ -inch follower, against which the screws work, making everything as taut and compact as you like, and you can fill it with any width of section you've a mind to. It costs about 3 or 4 cents for lumber and nails. To fill it, screw up, and then to handle it, is quite a pleasure, amounting almost to fascination, so light, snug, handy and taut does it feel.

But now, Doctor, I want to know what *you* have to say about this "flat-a-top" system, this "no spaces" system—*i. e.*, no spaces or bee-way (which I have never as yet found in the insects' natural habitat—the hollow oak-tree) between the brood and honey, and between tier and tier of sections, all of which is quite opposed to Nature. Such a rack just fits the 8-frame dovetailed hive.

Now, why couldn't honey-producers have been content with this simple style of section-rack, but must needs go complicating matters with these holders and tin T rests, and what not, until it has become almost as easy to acquire a thorough knowledge of the anatomy of the human subject as that of the multifarious parts of the present-day domicile of the busy bee.

Bear in mind that in this "flat-a-top" rack system, the lid also fits plump down on top of the upper tier of sections. Now *must* there, in your opinion, be an air-space between the top tier of sections and cover? If so, why so?

South Africa.

[The foregoing letter to Dr. Miller was written some months ago, and should have appeared before, but somehow it was overlooked among other manuscripts in this office. Here is Dr. Miller's reply to Mr. Deacou's letter:—EDITOR.]

Mr. Editor, I'm very glad to give my opinions, so far as I have any, upon the points mentioned in Mr. Deacou's very interesting letter. If he had been present when I read it, I'm afraid he would have thought I wasn't very sympathetic, but as he was away off in Africa, where he couldn't hear me, I took the privilege of laughing heartily over his tribulations, or perhaps more properly at his way of relating them.

With regard to the general accusation as to the desire to invent and adopt something new just because it is new, or of one's own invention, I may say that the T super is not an invention of mine, and that I have adhered to it without change some 12 years. When I find something enough better to warrant a change, I may change, but it will be only after thorough trial.

With regard to the section-rack you describe, Mr. Deacon, you set me an ungracious task to give an opinion about it, well knowing something about the feeling that attaches to an article one has settled down upon as all right, especially after one has added to it one's own "improvements." So I'll go at it carefully and say what I say *gradually*.

The rack you mention is an excellent thing, a thing well calculated to fill one's heart with delight—and the delight that a bee-keeper feels in new and improved appliances can only be fully understood by him who has experienced it—I say, the rack is an excellent thing, and a delight as compared with the old way of brimstoning the bees to get the honey.

And yet many a good thing has objectionable points, and one trouble with this simple rack is that when one part sits directly upon another without any bee-space between, there is some danger of killing bees, so some bee-keepers would prefer another kind of super. Indeed, after you had left brimstoning the bees and had for a time manipulated these racks you would take great pleasure in inventing an arrangement by which the sections would be safely held at a proper distance from the top-bars and from each other. Although I have much respect for the opinions of Mr. Simmins, I don't believe many practical bee-keepers could be induced to use such racks.

"Continuous passage-ways" had, a few years ago, something of a run in this country among a few, but nowadays no one says anything about them, and they seem to have fallen into disuse. It sounds very well to say that with continuous passage-ways the bees going directly from one part to another, they will do more and better work than where they have a lot of vacant space to cross, but in actual practice the bees don't seem to show any difference. Indeed, I've had them work across a space of an inch and a half of wood and air with apparently as good results as if no such space were present. Just think a minute. A certain number of field-workers bring in a certain amount of nectar in a day. Will that be increased or diminished because the house-keepers must carry it half an inch farther?

Your new machinery works to perfection, charmingly—when no bees or bee-glue are in the case. In practical use with the bees it's quite another thing. You'll find it a slow

job to place a rack of sections on the top-bars or on another rack without killing bees. Theoretically, there's no place for bee-glue when one surface sits directly on another. Practically, there will be a lot of it on all edges, corners and cracks. For there will be plenty of cracks. You can't fill up a rack of sections so true and even that it will sit on another with not the least space between at any point. And the bees will find and fill a space that you may not have noticed. Then when you have all screwed up just right with your thumb-screws, you'll find that by shrinking or swelling sometimes the sections will drop out, and sometimes the thumb-screws can hardly be worked because everything is so tight.

On the whole, the best thing is to use such racks for kindling wood, and get a decent super that will always work right, even if it does cost a little more. And don't think of getting along without a full space for bees between sections and cover. The worst gining I ever had on top of sections was when I had a cloth fitting close down on the sections. A board wouldn't allow so much gining as a cloth, but it would kill more bees.

C. C. MILLER.

Questions AND Answers

CONDUCTED BY

DR. C. C. MILLER, MARENGO, ILL.

[Questions may be mailed to the Bee Journal, or to Dr. Miller direct.]

Carrying Bees Out of the Hive.

I have 70 colonies of bees, and quite a large number are carrying off bees from the hive. I cannot see anything wrong with those they carry out. I have seen them carrying out some before, but never to the extent they are at now. What is the cause, and what can I do about it? W. H. F.
Lake City, Mo., Aug. 14.

ANSWER.—I'm sorry to say that not only am I ignorant as to what ails the bees, but if I did know I don't know any remedy. The only thing that I know of in which bees are likely to carry off from the hive of their sisters is bee-paralysis, and as yet no one seems to have found a remedy. But with paralysis the bees have a black and shiny appearance, and you say you cannot see anything wrong with those carried out, so I suppose you mean they are fully grown bees. In starvation the bees may carry out brood, but that's a different thing, as is also the carrying out of drone-brood at the time drones are driven out. [See "Bee-Paralysis," page 585.—ED.]

Frame Spacers—Comb Honey Hive, Etc.

1. Is there a good, practical spacer to separate the brood-frames? My hive is made here in Vermont, and is called the Dovetailed hive. It is 10½ inches deep, 12½ wide, and 18½ long, inside measure. It contains 9 frames. The top-bars are one inch wide all the way across, and no way of spacing them but by my eye. The hives are carried into the cellar after we go back to Chicago, and I am afraid the frames will be misplaced without any spacer.

2. Is this the best hive for the production of comb honey? If not, what hive do you recommend as the very best? What is its size, and price?

3. Or could I get a different frame for my hives, which will space itself? I had one of Root's Dovetailed hives sent to me a few weeks ago, but the frames are longer and not so deep as mine, so that I cannot use it. MRS. J. J. G.
Littleton, N. H., Aug. 13.

ANSWERS.—1. Yes, there are a good many spacers. The Stephens spacer is good. Some use furniture nails. I have

used with satisfaction a common $1\frac{1}{2}$ -inch wire-nail with a head about $\frac{3}{16}$ of an inch across, driving it in to the proper depth. If, as is probably the case, the ends of your top-bars rest on the wooden rabbets, you need have little fear as to their being displaced on being taken into the cellar. The bees have in all probability seen to that already, and have glued them down so tightly that little short of turning them upside down will be likely to displace them.

2. Perhaps there is no "best hive" for comb honey or any kind of honey. Nearly all will give good results with good management and good conditions. But it is a matter of some consequence to get one of the standard hives, so that you can at any time be able to order from any dealer hives or parts of hives, as you may desire. Moreover, the hives commonly in use are made in large quantities by manufacturers, consequently they can be sold at very low prices. One of the most popular hives at present is the Dovetail, but I didn't know there was more than one kind called by that name, and the dimensions you give are certainly not the dimensions of the regular Dovetail hive.

3. No doubt you can have frames made to fit your hive that would be self-spacing, such as the Hoffman frame, but rather than continue with an odd-sized hive, if you have yet only a few, would it not be better to adopt a standard size? The great thing is to have a frame of standard size, and the frame that you got in the Root Dovetail hive is probably more nearly standard than any other. This frame is $17\frac{1}{8}$ by $9\frac{1}{8}$ inches, outside measure, and I think you must be mistaken about its being longer than your frame, for you say the length of your hive is $18\frac{1}{4}$, and that of the Dovetail is only $18\frac{1}{4}$.

Taking Care of Queenless Colonies.

I have been looking through my colonies of bees to-day, and I find three colonies without any brood in their combs, and not many bees, either, so I thought that they must be without a queen. I did not know what to do, as I have no extra queen on hand, so I took one frame of brood from three other hives for each one of these three colonies. I have 40 colonies in all. Do you think they will start queen-cells and save the colonies in that way? or will I have to buy new queens for them?
L. N. M.
Rossville, N. Y.

ANSWER.—The probability is that in about three weeks from the time you gave the brood each of them will have a laying queen. That will be proof that you did the very best thing in the case. If your other colonies are strong, and can spare some more brood, it may be well to give to each of these three two or three more frames of mature brood, thus keeping up their strength till the young brood hatches out.

Lysol—Bees Starving—Feeding.

On page 408 lysol is spoken of for curing foul brood. In what way is it used, and what is it? I have asked our druggist about it, and he does not know what it is. Where can it be obtained?

There is something wrong with my bees. At first I saw them carrying out dead bees. I looked into the hives and found about two-thirds of the brood unsealed, some pretty nearly matured in that condition. What is the cause of their not sealing it? I thought it was on account of being a weak colony, but upon putting some of it into another it became infected the same way.

I notice another in the same condition. I can detect no smell as in foul brood. They keep the dead bees out at the sacrifice of the honey. I am feeding these three colonies now, or they would have starved. What do you think ails them? As I am short of honey what can I feed to winter them on, without danger of dysentery?

I forgot to say that about all the brood that the bees seal up matures and is apparently healthy.
E. S. S.
Atchinson, Kans., Aug. 17.

ANSWER.—I doubt whether you need be very much interested in lysol. Your bees probably don't need lysol so much as

honey or sugar. From the account you give, it seems to be a case of starvation. When stores become scarce, one of the first effects is to lessen the laying of the queen, then the youngest of the brood is sacrificed, then the older brood is sucked out, and you may see the white skins thrown outside the hive.

If you have no honey, the best thing you can feed is granulated sugar. Better feed early, and if you don't put it off too late the most convenient way is probably the crock-and-plate method repeatedly described in these columns. Take a gallon crock—of course a different vessel of different size can be used—fill the crock perhaps $\frac{3}{4}$ full of sugar and put in a pint of water for every pint or pound of sugar. The water may be cold or hot. Lay over the crock two thicknesses of flannel or six thicknesses of cheese-cloth, and over this put a plate upside down. Put one hand under the crock and the other over the plate and quickly turn the whole business upside down, giving it a shaking so that the sugar may fall to what is now the bottom. Now set it in an empty, bottomless hive on top of the hive to be fed, and cover up so no robbers can get in, and the bees will do the rest.

To come back to your first question, lysol is one of the disinfectants that acts much as phenol or carbolic acid, and is fed in very small quantities in the food of the bees. Some report favorably of it, others not. Any druggist can get it by ordering from his wholesale house. It is "a saponified product of coal-tar containing cresol."

Not Hive-Bees—A Cracker-Box Colony.

1. My wife writes me from New York State that her nephew has discovered a curiosity, or, I may say, a swarm of curiosities. A swarm of bees which she says looks just like my bees, except perhaps their bodies are a little more flat at the extremity, seem to be working in the ground, are bringing out dirt and building up a large mound. Do the common bees ever do this? or are they a distinct species? Seems to me I have read of such bees somewhere, and that they could not be domesticated.

2. I have a neighbor who has a fine swarm of bees in a cracker-box, and they have it nearly full of comb, filled with brood, which I can buy cheap. The comb is crooked and in poor shape to cut out and put into frames. Can I put frames of foundation into a hive and set the cracker-box on top and compel or coax them to go below and work, and abandon this cracker-box when they get the brood hatched out? Or will she lay in both places?
H. W. C.
Weeping Water, Nebr., Aug. 15.

ANSWERS.—1. There are a great many kinds of wild bees, and some of them very closely resemble in appearance the common hive-bee. The bees you speak of are certainly not hive-bees.

2. Doubtful if you can get the queen to desert her cracker-box this year. But next summer she may listen to your proposal for a change of domicile. Let her winter where she is, then next summer you can do as you propose. When the cracker-box is entirely filled and more room is needed, then the bees will work down upon your foundation, and as soon as you find the queen there you can remove the cracker-box or else put an excluder between the two stories. In three weeks all the brood will be hatched out and the box can be removed, unless you prefer leaving it to be filled with honey which will not be in very nice shape. Besides its crooked shape it will be in old combs and more or less mixed with bee-bread.

A New Binder for holding a year's numbers of the American Bee Journal, we propose to mail, postpaid, to every subscriber who sends us 15 cents. It is called "The Wood Binder," is patented, and is an entirely new and very simple arrangement. Full printed directions accompany each Binder. Every reader should get it, and preserve the copies of the Bee Journal as fast as they are received. They are invaluable for reference, and at the low price of the Binder you can afford to get it yearly.

PERSONAL MENTION.

MR. I. ISAAC IRWIN, of Oceanside, Calif., shipped 10 carloads of San Diego county honey to Liverpool, England, during the past year. So says the San Diego Sun.

MR. M. M. BALDRIDGE gave us a call of a few minutes last week. He reports about half a crop of honey in his locality—Kane county, Illinois, about 40 miles west of Chicago—mostly from sweet clover.

MRS. A. A. SIMPSON, of Greene county, Pa., has sent us a copy of "The Woman's Centennial Paper, 1796-1896," all of which was gotten up by prominent ladies of that county—especially of Waynesburg. It is indeed a real credit to the ladies who undertook the work, and carried it out so completely.

MR. J. T. CALVERT, of The A. I. Root Co., made this office a call last week. He was on his way to St. Paul and other places, visiting the various bee-supply branches established by The A. I. Root Co. He reports a good business done this year at the home office in Medina, Ohio. Mr. Calvert also called upon other dealers and manufacturers of bee-keepers' supplies while out on his trip.

MR. C. THEILMANN, of Theilmanton, Minn., was in Chicago last week, looking after a large shipment of honey that he had sent here. He has had a fairly good season this year, having had between 12,000 and 15,000 pounds of comb honey. He expected to make an exhibit of about 500 pounds at the Minnesota State Fair, held at Hamline the past week. Shouldn't wonder if he would capture some of the premiums offered there.

DR. MILLER now reports in Gleanings that he has one colony that this year has given 8 supers of 24 sections each—192 finished sections of honey. Think of the Doctor paying *all* his expenses attending the Lincoln convention, from the profits of one colony of bees! Yes, and he'll have enough left over to take himself and A. I. Root to hear "Sweet Marie," at the "variety show," if Lincoln tolerates such things. Probably either Mr. Whitcomb or Mr. Stilson will find time to see that the Doctor takes in all the sights while in "Bryantown"—if not possible during the golden sunshine of day, then in the silver-y moonlight.

MR. J. O. GRIMSLEY, of Texas, suggests in Gleanings that another bee-keepers' congress be called to meet during the Tennessee Centennial, at Nashville, which opens in May, 1897, and continues six months. We might be in favor of the National convention being held there next year, if as low railroad rates can be secured, and as general, as the Grand Army of the Republic always secures. But we are not in favor of holding any more national bee-conventions until we can be assured in advance that there will be no doubt that at least a rate of one and one-third for the round trip will be in force. Few can afford to spend from \$20 to \$50 to attend a bee-convention.

MR. FRANCOIS S. HAARHOFF, of Pretoria, South African Republic, says in Gleanings that modern bee-keeping is but little practiced there, but that the farmers are beginning to awake to their opportunities in the bee-keeping line. Pure honey, either comb or extracted, sells readily at 60 cents per pound, or section. With a good, big honey-crop each year there, it seems that a bee-keeper would soon feel like singing, "Every Day'll be Sunday By-and-By." Let's see. With 100 colonies like the one of Dr. Miller's that produced 192 sections of honey this year, there would be 19,200 pounds; at 60 cents per pound—well, something over \$11,500. How inspiring those figures are!

MR. RODERICK MCKENZIE is a bee-keeper at Hammond, Ind. We called on him on Saturday, Aug. 29. He has about 80 colonies, having had 40 colonies to start with in the spring. He expects to get half a ton of honey, mostly in the comb.

Mr. McKenzie uses two-pound sections, and some one-pounds. He thinks that a two-pound section is filled almost as quickly as a one-pound. He uses only a small comb foundation starter in each section, about $\frac{1}{2}$ inch deep, and reaching within about $\frac{1}{4}$ of an inch of the sides of the section. We were surprised to see how well the completed sections of

honey were fastened all around. Some of the two-pound sections of honey weighed 28 ounces each. He finds just as ready sale for such as the one-pounds.

Mr. McKenzie's bees are hybrids. There are other apiaries very near him. One is owned by Mr. F. Furnival, about 20 rods away. This has some 60 colonies. Then Mr. W. B. Washington has about as many a mile from Mr. McKenzie's. They all think that the locality is somewhat overstocked, and that some one will have to move before very large honey-crops can be harvested there.

Hammond is a city of 15 to 20 thousand people, about 25 miles southeast of Chicago, and is connected with the latter city by an electric street railway. It is about a two-hours' ride, and makes a nice afternoon outing. Before returning to the city Mr. McKenzie's good wife kindly prepared a delicious supper for us, after which we again took to the street-car, arriving home about 9 o'clock, p.m., as we live about an hour's ride on the street-car north of Chicago.

Many fall flowers were in blossom all along the way, mainly golden-rod, horsemint, etc. Sweet clover does not seem to do well there; perhaps on account of a too sandy soil. If the weather is propitious the fall honey-crop may be very good. This is what the Hammond bee-keepers depend upon. We hope they may yet have a good honey-flow.

MR. WM. M. BARNUM, who for some time answered questions in our "Question-Box" department, is now the editor of Colman's Rural World, of St. Louis, Mo., a fine agricultural periodical in newspaper form. In a recent number Mr. Barnum had this to say about the American Bee Journal, for which he has our thanks:

"Our bee-keeping friends should send for a copy of the 'old reliable' American Bee Journal. Every number is filled to the brim with practical apiarian information, including happily worded and well-edited letters from contributors. Every number is worth the price per year to every bee-keeper in the land."

MR. O. O. POPPLETON, of Stuart, Fla., called on us Aug. 31. He was on his way to the Grand Army meeting at St. Paul. He has about 130 colonies, and has taken 100 pounds of extracted honey per colony this year. He practices migratory bee-keeping to some extent, but not so much as before the great freeze in Florida in 1894.

Mr. Poppleton kept bees in Cuba two seasons, a few years ago. Cuba is only 20 or 30 miles across the water from Florida. The first year he had 35,000 pounds of extracted honey, and the second year 52,000 pounds. He had some 400 or 500 colonies. He says there is no limit to the amount of honey that can be produced on that island. Also that the cost per gallon that Cuban honey can be delivered to New York for, is the price that Southern U. S. extracted honey must be sold for in the same market. In other words, Cuban honey sets the price for ours. Hence, if our tariff on honey is higher, Cuban honey will be higher, and so will be ours. But just now there is scarcely any Cuban honey coming into this country, as the war on the island has destroyed nearly all the apiaries, and everything is pretty much at a stand-still.

We enjoyed Mr. Poppleton's call very much. Some 10 or 12 years ago he was one of the prominent correspondents of the American Bee Journal, he then living in Iowa. He is now one of Florida's leading bee-men. He would write more for the bee-periodicals were it not for a trouble of the eyes and head which he contracted during the Civil War.

The Alsike Clover Leaflet consists of 2 pages, with illustrations, showing the value of Alsike clover, and telling how to grow it. This Leaflet is just the thing to hand to every farmer in your neighborhood. Send to the Bee Journal office for a quantity of them, and see that they are distributed where they will do the most good. Prices, postpaid, are as follows: 50 for 25 cents; 100 for 40 cents; or 200 for 70 cents.

The Names and Addresses of all your bee-friends, who are not now taking the Bee Journal, are wanted at this office. Send them in, please, when sample copies will be mailed to them. Then you can secure their subscriptions, and earn some of the premiums we have offered. The next few months will be just the time to easily get new subscribers. Try it earnestly, at least.

OLDEST BEE PAPER IN AMERICA

THE AMERICAN BEE JOURNAL

ESTABLISHED IN 1861

GEORGE W. YORK, - Editor.

PUBLISHED WEEKLY BY

GEORGE W. YORK & COMPANY,

118 Michigan St., - CHICAGO, ILL.

\$1.00 a Year—Sample Copy Sent Free.

[Entered at the Post-Office at Chicago as Second-Class Mail-Matter.]

Vol. XXXVI. CHICAGO, ILL., SEPT. 10, 1896. No. 37.

EDITORIAL COMMENTS.

The North American Bee-Keepers' Association is to hold its 1896 meeting at Lincoln, Nebr., Oct. 7 and 8. Don't forget about it. Good time expected. Better be there. Nebraska bee-keepers will entertain *free* those from other States. How's that for a case of "enlargement of the heart?" Nebraskans are noted for big-heartedness—especially the apiarian part of the population.

The New Disease — Pickled Brood.—Dr. Howard, on page 577, in his painstaking and scientific way has doubtless given a flood of light upon a new bee-disease that seems to be making its appearance in a number of apiaries, and in an editorial in *Gleanings* for Aug. 15, Mr. Root evidently touches upon the same disease, in the following words:

I have several times referred to a malady or disease that somewhat resembles foul brood, but which lacks two of the important symptoms, viz.: that it is not ropy, and there is no appreciable odor of any kind. In most cases it seems to go off of itself; and very seldom does it affect more than two or three colonies in an apiary. I have one instance before me where this dead brood is spreading over the whole yard, and it may be necessary to resort to heroic measures before it can be held in subjection. Samples of the brood have been sent me, and it is neither ropy nor foul—that is, smelling like a cabinet-maker's glue-pot. The sender of this sample of brood tells me that his neighbor has the same thing.

Some speculation has been advanced, to the effect that this dead brood was owing to some sort of poison the bees get. This may or may not be true. I should be inclined to believe that it is some form of disease, and that it is, to a greater or less extent, contagious.

I have seen samples of it in our own yard at various times, but it has invariably gone off of itself, and it rarely affects more than two or three combs in the hive, and only a few scattering cells in each. It has never spread, and comes and goes.

In the case I have just referred to it has gone through the whole apiary. It has weakened the colonies, and the bees appear to be discouraged—so much so that they very soon fall victims to robbers.

I hope some scientist will take hold of this, find the microbe, and name it. In the meantime I trust that our friend, whose name I forbear mentioning, will treat these cases just as if they were cases of real foul brood, and report the result. I hesitate to mention the names of those who have diseases among their bees, without their consent, especially where the disease may be something that may easily be held under control. For instance, when foul brood has once been in an apiary, even though the last vestiges of it have not appeared for years, the mere fact that *it has been in that yard* seems to place a ban upon it for all time in the eyes of the general bee-keeping public.

Editor Root's desire that some scientist would investigate the matter is now gratified, much sooner, possibly, than he

expected. We, also, have lately received several samples of the "pickled brood," from bee-keepers who thought it foul brood. There was no offensive odor about it, as Mr. Root says; but as we had never seen a case of foul brood, we referred the samples to a bee-keeper who has had a real experience with it, and he said at once that the dead brood was not foul brood, but he could give no idea as to its cause, or suggest a remedy therefor.

We trust that where this new disease exists, Dr. Howard's treatment may be used, and reports given as to the results.

Owing to the increasing prevalence of the genuine foul brood, no bee-keeper should be without Dr. Howard's excellent booklet on that subject, which gives both cause and treatment. We mail it for 25 cents, or send it with the *Bee Journal* for a year, for only \$1.10.

C. R. Horrie & Co. Again.—The name of C. R. Horrie & Co. will be pretty familiar to most of our readers, as the Chicago firm that last year so unmercifully swindled bee-keepers when handling their honey. Well, through the kindness of an old friend to the *American Bee Journal*, we are in possession of one of the most flaming and "highfalutin" circular letters we ever saw, which was sent out last month by this same firm of Horrie & Co.

Our readers well know that we are not much in favor of giving free advertisements, but we will break over our rule, and give to the above firm a big, free notice, by publishing in full their "flowery" circular letter, omitting only the displayed heading which besides giving their name says they are commission merchants, dealing in honey, beeswax, etc., at 224 S. Water Street. Here is the printed letter they sent out last month:

CHICAGO, Aug. 22, 1896.

The grandeur of the Flowery Kingdom is made more wonderful to the imagination of man, by the busy bee, who makes the wild rose bow with beauty, as it yields up its sweetness to the ever vigilant master, who refuses to be comforted until all its commercial worth has duly, and deftly been extracted by the untiring genius of this marvelous insect, that has added so much to gratifying the finer tastes of those who are seeking the good things of the world. **The Bee Farmer** is engaged in one of the most laudable enterprises known to this day and generation. Little did our forefathers think it possible that man in time would work, hand in hand with this wonderful creation of God, until all the world pays homage to King B, and calls it great, in cheerful recognition of the fact that there is **nothing sweeter than Honey in the honey-comb.**

In the dark ages when all things were sublimely crude, King Solomon in exalting the beauty and fascinations of the fairest charmer, failed to find words that would fully express his fervent devotion, till he madly exclaimed, in the blindness of his passion, "Thou art sweeter than honey in the honey-comb."

As we are now upon the threshold of another Autumn Season, we feel that it is high time we began corresponding with you in regard to the **Honey Business.** As you have doubtless known us through dealings in the past, it seems very unnecessary for us to introduce ourselves, as we feel that our reputation in the trade generally is a sufficient guarantee of our ability and financial standing.

To begin, we will have a heavier general crop of Honey this year than this country has ever known before, that is, if we can intelligently judge from the communications we constantly receive from authorities in the Honey-Producing Sections. Consequently, we have perfected arrangements that will not only enable us to handle double the shipments of past years, but will also, in many cases, enable us to insure better satisfaction.

We have double the store-room we had before, have made improvements in the way of light and display accommodations, and therefore feel that we can make more ready sales, and although there may have been some parties who did business with us last year who were not quite satisfied, we think, that where complaint was made it was traced to the inferiority of the stock, condition on arrival, or the unfavorable time of shipment.

Late last season, as every one knows, the market

"slumped," but the early sales were, in almost every instance, such as to meet the general approval of the shippers. While there was a heavy crop of Honey last season, the production this year will far exceed anything in the past. The turn taken by the market late last season established a precedent that it will be well for Bee Men to observe. The heavy crops that were thrown on the market in November and December made Honey more common than usual to consumers, and they soon became tired of it, while early in the season they bought freely, and paid good prices. In fact, we could hardly get enough to satisfy the requirements of our trade. We may have a recurrence this year, and we want to advise our friends and shippers not to wait. Put your Honey up in proper shape as soon as it is taken off and ship at once to us. As stated above we have demonstrated our ability to handle Honey, and our better facilities make us an invaluable medium to every shipper who has Honey to sell. So far this season we have received a good many shipments, and we think the parties who have consigned to us are well satisfied with their sales. There is quite a good demand for both Honey and Beeswax, and we are especially anxious to receive heavy immediate shipments of both Comb and Extracted.

If you are not in possession of one of our stencils, or have none of our tags, write for them, and we will forward same immediately upon receipt of your letter. At any rate we would like to hear from you with full information as to what kind of Honey you have, and we could then probably give you closer information than the general facts as mentioned in this letter.

We quote price at which we are making sales :

Fancy, White, per lb.....	15 to 16
No. 1, "	14 to 15
Fancy, Amber, "	12 to 14
Fancy, Dark, "	9 to 10

EXTRACTED :

Fancy, White, per lb.....	7 to 7½
Amber, "	6 to 6½
Dark, "	5 to 5½
Beeswax, "	25 to 27

Although we have repeatedly given you instructions as to how to ship, there are still a few remarks to which we wish to call your attention, so that they will not be overlooked.

"Do not put White and Dark Honey in the same case, unless marked accordingly."

"Do not send us a pound of Honey unless you write or wire about it, stating what kind you have sent, and via what line it was shipped."

Now, no matter what your location is, we maintain that **Chicago is your best market**, and it is verified by the business we have received from the many intelligent shippers in the States of New York, Virginia, Florida, New Mexico, Vermont, California, Utah, Mississippi, Texas, in fact almost every State in the Union. We would advise you to ship by freight, as the rates are not only lower than express, but the Honey usually arrives in better condition.

Remember that our Honey business last year was proclaimed by even our competitors to have been double that of any other house, and we assure you that this large business only came to us through hard work and close attention to the interests of our shippers. It has always been our rule to **keep a shipper after we once get him started**. We endeavor to make him our friend and regular patron, and we will certainly endeavor to do the same by you if given a trial.

Write us if you want a new stencil to mark your boxes with. It appears neater when marked in this way than when tags are used. It is also a good and safe way to take a pencil, and mark the destination on the top of each crate.

We offer the following as references :

The Farmer's Voice Paper of this City; the Wisconsin Agriculturist, of Racine, Wisconsin; The Iowa Homestead, of Des Moines, Iowa; The Shippers' Weekly Review Paper, this City, or in fact any Bank, Wholesale House or Shipper in the country who has done business with us. We are well known, and it will be very little trouble to investigate our standing, if you desire to do so.

We wish you also to remember that in addition to our Honey business we have a fine trade for **Potatoes, Apples, and all kinds of Fruits and Vegetables**, as well as **Evaporated Fruits and Nuts** of all kinds, and would be only too well pleased to quote you prices on anything you desire to make sale of in this market.

You certainly cannot make any mistake by associating yourself with us, as we are the hustlers of this market, and can always do justice to the goods which you may send us.

Our time is yours, and will be glad to accommodate you in any way that we can.

Ship us in your Honey, and get what it is worth.

Yours respectfully,

C. R. HORRIE & Co.

How is that for a breezy letter? Pretty windy, eh? No one but the veriest know-nothing should be "caught" by such a letter as that. And yet, after all we published last winter against this firm, one of our old subscribers, who evidently received a copy of the above letter recently, wrote to ask us if we considered Horrie & Co. responsible!

When they mailed that letter, they knew that the best comb honey was bringing not over 13 cents per pound in a wholesale way. And yet they quoted 15 to 16 cents. Their scheme is, by quoting high prices, to get bee-keepers to ship them honey on commission, which last year in a number of instances they sold for about what they were offered, and remitted the shipper a net price of anywhere from 7 to 10 cents per pound for white comb honey.

Now we hope that none of our readers will fall into any such trap as is set before them in the above letter. Be sure that you have the best of recommendations before placing your honey in the hands of strangers. Better give your honey away around home, rather than to ship it to some city commission men who will take every advantage of you they can.

LATER.—Since the foregoing was written, we have learned that there has been a "ring" formed here among several firms of the Horrie stamp, and that they are all after honey, no doubt thinking that bee-keepers are easily gulled, and that there is a fortune to be made by swindling the confiding beemen. We are told that Horrie & Co. belong to the "ring," which we do not doubt.

Bee-keepers, beware of all strangers who are over-anxious to get your honey. Honest dealers don't have to send out tempting circular letters, baited with high quotations. Again we say, *Beware!*

The Sulphur Cure for Bee-Paralysis.—As noted in our "Personal Mention" department, Mr. O. O. Poppleton, of Florida, has been to see us. Among others the subject of bee-paralysis came up. He said that he has had perhaps the most extensive experience with this disease of any bee-keeper in this country, having had during the past 15 or 16 years about 200 colonies affected. One year in Florida he lost a crop of 10,000 pounds of honey on account of the disease. His experience with it began in Iowa, about 16 years ago, where he had a number of colonies affected. He has tried every suggested remedy, but all to no purpose until he began to use sulphur in treating it in Florida. This is the only thing that brought relief. He began by dusting with sulphur the frames and bees of two or three colonies, and as he saw the bees recover, he treated other affected colonies, and now he can hold the disease in check with little trouble by using the sulphur treatment.

In speaking of the symptoms of the disease, Mr. Poppleton said that the very best description he ever saw in print, was that given by a querist in Gleanings recently, who said:

"The bees seem to be swollen up, many of them, and have a shaking motion, and the well bees are dragging off those the nearest to lifeless, while the dead are quite thickly strewn about the hive-entrance. On opening the hive I find many of these bloated, shaking bees near the ends of the frames, in and about the rabbets of the hive, and in out-of-the-way places. The queen seems to be very prolific; but these trembling, dying bees seem to take the disorder rather faster than young bees emerge from the cells; hence instead of gaining in numbers, as are my other colonies, this colony is dwindling."

Mr. Poppleton says that in the North a colony that goes into winter quarters badly affected with this disease invariably dies before spring. He thinks that may be one reason why bee-paralysis is not so prevalent in the North—each spring there is a new start, while in the South, with their mild winters, the affected colonies do not die out so.

THE GREAT CAMPAIGN

—OR—

Political Struggles of Parties, Leaders and Issues

COMPRISING

**Biographies of the Republican, Democratic,
Populistic, Prohibition and National
Nominees for President and Vice-President
of the United States.**

—ALSO—

The Platforms, Principles and Leaders of All Parties

DISCUSSING

ALL VITAL QUESTIONS OF THE DAY

HAVING AS ITS OBJECT

The Enlightenment and Education of American

—VOTERS—

Upon the Living Issues of the Hour.

The Gold Standard of Currency, Bi-Metalism, Free Coinage of Silver, High Protective Tariff, Tariff for Revenue Only, Prohibition, Licensed Liquor Traffic, the Doctrine of Reciprocity, the Monroe Doctrine, Laws Governing Our Relations with Other Nations, the Venezuelan, Armenian and Cuban Questions. Containing also Lives and Portraits of former Presidents, with a Review of their Administrations and the Political Lessons gleaned from them; together with a Portrait Gallery of Statesmen and Political Celebrities comprising 100 accurate Phototypes and other Portraits, embracing the most active and prominent statesmen in our Nation. The whole forms a Voter's Hand-Book of Political Information, thoroughly practical, enjoyable and instructive, enabling him to vote intelligently upon those vital subjects which constitute the living issues of the present great campaign.

This book embodies the views and opinions of the great leaders from the various party points of view, clearly explaining all the momentous questions now before the people. It is planned upon the broad principles of non-partisan national patriotism, and attacks no man's creed, and upholds the ban-



McKinley.



Bryan.

American citizen. It is a vast storehouse of truth, plain, simple and unvarnished, which makes this work an unequalled source of information upon the great issues of this campaign, suited to the wants of every voter irrespective of party and without partisan bias.

Our Country calls for thirteen million volunteers. "I do love my country's good with a respect more tender, more holy



Levering.

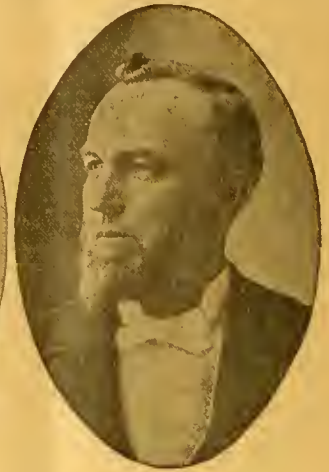

Bentley.

and profound than mine own life," is the language which Shakespeare puts into the mouth of an ideal patriot. May this sentiment find a universal echo in the hearts of the voters of the United States of America who go to the polls in November, 1896.

Great questions are to be settled; a mighty battle is to be fought; a battle of ballots such as this country has never witnessed, which, in its far-reaching effects, will accomplish on the field of American suffrage, at the Ballot Box, next November, results as potential for good or evil to our Nation, revolutions as radical, and effects as lasting upon our institutions, as were ever wrought upon the field where sword and bullet, grape and canister settled the issue of the hour.

An impartial view of the situation reveals the fact that our Country never needed more broad-minded wisdom and unselfish patriotism in all her history than she requires to guide her through the present crisis.

Since the rising war cloud of 1859-60 which deluged our Country in the blood of brothers, our Nation has not been so agitated, divided and excited as it is to-day from ocean to ocean—North, South, East and West, on the great financial question, which is a vital issue of this campaign; and its settlement is fraught with threatenings and omeas indicating political combinations, upheavals and surprises which our shrewdest politicians seem unmindful of or unwilling to recognize.

Since 1873 the mutterings of discontent have been growing louder between the advocates of Gold and Bi-metal standards. During the past three years, these mutterings have grown into clamorous shouts and peremptory demands on both sides. Statesmen never thought so diligently or more deeply on any subject; and the whole country never was so eager to have all sides of this momentous question presented in a clear, lucid and intelligible manner which the common reader can understand—the money question.

The Doctrine of Reciprocity is also treated at length from a broad, patriotic and non-partisan point of view.

This volume contains about 600 pages, is printed on super-calendered paper, and bound in beautifully lithographed board covers. The pictures of the four principal Presidential candidates shown herewith appear on the front outside cover, and the Vice-Presidential candidates on the back cover.

How to Get the Above Book.

Send \$1.00 and receive it postpaid. Or, send us two new subscribers for the Bee Journal at \$1.00 each, and we will mail you the book free as a premium. Or, for \$1.75, we will mail you the book and the Bee Journal for one year. Address,

GEORGE W. YORK & CO.,
118 Michigan Street, CHICAGO, ILL.

ner of no party; but placing every party and its principles, with its leaders upon its own platform, and bringing the several parties, platforms and champions in their true light before the mind of the reader, the intelligent citizen will, in this book, be enabled to view and compare them side by side and judge of their respective claims upon his vote as an

General Items.

Bees Did Well.

Bees have done very well here the past summer in southeastern Kansas. Our honey is gathered principally from sweet clover and heart's-ease. Some seasons white clover produces honey quite plentifully, but not every season. We don't have very severe winters here. Our bees come out in fine condition as a rule, in the spring. Long may the Bee Journal prosper.

DAVID PUDEBAUGH.

Ozawkie, Kans., Sept. 2.

The Northern Illinois Convention.

The annual meeting of the Northern Illinois Bee-Keepers' Association was held at the residence of B. Kennedy, in Winnebago Co., Ill., Aug. 18, 1896, with a good attendance, considering the poor crop of honey, which, according to the reports of the members, was only about 18 pounds per colony.

The officers elected were as follows: President, G. H. Herrick; Vice-President, O. Taylor; Secretary, B. Kennedy; and Treasurer, O. J. Cummings.

"What is the best way to get laying workers to accept a queen?" was asked. Ans.—Duble up.

"What is the best method of handling colonies and swarms for comb honey?" The Heddon method was considered the best.

"Do bees gather honey from rag-weed?" It was thought not.

The prospects for a honey crop another year was considered good, as the rains had started white clover up, and it is thicker now than for some years.

Mr. George McCartney showed a machine for fastening foundation in the sections and cutting it, that all the members thought was the best yet invented, and it promises to be a great success.

The spring meeting is to be held May 18, 1897, at the residence of H. W. Lee, of Pecatonica, Ill.

B. KENNEDY, Sec.

A Partial Crop—Pacific Weather.

I did not do anything with the bees this year, but one of my brothers gave them what attention they had. He got a partial crop of honey—say about one-fourth of a crop. Of course that is far better than that obtained in the southern counties. The honey was darker than usual. He has not yet disposed of it. The price of honey is far too low, considering the failure of the crop this year.

I do not see how the apiarists of the lower counties exist—it seems an impossibility for them to make a living off their bees at the low price honey commanded the past two years. Then, this year they got nothing in the honey-section of the State. It seems that the honey-fields of California are moving northward. The great San Joaquin valley is taking the palm away from the sage regions.

What hot weather you must have had in the East a few weeks ago. I'm sure many an Easterner at that time wished he was on the Pacific coast. When the thermometer runs up to 90° or so here

THE "NOVELTY" POCKET-KNIFE!



Your Name on the Knife.—When ordering, be sure to say just what Name and Address you wish put on the Knife.

The NOVELTY KNIFE is indeed a novelty. The novelty lies in the handle. It is made beautifully of indestructible celluloid, which is as transparent as glass. Underneath the celluloid, on one side of the handle is placed an AMERICAN BEE JOURNAL reminder, and on the other side, name and residence of the Subscriber.

The material entering into this celebrated knife is of the very best quality; the blades are handforged out of the very finest English razor-steel, and we warrant every blade. The bolsters are made of German silver, and will never rust or corrode. The rivets are hardened German silver wire; the linings are plate brass; the back springs of Sheffield spring steel, and the finish of handle as described above. It will last a lifetime, with proper usage.

Why purchase the Novelty Knife? In case a good knife is lost, the chances are, the owner will never recover it; but if the Novelty is lost, having name and address of owner, the finder will return it; otherwise to try to destroy the name and address, would destroy the knife. If traveling, and you meet with a serious accident, and are so fortunate as to have one of the Novelties, your pocket KNIFE will serve as an identifier; and in case of death, your relatives will at once be apprised of the accident.

How appropriate this knife is for a Christmas, New Year or birthday present! What more lasting memento could a mother give to a son, a wife to a husband, a sister to a brother, a lady to a gentleman, or vice versa, a son to a mother, a husband to a wife, a brother to a sister or a gentleman to a lady—the knife having the name of the recipient on one side?

The accompanying cut gives a faint idea, but cannot fully convey an exact representation of this beautiful knife, as the "Novelty" must be seen to be appreciated.

How to Get this Valuable Knife.—We send it postpaid, for \$1.00, or give it as a Premium to the one sending us three new Subscribers to the BEE JOURNAL (with \$3.00), and we will also send to each new name a copy of the Premium Edition of the book "Bees and Hoeser." We club the Novelty Knife with the BEE JOURNAL for one year, both for \$1.90.

Any Name and Address Put on the Knife.

GEORGE W. YORK & CO.,

CHICAGO, ILLS.

Allow about two weeks for your order to be filled.

PATENT WIRED COMB FOUNDATION

Has No Sag in Brood-Frames

Thin Flat-Bottom Foundation

Has No Fishbone in the Strips Honey.

Being the cleanest is usually worked the quickest of any Foundation made

J. VAN DEUSEN & SONS,
Sole Manufacturers,
Sprout Brook Montgomery Co., N. Y.



WARRANTED GOLDEN

ITALIAN QUEENS By return mail; bred from a Breeder tested by DoGittle out of 1,000 Queens for his own use, and valued at \$50. Queens, 50c; 6 for \$2.75; or \$5.00 per dozen.

Leather Colored Queens from Root's best imported stock same price. Bees from my Queens are excellent workers on red clover. I guarantee safe delivery. N. B.—I sent more than 200 Queens safely to California last season. **H. G. QUIRIN, Bellevue, Ohio.**

34A9 Mention the American Bee Journal.



ONE MAN WITH THE UNION COMBINATION SAW

Can do the work of four men using hand tools, in Rippling, Cutting-off, M-tring, Rabbeting, Grooving, Gaining, Dadlog, Edging-up, Jointing Stuff, etc. Full Line of Foot and Hand Power Machinery Sold on Trial. Catalogue Free.

SENECA FALLS MFG. CO.,
46 Water St., SENECA FALLS, N. Y.
1A1y Mention the American Bee Journal.

SHIPPING - CASES, HONEY - JARS, —CARTONS, LABELS—

And a Full Line of Supplies. Comb & Extracted Honey.

I. J. STRINGHAM,
105 Park Place. NEW YORK, N. Y.
APIARY—Glen Cove, L. I.



That Queen-Clipping Device Free!

Works Like a Charm.

The Monette Queen-Clipping Device WORKS LIKE A CHARM. With it I have clipped 30 queens, all in one day, when examining my bees. **WM. STOLLEY, Grand Island, Nebr.**

Couldn't Do Without It.

I have clipped 19 queens, and must say the Monette Queen-Clipping Device is by far the best invention ever made, and will be welcome to many bee-keepers as it was to me. I could not do without one now.

DR. GEO. LACKE, Newburgh, Ind.

PLEASE READ THIS OFFER TO PRESENT SUBSCRIBERS:

Send us just one new name for the American Bee Journal a year (with \$1.00), and we will mail you the Queen-Clipping Device FREE of charge. Or, the Queen-Clipping Device will be sent postpaid for 30 cts. But why not get it as a Premium by the above offer? You can't earn 30 cts. any easier. Almost every bee-keeper will want this Device. See page 130 (Feb. 27) for full description of it. Complete directions accompany each one sent out. It is a most ingenious and useful article. Address,

GEORGE W. YORK & CO., 118 Michigan St., Chicago, Ill.



we do not mind it. It is seldom, though, that it gets up to 75°. In the San Joaquin and Sacramento valleys it goes up to 100° or more almost every summer; yet, men work in the harvest-fields, and it is seldom that one is overcome by the heat. Usually in the middle of the day when the heat runs up so high, the men "lay off" until 2 p.m., when it moderates so they can work comfortably. I saw it so hot here in June, 1883, that cherries on trees on the side exposed to the sun were cooked. Yet there was not a single case of sunstroke.

Of course, ours is a dry heat, and is not so dangerous as the humid heat of the East. The heat of the East, when I was there, did not bother me any. I walked from Broadway to the business center of Baltimore, Md., one day, and did not mind it. Of course I called it a hot day. The next morning I read that there were several cases of sunstroke in Baltimore and Washington.

W. A. PRYAL.

North Temescal, Calif., Aug. 27.

Light Crop, but Fine Quality.

Crops are beginning to move now, and the worst is over for this season. What the next will bring no man knoweth. We are living in hopes, and almost on hopes. Honey is about one-fourth a crop, of extra-fine quality.

J. B. ADAMS.

Longmont, Colo., Sept. 1.

A First Year's Experience.

I had about 20 colonies of bees at the opening of spring, but about two-thirds of them were in box-hives, and I transferred them all as early as possible into frame hives. This set them back a good deal, as I really think it took them longer to build up on the old combs than it would have done to build up from foundation. I lost several swarms, and now have 33 colonies in good condition for winter.

I had everything to learn about bee-culture when I began last spring, and have made plenty of mistakes, but another year I think I shall know how to avoid some of them.

The season has been very wet and windy, so there were a good many days when the bees could do nothing, but there were oceans of wild flowers, and when there did come a day of sunshine, how the honey did roll in! Later on I will send a report of the amount of honey I have taken off. The bees are still working in the sections very busily.

CHAS. E. CRAWFORD.

Red Oak, Mich., Aug. 29.

Bees That Are Swarmers.

I want to say something more about those bees that are swarmers, but I think they are through swarming for this season; they began on the fourth month. I had two swarms out Aug. 26, but as it came off too cool for them to swarm since that date, I think the swarming business is closed for this time, and I am not sorry, either, for I have had quite a time with the bees for the past three months or more. Before buckwheat began to blossom they were not swarming very much for a few days, but as buckwheat came on they commenced again in good earnest. Several

—An Extra-Fine Grade of— Comb Honey!

Any one wishing something very nice in
**White Clover or Basswood
Comb or Extracted
HONEY**

for Exhibition or any purpose where a gilt-edge article is desired, should write for prices and particulars to.

JEWELL TAYLOR,

35A4t FORESTVILLE, MINN.

What They All Say!

The Queen you sent me is the finest I ever had, and I have bought them all over the country. I am glad I can get the best right at home. Find \$1.00 for another.

MASON E. MARVEL,
Aug. 16, 1896. Oakland, Mass.

The above Queen was an Adel. I have 300 more just like her. Hardy, prolific, great honey-gatherers and practically non-swarming and non-stinging. New 4 page Catalog, giving history of the Adels and safest method of introducing Queens, sent free.

HENRY ALLEY, Wenham, Mass.

35Atf Mention the American Bee Journal



Bee Supplies

Largest Stock and Greatest Variety in the West. **BEST** Good-at-Lowest prices. Cat. of 80 pages FREE.

E. KRETCHMER, RED OAK, IOWA.

Mention the American Bee Journal. 23D9t

RAIL ROAD LANDS

For Sale at Low Prices and on Easy Terms.

The Illinois Central Railroad Company offers for sale on easy terms and at low prices. 150,000 acres of choice fruit, gardening, farm and grazing lands located in

SOUTHERN ILLINOIS.

They are also largely interested in, and call especial attention to the 600,000 acres of land in the famous

YAZOO VALLEY OF MISSISSIPPI

lying along and owned by the Yazoo & Mississippi Valley Railroad Company, and which that company offers at low prices and on long terms. Special inducements and facilities offered to go and examine these lands, both in Southern Illinois and in the "Yazoo Valley," Miss. For further description, map, and any information, address or call upon E. P. SKENE, Land Commissioner, No. 1 Park Row, Chicago, Ill. 33D6t

READERS of this Journal who write to any of our advertisers, either in ordering, or asking about the Goods offered, will please state that they saw the Advertisement in this paper.

of the young swarms that had not as yet swarmed, cast a swarm. I also had 14 old colonies that had swarmed, send out another with a young queen. Several of them had swarmed three times several days, yes, some weeks, before—something I never had occur with my bees, only in one instance with one colony, and that was when I gave them a young queen immediately after the swarm issued, to prevent any further swarming, as I had done before. The young queen was not yet fertilized, but it would not work this season. In some instances, this season, I have had swarms from young swarms, which had not taken place before with my bees.

H. F. NEWTON.

Whitney's Crossing, N. Y., Aug. 31.

Did Fairly Well.

Bees did fairly well here. I commenced the season with six colonies, and now I have 11, and 175 pounds of comb honey, which sells here at 15 cents wholesale and 20 cents retail.

I would not be without the American Bee Journal, for I believe that I have gained more from it than from bee-books.

AUG. BACHMANN.

Seattle, Wash., Aug. 30.

Thick or Thin Sugar Syrup.

I prefer to feed a thick syrup, because it saves the bees much labor in evaporating, and also that I may be sure they will not suffer, if, from any cause, they fail to properly evaporate a thin syrup. When a thin syrup is fed late in the season (the time when feeding is done by a majority of bee-keepers), it is not properly ripened. When fed early it is usually well ripened, but always at a heavy cost in the vitality of the bees. The life of the worker-bee is not measured by time, but by the work it performs; and it is not too much to say that a full quarter of the vitality of a swarm of bees is often consumed in storing a winter supply of sugar syrup. Even when done under the most favorable condition, the loss is so heavy that it is safe to say that the feeding of sugar syrup in the fall is at the best a necessary evil, and to be avoided whenever possible. The bees become aged by this period of activity, and, although they may winter well, in the spring are unable to rear brood as rapidly as colonies depending upon natural stores. The lack of brood in sugar-fed colonies has often been observed, and always explained by the supposed inferiority of the food; whereas the cause is only partially this. That close observer, Capt. Hetherington, first called my attention to the great loss of vitality connected with feeding. Cheshire also admits the same, and gives a partial explanation based on physiology.—P. H. ELWOOD, in Gleanings.

Sweet Clover & Canada.

At the following prices:

5 lbs.	10 lbs.	25 lbs.	50 lbs.
\$1.00	\$1.60	\$3.75	\$7.25.

Also a quantity of Motherwort and Catnip seed. Prices on application.

EGGS for Hatching. Buff Leghorns, Indian Games, & Light Brahmans. Choice Birds. A breeder for 30 years. Prices on application

JOHN McARTHUR,

881 Yonge Street, - TORONTO, ONT.

15Atf Mention the American Bee Journal.

PROF. A. J. COOK'S BOOK FREE!

The Bee-Keeper's Guide

OR

MANUAL OF THE APIARY.

This 15th and latest edition of Prof. Cook's magnificent book of 460 pages, in neat and substantial cloth binding, we propose to give away to our present subscribers, for the work of getting new subscribers for the American Bee Journal.

A description of the book here is quite unnecessary—it is simply the most complete scientific and practical bee-book published today. Fully illustrated, and all written in the most fascinating style. The author is also too well-known to the whole bee-world to require any introduction. No bee-keeper is fully equipped, or his library complete, without "THE BEE-KEEPER'S GUIDE."

GEORGE W. YORK & CO., 118 Mich. St., CHICAGO, ILL.

Given For 2 New Subscribers.

The following offer is made to PRESENT subscribers only, and no premium is also given to the two new subscribers—simply the Bee Journal for one year:

Send us Two New Subscribers to the Bee Journal (with \$2.00), and we will mail you a copy of Prof. Cook's book FREE as a premium. Prof. Cook's book alone sent for \$1.25, or we club it with the Bee Journal for a year—both together for only \$1.75. But surely anybody can get only 2 new subscribers to the Bee Journal for a year, and thus get the book as a premium. Let everybody try for it. Will you have one?

Question-Box.

In the multitude of counsellors there is safety.—Prov. 11-14.

Taking Off the Surplus Section Honey.

Query 28.—In taking off surplus honey, do you take out the sections separately as fast as finished, or do you wait till all in a super are finished and take off the whole super at a time?—ILLINOIS.

Jas. A. Stone—Wait till the super is finished.

R. L. Taylor—I take off a whole super at a time.

Emerson T. Abbott—I aim to take all off at once.

Chas. Dadant & Son—Better take them off as fast as well sealed.

G. M. Doolittle—I take off a whole super at a time, using bee-escapes, as a rule.

Rev. M. Mahin—I take them out as finished, unless they are being finished very rapidly.

J. M. Hambaugh—I have practiced both ways, but we must be governed by the honey-flow.

W. G. Larrabee—I wait until all in the super are finished, but see that they have plenty of room in a super underneath.

Prof. A. J. Cook—If I wish it *very fine*, I take it off as soon as capped. Generally it pays best to take off a super at a time.

J. A. Green—I wait until a super is nearly finished, and look it over as soon as taken from the hive, putting back unfinished sections.

Mrs. L. Harrison—No! I let them remain in the cases until I sell them, unless I'm short of supers, which has not been the case of late.

E. France—I would not wait for the very last one to be finished, unless they were finishing them up pretty fast. If they were, I would let them finish all.

Mrs. J. N. Heater—If honey is coming in fast, I take a case at a time, but if it comes in very slowly, it sometimes pays to take a few at a time to have them in better condition.

Wm. McEvoy—As a rule, I wait until all are finished. But my system of working for section honey is different from all others.—[Suppose you tell us about your comb-honey system, some time, Mr. McEvoy.]

Dr. J. P. H. Brown—When there is a full flow of honey I usually leave the super on until all are capped; but if the flow is only moderate, I take out the sections as soon as capped in order to prevent discoloring.

J. E. Pond—I do not now produce honey enough to be able to determine which is the better plan, but I take out filled sections when I find them, and thus the small amount of comb honey I do get is clean and nice, when otherwise it might not be.

G. W. Demaree—When the season is poor, and slow progress is being made, I take out the finished sections, putting primed sections in their places; but when the season is good, and work goes on rapidly, I practice the *tiring* system

❖ MONEY SAVED IS MONEY GAINED. ❖

THE ROYAL UNION

Life Insurance Company

DES MOINES, IOWA.

The Iowa Policy

Is one that definitely promises to keep an accurate account with you; credit your premiums and interest, charge the actual expense and mortuary cost, and hold the remaining funds subject to your order.

Agents Wanted.

JOHN B. KING, GENERAL AGENT,
Suite 513 First Nat'l Bank Bld'g,
20Aft CHICAGO, ILL.

WHEN ANSWERING THIS ADVERTISEMENT, MENTION THIS JOURNAL.

IF YOU WANT THE

BEE-BOOK

That covers the whole Apicultural Field more completely than any other published, send \$1.25 to Prof. A. J. Cook, Claremont, Calif., for his

Bee-Keeper's Guide.

Liberal Discounts to the Trade.

WHEN ANSWERING THIS ADVERTISEMENT, MENTION THIS JOURNAL.

California

If you care to know of its Fruits, Flowers, Climate or Resources, send for a Sample Copy of California's Favorite Paper—

The Pacific Rural Press

The leading Horticultural and Agricultural paper of the Pacific Coast. Published weekly, handsomely illustrated, \$2.00 per annum. Sample Copy Free.

PACIFIC RURAL PRESS,
220 Market St., - SAN FRANCISCO, CAL.

HONEY We have No. 1 Alfalfa, also White and Sweet Clover Honey we will sell cheap.

Honey and Beeswax Wanted.

Boss bee-escape Warranted the best, simplest and quickest Escape on the market. Sent postpaid to any address for 30 cts. It can be returned at our expense if it is not as represented, or we will send the Escape on trial to any bee-keeper wishing to test it in good faith. We are agents for the Ferguson Patent Hive with double-case Super and Wicket-Gate Honey-Board, with the Escape. It is the easiest, quickest hive to handle for the production of comb or extracted honey.

E. S. LOVESY & CO.,
355 6th East St., SALT LAKE CITY, UTAH.
Mention the American Bee Journal. 9Aft

Page & Lyon Mfg. Co.,

NEW LONDON, WIS., operates two saw-mills that cut, annually, eight million feet of lumber, thus securing the best lumber at the lowest price for the manufacture of bee-keepers' supplies. They have also just completed one of

The Largest Factories,

and have the latest and most improved machinery for the manufacture of Bee-Hives, Sections, etc., that there is in the State. The material is cut from patterns, by machinery, and is absolutely accurate. For Sections, the clearest and

The Whitest Basswood

is used, and they are polished on both sides. Nearness to pine and basswood forests, and possession of mills and factory equipped with best machinery, all combine to enable this firm to furnish the best goods at

The Lowest Prices. ♡ ♡

For instance, it has a job lot of 200,000 No. 2 Sections that will be sold at 50 cts. per 1,000; or 2,000 Snow-White Sections will be sold for \$4.00, and larger quantities at still lower prices. Send for Circular and see the prices on a full line of supplies. 16Aft

Mention the American Bee Journal.

BEGINNERS.

Beginners should have a copy of the Amateur Bee-Keeper, a 70-page book by Prof. J. W. Rouse. Price 25 cents; if sent by mail, 28c. The little book and the Progressive Bee-Keeper (a live, progressive 28-page monthly journal) one year, 65c. Address any first-class dealer, or

LEAHY MFG. CO., Higginsville, Mo.

Van Deusen Foundation!

I have some of the celebrated Van Deusen Thin Foundation in 25-pound boxes, that I will put on board cars for \$12.50 per box.

Also ITALIAN

Queens!

Queens!



Fine Untested Queens mated PROMPTLY at 45 cts. each, or Six for \$2.40.

Safe delivery and satisfaction guaranteed. Address.

F. GRABBE,
LIBERTYVILLE, Lake Co., ILL.

26Aft Mention the American Bee Journal

Bee-Keeper's Guide—see page 589.

—putting the empty cases under the partly-filled cases—and remove the full cases when all the sections are completed in them. It only pays to handle one section at a time when the season is poor. I don't mean to say that I leave all the cases on the hive till the harvest is over; I remove all cases as soon as all the sections in them are all completed.

Eugene Secor—I wait till most sections are finished, and take the super off. I take the unfinished ones from several supers and make up a new one to be returned and finished, except at the close of the season, then I extract from the partly-filled ones.

Dr. C. C. Miller—Neither. During the flush of the season I take off a super when all but four or five are finished; and later in the season a super is often taken off when only half are finished. Then the unfinished ones are massed together to be put back again.

C. H. Dibbern—I remove whole supers. In case the yield is scant, and supers will not be entirely finished, I leave them on as long as any honey comes in, and then take off the supers. I then remove all sections that are finished, and replace the balance on the hives to be finished during the next flow, if any is expected.

Queens and Queen-Rearing.

If you want to know how to have queens fertilized in upper stories while the old queen is still laying below; how you may safely introduce any queen, at any time of the year when bees can fly; all about the different races of bees; all about shipping queens, queen-cages, candy for queen-cages, etc.; all about forming nuclei, multiplying or uniting bees, or weak colonies, etc.; or, in fact, everything about the queen-business which you may want to know—send for Doolittle's "Scientific Queen-Rearing"—a book of over 170 pages, which is as interesting as a story. Here are some good offers of this book:

Bound in cloth, postpaid, \$1.00; or clubbed with the BEE JOURNAL for one year—both for only \$1.75; or given free as a premium for sending us three new subscribers to the BEE JOURNAL for a year at \$1.00 each.

Honey-Clovers & Buckwheat SEED FOR SALE.

We have made arrangements so that we can furnish seed of several of the Clovers and Japanese Buckwheat, by freight or express, at the following prices, cash with order

	5lb	10lb	25lb	50lb
Alsike Clover.....	\$.70	\$1.25	\$3.00	\$ 5.75
Sweet Clover.....	.75	1.40	3.25	6.00
White Clover.....	1.25	2.00	4.50	8.00
Alfalfa Clover.....	.65	1.10	2.70	5.00
Crimson Clover.....	.55	.90	2.00	3.50
Jap. Buckwheat....	.20	.35	.90	1.25

Prices subject to market changes.

Add 25 cents to your order, for cartage, if wanted by freight.

Your orders are solicited.

GEORGE W. YORK & CO.,
CHICAGO, ILLS.

MUTH'S HONEY EXTRACTOR PERFECTION Cold-Blast Smokers,

Square Glass Honey Jars, Etc.

For Circulars, apply to CHAS. F. MUTH & SON, Cor. Freeman & Central Aves., Cincinnati, O. Send 10c for Practical Hints to Bee-Keepers.

Mention the American Bee Journal.

HONEY and BEESWAX

MARKET QUOTATIONS.

The following rules for grading honey were adopted by the North American Bee-Keepers' Association, and, so far as possible, quotations are made according to these rules:

FANCY.—All sections to be well filled; combs straight, of even thickness, and firmly attached to all four sides; both wood and comb unsoiled by travel-stain, or otherwise; all the cells sealed except the row of cells next the wood.

No. 1.—All sections well filled, but combs uneven or crooked, detached at the bottom, or with but few cells unsealed; both wood and comb unsoiled by travel-stain or otherwise.

In addition to this the honey is to be classified according to color, using the terms white, amber and dark. That is, there will be "fancy white," "No. 1 dark," etc.

Chicago, Ills., Aug. 31.—Fancy white clover, 13c.; No. 1 white, 11@12c.; fancy amber, 9@10c.; No. 1 amber, 6@8c.; fancy dark, 8@9c.; No. 1 dark, 7c. Extracted, white, 5@7c.; amber, 5@5½c.; dark, 4½@5c. Beeswax, 25@27c.

The month closes with some offerings of new comb honey, for which 14-15c. is asked for best lots—but there are no sales of consequence to report. There is usually a good deal of it moved in September, thus establishing the early market.

Philadelphia, Pa., Aug. 14.—Extracted, white, 8-10c.; amber, 4-5c.; dark, 3-4c. Beeswax, 25c.

No new comb in this market yet. Old comb cleaned out.

Detroit, Mich., Aug. 8.—No. 1 white, 12-12½c.; fancy amber, 10-11c.; No. 1 amber, 9-10c.; fancy dark, 8-9c. Extracted, white, 5½-6c.; amber, 5-5½c.; dark, 4-5c. Beeswax, 24-25c.

Cincinnati, Ohio, July 10.—No. 1 white, 13@14c.; fancy amber, 12@13c.; No. 1 amber, 10@12c. White, extracted, 5@7c.; amber, 5@6c.; dark, 3¼-5c. Beeswax, 20-25c.

Indianapolis, Ind., July 28.—Fancy white, 15-16c.; No. 1 white, 13-14c. Extracted, white, 6-7c. Beeswax, 25-27c.

No demand at all for off grades of either comb or extracted honey. Large fruit crop and warm weather are opponents to the demand for honey at present.

New York, N. Y., Aug. 8.—No. 1 white, 12@13c.; fancy amber, 11@12c.; No. 1, 10@11c. Extracted, white, 5½@5¾c.; amber, 5c.; dark, 50c. per gallon. Beeswax, 25c.

Our market has not opened up as yet and we would not advise shipping comb honey before Sept. 1, or latter part of this month. Extracted is selling fairly well at prices quoted. Beeswax very dull and declining.

St. Louis, Mo., Aug. 8.—Fancy white, 13@14c.; No. 1 white, 12@12½c.; fancy amber, 11@11½c.; No. 1 amber, 10@10½c.; fancy dark, 8@9c.; No. 1 dark, 7@7½c. Extracted, white, in cans, 5c.; in barrels, 4@4½c.; amber, 3@3½c.; dark, 2½@3c. Beeswax, 19@20c.

Very little honey coming in at present, and the weather is too warm to handle to advantage if it were here.

Albany, N. Y., Aug. 25.—Fancy white, 14-15c.; No. 1, 12-13c.; fancy amber, 11-12c.; No. 1 amber, 10-11c.; fancy dark, 9-10c.; No. 1 dark, 8½-9c.

Receipts of comb honey are quite large, and there is some demand, but we think producers make a mistake in urging immediate sales, as it tends to lower prices. There is quite a demand for comb honey put up in paper cartons.

San Francisco, Calif., Aug. 26.—White comb, 11-12½c.; amber, 7½-10c. Extracted, white, 5-5½c.; light amber, 4½-4¾c.; amber colored and candied, 3¾-4c.; dark tulle, 2¾-3c.

Little doing in honey, and transfers effected are wholly on local account. In seasons of light yield like the present one, the quality is ordinarily of rather low grade, but some honey as fine as was ever seen upon this market has been recently landed here in the shape of comb in 1-pound sections.

Beeswax, fair to choice, 22-25c. There is a fair inquiry for such as can be guaranteed strictly pure. Where there is any suspicion of adulteration, buyers give offerings the go-by.

Milwaukee, Wis., Aug. 8.—Fancy white, 14-15c.; No. 1, 12-13c.; No. 1 amber, 8-10c. Extracted, white, 6-7c.; amber, 5-6c.; dark, 4-5c. Beeswax, 22-24c.

New crop of honey begins to come forward. The demand is very poor and quotations almost nominal. Weather is very warm and the consumption of honey is very small. Plenty of fruit, and hence the appetite is satisfied with same in preference. Later on we expect an improved demand for honey of all kinds.

Minneapolis, Minn., Aug. 8.—Fancy white, 12½c.; No. 1 white, 10@11c.; fancy amber, 9@10c.; No. 1 amber, 8@9c.; fancy dark, 7@8c.; No. 1 dark, 6-8c. Extracted, white, 5½@6½c.; amber, 5@5½c.; dark, 4@5c. Beeswax, 23@26c.

The demand for both comb and extracted is very quiet, and for the latter, nominal. The hot weather of the past week or so has checked demand for comb honey.

Cleveland, Ohio, Aug. 8.—Fancy white, 14½@15c.; No. 1 white, 12½@13c. Extracted, white, 6@7c.; amber, 4½@5½c. Beeswax, 22@25c.

There is not very much honey in our market. Selling rather slow. Demand beginning to be a little better. Think trade will be fair in this line this fall.

Kansas City, Mo., Aug. 8.—Fancy white comb, 15c.; No. 1 white, 13@14c.; fancy amber, 12-13c.; No. 1 amber, 11-12c.; fancy dark, 10-11c.; No. 1, 8-10c. Extracted, white, 6-6½c.; amber, 5-5½c.; dark, 4-4½c. Beeswax, 22-25c.

Boston, Mass., Aug. 10.—Fancy white, 14-15c.; No. 1, 12-13c.; fancy amber, 9-10c. Extracted, white, 6-7c.; amber, 5-6c. Beeswax, 25c.

Good supply of new honey, but demand is light this very hot weather.

Buffalo, N. Y., Aug. 28.—Fancy comb, 1-pound, quiet, 11-12c.; No. 2, quiet, 8-10c.; No. 3, 4-6c.

Old honey is almost unsalable, as well as lots in poor order. Too early for much demand. Don't advise shipments before September to Buffalo and then classify according to actual value.

List of Honey and Beeswax Dealers.

Most of whom Quote in this Journal.

Chicago, Ills.

R. A. BURNETT & Co., 163 South Water Street.

New York, N. Y.

HILDRETH BROS. & SEGELKEN,
120 & 122 West Broadway.
CHAS. ISRAEL & BROS., 486 Canal St.

Kansas City, Mo.

O. C. CLEMOMS & Co., 423 Walnut St.

Buffalo, N. Y.

BATTERSON & Co., 167 & 169 Scott St.

Hamilton, Ills.

CHAS. DADANT & SON.

Philadelphia, Pa.

WM. A. SELSER, 10 Vine St.

Cleveland, Ohio.

WILLIAMS BROS., 80 & 82 Broadway.

St. Louis, Mo.

WESTCOTT COM. CO., 213 Market St.

Minneapolis, Minn.

S. H. HALL & Co.

Milwaukee, Wis.

A. V. BISHOP & Co.

Boston, Mass.

E. E. BLAKE & Co., 57 Chatham Street.

Detroit, Mich.

M. H. HUNT, Bell Branch, Wayne Co., Mich.

Indianapolis, Ind.

WALTER S. POWDER, 162 Massachusetts Ave.

Albany, N. Y.

CHAS. McCULLOCH & Co., 380 Broadway.

Cincinnati, Ohio.

C. F. MUTH & SON, cor. Freeman & Central avs.

BEE-BOOKS

SENT POSTPAID BY

George W. York & Co.,
Chicago, Ills.

Bees and Honey, or Management of an Apiary for Pleasure and Profit, by Thomas G. Newman.—This edition has been largely re-written, thoroughly revised, and is "fully up with the times" in all the improvements and inventions in this rapidly-developing pursuit, and presents the apiculturist with everything that could in the successful management of an apiary, and at the same time produce the most honey in an attractive condition. It contains 250 pages, and 245 illustrations—its beautifully printed in the highest style of the art, and bound in cloth, gold-lettered. Price, \$1.00.

Langstroth on the Honey-Bee, revised by Dadant—This classic in bee-culture, has been entirely re-written, and is fully illustrated. It treats of everything relating to bees and bee-keeping. No apiarian library is complete without this standard work by Rev. L. L. Langstroth—the Father of American Bee-Culture. It has 520 pages; bound in cloth. Price, postpaid, \$1.25.

Bee-Keepers' Guide, or Manual of the Apiary, by Prof. A. J. Cook, of the Michigan Agricultural College.—This book is not only instructive and helpful as a guide in bee-keeping, but is interesting and thoroughly practical and scientific. It contains a full delineation of the anatomy and physiology of bees. 400 pages; bound in cloth and fully illustrated. Price, postpaid, \$1.25.

Scientific Queen-Rearing, as Practically Applied, by G. M. Doolittle.—A method by which the very best of Queen-Bees are reared in perfect accord with Nature's way. 176 pages, bound in cloth, and illustrated. Price, \$1.00.

A B C of Bee-Culture, by A. I. Root.—A compendium of 400 pages, describing everything pertaining to the care of the honey-bees. It contains 300 engravings. It was written especially for beginners. Bound in cloth. Price, \$1.25.

Advanced Bee-Culture, Its Methods and Management, by W. Z. Hutchinson.—The author of this work is too well known to need further description of his book. He is a practical and entertaining writer. You should read his book. 90 pages, bound in paper, and illustrated. Price, 50 cts.

Rational Bee-Keeping, by Dr. John Dzierzon.—This is a translation of his latest German book on bee-culture. It has 350 pages; bound in cloth, \$1.25; in paper covers, \$1.00.

Bienen-Kultur, by Thomas G. Newman.—This is a German translation of the principles portion of the book called BEES OF HONEY. 100 page pamphlet. Price, 40 cents.

Convention Hand-Book, for Bee-Keepers, by Thomas G. Newman.—It contains the parliamentary law and rules of order for Bee-Conventions—also Constitution and By-Laws, with subjects for discussion, etc. Cloth, gold-lettered. Price, 25 cts.

Thirty Years Among the Bees, by Henry Alley.—Gives the results of over a quarter-century's experience in rearing queen-bees. Very latest work of the kind. Nearly 100 pages. Price, 50c.

Why Eat Honey?—This Leaflet is intended for FREE distribution, to create a Local Market. 100 copies, by mail, 40 cts.; 500 for \$1.50; 1000, \$2.50. If 500 or more are ordered at one time, your name and address will be printed on them FREE.

How to Keep Honey and preserve its richness and flavor. Price same as Why Eat Honey.

Apiary Register, by Thos. G. Newman.—Devotes two pages to a colony. Leather binding. Price, for 50 colonies, \$1.00; for 100 colonies, \$1.25.

Preparation of Honey for the Market, including the production and cure of comb and extracted honey. A chapter from BEES AND HONEY. Price, 10 cents.

Bee-Pasturage a Necessity.—This book suggests what and how to plant. It is a chapter from BEES AND HONEY. Price, 10 cents.

The Hive I Use, by G. M. Doolittle. It details his management of bees, and methods of producing comb honey. Price, 5 cents.

Dr. Howard's Book on Foul Brood.—Gives the McEvoy Treatment and reviews the experiments of others. Price, 25 cts.

Dictionary of Apiculture, by Prof. John Phin. Gives the correct meaning of nearly 500 apicultural terms. Price, 50 cts.

Winter Problem in Bee-Keeping, by G. R. Pierce. Result of 25 years' experience. 50 cts.

Handling Bees, by Chas. Dadant & Son.—A Chapter from Langstroth Revised. Price, 8 cts.

Bee-Keepers' Directory, by H. Alley.—Latest methods in Queen-Rearing, etc. Price, 50c.

Foul Brood Treatment, by Prof. F. R. Cheshire.—Its Cause and Prevention. Price, 10 cts.

Foul Brood, by A. R. Kohnke.—Origin, Development and Cure. Price, 25 cts.

History of Bee-Associations, and Brief Reports of the first 20 conventions. Price, 15 cts.

Honey as Food and Medicine, by T. G. Newman.—A 32-page pamphlet: just the thing to create a demand for honey at home. Should be scattered freely. Contains recipes for Honey-Cakes, Cookies, Fuddings, Foam, Wines, and uses of honey for medicine.

Prices, prepaid—Single copy, 5 cts.; 10 copies, 35 cts.; 50 for \$1.50; 100 for \$2.50; 250 for \$5.50; 500 for \$10.00; or 1000 for \$15.00.

When 250 or more are ordered, we will print the bee-keeper's card (free of cost) on the front cover page.

Bee-Keeping for Profit, by Dr. G. L. Tinker.—Revised and enlarged. It details the author's "new system, or how to get the largest yields of comb or extracted honey." 80 p.; illustrated, 25c.

Emerson Binders, made especially for the BEE JOURNAL, are convenient for preserving each number as fast as received. Not available to Canada. Price, 75 cts.

Commercial Calculator, by C. Ropp.—A ready Calculator, Business Arithmetic and Account-Book combined in one. Every farmer and business man should have it. No. 1, bound in water proof leatherette, calf finish. Price, 40 cts. No. 2 in fine artificial leather, with pocket, silicate slate, and account-book. Price, 60 cts.

Green's Four Books, by Chas. A. Green.—Devoted to, 1st, How We Made the Old Farm Pay; 2nd, Peach Culture; 3rd, How to Propagate Fruit-Plants, Vines and Trees; 4th, General Fruit Instructor. Nearly 120 pages. Fully illustrated. 25 cts.

Green's Six Books on Fruit-Culture, by Chas. A. Green.—Devoted 1st, to Apple and Pear Culture; 2nd, Plum and Cherry Culture; 3rd, Raspberry and Blackberry Culture; 4th, Grape Culture; 5th, Strawberry Culture. 129 pp.; illustrated. 25 cts.

Garden and Orchard, by Chas. A. Green.—Gives full instructions in Thinning and Marketing Fruits; Pruning, Planting and Cultivating; Spraying, Evaporation, Cold Storage, Etc. 94 pages, illustrated. Price, 25 cts.

Kendall's Horse-Book.—35 pictures, showing positions of sick horses, and treats on all their diseases. English or German. Price, 25 cts.

Silo and Silage, by Prof. A. J. Cook.—It gives the method in operation at the Michigan Agricultural College. Price, 25 cts.

Lumber and Log-Book.—Gives measurements of lumber, logs, planks; wages, etc. 25c.

Maple Sugar and the Sugar Bush, by Prof. A. J. Cook.—Full instructions. Price, 35 cts.

Grain Tables, for casting up the price of grain, produce, hay, etc. Price, 25 cts.

Capons and Caponizing, by Dr. Sawyer, Fanny Field, and others.—Illustrated. All about caponizing fowls, and thus how to make the most money in poultry-raising. 64 pages. Price, 30 cts.

Our Poultry Doctor, or Health in the Poultry Yard and How to Cure Sick Fowls, by Fanny Field.—Everything about Poultry Diseases and their Cure. 64 pages. Price, 30 cts.

Poultry for Market and Poultry for Profit, by Fanny Field.—Tells everything about the Poultry Business. 64 pages. Price, 25 cts.

Turkeys for Market and Turkeys for Profit, by Fanny Field.—All about Turkey-Raising. 64 pages. Price, 25 cts.

Rural Life.—Bees, Poultry, Fruits, Vegetables, and Household Matters. 100 pages. 25 cts.

Potato Culture, by T. B. Terry.—It tells how to grow them profitably. Price, 40 cts.

Hand-Book of Health, by Dr. Foote.—Hints about eating, drinking, etc. Price, 25 cts.

Alsike Clover Leaflet.—Full directions for growing. 50 for 25 cts.; 100 for 40 cts.; 200, 70c.

Book Clubbing Offers.

(Read Carefully.)

The following clubbing prices include the American Bee Journal one year with each book named. Remember, that only ONE book can be taken in each case with the Bee Journal a year at the prices named. If more books are wanted, see postpaid prices given with

the description of the books on this page. Following is the clubbing-list:

1. Langstroth on the Honey-Bee.....	\$2.00
2. A B C of Bee-Culture.....	2.00
3. Bee-Keeper's Guide.....	1.75
4. Bees and Honey [Cloth bound].....	1.65
5. Scientific Queen-Rearing.....	1.75
6. Dr. Howard's Foul Brood Book.....	1.10
7. Advanced Bee-Culture.....	1.30
9. Bienen-Kultur [German].....	1.25
10. Rational Bee-Keeping [Cloth bound].....	2.00
11. Rational Bee-Keeping [Paper bound].....	1.75
12. Thirty Years Among the Bees.....	1.30
13. Bee-Keeping for Profit.....	1.15
14. Convention Hand-Book.....	1.15
15. Poultry for Market and Profit.....	1.10
16. Turkeys for Market and Profit.....	1.10
17. Capons and Caponizing.....	1.10
18. Our Poultry Doctor.....	1.10
19. Green's Four Books.....	1.15
20. Green's Six Books on Fruit-Culture.....	1.15
21. Garden and Orchard.....	1.15
23. Rural Life.....	1.10
24. Emerson Binder for the Bee Journal.....	1.60
25. Commercial Calculator, No. 1.....	1.25
26. Commercial Calculator, No. 2.....	1.40
27. Kendall's Horse-Book.....	1.10
30. Potato Culture.....	1.20
32. Hand-Book of Health.....	1.10
33. Dictionary of Apiculture.....	1.35
34. Maple Sugar and the Sugar Bush.....	1.20
35. Silo and Silage.....	1.10
36. Winter Problem in Bee-Keeping.....	1.30
37. Apiary Register (for 50 colonies).....	1.75
38. Apiary Register (for 100 colonies).....	2.00
39. Bee-Keepers' Directory.....	1.30

Convention Notices.

TENNESSEE.—The next annual meeting of the East Tennessee Bee-Keepers' Association will be held at Sneedville, Tenn., on September 18, 1896. All persons interested in bee-culture are cordially invited to attend. Luther, Tenn. JOHN M. SMITH, Assl. Sec.

TEXAS.—The third annual convention of the Southwest Texas Bee-Keepers' Association will be held at Beeville, Tex., on Sept. 16 and 17, 1896. All are invited. No hotel bills to pay. Low rates on railroads. Beeville, Tex. J. O. GHIMSLEY, Sec.

MINNESOTA.—The annual meeting of the Southern Minnesota Bee-Keepers' Association will be held in Winona, on September 24 and 25, 1896, at 9 o'clock, a.m. All that feel in any way interested in bees or honey are cordially invited to attend. Winona, Minn. E. C. CORNWELL, Sec.

WISCONSIN.—The annual meeting of the Southwestern Wisconsin Bee-Keepers' Association will be held at Wauzeka, Wis., Oct. 7 and 8, 1896. All that are interested in apiculture are invited to attend, and especially those that want a foul brood law to protect their bees from this dread disease. Our committee is working hard to get every bee-keeper interested, and we should all feel it is for our interest to help get a State law to protect our bees. Many of our prominent bee-keepers of the State have promised to be at our meeting, and no one can afford to miss it. M. M. RICE, Sec. Boscobel, Wis.

North American Bee-Keepers' Association

OFFICERS FOR 1896.

PRESIDENT—A. I. Root..... Medina, Ohio.
VICE-PRES.—Wm. McEvoy..... Woodburn, Ohio.
SEC.—Dr. A. B. Mason..... Sta. B, Toledo, Ohio.
TREAS.—W. Z. Hutchinson..... Flint, Mich.
Convention at Lincoln, Neb., Oct. 7 & 8.

National Bee-Keepers' Union.

PRESIDENT—Hon. R. L. Taylor, Lapeer, Mich.
GEN'L MGR.—T. G. Newman, San Diego, Cal.

Bee-Keepers' Photograph.—We have now on hand a limited number of excellent photographs of prominent bee-keepers—a number of pictures on one card. The likeness of 49 of them are shown on one of the photographs, and 121 on the other. We will send them, postpaid, for 30 cents each, mailing from the 121 kind first; then after they are all gone, we will send the 49 kind. So those who order first will get the most "faces" for their money. Send orders to the Bee Journal office.

Bottom Prices

**BRING US BIG TRADE.
GOOD GOODS KEEP IT.**

If you want the best supplies that can be made at a little less cost than you can buy the same goods for elsewhere, write to us for low prices. 1896 Catalogue now ready—ask for it and a free copy of *The American Bee-Keeper* (36 pages).

Address,
**THE W. T. FALCONER MFG. CO.,
JAMESTOWN, N. Y.**

Mention the American Bee Journal.

COMB FOUNDATION!

Wax always wanted for Cash or in Exchange for Fdn. or other Supplies. My trade is established on **Low Prices** and the merit of my **Foundation**. Orders filled promptly.

WORKING WAX INTO FDN. BY THE LB. A SPECIALTY. Wholesale prices to dealers and large consumers. Send for Prices and Samples to—**GUS DITTMER, AUGUSTA, WIS.** Reference—Augusta Bank. 1Atf

Mention the American Bee Journal.

I ARISE



TO SAY to the readers of the **BEE JOURNAL** that **DOOLITTLE**

has concluded to sell **BEEES and QUEENS**—in their season, during 1896, at the following prices:

- One Colony of Itallans on 9 Gallup frames, in light shipping-box \$6.00
- Five Colonies..... 25.00
- Ten Colonies..... 45.00
- 1 untested queen. 1.00
- 6 " " queens 5.50
- 12 " " " 10.00
- 1 tested Queen... \$1.50
- 3 " " Queens. 3.50
- 1 select tested queen 2.00
- 3 " " Queens 4.00

Select tested queen, previous season's rearing 4.00
Extra Selected for breeding, THE VERY BEST. 5.00
About a Pound of BEEES in a Two-frame Nucien, with any Queen, \$2.00 extra.

☐ Circular free, giving full particulars regarding the Bees and each class of Queens.
Address

G. M. DOOLITTLE,

12A25t BORODINO, Onon. Co., N. Y.

A Bargain—EARLY QUEENS.

119 Colonies Itallan Bees in Chaff Hives; two acres land; good house; excellent well.
Early Queens—Tested, \$1.00; Untested, 50c. Sent by return mail.

E. L. CARRINGTON,

16Atf PETTUS, Bee Co., TEX.
Reference—1st National Bank of Beville.

Mention the American Bee Journal

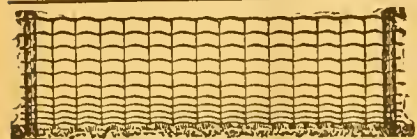

Under 25 Feet Of Snow.

Recently filled an order for a two mile sample for use in the great Yosemite Park, California. The statement that it would be subject to the above test, and that everything tried thus far had proved a **dead failure**, did not deter us, for the Page has no fear of "the beautiful." Send for evidence.

PAGE WOVEN WIRE FENCE CO., Adrian, Mich.

Mention the American Bee Journal.

19th Year Dadant's Foundation 19th Year

Is still in the lead, for we use all the latest improvements, including the

NEW WEED PROCESS,

and still make the best goods. Remember that we do not use any acid to purify our bees-wax, and that is why our Foundation preserves the smell of the honey and is more acceptable to the bees, than any other. It is kept for sale by

T. H. Strickler, Solomon City, Kansas.
G. K. Hubbard, Fort Wayne, Ind.
L. Hanssen, Davenport, Iowa.
C. Theilmann, Theilmanton, Minn.
E. C. Eaglesfield, Berlin, Wis.
E. T. Abbott, St. Joseph, Mo.
J. M. Jenkins, Wetumpka, Alabama
John Rey, East Saginaw, Mich.
Vickery Bros., Evansville, Ind.

The Jennie Atchley Company, Beaville, Texas.
C. F. Muth & Son, Cincinnati, Ohio
E. Kretchmer, Red Oak, Iowa.
G. B. Lewis Co., Watertown, Wis.
James Reynolds Elevator Co., Poughkeepsie, N. Y.
Louisiana Bee-Keepers' Supply Manufactory, Donaldsonville, La.
Page & Lyon, New London, Wis.
John Nebel & Son, High Hill, Mo.

and many other Dealers. All agree in saying that no goods are better than ours.

We make a specialty of **Veils and Veil Stuffs** of best quality, cotton and silk.

Langstroth on the Honey-Bee, Revised

Bee-Keepers' Supplies, Smokers, Sections, Tin Pails, etc.

Samples of Foundation and Tulle FREE with Circular. Instructions to beginners with Circular. Send us your address.

CHAS. DADANT & SON,

Mention the American Bee Journal.

HAMILTON, Hancock Co., ILL.

See Campaign Book Offer on page 589! Better Have It!

10 per ct. Off to Reduce Stock

on all kinds of **SUPPLIES**, except

—COMB FOUNDATION—

which will be sold in lots of 10 lbs. or more as follows: Medium, 35 cts.; Light, 36 cts.; Thin Surplus, 40 cts.; Extra Thin, 45 cts.

Queens—Warranted, 50c.; Tested, 75c.

☐ **W. J. FINCH, Jr., SPRINGFIELD ILLS.**

Mention the American Bee Journal.

* Extracted Honey *



Finest Quality, Basswood and Clover.

2 60-lb. cans in case, 8c. per pound. 1 60-lb. can in case, 9c. per pound. A sample by mail, 10 cts. **POUDER'S Honey-Jars and Complete Line of Supplies.** Catalogue Free.

WALTER S. POUDEF,

162 Sanson Avenue, INDIANAPOLIS, IND.
Mention the American Bee Journal.

Good Prices on Your Comb Honey!

Then you want our latest

NON-DRIP SHIPPING-CASES.

Our trade was never so large in these as now; and Commission Men tell us that Comb Honey in our Cases brings

BETTER PRICES

than some of the Cases made by competitors. The fact is, we know the demands of the trade, and are prepared to supply them. Remember, home-made or poorly made Cases are dear at any price. Honey in such Cases always brings several cents below the market price.

If you wish to get **GILT-EDGE PRICES** on **GILT-EDGE HONEY** put it up in

Root's Non-Drip Shipping-Cases.

THE A. I. ROOT COMPANY,

Factory and Main Office, **MEDINA, O.**

BRANCH OFFICES:

118 Michigan St., Chicago, Ill.

1024 Miss. Str., St. Paul, Minn.

Syracuse, N. Y.

Mechanic Falls, Maine.

AMERICAN BEE JOURNAL

ESTABLISHED IN 1861
THE OLDEST BEE-PAPER IN AMERICA

DEVOTED EXCLUSIVELY
TO THE INTERESTS
OF HONEY-PRODUCERS

Published Weekly, at \$1.00 per annum.

Sample Copy sent on Application.

36th Year.

CHICAGO, ILL., SEPTEMBER 17, 1896.

No. 38.

BIOGRAPHICAL

MR. W. H. PRIDGEN.

While a majority of the prominent bee-keepers of the United States reside north of "Mason and Dixon's Line," yet there are quite a good many to be found south of it. It is to be hoped that their number may increase in that region, which is so admirably adapted to profitable bee-culture, both on account of its abundant and varied flora, and the fact that the wintering problem in bee-keeping seems to be no problem at all in the Southland.

This week we are permitted to present to our readers the face, and some biographical information, of one of the young bee-keepers of old North Carolina—Mr. W. H. Pridgen. The following sketch is kindly furnished by Mr. W. R. Harvey, who is Mr. Pridgen's partner in a general merchandise store at Ita, N. C.:

Mr. W. H. Pridgen, of Creek, N. C., was born in Nash county (this State), Jan. 13, 1862. Oct. 1, 1871, his mother died, and he with his brother and sister were left in their grandmother's care for three years. His father moved to Warren county, N. C., married again, and took his children to live with him. Owing to the loss by the Civil War, and had management, his father's circumstances were materially changed, and Mr. Pridgen has never had the advantages of five months' schooling, but was put on the farm to work when so young that he claims that it gave him very much of a distaste for farm work. As his father's family increased he realized that he would have to paddle his own canoe, and resolved, though only a lad, to take advantage of the first opportunity presenting itself, to improve his circumstances, although he had been in the county but two years, and had not had the advantages of many others of his age in the community.

Mr. B. P. Davis, of Creek, singled out Mr. P. as a suitable boy to assist him in his store and sleep in it nights as a protection, and offered him the position, which was accepted. His spare time was spent in preparing himself for his new calling and the bright future he then pictured out. From year to year, his wages were advanced without his ever demanding it, and, from time to time, more and more of his employer's business was entrusted to his care, until he was made book-keeper, and did most of the buying.

An interesting love story could come in connection with his career, which, no doubt, played an important part (though he might not admit it). He realized at once, that to accomplish the ends he had in view, he must save his earnings, and after filling his position for 11 years, beginning at the

age of 15, sometimes sleeping in the same room every night for three years in succession, and being secretly engaged to Miss S. W. Davis nine years' of the time, he left Creek and tacked up his shingle at Ita, N. C., without giving his real reasons for so doing. Two years later Miss Davis' parents gave their consent, and the young couple were married, and I have been reliably informed that they are spending a life of happiness that is never marred by harsh words, the greatest delight of each being to play the part that will add to the comfort and enjoyment of the other. Six years ago—one year after their marriage—they moved back to Creek, and I took stock in the mercantile business here, and I have remarked, when I knew not that it would ever fall to my lot to write this, that as a partner I would not swap Mr. Pridgen off for any man of my acquaintance, as he is a good and agreeable



W. H. Pridgen.

business man, as well as a christian gentleman. His father kept bees during W. H.'s childhood, and he enjoyed the honey taken from his long row of 50 or more log-gums, but his bee-keeping experience only dates back to the time he first went to Creek, 20 years ago, as Mr. Davis kept a few colonies which he at once took the management of, having a natural fondness for the work and study of their habits. On his return to Creek, six years ago, he felt at liberty to give the bees more attention, and is now looked upon as an authority in this section on everything pertaining to apiculture. He now owns 80 colonies in 10-frame hives, 50 of which are uniformly marked 5-banders. He has recently agreed to conduct the apiarian department in a farm journal, and is endeavoring to arouse an interest in bee-keeping.

Ita, N. C.

W. R. HARVEY.

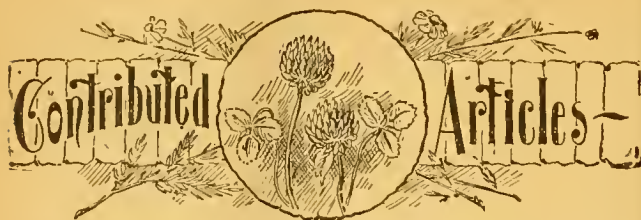

Dividing Colonies—Mr. Bevins' Plan.

BY C. P. DADANT.

We have but little fault to find with Mr. Bevins' plan of dividing, in the way that he described it on page 547, and to this inquiry, we would reply that the use of full sheets of foundation or of empty worker-combs removes our greatest objection to the method mentioned. What we hold is, that unless combs of foundation be given to the two divided colonies, and especially to the one queenless one, most of the comb built will be worthless. But allow me to develop the idea fully.

In a state of nature the bees of a swarm go into an empty cavity and build, first all worker-comb, and towards the last one or two drone-combs. We believe that the queen prefers to lay eggs in worker-combs, and that the bees build the worker-comb to please her. But when they are so far ahead of her as to see that she has all she can fill, they go back to the cheapest way of building, which is building with large cells. For this reason we do not believe in giving the bees a part of their combs already built, neither do we think it right to give them, as some do, half sheets or one-third sheets of foundation. Give them full sheets or only starters. If you give them full sheets they cannot build drone-combs. If you give them only starters, they feel the need of worker-comb, and will build mostly worker-combs. But if you give them a good portion, say half of the combs already built and the rest of the space empty, they will build more drone-comb than with any other method. You may not agree with us as to the cause, but you must agree as to the effect, if you try it.

If the colony is queenless it is still worse, for in that case not a single worker-cell will be built. The bees know that they are queenless, that drones are needed to fertilize the young queens, and since there is no present need of worker-comb, and the drone-comb may be built more economically, being of greater capacity for honey, the necessity is then imperious to give them the combs already built.

If the queen of a swarm is old and not very prolific, more drone-comb will be built than if she is young and vigorous. I say it is thus because the old queen is not desirous of much room. Laying in worker-cells, when the egg must be impregnated as it passes out, has become more or less of a fatigue to her, and she more readily lays in drone-combs, for in that case the eggs pass by the spermatheca which contains the seminal fluid, without impregnation. She must lay, whether she will or not, for in the busy season, when she is highly fed by the bees, her eggs are produced in such quantities that if no cells were furnished they would drop "like ripe fruits." The impregnation of the egg, as it is ejected, while passing by the spermatheca, is evidently pleasurable to her, but finally becomes a fatigue from which she can rest by laying drone-eggs.

The young queen, on the other hand, finds a pleasure in laying worker-eggs, and the bees accede to her wishes by building only worker-comb, especially, if there is no comb built ahead and she keeps up with them.

If you do not accept this explanation as plausible, and hold that the queen does not have her own way, we can still make the matter plain by throwing the responsibility on the workers. When they have an old queen, and see that she is

failing, they are anxious to rear drones so they may be sure of the fertilization of the young queens that they will soon be forced to rear. When they are hived on a hive half full of comb, there is plenty to do for the queen, and they do not see the need of worker-comb till she has caught up with them. But with a young queen, and no room ahead, they feel the need of worker-comb.

From these facts we would deduce the following rules:

Never give empty space for comb-building to a queenless colony or to a colony that has a very old queen.

When hiving a swarm give them no comb at all, but only starters, or else give them combs entirely built, but do not leave a portion only of the combs to build, as they will be sure to build a large quantity of drone-comb.

If you wish combs built in the natural way, let them be built by a strong, vigorous colony with a prolific queen, and you will have the minimum of drone-combs. Being a manufacturer of comb foundation, it is not my place to recommend the use of it, in full sheets as Mr. Bevins does, but were it not for that hindrance, I long ago should have replied to Hutchinson's "Use and Abuse of Comb Foundation." Others have done it as efficiently as I could. But I repeat it, to a man who does not wish to invest much money, no difficulty need be experienced in building good worker-comb, if he will act according to the instincts of the bees. Hamilton, Ill.



Some Hints on Wintering Bees.

BY MRS. L. C. AXTELL.

Last winter our bees wintered well, both in the cellar and out-of-doors. We lost but one colony, and found two queenless in May, when going through to clip queens' wings. We used to look them all through as soon as put out-of-doors in the spring, but as bees have paid us so poorly for several years we looked them through but once before swarming in the middle of May, to clip the queens' wings, as we think that clipping wings is the most important and paying work we have to do with bees. We lost no swarms in consequence, at least we think we lost none, although we had many swarms, both first and some virgin swarms.

We lose less than formerly in cellar wintering. The reason for losing less, we think, is mainly the large entrance we give by lifting up one side of the hive, as our hives are not nailed but clamped at the corners; any way to give a large opening at the bottom so all the dead bees can be easily carried out by the bees, so as not to clog their entrance. When they have a small entrance the bees that die in the hive drop down and clog the entrance, and the live bees find themselves shut in, they become uneasy and restless and eat more, which causes them to become diseased and die. The dead bees remaining in the hive would decay, often causing the death of the whole colony.

The colonies wintered out-of-doors winter just as safely as in the cellar, by turning the frames around so as to pack them with straw on all sides. We lift them up from the bottom-board by standing them upon a frame one inch high, so as to give more room under the frames for the dead bees in long cold spells, so as not to clog the entrance; but care must be taken that no mouse can get in, or they fill all below the frames with chaff, and so fill up the entrance. In two of our hives last winter I found the entrance clogged, and the first warm day when bees could fly I took down all four sides and caught hold of the frames the bees' frames rested on and turned them back, and with my hand scraped out all the chaff, as the mice had it packed tight up against the frames.

One would think the bees would sting the mice, and so keep them out, but they do not. I suppose the bees are dormant when the mice do most of their work. When warm,

so bees can fly, probably they keep down under the chaff, or get above the frames.

When I had cleaned out all the chaff below the frames, being sure I had gotten the mice out, too, then I put up the hive again and filled in all around the frames with chaff, putting a thin division-board outside of the frames, and carpets on top, and repacked with chaff, and put a strip of tin over the entrance so that the entrance would let only a bee pass in and out. I had no further trouble with mice. The bees were not injured any, apparently, as both colonies are among our best this summer. Had I neglected them until spring, or for some weeks, I think they would have been injured. We have in the past lost some colonies just in that way, at least we thought that was the cause of their death, being aroused by the mice when they ought to be dormant, and the entrance being clogged. One can generally tell if mice are in the hive, by looking in the top; they will have runways in the straw.

Roseville, Ill.



Opening Up New Markets for Honey.

BY F. A. SNELL.

In years past there has been much territory in our country where bees have not been kept—some parts, at least, of which are not adapted to the keeping of bees. I have tried and succeeded very well in making sales in such territory to some extent, through friends located there. In doing so the benefit would be two-fold in seasons when our crops have been good here, as then all bee-keepers have a good crop, and there is much to be sold; and if too much honey is thrown on our home or any other one market the result is a demoralized one, and low prices obtained for our honey.

The other benefit results in having an outlet for the large crop when it comes, and at good prices, besides supplying the people at distant points with Nature's purest and most healthful sweet—honey.

In 1886 our crop of honey was a good one in quantity and quality. Having friends in the unoccupied fields I wrote them as to selling for me, or buying and selling it to grocers or consumers. I thus secured two good markets at good distributing points. At one of these points my friends sold nearly 2,000 pounds of comb and extracted honey for me at satisfactory prices. At the other good point the second friend did nearly as well. Others with whom I thus arranged disposed of from 100 to 500 pounds, buying outright from me. The comb honey netted me about 15½ cents, and the extracted 9 cents, or about that. Each year since I have sold more or less at the distant points. The only drawback has been our extremely poor seasons for the last six years, during which time I have been able to ship only small lots to the distant points, owing partially to the urgent home demand for our honey. This season thus far has been a poor one with us.

Bee-keepers who make their bees their leading business should see well to it that too much honey is not forced on their home markets or the large city markets, but try to keep posted as to the honey crop, and select the not overcrowded points to sell their products in, so far as is possible, using no deception in crating. Have the sections cleaned of propolis, and as little soiled as can be; thus the best prices will be secured, which are too low, like all products of labor.

At this time, and for several years past, whether the crops were light or heavy, the tendency has been gradually but surely downward, until very little or no profit is left to the producer, and sometimes the produce is sold at less than the actual cost of producing. The producer of honey, at least, should come as near to the consumer as possible, which is secured to quite an extent by selling, at points as above indicated, in vacant territory; for, were these remote points reached by our large city dealers, much expense would be

added; viz.: freight to city markets from the country producer hundreds of miles away, perhaps; cost of commission and transportation from city to the unoccupied markets, which would make a difference of from 2½ to 5 cents per pound at the final selling point, which would of necessity compel the dealer there to add this amount to the selling price; and the loss from breakage is much increased at times, all of which will add to the retail price unless the grocer loses, in which case less honey will be consumed than if sold at a lower figure, and the grocer less inclined to buy; when, if sent by the producer to the point of consumption, all parties would be helped, and far more honey used at such points; and as the extent of our country is immense, on the whole the results of bringing the producer and consumer near each other would be great, and the greatest amount of honey possible sold, resulting in a benefit to all parties interested, viz.: the bee-keeper, dealer, and consumer. I think too much thought along this line cannot be bestowed.—Gleanings.



An Experience with Vicious Bees.

BY GEO. L. VINAL.

On page 486, L. S. inquires about vicious bees. While gathering honey on May 26, 1895, I purchased several colonies in box-hives, and transferred them into frame hives. In a few days I found I had some vicious bees in the yard, and traced them to one of those colonies. In looking into the hive I found it contained more brood and honey than any other colony in the yard. I was loth to destroy the queen, as she was so prolific, and her bees such workers, so I put up with it. They wintered well, and last spring they commenced the same warfare on any one that approached the hive, so I concluded to destroy the queen, and sent for two untested Carniolan queens.

Now comes the peculiar part of the story. One of the queens was quite large, round, with a long, pointed abdomen; around the abdomen were two white, not gray, but very distinct white, bands. Opening the hive of vicious bees, and finding their queen, I destroyed her, and introduced the Carniolan queen successfully. There could be no mistake, as I clipped her wings before introducing her.

In about a week I looked for her, and found her, and was astonished at the amount of brood there was in the hive. I did not disturb them again for 20 days. The young bees were hatching bees, still cross. I did not disturb them again until the middle of June, when I opened the hive. Oh, how cross they were! I supposed it was some of the old queen's bees. They came up with a zip, and were all over my hands and face. I used the smoker, but 'twas no good, they drove me out.

I then put some tobacco into the smoker, but that was also a failure. Then I put in some oak puff-balls, and smoked them with that, and succeeded in looking over the hive. When I lifted out the frame the bees ran over it like race horses. My hives hold 12 Langstroth frames; they were full of brood and honey, but of all the cross bees they were the worst.

I closed the hive, thinking perhaps it was the presence of some of the old queen's bees that still made them so cross. I cannot go within 50 feet of the hive, but I am pretty sure to get a reminder of their presence. They are the most excellent workers I ever saw, out early in the morning and late at night. When other bees are loafing and hanging out, they are bringing in honey and pollen.

They are also the most inveterate robbers. They are quite large, have three white bands around their abdomens, and the thorax is a shiny black. I had occasion to open the hive a few days ago, and they drove me out three times. At last I

saturated a sponge with sulphuric ether, placed it in the smoker (of course I had no fire in the smoker), and blew the fumes into the hive. I do not know whether it was the cold blast caused by the evaporation of the ether, or whether it was the fumes that conquered them. It's an expensive pleasure to use ether. But if you ever saw a lot of bees piled up in a heap, you will know how those were.

They are good for profit, but poor for pleasure. Who can tell the race they belong to, to cause them to be so vicious?

Charlton City, Mass., Aug. 18.



Prolific Queens—Queen-Rearing, Etc.

BY WM. S. BARCLAY.

On page 451, I gave a description of a prolific colony of bees, and their work in the summer of 1895. I will merely state here that the same colony (No. 3) repeated their work this summer in a similar manner, except from the fact that this being a very wet July (we had only five days on which rain did not fall), I did not get nearly so much honey from this colony, and that I permitted it to give two natural swarms, whereas last year it only gave one natural swarm. Aside from these facts, the product of this colony, and also some of the colonies made from it last season, was nearly equal to the results published at that time.

In writing the article spoken of, I failed to say (which I fully intended to do) that I had *neither bees nor queens for sale*; the consequence was that I have received many inquiries as to prices of bees, queens, etc. My principal object in writing the aforesaid article was in the hope that I could learn of some one who could furnish me with *pure Syrian queens*, by the crossing of which I could keep up to its full capacity the strain of bees which I valued so much.

In breeding queens this season, I reared two from a valuable comb-honey-producing Italian colony; these queens were both dark-colored, one of them entirely black without a single yellow ring, and only a slight shade of yellow could be detected on the abdomen, and that required the closest inspection to observe it at all. As I had always thought the queen-mother had a light trace of Carniolan blood, I thought the progeny of this dark queen would surely be hybrid, and yet when her young bees hatched (which they did about 10 days ago), every bee possessed the three distinctive yellow bands.

I have bred Italian queens for 35 years, and as I thought with great care and close observation, and I think my surprise at the purity of the progeny of this queen has never been equaled but once, and that was many years ago, when I saw a young queen fly from, and return to, the hive with evident signs of impregnation after she had filled two combs with eggs. I should here relate the particulars of this last strange circumstance, but that this communication has already attained too great length. I may, however, do so at some future date, and call out Dr. J. P. H. Brown, who related a similar experience in the American Bee Journal many years ago.

I cannot close this article without thanking Mr. Doolittle for his excellent communication on page 530, on "Queen-Rearing," every line of which I can endorse from practical experience in the same line of observation.

Beaver, Pa., Aug. 21.

Honey as Food and Medicine.—A new and revised edition of this 32-page pamphlet is now issued. It has 5 blank pages on which to write or paste recipes taken from other sources. It is just what its name indicates, and should be liberally distributed among the people everywhere to create a demand for honey. It contains a number of recipes on the use of honey as food and as medicine, besides much other interesting and valuable information. Prices, postpaid, are: Single copy, 5 cts.; 10 copies 30 cts.; 50 for \$1.00; 100 for \$1.75. Better give them a trial. Send all orders to the Bee Journal office.

The Question-Box.

Honey Market of the United States for 1896.

[Gleanings recently sent out a list of six questions to be answered by honey commission-men in various cities, and the replies from many of them were published in the number of that paper for Sept. 1. Editor Root says: "No bee-keeper who expects to send his honey away to market can afford to do so without first reading these replies." Both the questions and the replies thereto follow:—EDITOR.]

1. What style and size of shipping-case is best suited for your market?
2. What style of package for extracted honey in bulk—that is, whether square cans or barrels and kegs?
3. What weight of sections seems to sell best?
4. What time in the year do you secure the best prices?
5. What effect will the absence of California honey have on the price of Eastern honey?
6. From your receipts so far of honey, how does this season compare with that of last year?

BUFFALO, N. Y., Aug. 10.

1. Best white comb honey should be only in 20-pound cases of 20 one-pound combs each as nearly as can be, and to run under 20 pounds net rather than over, and the cases with two glass fronts, but no glass on the comb frames.
2. Extracted should be in 1 or 2 pound tin cans, same as canned goods, as they can then be readily retailed to consumers.
3. One-pound combs, light weight, or not to exceed one pound, sell best.
4. Honey sells best usually, from September to December, and drags some at other times.
5. Buffalo has never been seriously affected by California honey, except occasional seasons. Its absence should favorably affect our markets.
6. Receipts somewhat earlier than usual, and a surplus of fruit causes moderate demand as yet, although perhaps slowly increasing.

B. & Co.

DETROIT, Mich., Aug. 8.

1. 12-pound, 3 row.
2. Square cans.
3. One pound.
4. Fall.
5. Can't tell.
6. Much better.

M. H. H.

BOSTON, Mass., Aug. 8.

1. Neat new basswood, 20 combs, 18 to 20 pounds net; two-thirds cartons, one-third glass fronts.
2. Five-gallon square cans.
3. One-pound, but not over.
4. September 1 to Jan. 1.
5. Very little, as Eastern honey is plentiful.
6. About the same.

E. E. B. & Co.

KANSAS CITY, Mo., Aug. 10.

1. We prefer the 24 sections, single tier.
2. The square cans, and barrels or kegs for cheap grade of honey.
3. Some dealers prefer light sections, and some full weight.
4. In the fall.
5. Will have a tendency to make prices firmer.
6. Our receipts are lighter this year than they were last, up to this time.

C. C. C. & Co.

PHILADELPHIA, Pa., Aug. 14.

1. 24-pound single-tier, glass one side.
2. For grocer trade, 5-pound cans; for manufacturers kegs.
3. One-pound, full weight.
4. October and November.
5. None whatever; cheaper this year than ever.
6. I do not class myself as a commission-man. I always feel sorry when I hear of any goods being consigned to me. I desire to buy outright, and desire to quote market so goods will be offered to me.

W. A. S.

MINNEAPOLIS, Minn., Aug. 8.

1. We think that large cases for shipping comb honey to hold, say, 18 24-pound sections, is perhaps the best arrangement that has come under our observation and experience. By

all means avoid miscellaneous boxes. Have uniform sizes all around.

2. Square tin cans holding five gallons, or about 60 pounds each, packed two to the wooden case, with a wooden partition between, strong tinware, and good cases, by all means.

3. One-pound sections.

4. October, November, and December for comb; and these months, with the early spring months added, for extracted.

5. The failure of the California crop will enable Eastern producers to market their stocks at better prices. Still, there will be plenty of honey.

6. Our receipts of local-grown comb honey this year have already been numerous, and are of a much better quality than those we have had in previous years. There is in this section of the country a marked improvement in the method of producing, packing, grading, and shipping honey, which promises well for the future. The flavor of this year's Wisconsin, Minnesota, and northern Iowa honey is unusually good.

S. H. H. & Co.

MILWAUKEE, Wis., Aug. 8.

1. Single-story cases, 10, 20, and 30 pounds each.

2. Either or all kinds of packages named mostly preferred; kegs and 60-pound cans and half-barrels for white honey; dark honey in barrels and half-barrels.

3. One-pound sections, almost invariably.

4. There is no regular rule; usually early shipments in September.

5. It will have a tendency to improve values.

6. The receipts have been more and earlier for new.

A. V. B. & Co.

CLEVELAND, Ohio, Aug. 7.

1. Cases containing 24 sections of about 20 to 22 pounds weight.

2. Packages for extracted honey, square cans holding about 60 pounds.

3. Weight of sections should be a little less than one pound.

4. We get the best prices in August and September, but sell more goods in December and January.

5. We do not think the absence of California honey will have very much effect.

6. Receipts of honey so far have been more than last year up to this time.

W. B.

DENVER, Colo., Aug. 10.

1. For comb honey, a double-tier 24-pound shipping-case.

2. For extracted honey, 60-pound cans, two in a case.

3. Full-weight sections, 16 ounces to one pound, sell best ("16 to 1").

4. We get the best prices in the early spring months.

5. It will have the effect of giving us better prices and sales.

6. Our honey receipts so far are lighter than last year.

R. K. & J. C. F.

CHICAGO, Ill., Aug. 8.

1. 12 and 24 pound.

2. 60-pound cans, and barrels.

3. Sections weighing not to exceed 16 ounces and not less than 15.

4. September and October.

5. All commodities are extremely low this year—pork, grain, potatoes, apples, butter, and eggs and dried fruits. We believe the condition of the country doesn't warrant high prices on comb honey. We will endeavor to hold our market on fancy white 1-pound sections at 15 cents per pound. We cannot predict at this writing, but will be in position to answer this question about Sept. 1.

6. Our receipts this year far surpass any other year as to quality. We will say the quality is excellent. The shipping-cases are perfect.

F. S. T. & C.

RIVERSIDE, Calif., Aug. 10.

1. 24-pound shipping-cases are what the trade asks for, for comb honey; 5-gallon square cans are cheaper, and best package we have for extracted honey in California.

2. Buyers of comb honey frequently stipulate that sections shall not weigh more than one pound.

3. I would advocate the uniform use of 1½ sections, and that producers always use separators.

4. The time of year in which best prices are realized depends altogether on the extent of the crop, both in the year in which selling is done and the year previous. We realized best prices in California in July of last year, owing to the

partial failure of the eastern crop the year before. This season, when light crop follows large one, best prices will be realized later.

5. Eastern honey should be higher.

6. Honey crop in California for 1896 will be about 7 per cent. of the crop of 1895. There will not be one car of honey stored in California from wild forage-plants.

B. F. B.

SPRINGFIELD, Mass., Aug. 11.

1. We prefer a package containing 25 to 30 pounds of honey, in short 1-pound packages.

2. We have had very little to do with extracted honey, therefore we could not give a satisfactory answer to this question. We do not handle sufficient to quote on.

3. Answered in No. 1. Short pounds sell best in this market.

4. From the latter part of August to the first of January we have our best market, although we have had a very nice trade from Jan. 1 until April 1 in some seasons, owing to the condition of other things in the market at the time that tend to take away the sale of honey.

5. We have had very little California honey in this market, therefore do not know how it would affect the sale of York State honey.

6. We cannot give you any answer that will be any way satisfactory to you, as the season has not yet commenced for honey, and will not for about two weeks as yet. We expect to have a very satisfactory sale of honey this fall, and no doubt we shall have a very nice market.

P. & H.

ST. LOUIS, Mo., Aug. 10.

1. Cases with glass fronts, 24 to 36 pounds.

2. Choice white in cans, either jacket or square; common and amber in barrels.

3. One-pound.

4. First of October to first of January.

5. Should tend to stiffen prices. There is quite a good deal of old California in our market.

6. Receipts are lighter.

W. C. Co.

NEW YORK, Aug. 10.

1. Single-tier, holding 24 one-pound sections.

2. California and Arizona, in 60-pound cans, 2 in case; southern and western, in barrels and half-barrels; New York State and Eastern, in kegs. The trade being accustomed to these packages, we would not favor changing them.

3. One-pound section only, light weight always. No demand for any other size or weight.

4. For comb honey, during September, October, and part of November. Extracted selling all the year, will depend on supply and demand.

5. There is no total absence of California honey; besides, quite a lot was carried over. Last year's crop of California honey was very large, while in all other producing centers it was very light. This year it is the reverse, large crop all over excepting California. The competition of California, therefore, being nominal, fair prices should be obtainable for eastern and western honey. If the crop of California had turned out as large as that of last year, there is no doubt that prices would have gone still lower than those of last year.

6. Receipts from the South have been much larger than those of last season. No receipts from other centers as yet.

H. B. & S.

CINCINNATI, Ohio, Aug. 10.

1. Glassed cases holding 12, 20, or 24-pound sections, no difference whether single or double tier, are most popular.

2. Barrels, half-barrels, and crates of two 60-pound tin cans are alike acceptable to manufacturers.

3. One pound light.

4. When new honey comes in first.

5. None whatever these close times. Nothing can be sold at a high price.

6. Our receipts so far have been at least twice as large this year as they were last year at this time.

C. F. M. & S.

HONEY SEASON FOR THE UNITED STATES.

Editor Root also called for reports as to the 1896 honey crop in all parts of the country, and sums them up as follows, so far as heard from:

The responses to the call for reports up to this time, have not been very heavy; but so far as they go to show that the season is not as good as expected from the first reports. In Illinois Dr. Miller is the only one who reports a good season. All the rest give from poor to fair. Indiana seems to be uni-

versally poor. In Michigan there is only one who reports good, and all the rest show from fair to poor. This is a surprise, as we have had general reports of good seasons from that State. This can be accounted for only by the fact that those who order goods have a fair season, and so report; and those who do not order do not need the goods, and so of course do not write us. However, taking everything into consideration, the season over the country has been better than the one of 1895. As to prices on comb honey, 12 cents seems to be about a fair average.

Questions AND Answers

CONDUCTED BY

DR. C. C. MILLER, MARENGO, ILL.

[Questions may be mailed to the Bee Journal, or to Dr. Miller direct.]

Where Did the Egg Come From?

July 4, 1896, I examined one of my hives of bees, and it contained eggs and brood. July 11 it contained neither eggs nor young brood. Being away from home I did not examine it again until Aug. 18; when it contained neither eggs nor brood of any kind, and was apparently queenless, and had been for some weeks. On Aug. 31 I opened it to introduce a queen, and examined it carefully to see if there were any signs of a queen. To my surprise, I found a queen-cell containing a larva not quite half grown, well supplied with royal jelly. But there was not the slightest sign of another egg nor larva. The question is, From where did the egg the larva in the queen-cell was hatched from, come? Did the bees steal it from another hive? If not, where did they get it?

C. E. M.

ANSWER.—Before answering your question, I'd like to know what was the outcome of that queen-cell. If it contained a drone, or if the larva died in the cell, then I should guess that a laying worker had laid the egg. If a good queen came out of the cell, I'd make another guess. A queen was reared from some egg or larva that was present about July 4. She was a poor affair, was a long time in commencing to lay, and then laid just one egg in the queen-cell you found. I once had just such a case, and the curious part is that sometimes the royal progeny of such a queen may be fairly good.

Disappearance of the Queen.

I formed a nucleus July 30 by placing a frame of brood containing a queen-cell in it and filled out the remaining space with empty comb in an empty hive; removing a strong colony to another location I put this nucleus in its stead. August 12 this young queen hatched out a beautiful Italian queen; Aug. 29 (to-day), on examining the hive, I found sealed brood about half of each side of one frame, no queen that I could find, but 15 or 20 queen-cells mostly capped over. What became of the young hatched queen I saw in the hive Aug. 12—17 days before this?

On Aug. 12, on finding the queen hatched out, I gave them two frames of comb taken from the second story of another colony, which may have had eggs in it, but the bees were all swept off, and besides queen-cells being in this there were also 7 or 8 cells in another full frame of foundation which they have partly drawn out, and which was given to them the same time the empty frames of comb (Aug. 12), so the young queen must have deposited the eggs in the drawn-out comb foundation, which, if so, is evidence she was not lost in mating.

A. B. B.

ANSWER.—You are probably right in thinking that the young queen that you saw in the hive Aug. 12 laid the eggs for the brood you found on the 29th, and that no queen was present on the latter date. The question is, what happened

to the queen after she laid those eggs? I don't know. It isn't the usual thing for a queen to disappear in that way, but if you have any considerable experience you'll find that such cases do occasionally occur. It is just possible that you had the hive open after the queen began to lay, and in putting back a frame you crushed the queen. But you may not have opened the hive at all between Aug. 12 and Aug. 29, in which case you prove an alibi, and must be exonerated from all blame. Then it is left for us to guess what may have happened with the bees themselves. In rare cases a small fugitive lot of bees may have gotten into the hive, causing the balling and death of the queen. Possibly there was something about the queen that was not satisfactory to the bees, and they superseded her thus early, for I've known cases where a queen was superseded before laying a dozen eggs. Other accidental occurrences might be guessed at, but the sum and substance is that sometimes queens disappear without our knowing why.

Odor of Honey Cans and Kegs—Shipping Comb Foundation in Winter.

1. Do new honey-cans ever have an odor which will not leave them after scalding and airing a few hours?
2. How can one tell for certain whether such cans are new, or old oil cans?
3. Will the odor from oak kegs taint the honey?
4. Can foundation be safely shipped in the winter?

E. M. H.

ANSWERS.—1. I never heard anything of the kind, and will be obliged if any one who knows anything about it will tell.

2. I don't know of any way except the general way in which you can tell new tin from old by its unmarred brightness.

3. I think not materially. Paraffine the inside will make a sure thing of it and guard against leakage.

4. If well packed there ought not to be much trouble, but if roughly handled there is danger of a little crumbling of the edges.

Honey Fermentation—Galvanized Iron Tanks for Honey.

1. Some three months ago I extracted about 40 gallons of honey. It was almost all sealed over before being extracted—in fact, it was allowed to remain on the hive for some time, and had gotten extra thick, and the flavor was good. About 30 gallons of this honey was put in three 10-gallon kegs; the kegs were not filled up to the bung-hole, but say within 2¼ inches of it, and the bung put in fairly tight, and the kegs stored in a floored house. The balance was put in 4-gallon tins, and some bottled. The honey remained in the kegs for about three months before I decided to ship, but on examining them before doing so, I found the keg filled up to overflowing—in fact, when the kegs were struck, the bung flew out with a column of honey. The honey had gotten thin, had a slightly sharp taste, and there were a few small bubbles at the top, whereas some of the same honey which was put in tins and in bottles were in first-class condition. I know that honey, if left open in a damp atmosphere, will soon absorb moisture, increase in quantity, and become thin, but is it possible for moisture to find its way through a honey-tight keg to such an extent? For I am sure there was at least 2 to 3 quarts more liquid in each keg than what I put in. What would you advise me to do in the future in order to prevent a recurrence? Tins are not suitable packages for me.

2. If honey be left in a new galvanized iron tank, for say two months, will it spoil the flavor of the honey, or in any way depreciate its value? The galvanized tin roofing on our house, although there over 10 years, imparts a distinct unpleasant taste to rain water.

S. N.

Black River, Jamaica, Aug. 17.

ANSWERS.—1. It seems pretty clear that there was fermentation, and no doubt deliquescence as well. For that throwing out of the bung shows the presence of restrained gases coming from fermentation. It is possible that there

may have been some little pollen present as floating pollen. Honey is very eager for moisture, and although the kegs may have been water-tight, that would not hinder moisture from getting into the honey. Indeed, about the worst thing you can do, is to have the wood of the keg soaked so the hoops are very tight before putting in the honey. The honey will suck all the moisture out of the staves, loosen the hoops, and get in more moisture, then ferment, and perhaps burst the keg. Before putting honey into kegs, keep the kegs in a very dry place, driving up the hoops occasionally. Through tin and glass no moisture can pass. The wood can be made a little like glass by paraffining it. Have your kegs hot by standing in the sun or otherwise, pour two or three pounds of hot paraffine into the keg, bung tight, roll the keg over and over, tipping it on each end, then knock out the bung and pour out the paraffine. If you have been lively about it you'll get most of your paraffine back, but a thin coating will be all over the inside surface.

2. A good deal of discussion took place in Gleanings some time ago with regard to this, and I don't know that the matter was very fully settled, but some, at least, reported that there was no trouble.

Hives Made of Juniper Wood.

Will a natural swarm of bees stay in a hive made of juniper boards?
T. J. B.

ANSWER.—Bees will hardly object to any kind of wood unless there be some very strong odor from it, especially if it stands in the hot sun to make the odor more pronounced. Unless there's something about juniper wood that I know nothing about, no reasonable natural swarm would make any protest about it, providing the wood be seasoned and the hive set in the shade. No matter what the hive, not only should the hive be set in the shade, but there should be very large ventilation given for a few days by having the hive well raised and some opening at the top.

A Colony that Persists in Hanging Out.

I have one large colony of Italian bees in a box-hive quite busy at work, but the whole face of the hive is black with bees over one-half of the time, besides a large cluster underneath. They have varnished the face of the hive and alighting-board all over with wax. The super inside is black with bees, but they won't store any honey in it. The colony is one year old, and have never swarmed. Would they not begin to work like a new colony if they were transferred to a new hive, with self-spaced removable frames and starters fastened in them? We have a big patch of buckwheat that they are working in very lively. Do you think there are moths in the hive? No other colony I have has daubed their hives at all on the outside. I am anxious to transfer them, as I opened a hive the other day to examine them, and didn't get a sting. I forgot to mention that they have clustered out so for six or seven weeks. At first we thought they were going to swarm.

Last year was my first year with bees, and I am anxious to get all the information I can. I love to work with them. Success to the Bee Journal.
Garrison, Kan. Mrs. I. J.

ANSWER.—It isn't easy to say just what the trouble is, nor whether there is any trouble. The bees are hanging out either because there is too little room for them inside, or because there is too little ventilation, making it too hot in the hive. The varnishing is practiced more by this colony on the outside just because the bees are on the outside. The colonies that stay in the inside do their varnishing with propolis there, for if you will look closely you will find probably that propolis and not wax is used for varnishing.

Strong colonies and moths are not likely to go together, and I don't suppose that moths are to blame. They generally get in their work after some other trouble has made the colony non-resistant.

New swarms work with unusual vigor, and you probably think if the bees were transferred it would give them the vigor of a new swarm. In that you would probably be mistaken. It's doubtful if they'd do any more in supers after transferring, as the movable-comb hives are for the convenience of the bee-keeper rather than for the better working of the bees. Better let them stay where they are until next year, as it is now so late in the season. Possibly the reason they have done nothing in supers is because they have nothing to do. But if other colonies are working in supers then that cannot be the reason. Without knowing more about the case than you mention, the most reasonable guess would be that the pasturage has been too poor for them to store anything in supers, but now that they are working busily on buckwheat you may find them by this time making a good report from it. But if others are working in supers, and this one doing nothing in them, although strong in numbers and filling the super with bees, you have a very unusual case, and will kindly furnish further particulars.

An English Bee and Honey Show.—We received the following letter from Mr. R. A. Burnett, of Chicago, dated Aug. 10:

FRIEND YORK:—Enclosed is a clipping from an English paper that has come to me, and it shows how they regard bees. The exhibit is one of the great ones of that country—of horses and cattle.
Yours very truly,
R. A. BURNETT.

The show referred to is that of the Royal Agricultural Society, of England, which was held recently at Leicester. Referring to the apiarian part of the great show, the report says:

The growing interest throughout the country of late years, as the result of the action of the County Councils in appointing competent lecturers, and of other ways in which the industry has been boomed, was evident in the exhibits, which, both in number and quality, exceeded those of previous years. Each of the 15 classes in this department are well filled, and the tent in which the exhibits are nicely arranged, as well as the bee-driving and lectures on bee-keeping, will no doubt prove a center of much attraction during the show. Everything was arranged in capital style, and in a way best calculated to display to advantage the various exhibits. Not only was the honey and comb shown in varying degrees of preparation for consumption, but at the back of the capacious stand there was an observatory hive in which the bees could be seen at work, the cells in which the honey is located being easily distinguished from the part devoted to incubation. This part of the exhibit was of considerable interest to visitors, and was the source of great attraction.

The different purposes for which honey may be utilized was made perfectly clear, as not only were confectioneries, cosmetics, and soaps rendered the richer by its inclusion as an ingredient, but vinegar of the purest kind was shown to be obtained from honey. Prizes were offered in such a way as to bring out every aspect of the management and utilization of bees and their produce, and a most successful result was achieved. The entries were not only numerous, but were throughout of a highly meritorious character.

Perhaps one of the most encouraging classes as far as the industry is concerned, was that in which special prizes were offered for any practical, useful invention connected with bee-keeping introduced since 1894. This brought eleven entries, and four certificates of merit were awarded to competitors. On the walls of the stand were hung diagrams for the assistance of children in schools.

A New Binder for holding a year's numbers of the American Bee Journal, we propose to mail, postpaid, to every subscriber who sends us 15 cents. It is called "The Wood Binder," is patented, and is an entirely new and very simple arrangement. Full printed directions accompany each Binder. Every reader should get it, and preserve the copies of the Bee Journal as fast as they are received. They are invaluable for reference, and at the low price of the Binder you can afford to get it yearly.

OLDEST BEE PAPER IN AMERICA ESTABLISHED IN 1861

THE AMERICAN BEE JOURNAL

GEORGE W. YORK, Editor.

PUBLISHED WEEKLY BY

GEORGE W. YORK & COMPANY,

118 Michigan St., CHICAGO, ILL.

\$1.00 a Year—Sample Copy Sent Free.

[Entered at the Post-Office at Chicago as Second-Class Mail-Matter.]

Vol. XXXVI. CHICAGO, ILL., SEPT. 17, 1896. No. 38.

EDITORIAL COMMENTS.

Ho, for Lincoln!—As all our readers know, the North American bee-convention will be held at Lincoln, Nebr., on Wednesday and Thursday, Oct. 7 and 8—next month. Now, the Nebraska bee-keepers are going to a good deal of work and expense, intending, during the convention, to take care of every member outside of their State free. With such a generous offer, and in view of the excellent program arranged by Secretary Mason, it seems to us that so far as possible every bee-keeper, who is a bee-keeper, should arrange to go—especially as the Homeseekers' Excursion rate of about half fare can be taken advantage of on Oct. 6.

For all who can possibly start from Chicago—and those east of this city—we may say that we have arranged for a through sleeping-car to Lincoln without change, on the Chicago and Northwestern railroad. It will leave here at 6 o'clock Tuesday evening, Oct. 6, and arrive at Lincoln at 11 a.m. the next forenoon. Of course, the first session of the convention would be missed, though that perhaps would not be much, as very little will be done before the afternoon of the first day.

We do hope that a large enough company will gather here in Chicago, so that we can fill at least one sleeping-car. What a fine time such a crowd would have going on such a journey!

On the return trip we would leave Lincoln at 1:45 p.m., on Friday, Oct. 9, arriving in Chicago at 7 o'clock the following morning.

Now we want to hear from all who will go with us from Chicago. Please let us know at once about it. If any further information is desired, we shall be pleased to give it, if you will write us.

Honey Letters and Circulars.—At this time of the year, and for the next few months, various firms representing themselves to be "the largest honey-dealers in the West," or some other like untrue statement, will be sending out their bait in the shape of eloquently pleading letters or circulars. We wish to caution our readers against all such appeals soliciting shipments of honey or anything else, unless you know that the firms sending them are reliable. Better send to us all such letters and circulars and we will investigate them and report. You can rely pretty well upon the market quotations as given in the leading bee-papers, and when you find a firm giving higher quotations, think twice before shipping to them. In nine cases out of ten they are unreliable, and you will suffer a loss on your shipment.

We want the co-operation of all bee-keepers in putting down the frauds and swindlers that live by dealing dishonestly with honey-producers.

Nebraska Irrigation Fair.—Mr. Sanford Hartman, Superintendent of the department of "Bees, Honey and Apiarian Goods" at the Nebraska Irrigation Fair, to be held at North Platte, Oct. 9 to 15, inclusive, writes us as follows:

NORTH PLATTE, Nebr., Sept. 7, 1896.

MR. EDITOR:—I have to-day mailed you our premium list for the coming Fair. I should be glad to have you extend a cordial invitation through the American Bee Journal to all of the members and friends that attend the North American convention at Lincoln, Oct. 7 and 8.

We are beginning to sow large tracts of alfalfa here, which we think is going to open up some good locations for bee-keeping, and the field at present is almost unoccupied. Now this Fair will be a good place for some of your advertisers to show off some of their goods. I should be glad to correspond with any of them, as to railroad rates and other advantages, who may wish to exhibit any of their goods.

Yours truly,

SANFORD HARTMAN.

We take the following from the published "List of Premiums," a copy of which can be had by addressing Mr. Hartman:

All competitors of honey must produce their own honey.
Points for the judging of honey:
COMB HONEY—First, perfection of capping; second, evenness of surface; third, whiteness of capping; fourth, general appearance to marketability.

EXTRACTED HONEY—First, cleanliness; second, clearness; third, flavor.

	1st.	2nd.
Best white clover honey, not less than 20 lbs., crated and in single-comb sections weighing not more than 2 lbs. each.....	\$3 00	\$2 00
Best alfalfa honey, same amount and crated as above.....	3 00	2 00
Best 20 lbs. of extracted white clover honey...	2 00	1 00
Best 20 lbs. of extracted alfalfa honey.....	2 00	1 00
Best exhibit of apiarian supplies and implements	5 00	2 00
Best display of bees and queens in observatory hives and not allowed to fly, not less than two cages.....	3 00	2 00
Best honey-extractor, test to be made by actual extracting upon the grounds.....	2 00	1 00
Best all-purpose single-walled hive.....	1 00	
Best all-purpose chaff hive.....	1 00	
Best bee-smoker.....	50	
For the best collection of blossoming, with common and proper names.....	3 00	2 00

Sugar vs. Honey.—Reports show that the total amount of sugar consumed in the United States in the year 1892 was 3,899,488,000 pounds, or about 60 pounds for each inhabitant. Who doubts that all would have been healthier if at least 5 pounds of the 60 consumed by each individual had been honey? Suppose that could be brought about, wouldn't it open up a demand for honey? Five pounds each, with an estimated population of 70 million people, would require 350,000,000 pounds of honey annually to feed our own people.

The majority of families do not know the value of honey as a daily food. They imagine that it is mainly a medicine, or else know nothing at all about it. It seems to us that there is a big field here for bee-keepers to work in. Once get the people fully acquainted with honey, and soon bee-keepers will find a big demand for it. Every honey-producer should do his part in spreading information regarding the true value of honey as a table article.

Honey at a Wedding.—The editor of the Australian Bee-Bulletin says he got a good hint while attending the wedding of a bee-keeper. When the party were all seated around the room, after coming from the church, among the refreshments handed around were thin slices of bread on which a spoonful of honey was dropped in the middle. The recipient doubled the bread up, making a delightful little honey-sandwich. This is a good way to introduce honey, at social gatherings, etc.

Illinois State Fair Exhibit.—We have received the following regarding the exhibit of Italian bees at the coming Illinois State Fair:

Since the Illinois State Fair, to be held in Springfield, Sept. 28 to Oct. 3, offers premiums on two strains or classes of Italian bees, it becomes necessary to specify standards for judging each of these two strains, because in the rules adopted a standard for only one class is given, and even this class is indefinite. Hence, the Fair committee have decided to amend remark 2 under the rule adopted for judging Italian bees, so as to read as follows:

2. (a) Dark or leather-colored Italians should show three yellow bands.

(b) Golden Italians should show four or more yellow bands, and those showing the most yellow, and are the most evenly marked, should score the highest.

GEO. F. ROBBINS, }
W. J. FINCH, JR., } Com.

It was through the efforts of this committee that the premiums offered on bees and honey (no implements) at the Illinois State Fair were raised to a total of \$284, which is indeed very liberal, and should call out a fine exhibit.

New Union and Honey Exchange.—In Skylark's "Pickings by the Way," in *Gleanings* for Sept. 1, he gives some excellent suggestions as to what ought to be done at the Lincoln convention next month. Here is what he says:

The North American meets the 7th of October next. This is just the chance you want to form and organize a new union and honey exchange—national in every respect. There will be present a large number of bee-keepers—men of national reputation, almost equal to myself, and you will not get such a body together soon again.

Take the constitution of the present Union and add ample power to protect bee-keepers in everything that relates to their calling—power to fight adulteration in the legislative halls, in the courts, and in the streets. This question of adulteration overtops all others that confront us at the present time. Everything else dwindles into utter insignificance before it. It is the greatest enemy we have to fight. One man or a few men can do nothing; but a great organized body, cemented together by mutual interests and a common objective point, would be invincible in pleading for the right in the legislative hall or in a court of justice.

This hydra-headed monster, Adulteration, that has started up in our path, is the only one that bids fair at the present time to destroy us in the end. Its utter destruction and annihilation is our only salvation. "Is life so dear or peace so sweet" that we will stand idly here and allow our enemy to sweep over us, carrying everything before him? No! a thousand times no!

I don't want to say anything against the little Union, and I won't; but I have examined it with my little microscope, and it appears to watch that \$700 very much as a little bulldog watches a bone that he has laid away for future use. A national union and honey exchange would soon absorb it, for the members of the Union, as it is, would see that they could get much more protection in the new organization. This institution would be the great bulwark of our liberty—the fortress from which would belch forth the thunder of our cannon on evil-doers—a protection and a defense at all times and under all circumstances.

Don't talk to me about the expense of it. I hate expenses. A man would actually make money by his membership. Can you buy \$100 worth of supplies as cheap as you can buy 25 carloads? Well, that is exactly what this union and exchange would do—buy in large lots and sell to members at cost, plus expense of handling. To outsiders it might sell at a fair profit, benefiting even them. Any bee-keeper would make much more than his outlay for membership by belonging to it.

And last, but not least, there is the great and paramount object of having your honey handled honestly. It would be no joint stock company, where a few men can get rich at the expense of the many. Every man would be just as good as another, and a great deal better. This institution would eventually control the honey market, and get much better prices for our product. Thousands would flock into it, for they can see they would be making money by it. If a man can see he is losing money by staying out, how long will he stay there? If they can see, as they will see, that it is a blessing and a free lunch to be in, won't they tumble in pell-mell?

Some say we are talking too much; that action is what is

wanted, and then they go on and talk a good deal more. Well, why don't they act—take the lead without talk? The fact is, no one seems willing to make a leader of himself. But now a great body of leading bee-keepers is about to come together at Lincoln, Nebr., and it is to them we must look if anything is to be accomplished at the present time. Turn the North American, with its present membership, into a new "Union Honey Exchange," and in three months there will be 1,000 names on its rolls, and it will increase so fast that the little Union will march up to its treasury and cast in its little trifle of \$700. Let the headquarters be at Chicago, the hot-bed and sink of adulteration. First fight for pure-food laws, and then fight to get them executed, and it will not be long until the hydra-headed monster is laid low in the dust.

Skylark is a big fellow!—in his own mind. But he does occasionally throw out some mighty chunks of wisdom when he bends his brain to it. And the foregoing is a shining example of what he can do when he is careful to hold his bump of imagination in proper check.

Particularly are we with him in urging such a modification of the present Union as to make it of greater use to its members. There are certain questions—especially honey adulteration—that *must* be taken hold of, and we think the reorganized Union is just the one to do it. We believe that the adulteration fight is the very next—and first—thing for bee-keepers to take hold of in good earnest. Then there are some crooked honey commission-men that need straightening out. This the Union could help to do.

When it comes to a national honey exchange—well, that's a big thing. That will need some very steady, careful thought. The Union must *not* rush into that. We have no doubt it would prove a good thing if properly managed—but be sure to *count the cost* before undertaking so large a work as that. The idea is all right, but it means an enormous amount of cash capital and right management to carry it out.

Let all digest Skylark's suggestions, then come to Lincoln ready to aid in a "forward movement" in the interest of all bee-keepers.

Honey as a Medicine.—Mr. Elias Fox, in a recent number of *Gleanings*, wrote thus on the value of honey as a medicinal article as well as for food:

We have a young man here in this village who was troubled with dyspepsia, and the more medicine he took the worse he became. I advised him to try honey and graham gems for breakfast, telling him of my experience. He said, "Bring me up some and I will try it." I did so, and he commenced to gain, and now enjoys as good health as the average man, and he does not take medicine, either.

I attended the bee-keepers' convention at Madison, Wis., several years ago, and Dr. Vance, of that city, read an essay on honey as food and medicine, and in his remarks he said that honey is the only food taken into the stomach that leaves no residue. He claimed that it requires no action of the stomach whatever to digest it, as it is merely absorbed and taken up into the system by the action of the blood. I sincerely believe that honey is the natural foe to dyspepsia and indigestion, as well as a food for the human system.

Only One Cent a Copy for copies of the American Bee Journal before Jan. 1, 1896. We have them running back for about 10 years. But you must let us select them, as we cannot furnish them in regular order, and probably not any particular copies. Just send us as many one-cent stamps as you may want old copies, and we will mail them to you.

The Great Campaign Book offered on page 607, ought to be in the hands of every voter. It shows all sides of the political questions of the day. Better send for a copy of it. Orders filled by return mail.

Paste for Labeling on tin, when other things fail, is made simply of water and flour not boiled. So an exchange says. It can be proven by trial.

PERSONAL MENTION.

MR. JOHN L. NAIL, of Brevard county, Fla., has been treating the editor of his local newspaper to a feast of fine comb honey, and of course it "Nail-ed" that editor's sweet tooth completely. The honey was gathered from palmetto bloom. "Would be a good thing if other bee-keepers would follow Mr. Nail's example. It helps to advertise your honey, as well as to sweeten the life of ye country editor.

MR. H. H. PORTER, of Wisconsin, intending to leave that State for several months, asked that his subscription to the American Bee Journal be discontinued; but as he did not go, he sends for the paper again and says: "I am getting lonesome without the Bee Journal. Please commence where I stopped." We have no doubt many others would "get lonesome" without the regular visits of a favorite paper. But so far as we are concerned, we stand ready to help prevent any lonesomeness whenever we can. The American Bee Journal wants to go regularly to every bee-keeper in the land.

REV. M. MAHIN, D. D., of New Castle, Ind., we regret to learn, has been very sick. In a letter dated Sept. 2 he says:

"I am just coming out—at least I hope I am—of a month's severe illness from biliary calculi. I have suffered more than tongue can tell. I am not yet able to do any work, except a very little of the lightest kind."

We hope Dr. M. may soon be quite himself again, and live many happy years to aid and bless the church of which he is an honored minister. Our readers well know him as one of the number who furnish answers to the conundrums in our "Question-Box." In regard to the bees, Dr. Mahin says this:

"Bees are gathering some honey now, which is almost the first this season. I hope they will get enough to winter them."

MR. ALLEN PRINGLE'S DEATH has called out the following expressions of sympathy and regret:

Editor Hutchinson, in the Bee-Keepers' Review, among other things, said this about Mr. Pringle:

"Canadians have lost one of their brightest bee-keepers and truest men in the death of Mr. Allen Pringle. He was a scientist and scholar, and model farmer as well as a bee-

keeper, but, best of all, he was a man of sterling integrity, one who scorned to do a mean act, and was ever ready with tongue and pen to defend the right. One of his greatest regrets in leaving was that at such a comparatively early age (55) he should be compelled to leave so much work undone.

"Since the foregoing was written, I have received a letter from Mrs. Pringle, its sorrow and tenderness showing above all things how true a man was her husband."

The Canadian Bee Journal, after publishing a notice of Mr. Pringle's death, said:

"We were shocked to see the above item in The Toronto Daily Globe. The late Mr. Allen Pringle was undoubtedly an able writer. As a bee-keeper he assisted materially in putting bee-keeping before the public in its proper light. Mr. Pringle has held a number of prominent positions in the Ontario Bee-Keepers' Association."

HAMMOND, Ind., Aug. 18, 1896.

MR. YORK:—I regret exceedingly to learn of the sudden death of Allen Pringle. I feel as if I had lost a friend, although I had no acquaintance with him except through the American Bee Journal. I will miss his able, interesting, and incisive articles on apiculture. Truly, our loss is his infinite gain.

RODERICK MCKENZIE.

Gleanings in Bee-Culture had these words from Editor Root:

"While not a prolific writer, what Mr. Pringle did say commanded attention. The diction of his articles was beautifully smooth, and there was something in them, too, that reminded the reader that their author was a scholar of no mean order. A number of years ago, when bee-keepers everywhere were harassed by the reports that were going the rounds of the daily papers, to the effect that honey-comb was manufactured, and filled with glucose, nothing seemed able to stem the tide of it. Editorials in the bee-journals, protesting and denouncing it as untrue, had little or no effect. The "Wiley lie," that gave the start to these reports, appeared originally in the Popular Science Monthly; and Mr. Pringle, appreciating the fact that we were fighting through the wrong channels, conceived the idea of refuting the canard right where it started. The result was, he sent an article to that monthly, denying the comb honey yarn, and explaining how impossible it was to make it. This was given the same prominence as the original Wiley lie, and was subsequently copied widely by the general press. How much effect it had in stopping the course of this famous comb-honey canard it would be impossible to estimate at the present time."

Queens and Queen-Rearing.—

If you want to know how to have queens fertilized in upper stories while the old queen is still laying below; how you may safely introduce any queen, at any time of the year when bees can fly; all about the different races of bees; all about shipping queens, queen-cages, candy for queen-cages, etc.; all about forming nuclei, multiplying or uniting bees, or weak colonies, etc.; or, in fact, everything about the queen-business which you may want to know—send for Doolittle's "Scientific Queen-Rearing"—a book of over 170 pages, which is as interesting as a story. Here are some good offers of this book:

Bound in cloth, postpaid, \$1.00; or clubbed with the BEE JOURNAL for one year—both for only \$1.75; or given free as a premium for sending us three new subscribers to the BEE JOURNAL for a year at \$1.00 each.

Please Send Us the Names of your neighbors who keep bees, and we will send them sample copies of the BEE JOURNAL. Then please call upon them and get them to subscribe with you, and secure some of the premiums we offer.

Dzierzon's Rational Bee-Keeping;

—OR THE—

THEORY AND PRACTICE OF DR. DZIERZON

OF CARLSMARKT, GERMANY.

Translated from the latest German edition by Messrs. H. Dieck and S. Stuttered.
Edited and Revised by Mr. Charles Nash Abbott,
late Editor of the "British Bee Journal."

Price, in cloth, \$1.25; in paper cover, \$1.

This book contains 350 pages, and it describes fully and clearly the methods of bee-keeping used by that famous German apiarist—Dr. Dzierzon. No apiarian library is complete without this work.

Club and Premium Offers.

We will give a copy of the cloth-bound edition for 4 new subscribers to the BEE JOURNAL at \$1.00 each; or the paper-covered book for 3 new subscribers at \$1 each.

We will club the cloth-covered book with the BEE JOURNAL for one year, for \$2.00; or the same in paper for \$1.75—to new or old subscribers. You ought to have it—it is Dzierzon's apicultural master-piece.



GEORGE W. YORK & CO.,

CHICAGO, ILLS.

See the premium offer on page 607!

General Items.

A Good Honey Season.

This has been a good season for honey in this part of the country. We had plenty of rain during the summer, and there is a good prospect for a fall crop of honey, unless we have early frosts. I wintered 12 colonies of bees without any loss, on the summer stands, by placing the hives close together, facing the south, with candy on top of the frames, and chaff cushions over them. The instructions in the production of comb honey, by Rev. E. T. Abbott, in the 1895 Bee Journals, have been of great service to me.

I have taken so far this season about 800 pounds of very nice comb honey.

I enjoy every number of the Bee Journal.
 Mrs. PAUL BARRETTE.
 Prairie du Chien, Wis., Sept. 6.

P. S.—Being a woman, I must needs add a postscript. I forgot to say that I increased my bees by natural swarming to 26 colonies. I wish to thank you for all the good things contained in the Bee Journal the past year. Mrs. P. B.

No Surplus—Introducing Queens.

I have been handling bees in movable-comb hives for 22 years. I think I made the first movable-comb hive in this county. I use a modification of the Quinby hive, holding eight frames 18x10 inches, which I think is about the right size.

I have about 100 colonies of bees in three different yards, but no surplus honey this year. Bees have not made a living since the first of June, owing to the wet weather. There was a heavy linden bloom, but not a drop of nectar. Then came the buckwheat, but no honey yet. The fall bloom comes next, and if it fails, a great many bees will starve before cold weather.

I have tried nearly all of the different races of bees, and like the Italians and Carniolans the best. A cross between the two races is as good a bee as anyone could desire. The best yield of honey I ever got in one year was in 1880, which was a little over 4,000 pounds of extracted honey from 27 colonies, spring count.

I want to give to the readers of the Bee Journal my safe plan of introducing queens: Make the colony hopelessly queenless, by removing the queen and all of the brood and eggs, then cage the queen in the hive for 24 hours; then release her and all will be well.

A. J. McBRIDE.
 Watauga Co., N. C., Aug. 28.

Corn Honey—Moonlight Bees.

I see Dr. Miller "don't know" about bees gathering honey from corn. One season, in Iowa, I had some 300 pounds of corn honey (extracted), but it was gathered from the silk. The nectar fairly glistened on the silk, and it was fun to see the bees scratching and digging into the silk for the nectar.

Now any one that has manufactured maple sugar and boiled it down hard enough to grain good, and put it into a wooden vessel, and let it grain without

THE "NOVELTY" POCKET-KNIFE!



Your Name on the Knife.—When ordering, be sure to say just what Name and Address you wish put on the Knife.

The NOVELTY KNIFE is indeed a novelty. The novelty lies in the handle. It is made beautifully of indestructible celluloid, which is as transparent as glass. Underneath the celluloid, on one side of the handle is placed an AMERICAN BEE JOURNAL reminder, and on the other side, name and residence of the Subscriber.

The material entering into this celebrated knife is of the very best quality; the blades are hand-forged out of the very finest English razor-steel, and we warrant every blade. The bolsters are made of German silver, and will never rust or corrode. The rivets are hardened German silver wire; the linings are plate brass; the back springs of Sheffield spring steel, and the finish of handle as described above. It will last a lifetime, with proper usage.

Why purchase the Novelty Knife? In case a good knife is lost, the chances are, the owner will never recover it; but if the Novelty is lost, having name and address of owner, the finder will return it; otherwise to try to destroy the name and address, would destroy the knife. If traveling, and you meet with a serious accident, and are so fortunate as to have one of the Novelties, your pocket KNIFE will serve as an identifier; and in case of death, your relatives will at once be apprised of the accident.

How appropriate this knife is for a Christmas, New Year or birthday present! What more lasting memento could a mother give to a son, a wife to a husband, a sister to a brother, a lady to a gentleman, or vice versa, a son to a mother, a husband to a wife, a brother to a sister or a gentleman to a lady—the knife having the name of the recipient on one side?

The accompanying cut gives a faint idea, but cannot fully convey an exact representation of this beautiful knife, as the "Novelty" must be seen to be appreciated.

How to Get this Valuable Knife.—We send it postpaid, for \$1.00, or give it as a Premium to the one sending us three new Subscribers to the BEE JOURNAL (with \$3.00), and we will also send to each new name a copy of the Premium Edition of the book "Bees and Honey." We club the Novelty Knife with the BEE JOURNAL for one year, both for \$1.90.

Any Name and Address Put on the Knife.

GEORGE W. YORK & CO.,
 CHICAGO, ILLS.

Allow about two weeks for your order to be filled.

PATENT WIRED COMB FOUNDATION

Has No Sag in Brood-Frames

Thin Flat-Bottom Foundation

Has No Fishbone in the Strips Honey.

Being the cleanest is usually worked the quickest of any Foundation made

J. VAN DEUSEN & SONS,
 Sole Manufacturers,
 Sprout Brook Montgomery Co., N. Y.



ONE MAN WITH THE UNION COMBINATION SAW

Can do the work of four men using hand tools. In Rippling, Cutting-off, Mitring, Rabbeting, Grooving, Gaining, Dadoing, Edging-up, Jointing Stuff, etc. Full Line of Foot and Hand Power Machinery Sold on Trial. Catalogue Free.

SENECA FALLS MFG. CO.,
 46 Water St., SENECA FALLS, N. Y.
 1Aly Mention the American Bee Journal.

WARRANTED GOLDEN

ITALIAN QUEENS By return mail; bred from a Breeder tested by Doolittle out of 1,000 Queens for his own use, and valued at \$50. Queens, 50c; 6 for \$2.75; or \$5.00 per dozen.

Leather Colored Queens from Root's best imported stock same price. Bees from my Queens are excellent workers on red clover. I guarantee safe delivery. N. B.—I sent more than 200 Queens safely to California last season. H. G. QUIRIN, Bellevue, Ohio.

34A9 Mention the American Bee Journal.

SHIPPING - CASES, HONEY - JARS,

—CARTONS, LABELS—

And a Full Line of Supplies.
Comb & Extracted Honey.

I. J. STRINGHAM,
 105 Park Place. NEW YORK, N. Y.
 APIARY—Glen Cove, L. I.



That Queen-Clipping Device Free!

Works Like a Charm.

The Monette Queen-Clipping Device WORKS LIKE A CHARM. With it I have clipped 30 queens, all in one day, when examining my bees. WM. STOLLEY, Grand Island, Nebr.

Couldn't Do Without It.

I have clipped 19 queens, and must say the Monette Queen-Clipping Device is by far the best invention ever made, and will be welcome to many bee-keepers as it was to me. I could not do without one now.

DR. GEO. LACKE, Newburgh, Ind.

PLEASE READ THIS OFFER TO PRESENT SUBSCRIBERS:

Send us just one new name for the American Bee Journal a year (with \$1.00), and we will mail you the Queen-Clipping Device FREE of charge. Or, the Queen-Clipping Device will be sent postpaid for 30 cts. But why not get it as a Premium by the above offer? You can't earn 30 cts. any easier. Almost every bee-keeper will want this Device. See page 130 (Feb. 27) for full description of it. Complete directions accompany each one sent out. It is a most ingenious and useful article. Address,

GEORGE W. YORK & CO., 118 Michigan St., Chicago, Ill.



stirring, knows that the grain is very coarse. Well, the honey from corn was about as near like the coarse-grained maple sugar as it could be, and it had the maple-sugar flavor and color. I have seen bees working on corn silk in this State. They gather lots of pollen from corn tassels.

Mr. J. M. S., on page 551, might not have observed his bees working on the corn silk at the same time they were working on the tassels.

There is one thing I never saw mentioned until a while ago. It is about bees working by moonlight. In Iowa I had a cluster of three large basswood trees, and one large, single tree, right in the apiary, and the bees worked freely on them by moonlight. I don't think my bees were crossed with lightning-bugs, but still they might have been for aught I know.

Bees are still doing splendidly. I drove past several patches of alfalfa in bloom a few days ago, and they were humming with my Italians. One could smell the rich perfume from the blossoms quite a long distance.

DR. E. GALLUP.

Santa Ana, Calif., Aug. 20.

Importance of Decoy Hives.

Last week my "other half" visited with Wm. Suter, one of the oldest and most scientific bee-keepers in the county. The two late disastrous winters nearly cleaned him out of bees. Last spring he kept decoy hives around his yard, and reports nine swarms haying come and taken possession—some of them were immense, great swarms. There is an idea for all of us.

MRS. B. J. LIVINGSTON.

Centre Chain, Minn., Sept. 8.

An Experience with Bumble-Bees.

Wanting to learn some things in regard to handling bees, I was recommended to read the American Bee Journal, with the result that I shortly found what I was looking for, which is probably what happens to all members of the American Bee Journal family, sooner or later.

I had by this time, however, acquired the habit of reading the Bee Journal from title page to Doolittle's funny man. An occasional article on hunting bees would stir me so that I had in mind to rush into print with my very-much-easier way, but soberer second thoughts kept me out, and, anyway, the same favorable conditions do not prevail everywhere.

Then came those stories of A. Cotton, about the youngsters and the originals down his way, so I have to tell him the story, anyway. You may know it was some time ago that it happened, for what is now the finest lawn in Washington Park was then a meadow, where the hay for the Park horses was cut.

My brother and I, while playing "peg" under the trees, noticed the queer antics of the man who was driving the hay-rake. He would jump off while the thing was going, wave his big straw hat in the air until it seemed the horses got scared, and they would buck and try to run with him. He would have a time quieting them, and finally go on with the raking, but he was making a ragged looking job of it. We finally

PROF. A. J. COOK'S BOOK FREE! The Bee-Keeper's Guide OR MANUAL OF THE APIARY.

This 15th and latest edition of Prof. Cook's magnificent book of 460 pages, in neat and substantial cloth binding, we propose to give away to our present subscribers, for the work of getting new subscribers for the American Bee Journal.

A description of the book here is quite unnecessary—it is simply the most complete scientific and practical bee-book published today. Fully illustrated, and all written in the most fascinating style. The author is also too well-known to the whole bee-world to require any introduction. No bee-keeper is fully equipped, or his library complete, without "THE BEE-KEEPER'S GUIDE."

GEORGE W. YORK & CO., 115 Mich. St., CHICAGO, ILL.

✦ MONEY SAVED IS MONEY GAINED. ✦

THE ROYAL UNION Life Insurance Company DES MOINES, IOWA.

The Iowa Policy

Is one that definitely promises to keep an accurate account with you; credit your premiums and interest, charge the actual expense and mortality cost, and hold the remaining funds subject to your order.

Agents Wanted.

JOHN B. KING, GENERAL AGENT,
Suite 513 First Nat'l Bank Bld'g,
20Atf CHICAGO, ILL.

WHEN ANSWERING THIS ADVERTISEMENT, MENTION THIS JOURNAL.

IF YOU WANT THE

BEE-BOOK

That covers the whole Apicultural Field more completely than any other published, send \$1.25 to Prof. A. J. Cook, Claremont, Calif., for his

Bee-Keeper's Guide.

Liberal Discounts to the Trade.

WHEN ANSWERING THIS ADVERTISEMENT, MENTION THIS JOURNAL.

California

if you care to know of its Fruits, Flowers, Climate or Resources, send for a Sample Copy of California's Favorite Paper—

The Pacific Rural Press

The leading Horticultural and Agricultural paper of the Pacific Coast. Published weekly, handsomely illustrated, \$2.00 per annum. Sample Copy Free.

PACIFIC RURAL PRESS,
220 Market St., - SAN FRANCISCO, CAL.

HONEY We have No. 1 Alfalfa, also White and Sweet Clover Honey we will sell cheap.

Honey and Beeswax Wanted.

Boss bee-escape Warranted the best, simplest and quickest Escape on the market. Sent postpaid to any address for 30 cts. It can be returned at our expense if it is not as represented, or we will send the Escape on trial to any bee-keeper wishing to test it in good faith. We are agents for the Ferguson Patent Hive with double-case Super and Wicket-Gate Honey-Board, with the Escape. It is the easiest, quickest hive to handle for the production of comb or extracted honey.

E. S. LOVESY & CO.,

355 6th East St., SALT LAKE CITY, UTAH.
Mention the American Bee Journal. 9Atf

Given For 2 New Subscribers.

The following offer is made to PRESENT subscribers only, and no premium is also given to the two new subscribers—simply the Bee Journal for one year:

Send us Two New Subscribers to the Bee Journal (with \$2.00), and we will mail you a copy of Prof. Cook's book FREE as a premium. Prof. Cook's book alone sent for \$1.25, or we club it with the Bee Journal for a year—both together for only \$1.75. But surely anybody can get only 2 new subscribers to the Bee Journal for a year, and thus get the book as a premium. Let everybody try for it. Will you have one?

Page & Lyon Mfg. Co.,

NEW LONDON, WIS., operates two saw-mills that cut, annually, eight million feet of lumber, thus securing the best lumber at the lowest price for the manufacture of bee-keepers' supplies. They have also just completed one of

The Largest Factories,

and have the latest and most improved machinery for the manufacture of Bee-Hives, Sections, etc., that there is in the State. The material is cut from patterns, by machinery, and is absolutely accurate. For Sections, the clearest and

The Whitest Basswood

is used, and they are polished on both sides. Nearness to pine and basswood forests, and possession of mills and factory equipped with best machinery, all combine to enable this firm to furnish the best goods at

The Lowest Prices. ♡

For instance, it has a job lot of 200,000 No. 2 Sections that will be sold at 50 cts. per 1,000; or 2,000 Snow-White sections will be sold for \$4.00, and larger quantities at still lower prices. Send for Circular and see the prices on a full line of supplies. 16Atf

Mention the American Bee Journal.

BEGINNERS.

Beginners should have a copy of the Amateur Bee-Keeper, a 70-page book by Prof. J. W. Rouse. Price 25 cents; if sent by mail, 28c. The little book and the Progressive Bee-Keeper (a live, progressive 28-page monthly journal) one year, 65c. Address any first-class dealer, or

LEAHY MFG. CO., Higginsville, Mo.

Van Deusen Foundation!

I have some of the celebrated Van Deusen Thin Foundation in 25-pound boxes, that I will put on board cars for \$12.50 per box.

Also ITALIAN

Queens! Queens!

Fine Untested Queens mated PROMPTLY at 45 cts. each, or Six for \$2.40.

Safe delivery and satisfaction guaranteed. Address,

F. GRABBE,

LIBERTYVILLE, Lake Co., ILL.



26Atf Mention the American Bee Journal

Bee-Keeper's Guide—see page 604.

HONEY and BEESWAX

MARKET QUOTATIONS.

The following rules for grading honey were adopted by the North American Bee-Keepers' Association, and, so far as possible, quotations are made according to these rules:

FANCY.—All sections to be well filled; combs straight, of even thickness, and firmly attached to all four sides; both wood and comb unsoiled by travel-stain, or otherwise; all the cells sealed except the row of cells next the wood.

No. 1.—All sections well filled, but combs uneven or crooked, detached at the bottom, or with but few cells unsealed; both wood and comb unsoiled by travel-stain or otherwise.

In addition to this the honey is to be classified according to color, using the terms white, amber and dark. That is, there will be "fancy white," "No. 1 dark," etc.

Chicago, Ill., Sept. 8.—Fancy white, 13c.; No. 1, 11@12c.; fancy amber, 9@10c.; No. 1, 8c.; fancy dark, 8@9c.; No. 1, 8c. Extracted, white, 5@7c.; amber, 5@6c.; dark, 4½c. Beeswax, 25c.

Comb honey is beginning to move at these prices, and we look for an active trade from now on.

Philadelphia, Pa., Aug. 14.—Extracted, white, 8-10c.; amber, 4-5c.; dark, 3-4c. Beeswax, 25c.

No new comb in this market yet. Old comb cleaned out.

Detroit, Mich., Aug. 8.—No. 1 white, 12-12½c.; fancy amber, 10-11c.; No. 1 amber, 9-10c.; fancy dark, 8-9c. Extracted, white, 5½-6c.; amber, 5-5½c.; dark, 4-5c. Beeswax, 24-25c.

Cincinnati, Ohio, July 10.—No. 1 white, 13@14c.; fancy amber, 12@13c.; No. 1 amber, 10@12c. White, extracted, 5@7c.; amber, 5@6c.; dark, 3½-5c. Beeswax, 20-25c.

Indianapolis, Ind., July 28.—Fancy white, 15-16c.; No. 1 white, 13-14c. Extracted, white, 6-7c. Beeswax, 25-27c.

No demand at all for off grades of either comb or extracted honey. Large fruit crop and warm weather are opponents to the demand for honey at present.

St. Louis, Mo., Aug. 8.—Fancy white, 13@14c.; No. 1 white, 12@12½c.; fancy amber, 11@11½c.; No. 1 amber, 10@10½c.; fancy dark, 8@9c.; No. 1 dark, 7@7½c. Extracted, white, in cans, 5c.; in barrels, 4@4½c.; amber, 3@3½c.; dark, 2½@3c. Beeswax, 19@20c.

Very little honey coming in at present, and the weather is too warm to handle to advantage if it were here.

Albany, N. Y., Sept. 8.—Best white, 14c.; buckwheat and mixed grades, 9-12c. Extracted, white, 6½-7½c. Beeswax wanted at 28-30c.

The honey market is opening now. Demand and receipts are light so far, but we look for better demand soon as the weather changes colder. Although we do not expect old-fashioned prices, we believe there will be a large consumption at the prevailing prices, and that early market will be the best. Don't hold honey until cold weather, for it don't give satisfaction to either buyer or seller then. White extracted is wanted now, and his is the time to sell it for bottling. Other grades of extracted are slow yet.

San Francisco, Calif., Sept. 2.—White comb, 10-11c.; amber, 7½-9c. Extracted, white, 5-5½c.; light amber, 4½-4¾c.; amber colored and candied, 3¾-4c.; dark tulle, 2¾-3c.

There are moderate quantities of new-crop comb honey offering, including some of excellent quality, but no new-crop extracted worth mentioning has yet arrived, and very little of the latter is expected this season. The little business in progress is wholly on local account.

Beeswax, fair to choice, 22-25c. There is a fair inquiry for such as can be guaranteed strictly pure. Where there is any suspicion of adulteration, buyers give offerings the go-by.

New York, N. Y., Sept. 9.—Fancy white, 13c.; No. 1, 12c.; fancy amber, 11c.; No. 1, 10c.; dark, 9c. Beeswax declining; 23@24c. s now top price.

New crop comb honey is now arriving freely. The demand is fair only, and mostly for small lots of 10 to 25 crates. Some exceptionally fine lots will probably sell for a little more. No change in extracted, with plenty of supply.

Milwaukee, Wis., Aug. 8.—Fancy white, 14-15c.; No. 1, 12-13c.; No. 1 amber, 8-10c. Extracted, white, 6-7c.; amber, 5-6c.; dark, 4-5c. Beeswax, 22-24c.

New crop of honey begins to come forward. The demand is very poor and quotations almost nominal. Weather is very warm and the consumption of honey is very small. Plenty of fruit, and hence the appetite is satisfied with same in preference. Later on we expect an improved demand for honey of all kinds.

Minneapolis, Minn., Aug. 8.—Fancy white, 12½c.; No. 1 white, 10@11c.; fancy amber, 9@10c.; No. 1 amber, 8@9c.; fancy dark, 7@8c.; No. 1 dark, 6-8c. Extracted, white, 5½@6½c.; amber, 5@5½c.; dark, 4@5c. Beeswax, 23@26c.

The demand for both comb and extracted is very quiet, and for the latter, nominal. The hot weather of the past week or so has checked demand for comb honey.

Cleveland, Ohio, Aug. 8.—Fancy white, 14½@15c.; No. 1 white, 12½@13c. Extracted, white, 6@7c.; amber, 4½@5½c. Beeswax, 22@25c.

There is not very much honey in our market. Selling rather slow. Demand beginning to be a little better. Think trade will be fair in this line this fall.

Kansas City, Mo., Aug. 8.—Fancy white comb, 15c.; No. 1 white, 13@14c.; fancy amber, 12-13c.; No. 1 amber, 11-12c.; fancy dark, 10-11c.; No. 1, 8-10c. Extracted, white, 6-6½c.; amber, 5 5½c.; dark, 4-4½c. Beeswax, 22-25c.

Boston, Mass., Aug. 10.—Fancy white, 14-15c.; No. 1, 12-13c.; fancy amber, 9-10c. Extracted, white, 6-7c.; amber, 5-6c. Beeswax, 25c.

Good supply of new honey, but demand is light this very hot weather.

Buffalo, N. Y., Sept. 12.—Fancy comb, 1-pound, is selling some better, at about 11-12c., and some at 10c.; No. 2, 8-9c.; No. 3, etc., 3-6c. Extracted, 3-6c.

When fruit is over we anticipate better honey trade. Our best outlets at moderate prices.

List of Honey and Beeswax Dealers.

Most of whom Quote in this Journal.

Chicago, Ills.

R. A. BURNETT & Co., 163 South Water Street.

New York, N. Y.

HILDRETH BROS. & SEOLKEN, 120 & 122 West Broadway.

CHAS. ISRAEL & BROS., 486 Canal St.

Kansas City, Mo.

C. C. CLEMOMS & Co., 423 Walnut St.

Buffalo, N. Y.

BATTERSON & Co., 167 & 169 Scott St.

Hamilton, Ills.

CHAS. DADANT & SON.

Philadelphia, Pa.

WM. A. SELSER, 10 Vine St.

Cleveland, Ohio.

WILLIAMS BROS., 80 & 82 Broadway.

St. Louis, Mo.

WESTCOTT COM. CO., 213 Market St.

Minneapolis, Minn.

S. H. HALL & CO.

Milwaukee, Wis.

A. V. BISHOP & CO.

Boston, Mass.

E. E. BLAKE & Co., 57 Chatham Street.

Detroit, Mich.

M. H. HUNT, Bell Branch, Wayne Co., Mich.

Indianapolis, Ind.

WALTER S. POWDER, 162 Massachusetts Ave.

Albany, N. Y.

CHAS. MCCULLOCH & Co., 380 Broadway.

Cincinnati, Ohio.

C. F. MUTH & SON, cor. Freeman & Central avs.

went over there to find what the trouble was.

"Trouble enough," said he. "This field is full of bumble-bees, and if you had any spunk you could get the honey."

That was enough. Visions of sweets were too much for us, and at it we went. Our hats proved a poor thing to fight Bombus with, but we got a nest, and found about a third was honey, the balance brood, and the sealed cells contained only brood, or rather that was what our parents told us those white grubs were.

The next day we were ready for the fray, only we fashioned some bats out of a shingle, and a play-mate joined the party. We soon got a nest, and with the previous day's experience in mind, says I, "Now Tom, as you're the largest, we'll give you the most." Breaking off the unsealed brood, I bit out half the honey, and my brother took the rest and handed him the sealed cells. After eating a while on that, says Tom, "I don't believe I like this wild honey; and so I'll help hunt the bees, but you can have my share." W. B. CHAPMAN.

Chicago, Ill.

P. S.—Tom got even later, but it was a long while later, and that is another story, anyway.

—An Extra-Fine Grade of—

Comb Honey!

Any one wishing something very nice in White Clover or Basswood Comb or Extracted

HONEY

for exhibition or any purpose where a gilt-edge article is desired, should write for prices and particulars to,

JEWELL TAYLOR,

35A4t

FORESTVILLE, MINN.



INCUBATION

is the first step in the poultry business and much of future success depends upon its completeness. There is no failure where RELIABLE INCUBATOR is used. It is fully warranted and is the product of twelve years of experience. It has never been beaten in a Show. It is not like its competitors—it is better. We tell why in new book on poultry. Send 10c for it. RELIABLE INCUBATOR AND BROODER CO., QUINCY, ILLS.

36E17t Please mention the Bee Journal.

Sweet Clover 1/2 Canada.

At the following prices:

5 lbs.	10 lbs.	25 lbs.	50 lbs.
\$1.00	\$1.60	\$3.75	\$7.25.

Also a quantity of Notherwort and Catnip seed. Prices on application.

EGGS for Hatching. Buff Leghorns, Indian Games, & Light Brahmas. Choice Birds. A breeder for 30 years. Prices on application

JOHN MCARTHUR,

881 Yonge Street, TORONTO, ONT.
15A4t Mention the American Bee Journal.

WOVEN WIRE FENCE

Over 50 Styles The best on Earth. Horse high, Bull strong, Pig and Chicken tight. You can make from 40 to 60 rods per day for from 14 to 22c. a Rod. Illustrated Catalogue Free. KITSELMAN BROS., Ridgeville, - Indiana.

48E1f Mention the American Bee Journal.

BEE-BOOKS

SENT POSTPAID BY

George W. York & Co.,
Chicago, Ills.

Bees and Honey, or Management of an Apiary for Pleasure and Profit, by Thomas G. Newman.—This edition has been largely re-written, thoroughly revised, and is "fully up with the times" in all the improvements and inventions in this rapidly-developing pursuit, and presents the apiarist with everything that can aid in the successful management of an apiary, and at the same time produce the most honey in an attractive condition. It contains 250 pages, and 245 illustrations—is beautifully printed in the highest style of the art, and bound in cloth, gold-lettered. Price, \$1.00.

Langstroth on the Honey-Bee, revised by Dadant—This classic in bee-culture, has been entirely re-written, and is fully illustrated. It treats of everything relating to bees and bee-keeping. No apiarian library is complete without this standard work by Rev. L. L. Langstroth—the Father of American Bee-Culture. It has 520 pages; bound in cloth.

Price, postpaid, \$1.25.

Bee-Keepers' Guide, or Manual of the Apiary, by Prof. A. J. Cook, of the Michigan Agricultural College.—This book is not only instructive and helpful as a guide in bee-keeping, but is interesting and thoroughly practical and scientific. It contains a full delineation of the anatomy and physiology of bees. 400 pages; bound in cloth and fully illustrated.

Price, postpaid, \$1.25.

Scientific Queen-Rearing, as Practically Applied, by G. M. Doolittle.—A method by which the very best of Queen-Bees are reared in perfect accord with Nature's way. 125 pages, bound in cloth, and illustrated. Price, \$1.00.

A B C of Bee-Culture, by A. I. Root.—A cyclopædia of 400 pages, describing everything pertaining to the care of the honey-bees. It contains 300 engravings. It was written especially for beginners. Bound in cloth. Price, \$1.25.

Advanced Bee-Culture, Its Methods and Management, by W. Z. Hutchinson.—The author of this work is too well known to need further description of his book. He is a practical and entertaining writer. You should read his book. 90 pages, bound in paper, and illustrated. Price, 50 cts.

Rational Bee-Keeping, by Dr. John Dzierzon.—This is a translation of his latest German book on bee-culture. It has 350 pages; bound in cloth, \$1.25; in paper covers, \$1.00.

Bienen-Kultur, by Thomas G. Newman.—This is a German translation of the principal portion of the book called BEES OF HONEY. 100 page pamphlet. Price, 40 cents.

Convention Hand-Book, for Bee-Keepers. — Thomas G. Newman.—It contains the parliamentary law and rules of order for Bee-Conventions—also Constitution and By-Laws, with subjects for discussion, etc. Cloth, gold-lettered. Price, 25 cts.

Thirty Years Among the Bees, by Henry Alley.—Gives the results of over a quarter-century's experience in rearing queen-bees. Very latest work of the kind. Nearly 100 pages. Price, 50c.

Why Eat Honey?—This Leaflet is intended for FREE distribution, to create a Local Market. 100 copies, by mail, 40 cts.; 500 for \$1.50; 1000, \$2.50. If 500 or more are ordered at one time, your name and address will be printed on them FREE.

How to Keep Honey and preserve its richness and flavor. Price same as Why Eat Honey.

Apiary Register, by Thos. G. Newman.—Devotes two pages to a colony. Leather binding. Price, for 50 colonies, \$1.00; for 100 colonies, \$1.25.

Preparation of Honey for the Market, including the production and care of comb and extracted honey. A chapter from BEES AND HONEY. Price, 10 cents.

Bee-Pasturage a Necessity.—This book suggests what and how to plan. It is a chapter from BEES AND HONEY. Price, 10 cents.

The Hive I Use, by G. M. Doolittle. It details his management of bees, and methods of producing comb honey. Price, 5 cents.

Dr. Howard's Book on Foul Brood.—Gives the McEvoy Treatment and reviews the experiments of others. Price, 25 cts.

Dictionary of Apiculture, by Prof. John Phil. Gives the correct meaning of nearly 500 apicultural terms. Price, 50 cts.

Winter Problem in Bee-Keeping, by G. R. Pierce. Result of 25 years' experience. 50 cts.

Handling Bees, by Chas. Dadant & Son.—A Chapter from Langstroth Revised. Price, 8 cts.

Bee-Keepers' Directory, by H. Alley.—Latest methods in Queen-Rearing, etc. Price, 50c.

Foul Brood Treatment, by Prof. F. R. Cheshire.—Its Cause and Prevention. Price, 10 cts.

Foul Brood, by A. R. Kohnke.—Origin, Development and Cure. Price, 25 cts.

History of Bee-Associations, and Brief Reports of the first 20 conventions. Price, 15 cts.

Honey as Food and Medicine, by T. G. Newman.—A 32-page pamphlet; just the thing to create a demand for honey at home. Should be scattered freely. Contains recipes for Honey-Cakes, Cookies, Puddings, Foam, Wines, and uses of honey for medicine.

Prices, prepaid—Single copy, 5 cts.; 10 copies, 35 cts.; 50 for \$1.50; 100 for \$2.50; 250 for \$5.50; 500 for \$10.00; or 1000 for \$15.00.

When 250 or more are ordered, we will print the bee-keeper's card (free of cost) on the front cover page.

Bee-Keeping for Profit, by Dr. G. L. Tinker.—Revised and enlarged. It details the author's "new system, or how to get the largest yields of comb or extracted honey." 80 p.; illustrated. 25c.

Emerson Binders, made especially for the BEE JOURNAL, are convenient for preserving each number as fast as received. Not mailable to Canada. Price, 75 cts.

Commercial Calculator, by C. Ropp.—A ready Calculator, Business Arithmetic and Account-Book combined in one. Every farmer and business man should have it. No. 1, bound in water proof leatherette, calf finish. Price, 40 cts. No. 2, in fine artificial leather, with pocket, silicate slate, and account-book. Price, 60 cts.

Green's Four Books, by Chas. A. Green.—Devoted to, 1st, How We Made the Old Farm Pay; 2nd, Peach Culture; 3rd, How to Propagate Fruit-Plants, Vines and Trees; 4th, General Fruit Instructor. Nearly 120 pages. Fully illustrated. 25 cts.

Green's Six Books on Fruit-Culture, by Chas. A. Green.—Devoted 1st, to Apple and Pear Culture; 2nd, Plum and Cherry Culture; 3rd, Raspberry and Blackberry Culture; 4th, Grape Culture; 5th, Strawberry Culture. 129 pp.; illustrated. 25 cts.

Garden and Orchard, by Chas. A. Green.—Gives full instructions in Thinning and Marketing Fruits; Pruning, Planting and Cultivating; Spraying, Evaporation, Cold Storage, Etc. 94 pages, illustrated. Price, 25 cts.

Kendall's Horse-Book.—35 pictures, showing positions of sick horses, and treats on all their diseases. English or German. Price, 25 cts.

Silo and Silage, by Prof. A. J. Cook.—It gives the method in operation at the Michigan Agricultural College. Price, 25 cts.

Lumber and Log-Book.—Gives measurements of lumber, logs, planks; wages, etc. 25c.

Maple Sugar and the Sugar Bush, by Prof. A. J. Cook.—Full instructions. Price, 35 cts.

Grain Tables, for casting up the price of grain, produce, hay, etc. Price, 25 cts.

Capons and Caponizing, by Dr. Sawyer, Fanny Field, and others.—Illustrated. All about caponizing fowls, and thus how to make the most money in poultry-raising. 64 pages. Price, 30 cts.

Our Poultry Doctor, or Health in the Poultry Yard and How to Cure Sick Fowls, by Fanny Field.—Everything about Poultry Diseases and their Cure. 64 pages. Price, 30 cts.

Poultry for Market and Poultry for Profit, by Fanny Field.—Tells everything about the Poultry Business. 64 pages. Price, 25 cts.

Turkeys for Market and Turkeys for Profit, by Fanny Field.—All about Turkey-Raising. 64 pages. Price, 25 cts.

Rural Life.—Bees, Poultry, Fruits, Vegetables, and Household Matters. 100 pages. 25 cts.

Potato Culture, by T. B. Terry.—It tells how to grow them profitably. Price, 40 cts.

Hand-Book of Health, by Dr. Foote.—Hints about eating, drinking, etc. Price, 25 cts.

Alsike Clover Leaflet.—Full directions for growing. 50 for 25 cts.; 100 for 40 cts.; 200, 70c.

Book Clubbing Offers.

(Read Carefully.)

The following clubbing prices include the American Bee Journal one year with each book named. Remember, that only one book can be taken in each case with the Bee Journal a year at the prices named. If more books are wanted, see postpaid prices given with

the description of the books on this page. Following is the clubbing-list:

1. Langstroth on the Honey-Bee.....	\$2.00
2. A B C of Bee-Culture.....	2.00
3. Bee-Keepers' Guide.....	1.75
4. Bees and Honey [Cloth bound].....	1.65
5. Scientific Queen-Rearing.....	1.75
6. Dr. Howard's Foul Brood Book.....	1.10
7. Advanced Bee-Culture.....	1.30
9. Bienen-Kultur [German].....	1.25
10. Rational Bee-Keeping [Cloth bound].....	2.00
11. Rational Bee-Keeping [Paper bound].....	1.75
12. Thirty Years Among the Bees.....	1.30
13. Bee-Keeping for Profit.....	1.15
14. Convention Hand-Book.....	1.15
15. Poultry for Market and Profit.....	1.10
16. Turkeys for Market and Profit.....	1.10
17. Capons and Caponizing.....	1.10
18. Our Poultry Doctor.....	1.10
19. Green's Four Books.....	1.15
20. Green's Six Books on Fruit-Culture.....	1.15
21. Garden and Orchard.....	1.15
23. Rural Life.....	1.10
24. Emerson Binder for the Bee Journal.....	1.60
25. Commercial Calculator, No. 1.....	1.25
26. Commercial Calculator, No. 2.....	1.40
27. Kendall's Horse-Book.....	1.10
30. Potato Culture.....	1.20
32. Hand-Book of Health.....	1.10
33. Dictionary of Apiculture.....	1.35
34. Maple Sugar and the Sugar Bush.....	1.20
35. Silo and Silage.....	1.10
36. Winter Problem in Bee-Keeping.....	1.30
37. Apiary Register (for 50 colonies).....	1.75
38. Apiary Register (for 100 colonies).....	2.00
39. Bee-Keepers' Directory.....	1.30

Convention Notices.

TENNESSEE.—The Southern East Tennessee Bee-Keepers' Association will hold its annual meeting at Cookson's Creek, on Oct. 10, 1896. Session will open at 9 o'clock a.m. All are invited to attend, and especially those engaged in bee-culture. W. J. COPELAND, Sec. Fetzertown, Tenn.

MINNESOTA.—The annual meeting of the Southern Minnesota Bee-Keepers' Association will be held in Winona, on September 24 and 25, 1896, at 9 o'clock, a.m. All that feel in any way interested in bees or honey are cordially invited to attend. Winona, Minn. E. C. CORNWELL, Sec.

WISCONSIN.—The annual meeting of the Southwestern Wisconsin Bee-Keepers' Association will be held at Wauzeka, Wis., Oct. 7 and 8, 1896. All that are interested in apiculture are invited to attend, and especially those that want a foul brood law to protect their bees from this dread disease. Our committee is working hard to get every bee-keeper interested, and we should all feel it is for our interest to help get a State law to protect our bees. Many of our prominent bee-keepers of the State have promised to be at our meeting, and no one can afford to miss it. Boscobel, Wis. M. M. RICE, Sec.

North American Bee-Keepers' Association

OFFICERS FOR 1896.

PRESIDENT—A. I. Root..... Medina, Ohio.
VICE-PRES.—Wm. McEvoy..... Woodburn, Ont.
SEC.—Dr. A. B. Mason..... Sta. B. Toledo, Ohio
TREAS.—W. Z. Hutchinson..... Flat, Mich
Convention at Lincoln, Nebr., Oct. 7 & 8.

National Bee-Keepers' Union.

PRESIDENT—Hon. R. L. Taylor..... Lapeer, Mich
GEN'L MGR.—T. G. Newman..... San Diego, Cal

What They All Say!

The Queen you sent me is the finest I ever had, and I have bought them all over the country. I am glad I can get the best right at home. Find \$1.00 for another.

MASON E. MARVEL,
Aug. 16, 1896. Oakland, Mass.

The above Queen was an Adel. I have 300 more just like her. Hardy, prolific, great honey-gatherers and practically non-swarming and non-stinging. New 4-page Catalog, giving history of the Adels and safest method of introducing Queens, sent free.

HENRY ALLEY, Wenham, Mass.
35Atf Mention the American Bee Journal

THE GREAT CAMPAIGN

—OR—

Political Struggles of Parties, Leaders and Issues

COMPRISING

Biographies of the Republican, Democratic, Populistic, Prohibition and National Nominees for President and Vice-President of the United States.

—ALSO—

The Platforms, Principles and Leaders of All Parties

DISCUSSING

ALL VITAL QUESTIONS OF THE DAY

HAVING AS ITS OBJECT

The Enlightenment and Education of American

—VOTERS—

Upon the Living Issues of the Hour.

The Gold Standard of Currency, Bi-Metalism, Free Coinage of Silver, High Protective Tariff, Tariff for Revenue Only, Prohibition, Licensed Liquor Traffic, the Doctrine of Reciprocity, the Monroe Doctrine, Laws Governing Our Relations with Other Nations, the Venezuelan, Armeoian and Cuban Questions. Containing also Lives and Portraits of former Presidents, with a Review of their Administrations and the Political Lessons gleaned from them; together with a Portrait Gallery of Statesmen and Political Celebrities comprising 100 accurate Phototypes and other Portraits, embracing the most active and prominent statesmen in our Nation. The whole forms a Voter's Hand-Book of Political Information, thoroughly practical, enjoyable and instructive, enabling him to vote intelligently upon those vital subjects which constitute the living issues of the present great campaign.

This book embodies the views and opinions of the great leaders from the various party poluts of view, clearly explaining all the momentous questions now before the people. It is planned upon the broad principles of non-partisan national patriotism, and attacks no man's creed, and upholds the ban-



McKinley.



Bryan.

ner of no party; but placing every party and its principles, with its leaders upon its own platform, and bringing the several parties, platforms and champions in their true light before the mind of the reader, the intelligent citizen will, in this book, be enabled to view and compare them side by side and judge of their respective claims upon his vote as an

American citizen. It is a vast storehouse of truth, plain, simple and unvarnished, which makes this work an unequalled source of information upon the great issues of this campaign, suited to the wants of every voter irrespective of party and without partisan bias.

Our Country calls for thirteen million volunteers. "I do love my country's good with a respect more tender, more holy



Leveing.



Bentley.

and profound than mine own life," is the language which Shakespeare puts into the mouth of an ideal patriot. May this sentiment find a universal echo in the hearts of the voters of the United States of America who go to the polls in November, 1896.

Great questions are to be settled; a mighty battle is to be fought; a battle of ballots such as this country has never witnessed, which, in its far-reaching effects, will accomplish on the field of American suffrage, at the Ballot Box, next November, results as potential for good or evil to our Nation, revolutions as radical, and effects as lasting upon our institutions, as were ever wrought upon the field where sword and bullet, grape and canister settled the issue of the hour.

An impartial view of the situation reveals the fact that our Country ever needed more broad-minded wisdom and unselfish patriotism in all her history than she requires to guide her through the present crisis.

Since the rising war cloud of 1859-60 which deluged our Country in the blood of brothers, our Nation has not been so agitated, divided and excited as it is to-day from ocean to ocean—North, South, East and West, on the great financial question, which is a vital issue of this campaign; and its settlement is fraught with threatenings and omeas indicating political combinations, upheavals and surprises which our shrewdest politicians seem numindful of or unwilling to recognize.

Since 1873 the mutterings of discontent have been growing louder between the advocates of Gold and Bi-metal standards. During the past three years, these mutterings have grown into clamorous shouts and peremptory demands on both sides. Statesmen never thought so diligently or more deeply on any subject; and the whole country never was so eager to have all sides of this momentous question presented in a clear, lucid and intelligible manner which the common reader can understand—the money question.

The Doctrine of Reciprocity is also treated at length from a broad, patriotic and non-partisan point of view.

This volume contains about 600 pages, is printed on super-calendered paper, and bound in beautifully lithographed board covers. The pictures of the four principal Presidential candidates shown herewith appear on the front outside cover, and the Vice-Presidential candidates on the back cover.

How to Get the Above Book.

Send \$1.00 and receive it postpaid. Or, send us two new subscribers for the Bee Journal at \$1.00 each, and we will mail you the book free as a premium. Or, for \$1.75, we will mail you the book and the Bee Journal for one year. Address,

GEORGE W. YORK & CO.,

118 Michigan Street,

CHICAGO, ILL.

Bottom Prices

**BRING US BIG TRADE.
GOOD GOODS KEEP IT.**

If you want the best supplies that can be made at a little less cost than you can buy the same goods for elsewhere, write to us for low prices. 1896 Catalogue now ready—ask for it and a free copy of **The American Bee-Keeper** (36 pages).

Address,
**THE W. T. FALCONER MFG. CO.,
JAMESTOWN, N. Y.**

Mention the American Bee Journal.

COMB FOUNDATION!

Wax always wanted for Cash or in Exchange for Fdn. or other Supplies. My trade is established on **Low Prices** and the merit of my **Foundation**. Orders filled promptly.

WORKING WAX INTO FDN. BY THE LB. A SPECIALTY. Wholesale prices to dealers and large consumers. Send for Prices and Samples to—**GUS DITTMER, AUGUSTA, WIS.** Reference—Augusta Bank. 1Atf

Mention the American Bee Journal.

Honey-Clovers & Buckwheat

SEED FOR SALE.

We have made arrangements so that we can furnish seed of several of the Clovers and Japanese Buckwheat, by freight or express, at the following prices, cash with order

	5lb	10lb	25lb	50lb
Alsike Clover	\$.70	\$1.25	\$3.00	\$ 5.75
Sweet Clover	.75	1.40	3.25	6.00
White Clover	1.25	2.00	4.50	8.00
Alfalfa Clover	.65	1.10	2.70	5.00
Crimson Clover	.55	.90	2.00	3.50
Jap. Buckwheat	.20	.35	.90	1.25

Prices subject to market changes.

Add 25 cents to your order, for cartage, if wanted by freight.
Your orders are solicited.

**GEORGE W. YORK & CO.,
CHICAGO, ILLS.**

MUTH'S HONEY EXTRACTOR

PERFECTION
Cold-Blast Smokers,

Square Glass Honey Jars, Etc.

For Circulars, apply to **CHAS. F. MUTH & SON,** Cor. Freeman & Central Aves., Cincinnati, O. Send 10c for Practical Hints to Bee-Keepers.

Mention the American Bee Journal.

A Bargain—EARLY QUEENS.

119 Colonies Italian Bees in Chaff Hives; two acres land; good house; excellent well.

Early Queens—Tested, \$1.00; Untested, 50c. Sent by return mail.

E. L. CARRINGTON,
16Atf PETTUS, Bee Co., TEX.
Reference—1st National Bank of Beeville.

Mention the American Bee Journal.

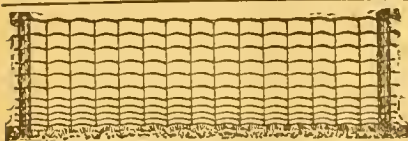

FOUR TO ONE!

Our wonderful success with the leading railroads, has led some people to think our farm trade had taken second place. This is a mistake, as our books show that for every 1000 miles sold railroads, 4000 miles have gone to the farmers. Railroad men buy Page fence because it suits adjoining farmers.

PAGE WOVEN WIRE FENCE CO., Adrian, Mich.

Mention the American Bee Journal.

19th Year Dadant's Foundation 19th Year

It still in the lead, for we use all the latest improvements, including the

NEW WEED PROCESS,

and still make the best goods. Remember that we do not use any acid to purify our beeswax, and that is why our Foundation preserves the smell of the honey and is more acceptable to the bees, than any other. It is kept for sale by

T. H. Strickler, Solomon City, Kansas.
G. K. Hubbard, Fort Wayne, Ind.
L. Hansen, Davenport, Iowa.
C. Theilmann, Theilmann, Minn.
E. C. Eaglesfield, Berlin, Wis.
E. T. Abbott, St. Joseph, Mo.
J. M. Jenkins, Wetumpka, Alabama
John Rey, East Saginaw, Mich.
Vickery Bros., Evansville, Ind.

The Jennie Atchley Company, Beeville, Texas.
C. F. Muth & Son, Cincinnati, Ohio
E. Kretzmer, Red Oak, Iowa.
G. B. Lewis Co., Watertown, Wis.
James Reynolds Elevator Co., Poughkeepsie, N. Y.
Louisiana Bee-Keepers' Supply Manufactory, Donaldsonville, La.
Page & Lyon, New London, Wis.
John Nebel & Son, High Hill, Mo.

and many other Dealers. All agree in saying that no goods are better than ours.

We make a specialty of **Veils and Veil Stuffs** of best quality, cotton and silk.

Langstroth on the Honey-Bee, Revised

Bee-Keepers' Supplies, Smokers, Sections, Tin Pails, etc.

Samples of Foundation and Tulle FREE with Circular. Instructions to beginners with Circular. Send us your address.

CHAS. DADANT & SON,

Mention the American Bee Journal.

HAMILTON, Hancock Co., ILL.

See Campaign Book Offer on page 607! Better Have It!

* Extracted Honey *



Finest Quality. Basswood and Clover.

2 60-lb. cans in case, 8c. per pound. 1 60-lb. can in case, 9c. per pound. A sample by mail, 10 cts. **POUDER'S Honey-Jars and Complete Line of Supplies.** Catalogue Free.

WALTER S. POUDER,
162 Mass. Avenue, INDIANAPOLIS, IND.

Mention the American Bee Journal.

Jars : Cans : Cases !

Muth pattern Square Flint Glass Jars 1-lb., per gross, \$4.75; ½-lb., per gross, \$3.80.

Square 60-lb. Tin Cans, two in a box, per box, 65c.; 10 boxes, \$6.00.

Shipping-Cases, 10 24-lb. cases, \$1.30; 10 12-lb. cases, 80c.

W. J. FINCH, Jr., SPRINGFIELD ILLS.

Mention the American Bee Journal.

Good Prices on Your Comb Honey!

Then you want our latest

NON-DRIP SHIPPING-CASES.

Our trade was never so large in these as now; and Commission Men tell us that Comb Honey in our Cases brings

BETTER PRICES

than some of the Cases made by competitors. The fact is, we know the demands of the trade, and are prepared to supply them. Remember, home-made or poorly made Cases are dear at any price. Honey in such Cases always brings several cents below the market price.

If you wish to get **GILT-EDGE PRICES** on **GILT-EDGE HONEY** put it up in

Root's Non-Drip Shipping-Cases.

THE A. I. ROOT COMPANY,

Factory and Main Office, **MEDINA, O.**

BRANCH OFFICES:

**118 Michigan St., Chicago, Ill.
1024 Miss. Str., St. Paul, Minn.**

**Syracuse, N. Y.
Mechanic Falls, Maine.**

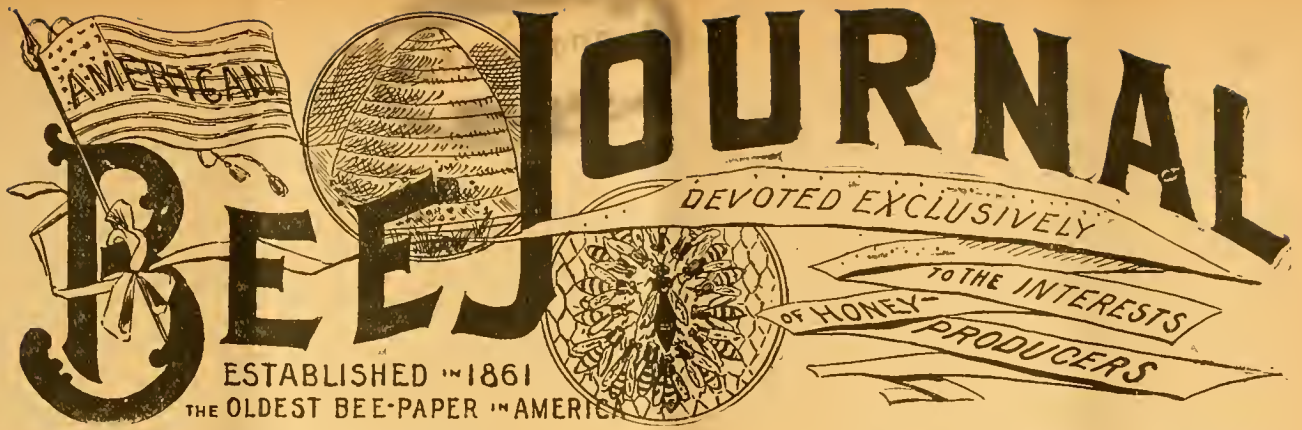

AMERICAN BEE JOURNAL

DEVOTED EXCLUSIVELY TO THE INTERESTS OF HONEY-PRODUCERS

ESTABLISHED 1861
THE OLDEST BEE-PAPER IN AMERICA

Published Weekly, at \$1.00 per annum.

Sample Copy sent on Application.

36th Year.

CHICAGO, ILL., SEPTEMBER 24, 1896.

No. 39.



Those Large Hives—Questions Answered.

BY C. P. DADANT.

We have received the following questions from a Canadian reader of the American Bee Journal:

1. I would like to ask the Dadants, through the American Bee Journal, several questions about those large hives. If I understand them rightly they would use a frame as long as the Langstroth and 12 inches deep. Is there not danger of a comb of that size, when filled with brood and honey, breaking down in warm weather?

2. Do you hive your swarms on heavy brood foundation, wired? And would you still keep those large hives in a country where the mercury sometimes goes down to 22° below zero?

I do not want as many swarms as I have been having this year; for it has caused me more trouble than I care to have, to keep running the swarms back again. W. B. Stratford, Ont., Canada.

The hive originally invented by M. Quinby, and which we are now using with a few changes, is not made to contain frames 12 inches deep, the hive itself being, on the outside, only a trifle over 12 inches in depth. The frames have a side-bar 11¼ inches deep, the entire frame measuring on the outside 11½ inches. If we did not have several hundred hives of this style in use, and were to begin anew, we should first of all avoid building a hive over 11¼ inches deep, owing to the difficulty of procuring lumber in any quantity wider than the common 12-inch stock board. Using this lumber would give us room for a frame about 10¼ inches in depth.

Replying to the first question asked by W. B., we will say that we have had no trouble with combs breaking down, since we have used Mr. Langstroth's instructions concerning the care of hives in hot weather. If the hive is so ventilated that the bees are enabled to keep the temperature at a normal point there is no danger of the combs breaking down. But let the clustering bees on the outside clog up the entrance, the ventilation is interrupted, and the result is disastrous, even with very shallow hives. This is clearly evidenced to us by the fact that whenever we have had combs breaking down by heat, those of the 6-inch super stood no better than the others—they all went together, age being the only safeguard, as the old combs are all more or less strengthened by the cast-skins of the larvæ which have been reared in the cells.

The hiving of the swarms, when we have no empty combs on hand, is all made of heavy foundation, wired horizontally, especially at the top, for we have ascertained that the greatest danger to foundation was due to the cluster hanging on it before it is properly fastened by the bees, and the wire helps to hold it in place till the bees have adjusted it.

As to the second question asked—whether we would keep those large hives in a country where the mercury sometimes goes down to 22° below zero—we reply yes, emphatically. It is really one of the main points that the deeper brood-chamber accommodates the bees better in a long-protracted cold spell than the shallow frame, for there is more honey above the bees in the first case. It is much more easy for them to move upwards to where the heat is concentrated than to move sidewise. We know that in an ordinary winter they will readily move sidewise, apparently as readily as upwards; but we know also that there are winters during which the bees starve on the frames by the side of a quantity of honey which they are unable to reach, owing to the cold. During the hard winters we have always lost more bees in the regular Langstroth frame than in any other style, and we have had only about one-fourth of our bees in this style, at the outside.

We have some 60 colonies in the American style (frames 13 inches deep)—have had them for 25 years or more, and they always winter best. The only objection which we have to this style of frame is that it gives less surplus room above the brood-combs than the other kinds, the former being only 12 inches long.

W. B. is not the only man who gets tired of the bother of hiving swarms; we find that most of our proselytes follow our methods most especially for that reason. The man who produces comb honey in small hives finds this the greatest hindrance to success.

Dr. Miller's query as to the cause of some of his bees swarming when given a second story of eight frames on top of the first, while his 14-frame hives did not swarm (see page 501), seems to me to furnish his own reply. In the latter case the bees have had plenty of room right along, while in the first instance he waited till the "one story was well filled." These bees did not know—they could not foresee—that they had some one looking after their interests and ready to give them room, "when the hive was well filled." All they knew was that the hive was too small for their capacity, and they became determined to swarm. Who can tell what passes through the minds of those smart little insects? Who was it first called the swarming impulse "a swarming fever?" Not I. But I should go a long way before I could select a better term, for it is indeed an unreasoning, blind impulse, which possesses them in spite of all you can do when once started.

My first experience with the swarming fever was, I believe, in 1873, in an apiary that we had at Riverside, about

4 miles north of home. We then had already large hives, but used the division-board more freely than we do now, usually not allowing our bees more than 8 frames of space. Finding several colonies in preparation for swarming, I divided them each into three swarms, leaving only two full combs on the old stand. Well, each of these swarms sent forth a swarm or two, and we had the most worthless lot of weak swarms that year that I ever saw.

Ye bee-keepers who are tired of hiving swarms, try the large hives once, and you will get relief. Hamilton, Ill.



Some Southern California Bee-Notes.

BY PROF. A. J. COOK.

THE EUCALYPTUS BLOOMING.—Various of our eucalyptus trees are already in bloom. The blossoms are exceedingly beautiful, and it is very pleasant in walking under the trees to hear the merry hum of the bees which is forming among the blossoms. It is possible that they do not get very much of honey, but they are certainly kept out of mischief.

SILVER WATTLE TREES.—The writer has just received from George S. Hay, of Cootamundra, New South Wales, Australia, some seeds of the silver wattle trees, which, Mr. Hay says, is a great friend of the bees in early spring. He says it blooms about the end of July, lasts for three or four weeks, and is one mass of golden bloom with a sweet honey-perfume to which the bees flock in great numbers, gathering from it pollen for their early brood-rearing.

BEE-KEEPING IN SAN DIEGO COUNTY.—At the recent Farmers' Institute at Fallbrook, Southern California, Mr. McDougall, of Escondido, one of the most successful and enterprising bee-keepers of Southern California, gave a most valuable paper upon bee-keeping. Mr. McDougall is no less distinguished as a fruit-grower than as a bee-keeper. In his paper he showed conclusively that San Diego county was one of the most favored localities for bee-culture in the world, and also showed that the wise, energetic bee-keeper was doing as well, if not better, than those in any other kindred pursuit. Mr. McDougall thinks that not only the dry weather, but the peculiar state of the atmosphere, has much to do with the failure in the honey crop. He spoke regretfully of the fact that many bee-keepers in California are exceedingly careless in their management, and use hives that are almost a disgrace to the business.

THE "EXCHANGE" IDEA.—There is a great interest in all of Southern California on the matter of Exchanges. The Citrus Fruit Exchange is gaining the respect, not only of the growers, but of the business men as well. This industry had become almost paralyzed before the Exchange was organized. It is now quite on its feet, and is steadily gaining in its influence. In some cases the Citrus Fruit Exchange has been made to include the deciduous fruits. This is true in the region of Claremont. It is said that the raisin industry in the San Joaquin valley was marketed last year at a loss of one-half million dollars to the growers. This season a raisin exchange has been organized. It is creditably reported that already the raisin-growers are offered double for the raisins what they secured last year. It is to be hoped that this co-operative system will spread till it takes in all Southern California and includes all fruits and all the other products of our State, certainly including honey. Nothing seems better settled than that no producer can hope to live under the commission system. The f. o. b. system, while an improvement on the old commission system, is yet faulty. It lacks the power of wise and even distribution at the market end of the transaction. It is believed that the present Exchange system, as soon as it can secure reliable agents in all parts of the East,

will be able to do a grand work. It is said that last year the losses in the Citrus Fruit Exchange, on a business that went a good deal over one million of dollars, was less than one-half of one per cent. This is certainly a good showing for a mere infant.

Claremont, Calif., Sept. 10.



A Parable for Those Who Need It.

BY LEANDER S. KEYSER.

"Has The Week's Delight come, Hannah?"

"Yes; there it lies on the center-table."

Mr. Oswell picked up his favorite weekly paper, glanced admiringly at the handsome cover, then placed his easy chair near the window, and proceeded to read the editorials on the first page; or, rather, he tried to read them. But something seemed to distract his attention; he could not rivet his mind on those glowing paragraphs, do what he would.

The trouble was, a tiny but extremely acute arrow had penetrated his bosom, and was sticking in his heart. The disturbance it caused in the action of that member gave him an odd experience. Not only did it prick him, and thus divert his attention from the reading, but it brought a series of panoramas before his fancy like dissolving views.

He seemed to hear the rumble of machinery, and lo! before his mind's eye there passed a printer's "pit" or press-room, containing a half-dozen or more cylinder printing-presses, from which was issuing copy after copy of *The Week's Delight*, and he noted that all the pressmen were as busy as they could be with their grimy toil.

Then he heard the click of type, and seemed to be transported to a large composing-room, where over a score of typesetters were standing before their cases, their hands flying deftly from the "boxes" to the "sticks." The next minute the editorial-rooms swept before him, where men with large but deeply-creased brows were bending over illegible manuscripts, or laboriously scrawling off copy for the next number of the paper.

Then it seemed that pay-day had come, and this whole company of toilers had gathered before a window waiting for the reward of their labors. When they had received their money and were gone, Mr. Oswell caught sight of a large pile of paper-bills, postage-bills, and bills of many kinds, all of which had to be paid, and paid at once. But Mr. Oswell observed that the business manager's brow was lowering, and his face bore a worried expression.

"If only our subscribers would pay—" the business manager was saying.

But Mr. Oswell heard no more. The arrow piercing his heart gave a sudden twitch, causing him such acute pain that he looked at it searchingly for the first time, and, behold! the slender shaft reached down to his bosom from the little printed "tab" on his paper. He hastily examined the label.

"Goodness, gracious!" he exclaimed; "my subscription to this is overdue, and of course the publishers need the money to carry on the business. I'll send them a check this minute."

He did that very thing, and, odd as it may seem, the little pricking shaft was at once removed. Mr. Oswell felt happy, and found that he could now read his paper with infinite satisfaction.

"Queer how one's conscience will puncture one when one becomes delinquent," he smilingly mused.—*Epworth Herald*.

Dayton, Ohio.

[While the above has little bearing on bee-keeping, the hint which it contains, if heeded, would have a big bearing on the success of any bee-paper. Happy is the publisher who hath no subscribers that are numbered among "the delinquents," for he shall be able to pay his bills as each cometh due.—
EDITOR.]

Natural Swarming vs. Artificial or Dividing.

BY HON. R. L. TAYLOR,

Superintendent of the Michigan Experiment Apiary.

It is a pretty general received opinion among bee-keepers, I think, that the operation of natural swarming gives the bees an impetus that causes them to work more rapidly, both at honey-gathering and comb-building, than would have been the case had they not gone through that process. Whether that opinion is sound or not is a question of much practical interest, because it would often be convenient, and desirable, if the net results were not to be thereby diminished, to prevent natural swarming by artificial swarming, through the use of some method of division. On the face of it there is strong evidence that natural swarming gives the impetus referred to, but there is reason to believe that we may cherish a just suspicion that the swarming is a mere coincidence, and that the apparent evidence is produced by other causes. For instance, it might easily prove to be the fact that the more rapid progress of the work of the hive is caused by the absence of the necessity of making provision for any considerable amount of brood, for a somewhat prolonged period of time, as the chronology of the apiary goes. To produce better results in the matter of sur-

be futile to attempt to show that either class did the better, without knowing the amount of honey required for the rearing of a pound of brood, and it would be equally impossible to make a valid argument showing the amount of honey required for the rearing of a given amount of brood, unless it is first determined whether the two classes gathered honey equally well in proportion to their strength. Still, if we assume that the two classes gathered honey with equal zeal, which is probably not a very violent assumption, we may, especially if supported by facts drawn from the swarms of June 23, arrive at a tentative conclusion, and, perhaps, open the way for a satisfactory solution of these questions hereafter.

First, a few words in explanation of the table: Of the swarms of June 6, the first three are artificial; that is, made by shaking the bees with the queen from a hive in which no preparations for swarming had been made, and hiving as in the case of a natural swarm. Colonies 4 to 7, inclusive, are natural swarms of the same date. As the table indicates, all were given brood-chambers, consisting of a single section of the Heddon hive, each furnished with full sheets of foundation. As will be seen, hives, bees, and supers were carefully weighed separately, so that at the end of the experiment, July

	Colony No	Contents hive.	Weight of bees		Comb honey lbs	Weight of hive		Increase in wt. of hive, lbs.	Number Heddon frames of brood	Weight of brood in lbs.	Weight of honey in brood chamber, lbs.	Total honey lbs
			June 6, 1896. In lbs.	July 11th, 1896. In lbs.		July 11th, 1896. In lbs.	July 11th, 1896. In lbs.					
Artificial Swarms hived June 6, 1896	1	Fdn.	16½	3¼	30½	14¾	5	6¼	8	8	10¾
	2	"	17¾	5¾	6½	29½	11¾	6½	8½	3½	10¾	10¾
	3	"	16¾	3	31	14¾	4½	5½	8½	8½	8½
	Total	12	6½	19	20	20½	27
Natural Swarms hived Jun. 6, 1896.	4	"	17	7¼	22½	27	10	7¾	10
	5	"	17½	6¾	20	27½	10	8	10
	6	"	16¼	7¼	23	26¼	10	8	10
	7	"	17¾	7	14¼	29	11¼	8	11¼
Total	28¼	79¾	41¼	79¾
Hiv'd Jun. 23, 1896.	8	Str's.	15¾	7	14¾	24¼	9	5	6¼	23	17½	Natural Swarm.
	9	"	14¾	7¾	12¼	29¾	15	4½	5½	6¾	21 5-8	Artificial Swarm
	10	"	15¾	6¼	14¼	22½	7	5	6 1-4	¾	15 1-4	Natural Swarm. Virgin Q
	11	Fnd.	16¾	9¼	18¼	29	12¾	5	6 1-4	6 1-4	24½	Natural Swarm.

plus honey some apiarists practice caging the queen for a time, thus putting a stop to the depositing of eggs, and to that extent to the feeding of brood. Is not natural swarming Nature's way of checking the queen? And, if so, may not artificial swarming be so managed that the same check is given and equally desirable results obtained?

The accompanying table gives the details of an experiment, such as circumstances permitted, conceived for the purpose of gaining, if possible, some satisfactory information on the matters referred to. The scantiness of the honey-flow has prevented the attainment of the degree of success hoped for, and, besides, the experiment, cast in an entirely new field, has been a sort of groping one, and yet, I think it will be found far from barren of valuable results.

One of the most perplexing, and at the same time one of the most natural things, that enter into the problem, is the satisfactory estimation of the amount of food necessary to produce the brood which each colony has reared during the process of the experiment; for it is evident that unless the colonies are of the same strength, and the amounts of brood reared equal, or, at least, unless the amounts of brood reared by several colonies bears the same proportion to their several strengths, this matter is in the highest degree important. It is evident, referring to the accompanying table, that the disparity between the strength of the artificial swarms of June 6th and the natural swarms of the same date is so great, and the amount of brood of each class bears such different ratio to its strength, as compared with that of the other, that it would

11, it was easy to determine the amount of the increase in each. At the same time the hives were gone over carefully to determine the amount of brood in each, which is expressed in Heddon frames, and the weight of the brood is determined from the showing in the case of the colonies 4 to 7 whose hives were practically free from honey, and the frames full of brood had an average weight of about 1¼ pounds. From this, when the amount of brood is determined, it is easy to find the amount of the honey in each brood-chamber. In the case of the swarms of June 23, the same course was pursued, except that 8, 9, and 10 were hived on starters, 9 being an artificial swarm, and 10 a natural swarm with a virgin queen.

Starting with the above assumption, then, that the two classes of swarms of June 6 each gathered the same amount of honey per pound of bees, it is only necessary (not to be captious about minor points) in order to find the amount of honey expended in the rearing of brood, to find the number of pounds of brood in each class will give results which if added respectively to the number representing the pounds of honey in evidence in each class will give sums which will take the second and fourth place in a true proportion in which the numbers representing the weight of the bees in the two classes are the other two terms, in other words to find the value of X in the expression: 12 : X 20 plus 27 : 28¼ : X 41¼ plus 79¾. The value of X will be found to be almost exactly 2¾.

But it is 35 days since the bees were hived, and if we allow 5 days for the time that elapses before active feeding begins, 30 days remain—nearly time enough for a generation

and a half. Making proper allowance we may say, till some crucial experiment is made, that it requires nearly two pounds of honey for the production of a pound of unhatched brood. Of course, much pollen is used in addition. If the mature bees during their active life use any considerable amount of honey with their more substantial pollen diet, that complicates the matter. If the same line of reasoning be applied to the colonies of June 23, proper allowance being made for the difference in the length of time during which feeding has been going on, and for the greater proportion of uncapped brood, they will furnish strikingly corroborative evidence.

That the assumption made above is not a violent one is shown clearly, so far as the performance of one colony can do it, by No. 9 of the table. An artificial swarm of about the average strength of others of the same date the total amount of its honey product is considerably above the average. The results in the case of this colony prove, so far as they go, that artificial swarms may do fully as effective work as natural ones.

It is only necessary to point out further that No. 10, the colony with a virgin queen, in proportion to its strength, outdid all its competitors in the production of comb honey—the point where excellency was least looked for—a result which seems at least to call for a suspension of judgment on the question of the desirability of virgin queens in colonies used for the securing of comb honey—Review.

Lapeer, Mich., July 27.



An Experience with Pickled Brood or White Fungus.

BY W. J. STAHMANN.

Bees in this locality have been troubled more or less with the brood dying in certain hives. Fearing it might be an epidemic, or finally turn into foul brood, I mailed a sample of the dead brood to Dr. Wm. R. Howard, of Texas—one of our most noted professors of bacteriology. He has made a complete diagnosis of the case, and has requested me to give the symptoms of, and my experience with, the disease for publication; promising to write up the scientific part, and differentiate all the points between this and true foul brood, accompanied with illustrations; to which proposition I gladly accede, hoping it may be of benefit to some brother bee-keeper. [Dr. Howard's article on this subject appeared two weeks ago.—EDITOR.]

In the first place the brood dies just before it is ready to seal; in this respect I do not think it varies 24 hours. I seldom find any dead brood in sealed cells, while that which I have found is the same size as that which is not sealed.

Secondly, it lies on its back, both ends pointing upward, at first white, and hard to distinguish from live brood. At this stage the bees generally remove it. If not removed, its color changes to a yellow in a few days, getting darker until it is nearly black. In some cases it is allowed to dry in the cells. It is very watery after it is colored; not at all rosy or sticky, and emits no foul odor.

One peculiarity of this disease is, that it apparently comes and goes. For instance, a colony may have only a few cells of dead larvæ and keep them removed, so that it is hardly noticeable at times; then they may take a turn and not remove it; this seems to cause it to increase very rapidly, and many more die than if they kept it removed. Then, again, they will take another fit of "Annt Dinah house-cleaning," and clear all up again. I have had some colonies that have shown considerable dead brood all summer, with no perceptible increase or decrease; this is more noticeable among black bees. Such colonies, if given a new queen from stock that will remove all foreign matter, check the disease to such an extent that it is sometimes a difficult matter to find a cell of

dead brood. Such colonies might have the disease a long time and the apiarist not notice it, unless he looked for it carefully. I have a number of colonies that never allow any of the dead larvæ to remain in the hive long enough for it to color. As long as bees keep removing them at this rate, the disease is kept in check and does not weaken the colony.

I am of the opinion that when bees have contracted this disease it never leaves them permanently, as some bee-keepers I have talked and corresponded with seem to think. One says "he has seen samples of it in his own yard at various times, but it has invariably gone off itself, and it rarely affects more than two or three combs in a hive, and only a few scattering cells in each. It has never spread, but comes and goes."

Another assured me that it would leave as soon as the honey began to come in freely; it did in his apiary, etc. I believe that some of my colonies have had this disease for several years without my noticing it, and that I have spread it in my apiaries by changing combs from one hive to another. So far there has been no serious result from it, as only a few of my colonies have been slightly weakened by the disease.

As an experiment tending towards a cure, I selected one colony that was badly infected, took away all their old combs and gave them new frames, with foundation starters only. So far I can find no trace of the disease. Weaver, Minn.



Another Constitution—Proposed by Dr. Mason.

STATION B, TOLEDO, Ohio, Sept. 9, 1896.

EDITOR AMERICAN BEE JOURNAL:—The following, or something similar, will appear in the next issue of the bee-papers. Please put it in the next issue of the American Bee Journal. It was my intention to submit the enclosed Constitution in this form to the members of the Amalgamation Committee—and I did so yesterday—for their criticism, and then when as well prepared as we could do it, present it to the next meeting of the North American at Lincoln, as the report of the Committee; but the editors of *Gleanings* and the American Bee Journal have suggested that it be published in the bee-papers so as to give all an opportunity to make any suggestion they may see fit *before* the convention meets.

Now, to hasten matters, let each one who wishes to make any suggestions write them out in full, wording them *just as they would like to have them worded*, and send directly to me, so as to reach me not later than Oct. 3, and I'll see that what they send me is laid before the convention at Lincoln.

You know I'm in favor of calling the organization "The North American Bee-Keepers' Union," and I don't allow any one who sends suggestions to criticize the name; just criticize the proposed Constitution and let *me* alone.

Direct all letters to "Station B, Toledo, Ohio."

A. B. MASON.

[The constitution referred to above, and as sent to us by Dr. Mason, reads as follows:—ED.]

ARTICLE I.—NAME.

This organization shall be known as the United States Bee-Keepers' Association.

ARTICLE II.—OBJECT.

Its object shall be to promote and protect the interests of its members, and to promote the general interests of the pursuit of bee-culture.

ARTICLE III.—MEMBERSHIP.

Any person may become a member upon the payment of one dollar annually to the Secretary or General Manager, except as provided in Section 7 of Article VI. of this Constitution, or an Honorary member by a majority vote of the members present at any regular meeting.

ARTICLE IV.—OFFICERS.

The officers of this Association shall be President, Vice-President, a Secretary and a Board of Directors, which shall

consist of a General Manager and six Directors, whose term of office shall be for one year, or until their successors are elected and qualified; and the Director, aside from the General Manager, receiving the largest number of votes shall be chairman of the Board of Directors. Those who are now officers of the National Bee Keepers' Union shall constitute the Board of Directors of this Association until their successors are elected and qualified.

ARTICLE V.—ELECTION OF OFFICERS.

SECTION 1.—The President, Vice-President, and Secretary shall be elected by ballot by a majority of the members present at each annual meeting of the Association, and shall constitute the Executive Committee.

SEC. 2.—The General Manager and the Board of Directors shall be elected by ballot during the month of December of each year by a majority of the members voting; blank ballots for this purpose, with a full list of the membership, shall be mailed to each member by the General Manager; and said ballots shall be returned to a committee of two members, who shall be appointed by the Executive Committee, whose names and postoffice address shall be sent to the General Manager by said Executive Committee on or before the 15th of the November preceding the election. Said committee of two shall count the ballots and certify the result to the General Manager during the first week in January.

ARTICLE VI.—DUTIES OF OFFICERS.

SEC. 1.—*President*—It shall be the duty of the President to preside at the annual meeting of the Association; to deliver an address at the next annual meeting after being elected, on some subject of interest to bee-keepers, and to perform such other duties as may devolve upon the presiding officer.

SEC. 2.—*Vice-President*—In the absence of the President the Vice-President shall perform the duties of President.

SEC. 3.—*Secretary*—It shall be the duty of the Secretary to keep a record of the proceedings of the annual meeting; to receive membership fees; to furnish the General Manager with the names and postoffice address of those who become members at the annual meeting; to pay to the Treasurer of the Association all moneys left in his hands after paying the expenses of the annual meeting; and to perform such other duties as may be required of him by the Association, and he shall receive such sum for his services as may be granted by the Board of Directors.

SEC. 4.—*General Manager*—The General Manager shall be Secretary of the Board of Directors, and shall keep a list of the names of members with their postoffice address; receive membership fees, and be Treasurer of the Association. He shall give a bond in such amount, and with such conditions as may be required and approved by the Board of Directors, for the faithful performance of his duties, and perform such other duties as may be required of him by the Board of Directors, or by this Constitution.

SEC. 5.—At the time of sending the ballots to the members for the annual election of the Board of Directors, he shall also send to each member a statement of the financial condition of the Association, and a report of the work done by said Board of Directors.

SEC. 6.—The Board of Directors shall pay the General Manager such sum for his services as said Board may deem proper, but not to exceed 20 per cent. of the receipts of the Association. Said Board shall meet at such time and place as it may decide upon.

SEC. 7.—*Board of Directors*—The Board of Directors shall determine what course shall be taken by the Association upon any matter presented to it for consideration, that does not conflict with this Constitution; and cause such extra, but equal, assessments to be made on each member as may become necessary, giving the reason to each member why such assessment is required; provided that not more than one assessment shall be made in any one fiscal year, and not to an amount exceeding the annual membership fee, without a majority vote of all the members of the Association.

SEC. 8.—Any member refusing or neglecting to pay said assessment as required by the Board of Directors shall forfeit his membership, and his right to become a member of the Association for one year after said assessment becomes due.

ARTICLE VII.—FUNDS.

The funds of this Association may be used for any purpose that the Board of Directors may consider for the interest of the members of the Association and in the interest of the pursuit of bee-culture.

ARTICLE VIII.—VACANCIES.

Any vacancy occurring in the Board of Directors may be filled by the Executive Committee; and any vacancy occurring in the Executive Committee shall be filled by the Board of Directors.

ARTICLE IX.—MEETINGS.

This Association shall hold annual meetings at such time and place as shall be agreed upon by the Executive Committee.

ARTICLE X.—AMENDMENTS.

This Constitution may be altered or amended by a majority vote of all the members, provided notice of said alteration or amendment has been given at a previous annual meeting.

[As the time is short, all who desire to make suggestions on the above Constitution should do so *at once*. Do not send them to us, but direct to Dr. Mason. He will then present all criticisms before the convention at Lincoln, Nebr., Oct. 7 and 8.—EDITOR.]

Questions AND Answers

CONDUCTED BY

DR. C. C. MILLER, MARENGO, ILL.

[Questions may be mailed to the Bee Journal, or to Dr. Miller direct.]

A Number of Questions on Bees.

F. H. D. sends the following questions, which, on account of the number, are arranged with the answer immediately following the question:

FULL SHEETS OF FOUNDATION IN THE SECTIONS.

1. What is the real value of full sheets of foundation in sections? Some seem to put in full sheets because they want the combs straight, others because they believe bees will draw out the foundation faster and take to it sooner than they would build new comb and take hold of new starters.

ANS.—I don't know enough to answer the question just as you put it. Both of the reasons that you give for preferring sections filled with foundation are valid ones. I'm not so sure, however, that such a great deal is gained in having sections built straight, for you can get pretty straight work with mere starters. But there's no question as to getting work started all over sooner. And that's equivalent to saying the sections will be finished sooner.

Another reason for preferring full sheets is, that you can thus have your sections filled with all worker-comb. Probably few would agree that a section of drone-comb looks as well as one of worker, and one having worker-comb in the upper part and drone-comb in the lower part looks worse still than one all drone. For another reason it is quite important to keep drone-comb out of sections—a reason that possibly some bee-keepers of experience have not thought of. That reason is, that a queen is more likely to go up into a super and lay there if there is drone-comb in the super, unless indeed she finds plenty of drone-comb in the brood-nest. But you say, "If a queen-excluder is used under the super, the queen cannot get up." Very true, but the bees don't seem to know she can get up, and I have more than once seen a few drone-cells in one corner of a section left vacant awaiting the queen, when the section would have been entirely finished if no drone-cells had been present.

Although I am not able to say just exactly what is the value of full sheets of foundation in sections, I may say that I

consider them of such value that I want every section filled with foundation.

2. Would you advise the use of foundation to the extent that you do when the completed section will bring in no larger returns than does the one without so much foundation?

Ans.—I think I would, if I correctly understand your question.

NARROW SECTIONS AND SLOTTED SEPARATORS.

3. Do you think it advisable to use $1\frac{1}{8}$ -inch sections and separators, *a la* B. Taylor, where the only section to be had (in case you run short) is the $1\frac{1}{8}$ inch size, and where shipping-cases and all surplus arrangements are sold only to accommodate the $1\frac{1}{8}$ -inch section?

Ans.—Having never tried Mr. Taylor's plan, I am not so competent to answer, but in general there should be a good deal of advantage gained thereby to warrant one in using anything but standard goods in such articles as sections that must constantly be bought anew. To answer your question more directly, I prefer to use $1\frac{1}{8}$ sections with ordinary separators, but, as already intimated, I might change my mind if I should give the other plan a fair trial.

WHAT ABOUT FULL WEIGHT SECTIONS OF HONEY.

4. Do you believe it to be an advantage to get a full pound of honey in a section? Does the Eastern trade take as kindly to them as they do to those holding only about $\frac{3}{4}$ pound?

Ans.—In general, both East and West, I think a section weighing a full pound is not so well liked as one that weighs less. In some cases, at least, the reason is that the section is sold for a pound no matter what its weight, although those who thus sell the sections are not willing to buy by the section, but insist on buying by weight. For the rest of this answer see the next.

5. Do you succeed in getting more than 13 ounces of honey in the regular size section ($1\frac{1}{8}$), which I presume you use? If so, how do you do it?

Ans.—I can't answer that question, for the reason that I never got a crop of honey entirely in $1\frac{1}{8}$ sections—(I'll come pretty near it this year, but it will be some days before it is weighed). But I think I can answer the spirit of your question. I don't believe the man is yet born who can get $1\frac{1}{8}$ sections, or sections of any other size, filled so that there shall not be a good deal of variation in weight. I think you can easily get more than 13 ounces in a $1\frac{1}{8}$ section by omitting to use separators. And with separators you may do it in a flush season by crowding your bees hard for room. But you can't by any way that I know of, get all to weigh alike. Neither can you get them to average the same one year as they do another, unless the seasons are alike. So I prefer not only to have my sections weigh less than a pound, but I'd rather have them weigh a good deal less than a pound—so much less that no dishonest grocer would be able to sell for a pound what is not a pound.

THUMB-SCREWS IN PLACE OF WEDGES.

6. Have you ever used thumb-screws in place of wedges? If so, were they a success? If you have never used them, do you believe that they will insure less propolis between the sections by reason of greater pressure, and do you think that they make the changing of sections during a flow enough easier and quicker to make up for cost of adopting same?

Ans.—I never used them. I wedge my sections in a super with a straight stick $\frac{1}{2}$ of an inch shorter than the inside length of the super, $\frac{1}{2}$ an inch wide, and $\frac{1}{4}$ thick. A follower the same length as the stick, $4\frac{1}{4}$ inches wide and $\frac{3}{8}$ thick, crowds up against the sections, and the wedge-stick is crowded in between the follower and the side of the super, one end of the stick going to the bottom of the super, and the other end coming to the top. I doubt if I would like a thumb-screw any better. The stick gives a diagonal line of equal

pressure, whereas the thumb-screw gives pressure only at one point. I don't want sections in a super to swap places before being taken off. I want the super to stay on till all but the four corner sections, and possibly a few others, are finished, then I take off the whole business, take out the unfinished sections, collect them from a number of supers, put them in a fresh super, and put them back on a hive to be finished.

TRANSFERRING BEES.

7. Do you think that I could transfer bees next spring by simply inserting a queen-excluder between the old hive and new one, putting the queen below on *full sheets of foundation*, and reap the same harvest that I would have reaped had I not transferred them? Or how would it be if only starters were used? Would the bees draw out the foundation even if no honey was coming in, they having only the amount in the old hive to draw from? Do you think it would pay to feed at this time for the purpose of hurrying them up? If so, how much would it probably take to complete the drawing out of the combs?

Ans.—No, I don't believe you'd get as much honey as to let the bees alone, unless indeed you could count on a good fall flow. I believe you might like better to increase this year, using a plan that I practiced to some extent last year. I took all the combs from a strong colony, filled up their hive with frames filled with foundation, put on a feeder, and gave them equal parts of water and granulated sugar—it was in the last of July or first of August—and fed till the hive was well filled, giving perhaps 20 pounds of sugar. I put the brood over another strong colony, an excluder under the brood so the colony couldn't get up; after 24 hours I took away this hive of brood with the bees that had gone up, set it on a new stand and gave it a queen or queen-cell. Thus you see I got three colonies from two, and all of them were good colonies this spring. I think you will see that one advantage of this plan over waiting till next spring is that you get the laying of three queens instead of two this fall and next spring.

8. Would it not be likely to give the colony a set back to thus divide it, when the nights are still quite cold, and where robbers are prowling about continually?

Ans.—I think it would.

NATURAL VS. ARTIFICIAL SWARMING.

9. Do you consider natural swarming far ahead of artificial?

Ans.—Now what makes you ask a question of that kind? Do you want me to get into trouble? Don't you know that bee-keepers believe that there's a sort of influence obtained from natural swarming that gives better results than can be obtained without it? But you've asked me what I consider about it, and if you'll promise to say nothing to any one else about it I'll tell you what I think. I don't know whether the popular opinion is correct, but I have serious doubts about it, and I'd a good deal rather never have a natural swarm. I don't believe there's anything gained by natural swarming that can't be gained without it, but then I don't know for sure.

QUEEN-EXCLUDING VS. PLAIN HONEY-BOARDS.

10. Would you advise the use of queen-excluding honey-boards in preference to plain ones? Or are you of the opinion that the bees will work in the supers just as readily as they will with the common wood honey-board?

Ans.—I don't think there's much difference, but I have had so little trouble with queens going up through the Heddon slat honey-board that I wouldn't pay the difference to have excluders. Now I'll answer a little more than you've asked, and say that the hives that have suited me best this year are those that have neither kind of honey-board. Top-bars $1\frac{1}{2}$ wide and $\frac{3}{8}$ thick, with $\frac{1}{4}$ inch between top-bars and sections.

MORE QUESTIONS TO FOLLOW.

11. Aren't you glad that I shall keep the balance of my questions over for another time?

Ans.—Yes, I'm glad you still have some left, and if you're

like me you'll never see the time when there are no questions you'd like to have answered. But I wouldn't be glad to have you stop asking, for when a man writes as plain a hand as you, and seems to know just what it is he wants to know about, and goes straight to the mark in asking the question, distinctly numbering each question, then I am glad to get his questions. So send on some more and I'll do my best with them.

PERSONAL MENTION.

DR. TINSLAR, of Kankakee county, Illinois, made us a very pleasant call on Sept. 12. He is a dentist as well as a bee-keeper; also Secretary of the local bee-keepers' society organized last spring.

MR. C. O. PERRINE, once famous for his extensive marketing of honey (?) in Chicago, and later for his enterprise in moving bees up the Mississippi, is now engaged in business in the city of Riverside, Calif.

MR. J. T. CALVERT, of The A. I. Root Co., was appointed one of the judges of the honey exhibit at the Minnesota State Fair held at Hamline recently. He reported the exhibit a very good one, a dozen or more entries being made in most classes.

MR. G. W. WILSON, of Wisconsin, reports in Gleanings a record of 300 pounds net gain of a colony kept on scales for 26 days—from June 20 to July 16. It made a gain of 29 pounds in one day. It was extracted honey, gathered during basswood bloom. Mr. W. wants to know who can beat it.

MR. E. B. KAUFFMAN, of Brickerville, Pa., has been making an exhibit of bees at the Lancaster County Fair. The local paper said this about it:

"One of the most interesting exhibits at the Fair is that of E. B. Kauffman, of Brickerville, who has three hives of bees on exhibition. Mr. Kauffman is very obliging, and willing to impart instruction concerning the habits and handling of the bee."

EDITOR HOLTERMANN, of the Canadian Bee Journal, recently sent out a number of questions to his subscribers in order "to give bee-keepers and others a better opportunity to judge of the present condition of bee-keeping and the honey crop" for 1896. He published the replies from between 50 and 60, which serve to show that generally a good season has prevailed this year throughout Canadian beedom. Of course there were exceptions, but we believe that over there, as here, in the main, bee-keepers have reason to feel encouraged.

MR. JEWELL TAYLOR (son of the late B. Taylor), of Minnesota, wrote us as follows, on Sept. 15:

A traveling man representing C. R. Horrie & Co. called on me last week. He was just about as "breezy" as their circular letter—a copy of which I received some time ago. I set the letter down as a genuine fraud as soon as I saw it, although I had never known anything of the firm.

I allowed the traveling man to pour forth his eloquence for awhile, and then I told him just what I thought of the firm, and he dropped his plumes, ending up by saying they would just as soon buy the honey at our railroad station. But of course I will never hear from them again. The gentleman (?) said:

"York is giving us fits because we took our advertisement from the American Bee Journal, and put it in the Shippers' Weekly."

You deserve great credit for the part you have taken in the matter.

JEWELL TAYLOR.

Yes, of course they took their advertisement somewhere else when we dropped them out of the Bee Journal. According to agreement their advertisement was to run several weeks

longer in the Bee Journal, but when we found how they were doing business, we just took their advertisement out quick, not waiting for the expiration of the contract.

THE LEAHY MFG. Co., of Missouri, have been doing a little figuring, the result of which they give in the Progressive Bee-Keeper for September. It is as follows:

Forty thousand feet of lumber has been used at the Higinville factory for shipping-cases the past season. As the average amount of lumber used to each case is about 1½ feet, you will see that we have made about 30,000 cases, and as these cases will average about 18 pounds of honey, you will see that our customers have produced over half a million pounds of comb honey. This at 14 cents a pound would bring over \$75,000. As about only half the honey is put up in sections (the rest of it being extracted), we estimate that our customers have produced from \$125,000 to \$150,000 worth of honey, not counting the beeswax. We think this is a fair estimate, as shipping-cases are usually the last things ordered, and are seldom ordered till honey is in sight, and then again there is a great deal of honey used and marketed that is never put in shipping-cases. Now as our customers only pay us from \$20,000 to \$25,000 a year for all of their supplies, you will see from the above figures that they have made from 400 to 500 per cent. of their investment, if you do not count the labor. Then, again, if we would count that all sections sold were filled with honey, the figures would be much larger, as we sell over a million sections each year.

Ho, for Lincoln!—As all our readers know, the North American bee-convention will be held at Lincoln, Nebr., on Wednesday and Thursday, Oct. 7 and 8—next month. Now, the Nebraska bee-keepers are going to a good deal of work and expense, intending, during the convention, to take care of every member outside of their State free. With such a generous offer, and in view of the excellent program arranged by Secretary Mason, it seems to us that so far as possible every bee-keeper, who is a bee-keeper, should arrange to go—especially as the Homeseekers' Excursion rate of about half fare can be taken advantage of on Oct. 6.

For all who can possibly start from Chicago—and those east of this city—we may say that we have arranged for a through sleeping-car to Lincoln without change, on the Chicago and Northwestern railroad. It will leave here at 6 o'clock Tuesday evening, Oct. 6, and arrive at Lincoln at 11 a.m. the next forenoon. Of course, the first session of the convention would be missed, though that perhaps would not be much, as very little will be done before the afternoon of the first day.

We do hope that a large enough company will gather here in Chicago, so that we can fill at least one sleeping-car. What a fine time such a crowd would have going on such a journey!

On the return trip we would leave Lincoln at 1:45 p.m., on Friday, Oct. 9, arriving in Chicago at 7 o'clock the following morning.

Now we want to hear from all who will go with us from Chicago. Please let us know at once about it. If any further information is desired, we shall be pleased to give it, if you will write us.

A New Binder for holding a year's numbers of the American Bee Journal, we propose to mail, postpaid, to every subscriber who sends us 15 cents. It is called "The Wood Binder," is patented, and is an entirely new and very simple arrangement. Full printed directions accompany each Binder. Every reader should get it, and preserve the copies of the Bee Journal as fast as they are received. They are invaluable for reference, and at the low price of the Binder you can afford to get it yearly.

The McEvoy Foul Brood Treatment is given in Dr. Howard's pamphlet on "Foul Brood; Its Natural History and Rational Treatment." It is the latest publication on the subject, and should be in the hands of every bee-keeper. Price, 25 cents; or clubbed with the Bee Journal for one year—both for \$1.10.

OLDEST BEE PAPER IN AMERICA ESTABLISHED IN 1861

THE AMERICAN BEE JOURNAL

GEORGE W. YORK, Editor.

PUBLISHED WEEKLY BY

GEORGE W. YORK & COMPANY,

118 Michigan St., CHICAGO, ILL.

\$1.00 a Year—Sample Copy Sent Free.

[Entered at the Post-Office at Chicago as Second-Class Mail-Matter.]

Vol. XXXVI. CHICAGO, ILL., SEPT. 24, 1896. No. 39.

EDITORIAL COMMENTS.

Nebraska and California in 1895.—The New York Sun reports that in 1895 there was marketed in Nebraska 300,000 pounds of extracted honey at an average of 10 cents per pound. And that California produced 2,000,000 pounds of extracted honey, 200,000 pounds of comb honey, and 30,000 pounds of beeswax. We fear that the honey figures assigned to California are far too low. We thought it was 7,000,000 pounds of honey produced in that State last year. It is possible we are mistaken in this, but we think not.

The British Bee-Keepers' Guide-Book is the title of a book written by Mr. Thos. Wm. Cowan, editor of the British Bee Journal and inventor of the splendid Cowan extractor. We learn from Gleanings that the 14th edition has just been issued. Editor Root, in referring further to this deservedly popular bee-book, says this:

Within 15 years 25,000 copies have been sold, and within a month 2,000 copies of the new edition have been sold. So great has been the demand for it throughout all Europe that it is now published in French, German, Danish, Swedish, Spanish and Russian. Of some of these, two or three editions have been published, and it is safe to say that no other bee-book is read in so many languages. The present edition has been thoroughly revised, enlarged, and a great portion entirely re-written. Old methods and implements have been stricken out, and new ones incorporated in their proper position. The special feature of this edition is the introduction of a large number of beautiful half-tone engravings representing various manipulations of the bees, and everything is put so plainly that there is no chance for misunderstanding. It is condensed, and yet covers fully all essential details. The author, as nearly as I can discover, has made his book small, not by covering briefly everything in bee-keeping, but by giving only the best plan or method in full, in his estimation, thus avoiding confusion to the beginner.

We feel that we are quite safe in saying that of all the editors of bee-periodicals printed in the English language today, Mr. Cowan is the ablest. By the way, he is also the oldest, for the majority of us bee-editors are still on the sunny side of 40. (Mr. Cowan and Mr. Hutchinson may contend that it is just as "sunny" on the other side of 40—and they might be right, too.)

We have never met Mr. Cowan, but we receive his journal every week, and so have come to know him somewhat on paper.

Geo. T. Wheadon & Co., of this city, have sent out yellow circular letters broadcast among bee-keepers, something after the style of Horrie & Co.'s. A number of our subscribers have sent us the Wheadon & Co.'s circulars soliciting shipments of honey. We thought once that we would publish their letter in full in the Bee Journal, but we have decided

that it would hardly pay to waste our space further in that line.

We never before this year had heard of Wheadon & Co. as honey-dealers, or even as general commission men, so of course they are not "The largest honey-dealers in the West," as they boastingly claim to be. Besides, their circular of Sept. 5 quotes altogether too high prices on honey, and especially on beeswax, which they say is scarce at 32 to 35 cents for the best. The fact is, the beeswax market has been, and is, extremely dull here, at 25 cents per pound.

We see this firm say in their letter: "Note our ad. in 'Bee-Keepers' Review,' September issue." We were surprised to see that, for we did not think that the Review would so soon again advertise for a new and untried Chicago honey-dealing firm.

We have wondered, also, where Wheadon & Co. got their names of bee-keepers, to whom they have been mailing their printed letter. We felt sure that Mr. Hutchinson would not sell his list of names to them, after his experience with Horrie & Co. last year, though it may be they got the names from the latter firm.

Of course it is too early yet to hear of either favorable or unfavorable honey-deals made by Wheadon & Co. But judging alone from their private circular quotations on honey and beeswax—which are too high—we could not advise shipping to them. We say this in reply to the numerous requests that we have received lately.

We might say further, that on Sept. 15 we purchased the very finest lot of about 350 pounds of comb honey on South Water Street, from a reliable firm, at 13 cents per pound. So you see that quotations of 15 and 16 cents are much too high, and cannot be realized to any great extent.

Prevention of Honey-Granulation.—If we would keep honey in a liquid state, we should heat it and then seal it in air-tight tins, and do all the work in a perfectly dark room, and store the tins of honey in a dark, warm room. We could then keep our honey in a liquid state for an indefinite period of time. So says a correspondent in the Australian Bee-Bulletin.

The Editorial Paragraphs in the July Review were nearly all crystallizations of whole articles found in Gleanings. As Editor Hutchinson is such an adept at the "boiling-down process," we feel that we can do no better than to extract the following samples of his work:

BURR-COMBS AND BRACE-COMBS are practically done away by the thick top-bars and accurate spacing of the Hoffman frames, so says the editor of Gleanings. He admits that these frames have their faults, but believes that they have the fewest of any self-spacing frames. In hot weather, when the propolis is soft, they may be handled with nothing to pry them loose. But there are so many times when it is necessary to handle frames when the propolis is *not* soft. After all, many of our preferences must be a choice of evils, or faults, rather.

DEQUEENING COLONIES DURING THE HARVEST.—Messrs. Elwood and Hetherington, and a few others, practice removing the queen with a frame or two of bees and brood just at the opening of the swarming season. At the ninth day all of the queen-cells are cut out and the bees left hopelessly queenless for a week or ten days more, when the old queen is again given to the colony. This practice prevents swarming.

Mr. T. H. Kloer, of Terre Haute, Ind., has been trying this plan upon an extensive scale, and he tells in Gleanings of some of the difficulties with which he had to contend. One trouble was that the removed queens would leave the nuclei and crawl about on the ground, perhaps get back into the old hive. In breaking up colonies for making nuclei for queen-rearing, I have often formed a nucleus with the old queen and one or two combs of bees, and I have never experienced the trouble mentioned by Mr. Kloer. He says that he finds it necessary to fasten the bees in the first day. By the second day they will have cooled down, and will stay at home. Of

course, all of the old bees will leave for the old stand if allowed to do so, but I have never had a queen leave.

In destroying the queen-cells, Mr. Kloer finds it advisable to shake the bees off the combs, and in this way he has never missed a cell in six years of practice.

Mr. Kloer's greatest difficulty was in introducing the queen after the bees had been so long queenless. As a rule, hopelessly queenless bees accept a queen with no objections, that is, unless they have been a long time queenless, when it is sometimes well-nigh impossible to get them to accept a queen.

THE WAY FOUNDATION IS PUT IN.—Gleanings calls attention to the fact that bees do not always, in building comb naturally, have two parallel sides of the cells perpendicular, and the inference is drawn that it makes no particular difference which way foundation is put in, that is, regarding the direction that is given the side-walls. It probably makes no difference so far as the drawing out of the foundation is concerned, but it has been asserted that the foundation is less likely to sag if two parallel side-walls of the cells are hung perpendicularly.

LATE-REARED QUEENS are pronounced superior by Geo. L. Vinal, in Gleanings. He has experimented six years by rearing queens under the same condition, as near as possible, at different seasons of the year, and, as a rule, the late-reared queens have been larger and better-developed. They begin laying earlier in the spring, and their progeny is larger and more industrious. He thinks it is because they are not called upon to lay to their full capacity for several months, and are enabled to develop into full maturity before laying many eggs.

APIS DORSATA.—W. K. Morrison, of Bermuda, has an article in Gleanings in which he is inclined to defend *Apis dorsata*. The points that he makes in their favor are as follows:

1. A larger number of flowers visited having deep nectaries.
2. A larger area covered by its greater power of flight.
3. More wax produced.
4. Honey to come to us now going to bumble-bees.
5. A greater power to take care of itself against wasps, etc."

It may be different in some parts of the country, but in this locality there are no honey-producing blossoms that amount to anything that cannot be visited by our common bees. Red clover was once raised here extensively, but the insects have been so destructive to it that its cultivation has been abandoned and Alsike used in its place.

Does *Apis dorsata* have a greater power of flight than our common bees? That is what I should be glad to know. A larger bird or insect does not always have the greater power of flight. *Apis dorsata* may have a greater power of flight than the bees we now have, but what proof have we?

If they produce more wax, how do we know that it is not at the expense of honey?

The honey that goes to the bumble-bees you can "stick in your eye."

Ability to contend with wasps and hornets may be of some value in some localities, but would amount to nothing here.

I don't wish to prejudice people against *Apis dorsata*, but I do think it an unwise thing to do to import this race of bees without knowing more about it.

"Any Fool can keep bees, but it takes a man or woman with brains and energy to get the bees to keep them." Australian Bee-Bulletin.

The Southwestern Wisconsin Bee-Keepers' Association will meet in annual session at Wauzeka, Wednesday and Thursday, Oct. 7 and 8, 1896. The Secretary, Mr. M. M. Rice, of Boscobel, Wis., extends this general invitation:

In behalf of the Association, we extend you a most cordial invitation to attend this meeting which promises to be the best ever held. The meetings of this society have always been interesting and profitable to those attending. If you are not a member we invite you to come just the same. We wish every one that is interested in apiculture to be present. Our committee on foul brood has done more hard work to get a foul brood law, and he needs the help of every bee-keeper in the State. We have the dreaded disease in southwestern Wisconsin at the present time, and it becomes every bee-keeper to

better himself by having a law to protect their interests. You cannot afford to miss this meeting, as it will be very interesting and profitable to all attending. Many of our noted bee-keepers of the State will be in attendance.

The display of bee-keeping appliances is well worth your visit to see.

Board can be obtained at the Wauzeka House at 75 cents per day.

The program, in part, is as follows—it will be well worth going a good ways to hear:

- Annual Address—Pres. N. E. France.
- Queen-Rearing, Best Method—J. W. Van Allen.
- Management of Swarms—D. Ricks.
- Package for Extracted Honey—A. Dexter.
- Large or Small Hives—A. Arms.
- Best Method of Wintering—B. F. Cooley.
- Song—Miss Evans.
- Comb Honey More Profitable than Extracted—R. P. Green.
- Wednesday evening session, Address on Foul Brood, songs and a general good time.
- Use and Abuse of Comb Foundation—J. Patzner.
- Bees on Shares—H. C. Gleason.
- Upward Ventilation in the Cellar—J. Harker.
- Bees or Fruit the More Profitable—T. Thorson.
- Planting for Honey—C. Zillmer.
- Spring Management of Bees—J. Murray.
- Feeding, Spring and Fall—W. S. Knox.
- The Moral Influence of Bee-Keeping as an Occupation—H. Lathrop.
- Which is More Instructive, Bees or Fruit?—J. S. Nichols.
- Marketing Honey—A. McCarty.
- Best Method of Increase—I. P. White.
- Bee-Keeping as a Specialty—I. L. Murray.
- Songs—N. E. France.
- What is the Future Prospect of Honey from Basswood?—F. F. Zillmer.

Honey Fruit Cake.—The Ladies' Home Journal for September gives this recipe for making honey fruit cake:

Four eggs, five cups of flour, two cups of honey, one cup of butter, one cup of sweet milk, two tea-spoonfuls of cream of tartar, one tea-spoonful of soda, one pound of raisins, one pound of currants, half a pound of citron, one tea-spoonful each of cloves, cinnamon and nutmeg. Bake in a slow oven.

Basswood and White Clover.—We wish to buy for cash a quantity of both light basswood and white clover extracted honey. Who has any for sale? Do not ship us any until we order, but if you think you have what we want, please mail us a sample, being sure to put your name on it. Also let us know how much you have for sale. We will then write you, in case the samples suit.

Honey as Food and Medicine.—A new and revised edition of this 32-page pamphlet is now issued. It has 5 blank pages on which to write or paste recipes taken from other sources. It is just what its name indicates, and should be liberally distributed among the people everywhere to create a demand for honey. It contains a number of recipes on the use of honey as food and as medicine, besides much other interesting and valuable information. Prices, postpaid, are: Single copy, 5 cts.; 10 copies 30 cts.; 50 for \$1.00; 100 for \$1.75. Better give them a trial. Send all orders to the Bee Journal office.

The Alsike Clover Leaflet consists of 2 pages, with illustrations, showing the value of Alsike clover, and telling how to grow it. This Leaflet is just the thing to hand to every farmer in your neighborhood. Send to the Bee Journal office for a quantity of them, and see that they are distributed where they will do the most good. Prices, postpaid, are as follows: 50 for 25 cents; 100 for 40 cents; or 200 for 70 cents.

The Names and Addresses of all your bee-friends, who are not now taking the Bee Journal, are wanted at this office. Send them in, please, when sample copies will be mailed to them. Then you can secure their subscriptions, and earn some of the premiums we have offered. The next few months will be just the time to easily get new subscribers. Try it earnestly, at least.

PLANTS TO BE NAMED.

By DR. H. S. PEPOON,

936 Belleplaine Ave., Station X. Chicago, Ill.

Ready for Business.

I have been absent on a camping tour, and have only lately returned to the city. This will be my excuse for past delays in answering queries about plants. I am ready now, however, to attend strictly to business, so send them on.

H. S. PEPOON.

Partridge-Pea—Water Hore-Hound.

I send two different plants, which I would like to have named. They grow around here on low sandy lands. Do you know anything about their honey-producing qualities? A. V. R.

De Motte, Ind., Aug. 6.

ANSWER.—No. 1, is the partridge-pea spoken of in a former number of the Bee Journal.

No. 2, is a member of the mint family, and has the common name of water-horehound, (botanically *Lycopus*). Like many mints it is well supplied with honey, and seems a favorite with the smaller bees.

Willow-Herb.

I enclose a sample of flower that made its first appearance here last summer. The marshes are fairly covered with them. What is its name, and how does it rank as a honey-producer?

Hancock, Wis., June 27. S. R. H.

ANSWER.—The plant you send is the willow-herb, already treated of in the Bee Journal for July.

Bush Clover.

I enclose a plant whose name I wish to know. Does it produce much honey? My bees are now working on it all day long, and we have oceans of it here.

Albertville, Ala., Aug. 26. J. H. S.

ANSWER.—The plant you send is a *hespedeza*, common name "clover," belonging to the Pulse family, already often mentioned as containing the clovers and other honey-plants. As to the honey-producing qualities I can say nothing. In the North the genus is not apparently a valuable one for honey, but experience may prove that some of the species have merit.

Partridge-Pea—Figwort.

I send two plants. Will you kindly give me their names? No. 1, some call "buttercup." It grows to perfection on low ground, on the banks of ditches and roadside. No. 2, I know no common name for. I only know one patch—it is on the south side of a hedge, and bees work on it from daylight to dark. A bee doesn't have to visit many of the little cups until it gets its load. Bees don't work a great deal on No. 1, but perhaps it may be a good honey-plant some other place. T. G.

Raritan, Ill, Aug. 31.

ANSWER.—No. 1 is the much-talked-of partridge-pea, on which I have made

NOW WE HAVE IT! GLEASON'S HORSE-BOOK!

The Only Complete and Authorized Work
by America's King of Horse-Trainers,

PROF. OSCAR R. GLEASON,

Renowned throughout America and recognized by the United States Government as the most expert and successful horseman of the age. The whole work comprises History, Breeding, Training, Breaking, Buying, Feeding, Grooming, Shoeing, Doctoring, Telling Age, and General Care of the Horse.

You will know all
about a horse
after you
have
read
it.

No one can fool you
on the age of a
horse after
you have
read
it.

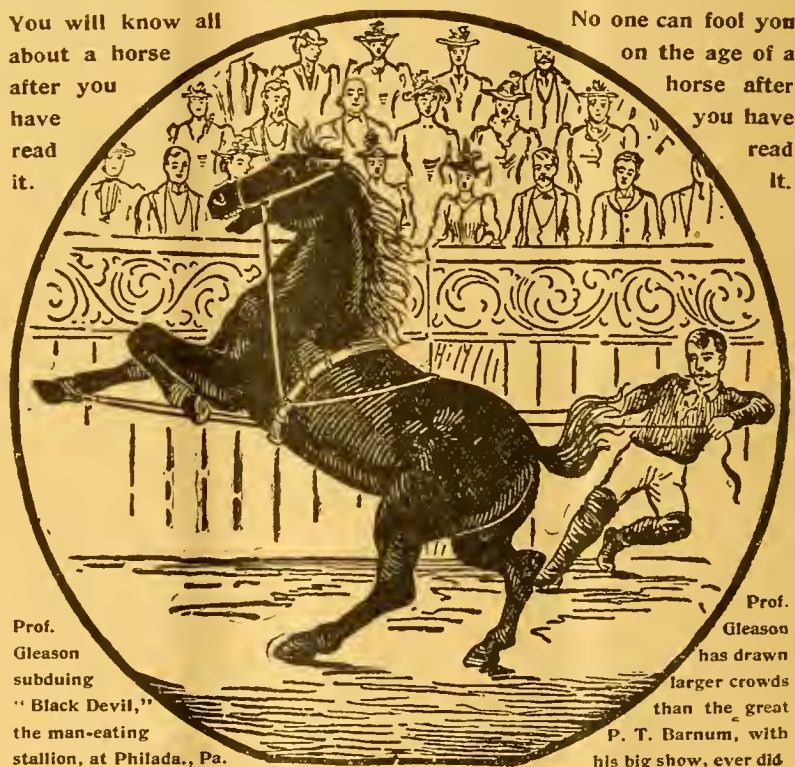

Prof. Gleason subduing "Black Devil," the man-eating stallion, at Philada., Pa.

Prof. Gleason has drawn larger crowds than the great P. T. Barnum, with his big show, ever did

416 Octavo Pages—173 Striking Illustrations.

Produced under the direction of the U. S. Government Veterinary Surgeon.

In this book Prof. Gleason has given to the world for the first time his most wonderful methods of training and treating horses.

100,000 SOLD AT \$3.00 EACH.

But we have arranged to supply a limited number of copies to our subscribers absolutely free. First come, first served.

Here are Our Offers of this Great Book.

Regardless of the fact that thousands upon thousands of these books in cloth binding have been sold at \$3.00 each, we are enabled to, and will for a limited period, send a heavy-paper-bound copy FREE as a premium to our present regular subscribers for sending us ONE NEW Subscriber to the Bee Journal for a year at \$1.00; or we will mail the book and the Bee Journal for a year to any one sending us \$1.60. Address,

GEORGE W. YORK & CO.,
118 Michigan Street, - - CHICAGO, ILL.

a report in a former number. No. 2 is the common figwort (*scrophularia*) found everywhere in proper locations, and doubtless is one of our most valuable honey-plants, judging by the eagerness with which bees seek it. It is a plant easy of cultivation, and as it is perennial, once established it requires no further care. It belongs to the family of the same name.

Lotus.

I enclose a plant that I would like to know the name of. It is found in the corn-fields. Its leaves resemble the partridge-pea, and the flowers are a kind of pink red, resembling the white clover. It was the only plant here the bees work on. H. N. C.
Fairview Village, Pa., Aug. 3.

ANSWER.—The plant you send belongs to the same family as the pea-clover and partridge-pea, and is one of the genus *lotus*. It is closely related to the clover, and probably has honey-producing value. The plant sent is a European one and is very rare in America, in fact not being found in Gray's botany. It therefore would have no economic value here from its scarcity, but if introduced abundantly it might add another valuable honey-plant to our list.

Another Lotus.

Enclosed find a plant that I would like to know the name of; also if it is a honey-plant. I found a single bush, growing on a dry ridge, almost bare rock. Ahlers, Oreg., Aug. 21. H. A.

ANSWER.—The plant you send is also a *lotus*, but of a Western species. Regarding its honey qualities, I can give no information, further than that given under H. N. C.

General Items.

Bees Did Finely—Home Market.

I have been waiting for some time to give you a report of the honey season in central Vermont. Bees have done finely—from 75 colonies, spring count, I have taken 2,500 pounds, mostly comb honey. It is very fine quality, and retails at 16 to 20 cents per pound; extracted 12½ cents per pound.

We had a very heavy basswood bloom, but the weather was too cool. I got my honey mostly from raspberries, which produces the best honey of any nectar-secreting plant in existence—allowing me to be the judge.

I take 10 papers, and the "old reliable" American Bee Journal is the most punctual to the whole lot. When Friday night comes, it comes.

By the way, I sell all my honey to the consumers, and no commission-man will get a hack at me. M. F. CRAM.
West Brookfield, Vt., Sept. 7.

Poor Season—Must Feed the Bees.

From what I can learn from old beemen, such as Mr. Samuel Valentine, of Hagerstown, Md., this has been the worst or poorest honey season in the past 40 or 50 years. Scarcely any honey. Mr. V. has nearly 300 colonies, and got

PROF. A. J. COOK'S BOOK FREE! The Bee-Keeper's Guide OR MANUAL OF THE APIARY.

This 15th and latest edition of Prof. Cook's magnificent book of 460 pages, in neat and substantial cloth binding, we propose to give away to our present subscribers, for the work of getting new subscribers for the American Bee Journal.

A description of the book here is quite unnecessary—it is simply the most complete scientific and practical bee-book published today. Fully illustrated, and all written in the most fascinating style. The author is also too well-known to the whole bee-world to require any introduction. No bee-keeper is fully equipped, or his library complete, without "THE BEE-KEEPER'S GUIDE."

GEORGE W. YORK & CO., 118 Mich. St., CHICAGO, ILL.

✦ MONEY SAVED IS MONEY GAINED. ✦

THE ROYAL UNION Life Insurance Company DES MOINES, IOWA.

The Iowa Policy

Is one that definitely promises to keep an accurate account with you; credit your premiums and interest, charge the actual expense and mortality cost, and hold the remaining funds subject to your order.

Agents Wanted.

JOHN B. KING, GENERAL AGENT,
Suite 513 First Nat'l Bank Bld'g,
20Atf CHICAGO, ILL.

IF YOU WANT THE

BEE-BOOK

That covers the whole Apicultural Field more completely than any other published, send \$1.25 to Prof. A. J. Cook, Claremont, Calif., for his

Bee-Keeper's Guide.

Liberal Discounts to the Trade.

DUQUESNE COLLEGE!

PENN AVE. AND EIGHTH ST.

PITTSBURG, PA.

Thorough Course—Classical, Scientific, Normal, English Commercial, Preparatory, and Ladies Literary. Efficient and experienced instructors. Day and Night sessions. Send for Catalog.

Mention the American Bee Journal.

Bees Invisible in Honey-Producing

In California, as described fully by an inventor in the **PACIFIC BEE JOURNAL**, and that the noting of

A Colony's Condition

by an Electric Record at all times; and

Queen Removal

without looking for her.

Honey Extracted without Man's Aid.

A monthly journal only 50 cts. a year. Take a year and tell it all. Sample Copies only to those who credit this paper.

39Atf LOS ANGELES, CALIF.

Mention the American Bee Journal

Given For 2 New Subscribers.

The following offer is made to PRESENT subscribers only, and no premium is also given to the two new subscribers—simply the Bee Journal for one year:

Send us Two New Subscribers to the Bee Journal (with \$2.00), and we will mail you a copy of Prof. Cook's book FREE as a premium. Prof. Cook's book alone sent for \$1.25, or we club it with the Bee Journal for a year—both together for only \$1.75. But surely anybody can get only 2 new subscribers to the Bee Journal for a year, and thus get the book as a premium. Let everybody try for it. Will you have one?

Page & Lyon Mfg. Co.,

NEW LONDON, WIS., operates two saw-mills that cut, annually, eight million feet of lumber, thus securing the best lumber at the lowest price for the manufacture of bee-keepers' supplies. They have also just completed one of

The Largest Factories,

and have the latest and most improved machinery for the manufacture of Bee-Hives, Sections, etc., that there is in the State. The material is cut from patterns, by machinery, and is absolutely accurate. For Sections, the clearest and

The Whitest Basswood

is used, and they are polished on both sides. Nearness to pine and basswood forests, and possession of mills and factory equipped with best machinery, all combine to enable this firm to furnish the best goods at

The Lowest Prices. ♡

For instance, it has a job lot of 200,000 No. 2 Sections that will be sold at 50 cts. per 1,000; or 2,000 Snow-White Sections will be sold for \$4.00, and larger quantities at still lower prices. Send for Circular and see the prices on a full line of supplies. 16Atf

WHEN ANSWERING THIS ADVERTISEMENT, MENTION THIS JOURNAL.

BEGINNERS.

Beginners should have a copy of the Amateur Bee-Keeper, a 70-page book by Prof. J. W. Rouse. Price 25 cents; if sent by mail, 28c. The little book and the Progressive Bee-Keeper (a live, progressive 28-page monthly journal) one year, 65c. Address any first-class dealer,

or LEAHY MFG. CO., Higginsville, Mo.

WHEN ANSWERING THIS ADVERTISEMENT, MENTION THIS JOURNAL.

California

If you care to know of its Fruits, Flowers, Climate or Resources, send for a Sample Copy of California's Favorite Paper—

The Pacific Rural Press

The leading Horticultural and Agricultural paper of the Pacific Coast. Published weekly, handsomely illustrated, \$2.00 per annum. Sample Copy Free.

PACIFIC RURAL PRESS,
220 Market St. - SAN FRANCISCO, CAL.

70 Colonies of Bees for \$100.

This offer will hold until October 10.

William Iden, Etna Green, Ind
Mention the American Bee Journal 39A3t

only 40 or 50 pounds of honey, so he told me on Sept. 1. He has an apiary across the river at Fallen Water, from which he will get some honey. He says it will take many a pound of sugar to winter them.

My brother has an apiary of 65 colonies 1 1/2 miles south of me, and he got only 30 pounds and no swarms, and will have to feed considerable. I had in the spring 20 colonies, transferred 12 of them last March, and introduced queens in 9 of them, and got exactly 200 pounds of section honey, nicely sealed over. I sold it all at 15 cents per pound, and I also got 40 or 50 pounds of unsealed honey. I had one swarm. I am only 1/2 mile from the river where there is plenty of blue thistle, hunden and other flowers. I am feeding considerable now. The honey harvest closed about the first of July, and the drouth set in, so there is nothing for the bees to gather—in fact, nearly all of my bees are nearly out of honey.

My brother and I bought 11 colonies a few weeks ago for \$5.00, but they will take some feeding. They gave us 4 that were entirely out of honey two weeks ago last Saturday. I transferred my 2 into my hives, and have them fed up all right. They will pull through until spring.

I do honestly believe that 3/4 of the bees will be starved out before November, for there are very few bee-men here.

I shall continue to read the good "old reliable" American Bee Journal, and hope that every bee-keeper may become a subscriber.
L. A. HAMMOND.
Keedysville, Md., Sept. 7.

Good Season.

We have had a very good season for honey, and it has been a very peculiar one. We got no clover honey until after basswood. Since then it has yielded quite freely. It is still in blossom, and the bees are still working on it.

F. E. HENRY.
Logan, Iowa, Sept. 10.

A Lady's Report.

I began with one colony of bees four years ago. I sold one colony last year, one colony died last winter, and I now have 10 colonies, from one of which I have taken 10 1/2 one-pound sections of honey, and they are at work on another set of sections. None of the other colonies have filled two supers yet.

MRS. R. R. TITUS.
Brookville, Kans., Sept. 15.

Bees Didn't Do Well.

Bees have not done very well here this year. We had too much rain in May and June. They got the second crop of alfalfa; then it became too hot and dry. I will have to feed some of my late swarms.

C. URMEY.
Salina, Kans., Sept. 12.

Realizing Most on Extracted Honey.

Put it up in a small package, and urge the sale and consumption in your vicinity, which you can do if you begin early in the season. You can put your honey in a small size package, and dispose of it as well as bottlers in the city can. People in country towns appreciate the value of honey better than people in the

THE "NOVELTY" POCKET-KNIFE!



Your Name on the Knife.—When ordering, be sure to say just what Name and Address you wish put on the Knife.

The NOVELTY KNIFE is indeed a novelty. The novelty lies in the handle. It is made beautifully of indestructible celluloid, which is as transparent as glass. Underneath the celluloid, on one side of the handle is placed an AMERICAN BEE JOURNAL reminder, and on the other side, name and residence of the Subscriber.

The material entering into this celebrated knife is of the very best quality; the blades are handforged out of the very finest English razor-steel, and we warrant every blade. The bolsters are made of German silver, and will never rust or corrode. The rivets are hardened German silver wire; the linings are plate brass; the back springs of Sheffield spring steel, and the finish of handle as described above. It will last a lifetime, with proper usage.

Why purchase the Novelty Knife? In case a good knife is lost, the chances are, the owner will never recover it; but if the Novelty is lost, having name and address of owner, the finder will return it; otherwise to try to destroy the name and address, would destroy the knife. If traveling, and you meet with a serious accident, and are so fortunate as to have one of the Novelties, your pocket KNIFE will serve as an identifier; and in case of death, your relatives will at once be apprised of the accident.

How appropriate this knife is for a Christmas, New Year or birthday present! What more lasting memento could a mother give to a son, a wife to a husband, a sister to a brother, a lady to a gentleman, or vice versa, a son to a mother, a husband to a wife, a brother to a sister or a gentleman to a lady—the knife having the name of the recipient on one side? The accompanying cut gives a faint idea, but cannot fully convey an exact representation of this beautiful knife, as the "Novelty" must be seen to be appreciated.

How to Get this Valuable Knife.—We send it postpaid, for \$1.00, or give it as a Premium to the one sending us three new Subscribers to the BEE JOURNAL (with \$3.00), and we will also send to each new name a copy of the Premium Edition of the book "Bees and Honey." We club the Novelty Knife with the BEE JOURNAL for one year, both for \$1.90.

Any Name and Address Put on the Knife.

GEORGE W. YORK & CO.,
CHICAGO, ILLS.

Allow about two weeks for your order to be filled.

PATENT WIRED COMB FOUNDATION

Has No Sag in Brood-Frames

Thin Flat-Bottom Foundation

Has No Fishbone in the Sargins Honey.

Being the cleanest is usually worked the quickest of any Foundation made

J. VAN DEUSEN & SONS,
Sole Manufacturers,
Sprout Brook, Montgomery Co., N. Y.



ONE MAN WITH THE UNION COMBINATION SAW

Can do the work of four men using hand tools, in Rippling, Cutting-off, Milling, Rabbeting, Grooving, Gaining, Dadoing, Edging-up, Jointing Stuff, etc. Full Line of Foot and Hand Power Machinery Sold on Trial. Catalogue Free.

SENECA FALLS MFG. CO.,
46 Water St., SENECA FALLS, N. Y.
1Aly Mention the American Bee Journal.

WARRANTED GOLDEN

ITALIAN QUEENS By return mail; bred from a Breeder tested by Doolittle out of 1,000 Queens for his own use, and valued at \$50. Queens, 50c; 6 for \$2.75; or \$5.00 per dozen.

Leather Colored Queens from Root's best imported stock same price. Bees from my Queens are excellent workers on red clover. I guarantee safe delivery. N. B.—I sent more than 200 Queens safely to California last season.
H. G. QUIRIN, Bellevue, Ohio.

34A9 Mention the American Bee Journal.

SHIPPING - CASES, HONEY - JARS, —CARTONS, LABELS—

And a Full Line of Supplies.
Comb & Extracted Honey.

I. J. STRINGHAM,
105 Park Place. NEW YORK, N. Y.
APIARY—Glen Cove, L. I.

That Queen-Clipping Device Free!

Works Like a Charm.

The Monette Queen-Clipping Device WORKS LIKE A CHARM. With it I have clipped 30 queens, all in one day, when examining my bees.
WM. STOLLEY, Grand Island, Nebr.

Couldn't Do Without It.

I have clipped 19 queens, and must say the Monette Queen-Clipping Device is by far the best invention ever made, and will be welcome to many bee-keepers as it was to me. I could not do without one now.

DR. GEO. LACKE, Newburgh, Ind.

PLEASE READ THIS OFFER TO PRESENT SUBSCRIBERS:

Send us just one new name for the American Bee Journal a year (with \$1.00), and we will mail you the Queen-Clipping Device FREE of charge. Or, the Queen-Clipping Device will be sent postpaid for 30 cts. But why not get it as a Premium by the above offer? You can't earn 30 cts. any easier. Almost every bee-keeper will want this Device. See page 130 (Feb. 27) for full description of it. Complete directions accompany each one sent out. It is a most ingenious and useful article. Address,

GEORGE W. YORK & CO., 118 Michigan St., Chicago, Ill.

city, who know but very little about how honey is produced, and are suspicious, and think that all extracted honey is adulterated, especially so after it becomes granulated.

If you have a large crop of extracted honey, I would not advise putting all in small packages, but put it up that way as fast as you can sell it, and the balance in 160-pound kegs, and send it to the city market to be sold to manufacturers and the Polish Jew trade; these two being the largest consumers of honey outside of the bottlers.

We notice a small size glass jar on the market that holds a half-pound of honey. It is quickly filled and simply sealed, so it doesn't leak, as all screw-cap jars do when turned sidewise. These jars cost about 2 cents, and when filled with honey they can be sold at the popular price of 10 cents to the consumer, which is equal to about 15 cents per pound, and sell at wholesale for \$1.00 per dozen. For shipping, they come packed two dozen in a racked case, and make a very attractive shipping-case.

H. R. WRIGHT.

Bee-Paralysis—The Sulphur Remedy.

Regarding "Bacillus Gaytoni," which is the cause of bee-paralysis, Mr. Poppleton, page 595, refers to his experience with sulphur as a "probation est" for said disease. I would like to suggest a most handy, practical way of applying the same, with the best possible effect attainable, and very simple it is—by using *lac sulphur*, which is an impalpable powder. Such can be used with great advantage in an ordinary insect powder duster (which can be had at any drugstore for the sum of 10 cents), and dusted on, either at the entrance or blown in on top, between the frames and on the combs.

The remedy is non-toxic, and what-ever the bees will take up of it would only relieve their bloated condition, by relieving their suffering from costiveness. Besides this, it looks very reasonable that this very remedy should have some specific action on said disease, as sulphur has long been used in the medical practice for a number of diseases of a similar nature in mankind. I refer to diseases of the scalp and the hair follicles proper, where it is caused by a fungus or bacillus. Besides, sulphur is a principal constituent of the hair.

Ewing, Nebr. E. E. NUSSLE, M. D.

Question-Box.

In the multitude of counsellors there is safety.—Prov. 11-14.

When to Unite Colonies.

Query 29.—My bees have swarmed so that I have more colonies than I want to keep. Would you advise me to unite them this fall, or next spring?—Wis.

J. M. Hambaugh—Unite in the fall.

Dr. J. P. H. Brown—I would unite this fall.

Chas. Dadant & Son—In the fall rather than in the spring.

G. M. Doolittle—It will cost less in stores and work to unite this fall.

J. A. Green—If your bees have honey enough and are strong enough in numbers to go through the winter safely, by

RAILROAD LANDS

For Sale at Low Prices and on Easy Terms.

The Illinois Central Railroad Company offers for sale on easy terms and at low prices, 150,000 acres of choice fruit, gardening, farm and grazing lands located in

SOUTHERN ILLINOIS.

They are also largely interested in, and call especial attention to the 600,000 acres of land in the famous

YAZOO VALLEY OF MISSISSIPPI

lying along and owned by the Yazoo & Mississippi Valley Railroad Company, and which that company offers at low prices and on long terms. Special inducements and facilities offered to go and examine these lands, both in Southern Illinois and in the "Yazoo Valley," Miss. For further description, map, and any information, address or call upon E. P. SKENE, Land Commissioner, No. 1 Park Row, Chicago, Ill. 33D6t



Bee Supplies

Largest Stock and Greatest Variety in the West. **BEST** food at **LOWEST** prices. Cat. of 50 pages FREE.

E. KRETZMER, RED OAK, IOWA.

Mention the American Bee Journal. 23D9t

Sweet Clover ¹/_N Canada.

At the following prices:

5 lbs.	10 lbs.	25 lbs.	50 lbs.
\$1.00	\$1.60	\$3.75	\$7.25.

Also a quantity of Motherwort and Catnip seed. Prices on application.

EGGS for Hatching. Buff Leghorns, Indian Games, & Light Brahmas. Ch. Ice Birds. A breeder for 30 years. Prices on application

JOHN McARTHUR,

881 Yonge Street, TORONTO, ONT.
15Atf Mention the American Bee Journal.

Queens and Queen-Rearing.

If you want to know how to have queens fertilized in upper stories while the old queen is still laying below; how you may safely introduce any queen, at any time of the year when bees can fly; all about the different races of bees; all about shipping queens, queen-cages, candy for queen-cages, etc.; all about forming nuclei, multiplying or uniting bees, or weak colonies, etc.; or, in fact, everything about the queen-business which you may want to know—send for Doolittle's "Scientific Queen-Rearing"—a book of over 170 pages, which is as interesting as a story. Here are some good offers of this book:

Bound in cloth, postpaid, \$1.00; or clubbed with the BEE JOURNAL for one year—both for only \$1.75; or given free as a premium for sending us three new subscribers to the BEE JOURNAL for a year at \$1.00 each.

See the premium offer on page 618!

all means wait until spring. Perhaps you will not have more than you need then.

Dr. C. C. Miller—Next spring, unless you're sure how many will live over winter.

Emerson T. Abbott—This fall, if at all, and then have the extra combs for spring feeding.

P. H. Elwood—After making allowance for a reasonable loss in wintering, unite in the fall.

Jas. A. Stone—I would have united them at swarming-time. In this case, I would unite this fall.

Prof. A. J. Cook—I have usually united in the fall, but I see advantages in waiting till spring.

C. H. Dibbern—I should unite them this fall, in September, as they will consume less united than if wintered separately.

Eugene Secor—If I had more bees than I wanted, and could not sell them, I would extract the honey after killing the bees.

W. G. Larrabee—If they have plenty of honey, wait until spring. If they are short of honey, and you do not care to feed, unite this fall.

Wm. McEvoy—Unite all the weakest colonies in the evenings, this fall, and the balance at the beginning of next honey harvest that you find the weakest then.

E. France—Wait until spring; not likely to be as many then as now. Then if you have more than you want, sell them. Not much gained by uniting strong colonies.

R. L. Taylor—If each colony has enough stores to winter it safely, I would not unite until next June, when white clover begins to open. Light and weak colonies should be united as soon as possible this year.

Mrs. J. N. Heater—In the spring, if at all. Your winter losses may reduce your stock as low as you wish to have it, or you may have queenless colonies in the spring that will need to be united with others.

G. W. Demaree—Why did you permit them to swarm more than you wanted? You can control swarming by raising the brood above a queen-excluder, if done just before, or just after, the swarm issues. In your case, it is cheapest to do the doubling up in the fall.

Mrs. L. Harrison—Unite them this fall, and save best queens. Or do as a farmer acquaintance, sulphur them, and put the hives in a room where neither mice nor bees can gain access to them. Is it any more cruel to suffocate bees, than it is to kill the family cow?

Rev. M. Mahin—By uniting in the fall you will save some honey, as a given number of bees will consume less honey as one colony than as two. But if you are not sure of wintering all your bees, it would be better to wait until spring. Perhaps by the first of May you may not have more than you want.

J. E. Pond—I prefer uniting in the fall, for the reason that I have not found uniting in the spring to be of much value. If I find weak colonies in the spring, I prefer to build them up from strong colonies. It doesn't pay me to unite old colonies in the spring; but by building up at that time, I have young bees coming along, as would be the case with a strong colony.

THE GREAT CAMPAIGN

—OR—

Political Struggles of Parties, Leaders and Issues

COMPRISING

Biographies of the Republican, Democratic,
Populistic, Prohibition and National
Nominees for President and Vice-President
of the United States.

—ALSO—

The Platforms, Principles and Leaders of All Parties

DISCUSSING

ALL VITAL QUESTIONS OF THE DAY

HAVING AS ITS OBJECT

The Enlightenment and Education of American

—VOTERS—

Upon the Living Issues of the Hour.

The Gold Standard of Currency, Bi-Metalism, Free Coinage of Silver, High Protective Tariff, Tariff for Revenue Only, Prohibition, Licensed Liquor Traffic, the Doctrine of Reciprocity, the Monroe Doctrine, Laws Governing Our Relations with Other Nations, the Venezuelan, Armenian and Cuban Questions. Containing also Lives and Portraits of former Presidents, with a Review of their Administrations and the Political Lessons gleaned from them; together with a Portrait Gallery of Statesmen and Political Celebrities comprising 100 accurate Phototypes and other Portraits, embracing the most active and prominent statesmen in our Nation. The whole forms a Voter's Hand-Book of Political Information, thoroughly practical, enjoyable and instructive, enabling him to vote intelligently upon those vital subjects which constitute the living issues of the present great campaign.

This book embodies the views and opinions of the great leaders from the various party points of view, clearly explaining all the momentous questions now before the people. It is planned upon the broad principles of non-partisan national patriotism, and attacks no man's creed, and upholds the ban-

American citizen. It is a vast storehouse of truth, plain, simple and unvarnished, which makes this work an unequalled source of information upon the great issues of this campaign, suited to the wants of every voter irrespective of party and without partisan bias.

Our Country calls for thirteen million volunteers. "I do love my country's good with a respect more tender, more holy



Levering.



Bentley.

and profound than mine own life," is the language which Shakespeare puts into the mouth of an ideal patriot. May this sentiment find a universal echo to the hearts of the voters of the United States of America who go to the polls in November, 1896.

Great questions are to be settled; a mighty battle is to be fought; a battle of ballots such as this country has never witnessed, which, in its far-reaching effects, will accomplish on the field of American suffrage, at the Ballot Box, next November, results as potential for good or evil to our Nation, revolutions as radical, and effects as lasting upon our institutions, as were ever wrought upon the field where sword and bullet, grape and canister settled the issue of the hour.

An impartial view of the situation reveals the fact that our Country never needed more broad-minded wisdom and unselfish patriotism in all her history than she requires to guide her through the present crisis.

Since the rising war cloud of 1859-60 which deluged our Country in the blood of brothers, our Nation has not been so agitated, divided and excited as it is to-day from ocean to ocean—North, South, East and West, on the great financial question, which is a vital issue of this campaign; and its settlement is fraught with threatenings and omens indicating political combinations, upheavals and surprises which our shrewdest politicians seem unmindful of or unwilling to recognize.

Since 1873 the mutterings of discontent have been growing louder between the advocates of Gold and Bi-metal standards. During the past three years, these mutterings have grown into clamorous shouts and peremptory demands on both sides. Statesmen never thought so diligently or more deeply on any subject; and the whole country never was so eager to have all sides of this momentous question presented in a clear, lucid and intelligible manner which the common reader can understand—the money question.

The Doctrine of Reciprocity is also treated at length from a broad, patriotic and non-partisan point of view.

This volume contains about 600 pages, is printed on super-calendered paper, and bound in beautifully lithographed board covers. The pictures of the four principal Presidential candidates shown herewith appear on the front outside cover, and the Vice-Presidential candidates on the back cover.

How to Get the Above Book.

Send \$1.00 and receive it postpaid. Or, send us two new subscribers for the Bee Journal at \$1.00 each, and we will mail you the book free as a premium. Or, for \$1.75, we will mail you the book and the Bee Journal for one year. Address,

GEORGE W. YORK & CO.,

118 Michigan Street,

CHICAGO, ILL.



McKinley.



Bryan.

ner of no party; but placing every party and its principles, with its leaders upon its own platform, and bringing the several parties, platforms and champions in their true light before the mind of the reader, the intelligent citizen will, in this book, be enabled to view and compare them side by side and judge of their respective claims upon his vote as an

HONEY and BEESWAX

MARKET QUOTATIONS.

The following rules for grading honey were adopted by the North American Bee-Keepers' Association, and, so far as possible, quotations are made according to these rules:

FANCY.—All sections to be well filled; combs straight, of even thickness, and firmly attached to all four sides; both wood and comb unsoiled by travel-stain, or otherwise; all the cells sealed except the row of cells next the wood.

No. 1.—All sections well filled, but combs uneven or crooked, detached at the bottom, or with but few cells unsealed; both wood and comb unsoiled by travel-stain or otherwise.

In addition to this the honey is to be classified according to color, using the terms white, amber and dark. That is, there will be "fancy white," "No. 1 dark," etc.

Chicago, Ill., Sept 18.—Fancy white, 13c; No. 1, 12c; fancy amber, 9@11c; No. 1, 8@9c; fancy dark, 8@10c; No. 1, 8c. Extracted, white, 5@7c; amber, 5@6c; dark, 4½@5c. Beeswax, 24@25c.

The sales of best grades of comb honey are now assuming more volume, and most sales are at 12, 12½, and 13c. All of the shipments that show care in preparation for transportation are arriving in good order. The market is all over dark comb honey, and there is a demand for it which anyone having a supply should take advantage of by shipping now.

Philadelphia, Pa., Aug. 14.—Extracted, white, 8-10c; amber, 4-5c; dark, 3-4c. Beeswax, 25c.

No new comb in this market yet. Old comb cleaned out.

Detroit, Mich., Aug. 8.—No. 1 white, 12-12½c; fancy amber, 10-11c; No. 1 amber, 9-10c; fancy dark, 8-9c. Extracted, white, 5½-6c; amber, 5-5½c; dark, 4-5c. Beeswax, 24-25c.

Indianapolis, Ind., July 28.—Fancy white 15-16c; No. 1 white, 13-14c. Extracted, white, 6-7c. Beeswax, 25-27c.

No demand at all for grades of either comb or extracted honey. Large fruit crop and warm weather are opponents to the demand for honey at present.

St. Louis, Mo., Aug. 8.—Fancy white, 13@14c; No. 1 white, 12@12½c; fancy amber, 11@11½c; No. 1 amber, 10@10½c; fancy dark, 8@9c; No. 1 dark, 7@7½c. Extracted, white, in cans, 5c; in barrels, 4@4½c; amber, 3@3½c; dark, 2½@3c. Beeswax, 19@20c.

Very little honey coming in at present, and the weather is too warm to handle to advantage if it were here.

Albany, N. Y., Sept. 19.—Fancy white, 13-14c; No. 1, 12-13c; fancy amber, 10-11c; No. 1 dark, 8-9c. Extracted, white, 6-7c; dark, 5c.

With cooler weather there is an increasing demand for comb honey, and stock is moving off freely. There is but very little demand for extracted, except fancy white put up in glass jars.

New York, N. Y., Sept. 9.—Fancy white, 13c; No. 1, 12c; fancy amber, 11c; No. 1, 10c; dark, 9c. Beeswax declining; 23@24c, a new top price.

New crop comb honey is now arriving freely. The demand is fair only, and mostly for small lots of 10 to 25 crates. Some exceptionally fine lots will probably sell for a little more. No change in extracted, with plenty of supply.

San Francisco, Calif., Sept. 8.—White comb, 10c; amber, 7½-9c. Extracted, white, 5-5½c; light amber, 4½-4¾c; amber colored and candied, 3¾-4c; dark tulle, 2¾-3c.

Supplies in this center are of limited volume, and are composed mainly of last season's extracted in connection with a little of this year's comb. Business is slow. Prices are too high for any export trade, and very little is required to satisfy the local demand.

Beeswax, fair to choice, 23-26c. Sales are not numerous, nor do they aggregate any large quantity. Market is moderately firm for strictly choice light colored, but where the quality is faulty, buyers are not readily found.

Milwaukee, Wis., Aug. 8.—Fancy white, 14-15c; No. 1, 12-13c; No. 1 amber, 8-10c. Extracted, white, 6-7c; amber, 5-6c; dark, 4-5c. Beeswax, 22-24c.

New crop of honey begins to come forward. The demand is very poor and quotations almost nominal. Weather is very warm and the consumption of honey is very small. Plenty of fruit, and hence the appetite is satisfied with same in preference. Later on we expect an improved demand for honey of all kinds.

Minneapolis, Minn., Aug. 8.—Fancy white, 12½c; No. 1 white, 10@11c; fancy amber, 9@10c; No. 1 amber, 8@9c; fancy dark, 7@8c; No. 1 dark, 6-8c. Extracted, white, 5½@6½c; amber, 5@5½c; dark, 4@5c. Beeswax, 23@26c.

The demand for both comb and extracted is very quiet, and for the latter, nominal. The hot weather of the past week or so has checked demand for comb honey.

Cleveland, Ohio, Aug. 8.—Fancy white, 14½@15c; No. 1 white, 12½@13c. Extracted, white, 6@7c; amber, 4½@5½c. Beeswax, 22@25c.

There is not very much honey in our market. Selling rather slow. Demand beginning to be a little better. Think trade will be fair in this line this fall.

Kansas City, Mo., Aug. 8.—Fancy white comb, 15c; No. 1 white, 13@14c; fancy amber, 12-13c; No. 1 amber, 11-12c; fancy dark, 10-11c; No. 1, 8-10c. Extracted, white, 6-6½c; amber, 5-5½c; dark, 4-4½c. Beeswax, 22-25c.

Boston, Mass., Aug. 10.—Fancy white, 14-15c; No. 1, 12-13c; fancy amber, 9-10c. Extracted, white, 6-7c; amber, 5-6c. Beeswax, 25c.

Good supply of new honey, but demand is light this very hot weather.

Buffalo, N. Y., Sept. 19.—Fancy comb, 1 pound, mostly 12c, occasionally 13-14c; No. 1, 8-10c; No. 2, 4-7c. Extracted, 4-5c. Demand grows better as fruit decreases.

List of Honey and Beeswax Dealers.

Most of whom Quote in this Journal.

Chicago, Ills.

R. A. BURNETT & Co., 163 South Water Street.

New York, N. Y.

HILDRETH BROS. & SEOLKEN,
120 & 122 West Broadway.
CHAS. ISRAEL & BROS., 486 Canal St.

Kansas City, Mo.

O. C. CLEMOMS & Co., 423 Walnut St.

Buffalo, N. Y.

BATTERSON & Co., 167 & 169 Scott St.

Hamilton, Ills.

CHAS. DADANT & SON.

Philadelphia, Pa.

WM. A. SELSER, 10 Vine St.

Cleveland, Ohio.

WILLIAMS BROS., 80 & 82 Broadway.

St. Louis, Mo.

WESTCOTT COM. CO., 213 Market St.

Minneapolis, Minn.

S. H. HALL & Co.

Milwaukee, Wis.

A. V. BISHOP & Co.

Boston, Mass.

E. E. BLAKE & Co., 57 Chatham Street.

Detroit, Mich.

M. H. HUNT, Bell Branch, Wayne Co., Mich.

Indianapolis, Ind.

WALTER S. POWDER, 162 Massachusetts Ave.

Albany, N. Y.

CHAS. McCULLOCH & Co., 380 Broadway.

Cincinnati, Ohio.

C. F. NUTH & SON, Cor. Freeman & Central avs.

Convention Notices.

TENNESSEE.—The Southern East Tennessee Bee-Keepers' Association will hold its annual meeting at Cookson's Creek, on Oct. 10, 1896. Session will open at 9 o'clock a.m. All are invited to attend, and especially those engaged in bee-culture. W. J. COPELAND, Sec. Fetzerton, Tenn.

CONNECTICUT.—The fall meeting of the Connecticut Bee-Keepers' Association will be held in the Capitol at Hartford, on Oct. 21, 1896, at 10:30 a.m. All interested in bees and the production of honey are invited to attend this meeting. Waterbury, Conn. MRS. W. E. RILEY, Sec.

UTAH.—The semi-annual meeting of the Utah State Bee-Keepers' Association will be held in the City and County building, on Oct. 5, 1896, at 10 a.m. All are invited. If we take into consideration existing conditions, it should be apparent to all that a good foul brood law for the protection of our bee-keepers is extremely necessary. For this and other reasons it is hoped that all our bee-keepers will attend and assist in framing a good law. Our bee-keepers should unite and work for their own interest, and for the general benefit and success of the bee industry. Provo, Utah. GEO. E. DUDLEY, Sec.

WISCONSIN.—The annual meeting of the Southwestern Wisconsin Bee-Keepers' Association will be held at Wauzeka, Wis., Oct. 7 and 8, 1896. All that are interested in apiculture are invited to attend, and especially those that want a foul brood law to protect their bees from this dread disease. Our committee is working hard to get every bee-keeper interested, and we should all feel it is for our interest to help get a State law to protect our bees. Many of our prominent bee-keepers of the State have promised to be at our meeting, and no one can afford to miss it. M. M. RICE, Sec. Boscobel, Wis.

North American Bee-Keepers' Association

OFFICERS FOR 1896.

PRESIDENT—A. I. Root..... Medina, Ohio.
VICE PRES.—Wm. McEvoy..... Woodburn, Ont.
SEC.—Dr. A. B. Mason..... Sta. B. Toledo, Ohio.
TREAS.—W. Z. Hutchinson..... Flint, Mich.
Convention at Lincoln, Nebr., Oct. 7 & 8.

National Bee-Keepers' Union.

PRESIDENT—Hon. R. L. Taylor, Lanier, Mich.
GEN'L MGR.—T. G. Newman, San Diego, Cal.

Bee-Keepers' Photograph.—We have now on hand a limited number of excellent photographs of prominent bee-keepers—a number of pictures on one card. The likeness of 49 of them are shown on one of the photographs, and 121 on the other. We will send them, postpaid, for 30 cents each, mailing from the 121 kind first; then after they are all gone, we will send the 49 kind. So those who order first will get the most "faces" for their money. Send orders to the Bee Journal office.

CORRECT MANNERS: HOW TO BEHAVE IN SOCIETY

Containing clear and concise directions for correct manners and usages of polite society. Many people have been misjudged for years simply because they had neglected to perform some little polite act at the proper time; many young men and women have lost the opportunities of a life-time on account of their ignorance of some trifling, customary rule of Society. Our BOOK tells all about it. 186 pages. Russia. Red Edges. Price, 75 cts.



Special Offer: We will mail this book free as a premium to any one sending us two New Subscribers to the Bee Journal for one year (with \$2.00), and also send a copy of the premium book "Bees and Honey" to each of the new subscribers; or we will club the book with the Bee Journal for a year—both for \$1.60.

GEORGE W. YORK & CO.,
CHICAGO, ILLS.

Bottom Prices

**BRING US BIG TRADE.
GOOD GOODS KEEP IT.**

If you want the best supplies that can be made at a little less cost than you can buy the same goods for elsewhere, write to us for low prices. 1896 Catalogue now ready—ask for it and a free copy of **The American Bee-Keeper** (36 pages).

Address,
**THE W. T. FALCONER MFG. CO.,
JAMESTOWN, N. Y.**

Mention the American Bee Journal.

COMB FOUNDATION!

Wax always wanted for Cash or in Exchange for Fdn. or other Supplies. My trade is established on **Low Prices** and the merit of my **Foundation**. Orders filled promptly.

WORKING WAX INTO FDN. BY THE LB. A SPECIALTY. Wholesale prices to dealers and large consumers. Send for Prices and Samples to—**GUS DITTMER, AUGUSTA, WIS.** Reference—Augusta Bank. 1A1f

Mention the American Bee Journal.

Honey-Clovers & Buckwheat SEED FOR SALE.

We have made arrangements so that we can furnish seed of several of the Clovers and Japanese Buckwheat, by freight or express, at the following prices, cash with order

	5lb	10lb	25lb	50lb
Alsike Clover	\$.70	\$1.25	\$3.00	\$ 5.75
Sweet Clover	.75	1.40	3.25	6.00
White Clover	1.25	2.00	4.50	8.00
Alfalfa Clover	.65	1.10	2.70	5.00
Crimson Clover	.55	.90	2.00	3.50
Jap. Buckwheat	.20	.35	.90	1.25

Prices subject to market changes.

Add 25 cents to your order, for cartage, if wanted by freight.
Your orders are solicited.

**GEORGE W. YORK & CO.,
CHICAGO, ILLS.**

MUTH'S HONEY EXTRACTOR PERFECTION Cold-Blast Smokers,

Square Glass Honey Jars, Etc.

For Circulars, apply to **CHAS. F. MUTH & SON, Cor. Freeman & Central Aves., Cincinnati, O.** Send 10c for Practical Hints to Bee-Keepers.

Mention the American Bee Journal.

A Bargain—EARLY QUEENS.

119 Colonies Italian Bees in Chaff Hives; two acres land; good house; excellent well.

Early Queens—Tested, \$1.00; Untested, 50c. Sent by return mail.

**E. L. CARRINGTON,
16Atf PETTUS, Bee Co., TEX.
Reference—1st National Bank of Beeville.**

Mention the American Bee Journal.

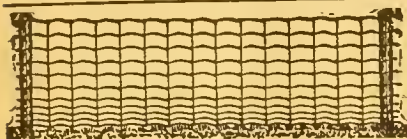

IT'S UNCERTAINTY THAT HURTS!

That's what the business men claim, and why not consider that feature when figuring on the fence problem. With an unproved device you are never sure that your stock and crops are safe. We are selling **Page** to men who have tested it over ten years. They're not experimenting.

PAGE WOVEN WIRE FENCE CO., Adrian, Mich.
Mention the American Bee Journal.

19th Year Dadant's Foundation 19th Year

It still in the lead, for we use all the latest improvements, including the

NEW WEED PROCESS,

and still make the best goods. Remember that we do not use any acid to purify our beeswax, and that is why our Foundation preserves the smell of the honey and is more acceptable to the bees, than any other. It is kept for sale by

T. H. Strickler, Solomon City, Kansas.
G. K. Hubbard, Fort Wayne, Ind.
L. Hanssen, Davenport, Iowa.
C. Theilmann, Theilmanton, Minn.
E. C. Eaglesfield, Berlin, Wis.
E. T. Abbott, St. Joseph, Mo.
J. M. Jenkins, Wetumpka, Alabama
John Rey, East Searusw, Mich.
Vickery Bros., Evansville, Ind.

The Jennie Atchley Company, Beeville, Texas.
C. F. Muth & Son, Cincinnati, Ohio.
E. Kretschmer, Red Oak, Iowa.
G. B. Lewis Co., Watertown, Wis.
James Reynolds' Elevator Co., Poughkeepsie, N. Y.
Louisiana Bee-Keepers' Supply Manufactory, Donaldsonville, La.
Page & Lyon, New London, Wis.
John Nebel & Son, High Hill, Mo.

and many other Dealers. All agree in saying that no goods are better than ours.

We make a specialty of **Veits and Veil Stuffs** of best quality, cotton and silk.

Langstroth on the Honey-Bee, Revised

Bee-Keepers' Supplies, Smokers, Sections, Tin Pails, etc.

Samples of Foundation and Tulle FREE with Circular. Instructions to beginners with Circular. Send us your address.

CHAS. DADANT & SON,

Mention the American Bee Journal.

HAMILTON, Hancock Co., ILL.

See Campaign Book Offer on page 623! Better Have It!

* Extracted Honey *



Finest Quality, Basswood and Clover.
2 60-lb. cans in case 8c. per pound. 1 60-lb. can in case, 9c. per pound. A sample by mail, 10 cts. **POUDER'S Honey-Jars and Complete Line of Supplies.** Catalogue Free.

**WALTER S. POUER,
162 Mass. Avenue, INDIANAPOLIS, IND.**

Mention the American Bee Journal.

Jars : Cans : Cases !

Muth pattern Square Flint Glass Jars 1-lb. per gross, \$4.75; 1/2-lb. per gross, \$3.80. Square 60-lb. Tin Cans, two in a box, per box, 65c.; 10 boxes, \$6.00. Shipping-Cases, 10 24-lb. cases, \$1.30; 10 12-lb. cases, 80c.

W. J. FINCH, Jr., SPRINGFIELD ILLS.

Mention the American Bee Journal.

Good Prices on Your Comb Honey!

Then you want our latest

NON-DRIP SHIPPING-CASES.

Our trade was never so large in these as now; and Commission Men tell us that Comb Honey in our Cases brings

BETTER PRICES

than some of the Cases made by competitors. The fact is, we know the demands of the trade, and are prepared to supply them. Remember, home-made or poorly made Cases are dear at any price. Honey in such Cases always brings several cents below the market price.

If you wish to get **GILT-EDGE PRICES** on **GILT-EDGE HONEY** put it up in

Root's Non-Drip Shipping-Cases.

THE A. I. ROOT COMPANY,

Factory and Main Office, **MEDINA, O.**

BRANCH OFFICES :

**118 Michigan St., Chicago, Ill.
1024 Miss. Str., St. Paul, Minn.**

**Syracuse, N. Y.
Mechanic Falls, Maine.**

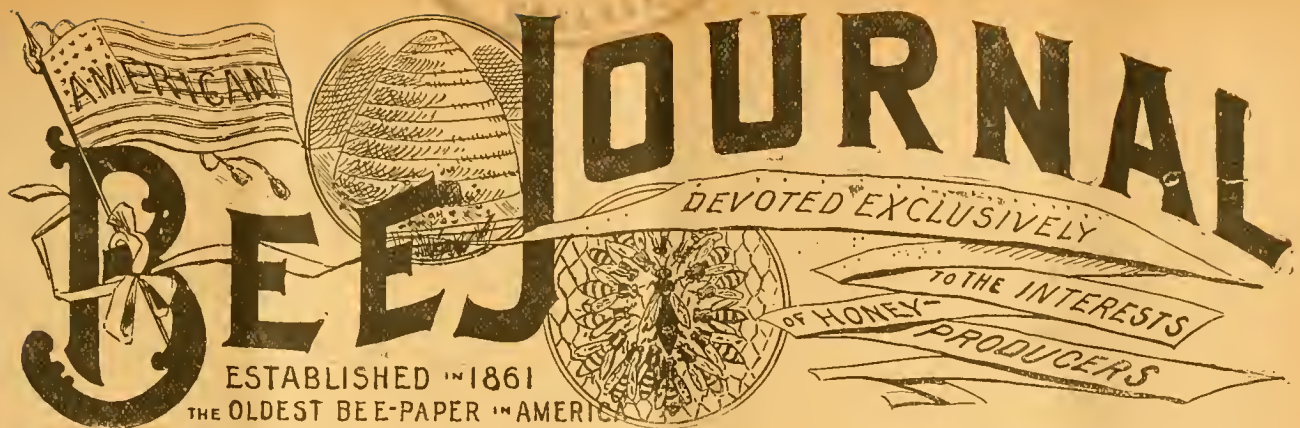

AMERICAN BEE JOURNAL

DEVOTED EXCLUSIVELY TO THE INTERESTS OF HONEY PRODUCERS

ESTABLISHED IN 1861
THE OLDEST BEE-PAPER IN AMERICA

Published Weekly, at \$1.00 per annum.

Sample Copy sent on Application.

36th Year.

CHICAGO, ILL., OCTOBER 1, 1896.

No. 40.



Bees and Grapes—Some Expert Testimony.

BY C. P. DADANT.

In the last number of *Gleanings in Bee-Culture*, I notice an article by the editor in which he inquires into the damage done by bees to grapes, and asks whether we should lay all or part of the blame upon the bees. As this is one of the rare seasons during which bees are seen upon grapes in large numbers, I wish to make some remarks upon the subject.

We have a large apiary on our home farm, but we have also a still larger vineyard, covering in all, now, 13 acres. The season of 1879 was the first in which we noticed bees working on the grapes to any extent, and in that season considerable complaint came to our ears from neighbors who imagined that we were getting rich at their expense. The fact is, that the bees were then starving, the drouth having destroyed all hopes of a honey crop. But the latter part of the summer was wet, when it was too late for the blossoms to come out. This wet weather caused fresh sap to flow in the stems of the vines, and the grapes became so full of juice that many of them burst. As a matter of course, the tenderest berries, those that had the thinnest skin, split the worst. In addition to this, as there were no other fruits, the birds pounced upon the grapes with great greed. A near neighbor of ours who had a small vineyard near a large timber said to us with great wrath:

"I know how it is about our grapes; I have examined the matter carefully; it is the bees that do the damage, and they always make two holes in each berry, one just above the other."

We tried to explain to him that the two holes were made by the beak of the bird when he was tired of eating, and still took pleasure in puncturing the juicy fruit. This was plain and evident, especially as the berries were all punctured on the same side of the bunch. But nothing would do. He could not see the birds at work, for they always come at day break, and are usually off before the vineyardist comes. But the poor bees, unaware of the harsh reputation that they are making for themselves, visit the punctured berries from morning till night and the entire damage is charged to them!

Well, it was of no use to try to explain; our man got angry, and would not speak to us any more, and we believe

that to this day he is of the opinion that the bees always make two holes in each berry.

But *can* bees puncture grapes? We have made repeated experiments, placing bunches of grapes inside of the hive, or attracting the bees to bunches so placed that we could keep them under our eyes and make sure that no other insects and no birds could approach, and we have invariably proven the assertion of Aristotle, made 2,000 years ago, and quoted by Mr. Langstroth, as correct, viz.: that "bees hurt no kinds of sound fruits, but that wasps and hornets are very destructive to them."

This is plain and easy to understand, most especially if one is acquainted with the shape of the mandibles or jaws of the bee. "These jaws are short, thick, without teeth, and beveled inside so as to form a hollow when joined together, as two spoons would do.... Wasps and hornets are furnished with strong, saw-like jaws, for cutting the woody fibre with which they build their combs, and can easily penetrate the skin of the toughest fruits."

Some four or five years ago the principal of our high school, in a lesson in entomology, requested her pupils to give her a list of the insects injurious to fruits. The bees were placed upon this list, and a discussion ensued. The attention of the president of the school board was called to the matter, and inasmuch as the principal had herself positively declared against the bee, he came to me and requested me to come before the class and give them my experience. I did so, but although no one tried to contradict my remarks on the natural history of the bee, it was evident to me that a little actual practical experience would go much farther towards convincing my hearers than all the theories in the world. So I asked the principal whether she would have any objection to a practical test. I agreed to furnish the bees, to attract them to the school-house, if the scholars would furnish the fruit.

A day was set, grapes, pears and peaches were brought, and a little honey served to attract the bees. They came in numbers. Then the honey was removed, and some damaged fruit given them. On this they worked, though not so readily as on the honey. After they got fairly to work, the damaged fruits were removed and sound fruits brought forward. Within 20 minutes the bees had left in disgust. This test effectually put a stop to all further complaints of bees damaging sound fruit, in this vicinity, and if there are any who still believe that they do puncture grapes, they do not feel inclined to come forward and assert it openly.

But is there not a real damage done by the bees on grapes that have cracked owing to rains, by an excess of flow of juice within the tender skin? Could not these berries be saved by the grape-grower? Yes, they may be saved, if you pick them the same day. Otherwise they are worse than useless. Most of my readers have probably noticed, in the fall, around the

vines, or around the wine-press, millions of small brown gnats, the same as you find around cider or vinegar barrels. We call them "vinegar gnats." As soon as grapes are punctured or cracked, these gnats appear. They lay eggs upon the pulp, and within 24 or 48 hours the berry is full of little grubs just large enough to be seen with the eye. They hatch and reproduce so plentifully that in a few days they darken the air in the vicinity.

We are to-day making wine. The beams of our press-house, above the press and the wine vats, are literally black with these little gnats. Would it not be better if the bees could take up all this juice, when the berries are damaged, than to have a nuisance like these gnats hatched and reared at the expense of the grape-grower?

But suppose neither bees nor gnats worked upon the fruit after it is cracked, what then? Within 48 hours the juice, exposed to the air, has begun fermenting, the fermentation is first alcoholic, then acetic, and you have sweet grape-juice, wine, and vinegar all upon the same bunch. Tell me, what are you going to do with that kind of mixture? Had it not been better if the bees had taken all that threatened to spoil?

But here is another trouble, and the worst of all for the apiarist. These juices—grape-juice, apple-juice, etc.—are not capable of being changed to honey. If the bee harvests them in any quantity, so much the worse for her, for they will sour on her stomach during the long nights of winter. Better, far better for our bees, if we could keep them out of the wine-growers' domain. Happily, there is honey to be gathered usually, when the grapes ripen, and it is not more than one year out of ten that the bees may be seen upon the damaged grapes. But it is at least evident that the grape-grower and the bee-keeper are brothers, that their interests are identical, and it is to be regretted that they do not always see it in that light.

Hamilton, Ill.



Is it Bee-Paralysis?—Description of that Disease.

BY ADRIAN GETAZ.

On page 518, P. S. H. asks what is the cause of some dead brood, observed in some of his colonies.

I would like to know whether P. H. S.'s bees are affected with bee-paralysis or not. As the American Bee Journal readers know, the disease exists in my locality and in my apiaries; I have several times seen some brood thrown out of the hives for which I could not account, and I strongly suspect that it was caused by that disease. Similar cases have been reported several times and described almost exactly like the one reported by P. H. S. The most general and most extensive were observed in California some three or four years ago. As bee-paralysis was also present, some attributed it to that disease, others to starvation of the brood, and a few went as far as saying that both bee-paralysis and the observed dead brood were due to starvation, but no scientific investigation was made, so the matter remained unsettled.

Bee-paralysis is more apparent in the early spring than at any other time of the year. All, or nearly all, the bees of the affected colonies are almost completely hairless, and look as if they had been polished. They are also more or less stiff, and move as if they were partially paralyzed. If the colony is not too far gone, they succeed in rearing enough brood to take their place.

As the season advances, the comparatively healthy young bees become old enough and numerous enough to take the lead in the management of the colony, and eventually they throw out all the old, diseased bees. During the operation, the appearances are almost like a case of robbing. After that the colony seems to have recovered, or almost so. But sooner or later it reappears, but in a different way. The first symp-

oms are a peculiar twitching and twisting of the body and wings. As the diseased bees grow older, this twisting decreases and is replaced by an increasing stiffness, and finally by the hairless stage of the disease. During the honey season this last stage is rarely reached, partly on account of the natural causes which shorten the life of bees; partly because the decidedly sick bees are expelled by the comparatively healthy ones.

Toward the fall less young brood is reared to take the place of the old bees, and the disease increases, more hairless bees are seen, and, finally, after they have wintered over and lived some six months or more, they all have reached the hairless and last stage of the disease.

The above refers to what might be called moderate cases of the disease. In extreme cases hairless bees can be seen during the whole year; young bees only a few days old already show signs of the disease, and fail to expel the older ones. The whole colony appears listless and inactive, and sometimes hangs outside of the hive instead of working, just about like a colony ready to swarm.

In the above I spoke of bees comparatively healthy. The fact is, that bee-paralysis is a slow developing disease, and it is probable that a part of these young bees, if not all, are already affected, but not enough yet to show it. I am now fully satisfied that the disease is not only contagious, but also inherited from the queen, and I do not see any reason whatever why the brood should not contract the disease. If no brood, or but very little, dies, it is because the disease does not develop itself fast enough to kill them before they reach the winged state, at least in the majority of cases.

Some say that bees affected with bee-paralysis are swollen and show more or less the symptoms of dysentery. Others say that they are shriveled. Both are correct. In the spring, or after a few days of confinement, they look as if they had the dysentery, but when flying freely they do not. Those crawling on the ground after being expelled, always look shriveled, and eventually die of starvation.

Knoxville, Tenn.



Poisonous Mountain Laurel Honey in Mexico.

BY DR. W. M. STELL.

After reading the articles in the American Bee Journal about mountain laurel, I decided to make an experiment for my own satisfaction, and seeing a great many goats here eating the leaves of this plant, a thought struck me about its poisonous effects on goats' milk, for this is the recourse that we have for obtaining milk here, as the mountains are so high and broken that it is impossible to have cows.

Now, the great question: Is the honey poisonous that the bees gather from laurel? and is the milk poisonous from goats that feed on laurel?

After watching the goats nibbling so ravenously on this bush, I asked the herder if he did not know that this plant was poisonous. He said no, to the contrary, that they often drove the goats to them, and besides that it was a great medical plant—for nervous headache they would bruise a leaf and bind it to the temples; for all kinds of ulcerating sores they would treat likewise. I asked if he ever took any inwardly, and he said that he had, but it produced pain and vomiting, also stated that burros and mules would not eat it.

I, at once, gathered some flowers and leaves to perform an experiment upon the honey-bee, as the opinion seemed to differ very much in regard to the poisonous honey. In reading those articles I failed to see any direct experiment performed by the writers to prove that honey is or is not poisonous when gathered from mountain laurel, though some stated that the hills were covered with this plant, and they never

knew of any bad effects produced by eating honey when it was in full blossom, while others made the contrary statement.

The following is the result of my experiment: I bruised, in a wedgewood mortar, eight ounces each, leaves and fresh flowers, adding 20 ounces of water and 12 ounces of dilute alcohol to extract its virtue. This was gently boiled down to about 16 ounces, which had a strong, sweetish, repugnant taste. I then mixed one ounce of this decoction with 8 of dilute honey; this was given to the bees at 6 o'clock p.m., in a Simplicity feeder, which was placed between the frames in the brood-chamber.

I will state that this colony was especially prepared for the experiment, having one frame only with brood (no honey), and four perfectly empty ones; the hive was closed and bees confined for two days before the experiment, to allow sufficient time for them to digest all honey in their stomachs.

The next morning I provided myself with a glass graduated and a small suction dropper. I felt certain when opening the cover that I would find my little workers all dead in a pile, but to my great surprise, on lifting the enamel cloth to one side, they had their little heads sticking straight up, and eyes as bright as diamonds. On examining further, I found the feeder empty and almost dry—they had deposited this poisonous honey in the combs. With the dropper, I sucked out two ounces of this honey (from the cells in the comb), which was taken in their honey-sacs, from the feeder, just the same way as they do from the natural flowers; of course the distance was very short, but the honey, without a doubt, underwent the same slight physiological change while there, and we do not know how rapid this change may be. Now, this was the first honey that they had for three days, and I tell you they seemed to enjoy it hugely.

Now, after seeing no bad effects on the bees, my next, to complete this experiment was on the human, so I told my assistant, who is a Mexican boy of 14 summers, that we would swallow this newly-gathered honey between us; I was obliged to swallow first, taking only one-half of an ounce, the boy swallowed the remaining $1\frac{1}{2}$ ounces. This honey had a splendid flavor, only leaving a slight astringent-like taste in the palate.

Now for the direct physiological effect on man and boy. About one-half hour after swallowing this honey I suddenly became giddy, and a slight loss of sight; felt as if being whirled around. I immediately introduced my finger as far down the throat as possible, and vomited "sweet laurels" up, which relieved me instantly. The dose with the boy stayed with him all right for one hour.

I will state right here, dear reader, the Almighty being my helper, I will never try another experiment on any human again, and advise you all to do likewise. Just listen to these honey symptoms:

The boy fell with a violent convulsion, hard, contracted stomach, cold hands and feet, profuse perspiration, mouth tightly closed, eyes opened and rolled back, pupils dilated, face flushed, twitching of lower limbs, and great difficulty of breathing, pulse full, only 50 per minute, but strong. Being more than satisfied, and greatly alarmed with these symptoms, 2 one-tenth grains of apomorphia were administered hypodermically, in the left biceps, which promptly produced an emetic effect that relaxed all muscular contraction. After a good vomit, he sat up, complaining of pain in the stomach and back of neck. Two ounces of castor-oil were administered, which operated in about two hours, bringing away a great deal of honey in the vomits also. The boy was quite broken up and unwell for a week, but is now bright as a dollar, as though nothing ever happened.

I hope, after this little experiment, those who are skeptic on laurel honey being poisonous, will only try a small bit on themselves, and know, personally, how it feels. I will assure

you that a little of the above symptoms will convince and put you straight. Some may say, why does it not produce such effects on the bee? Well, this I do not know, nor does any one else. It is true that when the nectar is gathered from flowers, it undergoes a slight, peculiar physiological change, that strains, refines and reduces the amount of acid, to prevent fermentation and conserves preservation, but does not alter its natural constituents; if it did, all honey would look and taste alike; there would be no necessity of grading our honey for the market. By this peculiarity of over-deposit of alkaleid in each flower enables us to distinguish its class when eating, and when this process is taking place it is just as natural for the bee as for the nurse-girl to let a good bit slip down when chewing for the baby; it is the same honey, only prepared and purified for us. Bees cannot carry honey from the field in buckets or bottles; Nature has provided each one with a little sac for this purpose. I do not believe that Nature intended that any material changes should take place while there; most assuredly the honey is slightly acted on by the secretions of the compound racemose glands of the head and thorax, to aid digestion and regurgitation.

The milk from goats feeding on laurel bushes contains no poison whatever, as I could discover; it may be because they only eat very little, and far apart.

My bees never visit the laurel blossoms; they crown themselves with something better.

There are two kinds of laurel, one being considered more poisonous than the other—mountain laurel (*Kalmia latifolia*) and cherry laurel (*Lauro cerasifolia*); the two are similar in size of growth, shape and color of leaves, also are evergreen. Mountain laurel has a cluster of bright pink flowers, while the flowers of cherry laurel are white; both are wild Spanish plants, and contain great abundance of hydrocyanic acid (prussic acid), which is a deadly poison, but often used in pharmacy, diluted. The leaves of cherry laurel are extensively used in Mexican cooking, and commonly sold on the streets with other aromatic herbs.

I believe it is the honest duty of all bee-keepers to be more studious about the poisonous plants, and ascertain from which source the bees gather the honey. Jasmine, digitalis, oleander, nightshade, etc., are all dangerous and poisonous garden plants, which should be substituted by others more profitable and as beautiful. I hardly think bees will visit such poisonous plants unless compelled to do so by absence of all others, and during a sudden check in the honey-flow.—
Southland Queen. Jesus Maria, Mexico.



Lady-Bird Beetles as Related to Bee-Culture.

BY PROF. A. J. COOK.

The subject, Coccinellidæ or Lady-bird beetles might seem a strange one for an article in a bee-paper, but I am sure any criticism is uncalled for. The intrinsic interest of the subject would warrant its appearance. The wonderful results wrought out by these little friends would also urge the penning of the article. The further fact that these little beetles often destroy entirely the worst enemies of our bee-plants, and those often the very best, is further justification, were such needed, for the appearance of this article in the American Bee Journal.

The Coccinellids, like the bees, belong to the class of insects, or hexapods, that is, they have distinct head, thorax and abdomen, have six legs, antennæ, the horn-like organ appended to the head, and always have compound eyes in the mature state. They do not, however, belong to the same order, Hymenoptera, which contains the bees, have four membranous wings, biting mouth parts and complete transformations. The lady-bird beetles and all beetles belong to the order Coleoptera. These also have biting mouth parts and complete transformation, but in all beetles the first or

primary wings are thickened and are called Elytra. This gives the name Coleoptera—which means sheathed-wings, and refers to the fact that the upper wings sheath the lower or functionally perfect wings. The word Hymenoptera means membranous wings, and this, too, is a good name, for we know that all four wings of the bee are membranous.

These lady-birds should be called beetles, not bugs. Bugs are quite different. They do not go through complete transformations. The young or larval bug looks very like the mature bug, but has no wings. No person who closely observes them would fail to detect that they were closely related, if not the same insect of different age. On the other hand, no one would think of a larval bee as the baby of its parent unless they had learned such to be the fact.

The lady bird beetles belong to the family Coccinellidæ. These lady-birds are generally pets. Many who look with abhorrence on most beetles, fondle the little lady-birds with much of gratification and pleasure. These little beetles are very short, often as broad as long, and the outline is usually almost circular. Occasionally, however, we find them somewhat elongated, reminding us of the leaf-beetles to which family belongs the celebrated potato-beetle and the little striped melon-beetles. It is very easy, however, to tell the lady-bird beetles from the leaf-beetles, as they have very short and knobbed antennæ, while the antennæ of the leaf-beetle are long and cylindrical. The number of joints of the tarsi, the last division of the legs, are only three, while in the leaf-beetle, there are always four joints to the tarsi. The tarsi are the portions of the foot which rest on the ground as the insect walks.

With very few exceptions the lady-bird beetles are our good friends. They belong to the great group of beneficial insects known as predaceous. That is to say, they feed upon other insects and eat them up, just as the cat eats the mouse. It is probable that all over the world these lady-bird beetles do immense good. They destroy hosts of injurious insects which otherwise would "eat every good thing from off the face of the whole earth." But in arid regions, such as Southern California, where the scale or bark lice thrive so remarkably these lady-birds become more than ever our friends and abettors. From the limited observation which I have had in Southern California, I think we can hardly over-estimate the real value of these lady-bird beetles.

The so-called twice-stabbed lady-bird (*Chilocorus bivulnerus*) is very common in California, as it is also in the East, and does untold good. In the East, a few years ago, the linden trees were seriously attacked by the linden scale (*Leucanium tillæ*), and there seemed no escape. While the Chalcid flies probably did the most to extirpate this enemy of one of our best bee-plants, it is certainly true that these lady-bird beetles played no inconsiderable part in the glad riddance. This twice-stabbed lady-bird is very common in Southern California, and feeds very largely upon the black scale, which is one of the most harmful of our insect pests. Thus we can hardly praise too highly the work of these little lady-birds among us.

A few years ago the white scale, also called the cottony-cushion scale, fluted scale, and, scientifically, *Icerya purchasi*, was so common in Southern California, and so appallingly destructive to the citrus trees, that it began to look as if the orange and lemon orchards would be entirely destroyed in this section of our State. What made the case all the more discouraging, these cottony-cushion scales were not confined to the citrus trees, but went on to almost all of our vegetation, making it almost impossible to destroy them by artificial means. As there are two and possibly three broods a year, their prolificness is something astounding. No wonder the fruit-growers of Southern California were in despair.

During the time of the Melbourne Exposition, through the

influence of enterprising fruit-growers of California, a little red and black lady-bird, *Novius (Nedalia) cardinalis* was imported from Australia. This little beetle seems quite insignificant. It is hardly larger than the head of a good-sized pin, and yet it has been mighty in its good work. Hardly two years had elapsed after its introduction into the orchards of California before the white scale was almost entirely banished from the fruit-groves. Now this scale is so rare that the later orchardists do not know what it is, and scarcely a week goes by that I do not receive specimens from some orchardist, wishing to know what it is, and whether it is likely to become a dangerous foe.

There is another very gratifying fact easily observed in our orchards. "Where the carrion is, there the eagles are gathered together;" so where this fluted scale is, there we will always find these little lady-birds. They are quick of scent, and are sure to find out the scale upon which they greedily banquet. Many a time the past year I have received these scales in a box sent me for identification, and upon opening the cage I have found one, two or more of these little Australian lady-birds. They are here evidently to stay, and because of their presence, the old cottony-cushion scale finds its lot a hard one. This case is not only very interesting, but it gives a hint as to very practical operations in our warfare with our insect foes. For does it not stand to reason that there are more *Novii* in the world, and that without doubt we may by importing insects from other countries do most to banish some of our worst insect foes? I believe this field in entomology which has hardly yet been cultivated at all, is very big with promise.

Another insect which has also been brought from Australia is the little black lady-bird, *Rhizobius ventralis*. In limited localities this little beetle has done as much to destroy the black scale as has the other to wipe out the cottony-cushion scale. For some reason we do not seem to succeed so well in introducing this insect into new localities in California, as we did in spreading the *Novius*. Why this is we can hardly say. It is very likely owing to peculiar enemies. It may be that this insect is harder to acclimate, and thus more time will be needed in its introduction. It is to be regretted that our fruit-growers are so impatient. They can hardly wait for this new friend to put in its valuable work. Of course we cannot surely state that this insect will ever become general and such a benefactor as was the *Novius*, but I think we have great reason to hope, and I believe the chances are in favor of its becoming one of our most valuable aids in dealing with the black scale.

Last week, while in attendance at a farmers' institute at Santa Monica, a gentleman brought into the room a small twig of lemon to inquire of me what scale was working upon it. It proved to be the common black scale, although the form and color of the scale was considerably modified from the type. To my great gratification no less than surprise, I found three larvæ of *Rhizobius ventralis*. Thus this little friend is spreading among us, and I believe there is great hope that we may wake up some morning and find that it has captured the black scale, and is holding the fort against this terrible pest of Southern California. If it is true that this insect finds it difficult to endure the dry, hot air away from the ocean, it is more than probable that it will gradually spread from the ocean, and adapt itself to the dry, hot atmosphere farther inland.

There are other lady-birds, some native, and others introduced from Australia, which are also helping us grandly in our fight against the insect foes of our orchards. Some of the more common red and spotted lady-birds are great foes to the Aphides or plant-lice, and last year when the plant-lice were so very common and abundant, these red lady-birds could often be gathered by the pint. No one can over-estimate the

value of these and others of this family in this good work of combating our injurious insects.

The county of San Bernardino, Calif., is doing a work that may well receive the gratitude of all Southern California. The people of that county have gone systematically at work to give the introduction of the *Rhizobius ventralis* a fair trial. Twice each month hundreds of the beetles are introduced into two separate orchards. This will give them a fair chance, and we shall soon know of a certainty whether they can be made at once a success or not. In either case, the result will be of great importance to the rest of the State. But in case this experiment is a failure, I shall still believe that we shall yet receive much benefit from this new comer as it adapts itself to its new environment. Every apiarist and farmer should study these lady-birds, that they may know assuredly of the appearance and habits of these valuable insects.

Claremont, Calif.

Questions AND Answers

CONDUCTED BY

DR. C. C. MILLER, MARENGO, ILL.

[Questions may be mailed to the Bee Journal, or to Dr. Miller direct.]

Bald or Bare Headed Brood.

1. What causes bald-headed brood?
2. Did you ever know any bad effects from it?
3. Do you know any cure for it?
4. Did you ever hear of foul brood originating from bald brood?

ANSWERS.—1. By bald-headed brood I suppose is meant brood that is old enough to be sealed yet is left unsealed. No one seems to know just what causes it, and I am not sure that I ever saw any guess at it except my own guess that wax-worms had something to do with it. You will generally find that these unsealed cells are more or less in clusters, or rather in rows, just as you might expect to find them if a worm had spun its gallery through the eappings.

2. No, the young bees seem to come out all right.

3. If worms are at the bottom of the trouble, then strong colonies and Italian bees ought to act as a preventive.

4. No, and I don't think you need have the least fear of it. Don't worry a minute about bare-headed bees.—[It may be that this is really "pickled brood," as mentioned by Dr. Howard, and by Mr. Stahmann on page 612.—Ed.]

Exhibiting Bees, Etc., at Fairs—Feeding for Winter Stores.

I will let you know something about our County Fair, or rather of my success. I received your answer on page 550, in time. I exhibited three rousing colonies. I had frames in glass, such as a few sections that I scraped up, with brood and queen, and protected queen-cells. Also a frame with six cells on a strip worked as per Doolittle's "Scientific Queen-Rearing." I opened the hives to show my way of handling the bees. I also took your plan to show the way of extracting, or what extracted honey is, with water, on account of robbing. I learned that there were bees kept within $\frac{1}{2}$ mile of the Fair ground. This was most certainly interesting to many who were there. I know only of one person that got a sting, or that had to swear about my bees. He sold sweet drinks, and tried to drive the bees away from it. I pointed to the old-fashioned bee-keeper's home, and kindly told him that we couldn't blame my bees alone. There had been 88 race-horses there and many others, and the above was the only complaint.

Mr. H. H. Snavely, proprietor of the Warwick House, was well pleased with my exhibit. There was no premium offered on bees or honey, but he paid or gave me \$10, free exhibit, three complimentary tickets, board for us the whole week at his public house free; also 50 pounds of granulated sugar to feed the three colonies to help safe wintering, so that I can bring them again next year. This was a great thing for the Lancaster city and town newspapers to publish. I also had a photograph there, showing where the bees' home is, the yard where the bee-hives are in view, also the old house-apiary, and all my other buildings; a large portion of the meadow and field, also the south side of the South Mountains of Lancaster county. Quite a portion is in view, and all in one picture. This also took the attention of many of the Fair public.

1. What do you think of my success?

2. Will you please tell what other counties in any State pay to bee-keepers for exhibiting bees, or must the bee-keeper pay? I got more than I would have asked for. I think I can now afford to renew my subscription to the Bee Journal. What do you think, Mr. Editor?

3. When I weigh my 10 pounds of sugar, also 10 pounds of water, and feed this early in September to one colony of bees, can I take it for granted that the colony has now 20 pounds of stores for winter? I mean cold water and sugar.

Brickerville, Pa.

E. B. K.

ANSWERS.—1. I congratulate you heartily on your success. It shows what may be done with the right kind of push, and no stronger proof is needed that your efforts were appreciated than the fact that you got no inconsiderable material reward where no reward had been offered at all. Even if you had received nothing of the kind, I feel pretty sure that you were well paid by the interest that you found awakened in others, and the pleasure they took in your exhibit.

2. The only way to find out about what is done in other counties is by consulting their premium lists. Very likely nothing will be found in many of them that in any way relates to bees, while in others a premium of 50 cents may be offered for honey. A few such exhibitions as you gave would stir up the managers of the Fairs so that they would hold out some inducement worth paying attention to. Yes, you can well afford to take a good bee-paper just so long as you keep a single colony of bees, and perhaps the editor wouldn't object if you send a good part of that \$10 as advance subscription. Neither would it greatly distress him if he should learn that at the Fair you secured some new subscribers for the "Old Reliable."

3. No, 10 pounds of sugar and 10 pounds of water will not make 20 pounds of stores for winter, any more than 20 pounds of nectar fresh from the flowers will make 20 pounds of winter stores. You can figure that about 6 pounds of the water will be thrown out of the hive, mostly in the form of vapor, leaving 14 pounds for winter stores. No matter how much water there may be, you can count at the rate of about 5 pounds of sugar for every pound of stores.

Milkweed Pollen on Bees' Feet—Pure-Blooded Bees.

1. I send two bees. You will notice on the feet a foreign growth. What is it, and what is the remedy, if any? It is only in one hive, and they are the yellowest bees I have. Only a few are afflicted like these.

2. Are there two full 5-banded Italians? I notice that some of my drones are black, and others have very little yellow on them, while some queens produce full yellow nearly to the tip.

3. What color would a pure drone be? Also, what is the test of pure Italian bees?

T. J. B.

ANSWERS.—1. The bees have been working on milkweed and the pollen-masses are clinging to their feet. There is no remedy unless you destroy all the milkweed in your neighborhood, but very likely the bees gather enough from the milkweed to pay for all the bees that are lost through getting their feet loaded.

2. You can always count easily the number of yellow bands on a worker if you get it to fill itself with honey and

let it fly on the window. Be sure not to miss counting the first band, the one toward the head, for that is not so broad as the others. But in the usual acceptation of the term you can hardly decide by seeing any one worker whether it is a "pure" 3-banded or 4-banded bee. For in a colony of hybrids you may find many 3-banded bees, but you cannot say any one of them is a pure Italian or 3-banded bee, for to be pure it is required that not only part but all the worker progeny must come up to the mark.

3. Drones vary very much in appearance, and there is no marking of the drones that would be taken as a test of pure Italians. The workers are the ones to go by, the test of pure Italians being the three yellow bands on all the workers. Of course there may be an occasional black or hybrid bee in a colony of pure Italians, for strange bees sometimes get into a hive and become adopted as members of the family, but the progeny of the queen must all show the three yellow bands.

Hives Put on Single Posts.

Is there any objection to putting a hive up from the ground on a single post. I wish to have them put up on a frame on a single post in the center, so I may keep the grass cut short under and around the hive. If there is any objection to this plan I would be pleased to know it.

W. F. W.

ANSWER.—One objection is that if a swarm should issue with a clipped queen, or a queen that for any reason could not fly, she would not be so likely to get back into the hive. Another is that heavily laden bees dropping on the ground on their return from the fields could not crawl into the hive. This difficulty would be chiefly obviated by having the alighting-board project well in front. Another objection is the difficulty of having the support sufficiently firm. The 3 by 4 post that you propose to use would have to be buried pretty deep, and there might be some danger of its rotting off and some day letting the hive topple over. Aside from the objections mentioned, I know of no reason why bees might not do well with their hive placed solidly on a single post.

Two Swarms Together—Superseding—Comb-Building, Etc.

1. I had two strong swarms of bees on June 23, one at 12 o'clock and the other at 12:30 p.m.; both settled in one cluster. I hived them in one hive on one of the old stands, and gave them two supers. What became of one queen I do not know. The other went right into the supers to do her work. I gave them narrow starters in the brood-nest. The last queen was superseded four or five days after, so the queen-cells proved in the lower story. They built almost all drone or honey comb. What or how could I have done to separate these swarms?

2. What made the queen go up into the super?

3. What made the bees supersede their queen, as she was one year old?

4. What made them build all drone-comb in their brood-chamber?

5. Is there any difference between drone and honey comb?

6. I gave one of my observatory hives a virgin queen 12 days old on Aug. 2, which was accepted all right. She commenced to lay on Aug. 8, and it takes her 3 to 4½ minutes to lay one egg. Will the queen be any better later? If not, then this will be a strong argument against rearing queens late in the fall or early in the spring, when they sometimes cannot get out to mate (on account of bad weather) at the right age?

7. What makes bees pick at each other around their wings, as if they would find something? A. B.
Seattle, Wash.

ANSWERS.—1. You might have hunted out the two queens and given part of the bees to each. After hiving the swarm, if you had looked you would perhaps have found one or both queens balled. Another, and an easier way I have seen rec-

ommended, is to put the united swarm into a two-story hive with combs in each story, allowing the bees to separate into two parts, each one with its own queen. But I know nothing about this last plan from actual experience.

2. When a swarm is first hived the natural tendency seems to be upward, and if there is free access to the super the queen is just as likely to go there as to stop in the brood-chamber unless there is some inducement to stay below. With only narrow starters in the brood-chamber, it may have seemed to the queen just as good a place to commence house-keeping in the super. If a queen-excluder had been used, then the queen could not have gone into the super. Or if the super had been left off till the queen had commenced laying below, there would have been no trouble. Or if a frame of brood, or even a frame of empty comb had been in the brood-chamber, the queen would hardly have gone above.

3. Many a queen is superseded before she is a year old, and it isn't always easy to tell why. In the present case the queen may not have been in entire favor with the bees that were strange to her at the time of swarming, and their dislike may have continued and resulted in their killing her. Or she may have been roughly handled and somewhat injured, in which case she would prepare for supersedure the same as a queen incapacitated from old age.

4. The comb in the brood-chamber may not have been built till after the death of the queen, and a strong colony of queenless bees are not likely to build worker-comb. Even with the queen in the super, the comb built below might have been considered for storage only, and when bees store rapidly the surplus comb built is generally drone-comb, perhaps because a given amount of wax will contain more honey if drone-comb than if worker-comb. So it's a saving of time to build drone-comb, and such busy creatures as bees like to save both time and wax.

5. All comb built by the bees goes under the name of honey-comb. In the Bible the word means the comb and the honey contained in it, and perhaps this use prevails in England, but in this country, according to present usage, only the wax structure is meant. Cells will be found in honey-comb measuring five to the inch, and these are worker cells, while drone-cells measure four to the inch. In changing from drone to worker cells a few irregular cells are built called "transition cells." All of these are used for storing honey as need requires, but there are no cells called honey-cells meant for storing honey alone, and in the sense in which I think your question is meant, there is no difference between drone and honey comb.

6. A queen that doesn't commence laying till she is 18 days old will probably not prove to be a very good queen, providing conditions are favorable. If it takes her 3 to 4½ minutes to lay an egg when she first commences, that's nothing strange, but if she keeps that up afterward at a time when queens in general are doing good work, I wouldn't give much for her. But if she turns out poor, that hardly proves anything for or against late-reared queens. In any case a single example doesn't prove much, and although as a rule a queen that is long in commencing to lay turns out poor, if the delay in laying is caused by bad weather or by the season of the year, it is still possible that she may turn out well. I know nothing about the matter from my own experience, but some claim that excellent queens are reared in the fall that do not commence to lay till spring. I have had some experience with queens reared early in the spring, and they are not always good. On the whole, I'd rather have queens that are reared about the time of swarming, or at least when bees are busy in the field.

7. When a strange bee gets into a hive, the bees pick at it and tease it in the way you mention. A diseased bee that belongs to the colony is treated in the same way.

PERSONAL MENTION.

MR. G. M. WHITFORD, of Arlington, Nebr., is the editor of the "Bee-Department" in The Cultivator—a farm paper published at Omaha.

THE A. I. ROOT Co. report that they have just put up another large building at the "Home of the Honey-Bees." It is 52x120 feet in size, and will hold 600,000 feet of lumber for sections. It is the largest of all their numerous buildings, some of the others being 40x120 feet.

MR. M. M. BALDRIDGE, of Kane county, Ill., called on us last week. He is one of the oldest readers and correspondents of the Bee Journal, having written for it from the very first, in 1861. He reports that had it not been for the sweet clover, bee-keepers in his part of the country would have had no surplus honey the past few years.

MR. GEO. W. BRODBECK, in Gleanings for Sept. 15, suggests that when the North American and the Union are amalgamated, there be two classes of members—protective and non-protective. We agree with Editor Root that all members should be protected. We should want all on an equal footing, and all to pay the same membership fee, and assessments, if any.

REV. JAMES M. SMITH, of Santa Maria, Calif., shows a very generous and unselfish spirit in the following, which accompanied a request that a sample copy be mailed to a friend of his, whom he hopes to succeed in inducing to become a subscriber:

"I am surprised how great a help the American Bee Journal is, and want others to learn its worth and get its help."

MR. JAMES LAIDLAW, of Canada, having failed to receive a copy of the Bee Journal one week, wrote for it and said:

"I would not be without the 'Old Reliable' on any account. I have learned more from it than I could have learned in a lifetime without it."

By the way, should a subscriber fail to get the Bee Journal any week, kindly let us know promptly, and we will be glad to mail you another copy.

DR. E. GALLUP, of Santa Ana, Calif., has sent us numerous and interesting copies of pamphlets, magazines, etc., extolling the natural beauties of scenery and climate of that Pacific wonderland. If he doesn't stop, we fear he will be the cause of a hopeless case of "California fever." We want to thank him for all the literature he has sent us, and if the "fever" gets high enough he may have another neighbor some day.

We have a long article from the busy Doctor, telling something of his bee-keeping experience of the present year. It is in answer to a number of inquiries, and we hope to publish it next week.

DR. MASON, in an article in Gleanings, says that previous to 1893 the National Bee-Keepers' Union "was known as the North American Bee-Keepers' Union." That is news to us. We think if the good Doctor will look up the matter, he will find that it has always been the "National Bee-Keepers' Union"—that it is national in name and international in its membership and object.

The Union has done a noble work in the interest of bee-keepers, and it must not be impaired in any way. We believe it would be greatly strengthened if it were reorganized in such a way as to take in the North American. There really is no need of two such societies, we think.

MESSRS. R. A. BURNETT & Co. are probably the oldest honey-dealers in Chicago. They are a firm who understand their business thoroughly, and are square in their dealings. Upon receipt of the Bee Journal for Sept. 17, they immediately wrote us as follows:

MR. YORK:—The Bee Journal of this date at hand. It seems to us that it is one of the issues that must be of great benefit to the trade and pursuit you especially promote. Your warning under the head of "Editorial Comments" should be sufficient to protect all those seeking to market honey in Chicago. By that offer you are placing at your subscribers'

disposal the information, for cost of postage, that may save them individually many dollars, and to the producers as a whole, thousands of dollars. The unprincipled dealer hurts all, by depressing the market to realize immediately upon receipt of honey.

Yours very truly,
R. A. BURNETT & Co.

We aim constantly to make the Bee Journal of real value to its subscribers, in every possible way, and we believe they appreciate it. Many are showing their approval by sending in new subscribers, as well as by paying their own subscriptions promptly. We trust that during the next few months there may be a genuine boom in the line of renewals and new subscriptions, as we are anxious to attain unto our ideal of a bee-paper, but cannot do so unless we have the hearty co-operation of the bee-keeping fraternity.

There is no reason why this journal should not be just twice as valuable to its readers as it is now. We can make it so when all who should receive its weekly visits are found upon our subscription list.

If your neighbor bee-keeper does not take the Bee Journal now, invite him to begin at once, and thus get in touch with the rest of the bee-world. You will be doing him a kindness as well as us, and will thus help to spread the information that every bee-keeper should have.

MR. WALTER C. LYMAN is a bee-keeper with about 60 colonies, at Downer's Grove, Ill., 21 miles west of Chicago. He had kindly invited "ye editor" and wife to spend a day with them, and we selected Saturday, Sept. 19. Although a bright day, it was more comfortable in doors than out. The honey season has been a poor one this year with Mr. Lyman. He has taken off not over 250 pounds of comb honey.

Mr. L., his sister, and mother (who is 75 years old) form the family. Yes, and Miss Dixon, who so acceptably presides over the kitchen department, must be included. Though somewhere around 40 years, Mr. Lyman is still single. But he seems not to worry about it any. Yet, unless he soon overcomes his extreme bashfulness, we fear he will some day be an old bachelor!

Mrs. Lyman is a remarkably preserved woman. She is as bright and vivacious as a girl in her "teens." It is a real inspiration to meet and talk with her. We never saw any one of her age that had kept so young-hearted.

We had a pleasant day a-visiting, and returned home in the evening rested and cheered.

A New Binder for holding a year's numbers of the American Bee Journal, we propose to mail, postpaid, to every subscriber who sends us 20 cents. It is called "The Wood Binder," is patented, and is an entirely new and very simple arrangement. Full printed directions accompany each Binder. Every reader should get it, and preserve the copies of the Bee Journal as fast as they are received. They are invaluable for reference, and at the low price of the Binder you can afford to get it yearly.

Honey as Food and Medicine.—A new and revised edition of this 32-page pamphlet is now issued. It has 5 blank pages on which to write or paste recipes taken from other sources. It is just what its name indicates, and should be liberally distributed among the people everywhere to create a demand for honey. It contains a number of recipes on the use of honey as food and as medicine, besides much other interesting and valuable information. Prices, postpaid, are: Single copy, 5 cts.; 10 copies 30 cts.; 50 for \$1.00; 100 for \$1.75. Better give them a trial. Send all orders to the Bee Journal office.

The Alsike Clover Leaflet consists of 2 pages, with illustrations, showing the value of Alsike clover, and telling how to grow it. This Leaflet is just the thing to hand to every farmer in your neighborhood. Send to the Bee Journal office for a quantity of them, and see that they are distributed where they will do the most good. Prices, postpaid, are as follows: 50 for 25 cents; 100 for 40 cents; or 200 for 70 cents.

The Names and Addresses of all your bee-friends, who are not now taking the Bee Journal, are wanted at this office. Send them in, please, when sample copies will be mailed to them. Then you can secure their subscriptions, and earn some of the premiums we have offered. The next few months will be just the time to easily get new subscribers. Try it earnestly, at least.

OLDEST BEE PAPER
-IN AMERICA- ESTABLISHED
IN 1861

THE AMERICAN BEE JOURNAL

GEORGE W. YORK, Editor.

PUBLISHED WEEKLY BY

GEORGE W. YORK & COMPANY,

118 Michigan St., CHICAGO, ILL.

\$1.00 a Year—Sample Copy Sent Free.

[Entered at the Post-Office at Chicago as Second-Class Mail-Matter.]

Vol. XXXVI. CHICAGO, ILL., OCT. 1, 1896. No. 40.

EDITORIAL COMMENTS.

The Lincoln Convention Next Week.—

Yes, just one week yet, and then the long-looked-for and much-talked-about North American convention of 1896 will be in session. As the time draws near, we often begin to wonder whom we shall see there—what new faces? We always are sure to meet and greet some whose faces we have never seen, but whose names are very familiar. We presume there will be a large attendance from the State of Nebraska. We hope there will be, for we want to see as many as possible of those hospitable people of the West. You know if the convention next week is not a big success, it won't be the fault of the Nebraska folks. They have been planning for a wonderful time.

We shouldn't be surprised if, when it's all over, we'll be glad that Lincoln was chosen instead of St. Paul or Minneapolis. At any rate, we are expecting a splendid time.

Look Out for the Honey-Sharks.—

Gleanings gives some timely warning in these words:

Don't, *don't* ship honey to strangers, even if they do write plausible letters and give bank references. A syndicate of sharks this year are quoting honey at high prices, and wanting to purchase outright. Their scheme is to get the producer to make a *bona-fide* sale, and then the bee-keeper will wait and never get his pay, because these swindlers are execution-proof; in other words, not collectable. When honey is sent on commission, the commission-man is liable if he does not make some sort of returns.

We think that the reading bee-keepers will not easily be caught this year by strange firms quoting high prices for honey. Surely they have had ample warning.

Sweet Clover and the Farmer.—

In the Country Gentleman of recent date, the following was published concerning sweet clover and its value to the farmer:

It first grew on our land (Scobarie, N. Y.) in spots, as the seed was washed on from the creek overflowing the land; then as it grew up, and the land was plowed for corn, it was plainly seen that the corn would be much better than where there was none growing. I considered it then advisable to gather some of the seed, as it grew wild, and seed it upon part of a piece of rye in the spring, as you would with ordinary clover.

The result was, in the fall after the rye was off the ground there was a very rich growth of about two feet high, a solid mat of it that it was almost impossible for a man to walk through. In the spring it was left to grow about up to the horses' knees, and in due time for corn-planting, and then was turned under by having a sharp share on the plow to cut the roots well, and a chain attached to the plow to drag under completely the green growth. It was perfectly subdued, and the corn on that four acres of a 12-acre lot was much heavier, and a better, healthier color than on the remaining ground

where red clover was seeded, and there was only about six inches growth to turn under.

I would advise all farmers, in preparing ground for a good corn crop, to seed their ground with this clover, either with winter grain or spring grain. It will yield much better corn crops, and will enrich their ground more and more each year. There is no danger of the seed lying in the ground and coming up another year, and it quickly dies after turning under. I think it is worth five times the quantity of common clover turned under. It also acts as a subsoiler, as the roots will root deep, and loosen the subsoil. I will gather a good quantity of the seed this year to use for another season. It is the cheapest manure that can be used, and is equal to many more loads of manure to the acre than any farmer puts on his land. The seed should be hulled and cleaned the same as other clover seed is prepared. For hay for cattle it is good cut early before it gets stalky, and two and three crops can be cut from it in that state, and then it dies off.

How does the foregoing compare with the laws in some States that class sweet clover as a "noxious weed?" It proves pretty clearly that certain law makers were led astray—which probably was not the first time.

We understand that a Wisconsin bee-keeper, who has a pasture field of sweet clover, has lately been ordered by the Weed Warden to plow it under, as that is one of the States where it is called a noxious weed by the law. Now, we'd like to see the Bee-Keepers' Union stand back of that bee-keeper, and make a test case of it. It can very easily be proven that sweet clover is not a "noxious weed," as thousands outside of States legislatures know.

"Sweet Clover Flowers are said to act like camphor when packed with clothing to preserve it from moths." So says the St. Louis Globe-Democrat.

The Honey Season for 1896.—

Editor Root in Gleanings for Sept. 15, gives a revised report of the honey season of the United States this year. On page 597 we gave his estimate (following the reports on the honey markets by commission-men), made up from the few reports that had come in up to that time. Mr. Root says:

Now that all the reports are in, it appears that the season was a little better than the partial report of our last issue made it—particularly for some States. It appears that the discouraging reports came first, and the more favorable ones later.

Taking the States in order, it would seem from the latest advices that the season has generally been good for Florida; same for Georgia. In our last issue Illinois seemed to be generally a failure, with the exception of Dr. Miller's locality. Later advices confirm it. As in our last issue, so in this, Indiana reports a general failure. Iowa comes out in marked contrast. With one exception, all the respondents for that State report the season "good;" "very good;" best known in years," etc. Only one respondent answers for Kentucky, and he calls the season there poor. The States in their alphabetical order between Iowa and Michigan are the same as reported in our previous issue. Michigan, generally reported as having a poor season in our last issue, is now reported as having anywhere from good to a fair season.

The year has generally been good in Missouri; indeed, one man says it is the best they have had in seven years. Only two respondents answer for Nebraska, and they both report good seasons. One answers from North Dakota, calling it fair. In our last number, New York was reported as having had an indifferent season; for this issue it is reported from good to fair. What was true of New York was also true of Ohio. Pennsylvania, according to our last issue, had a poor season. A larger number answer for that State now, and all report, with one exception, poor and very poor. Tennessee is the same as the last issue reported; so also are Vermont and Virginia. Utah is represented by two respondents, who call the season very good. Wisconsin, not reported at all in our last issue, is reported from fair to good.

All scattered reports that come in regarding the honey crop must ever be quite unsatisfactory. Just because one bee-keeper has a good yield, is no reason for thinking that all the bee-keepers in his locality fared equally well, for just as

likely as not the others had no surplus crop at all. The fact is, it is an extremely difficult matter to secure a just estimate of the honey crop of any year. Of course, Gleanings is to be commended for making the attempt, but the few reports received out of the thousands who keep bees, cannot serve as a reliable criterion, whether they be favorable or unfavorable, or both.

But we can rest assured of one fact, and that is, there is no danger yet of an over-production of pure honey by the bees. The only things just now that need worry the honest producer are the adulterators of honey and the dishonest honey commission-men.

Farmers' Institutes.—The International Association of Farmers' Institute Workers will hold its second meeting at the Sherman House, Chicago, beginning Oct. 14, at 10:30 a.m., continuing two days. Most of the prominent institute promoters in the United States and Canada are expected to be present and take part in discussing the various phases of the work. You are urged to attend and have some well digested experience or outline of some successful method, ready for presentation. The regular program will be supplemented by brief talks and discussions, which will give an opportunity for asking and answering questions.

The following general topics will be treated: "Developing New Workers," "Desirability and Methods of Securing Exhibits," "Irrigation Topics as Applied to Institutes," "Giving Instruction by Use of Models," "How to Broaden Institute Work," "Causes of Failure and How to Overcome Them," "Woman's Work in Institutes," "Closing Discussions and Killing Off Bores," "Special Obstacles to Institutes in the South," "How to Keep Up Interest."

The discussion of these subjects will be opened with addresses or papers by K. L. Butterfield, of Michigan; W. C. Latta, of Indiana; Jno. Hamilton, of Florida; G. A. Smith, of New York; B. W. McKeen, of Maine; C. C. Gregg, of Minnesota; Geo. McKerrow, of Wisconsin; Mary A. Mayo, of Michigan; Chas. F. Fox, of Idaho; W. S. Devel, of Arizona; E. J. Vickson, of California; R. E. A. Leach, of Canada; W. W. Miller, of Ohio; O. Clute, of Florida, and others.

Mr. F. W. Taylor, of Lincoln, Nebr., is the Secretary, to whom application for further information can be made if desired.

Another Constitution.—About two months ago we were invited to submit a new constitution for the North American, for the consideration of the Committee on Amalgamation that was appointed at the Toronto meeting last year. We complied with the request, sending in the following, which provides for a representative organization, and which, we believe, would serve as a starter upon which both the Union and the North American could unite without in the least interfering with the effectiveness of the Union:

ARTICLE I.—NAME.

This organization shall be known as the "United States Bee-Keepers' Association."

ARTICLE II.—OBJECT.

Its object shall be: 1st. The protection of the interests of its members. 2nd. The defense of their lawful rights. 3rd. The formation of a common bond of union among the apian fraternity of the United States. 4th. The dissemination of correct information concerning honey-bees and their products.

ARTICLE III.—MEETINGS.

This Association shall hold meetings annually, at such time and place as shall be selected by the Executive Committees, notices to be mailed to members 60 days previously, and the same to be published in the bee-periodicals at least two months before the meeting.

ARTICLE IV.—DUES.

The annual Membership Dues of this Association shall be \$1.00, payable in advance.

ARTICLE V.—MEMBERSHIP.

SECTION 1.—The Membership of this Association shall be composed of three classes, viz.: Representative, General and Honorary, each of which shall pay the Secretary-Manager one year's dues (\$1.00) when joining, receiving receipt there-

for, thus indicating the membership of the holder, and entitling to all rights and benefits conferred by the Association for one year from the date of payment. In order to retain membership in this Association, the advance annual dues must be paid within three months after expiration of previous year's dues.

SEC. 2.—The Representative Membership of this Association shall consist of two delegates to be selected by each State association, and to be seated upon showing receipt for payment of dues and presentation of proper credentials, the same to be approved by the Committee on Credentials.

SEC. 3.—The General Membership shall consist of all, excepting Representative members, who join the Association by the payment of annual dues.

SEC. 4.—Honorary Membership shall consist of those who may receive a two-thirds-vote of all the members present at any annual meeting, in consideration of some valuable service rendered in the interest of apiculture. Honorary members may also become General members upon the payment of the annual dues, and thus be entitled to all the benefits of the Association.

ARTICLE VI.—OFFICERS AND DUTIES.

SEC. 1.—The officers of this Association shall be, a President, Vice-President, Secretary-Manager, Treasurer, and Attorney, whose duties (all except the last named) shall be those usually performed by such officers. They shall constitute the Executive Committee.

SEC. 2.—The Vice-President shall also be the Committee on Credentials of Representative Membership.

SEC. 3.—The Secretary-Manager shall have in charge all the legitimate work of the Association, and carry out the same under the advice of the Executive Committee.

SEC. 4.—The Treasurer shall furnish a bond of \$1,000 for the faithful accounting of the funds of the Association, the same to be approved by the President and Secretary-Manager, who shall sign all vouchers for the payment of funds.

SEC. 5.—The Attorney shall attend to the legal work of the Association, as directed by the Executive Committee, and receive therefor the customary fees.

SEC. 6.—All officers shall be elected by a majority ballot, and hold their several offices for one year from January 1st, or until their successors are elected and qualified.

ARTICLE VII.—ELECTION OF OFFICERS.

All members in good standing on Dec. 1 shall have the privilege of voting, which shall be done by mail, upon proper blanks furnished (with a full list of membership) to each member, by the Secretary-Manager, on that date, the votes to be returned by the following January 1st. The Annual Report of the Secretary-Manager shall also accompany the Voting-Blanks.

ARTICLE VIII.—FUNDS.

The funds of the Association shall be used for any purposes in the interest of the pursuit of bee-culture, when approved by the Executive Committee, and to pay the legitimate expenses of the Association.

ARTICLE IX.—SALARIES AND MILEAGE.

SEC. 1.—The salary of the Secretary-Manager shall be 15 per cent. of the gross annual membership Dues received in each calendar year. He shall also be allowed the necessary cost of a stenographer for taking the proceedings of the annual meeting.

SEC. 2.—The railroad mileage of the Executive Committee, when attending the annual meetings, shall be paid by the Association.

SEC. 3.—The railroad mileage of the Representative membership shall be partially provided for in the following manner: 20 per cent. of the gross amount of annual dues paid by the membership of this Association found in each State, shall be paid to the two delegates from such State attending the annual meeting, to be equally shared by them. For instance: Any State having a membership in the Association of 100, would be entitled to \$20 to apply on the mileage expense of her two delegates to the annual meeting. The mileage of any State's delegates not equalling the amount such State is entitled to, the balance shall be paid into the Treasury of the Association of such State.

ARTICLE X.—AMENDMENTS.

This Constitution may be amended by a majority vote of all the members, provided that all proposed amendments shall be presented in writing, signed by five members, and sent to the Secretary-Manager before Dec. 1, so that they may be mailed with the Voting-Blanks and his Annual Report.

Question-Box.

In the multitude of counsellors there is safety.—Prov. 11-14.

The Average Weight of Prime Swarms.

Query 30.—What is the average weight of a natural prime swarm?—MICH.

J. A. Green—Five to six pounds.

P. H. Elwood—See the bee-books.

Wm. McEvoy—About seven pounds.

G. M. Doolittle—About five pounds.

Jas. A. Stone—I never weighed one to see.

J. M. Hambough—I never weighed one to see.

Dr. J. P. H. Brown—About from four to six pounds.

Dr. C. C. Miller—See what the natural swarmers say.

W. G. Larrabee—I don't know. I never weighed one.

Rev. M. Mahin—Dr. Miller doesn't know, neither do I.

Eugene Secor—I never weighed swarms enough to guess.

Mrs. L. Harrison—I don't know. I should guess 10 pounds.

Mrs. J. N. Heater—I should estimate about 2½ or 3 pounds.

C. H. Dibbern—They vary a good deal. I should call 4 to 5 pounds a fair-sized swarm, 6 to 7 pounds an extra-good one.

Emerson T. Abbott—I do not know. If they were full of honey, they would weigh more than they would if they were not.

E. France—Something less than a 10. What is the weight of a pig? Oh, "average" weight? I don't know—never weighed one. About a peck.

R. L. Taylor—About six pounds where the production of comb honey is the object. Colonies devoted to the production of extracted honey, and furnished with plenty of combs, should cast swarms 2 or 3 pounds heavier.

J. E. Pond—About four pounds I have found a fair average. I have had prime swarms that weighed only about two pounds, and then again I have had one or two that weighed over six pounds. The difference in length of time that elapses before hiving will, I think, make quite a difference in weight, by the greater or less honey consumed after swarming and before hiving. So that a heavy swarm, when it comes out, might be quite light when hived.

G. W. Demaree—It depends too much upon the amount of honey the swarm loads up with when it leaves its tenement house, to fix a reliable standard of weight for an average swarm. According to some experiments I have conducted, a bee can carry its own weight in honey over and above its food in its digestive organs. You can readily see the difficulty of fixing the weight of bees. It is like weighing a man with a load of indefinite weight on his shoulder, to ascertain his live weight. The average swarm, honey and all, is about six pounds. I mean prime swarms.

Bee-Keeper's Guide—see page 635.

NOW WE HAVE IT! GLEASON'S HORSE-BOOK!

The Only Complete and Authorized Work
by America's King of Horse-Trainers,

PROF. OSCAR R. GLEASON,

Renowned throughout America and recognized by the United States Government as the most expert and successful horseman of the age. The whole work comprises History, Breeding, Training, Breaking, Buying, Feeding, Grooming, Shoeing, Doctoring, Telling Age, and General Care of the Horse.

You will know all
about a horse
after you
have
read
it.

No one can fool you
on the age of a
horse after
you have
read
it.

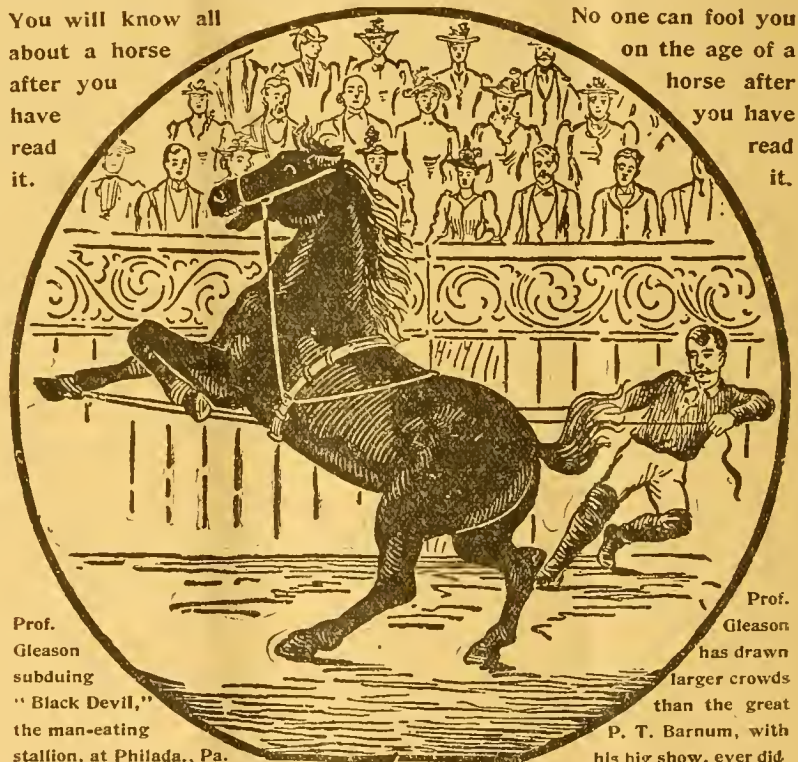

Prof.
Gleason
subduing
"Black Devil,"
the man-eating
stallion, at Philada., Pa.

Prof.
Gleason
has drawn
larger crowds
than the great
P. T. Barnum, with
his big show, ever did

416 Octavo Pages—173 Striking Illustrations.

Produced under the direction of the U. S. Government Veterinary Surgeon.

In this book Prof. Gleason has given to the world for the first time his most wonderful methods of training and treating horses

100,000 SOLD AT \$3.00 EACH.

But we have arranged to supply a limited number of copies to our subscribers absolutely free. First come, first served.

Here are Our Offers of this Great Book.

Regardless of the fact that thousands upon thousands of these books in cloth binding have been sold at \$3.00 each, we are enabled to, and will for a limited period, send a heavy-paper-bound copy FREE as a premium to our present regular subscribers for sending us **ONE NEW Subscriber** to the Bee Journal for a year at \$1.00; or we will mail the book and the Bee Journal for a year to any one sending us \$1.60. Address,

GEORGE W. YORK & CO.,

118 Michigan Street,

CHICAGO, ILL.

General Items.

Results of the Past Season.

The season is over, and the honey all harvested. I got 500 pounds in 1-pound sections, and a few unfinished sections, from 10 colonies, spring count. I had eight natural swarms, and made one artificial one, so I have now 19 colonies.

A. P. GREEN.

Cedarhome, Wash., Sept. 11.

Milkweed Pollen on Their Feet.

I noticed a question asked Dr. Miller by W. H. F., Lake City, Mo., as to what ailed his bees. As he and I have about the same number of colonies, and I have had just the same experience, I think he will find they have been working on milkweed. If he will look closely, he will notice that their feet look as if they had been crushed, and have a reddish cast.

WM. CRAIG.

Luce, Mich.

Successful with Bees.

I have been so far very successful with my bees, which start I got from that noble man, Allen Pringle. I purchased my first colony from him, and at that time I had never spoken to him. I sent him a letter, enclosing the money, and he sent me a good colony. They arrived June 6, 1894. I have now 11 good colonies.

I have received the American Bee Journal every Friday since I subscribed for it, and I am very pleased with it. I wish you every success.

GEO. K. WHITE.

Toronto, Ont., Sept. 19.

Report for the Season.

I notice an article on page 517, about the Ferris extractor. I know the extractor is a good one, for I have been using one on the same principle, only on a larger scale, for over 18 years, from which I have taken, and sold, 300 to 1,600 pounds of wax a year. I have always had first-class wax.

I will now give an account of the honey taken this season from my 40 colonies (I started with only 10). Thirty of them I have two stories high. I have taken from them in all, extracted, 2,465 pounds, and comb, 150 pounds; samples 50 pounds, and 100 pounds of wax. I have some fine samples, which I expect to have photographed soon.

J. ARCHER.

Santa Barbara Co., Calif., Sept. 3.

Cedar Hives All Right.

On page 471, S. W. B. complains of his bees leaving cedar hives. I would like to say to the readers of the Bee Journal that our firm has used cedar hives, and have never had a single swarm leave their hive. We use hives made of kiln-dried lumber, and also of lumber dried in the air, with perfect satisfaction. We have honey that has been stored continuously for three years in cedar cases, and the flavor is not affected in the least by the scent.

We are manufacturers of bee-supplies, and think it no more than right that the

PROF. A. J. COOK'S BOOK FREE!

The Bee-Keeper's Guide

OR

MANUAL OF THE APIARY.

This 15th and latest edition of Prof. Cook's magnificent book of 460 pages, in neat and substantial cloth binding, we propose to give away to our present subscribers, for the work of getting new subscribers for the American Bee Journal.

A description of the book here is quite unnecessary—it is simply the most complete scientific and practical bee-book published to-day. Fully illustrated, and all written in the most fascinating style. The author is also too well-known to the whole bee-world to require any introduction. No bee-keeper is fully equipped, or his library complete, without "THE BEE-KEEPER'S GUIDE."

Given For 2 New Subscribers.

The following offer is made to PRESENT subscribers only, and no premium is also given to the two new subscribers—simply the Bee Journal for one year:

Send us Two New Subscribers to the Bee Journal (with \$2.00), and we will mail you a copy of Prof. Cook's book FREE as a premium. Prof. Cook's book alone sent for \$1.25, or we club it with the Bee Journal for a year—both together for only \$1.75. But surely anybody can get only 2 new subscribers to the Bee Journal for a year, and thus get the book as a premium. Let everybody try for it. Will you have one?

GEORGE W. YORK & CO., 118 Mich. St., CHICAGO, ILL.

✦ MONEY SAVED IS MONEY GAINED. ✦

THE ROYAL UNION

Life Insurance Company

DES MOINES, IOWA.

The Iowa Policy

Is one that definitely promises to keep an accurate account with you; credit your premiums and interest, charge the actual expense and mortuary cost, and hold the remaining funds subject to your order.

Agents Wanted.

JOHN B. KING, GENERAL AGENT,
Suite 513 First Nat'l Bank Bld'g,
20 Atf CHICAGO, ILL.

Mention the American Bee Journal.

IF YOU WANT THE

BEE-BOOK

That covers the whole Apicultural Field more completely than any other published, send \$1.25 to Prof. A. J. Cook, Claremont, Calif., for his

Bee-Keeper's Guide.

Liberal Discounts to the Trade.

DUQUESNE COLLEGE!

PENN AVE. AND EIGHTH ST.

PITTSBURG, PA.

Thorough Courses—Classical, Scientific, Normal, English Commercial, Preparatory, and Ladies Literary. Efficient and experienced instructors. Day and Night sessions.

Send for Catalog.

Mention the American Bee Journal.

Sweet Clover & Canada.

At the following prices:

5 lbs.	10 lbs.	25 lbs.	50 lbs.
\$1.00	\$1.60	\$3.75	\$7.25.

Also a quantity of Motherwort and Catnip seed. Prices on application.

EGGS for Hatching. Buff Leghorns, Indian Games, & Light Brahmans. Ch Ice Birds. A breeder for 30 years. Prices on application

JOHN McARFUR,

881 Yonge Street, TORONTO, ONT.

15 Atf Mention the American Bee Journal.

READERS Of this Journal who write to any of our advertisers, either in ordering, or asking about the Goods offered, will please state that they saw the Advertisement in this paper.

Page & Lyon Mfg. Co.,

NEW LONDON, Wis., operates two saw-mills that cut, annually, eight million feet of lumber, thus securing the best lumber at the lowest price for the manufacture of bee-keepers' supplies. They have also just completed one of

The Largest Factories,

and have the latest and most improved machinery for the manufacture of Bee-Hives, Sections, etc., that there is in the State. The material is cut from patterns, by machinery, and is absolutely accurate. For Sections, the clearest and

The Whitest Basswood

is used, and they are polished on both sides. Nearness to pine and basswood forests and possession of mills and factory equipped with best machinery, all combine to enable this firm to furnish the best goods at

The Lowest Prices. ♡

For instance, it has a job lot of 200,000 No. 2 Sections that will be sold at 50 cts. per 1,000; or 2,000 Snow-White sections will be sold for \$4.00, and larger quantities at still lower prices. Send for Circular and see the prices on a full line of supplies.

16 Atf

WHEN ANSWERING THIS ADVERTISEMENT, MENTION THIS JOURNAL.

BEGINNERS.

Beginners should have a copy of the Amateur Bee-Keeper, a 70-page book by Prof. J. W. Rouse. Price 25 cents; if sent by mail, 28c. The little book and the Progressive Bee-Keeper (a live, progressive 28-page monthly journal) one year, 65c. Address any first-class dealer, or

LEAHY MFG. CO., Higginsville, Mo.

WHEN ANSWERING THIS ADVERTISEMENT, MENTION THIS JOURNAL.

California

If you care to know of its Fruits, Flowers, Climate or Resources, send for a Sample Copy of California's Favorite Paper—

The Pacific Rural Press

The leading Horticultural and Agricultural paper of the Pacific Coast. Published weekly, handsomely illustrated, \$2.00 per annum. Sample Copy Free.

PACIFIC RURAL PRESS,
220 Market St., - SAN FRANCISCO, CAL.

70 Colonies of Bees for \$100.

This offer will hold until October 10.

William Iden, Etna Green, Ind
Mention the American Bee Journal. 39 Atf

above statement, or enough of it to contradict any damage the statement might do us as manufacturers, should be published. The worst feature we have to overcome, in introducing cedar hives, is the fear that the scent will affect the honey, but we agree to pay the highest cash price for all honey produced in our hives, that is affected by the wood. We have shipped hives all over Washington and Oregon, and have never had a complaint.

P. & B.

Lewis Co., Wash.

Bees Didn't Do Well.

My bees have not done much this summer. They are doing some better now. We have had hardly any rain since February. It looks like rain now. If the honey-flow isn't better soon, we will have to feed.

A. R. YANDELL.

Sullivan, Ark., Sept. 12.

More Bees than Honey.

My bees have not done very well this year. I have taken only 1,100 pounds of honey from 46 colonies, though I may get 200 or 300 pounds more yet. I just doubled them up, with swarms, hiving 46. Every hive is full to overflowing, and all full of brood, but not much honey in the brood-chamber. There is plenty of bloom of all sorts.

THOMAS ASH.

E. Toledo, Ohio, Sept. 17.

"Golden" Comb Honey System.

Mr. Herman Ahlers, of Ahlers, Oreg., asks this question about my method of producing comb honey, recently illustrated in the American Bee Journal:

"What will become of the bee-bread? Won't the bees store it in the sections, close to the queen? or will they pack it up in the brood-nest?"

H. A.

This is a question I expected from some of our noted bee-keepers, from the fact that I feared it would result as you state it, but such is not the case. I have never found any pollen in any section as yet, and I do not believe that bees will deposit pollen when there are no eggs or larvae, as I have never had a queen lay an egg in her caged confinement (of five days) with this method; consequently, the bees must pack their pollen where there is a better prospect for the consumers (in the brood-nest). I hope Mr. Ahlers will try one colony at least, and report his experiment, as a practical test is the only true course to pursue for facts.

J. A. GOLDEN.

Reinersville, Ohio.

Producing Extracted Honey.

Of the various ways of producing extracted honey, the following seems to me to be the most successful:

In order to stimulate brood-rearing, I feed my bees early in the spring. When they have filled the combs (8 frames) with brood, I place four combs of brood in the upper story, and fill the remaining space with empty combs of last year's extraction. Thus I have 16 combs in all, viz., four combs with brood and four empty combs below, and the same above. A prolific queen will soon fill the empty combs with eggs. This causes a continual increase of bees, until about three weeks previous to the honey har-

THE "NOVELTY" POCKET-KNIFE!



Your Name on the Knife.—When ordering, be sure to say just what Name and Address you wish put on the Knife.

The NOVELTY KNIFE is indeed a novelty. The novelty lies in the handle. It is made beautifully of indestructible celluloid, which is as transparent as glass. Underneath the celluloid, on one side of the handle is placed an AMERICAN BEE JOURNAL reminder, and on the other side, name and residence of the Subscriber.

The material entering into this celebrated knife is of the very best quality; the blades are handforged out of the very finest English razor-steel, and we warrant every blade. The bolsters are made of German silver, and will never rust or corrode. The rivets are hardened German silver wire; the linings are plate brass; the back springs of Sheffield spring steel, and the finish of handle as described above. It will last a lifetime, with proper usage.

Why purchase the Novelty Knife? In case a good knife is lost, the chances are, the owner will never recover it; but if the Novelty is lost, having name and address of owner, the finder will return it; otherwise to try to destroy the name and address, would destroy the knife. If traveling, and you meet with a serious accident, and are so fortunate as to have one of the Novelties, your pocket KNIFE will serve as an identifier; and in case of death, your relatives will at once be apprised of the accident.

How appropriate this knife is for a Christmas, New Year or birthday present! What more lasting memento could a mother give to a son, a wife to a husband, a sister to a brother, a lady to a gentleman, or vice versa, a son to a mother, a husband to a wife, a brother to a sister or a gentleman to a lady—the knife having the name of the recipient on one side?

The accompanying cut gives a faint idea, but cannot fully convey an exact representation of this beautiful knife, as the "Novelty" must be seen to be appreciated.

How to Get this Valuable Knife.—We send it postpaid, for \$1.00, or give it as a Premium to the one sending us three new Subscribers to the BEE JOURNAL (with \$3.00), and we will also send to each new name a copy of the Premium Edition of the book "Bees and Honey." We club the Novelty Knife with the BEE JOURNAL for one year, both for \$1.90.

Any Name and Address Put on the Knife.

GEORGE W. YORK & CO.,

CHICAGO, ILLS.

Allow about two weeks for your order to be filled.

Extracted Honey For Sale!

We can furnish **Basswood** Extracted Honey, in 60-pound tin cans, on board cars in Chicago, at these prices: 1 can, in a case, 8 cents per pound; 2 cans in one case, 7½ cents; 4 cans (2 cases) or more, 7 cents. Cash must accompany each order.

A sample of the honey will be mailed to an intending purchaser, for 10 cents, to cover postage, packing, etc. We guarantee purity, and what we ship will be equal to sample.

Now it seems to us here is a splendid chance for any bee-keeper to supply his home demand after his own crop is all sold. Or, why not begin now to create a local honey-trade? Order one 60-pound can first, and start out among your neighbors and friends, and see what you can do. You ought to get at least 15 cents per pound in 5-pound lots, or 50 cents for 3 pounds. Some may be able to do even better than that, though we think that enough ought to be sold at these prices to make a fairly paying business out of it. Give it a good trial. Push it. It may grow into a nice winter's work for you.

GEORGE W. YORK & CO., 118 Michigan Street, CHICAGO, ILL.

That Queen-Clipping Device Free!

Works Like a Charm.

The Monette Queen-Clipping Device WORKS LIKE A CHARM. With it I have clipped 30 queens, all in one day, when examining my bees.

WM. STOLLEY, Grand Island, Nebr.

Couldn't Do Without It.

I have clipped 19 queens, and must say the Monette Queen-Clipping Device is by far the best invention ever made, and will be welcome to many bee-keepers as it was to me. I could not do without one now.

DR. GEO. LACKE, Newburgh, Ind.

PLEASE READ THIS OFFER TO PRESENT SUBSCRIBERS:

Send us just one new name for the American Bee Journal a year (with \$1.00), and we will mail you the Queen-Clipping Device FREE of charge. Or, the Queen-Clipping Device will be sent postpaid for 30 cts. But why not get it as a Premium by the above offer? You can't earn 30 cts. any easier. Almost every bee-keeper will want this Device. See page 130 (Feb. 27) for full description of it. Complete directions accompany each one sent out. It is a most ingenious and useful article. Address,

GEORGE W. YORK & CO., 118 Michigan St., Chicago, Ill.

There Is No Doubt About the MERIT of THE KEYSTONE DEHORNING KNIFE. It cuts both ways, does not crush. One clip and the horns are off close. Write for circular. A. C. BROSIUS, Cochranville, Pa.

Mention the American Bee Journal

4UB131

vest. At that time I place eight combs of sealed brood in the upper story; at the same time I prevent further egg-depositing in the upper story by interposing a queen-excluder. At the arrival of the honey-harvest the bees will all be hatched, emptying the combs to make space for the product of the honey-flow.

Experience shows that it requires no special inducement for the bees to store honey in the upper story, the combs of which being the natural home and usual place of ingress of the young workers.

The above described procedure is also a preventive to swarming; or at least it materially assists in the prevention of swarming, which (as an established fact) is necessary for the production of extracted honey.

In connection with the above, I would add the following suggestions: Never allow honey to accumulate to any excess in the hives, but extract it in proper time; that is, before the bees are confined to a limited space; for if you don't, you will weaken the energy of the bees for working.

Another means of the prevention of swarming, I think, lies in the procuring of five-banded Italian bees, which I believe to be more or less non-swarming.

A. G. HEISS.

Milwaukee, Wis., Sept. 15.

A Report from Indian Territory.

I am a bee-keeper of nearly two years' experience. I commenced with two colonies in box-hives, increased to four last year, transferred them to dovetailed hives last June, and increased, by purchase and artificial swarming, to 11 colonies. This year has been very dry—no rain since the middle of June. I have fed 400 pounds of granulated sugar. I Italianized all my bees.

I have made a great many blunders, and if it had not been for the American Bee Journal, I should never have succeeded so far.

J. T. HAIRSTON.

Salina, Ind. Ter., Sept. 13.

Queens and Queen-Rearing.

If you want to know how to have queens fertilized in upper stories while the old queen is still laying below; how you may safely introduce any queen, at any time of the year when bees can fly; all about the different races of bees; all about shipping queens, queen-cages, candy for queen-cages, etc.; all about forming nuclei, multiplying or uniting bees, or weak colonies, etc.; or, in fact, everything about the queen-business which you may want to know—send for Doolittle's "Scientific Queen-Rearing"—a book of over 170 pages, which is as interesting as a story. Here are some good offers of this book:

Bound in cloth, postpaid, \$1.00; or clubbed with the BEE JOURNAL for one year—both for only \$1.75; or given free as a premium for sending us three new subscribers to the BEE JOURNAL for a year at \$1.00 each.

A Bargain—EARLY QUEENS.

119 Colonies Italian Bees in Chaff Hives: two acres land; good house; excellent well. **Early Queens**—Tested, \$1.00; Untested, 50c. Sent by return mail.

E. L. CARRINGTON,

16Atf PATTUS, Bee Co., TEX. Reference—1st National Bank of Beeville.

Mention the American Bee Journal.

WOVEN WIRE FENCE
 Over 50 Styles The best on Earth. Horse high, Ball strong, Pig and Chicken tight. You can make from 40 to 60 rods per day for from 14 to 22c. a Rod. Illustrated Catalogue Free. **KITSELMAN BROS.,** Ridgeville, - Indiana.

48 EIT mention the American Bee Journal.

DO NOT ORDER UNTIL YOU HAVE WRITTEN US FOR PRICES ON

The "Boss" One-Piece Section



Also D. T. Hives, Shipping-Crates and Other Supplies.

We have completed a large addition to our Factory, which doubles our floor room; we are therefore in better shape than ever to fill orders on short notice. **Send for Price-List**

J. FORNCROOK,

WATERTOWN, Jeff. Co., Wis., Jan. 1st, 1896.

Mention the American Bee Journal.

Barnes' Foot-Power Machinery.

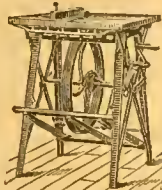

Read what J. I. PARENT, of CHARLTON, N. Y., says:—"We cut with one of your Combined Machines, last winter 50 chaff hives with 7-in. cap, 100 honey-racks, 500 broad frames, 2,000 honey-boxes and a great deal of other work. This winter we have double the amount of bee-hives, etc., to make and we expect to do it with this Saw. It will do all you say it will. Catalogue and Price-List

Free. Address, W. F. & JOHN BARNES, 45Ctf No. 995 Rndy St., ROCKFORD, Ill.

Mention the American Bee Journal.

CARLOADS



Of Bee-Hives, Sections, Shipping-Cases, Comb Foundation, and **Everything** used in the Bee-Industry.

I want the name and address of every Bee Keeper in America. No reason why you cannot do business with me. I have Cheap Lumber and Experienced Workmen; a good Water Power Factory and know how to run it. I am applying Dealers as well as consumers. Why not you? Send for Catalogues, Quotations, etc. **W. H. PUTNAM,** LE RIVER FALLS, Pierce Co., Wis.

Mention the American Bee Journal.

Honey-Clovers & Buckwheat SEED FOR SALE.

We have made arrangements so that we can furnish seed of several of the Clovers and Japanese Buckwheat, by freight or express, at the following prices, cash with order

	5lb	10lb	25lb	50lb
Alsike Clover	\$.70	\$1.25	\$3.00	\$ 5.75
Sweet Clover	.75	1.40	3.25	6.00
White Clover	1.25	2.00	4.50	8.00
Alfalfa Clover	.65	1.10	2.70	5.00
Crimson Clover	.55	.90	2.00	3.50
Jap. Buckwheat	.20	.35	.90	1.25

Prices subject to market changes.

Add 25 cents to your order, for cartage, if wanted by freight.

Your orders are solicited.

GEORGE W. YORK & CO.,

CHICAGO, ILLS.

Mention the American Bee Journal.

Wanted, Choice Comb Honey

W. W. McNeal, Wheelersburg, Ohio.

Mention the American Bee Journal.

AMONG THE BEE-PAPERS.

Queen-Rearing on a Canadian Island.

We learn from the Toronto Globe that a party consisting of Mr. Edmund Harris, President Long Point Company; R. F. Holtermann, President Ontario Bee-keeper's Association and also an officer of the Ontario Agricultural College, and others, visited Long Point the other day to inspect it as to the adaptability of the island for bee-keeping. Some forty-five colonies are being kept on the Point by the company at present as an experiment. Mr. Holtermann thought the place had great natural advantages for bee-keeping, especially after the basswood blossoms opened, and suggested that the island had great advantages for the breeding of queens. It is more than likely that Mr. Harris, the President with his well-known shrewdness and enterprise, will develop large apiaries on the island. The honey, which was sampled by those present, was pronounced first class, and it is the intention to put it on the New York, Boston, and other United States markets.—Gleanings.

Honey-Room Bee-Escapes.

R. C. Aikin, in the Progressive Bee-Keeper, makes quite an invention auxiliary to the new bee-escapes for honey-rooms—runs the bees into a largish box with one side of screen wire, instead of causing so many to wander around outside a la loose children. Having collected a lot of them he gives them in with the colony where they will do the most good. As he brings loads of supers from out-Apiaries with very little time spent in getting the bees out to start with, he would else be overrun with orphan bees, neither old nor young being able to find any home on getting out in a strange yard. His going-to-be way is to have a honey-wagon in milk-wagon style, bee-tight, and with the escape fixed in it. Then most of the old bees would get out and go home in the apiary where they belonged.—E. E. HASTY, in Review.

Replacing Aged Queens.

QUESTION.—I have several old hybrid queens that are past their usefulness, and I wish to replace them. How and when shall I proceed to do it?

ANSWER.—First as to the when: This can be done at any time; but I find that the bees supersede more queens just after the main honey-flow for the season is over than at any other time of the year; consequently, where I wish to supersede queens for any reason I do it just after the basswood-blossoms drop off, as the most of the honey in this locality comes from basswood. Now as to the how. Unless a change in variety of bees is desired, I would advise the beginner to leave this matter of superseding queens to the bees, as they will make fewer mistakes, if this matter is left to them, than the smartest bee-keeper in the land—especially where there is any Italian blood in the bees. But if we wish to change the breed of bees, then of course the apiarist must do it. The plan I use most, and like best, is to start queen-cells just before the basswood honey-yield closes, when the bees are in the best possible condition to rear extra

good queens; then two days before these cells are about to hatch I go to the colonies having queens which I wish to supersede, and hunt out the queens and kill them. Two days later the nearly mature cells are placed in queen-cell protectors and placed in these colonies; and my experience has been that, in 19 cases out of 20, young, thrifty, vigorous queens will be found laying in colonies thus treated, 15 days later.

If we do not wish to rear our own queens, we can send away for them; and to make sure that none shall be killed in introducing, the old queen should be killed nine days before we expect the new queens to arrive. When they arrive, open the hive and cut off all queen-cells, when the queen is to be introduced by letting the bees eat the candy away till the queen is liberated, according to instructions generally accompanying the queen.

Another way, which is usually successful, is to remove the old queen in the forenoon of a pleasant day, and at night, after the bees have returned home, give them a little smoke; and when they are filled with honey allow the new queen to run in at the entrance. Do not open the hive for four or five days, and you will rarely fail.—G. M. DOOLITTLE, in Gleanings.

Selected "Straws" from Gleanings.

Don't try to scrape sections when it's so hot propolis runs. Better have it cool enough so propolis is brittle.

Wooden separators can be made to do service very well instead of the basket-splints used by N. T. Phelps.

Don't leave sections on the hive, when the flow stops, for the bees to daub with glue. If you hope there will be a fresh flow, wait till it comes and then put the sections on again.

If supers containing some honey are put on a hive immediately after putting a swarm in it, I believe it has a tendency to make the swarm desert. Wait a day or two before putting on the supers. [The general practice on the part of those who clip their queens' wings, and catch the swarm as it returns, is to put that swarm on another stand under the same set of sections they have been working on. It is much more convenient to do the whole job at once. Mr. Vernon Burt, who comes to my mind as one who practices this plan, rarely, I believe, has a swarm that swarms again when so treated; but I can easily see that sections put over them, containing honey, take away the feeling that they have really got into new quarters. If swarms have any collective or individual idea, to the effect that they are going to the woods, or some place where there is no honey, comb, or even foundation, when they are placed in a hive that has sections partly drawn out, and filled with honey, and some bees on them, and if, also, they find foundation or combs in the brood-nest, it may make them feel as if they had made a mistake or that they had not got to the place they desired to go to.—EDITOR.]

READERS Of this Journal who write to any of our advertisers, either in ordering, or asking about the Goods offered, will please state that they saw the Advertisement in this paper.

HONEY and BEESWAX

MARKET QUOTATIONS.

The following rules for grading honey were adopted by the North American Bee-Keepers' Association, and, so far as possible, quotations are made according to these rules:

FANCY.—All sections to be well filled; combs straight, of even thickness, and firmly attached to all four sides; both wood and comb unsoiled by travel-stain, or otherwise; all the cells sealed except the row of cells next the wood.

No. 1.—All sections well filled, but combs uneven or crooked, detached at the bottom, or with but few cells unsealed; both wood and comb unsoiled by travel-stain or otherwise.

In addition to this the honey is to be classified according to color, using the terms white, amber and dark. That is, there will be "fancy white," "No. 1 dark," etc.

Chicago, Ill., Sept. 13.—Fancy white, 13c; No. 1, 12c; fancy amber, 9@11c; No. 1, 8@9c; fancy dark, 8@10c; No. 1, 8c. Extracted, white, 5@7c; amber, 5@6c; dark, 4½@5c. Beeswax, 24@25c.

The sales of best grades of comb honey are now assuming more volume, and most sales are at 12, 12½, and 13c. All of the shipments that show care in preparation for transportation are arriving in good order. The market is also bare of dark comb honey, and there is a demand for it which anyone having a supply should take advantage of by shipping now.

Philadelphia, Pa., Aug. 14.—Extracted, white, 8-10c; amber, 4-5c; dark, 3-4c. Beeswax, 25c.

No new comb in this market yet. Old comb cleaned out.

Detroit, Mich., Aug. 8.—No. 1 white, 12-12½c; fancy amber, 10-11c; No. 1 amber, 9-10c; fancy dark, 8-9c. Extracted, white, 5½-6c; amber, 5-5½c; dark, 4-5c. Beeswax, 24-25c.

Indianapolis, Ind., July 28.—Fancy white 15-16c; No. 1 white, 13-14c. Extracted, white, 6-7c. Beeswax, 25-27c.

No demand at all for off grades of either comb or extracted honey. Large fruit crop and warm weather are opponents to the demand for honey at present.

St. Louis, Mo., Aug. 8.—Fancy white, 13@14c; No. 1 white, 12@13½c; fancy amber, 11@11½c; No. 1 amber, 10@10½c; fancy dark, 8@9c; No. 1 dark, 7@7½c. Extracted, white, in cans, 5c; in barrels, 4½-4¾c; amber, 3@3½c; dark, 2½@3c. Beeswax, 18@20c.

Very little honey coming in at present, and the weather is too warm to handle to advantage if it were here.

Albany, N. Y., Sept. 19.—Fancy white, 13-14c; No. 1, 12-13c; fancy amber, 10-11c; No. 1 dark, 8-9c. Extracted, white, 6-7c; dark, 5c.

With cooler weather there is an increasing demand for comb honey, and stock is moving off freely. There is but very little demand for extracted, except fancy white put up in glass jars.

New York, N. Y., Sept. 9.—Fancy white, 13c; No. 1, 12c; fancy amber, 11c; No. 1, 10c; dark, 9c. Beeswax declining; 23@24c. s now top price.

New crop comb honey is now arriving freely. The demand is fair only, and mostly for small lots of 10 to 25 crates. Some exceptionally fine lots will probably sell for a little more. No change in extracted, with plenty of supply.

San Francisco, Calif., Sept. 16.—White comb, 10c; amber, 7½-9c. Extracted, white, 5-5½c; light amber, 4½-13c; amber colored and candied, 3½-4c; dark, 2½-3c.

There is a moderate quantity of the new crop comb, for which there is only local demand and that not very active. Last year's extracted is still in fair supply, but is quite steadily held, and is not meeting with much custom at the figures now demanded. A wheat ship cleared yesterday for Liverpool took 500 cases extracted honey of 1895 crop.

Beeswax, fair to choice, 23-26c. There is no heavy quantity on market, and buyers in search of this product find it necessary to pay full current rates, particularly if they are exacting as to quality.

Milwaukee, Wis., Aug. 8.—Fancy white, 14-15c; No. 1, 12-13c; No. 1 amber, 8-10c. Extracted, white, 6-7c; amber, 5-6c; dark, 4-5c. Beeswax, 22-24c.

New crop of honey begins to come forward. The demand is very poor and quotations almost nominal. Weather is very warm and the consumption of honey is very small. Plenty of fruit, and hence the appetite is satisfied with same in preference. Later on we expect an improved demand for honey of all kinds.

Minneapolis, Minn., Aug. 8.—Fancy white, 12½c; No. 1 white, 10@11c; fancy amber, 9@10c; No. 1 amber, 8@9c; fancy dark, 7@8c; No. 1 dark, 6-8c. Extracted, white, 5½@6½c; amber, 5@5½c; dark, 4@5c. Beeswax, 23@26c.

The demand for both comb and extracted is very quiet, and for the latter, nominal. The hot weather of the past week or so has checked demand for comb honey.

Cleveland, Ohio, Aug. 8.—Fancy white, 14½@15c; No. 1 white, 12½@13c. Extracted, white, 6@7c; amber, 4½@5½c. Beeswax, 22@25c.

There is not very much honey in our market. Selling rather slow. Demand beginning to be a little better. Think trade will be fair in this line this fall.

Kansas City, Mo., Aug. 8.—Fancy white comb, 15c; No. 1 white, 13@14c; fancy amber, 12-13c; No. 1 amber, 11-12c; fancy dark, 10-11c; No. 1, 8-10c. Extracted, white, 6-6½c; amber, 5 5½c; dark, 4-4½c. Beeswax, 22-25c.

Boston, Mass., Aug. 10.—Fancy white, 14-15c; No. 1, 12-13c; fancy amber, 9-10c. Extracted, white, 6-7c; amber, 5-6c. Beeswax, 25c.

Good supply of new honey, but demand is light this very hot weather.

Buffalo, N. Y., Sept. 19.—Fancy comb, 1-pound, mostly 12c, occasionally 13-14c; No. 2, 8-10c; No. 3, 4-7c. Extracted, 4-5c. Demand grows better as fruit decreases.

List of Honey and Beeswax Dealers.

Most of whom Quote in this Journal.

Chicago, Ills.

R. A. BURNETT & Co., 163 South Water Street.

New York, N. Y.

HILDRETH BROS. & SEOLKEN,
120 & 122 West Broadway.
CHAS. ISRAEL & BROS., 486 Canal St.

Kansas City, Mo.

O. C. CLEMOMS & Co., 423 Walnut St.

Buffalo, N. Y.

BATTERSON & Co., 167 & 169 Scott St.

Hamilton, Ills.

CHAS. DADANT & SON.

Philadelphia, Pa.

WM. A. SELSER, 10 Vine St.

Cleveland, Ohio.

WILLIAMS BROS., 80 & 82 Broadway.

St. Louis, Mo.

WESTCOTT COM. Co., 213 Market St.

Minneapolis, Minn.

S. H. HALL & Co.

Milwaukee, Wis.

A. V. BISHOP & Co.

Boston, Mass.

E. E. BLAKE & Co., 57 Chatham Street.

Detroit, Mich.

M. H. HUNT, Bell Branch, Wayne Co., Mich.

Indianapolis, Ind.

WALTER S. POWDER, 162 Massachusetts Ave.

Albany, N. Y.

CHAS. MCCULLOCH & Co., 380 Broadway.

Cincinnati, Ohio.

C. F. MUTH & SON, cor. Freeman & Central avs.

BEE-BOOKS

SENT POSTPAID BY

George W. York & Co.,
Chicago, Ills.

Bees and Honey, or Management of an Apiary for Pleasure and Profit, by Thomas G. Newman.—This edition has been largely re-written, thoroughly revised, and is "fully up with the times" in all the improvements and inventions in this rapidly-developing pursuit, and presents the apiculturist with everything that can aid in the successful management of an apiary, and at the same time produce the most honey in an attractive condition. It contains 250 pages, and 245 illustrations—is beautifully printed in the highest style of the art, and bound in cloth, gold-lettered. Price, \$1.00.

Langstroth on the Honey-Bee, revised by Dugdale.—This classic in bee-culture, has been entirely re-written, and is fully illustrated. It treats of everything relating to bees and bee-keeping. No apiarian library is complete without this standard work by Rev. L. L. Langstroth—the Father of American Bee-Culture. It has 520 pages; bound in cloth. Price, postpaid, \$1.25.

Bee-Keepers' Guide, or Manual of the Apiary, by Prof. A. J. Cook, of the Michigan Agricultural College.—This book is not only instructive and helpful as a guide in bee-keeping, but is interesting and thoroughly practical and scientific. It contains a full delineation of the anatomy and physiology of bees. 460 pages; bound in cloth and fully illustrated. Price, postpaid, \$1.25.

Scientific Queen-Rearing, as Practically Applied, by G. M. Doolittle.—A method by which the very best of Queen-Bees are reared in perfect accord with Nature's way. 176 pages, bound in cloth, and illustrated. Price, \$1.00.

A B C of Bee-Culture, by A. I. Root.—A cyclopaedia of 400 pages, describing everything pertaining to the care of the honey-bees. It contains 200 engravings. It was written especially for beginners. Bound in cloth. Price, \$1.25.

Advanced Bee-Culture, Its Methods and Management, by W. Z. Hutchinson.—The author of this work is too well known to need further description of his book. He is a practical and entertaining writer. You should read his book. 90 pages, bound in paper, and illustrated. Price, 50 cts.

Rational Bee-Keeping, by Dr. John Dzierzon.—This is a translation of his latest German book on bee-culture. It has 350 pages; bound in cloth, \$1.25; in paper covers, \$1.00.

Blauen-Kultur, by Thomas G. Newman.—This is a German translation of the principal portion of the book called BEES OF HONEY. 16-page pamphlet. Price, 40 cents.

Convention Hand-Book, for Bee-Keepers.—Thomas G. Newman.—It contains the parliamentary law and rules of order for Bee-Conventions—also Constitution and By-Laws, with subjects for discussion, etc. Cloth, gold-lettered. Price, 25 cts.

Thirty Years Among the Bees, by Henry Alley.—Gives the results of over a quarter-century's experience in rearing queen-bees. Very latest work of the kind. Nearly 100 pages. Price, 50c.

Why Eat Honey?—This Leaflet is intended for FREE distribution, to create a Local Market. 100 copies, by mail, 40 cts.; 500 for \$1.50; 1000, \$2.50. If 500 or more are ordered at one time, your name and address will be printed on them FREE.

How to Keep Honey and preserve its richness and flavor. Price same as Why Eat Honey.

Apiary Register, by Thos. G. Newman.—Devotes two pages to a colony. Leather binding. Price, for 50 colonies, \$1.00; for 100 colonies, \$1.25.

Preparation of Honey for the Market, including the production and care of comb and extracted honey. A chapter from BEES AND HONEY. Price, 10 cents.

Bee-Pasturage a Necessity.—This book suggests what and how to plant. It is a chapter from BEES AND HONEY. Price, 10 cents.

The Hive I Use, by G. M. Doolittle. It details his management of bees, and methods of producing comb honey. Price, 5 cents.

Dr. Howard's Book on Foul Brood.—Gives the McEvoy Treatment and reviews the experiments of others. Price, 25 cts.

Dictionary of Apiculture, by Prof. John Phil. Gives the correct meaning of nearly 500 apicultural terms. Price, 50 cts.

Winter Problem in Bee-Keeping, by G. R. Pierce. Result of 25 years' experience. 50 cts.

Handling Bees, by Chas. Dugdale & Son.—A Chapter from Langstroth Revised. Price, 8 cts.

Bee-Keepers' Directory, by H. Alley.—Latest methods in Queen-Rearing, etc. Price, 50c.

Foul Brood Treatment, by Prof. F. R. Cheshire.—Its Cause and Prevention. Price, 10 cts.

Foul Brood, by A. R. Kohnke.—Origin, Development and Cure. Price, 25 cts.

History of Bee-Associations, and Brief Reports of the first 20 conventions. Price, 15 cts.

Honey as Food and Medicine, by T. G. Newman.—A 32-page pamphlet; just the thing to create a demand for honey at home. Should be scattered freely. Contains recipes for Honey-Cakes, Cookies, Puddings, Foam, Wines, and uses of honey for medicine.

Prices, prepaid—Single copy, 5 cts.; 10 copies, 35 cts.; 50 for \$1.50; 100 for \$2.50; 250 for \$5.50; 500 for \$10.00; or 1000 for \$15.00.

When 250 or more are ordered, we will print the bee-keeper's card (free of cost) on the front cover page.

Bee-Keeping for Profit, by Dr. G. L. Tinker.—Revised and enlarged. It details the author's "new system, or how to get the largest yields of comb or extracted honey." 80 p.; illustrated, 25c.

Emerson Binders, made especially for the BEE JOURNAL, are convenient for preserving each number as fast as received. Not mailable to Canada. Price, 75 cts.

Commercial Calculator, by C. Ropp.—A ready Calculator, Business Arithmetic and Account-Book combined in one. Every farmer and business man should have it. No. 1, bound in water proof leatherette, call finish. Price, 40 cts. No. 2 in the artificial leather, with pocket, silicate slate, and account-book. Price, 60 cts.

Green's Four Books, by Chas. A. Green.—Devoted to, 1st. How We Made the Old Farm Pay; 2nd. Peach Culture; 3rd. How to Propagate Fruit-Plants, Vines and Trees; 4th. General Fruit Instructor. Nearly 120 pages. Fully illustrated. 25 cts.

Green's Six Books on Fruit-Culture, by Chas. A. Green.—Devoted 1st, to Apple and Pear Culture; 2nd, Plum and Cherry Culture; 3rd, Raspberry and Black-berry Culture; 4th, Grape Culture; 5th, Strawberry Culture. 129 pp.; illustrated. 25 cts.

Garden and Orchard, by Chas. A. Green.—Gives full instructions in Thinning and Marketing Fruits; Pruning, Planting and Cultivating; Spraying, Evaporation, Cold Storage, Etc. 94 pages, illustrated. Price, 25 cts.

Kendall's Horse-Book.—35 pictures, showing positions of sick horses, and treats on all their diseases. English or German. 25 cts.

Silo and Silage, by Prof. A. J. Cook.—It gives the method in operation at the Michigan Agricultural College. Price, 25 cts.

Lumber and Log-Book.—Gives measurements of lumber, logs, planks; wages, etc. 25c.

Maple Sugar and the Sugar Bush, by Prof. A. J. Cook.—Full instructions. Price, 35 cts.

Grain Tables, for casting up the price of grain, produce, hay, etc. Price, 25 cts.

Capon and Caponizing, by Dr. Sawyer, Fanny Field, and others.—Illustrated. All about caponizing fowls, and thus how to make the most money in poultry-raising. 64 pages. Price, 30 cts.

Our Poultry Doctor, or Health in the Poultry Yerd and How to Cure Sick Fowls, by Fanny Field.—Everything about Poultry Diseases and their Cures. 64 pages. Price, 30 cts.

Poultry for Market and Poultry for Profit, by Fanny Field.—Tells everything about the Poultry Business. 64 pages. Price, 25 cts.

Turkeys for Market and Turkeys for Profit, by Fanny Field.—All about Turkey-Raising. 64 pages. Price, 25 cts.

Rural Life.—Bees, Poultry, Fruits, Vegetables, and Household Matters. 100 pages. 25 cts.

Potato Culture, by T. B. Terry.—It tells how to grow them profitably. Price, 40 cts.

Hand-Book of Health, by Dr. Foote.—Hints about eating, drinking, etc. Price, 25 cts.

Alsike Clover Leaflet.—Full directions for growing. 50 for 25 cts.; 100 for 40 cts.; 200, 70c.

the description of the books on this page. Following is the clubbing-list:

1. Langstroth on the Honey-Bee.....	\$2.00
2. A B C of Bee-Culture.....	2.00
3. Bee-Keepers' Guide.....	1.75
4. Bees and Honey [Cloth bound].....	1.65
5. Scientific Queen-Rearing.....	1.75
6. Dr. Howard's Foul Brood Book.....	1.10
7. Advanced Bee-Culture.....	1.30
9. Blauen-Kultur [German].....	1.25
10. Rational Bee-Keeping [Cloth bound].....	2.00
11. Rational Bee-Keeping [Paper bound].....	1.75
12. Thirty Years Among the Bees.....	1.30
13. Bee-Keeping for Profit.....	1.15
14. Convention Hand-Book.....	1.15
15. Poultry for Market and Profit.....	1.10
16. Turkeys for Market and Profit.....	1.10
17. Capons and Caponizing.....	1.10
18. Our Poultry Doctor.....	1.10
19. Green's Four Books.....	1.15
20. Green's Six Books on Fruit-Culture.....	1.15
21. Garden and Orchard.....	1.15
23. Rural Life.....	1.10
24. Emerson Binder for the Bee Journal.....	1.60
25. Commercial Calculator, No. 1.....	1.25
26. Commercial Calculator, No. 2.....	1.40
27. Kendall's Horse-Book.....	1.10
30. Potato Culture.....	1.20
32. Hand-Book of Health.....	1.10
33. Dictionary of Apiculture.....	1.35
34. Maple Sugar and the Sugar Bush.....	1.20
35. Silo and Silage.....	1.10
36. Winter Problem in Bee-Keeping.....	1.30
37. Apiary Register (for 50 colonies).....	1.75
38. Apiary Register (for 100 colonies).....	2.00
39. Bee-Keepers' Directory.....	1.30

Convention Notices.

TENNESSEE.—The Southern East Tennessee Bee Keepers' Association will hold its annual meeting at Cookson's Creek, on Oct. 10, 1896. Session will open at 9 o'clock a. m. All are invited to attend, and especially those engaged in bee culture. W. J. COPELAND, Sec. Fetzerton, Tenn.

CONNECTICUT.—The fall meeting of the Connecticut Bee-Keepers' Association will be held at the Capitol at Hartford, on Oct. 21, 1896, at 10:30 a. m. All interested in bees and the production of honey are invited to attend this meeting. Waterbury, Conn. MRS. W. E. RILEY, Sec.

UTAH.—The semi-annual meeting of the Utah State Bee-Keepers' Association will be held in the City and County building, on Oct. 5, 1896, at 10 a. m. All are invited. If we take into consideration existing conditions, it should be apparent to all that a good foul brood law for the protection of our bee-keepers is extremely necessary. For this and other reasons it is hoped that all our bee-keepers will attend, and assist in framing a good law. Our bee-keepers should unite and work for their own interest, and for the general benefit and success of the bee industry. Provo, Utah. GEO. E. DUDLEY, Sec.

WISCONSIN.—The annual meeting of the Southwestern Wisconsin Bee-Keepers' Association will be held at Wauzeka, Wis., Oct. 7 and 8, 1896. All that are interested in apiculture are invited to attend, and especially those that want a foul brood law to protect their bees from this dread disease. Our committee is working hard to get every bee-keeper interested, and we should all feel it is for our interest to help get a State law to protect our bees. Many of our prominent bee-keepers of the State have promised to be at our meeting, and to one can afford to miss it. Boscobel, Wis. M. M. RICE, Sec.

Please Send Us the Names of your neighbors who keep bees, and we will send them sample copies of the BEE JOURNAL. Then please call upon them and get them to subscribe with you, and secure some of the premiums we offer.

Book Clubbing Offers.

(Read Carefully.)

The following clubbing prices include the American Bee Journal one year with each book named. Remember, that only ONE book can be taken in each case with the Bee Journal a year at the prices named. If more books are wanted, see postpaid prices given with

A GOLD DOLLAR



is about the actual worth of our new book on Incubation and Poultry. Contains a full and complete description of the Reliable Incubator & the Brooder of same name, together with cuts and instructions for building poultry houses and much of interest and benefit to the poultryman. Sent on receipt of the RELIABLE INCUBATOR & BROODER CO. QUINCY, ILLS.

36E17t Please mention the Bee Journal.

Bottom Prices

**BRING US BIG TRADE.
GOOD GOODS KEEP IT.**

If you want the best supplies that can be made at a little less cost than you can buy the same goods for elsewhere, write to us for low prices. 1896 Catalogue now ready—ask for it and a free copy of **The American Bee-Keeper** (36 pages).

Address,
THE W. T. FALCONER MFG. CO.,
JAMESTOWN, N. Y.
Mention the American Bee Journal.

COMB FOUNDATION!

Wax always wanted for Cash or in Exchange for Fdn. or other Supplies. My trade is established on **Low Prices** and the merit of my **Foundation**. Orders filled promptly.

WORKING WAX INTO FDN. BY THE LB. A SPECIALTY. Wholesale prices to dealers and large consumers. Send for Prices and Samples to—**GUS DITTMER, AUGUSTA, WIS.** Reference—Augusta Bank. 1A1f
Mention the American Bee Journal.

MUTH'S HONEY EXTRACTOR

PERFECTION
Cold-Blast Smokers,

Square Glass Honey Jars, Etc.

For Circulars, apply to CHAS. F. MUTH & SON, Cor. Freeman & Central Aves., Cincinnati, O. Send 10c for Practical Hints to Bee-Keepers.

Mention the American Bee Journal.



ONE MAN WITH THE UNION COMBINATION SAW
Can do the work of four men using hand tools, in Rippling, Cutting-off, Mitering, Rabbeting, Grooving, Gaining, Dadoing, Edging-up, Jointing Stuff, etc. Full Line of Foot and Hand Power Machinery Sold on Trial. Catalogue Free.

SENECA FALLS MFG. CO.,
46 Water St., SENECA FALLS, N. Y.
1A1y *Mention the American Bee Journal.*

SHIPPING - CASES, HONEY - JARS, —CARTONS, LABELS—

And a Full Line of Supplies.
Comb & Extracted Honey.
I. J. STRINGHAM,
105 Park Place. NEW YORK, N. Y.
APIARY—Glen Cove, L. I.
Mention the American Bee Journal.

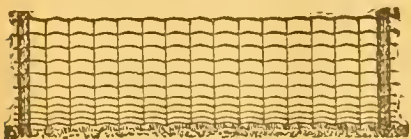

A Campaign of Education

For ten years we have carried it on, and with wonderful success. Competitors at first scoffed at our claim, that elasticity was absolutely necessary in a wire fence. Now they are tumbling over one another to prove they have it. No matter if it is all bunched in one panel, it's a move in the right direction.
PAGE WOVEN WIRE FENCE CO., Adrian, Mich.
Mention the American Bee Journal.

19th Year Dadant's Foundation 19th Year

It still in the lead, for we use all the latest improvements, including the

NEW WEED PROCESS,

and still make the best goods. Remember that we do not use any acid to purify our bees-wax, and that is why our Foundation preserves the smell of the honey and is more acceptable to the bees, than any other. It is kept for sale by

T. H. Strickler, Solomon City, Kansas.
G. E. Hubbard, Fort Wayne, Ind.
L. Hansen, Davenport, Iowa.
C. Theilmann, Theilmann, Minn.
E. C. Eaglesfield, Berlin, Wis.
E. T. Abbott, St. Joseph, Mo.
J. M. Jenkins, Wetumpka, Alabama
John Rey, East Saginaw, Mich.
Vickery Bros., Evansville, Ind.

The Jennie Atchley Company, Beeville, Texas.
C. F. Muth & Son, Cincinnati, Ohio
E. Kretzmer, Red Oak, Iowa.
G. B. Lewis Co., Watertown, Wis.
James Reynolds' Elevator Co., Poughkeepsie, N. Y.
Louisiana Bee-Keepers' Supply Manufactory, Donaldsonville, La.
Page & Lyon, New London, Wis.
John Nebel & Son, High Hill, Mo.

and many other Dealers. All agree in saying that no goods are better than ours.

We make a specialty of **Veils and Veil Studs** of best quality, cotton and silk.

Langstroth on the Honey-Bee, Revised

Bee-Keepers' Supplies, Smokers, Sections, Tin Pails, etc.

Samples of Foundation and Tulle FREE with Circular. Instructions to beginners with Circular. Send us your address.

CHAS. DADANT & SON,

Mention the American Bee Journal.

HAMILTON, Hancock Co., ILL.

See Campaign Book Offer on page 623! Better Have It!

* Extracted Honey *



Finest Quality, Basswood and Clover.
2 60-lb. cans in case 7c. per pound. 1 60-lb. can in case, 8c. per pound. A sample by mail, 10 cts. **POUDER'S Honey-Jars and Complete Line of Supplies.** Catalogue Free.
WALTER S. POUDER,
162 Mass. Avenue, INDIANAPOLIS, IND.

PATENT WIRED COMB FOUNDATION



Has No Sag in Brood-Frames
Thin Flat-Bottom Foundation
Has No Fishbone in the Surplus Honey.
Being the cleanest is usually worked the quickest of any Foundation made
J. VAN DEUSEN & SONS,
Sole Manufacturers,
Sprout Brook Montgomery Co., N. Y.

Good Prices on Your Comb Honey!

Then you want our latest

NON-DRIP SHIPPING-CASES.

Our trade was never so large in these as now; and Commission Men tell us that Comb Honey in our Cases brings

BETTER PRICES

than some of the Cases made by competitors. The fact is, we know the demands of the trade, and are prepared to supply them. Remember, home-made or poorly made Cases are dear at any price. Honey in such Cases always brings several cents below the market price.

If you wish to get **GILT-EDGE PRICES** on **GILT-EDGE HONEY** put it up in

Root's Non-Drip Shipping-Cases.

THE A. I. ROOT COMPANY,

Factory and Main Office, **MEDINA, O.**

BRANCH OFFICES:

118 Michigan St., Chicago, Ill.
1024 Miss. Str., St. Paul, Minn.

Syracuse, N. Y.
Mechanic Falls, Maine.

AMERICAN BEE JOURNAL

DEVOTED EXCLUSIVELY TO THE INTERESTS OF HONEY-PRODUCERS

ESTABLISHED IN 1861
THE OLDEST BEE-PAPER IN AMERICA

Published Weekly, at \$1.00 per annum.

Sample Copy sent on Application.

36th Year.

CHICAGO, ILL., OCTOBER 8, 1896.

No. 41.



Honey as Food—Why It Should be Eaten.

BY PROF. A. J. COOK.

There are four kinds of food that are necessary to health and life. These are the inorganic elements, like water, salt, phosphate and carbonate of lime, etc.; the non-nitrogenous organic—so-called because they owe their origin to organic nature, and contain no nitrogen—and the nitrogenous. The second class—the non-nitrogenous organic—contain oxygen, hydrogen and carbon, illustrated in starch, the various sugars and the fats. The last class all contain nitrogen, and resemble in many ways the white of an egg, and so are often called albuminoids. Muscle, white of an egg, cheese, and blood albumen, are illustrations of the nitrogenous food elements. That we need all of these in our food, is shown in the fact that we hunger for them if they are not represented, or if they are too scantily represented in our food. Again, milk and egg, which may be regarded as typical food, contain all of these substances.

In this article, we are concerned only with the second class of food principles—the non-nitrogenous organic. Of these, the fats do not interest us at present, although important in all complete food rations. Bees get their albuminous and fatty food elements in the pollen. We thus have before us now only the starch and sugars. These not only contain oxygen, hydrogen, and carbon, but always contain the oxygen and hydrogen in proportion to form water, that is, two atoms of hydrogen to one of oxygen. Thus the formula for starch is $C_6 H_{10} O_5$, and of water is $H_2 O$. Glucose and levulose, the sugars of honey, have the following formula, $C_6 H_{12} O_6$. From the fact that starch and sugar contain oxygen and hydrogen in proportion to form water, they are called carbo-hydrates. The carbo-hydrates, then, including starch, and all sugars, as cane sugar, which includes beet sugar, and maple sugar, milk sugar, and all the glucose or reducing sugars, are very important food elements, so important that we are not left, as in case of most foods, to the chance of securing them in our food that we eat, but the liver is constantly forming liver sugar, which is very much like the sugar of honey. The liver, then, is a marvelous chemist, for it can do what no human chemist can do—form sugar, though we only eat the purest muscle, like the beef's heart. To change nitrogenous material into

carbo-hydrates, is a wondrous transformation, that man has never yet been able to perform. The liver can, and does, do it. In our early development, before the liver is sufficiently formed to be functionally active, a purely pre-natal organ—the placenta—forms sugar. We all know how children long for candy. This longing voices a need, and is another evidence of the importance of sugar in our diet.

Until a comparatively recent date cane-sugar was unknown, if we except maple sugar, and that must have been a very unimportant food article. Thus, in the olden time honey formed the almost exclusive sugar, and so must have been a very important substance. We know by the references to it in classic writings, and in the Bible, that it was held in very high regard, as well it might be, for it, with starch, composed



President A. I. Root.

the entire stock of carbo-hydrates to be drawn upon by the caterer of the olden time, as he worked to satisfy the needs, or, what is about the same thing, the appetites of his patrons.

I have been told by some excellent physicians that they thought that some of the worst diseases of modern times—especially Bright's disease of the kidneys—was far more prevalent than formerly, and they thought it due to the large con-

sumption of cane-sugar, which was all unknown in the long ago. It seems to me that a little study of the subject may explain this, if it be true, and may give us two valuable hints—the one, to eat more honey; the other, to take special pains to give children all the honey that they wish, and at every meal-time, in the hope to lessen the amount of cane-sugar that they will eat. They like and crave sugar, because they need it to nourish them, and so given plenty of sugar in the honey, the need will be met, and the hunger for candy and cane-sugar will be less keen.

The digestion of food is simply to render it osmotic, or capable of being taken through an organic membrane, capable of being absorbed. We eat starch. It is non-osmotic, and would lie in the stomach and intestines indefinitely, except that by digestion it is changed to a glucose like sugar, which is very osmotic, and so easily absorbed from the aliment-canal into the blood. Cane-sugar, though somewhat osmotic, is not readily absorbed, nor is it readily assimilated, even though it pass into the blood. Thus cane-sugar must be digested or changed to a glucose like sugar.

Bees gather nectar from the flowers, and as they sip it, or draw it, from the flowers, they mingle with it a kind of



Secretary Dr. A. B. Mason.

saliva or ferment, from their upper head glands, and the large glands of the thorax, and thus transform it to honey, which contains, almost exclusively, a reducing sugar, and not cane-sugar. Thus bees do to nectar what we do to cane-sugar—they transform it to a more osmotic and more assimilable glucose like sugar. We call this in our case digestion of the cane-sugar, and it is just the same in case the bees do it. If any one prefers he may call it "transformation." In any case, it makes honey a safer food than cane-sugar, and we do well to eat it more generally; and it is especially desirable as food for children.

Children should be given all the honey at each meal-time that they will eat. It is safer; will largely do away with the inordinate longing for candy and other sweets, and in lessening the desire will doubtless diminish the amount of cane-sugar eaten. Then if cane-sugar does work mischief with health, the harm may be prevented. There can be no doubt but that in eating honey our digestive machinery is saved

work that it would have to perform if we ate cane-sugar; and in case it is over-worked and feeble, this may be just the respite that will save from a break-down.

Again, if cane-sugar is absorbed without change, it will be removed by the kidneys, and may result in their break-down; and so physicians may be correct in asserting that the large consumption of cane-sugar by the 19th century man, is harmful to the great eliminators—the kidneys—and so a menace to health and long life.

It may be urged in reply to the above, that honey is a poison to many. This is not the sugar of the honey, but some other element, very likely the formic acid, or perhaps the extract from the flowers. It seems most likely that the deleterious element is the formic acid added to the sweet by the bee. This keeps the honey from fermentation, and is not harmful to many; only occasionally a person is unable to eat it.

Claremont, Calif.



The Use of Drawn Combs—Some Drawbacks.

BY REV. EMERSON T. ABBOTT.

Much has been said of this of late, and some of the writers seem to think it a new thing. Perhaps it is, if a thing may be called new which has been tried and rejected, and then after years has been taken up again and pushed to the front. However, this has nothing to do with the real merits of the case.

I know by experience that bees will store honey more rapidly, and larger quantities of it, if they are given drawn combs, but the larger quantity will be secured at the sacrifice of quality. I am thoroughly convinced that bee-keepers will find that they have made a mistake, if they adopt the practice of using drawn combs. If honey is to be considered a luxury—as many claim it always will be—then quality is of more importance than quantity.

There are two drawbacks to the use of drawn combs, which, in my opinion, can never be overcome. One of these is the tendency of the honey to sour when it is put into the combs so rapidly. I tried drawn combs two seasons when the bees were working almost exclusively on the basswood, and in both cases I had trouble to keep the honey from granulating in the cells. Comb honey will seldom granulate unless it is improperly cured, or is exposed to moisture after it is taken from the hives. For some reason the bees do not cure the honey as thoroughly when stored in drawn combs as they do when they build the combs as they store the honey. I'm free to say that I see no way by which this difficulty can be overcome at present.

The other, and perhaps more serious, objection to the use of drawn combs is, that one can never secure as delicate and friable comb in this way as he can when the bees build the comb as they store the honey. I have never seen any combs that had been drawn out over winter and then filled with honey the next season, but what were tougher and harder than they would have been if they had been filled with honey at the time they were made, or as they were being drawn out. By placing such honey on the market one is sure to injure his comb-honey business, especially if he has been producing a fine quality of honey and catering to the best trade for fancy prices. His customers are very apt to conclude that he has learned the trick of making "artificial honey." Bee-keepers have enough to contend with now along the line without adding another difficulty in the shape of drawn combs.

I have just had my attention called to a Bulletin issued by the Connecticut Experiment Station, on the workings of the "pure food law" in that State, in which it is stated that out of 12 samples of comb honey examined by the State chemist, six were filled with sugar syrup which had been fed to the bees. Well, this may be so and it may not, but, to tell the truth, I am very much inclined to think that the chemist made

a mistake, and that had he been better posted, the six cases would have turned out to be only granulated honey. Let this be as it may, bee-keepers cannot afford to adopt any method which will lower the standard of comb honey, or render it any less tempting to the human palate. Therefore, my advice is, not to be in a hurry about adopting this method of adding to the sum total of the comb honey crop until it has been demonstrated that the points which I have suggested are not well taken.

Since writing the above, I have been talking with a bee-keeper who used drawn combs for the first time this season, and he said some of his honey had begun to sour in the combs at this early date, before he took it off from the hives.

St. Joseph, Mo.



Furnishing the Feed in an Apiary on Shares.

BY G. M. DOOLITTLE.

A correspondent sends in three questions and desires that I answer them in the American Bee Journal, which, with your permission, Mr. Editor, I will do. The first question is this:

"Who furnishes the feed when the apiary is worked on shares, for stimulating purposes, or to keep the bees from starvation, when they do not have stores enough in the fall for winter? In other words, what is the custom regarding such feeding?"

Well, I do not know that there is any custom. The only way that I know to govern such matters is to enter into an agreement explicit enough to cover all cases of emergency, and have it put down in black and white, and then live up to it according to the Christian rule laid down in the Good Book, "who sweareth to his own hurt and changeth not;" for if you go into "bees on shares," some one is apt, as a rule, to have their feelings, if not their pocket-book, hurt.

If you took the bees in the spring and the owner of them said nothing whether they had honey enough to carry them through to the time new honey came in, and they were short of feed, I should think that he should furnish the feed, were they likely to starve.

As to feeding to stimulate, I do not think that it can be made to pay for the feed and the time. If you are to have the bees for a term of years, and they do not have honey enough in the hives any fall for the bees to come through in good condition till swarming-time the next year, then I should say that the person taking the bees is the one who should furnish the feed. If both were to share and share alike in the profits from the bees (the way in which bees are usually let out on shares), then I should say that both should bear equally the expense of feeding, whenever it is necessary to be done.

But in addition to what I said above, about bees on shares, I would say with emphasis, *don't*. Far better purchase two or three colonies, work your way up with them as your knowledge increases, thus being "your own man" all the while, than to try to gain a knowledge regarding the business by building yourself up on some other person's property along this line. Almost any other partnership business works better than it does with bees.

CONTROLLING DRONES.

The next question asked is as follows: "I have five colonies of bees—three blacks and two Italians. I wish to secure the pure mating of my queens another year. Would it be well to give the Italians a frame of drone-comb and put drone-traps on the blacks when the young Italian queens are mating? or is there a better way?"

If the correspondent is desirous of having his queens purely mated, of course he must kill or control all drones from undesirable colonies. The drones can be controlled with the traps; but in this case you must buy the traps, keep them on the colonies, and furnish the money necessary to rear and feed

the drones, all of which is an expense that would better be avoided.

If you think that you must rear the drones, and do not wish to buy traps, you can put a piece of perforated zinc at the entrance of the undesirable colonies, keeping it there till four o'clock, then remove and let the drones out; and while out, replace and keep the most of them out for evening destruction. This would be about the only way with box-hives, unless the trap was used. But for frame hives (and I would advise the use of no others) much the best way would be to remove all of the drone-comb, or nearly so, from the black colonies, and replace it with worker-comb, and thus you will save all the trouble and cost of producing the drones, and you will rear 50 workers to every square inch of comb, in place of 32 drones, these workers storing honey for you in place of the drones eating it.

In any event, you could not be sure of having your queens purely mated unless there were no black or hybrid bees in the woods or any apiary for a distance of four or five miles from you in every direction, which is a state of affairs that does not usually exist in most parts of our country. But for honey-production, I doubt whether it would pay to be too careful to have all of your queens purely mated, for a first cross (or what is more truly hybrids than the general mixture which are called hybrids) give nearly, if not quite, as good results in honey as do pure bees of any race.

If you were to procure Italian queens for the three black colonies and Italianize the blacks before any drones were



Vice-President Wm. McEvoy.

reared in these hives in the spring, you would then have things about as you want them, and that, too, about as cheaply as by any plan I know. These things are quite easy when you come to fully understand all the points bearing on the same.

THE BEE-MOTH LARVA KILLED BY FROST.

The third and last question reads thus: "I have read that frost would kill the larvæ and eggs of the bee-moth. If so, what temperature will it take to do it? I have some combs which were exposed to the cold all winter, but worms hatched out in them the next June, or, at least, the worms were at work on them at that time."

It is generally supposed that a temperature of 10° above zero will destroy all eggs and larvæ of the bee-moth; but, candidly, I do not know whether it will or not. At times I have thought that zero and below was sure death to everything in the bee-moth line; then, again, I have been equally positive that worms which had wintered over somehow in a

very low temperature, either in the egg or larval form, were those which troubled the combs upon the return of warm weather the next year. Who can tell us something positive about this matter? We know that eggs and larvæ are carried over in a colony of bees, or in their combs; and I have thought that these, after hatching into the mature moth, may have found their way to my combs in some way, though I hardly knew how.

Borodino, N. Y.



Sweet Clover—Its Value from a Commercial Standpoint.

BY MRS. L. E. R. LAMBRIGGER.

Since bee-keepers have started to boom sweet clover as a honey-plant, an effort is being made on the part of constitutional kickers and chronic growlers to "down it," on the ground that it is a "noxious weed." Such an assertion is as false as it is ridiculous. If sweet clover is a noxious weed, then so is alfalfa, and in fact all our clovers.

In these days of financial distress, it is generally conceded that the thing which will bring us the quickest and surest returns for labor and capital invested is *the* thing of all things for the people to tie to. Silver dollars are no longer found rolling uphill, nor are they cast at our feet by the careless fling of mountain torrents in their mad scurry to the sea. We



Treasurer W. Z. Hutchinson.

must look elsewhere for them, and, in my opinion, sweet clover furnishes the gateway to one of those "elsewheres."

Its utility for any purpose for which alfalfa is famed, seems to be unquestioned, save in the minds of the uninformed or prejudiced.

Sweet clover hay is excelled by none both as food for horses and for milch cows. When young and tender it constitutes the finest of pasture; if wanted for its seed, it yields many times the number of bushels per acre of any clover with which I am familiar. It possesses valuable medicinal properties: it was ever one of the stand-bys of my grandmother's garden; she used to prepare an ointment from a decoction of the leaves, which for soothing and healing purposes far surpassed any of the present new-fangled "patents."

It is a handsome plant; its highly aromatic fragrance is pleasant—and I have read that pillows filled with the dried leaves will woo the god of sleep when all else fails.

As a honey-plant, I believe it to be unrivalled. It came

into bloom in our locality last spring on May 25, and the great honey-flow lasted a month—and a flow it was, indeed; it just seemed as if honey *poured* into the hives. This was from a two-acre field fenced in from stock. Then we had about as much more in pasture for the purpose of later blooms; some of that is blooming yet (Aug. 25). We had abundance of other bee-pasture, but the bees had neither eyes nor ears for anything as long as sweet clover lasted.

We tried a frame of the honey soon after it was sealed, and I did not quite like the flavor—thought my taste would have to be cultivated, but Aug. 9 we tested another frame, gathered in June, and found it excellent, so I am led to believe that sweet clover honey improves with age. (Am I correct?)

Great claims are made for alfalfa as a honey-plant; personally I know nothing about it, as there is but one piece of alfalfa in our locality, and that is less than a mile from us; and, by the way, we are the only bee-keepers in this locality. This neighbor, who owns the alfalfa, called the other evening; we asked him if he had observed any of our bees working on his alfalfa blooms.

"Bees! why, bless your soul, I never saw a honey-bee in my life—wouldn't know one if I did see it," he replied.

He was invited to step out and get acquainted; his comment was:

"What funny, stubby little things they are. Well, no! I've never seen any of them up our way."

This particular region seems to be the natural home of the honey-bee, and in my next, I will, with our editor's permission, give you some of the reasons why it is so.

In closing, my advice to every bee-keeper and farmer is, plant sweet clover if you want to be surprised. It never troubles cultivated fields, and never needs any preparation of soil.

Knox County, Nebr.



Starting an Apiary in California—Doctoring.

BY DR. E. GALLUP.

I have been asked by many correspondents how a person with small means could start an apiary in California. Also, how I came to give up bee-keeping for doctoring. By the editor's permission, I propose to answer both questions. It may make the article rather long, but I will try to make it interesting to some.

I started in last spring with two colonies of bees—a good one, and one with a poor queen, so it did not amount to much until I introduced a new queen. I found one swarm in March, and had two swarms given to me in April—one of them a good one, and the other weak in numbers, and required considerable nursing and feeding to keep it alive.

The first swarm found filled its hive and cast a good-sized swarm in 12 days. In six days I found the swarm queenless. On examining the old colony for a queen-cell, I found every comb built all drone-comb, and drone-brood, and queen-cells built over drone-brood. The new swarm had built all drone-comb also, and it was two months before I could get a laying queen in either of those colonies, on account of the weather being so cold and windy. I succeeded in rearing one queen, but she was balled and killed in front of her hive on her return from her wedding-trip.

There was no headway made at all until sometime in June. I started in with Gallup hives, but intending to rear bees for sale, I thought best to adopt the standard Langstroth hive. So I made all Langstroth hives, and have transferred all the six first colonies to them. I have purchased and had donated to me 12 queens; those donated were sent by breeders that claimed that I had done enough so they could afford to donate a queen, etc. I have received queens from two breeders in Texas, one from Arkansas, and five from Ken-

tucky, one from Iowa, and one from Wisconsin, one from Ohio, and one is now due from Massachusetts. The queens have all proved satisfactory except one that was worthless, and I superseded her.

I received an Albino queen from Texas, that is a little ahead of anything I ever saw, and I have seen some good queens in my time. The queens from Kentucky were extra-good ones, their workers are golden beauties, and they have evidently been reared for business as well as beauty. The queens from Wisconsin and Ohio I received only last week, so I cannot tell how they will turn out. All received have proven satisfactory as to purity; the one superseded could not, or would not, keep two Langstroth frames occupied with brood.

I have made all my own hives (45 single ones) myself. I made one observation hive and one sun extractor. The cost of single hives for material was 32 cents each. The tools used were a common handsaw, one carpenter's square, two hammers (one large, and one small for nailing frames), and a common jackplane. Not an expensive outfit, by any means. The hives are all made from first-class redwood lumber, and all are good, substantial, well-made hives. *I know, for I made them.*

I have purchased \$8 worth of comb foundation, and used nearly all of it. I lost one queen in introducing; came very nearly losing another by following the directions sent with the queen. I learned, some 50 years ago, how to introduce queens with tobacco smoke, from an old Hollander, and I have never failed by that process. I can remove a queen and introduce a new one in from 10 to 15 minutes.

Another kink I learned from him, also, is this: When you have to set hives close together, side by side, and young queens come out on their wedding flight, mark the front of the hive so the young madam cannot make a mistake. I pin a piece of newspaper, cut in a peculiar shape, over the entrance of one hive; over another I pin an old black hat; over another, a paper sack (inflated) just above the entrance, etc. Make your marks, whatever they are, as odd and prominent as possible. I have had six queens come out in one day, close side by side, and no mistake made in getting back all right; while I neglected two hives, and had both queens to go into one hive, but I discovered the mishap in time to save them both. I never had lost a queen in that manner, if I attended to "posting notices" just over the entrance. They can be removed as soon as we are done with them. I dislike painting the fronts of the hives different colors, as recommended by some. The old Hollander had over 100 hives set in a row, all alike, and only about two inches space between each hive, and he said that posting notices as above proved infallible. It certainly has with me.

During the bad weather in spring I fed \$3.00 worth of sugar, all told. I now have 30 good colonies of bees, all Italianized. If the two months in spring had been as good as it usually is here, I could have made 60 colonies just as easily as to have made the 30.

Now for what I was doing in that time: My last wife died three years ago the 17th of last March, with inherited consumption. I do not claim to cure consumption when once thoroughly seated, but I have cured incipient consumption in many cases. I always prolong life, and make the patients more comfortable while they do live. My wife left me with three little fellows on my hands to care for, the youngest two, the next four, and the oldest six years of age. And I have taken sole care of them since, without the help of a woman, with the exception of two months at one time, and one month just past. I have done all my housework, cooking, etc.

At the time I commenced my "bee-factory," last spring, I would get breakfast, and be at the west end of town (two miles from home) at 7 o'clock in the morning, where I treated

a Mrs. B. She had a complication of complaints caused by drugging for scatica. The doctors had drugged her for years. In fact, she had (like one of old) suffered many things from many physicians, but all to no purpose, but rather grew worse. She was cured in three weeks by common-sense treatment, at a cost of \$18.

I cured three cases of typhoid fever in three days each, at a cost of \$5.00 each; one case of neuralgia of long standing, dyspepsia, etc., all caused by drugging until the little girl had ceased to grow, and had weak eyes—I cured her at an expense of \$5.00 to the parents. One young man was deaf, caused by drugging for fever a few years ago; rheumatic pains, dyspepsia, constipation, etc.; cured at an expense to him of \$5.00.

A Mr. H., with one withered leg, cold and dead, had drugged constantly for 12 years; paid all his earnings over and above supporting his family, to doctors and drugstores, until his mind was badly affected, and on the verge of committing suicide. He said: "I had typhoid fever 12 years ago for 10 weeks, and the fever left me with this paralyzed leg." My reply was this: "*That cannot be possible, for a fever is a cleansing, purifying process, a remedial effort of Nature to throw off impurities from the system, consequently if properly assisted it always leaves the patient in better health than when it found him. Your fever could have been cured in three days by natural process, and without drugs of any description. Your swallowing poisonous drugs for 10 weeks paralyzed your leg. Your system is now thoroughly saturated with poison from head to foot. Now, if you commence treating with me, you must agree faithfully to stick to me three weeks, or I will not touch your case, because I shall stir up the stagnant and poisonous blood, and drive the poison out of the system, and it will make you deathly sick. Your body is a machine, and I shall go to work mechanically with my hands to cleanse the human machine. You will perhaps vomit, but you will purge fearfully, and wind up at the end with typhoid fever that the doctors suppressed 12 years ago. I can certainly cure you without the least particle of doubt on my part, etc.*"

He was cured at an expense to him of \$20. The veins and arteries are the streams and rivers; the nerves are the telegraph wires, etc. In his case he had a tornado of poison (commonly called "medicine") thrown into the stomach, and this tornado had impaled or thrown down the telegraph wire at the hip joint, and stopped all communication from the head office through the leg. All that was needed was to stir up the *debris* in the small streams and rivers, and repair the line at the hip joint. Now, understand, that the nerves are what causes the blood to flow, and without nerves the blood cannot flow.

Then I had another case helpless with rheumatism, joints all enlarged and badly swollen, very painful to attend. All those cases I visited before noon, and was at home at 11:30 to get dinner for myself and children. The youngest tots stay at home alone, the eldest went to school.

In the afternoon I had Mr. A. O. Sutton, of Easton, Mich., and family to see to. He came here on crutches with chronic rheumatism for seven years; had paid out hundreds of dollars to doctors, all to no purpose, only to make him worse. Mrs. Sutton had female trouble (chronic); the three little children, all nervous from drugging, etc. I sent them all home joyful, happy and well.

I had a Mrs. S. from Washington (State). She heard of me, and came all the way down here for treatment. She had been 42 years an invalid, a good share of the time bedfast, and had suffered many things from many physicians, all to no purpose. She had paid out hundreds of dollars to make herself sick, and to keep her sick. She was on the verge of insanity from drugging, but is now happy and sees her way clear to good health once more.

Besides my regular patients I attended three childbirths; their labor is shortened from six to seven hours, and they invariably are up and around on the third day. I attended and cared for five families of children with measles, besides my own three had them; not one of the lot staid in the house over one day. My children never went to bed a single day, and took care of themselves while I was away. I had three cases of cholera infantum, and one case of rheumatism; told the latter patient what to do, and let him cure himself, as he had only been drugged three months. I had one case of deafness and palpitation of the heart; gave him directions and let him cure himself, as he had only been drugged a short time.

One case was a boy 16 years old, with a sprained knee; three years previously he sprained the same knee, and paid a doctor \$30 to keep him a cripple for six months. I explained to him what to do, and he cured himself in two days; I charged him nothing for such a simple case.

I was called in to see a family down with fever and colds; told them what caused the colds and fever, and how to avoid it in the future. I cure cholera infantum by talking to the mother in this manner:

"We have had three hot days, and you have fed your little one just as often and just as much as you did when the weather was cool. It never takes as much food to keep up the vitality in hot weather as it does when cool, consequently you should not have fed so much or so often. The surplus food over and above what Nature required, was either decomposed or was undigested. That irritated the mucus membrane of the stomach and bowels, and your little one was cross and fretful from nervousness, and you fed it more. Now stop feeding the child for 24 hours; give it all the water it will drink, and flush the colon with tepid water, two or three times in the course of the 24 hours. Fill up all it can hold, and let it pass off immediately. If a very high fever, use cold water. It can do no harm. Hereafter, you must regulate the diet according to the weather, and avoid trouble."

Remember that *all* disease or sickness is avoidable. I have not the least particle of fear of sickness with my little chaps whatever. They are muscular, wiry, tough, healthy, and hearty; not a pound of surplus fat or diseased flesh about them; never have taken the least particle of medicine of any kind whatever; neither have I given a particle of medicine in all my 40 years' practical experience. I never have lost a case of diphtheria, cholera infantum, cramp, or any acute disease, where the patient had not previously been poisoned with drugs.

It has taken quite a long article to tell you what I was doing while starting my apiary. On my road home I would come past the lumber yard, and take a board or two, as the case might be, on my shoulder, and get up at break of day, feed the thoroughbred Langshans, brown leghorns, and Wyandotts, Pekin ducks, turkeys, and thoroughbred white fantails and the pony; then make a bee-hive before my neighbors were out of bed; get breakfast, and off on foot at 6:30. That gave me 30 minutes to go two miles and get to work. I am quite young yet, only past 76. I think you ought to see how a man with very little means can start an apiary. *What are you going to do about it?*

Bees are doing extra well yet.

Santa Ana, Calif., Sept. 11.



Honey as Food and Medicine.—A new and revised edition of this 32-page pamphlet is now issued. It has 5 blank pages on which to write or paste recipes taken from other sources. It is just what its name indicates, and should be liberally distributed among the people everywhere to create a demand for honey. It contains a number of recipes on the use of honey as food and as medicine, besides much other interesting and valuable information. Prices, postpaid, are: Single copy, 5 cts.; 25 copies 65 cts.; 50 for \$1.00; 100 for \$1.50. Better give them a trial. Send all orders to the Bee Journal office.

The New McCartney Combined Foundation-Fastener and Section-Press.

BY S. H. HERRICK.

It is said that necessity is the mother of invention. This may be true, but equally true it is that competition is the father of it. For, look where you will, and you will see that sharp competition is the order of the day, and is constantly spurring on the minds of our inventive geniuses to study out something still better and more useful than anything of its kind now before the public. Take our own industry, for example—what improvements have been made in hives! Take foundation—what a valuable invention it is. And then, smokers—what improvements have been brought out on them.

Take bee-escapes—but a few years ago no one had heard of such a thing. Then the "Dibbern escape" came out, but no sooner had it been fairly placed on the market than the "Porter" bobs up serenely, and (being a big improvement on the other) "takes all the persimmons." But while the "Por-

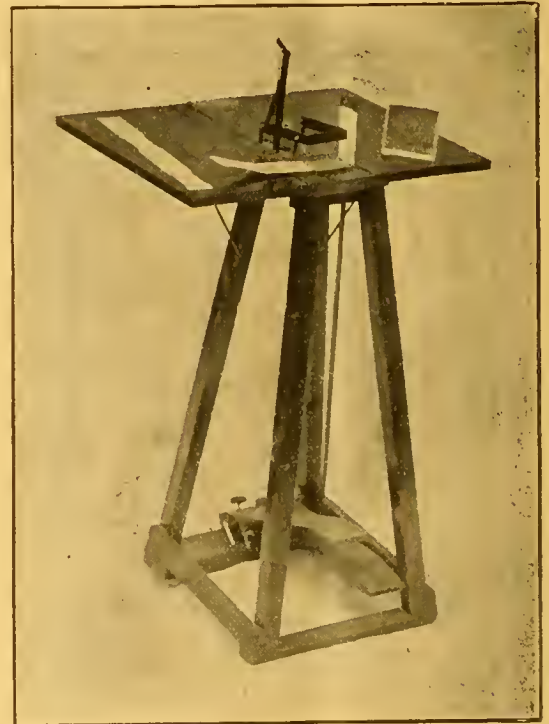

McCartney's Foundation-Fastener and Section-Press.

ter escape" is conducting the bees down and out "single file," Mr. Jardine conceives the idea that one exit is no more enough when bees want to find their mother than is one exit in a theater when the play is over; and out comes the new "Jardine escape," with its six exits.

Parker's foundation fastener was a pretty good little tool, but the "Daisy" came along and beat it all to pieces. Now comes the "New McCartney"—a machine which fastens the sections together, and cuts the foundation and fastens it in the sections, all complete. I do not know that I can describe the process, but I will try.

You will see by the illustration that there are two treadles. Standing (or sitting) in front of the machine, take a section and bend it ready to be fastened together. Place it in the machine, and press the foot on the right side treadle; this fastens the section squarely and nice. Slide the foot over to the other treadle and press down, and the foundation is car-

ried forward, cut off, and fastened—all in one move of the foot. Starters can be put in as small as a quarter inch or full size, and can be instantly changed from large to small, or *vice versa*. This is done by a set screw near the rear end of the treadle.

While at work the jaw should be kept lubricated by applying occasionally with a pencil-brush a little honey thinned with water and kept handy in a shallow dish. With a little practice this machine can be made to do very rapid work in a first-class manner.

I understand that this machine will be on exhibition at the meeting at Lincoln, Nebr., but unfortunately Mr. McCartney is at present afflicted with rheumatism, and probably will not be able to be present at that meeting.

Winnebago County, Ill.

PERSONAL MENTION.

MR. A. D. STOCKING, of Escondido, Calif., has recently passed away. For many years he was a subscriber and correspondent of the Bee Journal, though not of late years.

MR. HENRY F. IMHOLT, of Washington county, Minn., lost his father by death on Sept. 7. He was 76 years of age, being sick only two days, with inflammation of the bowels.

MR. W. P. KEYES, for some years a partner of Mr. James Fornbrook, of Watertown, Wis., and afterward connected with the Marshfield Mfg. Co., is now manager of the Wauzeka Section Co.

HON. GEO. E. HILTON, of Michigan, reports having taken 10,000 pounds of as fine comb honey as was ever produced in that State, from 150 colonies, spring count. Good for "George!"

MR. J. A. GREEN, we are very sorry to learn, lost his dear wife by death about two weeks ago, leaving a child about six weeks old. Mr. Green will have the sympathy of all the bee-keeping friends in his deep sorrow.

MR. WM. F. CLARKE had an excellent tribute to the memory of "The Late Allen Pringle," in the September Review. But it was greatly marred by the lugging in of some unnecessary as well as unkind personalities, referring to a few of Mr. Pringle's critics.

PROF. A. J. COOK has been selected to edit, in the monthly California Cultivator and Poultry-Keeper, a department called "Applied Science in Agriculture." It will be a valuable department, and a great addition to the editorial force of that double-named paper.

MR. HASTY, in the September Review, gives a lot of "cream" that he has succeeded in "skimming" from Gleanings and the Bee Journal. We think Mr. H. well deserves the name of "Inimitable Skimmer," even if he doesn't get quite all the "cream" that rises to "view."

MR. SIDNEY SLEEPER, of Holland, N. Y., reports in the September American Bee-Keeper that his 188 working colonies of bees gathered, on July 6, 3,000 pounds of honey in 10 hours; and on Aug. 15 they gathered 1,500 pounds of basswood and 7,000 pounds of buckwheat honey. How's that for high? Mr. S. thinks they beat the record of the world. We venture to remark that their keeper is not as sleepy as his name might indicate.

MESSRS. FREDERICO AND GIOVANNI METELLI, two prominent Italian brother bee-keepers, died recently within a few days of each other. Dr. Giovanni Metelli was born in 1843, and entered the military service as infantry surgeon in 1866, in which he remained until his death. His teachings were in favor of large hives, very strong colonies, and reserve colonies for reinforcement. According to the President of the Association, he "freed Italian apiculture from the last impediments which attached it to methods, which, however suited to the countries in which they originated, were little adapted to the fertility of the Italian soil, and the mildness of the climate,

and the different character of the Italian bee." So reports Mr. F. L. Thompson, in his interesting "Notes from Foreign Bee Journals," in the September Review.

MR. A. P. KARNS, of Titusville, Pa., finds himself the owner of a swarm of bees that had evidently absconded from some neighboring apiary, and had taken up their abode amid the branches and foliage of a maple tree at Mr. K.'s place. The local newspaper of Sept. 12 said that "the white combs containing honey and brood, suspended in the open air, and the festoon of busy workers, resembling a colony of *Apis dorsata*, the giant bees of India, has been a source of interest to residents of that vicinity during the past two weeks."

MR. FRANK MCNAY, the king of Wisconsin honey-producers, dropped into the Bee Journal office on Sept. 26. He has taken about 50,000 pounds of extracted honey this year, and has so far handled about 75,000 pounds. His honey was both basswood and willow-herb, samples of which he left with us. Mr. McNay bought the bees and fixtures belonging to the late Christopher Grimm, who, with his brother Adam, were such extensive bee-keepers. It seems that the mantles of both of the Grimms have fallen upon Mr. McNay. But his shoulders are high and broad, so he wears his honors gracefully.

EDITOR MERRILL, of the American Bee-Keeper, when announcing the Lincoln convention, said:

"The subject of amalgamation with the Bee-Keepers' Union will be brought up, and will no doubt be voted down."

This has led us to wonder whether our brother editor is a real prophet, or has he some inside information? We thought that amalgamation was really favored by the majority. We know that some objections have been advanced against it, but we don't remember seeing any that weren't somewhat sieve-like.

MR. THOS. G. NEWMAN wrote us, on Sept. 18, that he had been lecturing in San Francisco, and was then about to go to Camp Harmony, at Escondido, Calif., where the Hon. J. M. Hambach is now keeping bees. Mr. Newman, we believe, is lecturing in the interest of the spiritual philosophy. He also wrote that Mrs. Newman had met with a fall, and very badly bruised her face, head and side. It would seem that she had enough to contend with in her erysipelas affliction, without enduring painful accidents. We hope she will speedily recover from the effects of her fall, and also get relief from the erysipelas.

LATER.—Since writing the foregoing, we notice that Mr. Newman was elected President of the California State Spiritualists' Association, at its first annual meeting in San Francisco, Sept. 4. His spiritualistic friends are very anxious that he remove permanently to San Francisco.

A New Binder for holding a year's numbers of the American Bee Journal, we propose to mail, postpaid, to every subscriber who sends us 20 cents. It is called "The Wood Binder," is patented, and is an entirely new and very simple arrangement. Full printed directions accompany each Binder. Every reader should get it, and preserve the copies of the Bee Journal as fast as they are received. They are invaluable for reference, and at the low price of the Binder you can afford to get it yearly.

The Alsike Clover Leaflet consists of 2 pages, with illustrations, showing the value of Alsike clover, and telling how to grow it. This Leaflet is just the thing to hand to every farmer in your neighborhood. Send to the Bee Journal office for a quantity of them, and see that they are distributed where they will do the most good. Prices, postpaid, are as follows: 50 for 25 cents; 100 for 40 cents; or 200 for 70 cents.

The Names and Addresses of all your bee-friends, who are not now taking the Bee Journal, are wanted at this office. Send them in, please, when sample copies will be mailed to them. Then you can secure their subscriptions, and earn some of the premiums we have offered. The next few months will be just the time to easily get new subscribers. Try it earnestly, at least.

Now is the Time to work for new subscribers. Why not take advantage of the offer made on page 651?

OLDEST BEE PAPER IN AMERICA

THE AMERICAN BEE JOURNAL

ESTABLISHED IN 1861

GEORGE W. YORK, Editor.

PUBLISHED WEEKLY BY

GEORGE W. YORK & COMPANY,

118 Michigan St., CHICAGO, ILL.

\$1.00 a Year—Sample Copy Sent Free.

[Entered at the Post-Office at Chicago as Second-Class Mail-Matter.]

Vol. XXXVI. CHICAGO, ILL., OCT. 8, 1896. No. 41.

EDITORIAL COMMENTS.

At Lincoln, Nebr.—By the time the majority of our readers get this copy of the American Bee Journal, the 27th annual convention of the North American Bee-Keepers' Association at Lincoln, Nebr., will have drawn to a close. We will not be back in time to say very much, if anything, about the meeting, in next week's number, but in the issue for the week following we expect to begin the publication of a complete report of the proceedings. If all the plans are successfully carried out, something greatly advantageous to the bee-industry should result.

The Illinois State Fair was held last week. We had the pleasure of being present on Tuesday and Wednesday, accompanying the judge of the apiarian exhibit, Mr. F. Grabbe, of Libertyville, Ill. The bee and honey exhibits were large and very fine, being nearly twice the quantity as was shown last year, we were told. The principal exhibitors were Mr. C. Becker, Jas. A. Stone, and Finch & Robbins, all of Illinois; the Hutchinson brothers, of Michigan, and Geo. H. Kirkpatrick, of Indiana.

Next week we hope to speak more specifically of the exhibits and the premiums awarded.

Who Establishes the Price?—A honey-producer living some 40 miles from Chicago called on us lately and asked, "Who establishes the price of honey on the Chicago market?"

We replied, "Like Dr. Miller, we 'don't know.'"

Another bee-keeper and honey-dealer who was present, said, "Why, that's easy. The buyer who gets the honey from the commission-men, establishes the price, in nearly every instance in this market."

And he was correct to a very great extent. We verily believe that you can go into almost any of the newer honey-commission houses here and buy honey at your own figure. That is the very reason we have urged bee-keepers so strongly not to ship to strangers or new commission firms; for in so many cases they will take what they can get for the honey, deduct their commission and all other charges, and remit the balance to the shipper. And often that "balance" is quite a big surprise, on account of the small amount of cash which it represents.

For instance, just last week the honey-producer referred to first in this letter, called on a new honey-commission firm here, and bought only a single 12-pound case of finest comb honey for 11½ cents per pound. Yet that same firm was quoting to bee-keepers, privately, 15½ to 16½ cents!

The more we think about this subject, the nearer we come

to believing with Mr. Abbott, that the commission business is wrong in principle. It would be better all around if all such transactions were done upon a strictly *cash* basis. We don't want any commission business in ours when it comes to honey. We prefer to buy and sell for cash. Then there is no possible chance for trouble, if everything is bought and sold by sample. Must be equal to sample, or no sale.

The Dripless Shipping-Case, which has been lately advertised is a splendid thing for shipping comb honey. In Cleanings for Sept. 15 it was illustrated, and described as follows:

"The no-drip shipping-case is the same as any other case, only a trifle deeper. With each case is sent along a sheet of paper a little larger than the inside dimensions of the case. This is folded up into a paper tray, is then inserted, and strips laid in ¼ inches from center to center, and nailed.

"Perhaps some may ask, 'But why these strips?' Why not set the sections right down on the paper tray itself?' Did you ever notice that, when sections get to dripping, and stand upon a flat surface, how those sections will stick and hang to the surface? The little film of honey that enters between the surface and the bottom of the sections seems to act just like so much glue. To remedy this, the sections should be set up a little on cleats or strips of wood thick enough to raise them up anywhere from ⅛ to 3/16 from the paper tray. Now, then, if any drip runs down it runs on to the paper tray, and does not come in contact with the sections, except that it may touch where the corners of said sections rest on the cleats.

"Ever since these shipping-cases have been sent out they have received the hearty approval of bee-keepers and commission-men. The idea is old, and has been in use for a number of years. It was originated, I believe, by that prince of American bee-keepers—Capt. J. E. Hetherington, of New York State—the man who has the reputation of owning and operation the largest number of colonies of any one bee-keeper in the world. One of these cases was sent to us by a friend of the Captain's two or three years ago. I knew at the time it was a good thing, but neglected to bring it before our readers."

Terrill Bros.—A Commission Firm on South Water Street—seem to be in a fair way to get their just deserts for alleged swindling transactions that it is reported they have been guilty of. In the daily Chicago Tribune for Saturday, Sept. 26, appeared an account of the result of some detective work, which began with these words in bold-face letters as a heading:

"On A. S. Terrill's trail. Evidence of peculiar commission transactions in hand. Detective Eddy says he is prepared to institute court proceedings which will result in conviction of fraudulent dealings. Names of firms which have received consignments and then disappeared. List of victims said to be large."

Then came the following paragraphs detailing the matters above referred to:

Detective E. B. Eddy says he has in hand sufficient evidence to convict A. S. Terrill, who has a record in South Water street commission circles, of fraudulent dealings.

The United States Express Company recently took up the case of Terrill, whose career has been referred to frequently in the Tribune, and put Detective Eddy at work to unravel the complicated situation of affairs which is said to have cost farmers of the West thousands of dollars in the last few years. Mr. Eddy says he will institute proceedings in court at once.

A. S. Terrill has been known as the head of half a dozen concerns which were held in bad odor by South Water street merchants. The different firms which he organized, it is said, sent agents throughout the country to solicit shipments of produce. As an inducement prices were offered a few cents above the market, and all kinds of favorable conditions were pictured. When the shipments were handled the consignee often failed to receive his money, it is said, and when he came

to Chicago to see about it, he would have all kinds of trouble in locating the responsible parties.

These different concerns were broken up time and again, but only to appear under new names and repeat the tricks of the former firm.

The master mind behind the scenes was said to have been Terrill. The headquarters were at No. 198 South Water street, with an office for Terrill himself in the Unity Building. At different times the business was conducted under the firm names of Terrill Bros.; Klinger, Helm & Co.; Lawrence Produce Co.; E. V. McConkey & Co.; W. B. Paine; and George T. Wheadon & Co.

The law offices of the city are full of complaints and unpaid bills which A. S. and W. V. Terrill, and McConkey, are to be asked to account for.

Mr. Eddy's office was visited by a large number of victims or their representatives yesterday, and he has a large number of claims which he is preparing to collect if possible.

There are hundreds of these complaints which have been accumulating for several years, and as many as possible of them will be brought forward. One of the first results of the hunt by Eddy for the head of the concerns was a personal encounter with Terrill, in which the latter, it is said, threatened to kill the detective.

We might say for the information of our readers, that when C. R. Horrie was first known to us, he was a member of the firm of Horrie & McCoukey—the same E. V. McConkey referred to in the above. Shortly after, Horrie apparently started for himself under the name of C. R. Horrie & Co.; McConkey evidently did the same—with doubtless the Terrills backing both firms.

We have been told that Horrie and also McConkey were previously employees of Terrill Bros.

The George T. Wheadon & Co., mentioned in the Tribune's account (and who we also understand is an employee of Terrill Bros.), is the same concern that advertised in the September Bee-Keepers' Review, and that has been flooding bee-keepers with circular letters soliciting shipments of honey, quoting, as mentioned by the Tribune, "a few cents above the market," and picturing "all kinds of favorable conditions."

But we don't think that any of our readers will hereafter be caught by strange commission firms soliciting their honey, or by strangers traveling through the country offering to buy up their honey for such firms. Surely, we have given sufficient warning "along this line."

A Sample of Extracted Honey has been sent us by Mr. J. W. Stilson, of Osego, Wis., which he says has been shipped there for sale. He desires our opinion of the honey. So far as we are able to judge by the taste, we should say it is a good quality of glucose flavored with basswood honey. Of course, we may be wrong, and would not say positively. Best way is not to buy any large quantity of honey from strangers. You will see on page 652 we are offering extracted honey, and we guarantee its purity. We know from whom we buy honey, and so we do not hesitate to stand back of it.

Push the Daily Use of Honey.—One of Dr. Miller's straws in Gleanings reads thus:

"If all the cake and all the cooked sweets were utterly banished from the table, and Nature's own sweet—honey—substituted therefor, I believe it would add greatly to the health, happiness, and longevity of the Nation."

It seems to us that bee-keepers have been too long bending all their energies toward a greater production of honey, instead of spending a part of their effort in extending its use. Ten times as much honey as is now consumed should be used on our tables as a daily food.

Prof. Cook gives an exceedingly interesting article, on page 641, on this very subject. It will repay a careful reading.

It will not do to cease telling the great sweet-loving public about the special merits of honey. Information concerning

its value as a *food* must be continually kept before the multitude. The trouble is, so many have come to consider honey mainly as a medicine, and use it only in medicinal quantities. This is all wrong. The general public should be informed that if honey were used more regularly as a food, there would be less need of thinking of any kind of medicines.

Last week we received the following from Dr. Gallup, of Santa Ana, Calif., which is right in line with what we have written above.

HONEY AS FOOD AND MEDICINE.

I think that I have never given my views on the above question to the readers of the American Bee Journal, so here goes:

Honey passes directly into the circulation from the stomach, without any digestion; therefore, it is a perfect food, and if one eats too much at any one time it acts as a gentle laxative, and never leaves any irritation behind, like drug irritants.

Of course, some people cannot eat honey, as it creates distress, cramps, etc., in the stomach, but such people have diseased stomachs, caused by taking poisonous drugs, and irritating the ganglionic nerves that supply the gastric juices. The pneumogastric and ganglionic nerves are always inflamed or congested in all cases of dyspepsia or diseased stomachs. Those nerves can always be regulated and put in a normal condition *in time* by proper manipulation with the hands, and never with poisonous drugs. Honey never injures a normal stomach.

Now for creating a home market for honey: Myself and three little children are on our fourth 60-pound can of honey since December, 1895, and it is now September, 1896. The children have free and unlimited access to the honey at all times, and they are ready for their bread and honey at every meal in the year, and healthier, more wiry, tough little chaps you cannot scare up. Right here is a home demand for honey. Hurrah for our side!

DR. E. GALLUP.

Now, what can be done to get people interested in a greater use of honey? So far, we believe there is nothing superior to Mr. Newman's little pamphlet, entitled, "Honey as Food and Medicine." One of these should be in every home, and its reading and study should be urged. Most people are not fools. They know a good thing especially when they *taste* it. Honey touches the spot. And bee-keepers should see to it that plenty of it is found in every pantry of the land.

In order that every honey-producer may give the pamphlet—"Honey as Food and Medicine"—a trial, in helping to create a greater home demand for honey, we will mail 25 copies for 65 cents; 50 copies for \$1.00; or 100 copies for \$1.50. You can write your name and address on them, or put it on with a rubber stamp.

Now is the time to begin to distribute literature on the use of honey—as cooler weather is just coming on.

Honey Recipes.—The Ladies' Home Journal is widely known as a superior house-keeper's periodical, and really ought to be in every home. In a recent issue it published these recipes, which name honey as the principal ingredient:

HONEY-COOKIES.—One quart of honey mixed with half a pound of white sugar, half a pound of butter, and the juice of two lemons. Stir this mixture very hard, then mix in gradually flour enough to make a stiff paste. Cut into round cakes and bake in buttered pans.

HONEY GINGER-SNAPS.—One pint of honey, three-quarters of a pound of butter, two tea-spoonful of ginger. Boil together for a few minutes, and, when nearly cold, sift in flour until it is stiff enough to roll. Cut in small cakes and bake quickly.

HONEY TEA-CAKE.—One cup of honey, half a cup of sour cream, two eggs, half a cup of butter, two cups of flour, scant half tea-spoonful of soda, one tea-spoonful of cream of tartar. Flour to taste.

HONEY POPCORN-BALLS.—One pint of honey. Put it in a frying-pan and boil until very thick, then stir in freshly parched corn, and mould into balls when nearly cold.

Questions AND Answers

CONDUCTED BY

DR. C. C. MILLER, MARENGO, ILL.

[Questions may be mailed to the Bee Journal, or to Dr. Miller direct.]

Leaving the Surplus Arrangement on in Winter.

I have some hives of bees with surplus boxes on, with a little honey in. They have zinc division-boards between them. If I put them in the cellar that way, would they winter as well as they would without the top hive? I have plenty of room in the cellar. The top hives are full of drawn comb, with about 10 or 12 pounds of honey in each hive. I would like to leave them on if it would be advisable. Would they winter better without the bottom-boards on?

Verona, Ont.

W. S. G.

ANSWER.—Your bees will probably winter just as well with the supers left on. Indeed, some think it a decided advantage. If all is left glued at the top, just as the bees had it, you will probably do well to leave off the bottom-boards. There is hardly any danger that you will have it too open below while in the cellar, but you can make very bad work by having it too close. In general, I should say that if the upper part of the hive is left in the cellar just as it was on the summer stand, that there should be a good deal more ventilation below, and no harm can come from leaving it entirely open.

Rearing Queens—Bees Exhibited at Fairs—Swarming.

1. Regarding rearing queens in nucleus hives, you advise rearing them in large colonies instead. How do you do it? I would like to rear a few queens for my own use, and want to keep my bees gathering honey to extract. I would like to increase by the nucleus plan. I don't object to feeding a few nuclei, if necessary.

2. I have a very nice queen and bees that I should like to exhibit at our Fair in an observatory hive, and return after an absence of 8 or 10 days. Would the bees accept them? How should I proceed?

3. Would you advise placing one 8-frame hive over another, giving the queen full sway, and three weeks before basswood bloom put on the excluder, and expect the bees to fill up with honey to extract? Would it cause swarming? The queens are good ones.

J. M. Q.

Syracuse, N. Y.

ANSWERS.—1. All that's necessary to rear one or more queens in a strong colony is to make the colony queenless, and this should be done at the time when they are getting abundant stores. Generally the time of natural swarming is perhaps the best. As you want to rear queens and increase by nuclei, keeping the old colony at work gathering honey to extract, perhaps you may accomplish it in this way:

Take from the colony two frames of brood with adhering bees, taking the queen with them, and put in an empty hive, adding two or three empty combs. A week later you will find a number of sealed queen-cells in the now queenless hive. If you care to have so many, you can make a nucleus for every sealed cell. But don't have less than two brood-combs with adhering bees in each nucleus. If you haven't so many combs as you want in this one hive, you must draw from other colonies. If you take from a colony having a laying queen, most of the bees you take will go back to their old home. So take away the queen from any colony you want to draw brood and bees from. Do this a day or so before taking the brood, and return the queen as soon as you have taken what brood you want. You can now return to the old hive the queen that you took away a week before, swapping the brood of the two. That will make quite a respectable colony with the queen, to produce for you some honey. If your work is done early enough in the season, you ought to have no great difficulty in building your nuclei up to good colonies for winter.

You will do well to get Doolittle's excellent work on queen-rearing.

2. No complicated procedure is necessary. If only eight days elapse, all that will be necessary will be to replace the frame with the bees and queen; but if you wait as long as 10 days, there is some danger that a young queen may have emerged. Better destroy all sealed queen-cells about the eighth or ninth day.

3. If I catch your meaning, you would put the excluder between the two stories. If the two stories were fairly occupied at the time of doing this, you would be pretty sure to have swarming. If the colony was not very strong, and if you put nearly all the brood in the upper story, leaving the queen below, it would work well. If the colony was strong, and the two stories well filled with brood—for a strong colony will keep 10 to 14 combs filled with brood—then your better plan will be to put the queen in a third story put under the other two, an excluder between the first and second story. In a good season you'll find the two upper stories pretty well filled, and possibly the two stories may not be enough.

What About Stingless Queens?

Will a queen live, and lay just as well, if she loses her sting?

Cedarhome, Wash.

A. P. G.

ANSWER.—I don't know. I never had any such queen that I know of, and for that matter I never heard of any. But I may give something of a guess in the case. If she lived after the loss of the sting, very likely she would lay all right. I have had a number of queens with only five legs, and they did good work. But I think the defect was from birth. If a queen should be born without a sting, I see no reason why she might not be a good layer, just as a mooly cow may be as good a milker as one with horns. Of course, much would depend upon how she lost her sting. I can hardly imagine its loss in any other way than by the act of the bee-keeper, and possibly you are contemplating unstinging a lot of queens so as to have them all laying in one hive. I think you might cut off the end of the sting without permanently injuring the queen. But if you should be successful in that respect I doubt whether more than one queen would still be left in the hive. I know it is the general belief that when two queens meet there is always a fight, and a fight to the death, rare exceptions occurring. It may not be the safest thing for me to express my private opinion, but I am skeptical as to a fight in any case between two laying queens. A virgin queen seems always ready to fight with a rival, but I never saw two laying queens fight, and I've had them caged together more than once. I suspect it's the workers that "get up sides" and kill one or other of the queens. In that case it would not help matters to have the queens stingless. Of course, I'm not sure that my view is correct.

Cubical Hive—Building Cell-Cups—Cypro-Italian Bees.

1. In what number of the American Bee Journal did the letters of two bee-keepers to you appear, describing their size of cubical hive? One bee-keeper was from Texas, and the other from Michigan, and the size of their hives were almost the same; but I can't find the number of the American Bee Journal which describes the size.

2. On July 25, I introduced an Italian queen to a colony of hybrids; a week later I opened the hive and found the queen laying, but there were about ten queen-cells built. I tore them off, but they continue to build cell-cups to this day, and the queen seems to be all right. What is the matter with them, and what shall I do?

3. Do you think a direct cross between a Cyprian queen and an Italian drone (or *vice versa*) would make a desirable strain for honey-gathering?

G. J. K.

ANSWERS.—1. I am not able at present to turn to the desired numbers, but perhaps some one else can.

2. The first possibility is a determination to swarm, but although bees seem to swarm later and more persistently than usual, it hardly seems they would keep it up from July into September. The second thought that occurs is that in some way the bees are not satisfied with the queen, and are determined to supersede her. Whether your persistently destroying their queen-cells will make them change their minds is doubtful, but it is probably the only thing that can be done.

3. Some have spoken well of such a cross, but the majority would probably prefer to leave out the Cyprian blood.

Question - Box.

In the multitude of counsellors there is safety.—Prov. 11-14.

A Swarming-Time Question.

Query 31.—In working with clipped queens, sometimes a swarm issues and clusters on a tree before returning to the hive. What is the longest time such a swarm will remain before returning? In other words, how long is it safe to let them hang without hiving before concluding that by some means there is with the swarm a queen with whole wings?—CANADA.

G. M. Doolittle—Half an hour.

Rev. M. Mahin—After an hour's delay I would try to get them back.

Chas. Dadant & Son—About half an hour ought to tell whether a queen is with them.

P. H. Elwood—Usually only a few minutes. Sometimes nearly or quite a half hour.

Mrs. L. Harrison—I never practiced clipping queens. I would not leave them more than an hour.

J. M. Hambaugh—I have never practiced clipping queens' wings, hence I am not authority on this subject.

Emerson T. Abbott—I do not know. Try it and see. No two swarms would act alike in this respect, any more than two people.

W. G. Larrabee—I have known them to hang on a tree over night, but I don't think it would be safe to leave them longer than $\frac{1}{2}$ of an hour.

Dr. J. P. H. Brown—The length of time the swarm would remain depends much upon the state of the weather—if in the sun, shade, rain, location, etc.

R. L. Taylor—I cannot say. I do not allow a swarm to remain more than 15 or 20 minutes, particularly if the cluster becomes quiet. It is seldom one remains that long.

Jas. A. Stone—I would return them as soon as possible and watch for the queen with "whole wings." Because the whole-winged queen means (if you neglect to do so) a lost swarm.

C. H. Dibbern—1. That varies a good deal for some reason or no reason. I have known them to remain over night when no queen was with them. 2. Not more than two hours.

Dr. C. C. Miller—Generally they will return in 10 or 15 minutes, not clustering at all; often they'll cluster and remain so 15 or 20 minutes, and sometimes half a day or longer.

Eugene Secor—There are times when bees so persist in swarming that they will hang all night without a queen. Not often, however. In most cases they will return inside of an hour.

Prof. A. J. Cook—They usually alight for a time and often remain clustered for a half hour or more. I mean to always be sure that there can be no such queen, and wait till they go back, or let them alone.

G. W. Demaree—It depends on how busy I am when the swarm is out, as to how long I would trust them to hang in the cluster. They generally return by the time I can get ready for them, and sometimes a little before I am ready to

NOW WE HAVE IT! GLEASON'S HORSE-BOOK!

The Only Complete and Authorized Work
by America's King of Horse-Trainers,
PROF. OSCAR R. GLEASON,

Renowned throughout America and recognized by the United States Government as the most expert and successful horseman of the age. The whole work comprises History, Breeding, Training, Breaking, Buying, Feeding, Grooming, Shoeling, Doctoring, Telling Age, and General Care of the Horse.

You will know all
about a horse
after you
have
read
it.

No one can fool you
on the age of a
horse after
you have
read
it.

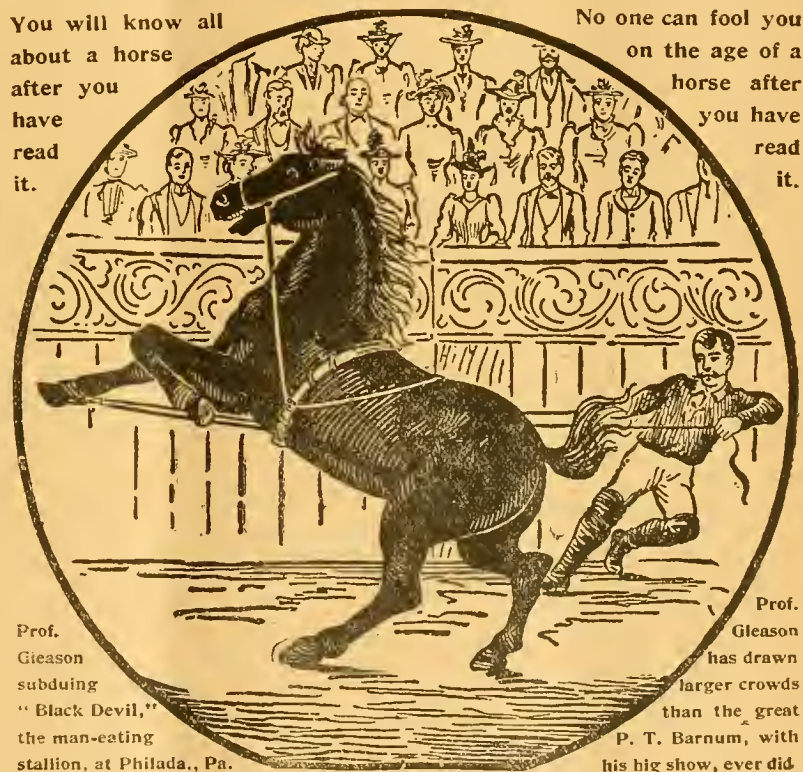

Prof. Gleason subduing "Black Devil," the man-eating stallion, at Philada., Pa.

Prof. Gleason has drawn larger crowds than the great P. T. Barnum, with his big show, ever did

416 Octavo Pages—173 Striking Illustrations.

Produced under the direction of the U. S. Government Veterinary Surgeon.

In this book Prof. Gleason has given to the world for the first time his most wonderful methods of training and treating horses

100,000 SOLD AT \$3.00 EACH.

But we have arranged to supply a limited number of copies to our subscribers absolutely free. First come, first served.

Here are Our Offers of this Great Book.

Regardless of the fact that thousands upon thousands of these books in cloth binding have been sold at \$3.00 each, we are enabled to, and will for a limited period, send a heavy-paper-bound copy FREE as a premium to our present regular subscribers for sending us **ONE NEW Subscriber** to the Bee Journal for a year at \$1.00; or we will mail the book and the Bee Journal for a year to any one sending us \$1.60. Address,

GEORGE W. YORK & CO.,

118 Michigan Street,

CHICAGO, ILL.

accommodate them. But bees do not act uniformly, and when they "settle" without the queen, and sulk too long, say 15 or 20 minutes, I take them in for fear some sort of queen may have fallen in with the swarm.

J. A. Green—I think I have known them to remain clustered for two hours under such circumstances. As there is always a chance that they may have a queen with them, I would advise hiving them if they do not return inside of half an hour.

Wm. McEvoy—Yes, the swarms sometimes cluster on a tree when they have no queen with them, but such swarms often return in less than five minutes. If the bees remain very quiet for five minutes after they have clustered, you would better hive them, as there will be a queen with them 19 times out of 20.

J. E. Pond—I have had several swarms alight and then go back again, usually from 20 minutes to an hour. In one case where the swarm left without the queen to my certain knowledge, it was about one-half hour before they returned. This is the only case in which I *knew* the queen did not alight with the swarm.

Mrs. J. N. Heater—They rarely cluster at all unless a queen is with them. For several years I have practiced placing a tumbler over the queen on the alighting-board when a swarm issues, and never but once or twice have known them to attempt to cluster without her. When the queen goes with the swarm, so much depends upon circumstances that the length of time they will remain clustered varies indefinitely.

E. France—I have seen them stay two hours. If you want to hive them, pick up the queen, put her in a cage, put the cage with the swarm if the swarm can be reached; if you cannot reach the swarm, move the old colony away, then put the hive you want them in on the old stand, with the frames, and place the queen in the cage, and the swarm will soon come to her; then liberate the queen, and give them a frame of young brood.

Queens and Queen-Rearing.

If you want to know how to have queens fertilized in upper stories while the old queen is still laying below; how you may safely introduce any queen, at any time of the year when bees can fly; all about the different races of bees; all about shipping queens, queen-cages, candy for queen-cages, etc.; all about forming nuclei, multiplying or uniting bees, or weak colonies, etc.; or, in fact, everything about the queen-business which you may want to know—send for Doolittle's "Scientific Queen-Rearing"—a book of over 170 pages, which is as interesting as a story. Here are some good offers of this book:

Bound in cloth, postpaid, \$1.00; or clubbed with the BEE JOURNAL for one year—both for only \$1.75; or given free as a premium for sending us three new subscribers to the BEE JOURNAL for a year at \$1.00 each.

READERS of this Journal who write to any of our advertisers, either in ordering, or asking about the Goods offered, will please state that they saw the Advertisement in this paper.

THE "NOVELTY" POCKET-KNIFE!

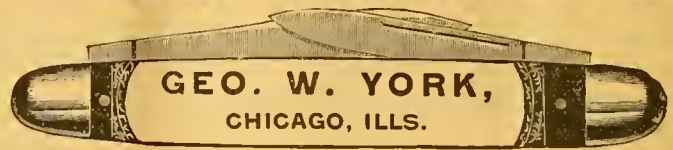

Your Name on the Knife.—When ordering, be sure to say just what Name and Address you wish put on the Knife.

The NOVELTY KNIFE is indeed a novelty. The novelty lies in the handle. It is made beautifully of indestructible celluloid, which is as transparent as glass. Underneath the celluloid, on one side of the handle is placed an AMERICAN BEE JOURNAL reminder, and on the other side, name and residence of the Subscriber.

The material entering into this celebrated knife is of the very best quality; the blades are handforged out of the very finest English razor-steel, and we warrant every blade. The bolsters are made of German silver, and will never rust or corrode. The rivets are hardened German silver wire; the linings are plate brass; the back springs of Sheffield spring steel, and the finish of handle as described above. It will last a lifetime, with proper usage.

Why purchase the Novelty Knife? In case a good knife is lost, the chances are, the owner will never recover it; but if the Novelty is lost, having name and address of owner, the finder will return it; otherwise to try to destroy the name and address, would destroy the knife. If traveling, and you meet with a serious accident, and are so fortunate as to have one of the Novelties, your pocket KNIFE will serve as an identifier; and in case of death, your relatives will at once be apprised of the accident.

How appropriate this knife is for a Christmas, New Year or birthday present! What more lasting memento could a mother give to a son, a wife to a husband, a sister to a brother, a lady to a gentleman, or vice versa, a son to a mother, a husband to a wife, a brother to a sister or a gentleman to a lady—the knife having the name of the recipient on one side?

The accompanying cut gives a faint idea, but cannot fully convey an exact representation of this beautiful knife, as the "Novelty" must be seen to be appreciated.

How to Get this Valuable Knife.—We send it postpaid, for \$1.00, or give it as a Premium to the one sending us three new Subscribers to the BEE JOURNAL (with \$3.00), and we will also send to each new name a copy of the Premium Edition of the book "Bees and Honey." We club the Novelty Knife with the BEE JOURNAL for one year, both for \$1.90.

Any Name and Address Put on the Knife.

GEORGE W. YORK & CO.,
CHICAGO, ILLS.

Allow about two weeks for your order to be filled.

Extracted Honey For Sale!

We can furnish **Basswood** Extracted Honey, in 60-pound tin cans, on board cars in Chicago, at these prices: 1 can, in a case, 8 cents per pound; 2 cans in one case, 7½ cents; 4 cans (2 cases) or more, 7¼ cents; or in kegs holding about 275 lbs., net, at 7 cents. Cash must accompany each order.

A sample of the honey will be mailed to an intending purchaser, for 10 cents, to cover postage, packing, etc. We guarantee purity, and what we ship will be equal to sample.

Now it seems to us here is a splendid chance for any bee-keeper to supply his home demand after his own crop is all sold. Or, why not begin now to create a local honey-trade? Order one 60-pound can first, and start out among your neighbors and friends, and see what you can do. You ought to get at least 15 cents per pound in 5-pound lots, or 50 cents for 3 pounds. Some may be able to do even better than that, though we think that enough ought to be sold at these prices to make a fairly paying business out of it. Give it a good trial. Push it. It may grow into a nice winter's work for you.

GEORGE W. YORK & CO., 118 Michigan Street, CHICAGO, ILL.

That Queen-Clipping Device Free!

Works Like a Charm.

The Monette Queen-Clipping Device WORKS LIKE A CHARM. With it I have clipped 30 queens, all in one day, when examining my bees. WM. STOLLEY, Grand Island, Nebr.

Couldn't Do Without It.

I have clipped 19 queens, and must say the Monette Queen-Clipping Device is by far the best invention ever made, and will be welcome to many bee-keepers as it was to me. I could not do without one now.

DR. GEO. LACKE, Newburgh, Ind.

PLEASE READ THIS OFFER TO PRESENT SUBSCRIBERS:

Send us just one new name for the American Bee Journal a year (with \$1.00), and we will mail you the Queen-Clipping Device FREE of charge. Or, the Queen-Clipping Device will be sent postpaid for 30 cts. But why not get it as a Premium by the above offer? You can't earn 30 cts. any easier. Almost every bee-keeper will want this Device. See page 130 (Feb. 27) for full description of it. Complete directions accompany each one sent out. It is a most ingenious and useful article. Address,

GEORGE W. YORK & CO., 118 Michigan St., Chicago, Ill.

General Items.

Illinois State Members' Reports.

The four questions ordered sent out by the Secretary of the Illinois State Bee-Keepers' Association to its members, were mailed on Sept. 15. The questions and answers thereto are as follows:

1. How many colonies have you?
2. What are the prospects for a honey crop?
3. How much honey gathered to date?
4. Is the honey gathered No. 1 or not?

Peter Blunier, of Roanoke—1, 100 now; spring count, 54. 2, Honey crop is at an end for this season. 3, About 1,600 pounds, and about as much more on the bives yet. 4, Most of it is No. 1; some must be classed as No. 2.

W. B. Blume, of Norwood Park—1, 36, spring count; now 78. 2, Not very good. 3, About 2,000 pounds. 4, Half No. 1: the balance a mixed grade.

F. X. Arnold, of Deer Plain—1, 139. 2, Nix; it's all over. 3, Can't tell; a little more than the bees need for winter. 4, Heart's-ease and Spauish-needle.

C. Becker, of Pleasant Plain—1, 50. 2, Fair since Sept. 1. 3, About 500 pounds surplus. 4, No. 1 for fall honey, but dark.

M. M. Baldrige, of St. Charles—1, 20. 2, When? Too late in the season for prospects. 3, About half a crop—not more than \$15 worth per colony. 4, Very good, being a combination of sweet clover, white clover and Alsike.

W. G. Secor, of Greenfield—1, 35. 2, No clover honey; fall flow coming in now, and will be good if the weather is favorable. 3, 20 pounds of extracted and 28 of comb; balance is on the hives; will "round up" later. 4, No. 1 smartweed and Spanish-needle.

A. I. Emmons, of Greenfield—1, 40. 2, Fair for fall honey, if frost does not come too soon. 3, None taken off the hives yet. 4, From fall flowers.

Dr. C. C. Miller, of Marengo—1, About 270. 2, No prospect about it, but a pretty good reality. 3, Probably not far from 10,000 pounds of comb honey. 4, Not by a long sight. It's the nicest kind of honey.

W. C. Lyman, of Downer's Grove—1, 57. 2, Poor. 3, About 250 pounds. 4, Good.

G. W. Williams, of Mt. Sterling—1, 25. 2, Better than for six years. 3, About 800 pounds. 4, A little No. 1.

Chas. Dadant & Son, of Hamilton—1, About 320. 2, Bad. 3, A little clover; no fall crop. 4, Not very good.

J. Q. Smith, of Lincoln—1, I have reduced to 35 colonies. 2, Good for fall crop. 3, I put on 2,000 sections, and all are about sealed over; 14 colonies are building comb under the hives. 4, No. 1. It is smartweed, and very white and clear. I never had finer nor better filled sections.

A. Y. Baldwin, of DeKalb—1, 80. 2, Nothing brilliant, save a fall flow. 3, Between 1,000 and 1,200 pounds. 4, Fair for fall honey.

J. A. Green, of Ottawa—1, 110. 2, Bees are doing very well at present. If the weather continues favorable, we will



For the
Kidneys,
Liver
and
Urinary
Organs.

There is only one way by which any disease can be cured, and that is by removing the cause, whatever it may be. The great medical authorities of the day declare that nearly every disease is caused by deranged Kidneys or Liver. To restore these, therefore, is the only way by which health can be secured. Here is where

Warners
Safe Cure

has achieved its great reputation. It

ACTS DIRECTLY UPON THE KIDNEYS AND LIVER

and by placing them in a healthy condition, drives disease and pain from the system.

Large bottle or new style smaller one, at your druggists. Its reputation—"Twenty years of success," in four continents. Warner's Safe Cure Co., London, Rochester, Frankfort, Melbourne, Toronto.

Mention the American Bee Journal.

RAIL ROAD LANDS

For Sale at Low Prices and on Easy Terms.

The Illinois Central Railroad Company offers for sale on easy terms and at low prices. 150,000 acres of choice fruit, gardening, farm and grazing lands located in

SOUTHERN ILLINOIS.

They are also largely interested in, and call especial attention to the 600,000 acres of land in the famous

YAZOO VALLEY OF MISSISSIPPI

lying along and owned by the Yazoo & Mississippi Valley Railroad Company, and which that company offers at low prices and on long terms. Special inducements and facilities offered to go and examine these lands, both in Southern Illinois and in the "Yazoo Valley." Miss. For further description, map, and any information, address or call upon E. P. SKENE, Land Commissioner, No. 1 Park Row, Chicago, Ill. 33D6t

Mention the American Bee Journal.

Bee-Keeper's Guide—see page 654.

have a good crop. 3, About 3,000 pounds. 4, Some honey-dew; otherwise No. 1.

Geo. Thompson, of Geneva—1, 16. 2, Not very good. 3, Not over 300 pounds. 4, Honey dark, having no white clover.

S. H. Herrick, of Rockford—1, 20. 3, 225 pounds. Bees are now storing surplus from new crop of white clover and second blossoming of Alsike. 4, 175 pounds No. 1; 50 pounds not.

Elias Robinson, of Carmi—1, 60. 2, Not to exceed half a crop. 3, About 400 pounds. 4, 2nd in quality.

W. T. Talbott, of Farmingdale—1, 20. 2, None. 3, About 20 pounds. 4, No. 2 grade.

A. P. Raught, of Volo—1, 11. 3, 370 pounds. 4, 275 pounds white clover, and the rest buckwheat.

C. Schrier, of Peotone—1, 19. 2, Very good. 3, 900 pounds, and more coming. 4, No. 1.

S. N. Black, of Clayton—1, 17. 2, Will get no honey. 3, No surplus.

John A. Crutchfield, of Broadwell—1, 10. 2, Good. 3, 100 pounds. 4, No. 1.

R. Miller, of Compton—1, 100. 3, Only half a crop this year. 4, No. 1.

E. West, of Channahon—1, 45. 2, Poor. 3, About 800 pounds. Haven't taken it off yet. 4, Not No. 1; dark in color, and strong in flavor.

Fraek Ernst, of Farmingdale—1, 10. 2, Very poor. 3, None.

E. F. Schaper, of Chesterton, Ind.—1, 60. 2, Poor. 3, 150 pounds extracted; probably will extract 500 pounds more. 4, Good light amber.

J. A. Roorda, of DeMotte, Ind.—1, 80 colonies, spring count, increased to 101. 2, Good. 3, About 8,000 pounds of comb honey, and 500 pounds of extracted. 4, Amber.

The above reports are all so far heard from.
JAS. A. STONE, Sec.

A Report from Tennessee.

Bees have done very well so far this year. Our honey here in East Tennessee is gathered from the poplar and basswood, first crop, and from the golden-rod and white aster for fall crop. Bees are now at work on the golden-rod, and are now doing very well. We find comb honey the best to produce for the market, and it leaves the bees in better condition for winter than by extracting. I have run an apiary for 20 years, and I always find the American Bee Journal to be very good. My crop of honey this year was 2,000 pounds.

G. D. HAWK.

Childress, Tenn., Sept. 18.

Half a Crop of Honey.

Bees did very well in this part of the country up to the first of August, but since then they have done nothing. There is just about half a crop, so I would say that it is not advisable for Horrie & Co. to send Mr. Dingman here to buy honey this year, as the crop is so light that it would not pay him. He did well (?) here last year, but I think it will not pay him to come this year, and so I advise him to stay at home.

Our southern Minnesota bee-keepers' convention closed yesterday; we had a two-days' session, and a good time gen-

PROF. A. J. COOK'S BOOK FREE!

The Bee-Keeper's Guide

OR

MANUAL OF THE APIARY.

This 15th and latest edition of Prof. Cook's magnificent book of 460 pages, in neat and substantial cloth binding, we propose to give away to our present subscribers, for the work of getting new subscribers for the American Bee Journal.

A description of the book here is quite unnecessary—it is simply the most complete scientific and practical bee-book published to-day. Fully illustrated, and all written in the most fascinating style. The author is also too well-known to the whole bee-world to require any introduction. No bee-keeper is fully equipped, or his library complete, without "THE BEE-KEEPER'S GUIDE."

GEORGE W. YORK & CO., 118 Mich. St., CHICAGO, ILL.

✦ MONEY SAVED IS MONEY GAINED. ✦

THE ROYAL UNION

Life Insurance Company

DES MOINES, IOWA.

The Iowa Policy

Is one that definitely promises to keep an accurate account with you; credit your premiums and interest, charge the actual expense and mortality cost, and hold the remaining funds subject to your order.

Agents Wanted.

JOHN B. KING, GENERAL AGENT,
Suite 513 First Nat'l Bank Bld'g,
20A1f CHICAGO, ILL.
Mention the American Bee Journal.

IF YOU WANT THE

BEE-BOOK

That covers the whole Apicultural Field more completely than any other published, send \$1.25 to Prof. A. J. Cook, Claremont, Calif., for his

Bee-Keeper's Guide.

Liberal Discounts to the Trade.

DUQUESNE COLLEGE!

PENN AVE. AND EIGHTH ST.

PITTSBURG, PA.

Thorough Courses — Classical, Scientific, Normal, English, Commercial, Preparatory, and Ladies Literary. Efficient and experienced instructors. Day and Night sessions.

Send for Catalog.

Mention the American Bee Journal.

Sweet Clover 1/2 Canada.

At the following prices:

5 lbs.	10 lbs.	25 lbs.	50 lbs.
\$1.00	\$1.60	\$3.75	\$7.25.

Also a quantity of Motherwort and Catnip seed. Prices on application.

EGGS for Hatching. Buff Leghorns, Indian Games, & Light Brahmas. Choice Birds. A breeder for 30 years. Prices on application

JOHN McARTHUR,

881 Yonge Street, - TORONTO, ONT.
15A1f Mention the American Bee Journal.

READERS of this Journal who write to any of our advertisers, either in ordering, or asking about the Goods offered, will please state that they saw the Advertisement in this paper.

Given For 2 New Subscribers.

The following offer is made to PRESENT subscribers only, and no premium is also given to the two new subscribers—simply the Bee Journal for one year:

Send us Two New Subscribers to the Bee Journal (with \$2.00), and we will mail you a copy of Prof. Cook's book FREE as a premium. Prof. Cook's book alone sent for \$1.25, or we club it with the Bee Journal for a year—both together for only \$1.75. But surely anybody can get only 2 new subscribers to the Bee Journal for a year, and thus get the book as a premium. Let everybody try for it. Will you have one?

Honey-Clovers & Buckwheat SEED FOR SALE.

We have made arrangements so that we can furnish seed of several of the Clovers and Japanese Buckwheat, by freight or express, at the following prices, cash with order

	5lb	10lb	25lb	50lb
Alsike Clover	\$.70	\$1.25	\$3.00	\$5.75
Sweet Clover75	1.40	3.25	6.00
White Clover.....	1.25	2.00	4.50	8.00
Alfalfa Clover.....	.65	1.10	2.70	5.00
Orimison Clover....	.55	.90	2.00	3.50
Jap. Buckwheat....	.20	.35	.90	1.25

Prices subject to market changes.

Add 25 cents to your order, for cartage, if wanted by freight.

Your orders are solicited.

GEORGE W. YORK & CO.,
CHICAGO, ILLS.

Mention the American Bee Journal.

A Bargain—EARLY QUEENS.

119 Colonies Italian Bees in Chaff Hives: two acres land; good house; excellent well.

Early Queens—Tested, \$1.00; Untested, 50c. Sent by return mail.

E. L. CARRINGTON,

16A1f PETTUS, Bee Co., TEX.
Reference—1st National Bank of Beeville.

Mention the American Bee Journal.

BEGINNERS.

Beginners should have a copy of the Amateur Bee-Keeper, a 70-page book by Prof. J. W. Rouse. Price 25 cents; if sent by mail, 28c. The little book and the Progressive Bee-Keeper (a live, progressive 28-page monthly journal) one year, 65c. Address any first-class dealer, or

LEAHY MFG. CO., Higginsville, Mo.

WHEN ANSWERING THIS ADVERTISEMENT, MENTION THIS JOURNAL.

California

If you care to know of its Fruits, Flowers Climate or Resources, send for a Sample Copy of California's Favorite Paper—

The Pacific Rural Press

The leading Horticultural and Agricultural paper of the Pacific Coast. Published weekly, handsomely illustrated, \$2.00 per annum. Sample Copy Free.

PACIFIC RURAL PRESS,
220 Market St., - SAN FRANCISCO, CAL.

70 Colonies of Bees for \$100.

This offer will hold until October 10.

William Iden, Elna Green, Inc
Mention the American Bee Journal. 39A3t

erally. Reports showed about half a crop this year, except in the northern part of the State. We had a good meeting, and an entertainment given us in the evening after the first day by the ladies of Winona city, was very much enjoyed.

E. B. HUFFMANN.
Winona, Minn., Sept. 26.

Changing the Stock, Etc.

One man here was telling my folks a new way to extract honey. He simply sets a pan under the hive (they are box-hives), and catches the honey that runs out on a hot day.

On page 599, Mrs. I. J. has a colony of bees that won't work. One of my neighbors had a swarm of common bees that acted the same way, so I put some of the comb into two frames, gave them a new queen, carried the old hive off about 12 rods, covered it up with a sheet, put the new hive in the place the old one was moved from, and the bees went right to work. This was on July 25, and to-day that hive is full of Albino bees, and all 10 frames are full of comb and honey. It is new blood that such bees need.

I had 5 colonies last spring, and now have 15. I use 8 and 10 frame hives, and have 300 pounds of comb honey. I could sell 1,000 pounds if I could produce it, but honey-dew would not sell at any price.

I do not know how I could get along without the Bee Journal and Gleanings.

C. G. ASCHA.

Hinsdale, Mass., Sept. 21.

A Correction—Swarming.

I wish to make a little correction of my letter on page 588, where it refers to bees that are swarmers. It makes me say, "In some instances I have had swarms from young swarms, which had not taken place before with my bees." It should read: "In several instances this season I have had swarms from young swarms' swarms, which had not taken place before with my bees." It is not an uncommon thing to have young swarms cast a swarm with my bees, for they do that almost every season, but when a young swarm's swarm cast a swarm, it is rather remarkable, as far as I know.

Here is an instance concerning one swarm, and I gave some attention to the matter: An old colony swarmed quite early; in fact, they sent out three swarms, and in buckwheat time cast another with a young queen. This old colony's first swarm cast two swarms, and their first swarm cast two more. That is an increase of eight swarms by natural swarming. The old colony here-in referred to, after sending out the three swarms, filled two cases of 18 sections each, with white honey, and another set of the same in buckwheat time. Their first colony filled two, and their first swarm filled two sets also. The first swarm of the fourth generation has a set nearly filled. In fact, there are three sets of 18 sections each on the old swarm and its increase; but for all this my honey crop is light, compared to some of the bee-men. H. F. NEWTON.

Whitney's Crossing, N. Y., Sept. 21.

See the premium offer on page 651!

HONEY and BEESWAX

MARKET QUOTATIONS.

The following rules for grading honey were adopted by the North American Bee-Keepers' Association, and, so far as possible, quotations are made according to these rules:

FANCY.—All sections to be well filled; combs straight, of even thickness, and firmly attached to all four sides; both wood and comb unsoiled by travel-stain, or otherwise; all the cells sealed except the row of cells next the wood.

No. 1.—All sections well filled, but combs uneven or crooked, detached at the bottom, or with but few cells unsealed; both wood and comb unsoiled by travel-stain or otherwise.

In addition to this the honey is to be classified according to color, using the terms white, amber and dark. That is, there will be "fancy white," "No. 1 dark," etc.

Chicago, Ill., Sept. 30.—Fancy white, 13c.; No. 1, 12c.; fancy amber, 9@11c.; No. 1, 8@9c.; fancy dark, 8@10c.; No. 1, 8c. Extracted, white, 5@7c.; amber, 5@6c.; dark, 4½@5c. Beeswax, 24@25c.

The sales of best grades of comb honey are now assuming more volume, and most sales are at 12, 12½, and 13c. All of the shipments that show care in preparation for transportation are arriving in good order. The market is also bare of dark comb honey, and there is a demand for it which anyone having a supply should take advantage of by shipping now.

Philadelphia, Pa., Sept. 30.—Extracted, white, 8-10c.; amber, 4-5c.; dark, 3-4c. Beeswax, 25c.

No new comb in this market yet. Old comb cleaned out.

Detroit, Mich., Sept. 30.—No. 1 white, 12-12½c.; fancy amber, 10-11c.; No. 1 amber, 9-10c.; fancy dark, 8-9c. Extracted, white, 5½-6c.; amber, 5-5½c.; dark, 4-5c. Beeswax, 24-25c.

Indianapolis, Ind., Oct. 3.—Fancy white, 14-15c.; No. 1 white, 12-13c. Extracted, white, 6-7c. Beeswax, 22-25c.

Demand is fair for grades quoted, but no demand for inferior grades.

St. Louis, Mo., Sept. 30.—Fancy white, 13@14c.; No. 1 white, 12@13c.; fancy amber, 11@11½c.; No. 1 amber, 10@10½c.; fancy dark, 8@9c.; No. 1 dark, 7@7½c. Extracted, white, in cans, 5c.; in barrels, 4@4½c.; amber, 3@3½c.; dark, 2½@3c. Beeswax, 19@20c.

Very little honey coming in at present, and the weather is too warm to handle to advantage if it were here.

Albany, N. Y., Sept. 30.—Fancy white, 13-14c.; No. 1, 12-13c.; fancy amber, 10-11c.; No. 1 dark, 8-9c. Extracted, white, 6-7c.; dark, 5c.

With cooler weather there is an increasing demand for comb honey, and stock is moving off freely. There is but very little demand for extracted, except fancy white put up in glass jars.

New York, N. Y., Sept. 30.—Fancy white, 13c.; No. 1, 12c.; fancy amber, 11c.; No. 1, 10c.; dark, 9c. Beeswax declining; 23@24c. s now top price.

New crop comb honey is now arriving freely. The demand is fair only, and mostly for small lots of 10 to 25 crates. Some exceptionally fine lots will probably sell for a little more. No change in extracted, with plenty of supply.

San Francisco, Calif., Sept. 23.—White comb, 10c.; amber, 7½-9c. Extracted, white, 5-5½c.; light amber, 4½-4¾c.; amber colored and candied, 3¼-4c.; dark tulle, 2¼-3c.

Not much new crop honey on market, and not likely to be the current season. At the rates prevailing, however, the demand is somewhat limited and almost wholly local. Stocks of 1895 crop in the hands of the wholesale and jobbing trade are almost exhausted. Most of the extracted of this year's yield has been forwarded East from the interior.

Beeswax, fair to choice, 23-26c. No change to note in values. For choice to select the market is moderately firm at the prevailing rates.

Milwaukee, Wis., Sept. 30.—Fancy white, 14-15c.; No. 1, 12-13c.; No. 1 amber, 8-10c. Extracted, white, 6-7c.; amber, 5-6c.; dark, 4-5c. Beeswax, 22-24c.

New crop of honey begins to come forward. The demand is very poor and quotations almost nominal. Weather is very warm and the consumption of honey is very small. Plenty of fruit, and hence the appetite is satisfied with same in preference. Later on we expect an improved demand for honey of all kinds.

Minneapolis, Minn., Sept. 30.—Fancy white, 12½c.; No. 1 white, 10@11c.; fancy amber, 9@10c.; No. 1 amber, 8@9c.; fancy dark, 7@8c.; No. 1 dark, 6-8c. Extracted, white, 5½@6½c.; amber, 5@5½c.; dark, 4@5c. Beeswax, 23@26c.

The demand for both comb and extracted is very quiet, and for the latter, nominal. The hot weather of the past week or so has checked demand for comb honey.

Cleveland, Ohio, Sept. 30.—Fancy white, 14½@15c.; No. 1 white, 12½@13c. Extracted, white, 6@7c.; amber, 4½@5½c. Beeswax, 22@25c.

There is not very much honey in our market. Selling rather slow. Demand beginning to be a little better. Think trade will be fair in this line this fall.

Kansas City, Mo., Sept. 30.—Fancy white comb, 15c.; No. 1 white, 13@14c.; fancy amber, 12-13c.; No. 1 amber, 11-12c.; fancy dark, 10-11c.; No. 1, 8-10c. Extracted, white, 6-6½c.; amber, 5-5½c.; dark, 4-4½c. Beeswax, 22-25c.

Boston, Mass., Sept. 30.—Fancy white, 14-15c.; No. 1, 12-13c.; fancy amber, 9-10c. Extracted, white, 6-7c.; amber, 5-6c. Beeswax, 25c.

Good supply of new honey, but demand is light this very hot weather.

Buffalo, N. Y., Sept. 30.—Fancy comb, 1-pound, mostly 12c., occasionally 13-14c.; No. 2, 8-10c.; No. 3, 4-7c. Extracted, 4-5c. Demand grows better as fruit decreases.

List of Honey and Beeswax Dealers.

Most of whom Quote in this Journal.

Chicago, Ills.

R. A. BURNETT & Co., 163 South Water Street.

New York, N. Y.

HILDRETH BROS. & SEGELKEN,
120 & 122 West Broadway.
CHAS. ISRAEL & BROS., 486 Canal St.

Kansas City, Mo.

C. C. CLEMOMS & Co., 423 Walnut St.

Buffalo, N. Y.

BATTERSON & Co., 167 & 169 Scott St.

Hamilton, Ills.

CHAS. DADANT & SON.

Philadelphia, Pa.

WM. A. SELSER, 10 Vine St.

Cleveland, Ohio.

WILLIAMS BROS., 80 & 82 Broadway.

St. Louis, Mo.

WESTCOTT COM. CO., 213 Market St.

Minneapolis, Minn.

S. H. HALL & Co.

Milwaukee, Wis.

A. V. BISHOP & Co.

Boston, Mass.

E. E. BLAKE & Co., 57 Chatham Street.

Detroit, Mich.

M. H. HUNT, Bell Branch, Wayne Co., Mich.

Indianapolis, Ind.

WALTER S. POWDER, 162 Massachusetts Ave.

Albany, N. Y.

CHAS. MCCULLOCH & Co., 380 Broadway.

Cincinnati, Ohio.

C. F. MUTH & SON, cor. Freeman & Central avs.

Convention Notices.

TENNESSEE.—The Southern East Tennessee Bee-Keepers' Association will hold its annual meeting at Cookson's Creek, on Oct. 10, 1896. Session will open at 9 o'clock a.m. All are invited to attend, and especially those engaged in bee-culture. W. J. COPELAND, Sec. Fetzeron, Tenn.

CONNECTICUT.—The fall meeting of the Connecticut Bee-Keepers' Association will be held at the Capitol at Hartford, on Oct. 21, 1896, at 10:30 a.m. All interested in bees and the production of honey are invited to attend this meeting. Waterbury, Conn. MRS. W. E. RILEY, Sec.

North American Bee-Keepers' Association

OFFICERS FOR 1896.

PRESIDENT—A. I. Root..... Medina, Ohio.
VICE PRES.—Wm. McEvoy..... Woodburn, Ont.
SEC.—Dr. A. B. Mason..... Sta. B. Toledo, Ohio.
TREAS.—W. Z. Hutchinson..... Flint, Mich.
Convention at Lincoln, Nebr., Oct. 7 & 8.

National Bee-Keepers' Union.

PRESIDENT—Hon. R. L. Taylor..Lapeer, Mich.
GEN'L MGR.—T. G. Newman...San Diego, Cal.

Warner's Safe Cure.—For the past half dozen years Warner's Safe Cure has not been advertised in the agricultural press, the city papers having been exclusively used. The Company manufacturing the old and reliable kidney and liver medicine have, however, come to the conclusion that the agricultural paper is read more thoroughly than the city daily, and better results can be obtained by returning to it. In this they are correct, and we hope our readers will prove it to them by reading the new advertisement of the Warner's Safe Cure Co. which will be found in another column of this paper, and acting on the advice there given.

Bee-Keepers' Photograph.—We have now on hand a limited number of excellent photographs of prominent bee-keepers—a number of pictures on one card. The likeness of 49 of them are shown on one of the photographs, and 121 on the other. We will send them, postpaid, for 30 cents each, mailing from the 121 kind first; then after they are all gone, we will send the 49 kind. So those who order first will get the most "faces" for their money. Send orders to the Bee Journal office.

Please Send Us the Names of your neighbors who keep bees, and we will send them sample copies of the BEE JOURNAL. Then please call upon them and get them to subscribe with you, and secure some of the premiums we offer.

CORRECT MANNERS: HOW TO BEHAVE IN SOCIETY

Containing clear and concise directions for correct manners and usages of polite society. Many people have been misjudged for years simply because they had neglected to perform some little polite act at the proper time; many young men and women have lost the opportunities of a life-time on account of their ignorance of some trifling customary rule of Society. Our BOOK tells all about it. 136 pages. Russia. Red Edges. Price, 75 cts.



Special Offer: We will mail this book free as a premium to any one sending us two New Subscribers to the Bee Journal for one year (with \$2.00), and also send a copy of the premium book "Bees and Honey" to each of the new subscribers; or we will club the book with the Bee Journal for a year—both for \$1.60.

Bottom Prices

**BRING US BIG TRADE.
GOOD GOODS KEEP IT.**

If you want the best supplies that can be made at a little less cost than you can buy the same goods for elsewhere, write to us for low prices. 1896 Catalogue now ready—ask for it and a free copy of **The American Bee-Keeper** (36 pages).

Address,
THE W. T. FALCONER MFG. CO.,
JAMESTOWN, N. Y.
Mention the American Bee Journal.

COMB FOUNDATION!

Wax always wanted for Cash or in Exchange for Fdn. or other Supplies. My trade is established on **Low Prices** and the merit of my **Foundation. Orders filled promptly.**

WORKING WAX INTO FDN. BY THE LB. A SPECIALTY. Wholesale prices to dealers and large consumers. Send for Prices and Samples to—**GUS DITTMER, AUGUSTA, WIS.** Reference—Augusta Bank. 1 Atf
Mention the American Bee Journal.

MUTH'S HONEY EXTRACTOR
PERFECTION
Cold-Blast Smokers,
Square Glass Honey Jars, Etc.

For Circulars, apply to **CHAS. F. MUTH & SON,** Cor. Freeman & Central Aves., Cincinnati, O. Send 10c for Practical Hints to Bee-Keepers.
Mention the American Bee Journal.



ONE MAN WITH THE UNION COMBINATION SAW
Can do the work of four men using hand tools, in Rippling, Cutting-off, Mitring, Rabbling, Grooving, Gaining, Dadoing, Edging-up, Jointing Stuff, etc. Full Line of Foot and Hand Power Machinery Sold on Trial. Catalogue Free.

SENECA FALLS MFG. CO.,
46 Water St., SENECA FALLS, N. Y.
1 Atf *Mention the American Bee Journal.*

HONEY-JARS!

1-lb. square Flint Jars, with Corks, \$4.85 per gross. Including Labels, name and address on same, \$5.10 per gross.

A Full Line of Supplies on hand.
Catalogue.
I. J. STRINGHAM,
105 Park Place. NEW YORK, N. Y.
APIARY—Glen Cove, L. I.
Mention the American Bee Journal.

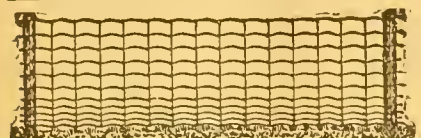

FENCES AND FERTILIZERS

It is customary to spread the plant food evenly over the field, then mix with the soil. Why not bury it all in one corner of the field? That's the way some people build "elastic" fences. When a shock strikes the Page, it don't have to wait while a boy "goes to the spring," but finds it all along the line.
PAGE WOVEN WIRE FENCE CO., Adrian, Mich.
Mention the American Bee Journal.

19th Year Dadant's Foundation 19th Year

Is still in the lead, for we use all the latest improvements, including the

NEW WEED PROCESS,

and still make the best goods. Remember that we do not use any acid to purify our beeswax, and that is why our Foundation preserves the smell of the honey and is more acceptable to the bees, than any other. It is kept for sale by

T. H. Strickler, Solomon City, Kansas.
G. K. Hubbard, Fort Wayne, Ind.
L. Hanssen, Davenport, Iowa.
C. Theilmann, Theilmanton, Minn.
E. C. Eaglesfield, Berlin, Wis.
E. T. Abbott, St. Joseph, Mo.
J. M. Jenkins, Wetumpka, Alabama
John Rey, East Saginaw, Mich.
Vickery Bros., Evansville, Ind.

The Jennie Atchley Company, Beeville, Texas.
C. F. Muth & Son, Cincinnati, Ohio
E. Kretschmer, Red Oak, Iowa.
G. B. Lewis Co., Watertown, Wis.
James Reynolds Elevator Co., Poughkeepsie, N. Y.
Louisiana Bee-Keepers' Supply Manufactory, Donaldsonville, La.
Page & Lyon, New London, Wis.
John Nebel & Son, High Hill, Mo.

and many other Dealers. All agree in saying that no goods are better than ours.

We make a specialty of **Veils and Veil Stuffs** of best quality, cotton and silk.

Langstroth on the Honey-Bee, Revised

Bee-Keepers' Supplies, Smokers, Sections, Tin Pails, etc.

Samples of Foundation and Tulle FREE with Circular. Instructions to beginners with Circular. Send us your address.

CHAS. DADANT & SON,
Mention the American Bee Journal. **HAMILTON, Hancock Co., ILL.**

See Campaign Book Offer on page 623! Better Have It!

* Extracted Honey *

Finest Quality. Basswood and Clover.
2 60-lb. cans in case 7c. per pound. 1 60-lb. can in case, 8c. per pound. A sample by mail, 10 cts. **POUDER'S Honey-Jars and Complete Line of Supplies.** Catalogue Free.
WALTER S. POUDER,
162 Mass. Avenue, INDIANAPOLIS, IND.



PATENT WIRED COMB FOUNDATION



Has No Sag in Brood-Frames
Thin Flat-Bottom Foundation
Has No Fishbone in the Surplus Honey.
Being the cleanest is usually worked the quickest of any Foundation made
J. VAN DEUSEN & SONS,
Sole Manufacturers,
Sprout Brook Montgomery Co., N. Y.

Root's Double-Walled Dovetailed Chaff Hives, and Winter-Cases for Single-Wal'ed Hives,

Have met with much success everywhere in wintering. The Double-Walled Chaff Hive is light, neat, compact, and weighs only a trifle more than the single-walled hives of the same capacity. Now is the time to lay in your stock for winter.
Send for Catalog and Prices.

THE A. I. ROOT COMPANY,

Factory and Main Office, **MEDINA, O.**

BRANCH OFFICES:

118 Michigan St., Chicago, Ill.
1024 Miss. Str., St. Paul, Minn.

Syracuse, N. Y.
Mechanic Falls, Maine.

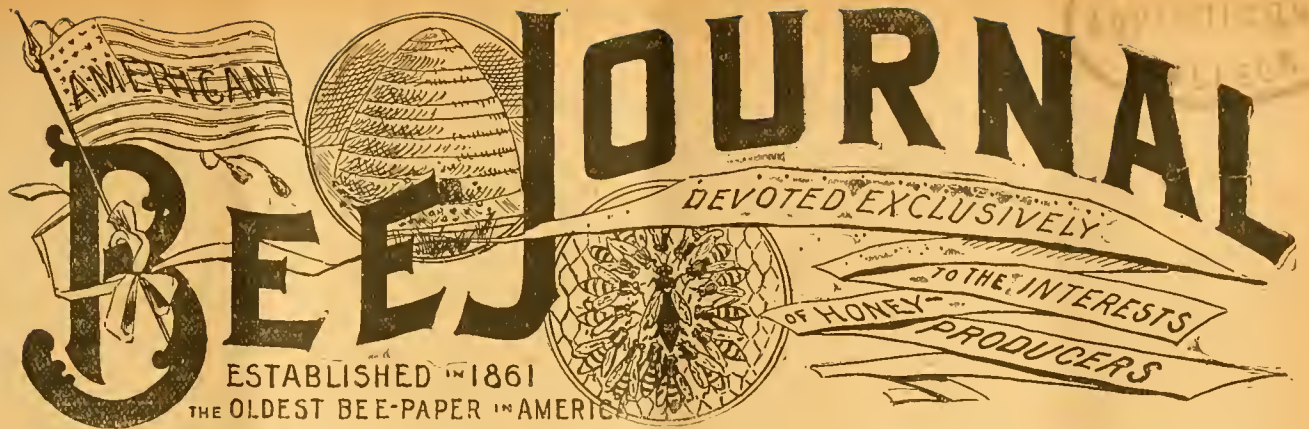

AMERICAN BEE JOURNAL

ESTABLISHED 1861
THE OLDEST BEE-PAPER IN AMERICA

DEVOTED EXCLUSIVELY
TO THE INTERESTS
OF HONEY-PRODUCERS

Published Weekly, at \$1.00 per annum.

Sample Copy sent on Application.

36th Year.

CHICAGO, ILL., OCTOBER 15, 1896.

No. 42.



Number of Bees Needed as a Queen Escort.

BY G. M. DOOLITTLE.

On page 555 is a letter from Mr. H. Galloway, the closing two sentences reading as follows:

"I think it would be a good thing for the one who sends queens, and also for the one who receives them, to have all go through safely. I would like Mr. Doolittle's opinion on the matter."

I do not suppose that all Mr. G. desired to know was, whether I agreed with his "think" or not, although quoting as I have done would lead us to draw that conclusion. I take it that he wishes to know what my opinion is on the subject of few or many bees being sent as escorts with a queen when she is sent by mail; but as I wished to notice that "think" a little, I quoted so I could be asked the question I wished asked me.

Then Mr. G. thinks it would be a good thing for one who sends queens to have them go alive. Well, that *think* agrees *exactly* with my think, and did I lose as many queens enroute as I did ten years ago, I would give up the queen-business in disgust. Ten years ago, if two-thirds of the queens went through alive, it was doing pretty well, no matter how many bees were put into a cage; for with our hard candy and water-bottles of that time, the water would leak out, moisten the candy and drown the bees, or else the bees would fail to get water from the bottle to moisten the candy, and as they could not eat it hard, they died of starvation. Thus sending queens at that time was very unsatisfactory to all concerned.

But with the advent of the *powdered sugar-honey* candy, a new era dawned upon us as regards sending queens in the mails. The uncertainty which before existed, began to narrow down to the skill of the one who made this new candy, so it was neither too soft nor too hard; the number of bees placed in the cage with the queen, according to the length of the journey, with candy in proportion to that journey, and the age of bees used, also. Where all was planned as it should be, the uncertainty was turned to a *certainty*, as far as sending queens to any part of North America is concerned. Of the hundreds of queens I have sent this year, not one has been reported dead, except during that extreme hot week in August, which was unprecedented as a universal hot wave, during

which the candy melted in some of the cages and drowned the bees.

If the loss from a queen arriving dead makes the one who ordered the queen feel badly, that one may rest assured that the reports of queens arriving dead makes the queen-breeder feel fully as much so, for it means that he is to send another queen immediately to replace her, no matter how much he is behind in orders, or how badly he is being pressed for queens. Often have I gone to full colonies, working in sections, to get queens to replace these lost ones, because I could not bear to keep those waiting whose orders were past due, on account of an unforeseen loss of queen-cells, a cold spell in which queens did not mate, or something of the kind, which made these losses fall more heavily if possible on me than they did on the one receiving the dead queen; and how any queen-breeder could have laughed at suggestions as to the cause of the loss of queens by the receiver of those arriving dead, is more than I can comprehend. I have always been glad of these suggestions, and they have been of profit to me more than once.

Why! the whole of our bee-keeping fabric has been built out of the suggestions coming from the many, far more than it has by the prominence of any one individual, or any few individuals. Then what folly to think that "I" am head and center of the whole affair. But to the main point:

"How many escort bees should accompany a queen while she is confined in a cage traveling through the mails? Well, if I were in Dr. Miller's shoes, I should feel just like saying, "I don't know." But being in Doolittle's shoes, I will tell the readers of the American Bee Journal just what I do now, during the year 1896, this doing being governed by all the experience of the past.

If the distance the queen is to go is from 600 to 800 miles, or not so great but that I can reasonably expect she will go through in three days, I use one of the small, penny postage cages, during June, July, August and September, putting 11 bees in the cage during the first and last months, unless it is warm for the time of year, and eight bees at all other times; and I never intend to send any queen with less than eight attendants at any time of year.

If the distance is greater than that named above, I generally use a large cage, or one requiring two cents postage to take it, so that I can put in more food and more bees. In this cage I put from 14 to 20 bees during June and September, according to the weather, and 12 during July and August. This would be the kind of a cage and the number of bees I would use to reach the State of Washington during those months, and were it earlier or later in the season, I should most likely use one of the foreign shipping-cages, into which I put from 30 to 40 bees as an escort for the queen.

I used to say that the hardest place in the world to get a queen through alive, was southwestern Texas, where the

queen and her escort has to undergo from two to four days' staging after a weeks' journey before, where the mail-bag is generally thrown on the stage coach to lie in the hot sun the rest of the way. The only wonder is, that bees can live at all under such circumstances; but they do, and, strange to say, have mostly gone alive for the last three or four years.

In no one thing have we made greater strides during the past, nor come nearer perfection, than we have in this business of shipping queens in the mails; and as Mr. G. well says, it has become an "important matter;" for through this has come the improvement of our bees, and a zest which has placed bee-keeping among one of the important industries of the age.

Borodino, N. Y.



Production of Comb Honey vs. Extracted.

BY HON. GEO. E. HILTON.

Perhaps there is no subject in apiculture, excepting wintering, that is worn as near threadbare as this. Comb honey is my specialty in the production of honey, and my large crop this year is a fancy article, and because it is not a staple in our markets it is a drug. Extracted honey comes nearer being a staple article than does comb, and I believe if we exert ourselves more in the introduction of extracted honey the future will see the greater portion of our honey sold in the liquid form. It costs so much less to produce it and prepare it for market, and we can produce so much more per colony that we can sell it for about half what we get for comb honey and give us the same profit.

Then it can be put to so many more uses. With a little educational effort our bakers can be induced to use it by the barrel instead of the cheap syrup they buy. There never was a "jumble" or a cooky made with molasses that equaled in flavor or richness, or that kept as well, as those made of extracted honey.

Our wives, both upon the farm and in the cities and villages, should learn that it is better for nearly all their pastries and a thousand times more wholesome than the "cooking molasses" they buy, and of which the children, whose appetites crave the sweet thing, consume. No sugarcured ham was ever so effectually cured as the ham cured in extracted honey.

I suppose tobacco will always be used (I hope not), but, if it is, here is another source where tons of the extracted honey can be used in the place of syrups now used for that purpose, and so I could continue to enumerate the uses that the extracted honey could be put to that comb honey cannot, but it needs a special effort of the parties living in close proximity to these different institutions; but the still broader field is the family or home market.

The reader knows by this time that I have more confidence in our home markets than "the markets of the world," and that I believe the American markets should be the markets of Americans. This is as true of the neighborhood, county and State as of the Nation, and the bee-keeper himself is more to blame than any one else that the tables of the masses are not supplied with this God-given, health-promoting, "nectar fit for the Gods." I think I have said before that it was one thing to produce a crop of honey and another to dispose of it successfully, and the bee-keeper who cannot sell a crop after it is produced will make a failure.

I have had some experience as a salesman, and I know of nothing that requires a more persistent effort than the introduction of extracted honey, simply because its merits are so little known, and in many localities it is still associated with the old-time "strained" honey, and I occasionally find a bee-keeper calling it by that misnomer.

Of course we must study the wants of our customers, the kind and size of package, keep the different grades of honey

distinctly by themselves, and sell each kind or quality upon its merits; by doing this we will establish a certain line of customers for a certain kind or grade of honey, and it will be surprising what a large amount can be disposed of in a comparatively small area. I believe that in ten years my sales increased ten times in my home and closely surrounding markets.

There is a 32-page pamphlet by Thomas G. Newman, entitled, "Honey as Food and Medicine," just the thing to be scattered freely for the purpose of creating a demand for extracted honey; it contains recipes for honey-cakes, cookies, puddings, foam, and uses of honey for medicine. I believe it would pay bee-keepers to give away 100 of these to every 100 pounds of extracted honey they desire to put on a new market. What would you think of your merchant, whose name never appeared in your local paper, and who never employed other means to inform his patrons of what he had and where and how he kept and sold it? Why don't we bestir ourselves and endeavor to extend and increase our business? It certainly is as legitimate as that of the grocer, the dry-goods man or the banker.

Let us read up during the coming winter, get ready for the next season, increase our production with a determination to increase our sales and profits; do this, and we will be happier, wealthier, and the community in which we live will be benefited as the result.—Michigan Farmer.

Newaygo County, Mich.



Introducing Queens—Various Methods.

BY DR. E. GALLUP.

I tried the experiment the past summer, of introducing queens according to directions accompanying the queen given by the breeder, and attached to the cage. The directions were to place the queen-cage and all, as she was received, in the hive, after making the colony queenless, and allowing the bees to liberate the queen by eating out the candy, and on no conditions to open the hive under five days.

Well, I received queens from two different breeders by the same mail, and introduced the cages according to directions. On the third morning I found dead and wounded bees in front of the hives. I got a pan of water, table-spoon, and smoker ready; opened the first hive, spooned out the ball of bees, and dropped them in the pan of water, and caged the queen. She was all right again. I opened the next hive, went through the same performance, and the last queen was so nearly dead that she only lived about two hours. I dropped the ball of bees in the pan of water to prevent the bees from stinging her before I could get her liberated, and then she might fly away before I could cage her.

I have lost queens by having them stung right before my face, trying to liberate them by smoke or other process. I have lost queens by having them fly away. I never have lost one by introducing with tobacco smoke. I once had a queen balled by introducing in the middle of the day when there were lots of bees in the field. Those returning that had escaped the smoking were the ones that did the mischief, but I discovered their trick in time to save the queen. I now introduce either in the morning or evening, when the bees are all at home. I do not smoke the queen, but roll her in honey before dropping her into the hive to prevent her from flying, and also to keep her more quiet, as a timid queen dodging about might induce the bees to attack her, when they otherwise would not. A strange queen that has been once balled is apt to be very timid.

In old box-hive times years ago I drummed out a swarm of bees, hunted out the queen, and as soon as they had discovered the loss of their queen I liberated the Italian queen in the mass of bees, and she was all right, providing the bees were filled with nectar, recently gathered; or by thoroughly

sprinkling with diluted sweet. In half or three-fourths of an hour shake the bees on a blanket in front of the hive, and let them run in the same as when hiving a swarm. I learned this kink from Mr. Wellhouser, over 50 years ago; also the introducing with tobacco smoke, the true theory of artificial increase, rearing queens, etc.

I have practiced another method of introducing, with success. For a cage I use wire with the mesh just right so that a worker can crowd through into where the queen is—I think about 3/16 mesh, but I am not now sure of the size. Bees never meddle with a queen inside of such a cage. Introduce the cage between two combs by crowding the combs together so as to hold the cage in place; stop the upper end of the cage with a cotton rag, made into a ball large enough to fill the end of the cage. Place the cage low enough so there is room for the queen to pass out below the flat cover. On the third day remove the cover of the hive *carefully*, pull out the rag from the end of the cage, and *carefully* replace the cover, and the thing is done.

In smoking with tobacco, I puff in the smoke at the entrance of the hive, then wait two or three minutes and give them another dose, etc., until they are drunk enough to behave themselves. An ugly, cross hybrid colony I have smoked until many of the bees were kicking and sprawling on the bottom-board. I have had such colonies that I could not get to accept a queen by other processes. If this is done early in the morning, or middle of the day, look out for robbers. Therefore, the evening is the best time.

An old, experienced bee-keeper can almost always introduce by some method that he has adopted, but a great many queens are lost every year by using the method recommended by the shipper, and then the receiver finds fault with the shipper, and attributes all to wrong directions, etc. Beginners are apt to be nervous and excited, and they handle their bees so as to make them excited and cross. In all my tinkering with the bees this summer, I have no cross bees. I can pass all around among the hives, and so can my little children.

By the way, my youngest boy is a perfect drone-trap. I tell him what hive to catch the drones from, and he will squat down by the side of the entrance at the time when drones are flying, and soon clean them all out. He never gets stung, and of course it is the hybrid colonies that I set him at. In examining and manipulating my bees I light the smoker (usually, not always), and have it on hand in case of a mishap. I never puff smoke into the entrance, but let the workers keep right along at work. I open the hive carefully, without jar, take out combs, and do whatever I have to do without using a veil or smoke, always being very careful never to crush a bee. My bees are pets—they are never abused, only when I use tobacco smoke in introducing queens. But they forget that insult in two or three days.

Santa Ana, Calif.



Marketing Honey to the Best Advantage.

BY L. F. ABBOTT.

A matter of considerable importance to bee-keepers is how to market their honey to best advantage. Most of the older bee-keepers can remember when there was no delay in selling what surplus honey they had to spare at a good price. The grocery-man then easily excused himself for asking a quarter of a dollar a pound for honey, even in broken combs and very dark-colored at that.

Now methods in bee-keeping and honey-production are very much changed. There is not only more honey produced, but it is put upon the market in finer condition and more attractive forms. The facilities of transportation are such that the products of Western apiaries, and the almost spontaneous crop of California's sage-bush, find their way to Eastern mar-

kets and lower the price for the Eastern bee-keeper's somewhat superior product.

But this is nothing in comparison with the evils resulting from adulteration—spurious products put up by unscrupulous vendors and palmed off upon the unsuspecting public as pure extracted honey. Large amounts of this stuff, made principally of glucose, floating a small piece of honey-comb, have been sold in all our markets. Like everything of this kind, the cheat is sooner or later found out, but instead of the real transgressors having to suffer, the honest bee-keeper who sells the pure article of honey has the fraud saddled off onto him. There is only one thing for the bee-keeper to do, viz.: produce a good article of honey and put it upon the market in nice shape, putting his name upon every package of extracted honey, and show the public that good extracted honey is truly a reality.

I have looked over the markets of some of our cities, and I find that dealers—the grocerymen—do not want this glucose stuff, and I also find that the prejudice of the public has been so aroused that dealers are slow to take hold of the genuine extracted honey and pay anything like a fair price for it. With comb honey the case is different. This speaks for itself, in a measure, and any nice, white section honey need not go begging for a market.

To hit the market—pleasing both the dealer and consumer—we must adopt a plan whereby our goods can be handled by both without breakage and leakage; be kept clean and in nice condition, and present an attractive appearance; and above all, in the case of extracted honey, that it be just what the label on the package affirms it to be. Of course every bee-keeper is desirous of obtaining a fair price for his honey. A few years ago 30 cents a pound satisfied him. After awhile 25 cents proved a satisfactory price. Of late years California and Western bee-keepers have set the price for Eastern honey-producers, at first at 20 cents a pound for comb honey, and latterly at 18 cents as the wholesale price, which is low enough for the nicest grade. Extracted honey can be afforded for somewhat less a price.

But in selling honey in either form, give honest weight. The consumer, whose palate we wish to tickle, naturally objects to paying the price of honey for glass bottles or white-wood sections. And again, if one buys a pound of honey he wants what he pays for and he is entitled to it. It is better to keep both the goods and price at a fair, honest level, than to lower both to a suspicious minimum.

In putting extracted honey upon the retail market, use some small packages. A glass package is preferable to all others. Jelly tumblers—two sizes—do very well; the main objection is their cost. The smaller sizes hold 10 ounces of honey, the larger exactly a pound. Square white glass jars—discard the amber-colored, as they discount your white honey—something like a pickle-jar, close with a cork, make a good and clean package. Such jars hold about 15 ounces of honey and, bought by the gross, cost about 1½ cents apiece, if you are fortunate as to breakage on the railroads.

Either of these make a neat and attractive package, with a colored label neatly printed with the name of the apiary and owner's name and "pure honey" on it, neatly pasted upon each. Lithographic labels I would discard. Honey is good-looking enough of itself without embellishment by printers' art.

One fault with jelly tumblers as a package for extracted honey is their liability to leak, and this may be easily remedied by running a ring of melted wax above the rim upon which the covers shut. Warm the tumbler, turn on a few drops of hot beeswax above the rim, holding the tumbler at an angle of 45°, and slowly turn it around; the wax will flow, making an even, narrow ring of wax. Done before the glasses are

filled with honey, it will be air-tight when the cover is shut down upon it.

Where one has considerable comb honey in sections to market, the plan of furnishing a small, upright show-case to the grocery men handling your honey, I have found to work well. These cases are made with three glass sides, using glass 16x30 inches, set in a cheap frame, the wood filled and varnished. These cases will cost \$2.50 to \$3.00, but soon pay their cost, as they exclude flies, dirt and dust. Upon the front pane have your name and address painted in showy letters. When the honey is sold low, replenish from time to time from your stock at home.

Honey placed upon the market in this or some such form will attract notice and inspire confidence in its genuineness by having the producer's name back of it, as well as its own truth-telling good looks. Small and medium-sized packages, neat, and above all, tight, so as not to be leaking the contents and daubing everything they come in contact with; full weights and pure quality; honey in this form will command a fair price when the same goods might go begging for sale wanting these requisites.—Ohio Farmer.



The Large vs. the Small Hive Again.

BY C. P. DADANT & SON.

The following letter, addressed to the editor of the Bee Journal, has been referred to us for reply:

MR. EDITOR:—I have been very much interested in the large and small hive question, and especially what the Dadants have had to say on the side of the large hive. I want to call your attention to an article by Chas. Dadant, on page 822, of the Bee Journal for Dec. 26, 1895. I will quote the last paragraph:

"But in our own practice, although we contract our hives, when the colony is feeble, to keep it warm, we never try to harvest any honey unless the lower story is filled to the full capacity. Here, evidently, our 8-frame bee-keeper thinks he has the advantage over us; but we do not think so, and we will tell you why in another article."

But so far Mr. Dadant has not told us "why." He has evidently forgotten. Would you please jog his memory on this point. I would very much like to know "why," and how he fills the lower story to its full capacity.

F. E. HENRY.

Mr. Henry has probably not read all of the articles written by us during the season, for we at one time stated that our reason for leaving a great deal of honey in the lower story is to enable the bees to breed plentifully in the spring. The advantage that we thus have over the bee-keeper with small hives lies in our having much better means of securing a powerful colony through the breeding of young bees at a time when their action is most needed. A colony which is stinted cannot go through the spring months with the same chances of success as one that has a plentiful supply. Let it be understood that we do not try to crowd the honey in the lower story for this purpose, but simply that if there is more than a fair supply we make no attempt to remove it from the brood-chamber in the fall. We used to extract honey from the outside combs in 10-frame Quinby hives, and after a few years we stopped this practice.

We have already told in a previous number, how we accidentally found out the difference in results between a colony that is allowed a large surplus and one which is only allowed to retain the exact amount supposed to be sufficient for winter. The thing may bear repeating. We hope it may not prove tedious to those who have remembered it.

It was some 20 years ago, before we were accustomed to use foundation in the hives as guides. We had a great deal of work, had gotten behind, and the swarming season found us unprepared. In an apiary away from home a number of colonies swarmed and were hived in hives without any guides in

the frames. The result was a lot of crooked combs built in such shape that it was impossible to remove any of the frames until the combs had been transferred, the same as if the colony was in a box-hive. This would not do for fall work, so it was put off till spring. The following spring neglect or some other cause made us leave those hives in the same condition. As a matter of course no honey had been taken from the body of these hives in the fall, since the frames could not be removed, while we had taken the usual amount of extracted honey from their neighbors, whose combs were straight in the frames. The result was that these colonies yielded the best crop.

This was continued for two or three years, and we finally came to the conclusion that it was the greater amount of stores left in them for winter which caused those bees to harvest the best crop. Further tests proved this correct, and we have always since that time left the entire lower story untouched for their winter supply. Instead of 25 pounds, as customary, we figure that our bees, when they are in right condition for winter, have an average of 40 pounds of honey. It is quite an amount, but since they harvest it themselves, and pay us pretty well when the crops are good, we believe ours is the proper policy to follow.

For the past four or five years bee-culture here has been a failure, but the clover looks beautiful now, and we hope for a fair crop in 1897.

Hamilton, Ill.



Report of the Southeastern Minnesota Convention.

BY JOS. H. BOLTON.

The Southeastern Minnesota Bee-Keepers' Association held their annual convention at Winona, Sept. 24 and 25. At the opening session there was no program; every one seemed busy getting acquainted with every one else, and judging from the spirit manifested throughout the meeting, this session was an entire success. Really, the most enjoyable part of it, or what made it so, perhaps, was that we were all farmers, and all interested in the same subjects. In the discussions which followed each paper, there was hardly one of the 50 or 60 present who did not take part.

In the afternoon, Pres. Turnbull, of La Crescent, presided and made the opening address. He referred to the present political agitation, and the fact that the "little busy bee," with its joyous hum, worked on unmindful of these things. He thought the farmers who kept bees the most happy and independent people on earth; they raised nearly everything they needed, and enjoyed luxuries beside. The excellence of the honey exhibit at the State Fair was mentioned. Mr. Turnbull referred briefly to the experience of the year, which had not been the best for honey. He hoped for a pleasant and profitable meeting.

An interesting paper upon "The Management of Bees," was then presented by Mr. W. K. Bates, of Stockton. This gave rise to much discussion, mainly upon the question of top ventilation of hives in cellar wintering. It was almost the unanimous opinion of those present that ventilation at the top was a necessity, but the methods for securing it differed greatly.

Mr. E. B. Huffman, of Homer, spoke briefly upon his experience, and exhibited a number of home-made implements for lessening even the light labor now required in our pursuit.

The evening was given over to entertainment and refreshments provided by the ladies of Winona.

The morning session of the second day was opened by a paper on "Foul Brood," by Mr. S. W. Judge, of Pickwick. Mr. Andrew Quist, of Hokah, followed with a paper on "The Nameless Bee-Disease, or So-Called Bee-Paralysis." Mr. W.

J. Stahmann, of Weaver, then gave a very interesting essay on "The New Bee-Disease, Pickled Brood, or White Fungus."

These papers excited the interest of every one present. Foul brood was given a very thorough investigation, and a committee was appointed to confer with the State Bee-Keepers' Association at their convention to be held the coming January, with the aim of securing legislative enactment to control and prevent, if possible, the spread of this contagious disease.

The last session was opened by Mr. C. F. Lang, of Wisconsin, who spoke very interestingly of his season with the bees. The question-box was opened, and queries on nearly every vital subject of apiarian management were propounded and discussed. Officers for the ensuing year were elected, being the same as last year, and an adjournment to meet at Winona next year, at a time to be fixed later, was taken.

No wish could have been more completely gratified than was the one expressed by the President at the close of his opening address, for a pleasant and profitable meeting. It was a complete success. St. Paul, Minn.



Something About Selling Honey on Commission

BY W. Z. HUTCHINSON.

Nearly all of the honey sold in the large cities is sold through the agency of commission-men, and in many instances there are mistakes, misunderstandings, and dissatisfaction. One cause for all of this trouble is the great difference in honey. There is the difference rising from the varied sources from which honey is gathered, the different methods employed by different bee-keepers in securing the crop, in packing it for market, the condition in which it reaches the market, etc. If honey could be graded as exactly as grain can be graded, much of this friction would be avoided. One trouble is, that each bee-keeper often thinks that *his* honey is first-class, and so represents it to the dealer to whom it is shipped. It sometimes turns out otherwise, and then there are disputes and trouble. The North American Bee-Keepers' Association has tried to lessen the troubles by formulating a set of rules for use in grading honey. The honey is graded according to the conditions of the combs, and then classified according to color—"white," "amber" and "dark" being the terms used. Dealers say, however, that this attempt at grading honey has produced no practical benefit.

If producers are inclined to grade their honey too high, dealers are not free from the fault of quoting too high. Of course prices are likely to fluctuate, and honey is sometimes sold at a higher figure than the published quotations, but the reverse is usually true. Of course these high quotations are given to induce shipments. A newly-established commission firm of Chicago sent out circulars last fall soliciting consignments of honey, and, as an inducement to shippers, prices four or five cents above the regular quotations were given. In correspondence with shippers they promised to get these prices and to make quick sales, and advised immediate shipments. When returns were finally made, they were often four or five cents below the regular quotations, 10 per cent. commission was charged where only five had been mentioned in the circular, freight bills and cartage were high, and there was general dissatisfaction. One man sent over 400 pounds of fine white honey, and received only a little over \$16 as the net proceeds—about four cents per pound. Another man sent a carload from New Mexico, and it netted him only about three cents per pound! This is for comb honey. The New Mexico man wrote me that he and his sons had lost \$1,000 by the deal.

This firm gave good references, and paid their bills promptly, and may have been honest for all that I know, but they made the mistake of promising to get high prices, and

then failed to get more than two-thirds the market price, or, at least, they reported sales at this low figure. Only yesterday I received a letter from a man who had sent this firm 90 pounds of dried apples, 10 bushels of walnuts, and 10 bushels of butternuts. He enclosed a letter they had written him when he inquired about sending the produce. Walnuts they told him were selling at from 50 to 75 cents per bushel, and butternuts from \$1.00 to \$1.50. The price of dried apples was not mentioned, but quick sales were promised, as it was early and there was a scarcity of nuts. It was two months before he received any returns, and the net proceeds were \$3.03! Such transactions are very discouraging to producers, and work an injury to commission-men who are honest and know how to do business.

I presume that commission-men are as honest as the common run of people, but the opportunities and temptations for trickery are greater than in many other kinds of business. The goods are in their hands, and the shipper has to take their word as to the price at which they are sold. Of course, prices at which shipments are sold can be verified, but unless the quantity involved is large, an investigation, and perhaps a lawsuit, are too expensive. Not only is there a chance for dishonesty in reporting sales, but there is a temptation to sell at a low price, to "shade" the price a little for the sake of making a sale and getting the commission. In short, the shipper is almost completely at the mercy of the commission merchant, and for this reason should use extraordinary care in selecting the man to whom he is to send his product. Select one who has for years made a specialty of handling honey, and one who gives satisfaction, and who, you believe, is honest. Have correspondence in advance of shipment. Learn the state of the market, describe your goods fully, and if you are not willing to allow them to be sold at any price that the merchant thinks best, then limit him in price. Say, "If you can't get so much, don't sell."

As a rule, there is more satisfaction in making an out and out sale. Better prices, however, are sometimes realized when honey is sold on commission, as the man who buys and pays cash down is pretty careful not to pay too much.

My own experience with commission-men has been very pleasant and satisfactory, but I have never sent any honey to any firm that had no established reputation for honesty and fair dealing. I have sometimes put a limit upon the price, but, as a rule, I would rather select the best market and the best man, and then trust to them. The man who is on the spot can usually tell better than any one else as to when it is best to sell at a certain price. Choose well your man—there lies nearly the whole secret.

But the shipper of honey is not the only one who has troubles. The commission-man comes in for his share. Honey is poorly put up, comes to hand broken and dripping, or the inner sections are imperfect or of dark honey, while the outer ones are white and perfect. All these things cause trouble and unpleasantness. This very Chicago firm to which I have referred recently sent me a case of honey to show that a complaining shipper ought not to complain because they did not make satisfactory sales. The honey was dark, and not a comb remained fastened in the frames. The case was just one mush of broken combs and dripping honey. Honey should never be sent by express. The rapid handling is almost sure to break it. By freight is the way to send it. The small cases should be put into a crate with handles at each end, and the crate of such size that two men will be required to handle it with ease, as this will insure more careful handling. The combs should be placed parallel with the track. If there are transfers to be made, it is well to go to a printing office and have some labels printed bearing a large , and the reading should be as follows: "Put this crate in the car so that the hand points towards the front end of the car."—Country Gentleman.

Questions AND Answers

CONDUCTED BY

DR. C. C. MILLER, MARENGO, ILL.

[Questions may be mailed to the Bee Journal, or to Dr. Miller direct.]

Not a Bee-Supply Dealer.

DR. MILLER:—Please send me your catalog on bee-culture, and prices of boxes and anything you have to sell to benefit a bee-man.

L. A. F.

ANSWER.—To this and other similar inquiries, I must reply that I don't keep for sale bee-supplies of any kind. Of course, one never knows for certain just what he may do, but at present I have no expectation of ever being interested in selling bees, hives or other appliances.

Hive Ventilation.

I hear about "good ventilation" for bees. How should a hive be constructed that it may have good ventilation? With a body and the super perfectly tight, will a $\frac{3}{8}$ entrance next to the bottom-board, the whole width of the hive, give sufficient ventilation for a strong colony through the summer?

Day before yesterday the thermometer was at over 100° in the shade; to-day at 60. Is there not danger, where a hive is blocked up an inch from the bottom-board, that the brood may get chilled in some of these extremes of cool weather?

Blue Rapids, Kan., Aug. 17.

C. G. B.

ANSWER.—The old-fashioned way with box-hives was to raise the whole business an inch or so by having a block under each corner of the hive. Possibly harm was sometimes done by that, and in spring and early summer it is important to keep the hive warm so that breeding may not be interrupted, but it is doubtful if on the whole as much harm was done as by the practice of many nowadays in having an entrance throughout the whole working season of not more than two to five square inches. When the thermometer drops from 100° to 60° within three days, there is a bare possibility that some brood might be chilled in the lower edges of the comb if the hive is raised an inch all around, but you will generally find that the cluster of bees will be sufficient protection for the brood. Bees may do with a $\frac{3}{8}$ entrance the width of the hive, and many of them get along with no more throughout the season, but they might do a good deal better with more. In hot weather, certainly no harm is likely to come from two or three times as much.

Honey in Box-Hives—Swarming.

1. I have a colony of Italian bees in a box-hive nailed on the bottom-board, with about 50 pounds of honey in it. How would you get the honey out? or what would you do with it?

2. When do they first swarm? and how will I know it, or find it out?

3. What is the trouble when the drones ride the workers in and out of the hive, and fuss with those that are bringing in pollen?

4. Where is the cheapest place to buy sections, etc.?

F. W.

ANSWERS.—1. Probably you will do as well to let the bees alone till next year. Then wait till they swarm, hive the swarm in a movable-comb hive, set it in place of the old hive, putting the old hive close beside it, then in five to seven days move the old hive to a new place, and three weeks after swarming all the young worker-bees will be hatched out, when

you can drive out the balance of the bees and unite them with the swarm. Then if there's any honey left in the old hive you can get it. If it has all been used up in rearing young bees, that's the best use that can be made of it. If you should actually weigh all the honey that's in the hive now, you might find it fall short of 50 pounds, for there's a good deal of weight in bees, pollen and old combs.

2. Most of the swarming is done in the months of June and July, but sometimes a strong colony may swarm during the last of May. There is hardly any sure way by which you can know beforehand when a colony is going to swarm if in a box-hive. In a frame hive you can tell something about it by the queen-cells. But you'll have no trouble about telling when the swarm actually comes, for it will seem that all the bees in the hive, and more, too, will come out of the hive all at once, or as fast as they can pour out. But you hardly need expect swarms before some time in June, and not then till the colony is strong, unless the hive is so small that they are crowded for room.

3. Whenever a scarcity of forage occurs, and almost universally in the fall, you will find the drones driven out of the hive by the workers. The workers seem to pretend to sting the drones, and often a poor drone may be seen with one or two workers on his back biting him.

4. Consult the advertising columns of this journal. Several supply dealers may be found there, and any of them can furnish the articles you desire. Write and ask them to send you catalogs.

Feeding Flour in Winter.

How do you feed bees flour for pollen, in the winter? I think I shall have to feed my bees flour.

G. P.

Sabael, N. Y.

ANSWER.—You don't need to feed flour or any substitute for pollen in the winter. If they have plenty of honey or good sugar syrup, they are all right without the pollen or its substitute. In spring, some substitute for pollen may be sometimes fed to advantage.

What Caused the Loss of Queens?

I had, last winter, three fine Italian colonies of bees standing side by side. I examined them the preceding fall and found each with a good young queen. I opened them once in the early spring, but did not look for the queen; they seemed in a normal condition. Two months later I opened the first in order, and could not possibly find the queen, but noticed at least four of the combs full of capped drone-brood. I immediately examined the other two hives, and to my surprise I found them queenless, and in the same condition as the first. You can imagine what followed—thousands of drones. Now for questions:

1. What do you conjecture as to the cause of the loss of my queens?

2. Did those queens likely die early in the spring?

3. Are combs injured by having drone-brood reared in them as described?

I forgot to say that all the combs were from good foundation and worker-cells. I must confess I was disgusted with the condition of things, but I have not had the experience repeated.

W. L.

Forest City, N. C.

ANSWERS.—1. I've sat for some time puzzling over your question, trying to think of some answer that would not utterly ruin what reputation I may have as an answerer of questions, and I think I'll have to give it up. If the bees had been reasonable enough to have lost the queen in only one hive, the answer would be easy; several ways in which a queen might come up missing, but when it comes to three in a row, it seems there must have been some special reason. True, all three of them may have been balled by their own bees and killed—such freaks sometimes occur; or the queens may have been of poor quality although good-looking, and so

were superseded by the bees, but such a guess is hardly satisfactory. There's a bare possibility, as you say they had good young queens in the fall, that they were virgin queens, reared too late to be fertilized, but your saying they were good makes me think they were probably laying in the fall. If any one knows the answer to your riddle, I'll be glad to have him rise and recite it.

2. I don't know.

3. As no change is made in the cells except at the outer surface, they are all right yet for worker-brood.

PERSONAL MENTION.

MR. J. H. MARTIN (Rambler) is now the editor of a department in the monthly Rural Californian called "Practical Bee-Keeping." He will be a success in his new position.

MR. JOHN M. SEILER, of Minnesota, wrote us Oct. 2: "The bees are done swarming and the work for this season is over, but the American Bee Journal is just as interesting and profitable as in the busy time."

MR. S. T. PETTIT, of Canada, reports a splendid crop of honey and wax. He says: "If for no other reason, I would have the bees cap the honey for the wax; but it pays in the quality of honey." He regretted exceedingly that he could not go to the Lincoln convention.

MR. GEO. R. MCCARTNEY—inventor of the McCartney combined section-press and foundation fastener—has just suffered a severe affliction in the very sudden death of his little three-year-old child, of membranous croup. Only two hours before his death the child was as well as ever. The Bee Journal extends sincerest sympathy to the bereaved parents.

MR. CHAS. DADANT dropped into our office a week ago last Saturday, when on his way home to Hamilton, Ill., from Sturgeon Bay, Wis., where he had been for about two months to avoid an attack of hay fever. Though nearly 80 years old, Mr. Dadant is well and hearty, and indicates no good reason why he should not reach the 100-year mark. We hope he will.

MR. WM. MCEVOY—the everywhere-known foul brood inspector of Ontario—could not attend the Lincoln meeting last week on account of being behind in his official duties. He says some of his trips are over 300 miles from home. He reports getting along well in putting the disease out of the apiaries, and also in showing their keepers how to manage the business to take the dollars out of their bees. Success to that untiring Inspector!

COL. CHAS. F. MILLS, of Springfield, Ill., is the efficient Secretary of the Illinois Farmers' Institutes. We met him at the State Fair. He is very friendly toward bee-keeping, and will do all in his power to aid them in anything they may desire. He is now arranging to have bee-culture represented among the subjects to be talked on at the institutes. Mr. Mills is a worker, and has lots of friends among farmers and others.

MR. F. GRABBE—the judge of the apiarian exhibits at the Illinois State Fair—is an old bee-keeper, having a large and prosperous apiary in Missouri at the present time. He also has bees at his home in Libertyville, Ill. Some 25 years ago he was one-half owner of the Bee Journal, with Wm. F. Clarke. Mr. Grabbe used to be quite an exhibitor of bees and honey at Fairs. He now, with his son, has a honey store in Chicago, and bottles pure honey for the grocery trade, having on hand enough honey, he thinks, to last through the selling season.

MR. JAS. A. STONE is the faithful Secretary of the Illinois State Bee-Keepers' Association. When at the State Fair we were sumptuously entertained by Mr. S. and his good wife. They live $6\frac{1}{2}$ miles from Springfield, on a large farm, in one of the richest agricultural spots of the world. On account of the rain and shortness of our stay we could not look over the place as we would have been glad to do. But we could see that it was an ideal country home. Mr. Stone has now 40

colonies of bees, though in good seasons he prefers to have 120. The past has again proven to be a poor season with bees there, but the prospects are good for next year.

Mr. and Mrs. Stone have one son—"Percy"—who is a veritable "chip of the old block," as the saying goes. He is a graduate of the Springfield High School, and, also, we believe, of the State University, at Champaign, having taken honors at both institutions. We bespeak for him a successful and prosperous career.

MISS SUSIE TRENDLEY is a young school teacher living at St. Peters, Mo. She also takes a hand with the bees occasionally. Here is a record she made the past season, when extracting some gallons of honey gathered from Spanish-needle: Aug 27 to 28, 55 gallons; Sept. 4, 60; the 8th, 60; the 9th, 85; the 11th, 42; the 12th, 72; the 14th, 55; the 15th, 54; the 16th, 54; and the 17th, 12; with perhaps 100 gallons still on the hives and to be extracted. Counting 12 pounds to the gallon, there would be over 8,000 pounds in all. Pretty good for a little Missouri schoolma'am!

MR. GEO. MCKERROW, of Madison, Wis., is the pushing Secretary of the Wisconsin Farmers' Institutes. We met him at the Illinois State Fair two weeks ago. He used to be interested in bee-keeping, and told us of one of his colonies, some 20 years ago, that cast a large swarm, and from the swarm he took \$40 worth of honey that year. That was before section-boxes were in use, and honey in those days was worth something. With such a record, we felt that Mr. McKerrow had made a mistake in not following up the bee-business. But he became more interested in general farm stock, and now is a champion of the Oxford Down and South Down sheep, which he had on exhibition at the Springfield Fair. We should judge that he is a hustler at farmers' institutes.

A New Binder for holding a year's numbers of the American Bee Journal, we propose to mail, postpaid, to every subscriber who sends us 20 cents. It is called "The Wood Binder," is patented, and is an entirely new and very simple arrangement. Full printed directions accompany each Binder. Every reader should get it, and preserve the copies of the Bee Journal as fast as they are received. They are invaluable for reference, and at the low price of the Binder you can afford to get it yearly.

The Alsike Clover Leaflet consists of 2 pages, with illustrations, showing the value of Alsike clover, and telling how to grow it. This Leaflet is just the thing to hand to every farmer in your neighborhood. Send to the Bee Journal office for a quantity of them, and see that they are distributed where they will do the most good. Prices, postpaid, are as follows: 50 for 25 cents; 100 for 40 cents; or 200 for 70 cents.

Only One Cent a Copy for copies of the American Bee Journal before Jan. 1, 1896. We have them running back for about 10 years. But you must let us select them, as we cannot furnish them in regular order, and probably not any particular copies. Just send us as many one-cent stamps as you may want old copies, and we will mail them to you.

The Names and Addresses of all your bee-friends, who are not now taking the Bee Journal, are wanted at this office. Send them in, please, when sample copies will be mailed to them. Then you can secure their subscriptions, and earn some of the premiums we have offered. The next few months will be just the time to easily get new subscribers. Try it earnestly, at least.

The McEvoy Foul Brood Treatment is given in Dr. Howard's pamphlet on "Foul Brood; Its Natural History and Rational Treatment." It is the latest publication on the subject, and should be in the hands of every bee-keeper. Price, 25 cents; or clubbed with the Bee Journal for one year—both for \$1.10.

The Great Campaign Book offered on page 666, ought to be in the hands of every voter. It shows all sides of the political questions of the day. Better send for a copy of it. Orders filled by return mail.

Now is the Time to work for new subscribers. Why not take advantage of the offer made on page 669?

OLDEST BEE PAPER IN AMERICA ESTABLISHED IN 1881

THE AMERICAN BEE JOURNAL

GEORGE W. YORK, Editor.

PUBLISHED WEEKLY BY

GEORGE W. YORK & COMPANY,

118 Michigan St., CHICAGO, ILL.

\$1.00 a Year—Sample Copy Sent Free.

[Entered at the Post-Office at Chicago as Second-Class Mail-Matter.]

Vol. XXXVI. CHICAGO, ILL., OCT. 15, 1896. No. 42.

EDITORIAL COMMENTS.

The Lincoln Convention closed Thursday evening, Oct. 8. There was a fair attendance, and a splendid meeting. We reached our office again last Saturday morning (Oct. 10), having had a most delightful trip. The visiting members from outside of Nebraska were right royally entertained, and thoroughly enjoyed the convention throughout.

We expect to begin the report of the proceedings in full next week. For the present we will simply say that the next meeting is to be held at Buffalo, N. Y. (date to be selected by the Executive Committee), and that the newly elected officers are as follows:

President—George W. York, of Chicago, Ill.
 Vice-President—Hon. E. Whitcomb, of Friend, Nebr.
 Secretary—Dr. A. B. Mason, of Toledo, Ohio.
 Treasurer—O. L. Hershiser, of Buffalo, N. Y.

Langstroth on the Honey-Bee.—The third edition of Dadant's revision of that master-piece—"Langstroth on the Honey-Bee"—is now out. There are no changes in the work except a few corrections suggested by some of the leading bee-keepers who have read the book critically at the request of the revisers. There has also been added, in the biography of Mr. Langstroth, a statement concerning his death, which occurred about a year ago.

The second edition of the French translation of this work is also out. It was printed, and is kept for sale, in Switzerland. But 200 copies of it have been received by Chas. Dadant & Son for their United States trade.

No word in praise of this grand bee-book is needed from us. It simply has no superior in the book literature of bee-culture. We mail it for \$1.25, or club it with the American Bee Journal for a year—both together for \$2.00. We can furnish either edition—English or French. The longer evenings will soon be here, when all bee-keepers will have more time to read. And what better reading than the Langstroth-Dadant classic and practical book?

The Illinois Apiarian Exhibit at the State Fair week before last was perhaps the best made at any Fair this season. As mentioned last week, it was our privilege to be present two days, and to go over the exhibits with the judge—Mr. F. Grabbe.

In all there was given in awards \$284, which we believe is the largest amount offered on apiarian exhibits by any Fair this year. So of course there was some sharp competition.

Mr. Geo. H. Kirkpatrick, of Indiana, who is an old hand at making bee and honey exhibits, put up a very fine show of both comb and extracted honey, comb foundation, beeswax,

bees, hives, honey extractor, 33 samples of extracted honey, and various other articles. Mr. Kirkpatrick won a total of \$95 in cash premiums.

The Hutchinson Brothers—W. Z. and Elmer—of Michigan, are also expert exhibitors, and had a large display of comb and extracted honey, the former in 12-pound shipping-cases, which were built in pyramid shape, the interstices and two edges being filled in with extracted honey in glass jars, the whole surmounted with a smaller pyramid of honey in jars. It extended clear to the roof of the building, and must have impressed visitors with the fact that there is quantity as well as quality in honey. The Hutchinsons also had two large exhibits of honey-plant specimens, mounted; beeswax, honey-vinegar, bees, queen-bees, samples of extracted honey, etc. In all they captured \$81 in premiums.

Mr. Jas. A. Stone's exhibit consisted principally of beeswax in fancy and commercial forms, and candied extracted honey that formed a part of the Illinois State exhibit at the World's Fair. He won \$25 in premiums.

Mr. C. Becker was the largest exhibitor from this State. He showed comb and extracted honey, comb foundation, bees, samples of extracted honey, honey-plant specimens, honey extracted on the ground, etc. Mr. Becker won \$51 in premiums. He has made a good start, and no doubt will become a hard man to compete with at future Fairs. He told us he was learning how to exhibit, and no doubt will prove an apt scholar.

Messrs. Finch & Robbins had on exhibition comb foundation, beeswax, bees, queens, and a general line of bee-supplies.

There was one other large exhibit of comb and extracted honey, beeswax, bees, etc. Mr. Thos. Wallace showed bees and queens.

The result of the awards of cash premiums were substantially as follows:

Display of comb honey—1st, W. Z. Hutchinson, \$25; 2nd, Geo. H. Kirkpatrick, \$15; 3rd, C. Becker, \$10.

Case of white clover comb honey, 12 to 24 pounds—1st, Mr. Kirkpatrick, \$5.

Case of basswood comb honey, 12 to 24 pounds—1st, Mr. Kirkpatrick, \$5; 2nd, W. Z. Hutchinson, \$3.

Case of comb honey from fall flowers, 12 to 24 pounds—1st, Mr. Becker, \$5.

Display of extracted honey—1st, Mr. Kirkpatrick, \$25; 2nd, Mr. Becker, \$15; 3rd, W. Z. Hutchinson, \$5.

Display of samples of extracted honey, named—1st, Mr. Kirkpatrick, \$5; 2nd, Mr. Becker, \$3.

Display of candied honey—1st, Mr. Kirkpatrick, \$15; 2nd, Mr. Stone, \$15; 3rd, W. Z. Hutchinson, \$5.

Display of beeswax—1st, Mr. Stone, \$15; 2nd, Mr. Kirkpatrick, \$10; 3rd, W. Z. Hutchinson, \$5.

Dark Italian bees—1st, Finch & Robbins, \$5; 2nd, Mr. Becker, \$3.

Golden Italian bees—1st, Mr. Wallace, \$5; 2nd, Finch & Robbins, \$3.

Carniolan bees—1st, Mr. Becker, \$5; 2nd, Mr. Kirkpatrick, \$3.

Other race or strain of bees—1st, Finch & Robbins (on the "Adels"), \$5; 2nd, Elmer Hutchinson (on Cyprians), \$3.

Queen-bees in cages—1st, W. Z. Hutchinson, \$5; 2nd, Mr. Wallace, \$3.

Comb foundation—1st, Mr. Kirkpatrick, \$10; 2nd, Finch & Robbins, \$3.

Honey-plants, pressed and mounted—1st, W. Z. Hutchinson, \$10; 2nd, Elmer Hutchinson, \$5.

Honey extracted on the ground—1st, Mr. Becker, \$10; 2nd, W. Z. Hutchinson, \$5.

Honey-vinegar—1st, W. Z. Hutchinson, \$3; 2nd, Elmer Hutchinson, \$2.

The apiarian exhibits this year certainly were a great credit to the bee-industry, and no small part of the whole Fair. It shows that when Fair managers give the proper financial encouragement, a good exhibit will result. Next year we wish the premiums might be doubled, and also that more resident bee-keepers might be represented. It is no great credit to Illinois that other States come in and carry off the bulk of the cash premiums offered at her big Fair. In

the future we hope to see a much larger number of exhibitors, and if need be smaller quantities exhibited, though we think that bee-keepers can have all the space they will occupy.

In conclusion we may say that we suppose no other State can boast of finer Fair Grounds than those at Springfield, Ill. Nor are there any larger or better equipped buildings. It seems to us that no pains should be spared to make it the greatest annual event in the West, so that all the railroad companies would make at least a one-half rate. It is already the great World's Fair on a smaller scale.

Letters Soliciting Honey have been sent out quite liberally the past month or two. One of our subscribers writes that he has received no less than four within one month, all being the same wording, but signed by supposedly different Chicago firms. Of course it's a "ring" letter—one used by several so-called "honey-firms," but all probably having the same backing, as stated in the Bee Journal last week.

We hope that our readers will send us all such letters, and also anything out of the ordinary that they may receive, so that we can look them up and report on them in the Bee Journal. We must work together in such matters if we expect to stop fraudulent firms from fleecing bee-keepers. After a few more "rounds" like we have given them lately, we think they will find it doesn't pay to send "baity" letters to bee-keepers. They of course think that bee-keepers are all thick-headed dunces, and will "bite" at anything. But they'll find out pretty soon that the bee-keepers who read the bee-papers are not such fools as they supposed them to be.

Granulation of Honey.—In the British Bee Journal for July, 1896, there appeared an interesting editorial on the granulation of honey, which we take pleasure in reproducing for the benefit of our readers:

The considerable variation in time during which honey will remain liquid is a constant source of puzzlement to bee-keepers, and the cause of a regular repetition of the inquiry, How long a time elapses before honey granulates or becomes solid? Those who have had much experience of the matter, however, know that the length of time cannot possibly be fixed. A fairly accurate calculation may no doubt be made, under certain circumstances, by those who have handled honey gathered in various districts where special kinds of bee-foreage are regularly grown, as to whether a particular crop is likely to granulate soon, or keep liquid for a year or so. But it is little beyond a more or less safe guess in any case; a guess ventured upon in view of the weather conditions at the time of gathering and the source from whence the honey is obtained. This is about all that can be done in "timing" granulation without the need for dipping more deeply into the science of the subject than the ordinary bee-keeper cares to do.

We may, however, just touch upon the scientific view of the question by observing that honey consists of two distinct saccharine portions, viz.: dextrose (grape-sugar)—this may be termed the crystalline portion—and levulose (fruit-sugar), which is incapable of crystallization. Chemically, however, these two substances, though dissimilar in the respect mentioned above, are identical in composition. Both containing particles of carbon, hydrogen, and oxygen in the proportion of six to twelve to six; the chemical formula being $C_6H_{12}O_6$. They are also identical in most of their chemical reactions, while possessing widely different physical properties. The crystalline portion (dextrose) turns a ray of polarized light to the right, and the non-crystalline (levulose) turns the polarized ray to the left.

The great bulk of normal honey consists of almost equal parts of dextrose and levulose—or invert sugar as it is usually called—water, and a minute quantity of formic acid; but the actual proportions sometimes vary, and, according to the source from whence the nectar is gathered, one may predominate over the other, thus either retarding or accelerating granulation. Another cause of variation in the time during which honey granulates may be brought about mechanically, as it were; as whenever it happens that honey, while in the comb, begins to granulate, and is afterward extracted, some portion of the crystals may remain behind in the comb, thus

causing the non-crystallizable sugar (or levulose) to predominate. Such honey—from which the dextrose is partially separated—will, no doubt, remain liquid for a long time.

The widely-varied action of time so far as affecting granulation, is also shown by noting its effect on honey gathered from different sources. To illustrate the point let us take two types of honey, each having distinctly different characteristics in this line, viz.: that from white clover and from mustard. Clover honey—collected in a good season for that product, *i. e.*, one of continuous warm, dry weather during the gathering time—will, if well kept in a suitable place, generally retain its liquid condition for one or two years (often more) without any appreciable deterioration in quality, whether in comb or in jars. (Within the last few days we partook of a section of clover honey gathered in 1894, the condition and quality of which was simply perfect in every respect.) But the same variety of honey gathered under different weather conditions will, in some seasons, granulate before the end of the same year.

On the other hand, honey from the mustard-fields in Lincolnshire, gathered in the finest and driest of weather, will become quite solid in a couple of weeks after being extracted. The difference, then, in time of granulating largely depends on the component parts of the honey dealt with, and for the rest upon the weather condition at the time of gathering. And these facts should make clear the impossibility of fixing the time for granulation by rule of thumb.

Regarding the temperature for keeping comb honey liquid as long as possible, about 65° to 75° is generally considered best for the purpose. To store it either at a much higher, or at, say 10° lower than the temperature stated is not nearly so effectual as a preservative.

But the keeping properties of extracted honey are largely dependent on the bee-keeper himself, so far as knowing what samples are likely to remain in good condition, and those in which fermentation is sure to be set up if kept beyond the season in which they are gathered. Thin honey—we mean thin extracted—never keeps well. Moreover, the watery portion which rises to the top of honey in bulk, should never be mixed along with that intended for keeping. A small portion of such thin, watery stuff, instead of being itself ripened by blending with ripe honey of good consistency, will rather tend to spoil the lot by setting up fermentation.

Against Foul Brood in Minnesota.—At the meeting of the Southeastern Minnesota Bee-Keepers' Association at Winona, Sept. 15, the following resolutions were unanimously adopted:

WHEREAS, There now exists in several localities in this State, and in our near vicinity in neighboring States, a disease in our colonies known as foul brood, which has proven to be very destructive and contagious, completely destroying bees in large territories; and,

WHEREAS, It is the unanimous desire of the Southeastern Minnesota Bee-Keepers' Association that this infection shall be stamped out; now, therefore, be it

Resolved, That a committee of three be appointed by our President (of which he shall be ex-officio chairman) to attend the annual meeting of the Minnesota State Bee-Keepers' Association; and that they be instructed to co-operate with said Association in any measures that may be decided upon to prevent and control the spread of this disease; and be it further

Resolved, That said committee be instructed to compile the names of bee-keepers of the State of Minnesota, in order that printed copies of this resolution, together with a paper setting forth in detail the method it is found most desirable to pursue in obtaining legislation; and urging them that they each individually either see or write their Representative, asking his aid in our behalf.

In compliance with the foregoing, a committee was appointed composed of the following: John Turnbull, of La Crescent, Chairman Ex-officio; S. W. Judge, of Pickwick; W. J. Stahmann, of Weaver; and Joseph H. Bolton, of St. Paul.

It is hoped that the bee-keepers of Minnesota will heartily co-operate with the committee in their efforts to rid the State of foul brood.

Honey-Recipes.—We wish to request all who know reliable recipes in which honey is used (and that are not now found in the pamphlet, "Honey as Food and Medicine"), to send them to us, as we desire to put them in the next lot we have printed. We want especially any good recipes for making honey-candies. We will also publish in the Bee Journal all that are sent in. Kindly let us have them at once.

THE GREAT CAMPAIGN

—OR—

Political Struggles of Parties, Leaders and Issues

COMPRISING

Biographies of the Republican, Democratic,
Populistic, Prohibition and National
Nominees for President and Vice-President
of the United States.

—ALSO—

The Platforms Principles and Leaders of All Parties

DISCUSSING

ALL VITAL QUESTIONS OF THE DAY

HAVING AS ITS OBJECT

The Enlightenment and Education of American

—VOTERS—

Upon the Living Issues of the Hour.

The Gold Standard of Currency, Bi-Metalism, Free Coinage of Silver, High Protective Tariff, Tariff for Revenue Only, Prohibition, Licensed Liquor Traffic, the Doctrine of Reciprocity, the Monroe Doctrine, Laws Governing Our Relations with Other Nations, the Venezuelan, Armenian and Cuban Questions. Containing also Lives and Portraits of former Presidents, with a Review of their Administrations and the Political Lessons gleaned from them; together with a Portrait Gallery of Statesmen and Political Celebrities comprising 100 accurate Phototypes and other Portraits, embracing the most active and prominent statesmen in our Nation. The whole forms a Voter's Hand-Book of Political Information, thoroughly practical, enjoyable and instructive, enabling him to vote intelligently upon those vital subjects which constitute the living issues of the present great campaign.

This book embodies the views and opinions of the great leaders from the various party points of view, clearly explaining all the momentous questions now before the people. It is planned upon the broad principles of non-partisan national patriotism, and attacks no man's creed, and upholds the ban-



McKinley.



Bryan.

American citizen. It is a vast storehouse of truth, plain, simple and unvarnished, which makes this work an unequalled source of information upon the great issues of this campaign, suited to the wants of every voter irrespective of party and without partisan bias.

Our Country calls for thirteen million volunteers. "I do love my country's good with a respect more tender, more holy



Levering.

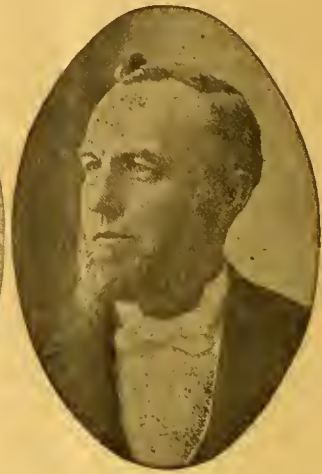

Bentley.

and profound than mine own life," is the language which Shakespeare puts into the mouth of an ideal patriot. May this sentiment find a universal echo in the hearts of the voters of the United States of America who go to the polls in November, 1896.

Great questions are to be settled; a mighty battle is to be fought; a battle of ballots such as this country has never witnessed, which, in its far-reaching effects, will accomplish on the field of American suffrage, at the Ballot Box, next November, results as potential for good or evil to our Nation, revolutions as radical, and effects as lasting upon our institutions, as were ever wrought upon the field where sword and bullet, grape and canister settled the issue of the hour.

An impartial view of the situation reveals the fact that our Country never needed more broad-minded wisdom and unselfish patriotism in all her history than she requires to guide her through the present crisis.

Since the rising war cloud of 1859-60 which deluged our Country in the blood of brothers, our Nation has not been so agitated, divided and excited as it is to-day from ocean to ocean—North, South, East and West, on the great financial question, which is a vital issue of this campaign; and its settlement is fraught with threatenings and omens indicating political combinations, upheavals and surprises which our shrewdest politicians seem unmindful of or unwilling to recognize.

Since 1873 the mutterings of discontent have been growing louder between the advocates of Gold and Bi-metal standards. During the past three years, these mutterings have grown into clamorous shouts and peremptory demands on both sides. Statesmen never thought so diligently or more deeply on any subject; and the whole country never was so eager to have all sides of this momentous question presented in a clear, lucid and intelligible manner which the common reader can understand—the money question.

The Doctrine of Reciprocity is also treated at length from a broad, patriotic and non-partisan point of view.

This volume contains about 600 pages, is printed on super-calendered paper, and bound in beautifully lithographed board covers. The pictures of the four principal Presidential candidates shown herewith appear on the front outside cover, and the Vice-Presidential candidates on the back cover.

How to Get the Above Book.

Send \$1.00 and receive it postpaid. Or, send us two new subscribers for the Bee Journal at \$1.00 each, and we will mail you the book free as a premium. Or, for \$1.75, we will mail you the book and the Bee Journal for one year. Address,

GEORGE W. YORK & CO.,
118 Michigan Street, - CHICAGO, ILL.

ner of no party; but placing every party and its principles, with its leaders upon its own platform, and bringing the several parties, platforms and champions in their true light before the mind of the reader, the intelligent citizen will, in this book, be enabled to view and compare them side by side and judge of their respective claims upon this vote as an

The Honey of a Kiss.

BY MAUD MOORE.

When the cares of day are ended,
And my baby's prayer is said,
When he lies in peaceful slumber
In his little trundle-bed.
As I sit beside him listening
To his breathing calm and deep,
Comes the question that he asked me
Just before he went to sleep—
With the rosy lips a-tremble
And his laughing eyes a-light—
"Is there honey in the kisses
Of your little boy to-night?"

For I tell my little Ormond
If he has been good all day,
True and tender in his speaking,
Kind and thoughtful in his play;
Just as in the fragrant blossom
Of the clover for the bee,
There is honey in the kisses
Of my little boy for me.

But a little noise of nestling
From my baby's trundle-bed,
And a dimpled arm tossed upward
O'er a moist and curly head,
Bring me back from out my musing—
From the world of dreams to this,
And I send him back to slumber
With the honey of a kiss.

—Selected.

Question-Box.

In the multitude of counsellors there is safety.—Prov. 11-14.

A Question on Queen-Rearing.

Query 32.—If the queen be taken from a colony that has at the time no queen-cells, and the colony be allowed to rear a young queen, about how long will it be from the time when the old queen is removed before the new one begins to lay?—P.A.

J. A. Green—20 days.

Wm. McEvoy—About 25 days.

Chas. Dadant & Son—18 to 24 days.

G. M. Doolittle—From 20 to 25 days.

J. M. Hambaugh—From 25 to 30 days.

Dr. J. P. H. Brown—Usually in about 21 days.

P. H. Elwood—Nearly three weeks, on an average.

Mrs. L. Harrison—The time varies; about 16 days.

Engene Secor—I should expect eggs in about 26 days.

W. G. Larrabee—I should think about 25 days, but I never tested it.

Jas. A. Stone—From 18 to 40 days. It might be longer in a honey-dearth.

Prof. A. J. Cook—I should say 19 or 20 days, if there was no delay in the mating.

Emerson T. Abbott—Buy a bee-book and read it, and you will not need to ask such questions.

Dr. C. C. Miller—In a strong colony perhaps in 18 or 20 days at the shortest, but in a nucleus the time may be extended several days.

J. E. Pond—This questioner should purchase some book on bee-keeping, where he would find many facts and principles laid down and explained that would be of value to him. For instance, about 16 days from egg to queen; from 4 to 10 days for mating, and from 2 to

THE "NOVELTY" POCKET-KNIFE!



Your Name on the Knife.—When ordering, be sure to say just what Name and Address you wish put on the Knife.

The NOVELTY KNIFE is indeed a novelty. The novelty lies in the handle. It is made beautifully of indestructible celluloid, which is as transparent as glass. Underneath the celluloid, on one side of the handle is placed an AMERICAN BEE JOURNAL reminder, and on the other side, name and residence of the Subscriber.

The material entering into this celebrated knife is of the very best quality; the blades are handforged out of the very finest English razor-steel, and we warrant every blade. The bolsters are made of German silver, and will never rust or corrode. The rivets are hardened German silver wire; the linings are plate brass; the back springs of Sheffield spring steel, and the finish of handle as described above. It will last a lifetime, with proper usage.

Why purchase the Novelty Knife? In case a good knife is lost, the chances are, the owner will never recover it; but if the Novelty is lost, having name and address of owner, the finder will return it; otherwise to try to destroy the name and address, would destroy the knife. If traveling, and you meet with a serious accident, and are so fortunate as to have one of the Novelties, your pocket KNIFE will serve as an identifier; and in case of death, your relatives will at once be apprised of the accident.

How appropriate this knife is for a Christmas, New Year or birthday present! What more lasting memento could a mother give to a son, a wife to a husband, a sister to a brother, a lady to a gentleman, or vice versa, a son to a mother, a husband to a wife, a brother to a sister or a gentleman to a lady—the knife having the name of the recipient on one side?

The accompanying cut gives a faint idea, but cannot fully convey an exact representation of this beautiful knife, as the "Novelty" must be seen to be appreciated.

How to Get this Valuable Knife.—We send it postpaid, for \$1.00, or give it as a Premium to the one sending us three new Subscribers to the BEE JOURNAL (with \$3.00), and we will also send to each new name a copy of the Premium Edition of the book "Bees and Honey." We club the Novelty Knife with the BEE JOURNAL for one year, both for \$1.90.

Any Name and Address Put on the Knife.

GEORGE W. YORK & CO.,
CHICAGO, ILLS.

Allow about two weeks for your order to be filled.

Extracted Honey For Sale!

We can furnish **Basswood** Extracted Honey, in 60-pound tin cans, on board cars in Chicago, at these prices: 1 can, in a case, 8 cents per pound; 2 cans in one case, 7½ cents; 4 cans (2 cases) or more, 7¼ cents; or in kegs holding about 275 lbs., net, at 7 cents. Cash must accompany each order.

☞ A sample of the honey will be mailed to an intending purchaser, for 10 cents, to cover postage, packing, etc. We guarantee purity, and what we ship will be equal to sample.

Now it seems to us here is a splendid chance for any bee-keeper to supply his home demand after his own crop is all sold. Or, why not begin now to create a local honey-trade? Order one 60-pound can first, and start out among your neighbors and friends, and see what you can do. You ought to get at least 15 cents per pound in 5-pound lots, or 50 cents for 3 pounds. Some may be able to do even better than that, though we think that enough ought to be sold at these prices to make a fairly paying business out of it. Give it a good trial. Push it. It may grow into a nice winter's work for you.

GEORGE W. YORK & CO., 118 Michigan Street, CHICAGO, ILL.

That Queen-Clipping Device Free!

Works Like a Charm.

The Monette Queen-Clipping Device WORKS LIKE A CHARM. With it I have clipped 30 queens, all in one day, when examining my bees. WM. STOLLEY, Grand Island, Nebr.

Couldn't Do Without It.

I have clipped 19 queens, and must say the Monette Queen-Clipping Device is by far the best invention ever made, and will be welcome to many bee-keepers as it was to me. I could not do without one now.

DR. GEO. LACKE, Newburgh, Ind.

PLEASE READ THIS OFFER TO PRESENT SUBSCRIBERS:

Send us just one new name for the American Bee Journal a year (with \$1.00), and we will mail you the Queen-Clipping Device FREE of charge. Or, the Queen-Clipping Device will be sent postpaid for 30 cts. But why not get it as a Premium by the above offer? You can't earn 30 cts. any easier. Almost every bee-keeper will want this Device. See page 130 (Feb. 27) for full description of it. Complete directions accompany each one sent out. It is a most ingenious and useful article. Address,

GEORGE W. YORK & CO., 118 Michigan St., Chicago, Ill.

5 or 6 days before eggs would be found. The rule varies, but the above are about the averages. Nothing pays a novice better than to study the first principles of apiculture; without a knowledge of them he will be constantly groping in the dark.

C. H. Dibbern—Let's see! It will be 16 days before a young queen is hatched, and about 16 days more before she begins to lay, so you may call it a month and not be far wrong.

R. L. Taylor—Under such circumstances a young queen would emerge from the cell in 10 days, and would usually begin to lay in from 10 to 20 days thereafter, according to the season, weather and forage.

E. France—The young queen would hatch in 12 days, and would be laying in about 10 days more—22 days after the removal of the old queen. Ten days after the removal of the old queen take out all but one of the queen-cells; if that is not done, the colony will be likely to swarm.

Mrs. J. N. Heater—If the bees made use of a just-hatched larva to rear their queen, she might be depositing eggs in about 28 days from the time of removing the old queen. But they may gain a few days by using a larva of an improper age, or be retarded by bad weather at the time when the queen should take her flight.

Rev. M. Mahin—Under the most favorable conditions the young queen might begin to lay in 17 days. A young queen is sometimes hatched in 10 days from the removal of the old one, and in rare cases is fertilized on the fifth day after emerging from the cell, and begins to lay two days later. But as a rule I would not expect eggs before the 19th or 20th day.

G. W. Demaree—There are several uncertain conditions of things that must be taken into account when you attempt to answer a question like this. It requires 16 days to produce a queen from the time the egg is laid. Thus, 3 days for the egg to hatch out the larva; now if the bees select a larva 2 days old to commence with, 5 of the 16 days are consumed at the very commencement, and a queen should be hatched out in 11 days from the time the old queen was missed by her bees. Now add 7 days for the queen to mate, and 3 days more to develop into the egg-laying state—thus 11, 7, 3—21 days. I have had them laying eggs in from 18 to 24 days.

PLANTS TO BE NAMED.

By DR. H. S. PEPOON,

936 Belleplaine Ave., Station X, Chicago, Ill.

One of the Mints.

What is the name of the enclosed plant. It is a strange one in this section, and a few bunches are growing in my yard. It is in bloom now, and I discover my bees are working on it all day long. If there was plenty of it I believe it would be a profitable honey-plant.

Evans, Ky., Sept. 19. P. A.

ANSWER.—The plant you send belongs to the mint family, which furnishes a number of valuable honey-plants, as horse-mints, sages, etc. The plant in

question is an introduced one, coming from Asia, and is rare in this country. It is related closely to the horse-balm (*Collinsonia*), but so far as I can determine it has no common name. Like many of its relatives, it is probably a honey-plant, but of no value, from its scarcity.

"A Boneset Relative."

I enclose a sample of a weed to be named. It grows in old fields and waste places; it begins blooming the last of August and first of September, and lasts about four weeks, and as dry as the weather is the bees just swarm on it. They gather both honey and pollen from it. We have had hardly any rain since February.

A. R. Y.

Sullivan, Ark., Sept. 12.

ANSWER.—The plant you send has already been mentioned in this department under the heading "A Boneset Relative," in the number for Aug. 13, which please refer to.

Tall Rattlesnake Root.

I enclose a sample of a plant that I found near my house. I think I never saw a plant that the bees work on so constantly as they do on this. I would like to know the name of it. It grows on a piece of new ground that has been burned over.

E. H.

Graunville, Mass., Sept. 16.

ANSWER.—Your plant is the "tall rattlesnake root" (*Prenanthes altissima*), a near relative of the wild and garden lettuce, and other plants of the great Composite family. It is doubtless a good honey-plant, and is mentioned by Prof. Cook, who says it "swarms with bees all day long." It is a perennial plant and easily grown from seed.

Willow-Herb.

I enclose a sample of a plant that grows on the marshes. It begins blooming in June, and ends about the middle of August. Please tell the name of it.

S. R. H.

Hancock, Wis., Sept. 16.

ANSWER.—The plant you send has already been "written up" in a former number of the Bee Journal. It is the great swamp loose-strife or willow-herb or fire-weed. "Willow-herb" is the appropriate name for it. Prof. Cook says of this plant: "It is often the source of immense honey harvests.....the honey is white as clover honey. It often gives a rich harvest to the apiarist of northern Michigan."

Another Boneset.

The enclosed weed (I suppose) grows abundantly here. It has been in bloom for more than two weeks, and I think it will continue to bloom for some weeks longer. Please name it, and say what its honey value is. I notice my bees are busy on the bloom from morning until night.

H. S.

Ocean Springs, Miss., Sept. 22.

ANSWER.—Your plant is treated in the Bee Journal for Aug. 13, under the heading, "A Boneset Relative." Prof. Cook says of the bonesets: "Now commence to bloom the numerous bonesets or thoroughworts (*Eupatorium*), which

Warner's Safe Cure

IN LARGE OR SMALL BOTTLES.



Owing to the many requests from its patrons, Warner's Safe Cure Co. have put on the market a smaller size bottle of Safe Cure which can now be obtained at all druggists at half the price of the large bottle.

Warner's Safe Cure

is not only a scientific vegetable preparation and does all that is claimed for it, but it is the only Kidney and Liver medicine used by the best people of four continents. A medicine that bears the stamp of the world's approval, and maintains its position for a fifth of a century, must necessarily possess peculiar merit.

Mention the American Bee Journal.

fill.....the hives as well with their rich golden nectar." As before hinted, such plants as this one certainly would repay the little care necessary to once establish them near the apiary.

General Items.

Had a Fair Crop.

We had a fair crop of clover honey, and enough fall honey to fill the brood-chambers. Bees are in good condition for wintering. I will send in a report after I have weighed the honey. The Bee Journal has been a great help to me. I don't think I have missed a number in six years.

L. D. MILLER.

Audubon, Iowa, Sept. 25.

Failure on Account of Drouth.

Bees made a failure this year, owing to the early drouth. I am feeding a few colonies. This is the third year in succession that bees have made a total failure.

I saw on page 612 a description of a disease called "pickled brood." I found a very bad case in my own apiary some time since. I thought it must be foul brood, and I burned it all. A few other colonies were slightly affected, but are clear of it now. I called on a farmer

bee-keeper last week, and found that 10 out of 11 colonies were dead; the one that is living has plenty for winter. He said he had hived three swarms this year, but had not taken any honey. His neighbors, he said, were in the same fix.
Waring, Tex. A. G. ANDERSON.

Did Well This Year.

Bees did well here this summer, running from 50 to 110 pounds of comb honey per colony. The price is from 12 to 18 cents per pound.
L. BRYANT.
Waymart, Pa., Sept. 29.

Flow from Alsike and White Clover.

The honey crop has been a failure here for three years, on account of drouth killing all the honey-flora; but the first two weeks of this month we had quite a flow from Alsike and white clover, which was revived, as we have been having considerable rain this season.
Poneto, Ind., Sept 28. J. W. COOK.

Very Poor Honey-Year.

It has been a very poor honey-year here. My colonies averaged only about half what they did last year—I got only 400 pounds from 30 colonies. They got little or no honey from clover. The honey-flow this year was mainly from basswood. I hope next year will be better.
W. B. SKUSE.
Geneva, N. Y., Oct. 2.

Very Little Surplus Honey.

I wish someone in northeast Colorado or southeast Wyoming that has bees for sale would advertise in the Bee Journal the price per colony, as I am thinking of moving to western Nebraska, and the Express company asks \$21.00 per 100 pounds for taking bees there from here. As I am only a beginner, that is too much to risk. Dry weather cut the honey crop short here—very little surplus. Bees are very slow of sale here at \$2.50 per colony, in movable-frame hives.
C. C. BEERS.
Pacific Co., Wash.

Enlarging Hives and Frames.

About 35 years ago we commenced keeping bees; bought one colony in a box-hive, and soon thereafter we paid \$5.00 for an individual right to use the Langstroth (then patent) frame, and bought a sample 10-frame hive with portico front and fast bottom. We soon sawed off the portico front, and knocked off the fast bottom; thus improved, we have been using the hive ever since. Not that it has been satisfactory, but we hesitated to make a change, having our fixtures complete.

We have repeatedly snffered heavy winter losses and spring dwindling, notwithstanding we have tried the cellar repository, and double walls with packing out-of-doors; but after reading the articles of the Dadants and others, published last winter, advocating larger frames and hives, we have pieced down our hive-bodies two inches at the bottom, and did likewise with the frames, cutting out nearly all the drone-cells, and filling in with worker-cells. This will give us quite an addition to our brood-frames, leave more room along the top-bars for honey-storage, and we think

NOW WE HAVE IT!
GLEASON'S
HORSE-BOOK!

The Only Complete and Authorized Work
by America's King of Horse-Trainers,
PROF. OSCAR R. GLEASON,

Renowned throughout America and recognized by the United States Government as the most expert and successful horseman of the age. The whole work comprises History, Breeding, Training, Breaking, Buying, Feeding, Grooming, Shoeing, Doctoring, Telling Age, and General Care of the Horse.

You will know all about a horse after you have read it.

No one can fool you on the age of a horse after you have read it.

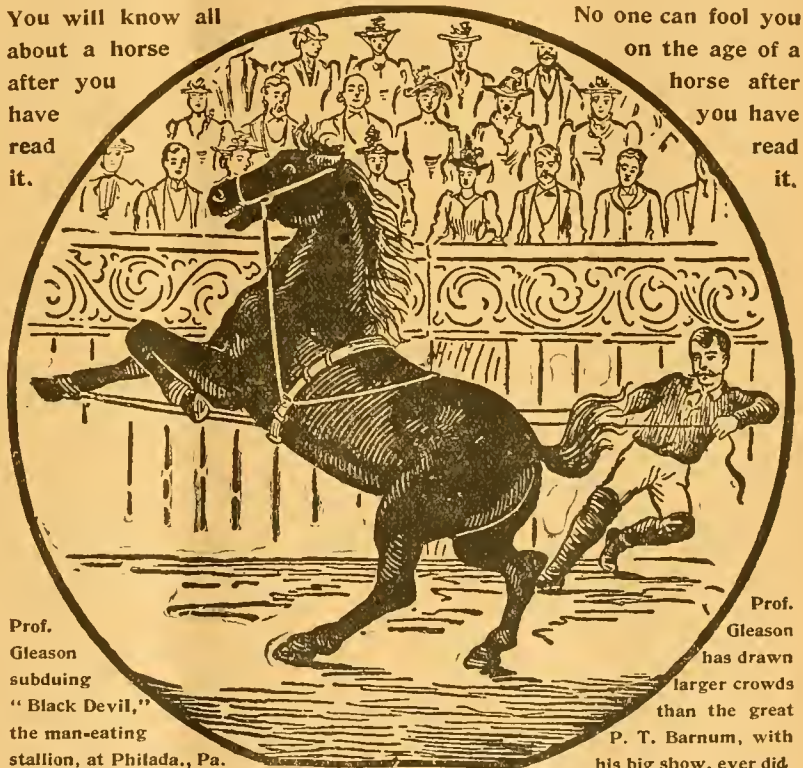

Prof. Gleason subduing "Black Devil," the man-eating stallion, at Philada., Pa.

Prof. Gleason has drawn larger crowds than the great P. T. Barnum, with his big show, ever did

416 Octavo Pages—173 Striking Illustrations.

Produced under the direction of the U. S. Government Veterinary Surgeon.

In this book Prof. Gleason has given to the world for the first time his most wonderful methods of training and treating horses

100,000 SOLD AT \$3.00 EACH.

But we have arranged to supply a limited number of copies to our subscribers absolutely free. Frst come, first served.

Here are Our Offers of this Great Book.

Regardless of the fact that thousands upon thousands of these books in cloth binding have been sold at \$3.00 each, we are enabled to, and will for a limited period, send a heavy-paper-bound copy FREE as a premium to our present regular subscribers for sending us **ONE NEW Subscriber** to the Bee Journal for a year at \$1.00; or we will mail the book and the Bee Journal for a year to any one sending us \$1.60. Address,

GEORGE W. YORK & CO.,
118 Michigan Street, - - CHICAGO, ILL.

it will help to solve the wintering problem, for frequently our bees would starve with honey in the outer frames which was not to be reached during a long, continuous cold spell. And this change of frame will not necessitate any change of fixtures—bottom-boards, covers, etc.

We now put in the hive—which has a width of 14 inches inside—nine frames; this gives us spacing room of 1½ inches to each frame, and a quarter inch next to the outside frame. This, we think, is better than any closer spacing, as it gives a little more room between the combs for bees to cluster in winter; also gives more depth of cell for honey-storing.

The honey-flow here has been quite continuous since apple-blossom, but we had a good many rainy, cloudy days in June and July, so that although the bees bred freely and swarmed, yet but little surplus was stored above.

They increased from 28 to 42 colonies, and have plenty of winter stores. This is all we expect. Last fall we had to feed, but that was the first time during our bee-keeping that our bees did not secure a sufficient supply for themselves.

Perhaps I ought to mention one thing further about piecing down the frames. Our frames were the old style, with ¼ wide top-bars, ¼ inch thick. We sawed off the projecting ends that rest on the rabbets, and nailed on a new top-piece, 1½ wide by ¼ thick; this strengthens the top so as not to sag with the increased weight of comb, and gives the up-to-date width. Then we pieced down the frame at the bottom with a ¼-inch splice on the inside of the end-pieces. This gives a hive and frame nearly the same as recommended by Mr. Dadant in the last number of the American Bee Journal, and any person can make the change that has the Langstroth frame, with no loss of fixtures, etc.

CHESTER BELDING.

Middletown, N. Y., Sept 28.

Satisfied with the Results.

When I came home from Colorado, in September, 1895, I found a good many around here keeping bees, but they could get no honey. So I bought two colonies and a nucleus, and I have six strong colonies now. I got four swarms from them, and lost one of them, so I have six colonies now, and they are all very strong. I have taken 96 pounds of section honey from them. They are in 8-frame hives, and all full of honey.

All I have to say about it is, if a man is afraid of bees, and will not take a bee-paper, or get a good bee-book, he had better let them alone. JOHN CRAIG.

Gillespie, Ill., Sept. 29.

Large Hives are His Hobby.

I like the Dadants' articles extremely well. Large hives have been my hobby for years. For myself, I want no smaller size than the 10-frame Langstroth hive, and if it were not for the extra expense in bottoms and covers, I would have 12 frames. I made six 10-frame hives this season, and they are the best colonies in the lot, with the same management. But as Adam Grimm said, an 8-frame hive will sell for just as much per colony, and we can make more of them. He urged me strongly to drop everything else, and go into bee-keeping exclusively.

Santa Ana, Calif. DR. E. GALLUP.

PROF. A. J. COOK'S BOOK FREE!

The Bee-Keeper's Guide
OR
MANUAL OF THE APIARY.

This 15th and latest edition of Prof. Cook's magnificent book of 460 pages, in neat and substantial cloth binding, we propose to give away to our present subscribers, for the work of getting new subscribers for the American Bee Journal.

A description of the book here is quite unnecessary—it is simply the most complete scientific and practical bee-book published today. Fully illustrated, and all written in the most fascinating style. The author is also too well-known to the whole bee-world to require any introduction. No bee-keeper is fully equipped, or his library complete, without "THE BEE-KEEPER'S GUIDE."

Given For 2 New Subscribers.

The following offer is made to PRESENT subscribers only, and no premium is also given to the two new subscribers—simply the Bee Journal for one year:

Send us Two New Subscribers to the Bee Journal (with \$2.00), and we will mail you a copy of Prof. Cook's book FREE as a premium. Prof. Cook's book alone sent for \$1.25, or we club it with the Bee Journal for a year—both together for only \$1.75. But surely anybody can get only 2 new subscribers to the Bee Journal for a year, and thus get the book as a premium. Let everybody try for it. Will you have one?

GEORGE W. YORK & CO., 118 Mich. St., CHICAGO, ILL.

✦ MONEY SAVED IS MONEY GAINED. ✦

THE ROYAL UNION
Life Insurance Company
DES MOINES, IOWA.

The Iowa Policy

Is one that definitely promises to keep an accurate account with you; credit your premiums and interest, charge the actual expense and mortality cost, and hold the remaining funds subject to your order.

Agents Wanted.

JOHN B. KING, GENERAL AGENT,
Suite 513 First Nat'l Bank Bld'g,
20A St CHICAGO, ILL.

Mention the American Bee Journal.

IF YOU WANT THE

BEE-BOOK

That covers the whole Apicultural Field more completely than any other published, send \$1.25 to Prof. A. J. Cook, Claremont, Calif., for his

Bee-Keeper's Guide.

Liberal Discounts to the Trade.

Mention the American Bee Journal.

DUQUESNE COLLEGE!

PENN AVE. AND EIGHTH ST.

PITTSBURG, PA.

Thorough Courses—Classical, Scientific, Normal, English, Commercial, Preparatory, and Ladies Literary. Efficient and experienced instructors. Day and Night sessions.

Send for Catalog.

Mention the American Bee Journal.

California

If you care to know of its Fruits, Flowers, Climate or Resources, send for a Sample Copy of California's Favorite Paper—

The Pacific Rural Press

The leading Horticultural and Agricultural paper of the Pacific Coast. Published weekly, handsomely illustrated, \$2.00 per annum. Sample Copy Free.

PACIFIC RURAL PRESS,
220 Market St., - SAN FRANCISCO, CAL.

Mention the American Bee Journal.

Honey-Clovers & Buckwheat
SEED FOR SALE.

We have made arrangements so that we can furnish seed of several of the Clovers and Japanese Buckwheat, by freight or express, at the following prices, cash with order

	5lb	10lb	25lb	50lb
Alsike Clover	\$.70	\$1.25	\$3.00	\$ 5.75
Sweet Clover	.75	1.40	3.25	6.00
White Clover	1.25	2.00	4.50	8.00
Alfalfa Clover	.65	1.10	2.70	5.00
Orlmon Clover	.55	.90	2.00	3.50
Jap. Buckwheat	.20	.35	.90	1.25

Prices subject to market changes.

Add 25 cents to your order, for cartage, if wanted by freight.

Your orders are solicited.

GEORGE W. YORK & CO.,
CHICAGO, ILLS.

Mention the American Bee Journal.

WOVEN WIRE FENCE

Over 50 Styles! The best on Earth. Horse high, Bull strong, Pig and Chicken tight. You can make from 40 to 60 rods per day for from 14 to 22c. a Rod. Illustrated Catalogue Free. KITSELMAN BROS., Ridgeville, - Indiana.

48EtF Mention the American Bee Journal.

My prices for **Untested Queens** for the next two weeks:

1 Queen, 40 cts.; 2 Queens, 75 cts.; 3 Queens \$1.00.

E. L. CARRINGTON,

16A St PETTUS, Bee Co., TEX
Reference—1st National Bank of Beville.

Mention the American Bee Journal.

BEGINNERS.

Beginners should have a copy of the Amateur Bee-Keeper, a 70-page book by Prof. J. W. Rouse. Price 25 cents; if sent by mail, 28c. The little book and the Progressive Bee-Keeper (a live, progressive 28-page monthly journal) one year, 65c. Address any first-class dealer, or

LEAHY MFG. CO., Higginville, Mo.

WHEN ANSWERING THIS ADVERTISEMENT, MENTION THIS JOURNAL.

A GOLD DOLLAR

is about the actual worth of our new book on Incubation and Poultry. Contains a full and complete description of the Reliable Incubator & the Brooder of same name, together with cuts and instructions for build'g poultry houses and much of interest and great value to the poultryman. Sent on receipt of 10c. RELIABLE INCUBATOR & BROODER CO. - QUINCY, ILL.

36E17t Please mention the Bee Journal.

HONEY and BEESWAX

MARKET QUOTATIONS.

The following rules for grading honey were adopted by the North American Bee-Keepers' Association, and, so far as possible, quotations are made according to these rules:

FANCY.—All sections to be well filled; combs straight, of even thickness, and firmly attached to all four sides; both wood and comb unsoiled by travel-stain, or otherwise; all the cells sealed except the row of cells next the wood.

No. 1.—All sections well filled, but combs uneven or crooked, detached at the bottom, or with but few cells unsealed; both wood and comb unsoiled by travel-stain or otherwise.

In addition to this the honey is to be classified according to color, using the terms white, amber and dark. That is, there will be "fancy white," "No. 1 dark," etc.

Chicago, Ill., Oct. 7.—Fancy white, 12¼@13c.; No. 1, 11@12c.; fancy amber, 9@10c.; No. 1, 8c.; fancy dark, 8@10c.; No. 1, 8c. Extracted, white, 5@7c.; amber, 5@6c.; dark, 4¼@5c. Beeswax, 25c.

The demand for the past two weeks has been of fair volume, enabling us to close out receipts promptly. We usually have the best trade of the year at this time, and it is also the season when comb honey bears transportation well.

Philadelphia, Pa., Sept. 30.—Extracted, white, 8-10c.; amber, 4-5c.; dark, 3-4c. Beeswax, 25c.

No new comb in this market yet. Old comb cleaned out.

Detroit, Mich.; Sept. 30.—No. 1 white, 12-12¼c.; fancy amber, 10-11c.; No. 1 amber, 9-10c.; fancy dark, 8-9c. Extracted, white, 5½-6c.; amber, 5-5½c.; dark, 4-5c. Beeswax, 24-25c.

Indianapolis, Ind., Oct. 3.—Fancy white, 14-15c.; No. 1 white, 12-13c. Extracted, white, 6-7c. Beeswax, 22-25c.

Demand is fair for grades quoted, but no demand for inferior grades.

St. Louis, Mo., Sept. 30.—Fancy white, 13@14c.; No. 1 white, 12@13¼c.; fancy amber, 11@11¼c.; No. 1 amber, 10@10¼c.; fancy dark, 8@9c.; No. 1 dark, 7@7¼c. Extracted, white, in cans, 5c.; in barrels, 4@4¼c.; amber, 3@3¼c.; dark, 2½@3c. Beeswax, 19@20c.

Very little honey coming in at present, and the weather is too warm to handle to advantage if it were here.

New York, N. Y., Oct. 9.—Fancy white, 12@13c.; off grades, 10@11c.; buckwheat, 8@9c. Extracted is in fair demand at unchanged prices. Beeswax is doing a little better, and firm at 24@25c.

There is a fair demand for fancy white comb honey, while off grades, mixed, and buckwheat are rather neglected. Receipts are heavy and stock accumulating. Sales are principally in small lots, and in order to move round quantities it is necessary to make concessions from quotations.

San Francisco, Calif., Sept. 23.—White comb, 10c.; amber, 7½-9c. Extracted, white, 5-5½c.; light amber, 4¼-4½c.; amber colored and candied, 3¼-4c.; dark tulle, 2¼-3c.

Not much new crop honey on market, and not likely to be the current season. At the rates prevailing, however, the demand is somewhat limited and almost wholly local. Stocks of 1895 crop in the hands of the wholesale and jobbing trade are almost exhausted. Most of the extracted of this year's yield has been forwarded East from the interior.

Beeswax, fair to choice, 23-26c. No change to note in values. For choice to select the market is moderately firm at the prevailing rates.

Albany, N. Y., Oct. 7.—Fancy white, 12-13c.; No. 1, 11-12c.; fancy amber, 9-10c.; No. 1 dark, 8-9c. Extracted, white, 6-7c.; dark, 4-5c.

The receipts of both comb and extracted honey are very large, and prices are somewhat lower. We have an ample stock of all styles except paper cartons weighing less than a pound.

Boston, Mass., Oct. 9.—Fancy white, 13-14c.; No. 1, 11-12c. Extracted, white, 6-7c.; amber, 5-6c. Beeswax, 25c.

Milwaukee, Wis., Sept. 30.—Fancy white, 14-15c.; No. 1, 12-13c.; No. 1 amber, 8-10c. Extracted, white, 6-7c.; amber, 5-6c.; dark, 4-5c. Beeswax, 22-24c.

New crop of honey begins to come forward. The demand is very poor and quotations almost nominal. Weather is very warm and the consumption of honey is very small. Plenty of fruit, and hence the appetite is satisfied with same in preference. Later on we expect an improved demand for honey of all kinds.

Minneapolis, Minn., Sept. 30.—Fancy white, 12¼c.; No. 1 white, 10@11c.; fancy amber, 9@10c.; No. 1 amber, 8@9c.; fancy dark, 7@8c.; No. 1 dark, 6-8c. Extracted, white, 5½@6¼c.; amber, 5@5½c.; dark, 4@5c. Beeswax, 23@26c.

The demand for both comb and extracted is very quiet, and for the latter, nominal. The hot weather of the past week or so has checked demand for comb honey.

Cleveland, Ohio, Sept. 30.—Fancy white, 14¼@15c.; No. 1 white, 12¼@13c. Extracted, white, 6@7c.; amber, 4¼@5¼c. Beeswax, 22@25c.

There is not very much honey in our market. Selling rather slow. Demand beginning to be a little better. Think trade will be fair in this line this fall.

Kansas City, Mo., Sept. 30.—Fancy white comb, 15c.; No. 1 white, 13@14c.; fancy amber, 12-13c.; No. 1 amber, 11-12c.; fancy dark, 10-11c.; No. 1, 8-10c. Extracted, white, 6-6¼c.; amber, 5-5½c.; dark, 4-4¼c. Beeswax, 22-25c.

Buffalo, N. Y., Oct. 9.—Fancy comb, 1-1 pound, mostly 12c., occasionally 13-14c.; No. 2, 8-10c.; No. 3, 4-7c. Extracted, 4-5c. Demand grows better as fruit decreases.

List of Honey and Beeswax Dealers.

Most of whom Quote in this Journal.

Chicago, Ills.

R. A. BURNETT & Co., 163 South Water Street.

New York, N. Y.

HILDRETH BROS. & SGOELKEN,
120 & 122 West Broadway.
CHAS. ISRAEL & BROS., 486 Canal St.

Kansas City, Mo.

O. C. CLEMOMS & Co., 423 Walnut St.

Buffalo, N. Y.

BATTERSON & Co., 167 & 169 Scott St.

Hamilton, Ills.

CHAS. DADANT & SON.

Philadelphia, Pa.

WM. A. SELSER, 10 Vine St.

Cleveland, Ohio.

WILLIAMS BROS., 80 & 82 Broadway.

St. Louis, Mo.

WESTCOTT COM. CO., 213 Market St.

Minneapolis, Minn.

S. H. HALL & CO.

Milwaukee, Wis.

A. V. BISHOP & CO.

Boston, Mass.

E. E. BLAKE & Co., 57 Chatham Street.

Detroit, Mich.

M. H. HUNT, Bell Branch, Wayne Co., Mich.

Indianapolis, Ind.

WALTER S. POWDER, 162 Massachusetts Ave.

Albany, N. Y.

CHAS. MCCULLOCH & Co., 380 Broadway.

Cincinnati, Ohio.

C. F. MUTH & SON, cor. Freeman & Central avs.

READERS Of this Journal who write to any of our advertisers, either in ordering, or asking about the Goods offered, will please state that they saw the Advertisement in this paper.

Convention Notices.

CONNECTICUT.—The fall meeting of the Connecticut Bee-Keepers' Association will be held at the Capitol at Hartford, on Oct. 31, 1896, at 10:30 a.m. All interested in bees and the production of honey are invited to attend this meeting.

Waterbury, Conn. Mrs. W. E. RILEY, Sec.

National Bee-Keepers' Union.

PRESIDENT—Hon. R. L. Taylor, Lapeer, Mich.
GEN'L MOR.—T. G. Newman, San Diego, Cal.

Queens and Queen-Rearing.

If you want to know how to have queens fertilized in upper stories while the old queen is still laying below; how you may safely introduce any queen, at any time of the year when bees can fly; all about the different races of bees; all about shipping queens, queen-cages, candy for queen-cages, etc.; all about forming nuclei, multiplying or uniting bees, or weak colonies, etc.; or, in fact, everything about the queen-business which you may want to know—send for Doolittle's "Scientific Queen-Rearing"—a book of over 170 pages, which is as interesting as a story. Here are some good offers of this book:

Bound in cloth, postpaid, \$1.00; or clubbed with the BEE JOURNAL for one year—both for only \$1.75; or given free as a premium for sending us three new subscribers to the BEE JOURNAL for a year at \$1.00 each.

Bee-Keepers' Photograph.

We have now on hand a limited number of excellent photographs of prominent bee-keepers—a number of pictures on one card. The likeness of 49 of them are shown on one of the photographs, and 121 on the other. We will send them, postpaid, for 30 cents each, mailing from the 121 kind first; then after they are all gone, we will send the 49 kind. So those who order first will get the most "faces" for their money. Send orders to the Bee Journal office.

Please Send Us the Names of your neighbors who keep bees, and we will send them sample copies of the BEE JOURNAL. Then please call upon them and get them to subscribe with you, and secure some of the premiums we offer.

CORRECT MANNERS: HOW TO BEHAVE IN SOCIETY.

Containing clear and concise directions for correct manners and usages of polite society. Many people have been misjudged for years simply because they had neglected to perform some little polite act at the proper time; many young men and women have lost the opportunities of a life-time on account of their ignorance of some trifling customary rule of Society. Our BOOK tells about it. 186 pages. Russia. Red Edges. Price, 75 cts.



Special Offer: We will mail this book free to you as a premium to any one sending us two New Subscribers to the Bee Journal for one year (with \$2.00), and also send a copy of the premium book "Bees and Honey" to each of the new subscribers; or we will club the book with the Bee Journal for a year—both for \$1.00.

GEORGE W. YORK & CO.,
CHICAGO, ILLS.

Bottom Prices

**BRING US BIG TRADE.
GOOD GOODS KEEP IT.**

If you want the best supplies that can be made at a little less cost than you can buy the same goods for elsewhere, write to us for low prices. 1896 Catalogue now ready—ask for it and a free copy of *The American Bee-Keeper* (36 pages).

Address,
**THE W. T. FALCONER MFG. CO.,
JAMESTOWN, N. Y.**

Mention the American Bee Journal.

COMB FOUNDATION!

Wax always wanted for Cash or in Exchange for Fdn. or other Supplies. My trade is established on **Low Prices** and the merit of my **Foundation. Orders filled promptly.**

WORKING WAX INTO FDN. BY THE LB. A SPECIALTY. Wholesale prices to dealers and large consumers. Send for Prices and Samples to—**GUS DITTMER, AUGUSTA, WIS.** Reference—Augusta Bank. 1A1f

Mention the American Bee Journal.

MUTH'S HONEY EXTRACTOR

PERFECTION
Cold-Blast Smokers,

Square Glass Honey Jars, Etc.

For Circulars, apply to CHAS. F. MUTH & SON, Cor. Freeman & Central Aves., Cincinnati, O. Send 10c for Practical Hints to Bee-Keepers.

Mention the American Bee Journal.



ONE MAN WITH THE UNION COMBINATION SAW

Can do the work of four men using hand tools, in Rippling, Cutting-off, Mitering, Rabbering, Grooving, Gaining, Dadoing, Edging-up, Jointing Stuff, etc. Full Line of Foot and Hand Power Machinery Sold on Trial. Catalogue Free.

**SENECA FALLS MFG. CO.,
46 Water St., SENECA FALLS, N. Y.
1A1y** *Mention the American Bee Journal.*

HONEY-JARS!

1-lb. square Flint Jars, with Corks, \$4.85 per gross. Including Labels, name and address on same, \$5.10 per gross.

A Full Line of Supplies on hand. Catalogue.

**I. J. STRINGHAM,
105 Park Place. NEW YORK, N. Y.
APIARY—Glen Cove, L. I.**

Mention the American Bee Journal.

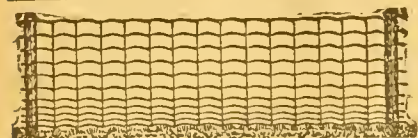

SINGLE STANDARD

However opinions may differ on the financial question, there has been no demand for a change in the fence standard. "Just as good as the Page" is current everywhere, if you can safely rely on the promise being redeemed. After all, it is better to get the genuine stuff and take no chances. Write

PAGE WOVEN WIRE FENCE CO., Adrian, Mich.

Mention the American Bee Journal.

19th Year Dadant's Foundation 19th Year

Is still in the lead, for we use all the latest improvements, including the

NEW WEED PROCESS,

and still make the best goods. Remember that we do not use any acid to purify our beeswax, and that is why our Foundation preserves the smell of the honey and is more acceptable to the bees, than any other. It is kept for sale by

T. H. Strickler, Solomon City, Kansas.
G. K. Hubbard, Fort Wayne, Ind.
L. Hanssen, Davenport, Iowa.
C. Theilmann, Theilmanton, Minn.
E. C. Eaglesfield, Berlin, Wis.
E. T. Abbott, St. Joseph, Mo.
J. M. Jenkins, Wetumpka, Alabama
John Rey, East Saginaw, Mich.
Vickery Bros., Evansville, Ind.

The Jennie Atchley Company, Beeville, Texas.
C. F. Muth & Son, Cincinnati, Ohio
E. Kretchmer, Red Oak, Iowa.
G. B. Lewis Co., Watertown, Wis.
James Reynolds Elevator Co., Poughkeepsie, N. Y.
Louisiana Bee-Keepers' Supply Manufactory, Donaldsonville, La.
Page & Lyon, New London, Wis.
John Nebel & Son, High Hill, Mo.

and many other Dealers. All agree in saying that no goods are better than ours.

We make a specialty of **Veils and Veil-Stuffs** of best quality, cotton and silk.

Langstroth on the Honey-Bee, Revised

Bee-Keepers' Supplies, Smokers, Sections, Tin Pails, etc.

Samples of Foundation and Tulle FREE with Circular. Instructions to beginners with Circular. Send us your address.

CHAS. DADANT & SON,

Mention the American Bee Journal.

HAMILTON, Hancock Co., ILL.



There Is No Doubt About the **MERIT** of **DEHORNING**

It cuts both ways, does not crush. One clip and the horns are off close. Write for circular. **A. C. BROSIUS, Cochransville, Pa.**

Mention the American Bee Journal 40E13t

* Extracted Honey *



Finest Quality. Basswood and Clover.
2 60-lb. cans in case 7c. per pound. 1 60-lb. can in case, 8c. per pound. A sample by mail, 10 cts. **POUDER'S Honey-Jars and Complete Line of Supplies. Catalogue Free.**

**WALTER S. POWDER,
162 Mass. Avenue. INDIANAPOLIS, IND.**

PATENT WIRED COMB FOUNDATION



**Has No Sag in Brood-Frames
Thin Flat-Bottom Foundation
Has No Fishbone in the Surplus Honey.**

Being the cleanest is usually worked the quickest of any Foundation made

**J. VAN DEUSEN & SONS,
Sole Manufacturers,
Sprout Brook Montgomery Co., N. Y.**

Root's Double-Walled Dovetailed Chaff Hives, and Winter-Cases for Single-Wal'ed Hives,

Have met with much success everywhere in wintering. The Double-Walled Chaff Hive is light, neat, compact, and weighs only a trifle more than the single-walled hives of the same capacity. Now is the time to lay in your stock for winter.

Send for Catalog and Prices.

THE A. I. ROOT COMPANY,

Factory and Main Office, **MEDINA, O.**

BRANCH OFFICES:

**115 Michigan St., Chicago, Ill.
1024 Miss. Str., St. Paul, Minn.**

**Syracuse, N. Y.
Mechanic Falls, Maine.**

AMERICAN BEE JOURNAL

DEVOTED EXCLUSIVELY TO THE INTERESTS OF HONEY-PRODUCERS

ESTABLISHED 1861
THE OLDEST BEE-PAPER IN AMERICA

Published Weekly, at \$1.00 per annum.

Sample Copy sent on Application.

36th Year.

CHICAGO, ILL., OCTOBER 22, 1896.

No. 43.

Report of the Proceedings

OF THE

Twenty-Seventh Annual Convention

OF THE

North American Bee-Keepers' Association,

HELD AT

LINCOLN, NEBR., October 7 and 8, 1896.

BY DR. A. B. MASON, SEC.

The convention was called to order by the President, A. I. Root, of Medina, Ohio, at 10:15 a.m., in the chapel of the State University, at the close of the students' chapel service. During this service most of the bee-keepers present were seated on the platform, with the Chancellor of the University.

Master Johnnie Heath, the 12 year-old son of H. E. Heath, the editor of the Nebraska Farmer, gave a piano solo, entitled "Ben-Hur March."

Then came the following paper by Hoo. E. Whitcomb, of Friend, Nebr., on

Importance of Watering in the Apiary.

Many bee-keepers have entirely overlooked the importance of bringing water into the apiary and thus allowing the bee to search for this much-needed article as best she can, and usually at a great loss to the colony, especially during the warm days in winter and early spring. Like the farm or dairy, it is a close attention to the small items that pays best, and negligence in the apiary is just as prolific of losses as when applied to any other industry. Many of us as bee-keepers do not consider the important uses to which water is applied to the apiary, or the losses resulting from a neglect to fully and carefully supply it.

The necessity of water by the honey-bees is to dissolve honey which sometimes becomes candied in the cells, and in brood-rearing they can make but little progress without an abundant supply of water. In early spring, when compelled to go long distances or to secure a supply from hydrants, tanks, brooks or drains, the losses will be beyond comprehension, and the careful apiarist is fully aware of the value of these little water-gatherers at this season of the year. He could well afford to lose four times their number a month or two later on. It is apparent that many cases of so-called spring-dwindling is traceable to the want of water of the proper temperature supplied at convenient places in the apiary.

The advantages of providing water for the bee is, first, to avoid the disease called thirst; second, when allowed to forage away from the apiary they obtain, oftentimes, that which is impure and of so low a temperature that it is injurious to the delicate organism of the bee, and it becomes chilled and cannot return to the hive.

To obviate these difficulties I bring the water in close proximity to the colony, in all its purity, and in a condition of temperature best suited to meet the requirements of the delicate form of the bee. Thus she may secure an abundant supply on making the shortest possible journey to and fro, and also at a temperature even warmer than the surrounding

atmosphere. Many of us have taken great pains in locating the apiary to secure the most sheltered point, where the chilling winds of spring may be the least liable to reach them, and at the same time have allowed our bees to wander out perhaps a mile into the cool currents of air in quest of water, perchance sipping the water from tanks or streams almost ice cold, and yet our colonies wintered fairly well, but we complain of losing a great per cent. by spring dwindling, and giving the matter a little thought, water had the most to do with our difficulties.

To avoid this almost entirely, I have adopted the plan of supplying an abundance of pure drinking water in easy access



Chancellor McLean, of Nebraska State University.

to the colony. To accomplish this as effectually and cheaply as possible, I use the one-half gallon fruit-jar, removing the screw top and rubber (any tight vessel will answer equally as well), and taking an inch board from four to eight inches square (the size is immaterial); now with a small gauge or a common pocket-knife cut a groove diagonally across the block nearly from one corner to the opposite one, taking care not to cut the groove quite to the corner. The center of this block may be cut out to suit your fancy, and may be turned if so desired, and you have an excellent and cheaply devised watering apparatus.

Now fill the jar with water, placing the block over the mouth of the jar, invert the whole, and set in convenient places or desired points in the apiary. The points I claim for

this device are its simplicity and cheapness, and after the breeding season is past, and there is little need of watering, the jar is of as much utility in the kitchen as it was last year while the good house-wife was putting up the winter's supply of fruit.

Again, when the weather is so mild that the bee can fly in quest of water, the sun's rays shining upon the water through the inverted jar, warms its contents quickly, and the bee gets a supply without being chilled or a failure to return with the much-needed water or even a danger of wet feet. To avoid the difficulty of readily attracting the bee to its new watering



Hon. E. Whitcomb, Friend, Nebr.

place, I would recommend slightly sweetening the water in these jars for a day or two, and everything will move on smoothly afterwards.

So far as our observation has gone, during the height of brood-rearing, and taking no note of evaporations, five well-stocked colonies will use the majority of one of these jars of water daily.

Thus the careful, far seeing apiarist will be able at once to see the importance of watering in the apiary, and also of lessening the flight to and fro, and assuring its purity and temperature best suited to the delicate organism of the honey-bee.

E. WHITCOMB.

After Mr. Whitcomb had read his paper, he said he had a jar with him with which he would like to illustrate his method of watering, it having been illustrated in the institute work of the State. He said:

"I water my bees in the most crude manner possible, by taking a quart jar, fill it with water, invert it and set it on a block about eight inches square, in which you will see grooves are cut. Enough water seeps out to afford the bees drink. Mr Davidson, of Omaha, desired me to come to see him. I went, and together we looked over his bee-yard. I found he had chosen a very good place for his apiary; the man declared as we went along that his bees were not there. It was sheltered where his apiary was, and it was warm where we were, but they must have water. He went to the hydrant and found them there, where they got the cold water and could not get back, and he said he had lost many of them. After this experience, he got a few jars, and has since said that his bees were doing finely. A few months ago I visited him, and found him delighted with his new plan."

Pres. Root—You do not tell of the gallon jar, but only of the quart.

Mr. Whitcomb—The size is immaterial.

Mrs. A. L. Amos, Coburg, Nebr.—I would like to say that we must not depend too much upon the jars. I had quite a number, and they will break.

Dr. C. C. Miller, Marengo, Ill.—Do you keep these jars going all the time? We don't need as many jars in the fall as we do at the time of breeding. The bee must have water in order to carry on breeding, and many of them never get back if they encounter some cold wave.

L. D. Stilson, York, Nebr.—I use hotbed sash to save the lives of my bees. I set the glass up so that the rays of the sun will reflect upon the jars, and I find this adds to warmth and to saving the life of the bee. Two hotbed sash will cover a dozen jars or more.

Rev. E. T. Abbott, St. Joseph, Mo.—Cannot tin cans be used?

Mr. Abbott's question was answered in the affirmative.

J. H. Masters, Nebraska City, Nebr.—I have always watered my bees, but I have a different plan. I have what we call a goose-neck hydrant. This is a pipe we use, and we can run off the water at any time. I use an old stove bottom, put in some hay or straw, and then set it under the hydrant and turn it on so that it will just drip. I then set it where the sun's rays can strike it, and it gets warmed up. This is the best plan for watering that I have ever tried. I am satisfied that the only reason that I have never been troubled with spring dwindling of bees is the fact that I have always kept my bees watered. I notice that the bees prefer cool water; they have been seen in great numbers around the drippings from the ice-box instead of going to the hydrant: if the days are a little cool they go to the hydrant all the time.

J. S. Lovell, Council Bluffs, Iowa—I was never so impressed with the fact that bees are no exception to the animate nature, as I was last summer when crossing Valley county, this State. I found the bees at the pump; they were there in great numbers, hundreds of them, so we could hardly lead the stock there to drink. We went on farther and nitched; these bees went there and took possession of that water-tub. I shall tell the gentleman to fix to water his bees. I believe they get thirsty and must drink.

T. R. DeLong, Angus, Nebr.—I am interested in bee-work somewhat, and I have been thinking ever since Mr. Whitcomb read his paper that I had neglected my bee-watering in the apiary. My bees went to the water-tank, but the principal reason why I have not adopted that system of watering is the fact that the Little Blue river runs near my apiary, which is protected and well shaded by fruit-trees. I never let the bees out in cool weather, and I don't think I have ever suffered any loss. I shall try this system of watering in my orchard, and have it adopted throughout the community in which I live. I don't think I suffered any loss from a cool current of atmosphere.

Question—How do you keep your bees from flying?

Mr. DeLong—I close the openings. I am real interested in bee-culture; when I hear the bees humming I can usually tell the condition of the atmosphere.

Dr. Miller—I would like to ask how many there are present who make provision for watering their bees? I suppose many don't do anything with this matter.

This question was put; seven watered their bees and four do not water them, others not voting.

Fred Biesemier, Sterling, Nebr.—I make provision for watering my bees, and I would say that I use the jars, and never have any trouble as to losing bees, by their getting chilled.

Mr. Stilson—In regard to watering bees, I would say that my apiary is located in such a manner as to be sheltered on three sides by frame buildings, and a fence on the other side; and 150 feet from my apiary is a pond. I have another pond 200 feet away, and I find that bees watered in this manner go to the nearer place; in going this distance in cold weather many freeze.

Some member arose and said: "I use stone jars holding 5 or 6 gallons, and I think there is no better plan than this."

Mr. Stilson—I have a word to say with reference to the jars being placed in the sun. This is a good plan, as the sun's rays will warm the atmosphere around the jars, and also the reflection of the sun on the jar will warm the water. Some times, in cool weather, I have taken a sheet of glass and put

over the jar so as to reflect the heat on the jar, and in this way I have saved the lives of many of my bees.

Mr. Abbott—I do my chickens a service. I don't water my bees—I turn them in with the chickens. Perhaps some here do not know that chickens drink—I know they do. I use wooden boxes about 2 inches deep and 12 inches square; these boxes were made for bee-feeders, as they had been coated with beeswax. I set the boxes 6 or 8 inches from the ground, then put a raised cover on the top so the chickens cannot get up and soil the water; in this way both bees and chickens can drink.

A member asked: "How do the chickens like their associates?"

Mr. Abbott—The chickens don't care. Chickens have more sense than some people.

Do they drink together all right?

Mr. Abbott—Yes.

Do you let them roost together?

Mr. Abbott—No, sir; I do not. (Laughter.) This is a very convenient way to water bees, and as I think more of my chickens than I do of my bees, of course I use this method.

Dr. A. B. Mason, of Toledo, Ohio—I water my bees with gallon jars, and salt the water to keep it pure, and put in corn-cobs or pieces of wood to keep the bees from being drowned.

Following this discussion Mr. L. D. Stilson read a paper on

Some of the Conditions of Nebraska.

To some of you it may seem strange that we should have conditions here which are not found elsewhere; surroundings make new conditions. As you will readily observe by looking at the map, we occupy a central location in the United States. This, of itself, would not create conditions different from other States or localities. But look further and see our beautiful State lying just at the foot of the mighty Rockies, and only a little ways from our western border is the line of eternal snow. Then look to the north, the east, the south, and find us in the midst of the greatest garden-spot in the world, and you begin to realize some of the possibilities the future has in store for us. Here seems to be a central meeting-place for widely-varied conditions.

The pioneer bee-keeper, like the pioneer farmer, on these broad, fertile prairies had to begin his experimental work all over again; he was met by conditions which were untried and of which he knew nothing. The honey-flow was new to him, thousands of acres, rich in flowers, but not a tree or bush in sight, was not at first sight an inviting field for the apiarist. Wild bees were to be found along the Missouri river, along our eastern border. As the settler moved westward he took with him the few hives of bees. These increased equally well, whether located along some stream or whether placed along the high tablelands in the central part of the State. A little study on the part of the master, soon taught him that the flora of the State was a rich field for the honey-gleaner; and that the wind and waters had brought down from the peaks of the western mountains, plants of such hardy nature that ere the frosts of winter had left the ground at their roots, the tops were furnishing honey and pollen for the honey-bee, while species of the same families brought to us from the South or East would be 10 or 20 days later, thus extending the honey-harvest. In this way we find the red cedar, wild plums, wild grapes and wild cherries; these, with many of the small plants, are valuable in furnishing food for building up early in the spring.

When the missionaries first went to a certain race of heathen they found each man had, or was making for himself, an idol. Among the articles carried by the missionaries were some cocoanuts; these the natives soon seized upon as gods ready-made. When we, as pioneers, first came to Nebraska, we did not have to hew out farms from the timber, as in the Eastern States, but we found farms ready-made. But ready-made as they were, like the idolator, we knew not how to grow crops to the best advantage, and to some of us, at least, it is a study yet. We plowed too much land, we sowed too much grain, we planted too much corn, and as a consequence, weeds infested the land, and for several years past the great bulk of our honey has been produced from "heart's-ease"—a plant something like the smartweed of the East. It grows in every waste place, it springs up in every stubble field, and no matter whether it is dwarfed by drouth to a tiny

plant of a few inches, or whether watered by copious showers and grows to the height of a man, it always blossoms full, and is always laden with honey.

It is said that necessity is the mother of invention. Necessity is only putting a man where he is obliged to think and act for himself. Necessity is only putting a man upon his own individual manhood.

Here in Nebraska necessity has put a good many of us where we are obliged to do some good, hard thinking for ourselves, and as bee-keepers it has done us good. Instead of moving our apiaries, as some of our Eastern friends advise, so as to keep near the virgin forests, we continue to plant and to hoe, to reap and to mow, but in our planting we look to a double harvest, learning by study and experience that the tree or plant richest in honey is also richest in fruit, grain or forage, so that not only do we plant for grain or fruit, but for honey as well. We are learning that the best forage clovers make better beef and butter when they are the richest in honey. The fruit-blossoms rich in honey, produce as rich or richer fruits than those which produce none.

Nebraska is to-day a land of groves, planted by the pioneer farmer. Many of these groves were planted with a treble end in view—first a wind-break or screen, second for fuel, and third for their fruits or honey. It costs no more to set trees which serve these three purposes, and the wide-awake tree-planter was not slow to catch the idea.

The climate of our State is such that plants secrete very rich nectar, so that the bee can gather it and after storing in the hive it can at once be sealed over, retaining to a great extent the aroma of the flower from which it was gathered. A few years ago we extracted from one super clean, returning the combs, and in four days we extracted 50 pounds again, nearly all sealed, and weighing 15 pounds to the measured gallon. This was pure heart's-ease, and samples have never shown granulation.

In bee-keeping, as in all other branches of agriculture, we have made serious mistakes. We have profited by some of these, but of others we are still at sea, the compass broken, and the log-book lost.

The winter problem is to us one of great interest. Some seasons our bees will go through the winter with little or no loss, then again under seemingly the same conditions, a single day of wind, dust, and snow will wipe the apiary out of existence. How to avoid these losses we have no certain rule.



Mr. L. D. Stilson, York, Nebr.

Tell us, ye wise men, how to avoid these winter losses, and ye shall be held in grateful remembrance.

As a rule, the bee-keepers of the State have had but little difficulty in disposing of their honey crops at fairly good prices. True, at such centers as Lincoln and Omaha the shipment of Southern and California honey keeps the prices lower than in the interior of the State, and he who forces his honey, be it ever so good, onto an overstocked market, loses by the operation. But the wide-awake, practical bee-keeper who puts up his honey in fine shape and courts the home market of his nearest town, invariably receives good returns for

his honey. As a rule, we have no use for the commission-men in our business. They are of no value to us in disposing of our apian products. We believe in selling by the producer direct to the consumer, with no interference of middlemen.

As a whole, our Nebraska bee-keepers are students of the text-books on apiculture, and readers of the various bee-papers of the nation. They are attendants at the farmers' institutes and farmers' conventions, and consequently the patent-right shark has poor picking here. Our people do not consider that to buy a farm, township or county right of some new-fangled notion or nostrum is the right road to success in bee-culture.

We have learned long ago that we do not know all of bee-culture; therefore, it was

Resolved, To invite the wise men of the East, the West, the North, and the South to hold this convention here, that we might sit at your feet and learn, not bickering and strife, but in brotherly love explain the systems best in practice by you in the avocation in which we are all engaged.

L. D. STILSON.

As no discussion followed Mr. Stilson's paper, Prof. Lawrence Bruner, Entomologist of the Nebraska State University, gave a very interesting talk on "The Wild Bees of Nebraska," many of which, with the honey-bee, were illustrated on a large map, as were also their heads, tongues and legs.

At the Secretary's request, Prof. Bruner very kindly consented to put his "talk" on paper, and it is as follows:

The Wild Bees of Nebraska.

Incidentally, in connection with the work as taken up, when making observations on the visits of the honey-bee to various flowers, the wild bees have been collected and studied. The present paper is a partial result of such studies.

The title chosen for this paper may have been somewhat misleading to many of those present. They may have thought to themselves, "Why, have we many wild bees in this State? and, if so, where do they live?" That this thought may not remain with them any longer than possible, I wish at once to say that it is chiefly of other than the honey-bee that I am to talk.

Unless one has paid some attention to the study of insects in general, he or she is very apt to imagine that a bee is a bee, a bug a bug, and a grasshopper a grasshopper—that there are several or even many distinct kinds of each of these insects never occurs to him or her. The entomologist, however, soon learns to his sorrow that the variety of insect life is great. He begins to wish that there were less kinds, and that each lacked their particular and peculiar habits—the subject begins to enlarge so greatly.

By a very little work in the direction of collecting specimens of the native or wild bees of this State, we have already gathered close to 200 distinct kinds. Some of these are large and quite conspicuous, hence are known to most of us. Others are very small and inconspicuous, and are unknown even to most entomologists.

All bees are more or less connected with the fertilization of flowers—*i. e.*, they gather and carry the pollen from one flower to another. These flowers among themselves are constructed on very different plans, hence require different methods for bringing about their pollenization or fertilization. It stands to reason, then, that the bees which perform this task must differ one from the other in structure as well as in habit.

Our efforts thus far have been confined principally to the gathering or capturing and naming of these bees, with the result that there already have been brought together in the neighborhood of 200 distinct species or kinds. These belong to at least 37 distinct genera, and possibly to others still unrecognized. It is estimated that by future work in this same direction there will be at least 100 additional forms found to inhabit our State, since our studies in other directions go to show that the State is one exceedingly rich in its flora and fauna. Our birds seem to exceed those of any of our sister States by fully a half hundred kinds. We have more species of grasshoppers than they, and our tiger beetle are double theirs. Our botanists tell us that the kinds of plants belonging to our flora are similarly extensive.

All bees differ from their allies—the wasps—in being anthropophilous, or honey and pollen eating, instead of carnivorous. As has already been hinted, our native bees vary greatly one from another in color, structure, size, and habits. This is to be expected when we take into consideration their numbers and the vastly different flowers from which they must obtain their food and that for their young.

First of all, much depends upon the form and length of a bee's tongue, whether or not it will be able to reach and secure the nectar that lies more or less deeply hidden away within the recesses of flowers. Not all bees are equally well equipped in respect to this organ. Some have this organ short and blunt, hence are confined in their search for food to such flowers as have their nectar near the surface. Others have their tongue excessively lengthened, and therefore can obtain nourishment from deeper flowers. Some bees are slender and are thus enabled to creep into flowers where plumper-bodied species could not venture. A few of our bees are solely nectar-gatherers, but most gather both the nectar and pollen. All of them feed their young with either nectar or pollen, or a combination of the two.

The representatives of a few genera are parasitic, living as guests (uninvited) in the nests of hosts that are obliged to work for them for nothing. Cuckoo-like, these parasites linger near the nests of their hosts until the latter has a cell about completed and provisioned, and are away, when they stealthily enter and leave an egg, and are off, ready to repeat the operation when opportunity presents. These parasitic bees are just as particular about their homes for their prospective offspring as are all parasites. To this end they invariably select the nest of some particular host, a given parasite invariably choosing the same species for its host. In this way the careful observer can frequently determine the presence of a particular bee in a given region, although he may not have been fortunate enough to see or take it.

While the hive-bee, or honey-bee, is social in its habits, and contains an additional form (worker) to the female (queen) and male (drone), nearly all of the wild bees are solitary and are without this worker. Only the bumble-bees are thus provided, and here more than one female are to be found in a single colony.

Where the student has so many distinct forms to deal with as he has here, it becomes necessary for him to select sure means for their separation. This has already been accomplished, and it is now comparatively easy for us to locate any bee in the group where it naturally belongs. Some of the characters thus employed are wing venation, presence or absence of spines on the legs, length of tongue, number of joints in the lip and jaw appendages, and the absence or presence in varying amount of hair upon the body or legs of the bee which is to be classified.

Taking up some of our native bees separately, it has been found that about the following can be said of their appearance and mode of life:

The genus *Holletes* is composed of rather robust, hairy, wasp-like insects more or less well equipped for carrying pollen, which they carry to their solitary nests for food for their young. The nests are made in the ground by the female, and are filled cell by cell with pollen, and an egg laid in each when finished. There are probably two broods a year.

To the genus *Prosopis* belong bees with coal-black and naked bodies. These bees are said to fill their brood-cells "with a mixture of disgorged honey and pollen." The cells are lined with a hard cement which is smoothed out with the broad, short tongue, and given the appearance of earthenware. Although not strictly confined to certain flowers for their food supply, they habitually choose strongly-scented ones for this purpose.

The species of *Sphecodes*, also black or black and red bees with comparatively naked bodies, have similar habits with those of the preceding genus. The tongues in these are a trifle longer, and hence their possessors are less restricted in their foraging.

The species of *Halictus* are still more favored in their development of tongue and pollen-gathering apparatus, and accordingly visit more flowers in their season for food for self and young. The genus is very extensive and contains some of our smallest bees, a few of them measuring less than one-thirtieth of an inch in length. Only a comparatively few of the many species found in our State have been named, hence the worker must first see to this important work before he can record any possible special habits belonging to any given form.

Our most brightly-colored bees belong to the genera *Augochlora* and *Azapotemon*, both of which are made up of forms having their bodies in part or entirely metallic green or blue. Some of these also are very small, and are as yet unnamed.

The genus *Andrena* is perhaps the largest one belonging to our fauna, and like *Halictus* is made up of forms most of which are new to science. As shown by the illustration these bees are admirably fitted for collecting pollen with which they provision their nests.

The genus *Nomia* comprises but three or four distinct

specimens related to *Andrena* in habit, but differing much in the structure of the hind legs and antennæ of the males. *Eunomia* also belongs near here. It has but two representatives of our fauna.

The genera *Macropis*, *Megacilissa*, *Panurgus*, *Calliopsis* and *Perdita*, with possibly one or two others, are represented by from one to several species each. None of these have been studied with sufficient care thus to warrant our trying to give their habits at this time.

In the genus *Nomada* we have bunched an extensive series of brightly-marked, small to medium-sized, wasp-like parasitic bees. These are loafers that through disuse, possibly, have lost the pollen gathering and carrying arrangements that at one time may have belonged to their ancestors. Living as they do in the nests of different species of *Andrena* and *Halictus*, each with some particular host, there are many species of them.

Another genus of these parasitic bees quite common to Nebraska is *Epeopus*, the various species of which live in the nests of *Colletes*.

Melecta, *Stelis* and *Coelioxys* are also genera of the cuckoo tribe. They impose the caring and rearing of their young respectively upon the members of the genera *Anthophora*, *Osmia* and *Megachile*.

The different species of the genus *Osmia* are usually metallic green or blue, but others are plain black. These bees with several other genera are provided with pollen-gathering hairs upon the ventral side of the abdomen. Some of them nest in the ground, others in wood or the stems of plants, and still others are said to select the deserted shells of snails for that purpose.

Heriades, *Monumentha*, *Anthidium* and *Lithurgus* are allied genera with but few representatives in our State.

To the genus *Megachile*, which is an extensive one, belong the leaf-cutters. These are, for the most part, rather large, robust bees which are very thickly clothed with long hairs. They construct their nests in the stems of plants or in burrows in partly rotten wood, and make the cells of carved pieces of leaves which they cut for the purpose. One species of the genus is especially fond of red clover blossoms, and no doubt does much towards fertilizing them.

One of our prettiest little bees in the State is a member of the genus *Ceratina*. It is bluish-green and has the habit of excavating the pith from brambles, briars and other similar plants. As it is without the pollen-gathering hairs either upon its legs or body, and rather than be a "cuckoo," it feeds its larvæ with a semi fluid honey.

The genera *Eucera*, *Mellissodes*, *Xenoglossa*, *Synhalonia*, and *Diadasia*, are mostly rather large bees in which the antennæ of the males are much longer than in the females. The females are usually supplied with pollen-brushes. Quite a number of species are to be met with in our State.

Emphor, *Habropoda*, *Anthophora* and *Clissodon* are also large bees which are fairly well represented here.

The carpenter-bee, *Xylocopa*, is also one of our wild bees. This is the large blue-black and yellow bee that makes its nest in holes made by itself in solid wood.

Of course *Bombus*, to which belong our various bumble-bees, is rather well represented here; and almost every school boy or girl can tell of more than one thrilling experience that he or she has had with them.

The genus *Apathus*, which is represented by three species that live asinquillins in the nests of *Bombus*, is interesting. These bees are very simple in appearance to the bees with which they live as invited guests, or not, as the case may be.

Lastly, among the native or wild bees of Nebraska can be included the honey or hive bee. LAWRENCE BRUNER.

How many varieties of bumble-bees have we?

Prof. Bruner.—I think we have ten in the West, in the East four. The bumble-bee lives along the Rocky mountains. The western portion of the State has more varieties than the eastern.

Prof. Bruner, what is the size of our Nebraska bees?

Prof. Bruner.—They go from the largest bumble-bee to a bee that is very small indeed—about 1/30 of an inch.

What kind of a bee is it that visits the maple trees?

Prof. Bruner.—These are called the leaf-cutting bee; they are smaller than the bumble-bee. There are leaf-cutting bees which make holes in the center of partly decayed wood. These holes are about 1/2 inch in length and 1/4 inch in diameter. These bees cut the pieces with their jaws. Their jaws work like scissors.

Mr. Masters—I have seen bees work on rose leaves, but I did not know what kind of bees they were.

Prof. Bruner—Some bees work on the leaves of the rose and some even on the petals.

Dr. Miller—Professor, what is hibernation?

Prof. Bruner—Passing through the winter in a torpid state, and coming out alive in spring—like the squirrel.

A member—Are there any stingless bees in the world that store honey?

Prof. Bruner—I don't know. I read that there was such a bee introduced from South America, but they found that they could sting a little better than the honey-bee!

Prof. Bruner said that he would bring his collection of bees to the convention room, which he did. It was a very fine display, and attracted much attention.

It was then voted to have the afternoon session at 2 o'clock, and the evening session at 7:30 o'clock. The convention then adjourned till the afternoon session.

(Continued on page 689.)



California Bee-Keeping Notes.

BY PROF. A. J. COOK.

Mr. H. Levering, one of the able bee-keepers of Southern California, and editor of the bee-department of the *California Cultivator*, sends me three flowers which he wishes identified. He says that they are visited very generally by the bees. The plants are, 1st, *Senecio douglassii*, a very common shrub of the composite family, which is in bloom from early June to winter. This is a near relative of the thistle and common star thistle (*Centaurea*), common East and in California. Like nearly all California plants it is in bloom just about with the wild buckwheat, *Eriogonum fasciculatum*, and continues like that famous bee-plant till late autumn.

The second plant was California Virgins' Bower, *Clematis ligusticifolia*. This closely resembles the Virginia Virgins' Bower of the East. I had never supposed, that these were bee-plants. I see that Benton does not include them in his lists. The Columbine, a flower of the same family—*Ranunculaceæ*—has much nectar in the pendant tips of its irregular flowers, but it is concealed from honey-bees.

The third plant is *Brickellia californica*. This is also a shrubby composite, and very closely related to boneset or *Eupatorium* of the East. We can well see, then, that it might secrete nectar, though we wonder how any plant can search out nectar or ought else from the parched soils of September in Southern California. It simply shows that individuals can get sweet, not to say be sweet, though all Nature conspire to parch, blight or burn them.

One of my students here—a very bright young lady—has commenced keeping bees. She has taken off two supers of sections even in this dry season.

That article of Dr. Howard's, in a late *American Bee Journal*, on a "New Bee-Disease," is worthy of the author of that excellent treatise on "Foul Brood."

The newspapers state that Mme. Modjeska has an apiary of over 600 colonies of bees on her ranch in San Diego county,

and that she sells a large amount of honey each year. The honey is all from white sage, and so of finest quality. The writer has often passed through Modjeska, on his way to San Diego. The region is excellent for bees. But if Mme. Modjeska gets a large crop of honey such seasons as the present and that of 1894, it must come from her honeyed words.

Claremont, Calif.



The Preparation of Bees for Winter.

BY HON. GEO. E. HILTON.

In most localities the month of September will end the secretion of nectar in the flowers for this season at least. And, as successful wintering depends largely on properly preparing the bees, I shall recommend that preparation at once.

Perhaps some of them need no attention at all, some will be found with insufficient stores, others may have more than they really need, but in order to learn their condition we must go through our apiaries and examine each colony and make a note of their condition, that if there is sufficient honey in the yard to winter all or to give each colony not less than 25 or 30 pounds, we must equalize by taking from the heavier and exchanging combs with the lighter, thus equalizing them; but should there not be honey enough in the yard we must feed.

The above estimate I think will hold good for either outdoor or cellar wintering; it is claimed that bees consume less stores wintered in the cellar than those wintered on the summer stands. This may in a measure be true while they are in the cellar, but it is just as true that they consume more stores during the spring months and changeable weather than those protected in the double-walled hives, making one just about offset the other. In case I find myself compelled to feed, and I usually prepare for this emergency, I prefer to feed by removing combs that have little or no honey in them and replace with combs well filled and capped over in the earlier part of the season.

In the absence of these my next choice is extracted honey. In the absence of both we must resort to sugar syrup, and while bees winter well on syrup made from pure granulated or confectioner's sugar, I prefer the honey, but, in feeding either, we must resort to some kind of a feeder, especially if the bottoms of our hives are not perfectly tight.

For winter feeding, or rather feeding for winter, I know of no feeder I like as well as the "Miller feeder;" this is about the size of your comb honey super, and is set upon the hive in the same manner. The bees go directly from the center of the brood-nest into it, and it is so arranged that the bees cannot get above it or daub themselves with the feed.

After determining the amount the colony needs, one of these can be set on and the required amount poured in at one feeding, as it will hold 30 pounds of honey or syrup. As my hives all have tight bottoms, I frequently raise the front of the hive two or three inches, and just before dark pour in at the back end of the brood-nest three or four pounds at a time. As this will all be stored in the combs and everything cleaned up before morning, there is no danger of robbing. Should the honey thus fed be very thick, I should thin it with a little hot water, as the bees can handle it much better and faster if it is thin and a little warm.

In preparing sugar syrup, make it just as it is made for table use, being very careful not to burn it or it will surely kill the bees. Don't put off this feeding until too late, as it is very essential that the bees should have time to thoroughly ripen and cap it over. After your feeding is done remove everything of a non-porous character, and place next to the bees something that will allow the moisture to pass off. A piece of woolen blanket, a piece of old but clean carpet, or even a piece of burlap will answer nicely. Then put on a cushion or pillow filled with clean wheat chaff or cut straw, and leave

them thoroughly alone until next spring, and you need have no more fears of their wintering well than of a flock of sheep that are given proper attention. If you winter bees in the cellar, treat them in the same manner, and leave the hive cover off. Put them in the cellar between Nov. 1 and 15, and all be well.—Michigan Farmer. Newaygo Co., Mich.



Unfinished Sections—Removing the Honey.

BY F. A. SNELL.

At the close of the honey season, when a part or all the bees are run for comb honey, there will be many unfinished combs, or those only partly filled with honey. Some may be capped partly over, while some will be partly filled, but no sealing done. From some cases quite a portion of complete combs may be found, and these should be cleaned of propolis and crated for market. Those not finished may be left in each case until all complete sections from the hives have been removed from the cases and crated to sell. Then with the honey extractor the honey from the unfinished sections may be removed. Two shallow frames of about four or five inches in depth with a bottom, on which the sections may rest, are hung in the revolving basket of the machine. The shallow frames should be about 2½ inches in width, and one hung in on either side so the face of the combs may be next to the wire screen.

A honey-knife, the blade of which is about three inches long, and having a curved handle, is just the thing for this work. The combs to be uncapped are held with the left hand on the frame over the uncapping can, and with the knife the cappings are removed and the section set in the extractor. Four or more can be emptied at one time. These are then placed in a case, cleaned of propolis, and more emptied and placed with the others emptied. When a case is full, it is placed to one side, and so on until all are completed.

The propolis, if not previously done, should be scraped off each section before placing in the case. The honey should be strained through a thin-cloth strainer, and placed in the can or barrel. This work should be done as soon after the honey season closes as is convenient, and while the weather is yet warm, for the honey is harder to remove when cool. The bees will also clean up the combs much better when warm. One or two cases of sections can be put on each hive in the yard just before sundown, and will be readily entered and all honey slicked up by the bees, and no excitement occur.

When cleaned of honey, the cases can be removed from the hives by use of the bee-escapes, or during a cool spell, when no bees are in the cases, and stored in the honey-room, all ready for the next season's use; and when placed on the hives, they will aid in the start in storing surplus. When no extractor is at hand, the unfinished combs will be cleared of honey often by placing them over light colonies, or those short of stores, but it is not certain. The plan given is sure and systematic.

Milledgeville, Ill.



Cleansing Pollenized Brood-Combs.

BY F. A. GEMMILL.

As a rule, nearly all apiarists sooner or later find themselves supplied with a super-abundance of brood-combs containing more or less pollen, the quality or quantity being such that it is not desirable to again return them to the bees. To those who may desire such combs relieved of their contents, I may here state that I have succeeded to my heart's content, and herewith give the method so that others having the same facilities may follow that practiced by myself.

The generally adopted plan heretofore used was to first soak the combs in water for a few days, and then throw out the water-soaked pollen by means of the honey-extractor. In order to force the air out of the cells so that the water would find its way to the bottom, the combs were held over some

large vessel (I used a large square tin uncapping-can), while yet another vessel containing a quantity of water was close at hand. A small corn-broom or whisk was dipped into the water and whisked or thrown over the surface of the combs, they being held at an angle of about 45° during the operation. As soon as thoroughly filled they were set side by side in the uncapping-can, when it was filled with water so as to completely cover the combs, the same being held in position by having a board and large stone placed thereon, and allowed to remain thus for 36 or 48 hours or more if desired.

The above method has been practiced by myself in the past, but a more expeditious and much more satisfactory plan has been used of late, and any one having the advantage of a town or city water-works system I would certainly recommend its utilization for such a purpose. The mode of procedure in this case is the same as just outlined up to the time of the applying of the water to the surface of the combs, but instead of whisking it into them a nozzle is attached to the water-works hose, capable of throwing a fine stream or spray, that will cover the surface of the comb, five or six inches in diameter, every cell inside of that compass being thoroughly drenched to the septum with such force as in some instances to throw out the dried pellets of pollen, which are sometimes seen in such combs, almost instantaneously; the filling and washing out of a whole comb being accomplished in a very few seconds.

The same method in regard to the saturating of the solid pollen is carried out with all combs not thoroughly cleansed by the first spraying, and in 48 hours the stream or spray is again brought into requisition, this time, however, before the combs have been revolved in the extractor, as the stream, when directed onto the water-soaked combs, forces anything and everything contained in them to make a hasty retreat, leaving all as clean and sweet as if new.

Nothing now remains but to give the cleansed combs a few turns in the extractor to get rid of the remaining water they may contain. A wire-cloth screen, such as is used when shipping or removing bees to "fields anew," is now laid on two pieces of 2x4 scantling, and the hives containing seven combs in each, and perfectly spaced, are tiered five or six stories high with another screen on top so that a current of air can pass through and thoroughly dry them.

The above plan was so satisfactory that I was almost sorry when it was finished, indeed my son who assisted me in the work (he being an awfully lazy fellow, like myself), remarked that he never saw me like to boss a job so well before. You know I could sit down to it while he had to stand up and run the extractor.

I will conclude by saying that the combs treated as stated were all wired brood-combs, four years old or thereabout, but I see no reason why, with care, unwired combs could not be treated in like manner. For cleansing combs containing small quantities of sour honey, which sometimes accumulates if left too long unoccupied by the bees, as they were last season (I not having swarms to hive them on), the spray is a capital way of making them sweet and clean, and also for cleaning the basket of the extractor.—Canadian Bee Journal. Stratford, Ont.



Comparison of Section Comb Foundations.

BY HON. R. L. TAYLOR,

Superintendent of the Michigan Experiment Apiary.

Comb foundation bears about the same relation to the apiarist as commercial fertilizer is to the farmer who is compelled to use it. In each case the quality of the article has much to do with the success and prosperity of the class using it. It is of the utmost importance, consequently, that purchasers be informed, insofar as may be, of the character of the goods offered for sale by different dealers, a condition which results not only in present safety to the purchaser, but also (and this is perhaps even more important) compels manufacturers continually to make every effort to keep the quality of their product at the highest possible point. It is therefore deemed desirable that the experiments heretofore made with comb foundation should be repeated, and this has been done during the season of 1896.

It is all the more important that these experiments should be continued, because new methods are from time to time being learned and practiced in the manipulation, and it is of the highest interest that it be known if possible whether the methods affect the product favorably or otherwise. During the past year, especially, there has been a marked change in methods by the adoption by our leading manufacturers of the Weed invention. This is a machine the most important feature of which seems to be the contrivance by which melted wax is made into sheets of any length by being passed between

cylinders. The immediate object of the present experiment was to test the quality of foundation made by this new process.

As a basis for comparison I made some foundation on the Given Press, out of wax carefully selected for its purity, color and favorable texture, the effort being directed to the selection of wax known to be most acceptable and most readily worked by the bees. The samples compared were three, one from the largest manufacturer in this State, M. H. Hunt, which was made by the method heretofore in vogue; and the other two respectively from the two leading manufacturers of this country, if not of the world, the A. I. Root Co. and Chas. Dadant & Son, made by the new process. One case was devoted to the three kinds, that is, each case of a size to contain 36 sections 9-to-the-foot was filled with sections one-half of which contained one of the above three kinds and the other half the Given foundation. The two kinds were placed in the case alternately without separators, the presumption being that those containing foundation worked soonest and most readily by the bees would at the finish contain more honey than the others.

For the benefit of those who have not pursued the reports of former experiments, it should be said that it is deemed very material to the success of an experiment of this nature that the sections employed be about nine-to-the-foot or 1½ inches wide, for the reason that this width approximates very nearly the space which the bees like best to allow each comb. To be exact, this space is somewhat less than the bees use on an average, but a departure on that side is desirable, as appears if the difficulty encountered by the use of sections that are too wide is considered.

I found by actual trial, if two kinds of foundation for one of which the bees have a decided preference, are disposed in a case in alternate sections, having each a width of nearly 1½ inches, or 7-to-the-foot, that at first the bees work out the preferred foundation much more rapidly than they do the other, and continue to do so until the resulting comb is of the thickness which the bees prefer, and must have for use in the production of brood; and that when this point is reached, their work on it is, to some extent, suspended, and an effort made to bring up the thinner comb from the poorer foundation, so that, with such sections, the preferences of the bees defeat the object of the experiment which is to have them deposit honey in the two classes of sections in proportion to the estimation in which they hold the two kinds of foundation, uninfluenced by their ideas of propriety on other points. But the use of sections 9-to-the-foot meets the required condition, for, unless one of the foundations is execrable indeed, the comb from the better one is not likely to reach the desired thickness before the available space is all occupied.

The results of the experiment appear in detail in the following table:

Make.	Size of tdn. used—inches.	No. to the pound.	No. of feet to the pound.	Wt. of ½ case of honey from each kind of fdn.	Per cent. of excess of that made from Given fdn.
				lbs. oz.	
Root	3¾x3¾	112	11.3	11 9	
Given	3¾x3¾	116	11.3	11 13	2.16
Hunt	3¾x3¾	128	12.7	10 15	
Given	3¾x3¾	116	11.3	11 5	3.42
Dadant	3¾x3¾	128	12.5	9 14	
Given	3¾x3¾	116	11.3	10 1	1.89

In each case the Given foundation, as generally heretofore, shows a superiority, but in a greatly reduced degree.

The sample from Hunt, whose foundation has heretofore, in this kind of experiment, stood at or near the head, loses its place, though on the whole it compares more favorably with the Given than in the test of a year ago.

The showing made by the New Process foundation is very favorable indeed—a very gratifying fact, since the increased facility in manufacturing gained by the new method will have a strong tendency to decrease the price of the product.

It is another matter for congratulation that the samples of foundation used in the present experiment approach uniformity very much more nearly than ever before.—Review.

Lapeer, Mich.

OLDEST BEE PAPER IN AMERICA ESTABLISHED IN 1861

THE AMERICAN BEE JOURNAL

GEORGE W. YORK, Editor.

PUBLISHED WEEKLY BY

GEORGE W. YORK & COMPANY,

118 Michigan St., CHICAGO, ILL.

\$1.00 a Year—Sample Copy Sent Free.

[Entered at the Post-Office at Chicago as Second-Class Mail-Matter.]

Vol. XXXVI. CHICAGO, ILL., OCT. 22, 1896. No. 43.

EDITORIAL COMMENTS.

The Chicago Honey Market is still being over-quoted by certain commission firms who evidently find it difficult to get any honey at all. In a private letter dated Oct 9, one of them quoted 15 to 16 cents for "white, choice to fancy" comb honey, when we could then, and can yet, get the best comb honey here for 13 cents per pound. Don't allow yourself to be induced to ship to any firm that over-quotes prices on honey.

What Have You Learned the past season? The longer evenings will soon be here, and you will then have time to write out the results of your experience and the experiments of the season just ending. As you have been benefited by what others have written, why not return the favor by describing the new and helpful kinks that you have discovered?

Remember, the Bee Journal is kept up for the purpose of interchanging ideas on all apiarian subjects. It is perfectly independent, is run by no clique, is fearless for the right, and against the wrong. In a word, it is here to do its utmost to aid bee-keepers and place the industry of bee-culture on a higher plane. It is your paper, and its columns are open always to the best information to be had relating to bees and their profitable management.

Lincoln Convention Comments.—We hardly know where to begin to comment upon the recent meeting of the North American Bee-Keepers' Association held at Lincoln, Nebr. Perhaps it will be just as well, however, to begin at the start, and say that we left Chicago Monday night—just one day sooner than we had expected to go. Editor Ernest R. Root, of Gleanings, was our genial, and very congenial, traveling companion from first to last. We were together five nights and four days on the round trip.

We reached Des Moines, Iowa, about 8 o'clock Tuesday morning, where Hon. and Mrs. Eugene Secor, of Forest City, joined us. Messrs. Jos. Nysewander and James Cormac, two local bee-keepers, also met us for a few minutes on the train at Des Moines, but did not go on with us.

At Atlantic, Iowa, Mr. W. C. Frazier got aboard the train and went on to the convention, also returned with us to that point. Mr. F. is a hustling farmer bee-keeper, does the work of about two ordinary men, and seems to keep healthy and well. Perhaps the pound of honey he said he ate daily, helps to sustain his muscle as well as avoirdupois. He is interested in sheep, bees, poultry and strawberries—of course the finest varieties of each.

We reached Lincoln at 3:35 p.m., and not finding a delegation of Nebraska bee-keepers with brass band and banners

(1) waiting to receive us at the railroad station, the five of us boarded a carriage and were taken to the "Lincoln" hotel. Leaving Mr. and Mrs. Secor there, the rest of the company went to the University buildings, where we found that kind-hearted, cheerful-countenanced Nebraska bee-keeper—Mr. L. D. Stilson. He was accompanied by Mr. H. E. Heath, the busy editor of the Nebraska Farmer, which, by the way, is published in Lincoln.

Dr. Miller and A. I. Root arrived at about 5:30 p.m., Tuesday, and Dr. Mason the following morning. These three, with E. R. Root and the writer, were assigned to the Lindell Hotel, which is a grand place to stop; the meals are excellent, and all attendants kind and courteous.

Mr. and Mrs. Secor were very fortunate in being sumptuously entertained at Chancellor McLean's delightful home, where they were made to feel as if regular members of the family.

Before going any further, we want to say that never before have we met a man who holds so high a position as does Prof. McLean (being Chancellor of the great Nebraska State University), who was also such a genial, generous and kindly hearted man. Why, he was simply "one of us" all the time, and won the admiration of the whole convention by his interest in us all and our meetings. It is indeed a pleasure to show our readers the Chancellor's pleasant countenance (see first page), and to inform you that he is now an honorary member of the Association. We also had the privilege of meeting Mrs. McLean, who we felt was in every way her honored husband's equal.

It would be impossible to touch upon every incident of the convention in one installment of comments, so we will extend them through several numbers of the Bee Journal.

But before closing for this time, we want to refer to Prof. Lawrence Bruner and his interesting talk on bees. He has charge of the entomological department of the University, and we are sure it is in good hands. We were told that the Professor is a born entomologist. When but a child he was incessantly after all kinds of bugs, and wanted to know, you know, all about them. We think he found out, or else he would not be in his present responsible work. For 13 years Prof. Bruner occupied a position in Washington, D. C. He is a pleasant speaker, and held the attention of the convention closely when delivering his lecture on "The Wild Bees of Nebraska." He did not wholly confine himself to the bees of that State, as will be seen when reading his address as it appears in the regular report of the convention proceedings.

Next week we will try to give some glimpses of the convention and its members, as well as a few side lights that helped to enliven the whole.

United States' Annual Honey Crop.—Editor Root, of Gleanings, has several times made an effort to get at the amount of comb and extracted honey produced annually in the United States. Finally, he thinks he has succeeded in getting somewhere near the correct estimate. In Gleanings for Oct. 1, he has this editorial in regard to this subject:

Some two years ago I made an effort to get the manufacturers of section honey-boxes in this country to make a report of their output to Dr. C. C. Miller. My idea was that, if we could get all of them to give to him the number of sections they had made during the calendar year, we could make a sort of estimate on the amount of comb honey produced annually. Still better, if manufacturers would give their average annual output for a period of ten years to some one person, that person could figure very closely on the average annual amount of comb honey produced during that period.

Two years ago, when I tried to carry out this scheme, one of the large manufacturers refused to give their output. The consequence was, I had to give up my pet scheme for a time. But this year I have learned approximately the number of sections that were made in the United States during the past year. Making a liberal allowance for the fact that sections

are under weight, so far as the amount of honey they hold, it appears that the amount of comb honey produced during the year in the United States is somewhere about 25,000,000 pounds; and if there is as much extracted honey produced as comb, then the total amount of honey produced annually in this country would be about 50,000,000 pounds, or 25,000 tons. While this estimate may not be strictly accurate, it is far better than the rough guesses that have been made from year to year, and far more accurate than the government reports.

Our stenographer thought I ought to deduct something for sections on hand, not filled with honey. There were thousands (and we might say millions) of sections of last year's output left over. These, by the law of averages, would balance the number left on hand of this season; but this year the number left over will be less than last, because, as I have shown, the season has been better.

According to the foregoing, there is 50,000,000 pounds of honey produced annually in this country. Suppose we say that its average value is 10 cents per pound (and that is sufficiently high, we think), or \$5,000,000. If that be true, then the \$20,000,000 that some enthusiast estimated nearly a year ago was about four times too high. Still, it is a difficult thing to get at the right figure in a matter of this kind. There is so much chance for error; but we think that an estimate of \$10,000,000 would be quite ample to cover the needs of the case.

The Southwestern Wisconsin bee-convention was held at Wauzeka, Oct. 7 and 8. The officers elected were: President, N. E. France, of Platteville; Vice-President, Thos. Evans; Secretary, F. L. Murray; and Treasurer, J. W. Van Allen.

After much discussion on marketing honey, the convention voted to sell next year's honey crop through a member of the association, and Mr. N. E. France was selected for the purpose.

The President exhibited a large picture frame containing 75 portraits of prominent bee-keepers, the most of them having been clipped from the American Bee Journal, Gleanings and the Review.

We expect soon to be able to give a full report of the proceedings.

Geo. T. Wheadon & Co. Again.—Mr. Dana Twining, of Frankfort Station, Ill., has had some correspondence with the would-be honey-commission firm of Wheadon & Co., of this city, as will be seen by the following:

EDITOR AMERICAN BEE JOURNAL—

Dear Sir:—Some time ago I received a circular from Geo. T. Wheadon & Co., of Chicago, giving quotations of honey, and later on I received a letter from them requesting a reply. They wished to know about the prospect of obtaining honey in this vicinity; they would send a man here if I had enough to be worth while.

In my reply I wrote them that last year I received circulars from C. R. Horrie & Co., but did not ship them any honey; I referred them to an editorial in the American Bee Journal of Sept. 10, 1896, and I did not intend to ship Geo. T. Wheadon & Co. any honey this year. I also referred them to the American Bee Journal of Sept. 24. They wrote me a reply, which I enclose, not because they request it. You can see that Geo. T. Wheadon & Co. are not a legitimate firm. If they were, they would have written me a different reply.

Yours truly, DANA TWINING.

Frankfort Station, Ill., Oct. 12.

The letter referred to by Mr. Twining, which he received from Geo. T. Wheadon & Co., of 198 South Water street, is here given in full, excepting, of course, the lithographed letter heading which mentions honey as a part of their business:

DANA TWINING, Frankfort Station, Ill.—

Dear Sir:—Your somewhat sarcastic letter under date of Sept. 28, is at hand. We judge from the tone of your letter that you pin your faith to the editor of the American Bee Journal. We will inform you right here that he does not amount to much in Chicago. He is endeavoring to make his readers think that he is a prominent personage, but he is

not known among our leading business men. From the tone of your letter, we judge that you have never seen him. You should come to Chicago and see him once—it will be well worth your carfare. It would be as big a sight as to attend the World's Fair. You might send him this letter. We would consider it a great favor, as he does not hear from us in a direct way, we doing no advertising with him.

Very truly yours, GEO. T. WHEADON & Co.
E.—Dictated by G. T. W.

It is a real pleasure to us to publish the foregoing correspondence, for it shows that our denunciations of fraudulent commission firms is having the proper effect. Wheadon's letter reminds us of the saloon people's talk about prohibition laws not prohibiting, and yet they spend time and money in trying to break down such laws or to prevent their enactment. 'Tis simply a case of "sour grapes."

So far as we know, Wheadon has never seen us, and he knows better than to attempt to advertise in the Bee Journal; and as for our "not amounting to much in Chicago"—well, we are entirely satisfied if we can only be known well enough among bee-keepers to prevent them from shipping their honey to such parasitic firms as Geo. T. Wheadon & Co., C. R. Horrie & Co., and others of their kind.

We want to thank Mr. Twining for sending us these letters, and we trust that others who wish to aid in protecting bee-keepers from being unfairly dealt with, will also forward to us any and every thing that they may receive of a similar nature.

The Toronto Apiarian Exhibit.—The Canadian Bee Journal has this to say concerning the apiarian exhibit made this year:

Never before in the recollection of exhibitors has there been as fine an exhibit of honey at the Toronto Industrial Exhibition, but unfortunately for the exhibitors and for the public generally, the place this year occupied is under the east end of the Grand stand, a position in a remote corner, and away from other exhibits, people expecting to find under this building nothing but lunch counters and dining halls. Again, moving the building each year gives those wishing to see the honey-building and intending purchasers no end of trouble. What bee-keepers and the bee-keeping industry requires is a separate building permanently located, and the position of that building in a location where it can be readily reached. We have said this building is required by the bee-keeping industry, because it must not be forgotten that those exhibiting at Toronto are benefiting bee-keepers generally, because they are drawing attention to honey, and many purchase honey in city stores, through having seen and perhaps tasted it at the exhibition. The large exhibits are all neatly and tastily put up, some of course going to greater expense than others in providing the finishing touches, but all of them a credit to bee-keepers.

"Drawn Combs increase the crop of comb honey 100 per cent., writes L. A. Ressler to Gleanings. When I first read that I thought that Mr. Ressler had been a little extravagant, and it does sound so, but I am not so sure that he isn't pretty near the truth. How much more extracted than comb honey can you produce? That's the question; and drawn comb will enable you to produce as much comb as extracted honey. There is a big field here for experiment and investigation."

The above paragraph was written by Editor Hutchinson in the Review for September. That last sentence sounds queer, for, if we mistake not, it was Mr. H. himself who only a short time ago was saying that he thought bee-keeping, along the line of improvements, had about reached 'the end of the string.' And yet he says, "There is a big field here for experiment and investigation." Must have changed his mind.

HONEY SPONGE-CAKE.—One cupful of honey, one cup of flour, five eggs. Beat the yolks and honey together; beat the whites to a froth; mix all together, stirring as little as possible; flavor with lemon, and bake quickly.

PERSONAL MENTION.

EDITOR R. B. LEAHY, of the Progressive Bee-Keeper, we regret to learn, has been suffering from rheumatism. Why not turn the bees on, R. B.?

MR. A. E. SHERRINGTON, of Walkerton, Ont., one of the Directors of the Ontario Bee-Association, exhibited 32 varieties of apples at the Toronto Industrial Exhibition.

MR. N. E. FRANCE, of Platteville, Wis., was recommended by the Southwestern Wisconsin Bee-Keeper's Association as the proper man for appointment by the Governor as State foul brood inspector. Good choice.

MR. THOS. EVANS exhibited, at the Southwestern Wisconsin convention, some very fine comb foundation, made by his invention for sheeting the wax—sheets wound on a roller of any length and of uniform thickness.

SOMNAMBULIST seems to have taken too much to heart our joking suggestion that Skylark and Sommy should "amalgamate." We see our mistake now. It wouldn't be safe for any one to be "skylarking" around Somnambulist's habitation. Better keep away, "Skyke."

MR. O. O. POPPLETON, of Florida, who has been spending about six weeks in Iowa, called on us last week, when on his way home. He was expecting to visit The A. I. Root Co. before returning to Florida. Mr. P. is a very pleasant man to meet, as well as an old and experienced bee-keeper.

MR. S. J. BALDWIN—a bee-supply dealer in England—is spending a few months at Elizabeth, N. J., for the good of his health. He says:

"The benefits derived from my previous visits to this great country have induced me to come again, and I feel it much more pleasant and certainly more beneficial to my health than doctor's nostrums, to say nothing about the cost."

FUNK & WAGNALLS COMPANY, of New York, have just received a single order from one firm for 100,000 copies of their celebrated "Standard Dictionary of the English Language," amounting at retail to nearly one and a quarter millions of dollars. This is the largest single sale of so large a work ever made in America. Previous to this one large transaction, over 100,000 copies had been issued, and the Company is still receiving many large orders from its subscription agents throughout the world.

MR. EDWARD H. TAYLOR, of Welwyn, Herts, England, gave us a very pleasant call, Monday, Oct. 12. He had been to see the G. B. Lewis Co., of Watertown, Wis., and was on his way to visit The A. I. Root Co., at Medina, Ohio. Mr. Taylor, though but a young man, is successor to Mr. T. B. Blow, who was an extensive English manufacturer of and dealer in bee-keepers' supplies. He uses about 15 tons of beeswax annually for comb foundation, getting most of the wax from the island of Madagascar, off the east coast of Africa.

We took Mr. Taylor to see Messrs. R. A. Burnett & Co., Chicago honey-dealers, and he was much interested in the quality of United States honey, and also in the manner of putting it up for shipment and market.

Basswood Trees from the Seed.—We have quite frequently had inquiries concerning the growing of basswood trees from the seed, and in Gleanings for Oct. 1 we find the following by Mr. A. I. Root, which no doubt contains the very information that many have long desired:

There have been several inquiries in years past in regard to growing basswood seedlings; and we have once or twice had a nurseryman reply; but the impression was left, if I am correct, that the matter was too difficult, and could be managed only by an expert. Well, the basswoods in front of our store, and, in fact, all along the road in front of our dwelling, have been bearing pretty good loads of blossoms and seed for two or three years past. I have several times noticed young basswood seedlings among our vegetable plants; but the boys

who do our weeding were sure to "yank" them out sooner or later. This season I succeeded in protecting one strawberry bed that stands just across the sawed-flagging pavement from the basswood trees. No attempt was made to sow the seeds, mind you. The plants that came up were only from seeds carried across the walk by the wind. I have just counted 35 young basswood trees in a bed only 30 feet long. The tallest one is about a yard high, and as straight as a whip. These vary from a few inches to three feet. They had no attention and no cultivation, except to let them grow among the strawberries. We are just now preparing some beds, and we propose sowing thousands of the seeds, which can easily be gathered by the bushel from the loaded trees. My impression is, they can be grown as easily as or easier than cabbage-plants, for they require no glass and no protection. Of course, it takes a long time to grow them—that is, if you want them two or three feet high. We shall sow the seeds during the present month and up into October as we have beds cleared off. I believe it will be safe to put them in two or three inches deep, in mellow soil. It has been a query in my mind, whether forest-tree seedlings will thrive well on ground fertilized with stable manure; but if I were to judge from those I have mentioned, I think it is just what they want, only that the manure should be old and well rotted. The bed in question has had no manure for something over a year; but previous to that time it was mulched so heavily for strawberries that the soil may be perhaps one-fourth manure, say six inches deep. In regard to distance apart, I would put in the seeds say about four to the inch, in rows five or six inches apart. Should the seed all grow they can be transplanted when they seem to be crowding each other. It may be that they would do better without transplanting until they are several feet high; but I do not see how we can get a perfectly even stand without transplanting. After the first year they had better be put out in the fields, say a foot apart in the row, the rows wide enough to be cultivated with a horse. Where land is cheap, I think they can be grown profitably for the lumber, to say nothing about free bee-pasturage. In regard to the latter, I still believe the basswood tree furnishes more honey to the world than any other one plant known—that is, where it thrives.

A New Binder for holding a year's numbers of the American Bee Journal, we propose to mail, postpaid, to every subscriber who sends us 20 cents. It is called "The Wood Binder," is patented, and is an entirely new and very simple arrangement. Full printed directions accompany each Binder. Every reader should get it, and preserve the copies of the Bee Journal as fast as they are received. They are invaluable for reference, and at the low price of the Binder you can afford to get it yearly.

The Alsike Clover Leaflet consists of 2 pages, with illustrations, showing the value of Alsike clover, and telling how to grow it. This Leaflet is just the thing to hand to every farmer in your neighborhood. Send to the Bee Journal office for a quantity of them, and see that they are distributed where they will do the most good. Prices, postpaid, are as follows: 50 for 25 cents; 100 for 40 cents; or 200 for 70 cents.

The Names and Addresses of all your bee-friends, who are not now taking the Bee Journal, are wanted at this office. Send them in, please, when sample copies will be mailed to them. Then you can secure their subscriptions, and earn some of the premiums we have offered. The next few months will be just the time to easily get new subscribers. Try it earnestly, at least.

The McEvoy Foul Brood Treatment is given in Dr. Howard's pamphlet on "Foul Brood; its Natural History and Rational Treatment." It is the latest publication on the subject, and should be in the hands of every bee-keeper. Price, 25 cents; or clubbed with the Bee Journal for one year—both for \$1.10.

The Great Campaign Book offered on page 666, ought to be in the hands of every voter. It shows all sides of the political questions of the day. Better send for a copy of it. Orders filled by return mail.

Now is the Time to work for new subscribers. Why not take advantage of the offer made on page 683?

Question-Box.

In the multitude of counsellors there is safety.—Prov. 11-14.

Swarming With the Queen on Her Bridal Trip.

Query 33—When a young queen flies out on her bridal trip the bees sometimes swarm out with her. Does such a swarm sometimes remain out permanently without returning? And if so, in about what proportion of cases?

Wm. McEvoy—No.

Engene Secor—I can't answer.

W. G. Larrabee—I don't know.

Mrs. J. N. Heater—Yes, sometimes.

P. H. Elwood—Usually they remain out.

Emerson T. Abbott—They do. I do not know the proportion.

Chas. Dadant & Son—Yes, in most cases the swarm will be lost.

J. M. Hambaugh—I have never been an eye witness to a case of this kind.

J. A. Green—Yes, but I have not known many cases—less than one per cent.

C. H. Dibbern—I don't know, but I think such swarms usually return to their own hives.

Prof. A. J. Cook—I think not. If they go out with her, I think it is to swarm, and not for mating.

Mrs. L. Harrison—They do; and sometimes never return. Little after-swarms, of about the size of a pint.

Jas. A. Stone—I never had such a circumstance occur that I knew of, but in such a case it would depend upon whether another queen got with them.

Dr. J. P. H. Brown—Weak swarms sometimes do not return. If you refer to nuclei, keep them well stocked with bees and brood, and they won't go out with the queen.

E. France—If the queen stays with the swarm, they will never return to the hive. If the queen should get away from the swarm, the swarm would return, and the queen also.

R. L. Taylor—I do not remember a case where such a swarm remained out permanently, but if such swarming out is repeated often, the swarm becomes reduced in numbers.

Dr. C. C. Miller—I don't know much about it. If obliged to make a guess, I should say that one young queen in ten takes a swarm with her on her bridal trip, and nine out of ten of these swarms return.

G. M. Doolittle—Yes. Some years, one out of every eight will thus go with the queen. Other years, not one in the whole apiary. With me, all that so go out would stay out permanently, were they not captured by the apiarist.

G. W. Demaree—Yes. Sometimes a small colony with little or no brood will follow out the young queen when she makes her wedding trip, and sometimes they become confused while out, and fail to return home. I have had but few experiences of the kind in 20 years past. It certainly does not often occur.

J. E. Pond—I never knew a case where the bees left and did not come back under the circumstances stated. In

The "Premium": A Good Watch Mailed Free!

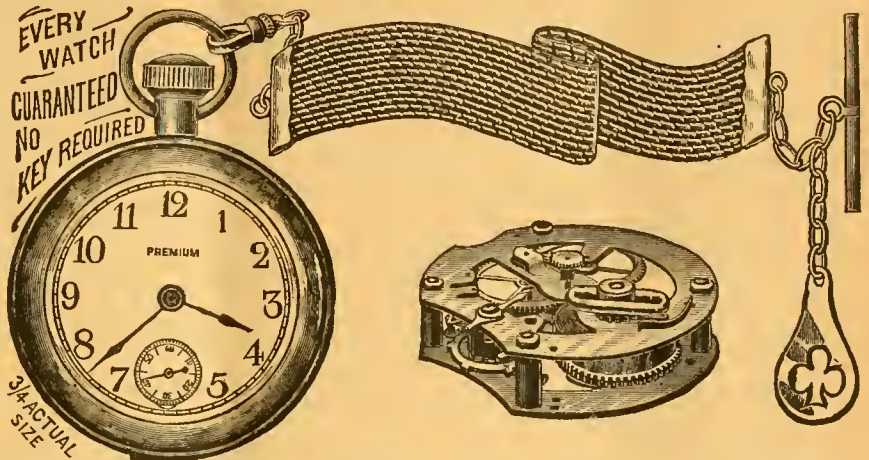

The movement of this Watch is regular American lever, lantern plion, quick train, 240 beats per minute, three-quarter plate, short wind; runs 30 hours to one winding; dust cap over movement; every movement fully timed; regulated and guaranteed for one year, the same as a Waltham or Elgin; nickel finish, heavy bevel crystal, and back pinion wind and set.

OUR OFFERS:—We will mail the above Watch for \$1.25; or club it with the Bee Journal for a year—both together for \$2.10; or we will send it free as a premium for getting **Three New yearly Subscribers** to the Bee Journal at \$1.00 each. The Watch is mailed from New York City, so please allow a few days before expecting your order to be filled.

GEORGE W. YORK & CO., 118 Michigan St., Chicago, Ill.

❖ MONEY SAVED IS MONEY GAINED. ❖

THE ROYAL UNION
Life Insurance Company
DES MOINES, IOWA.

The Iowa Policy

Is one that definitely promises to keep an accurate account with you; credit your premiums and interest, charge the actual expense and mortality cost, and hold the remaining funds subject to your order.

Agents Wanted.

JOHN B. KING, GENERAL AGENT,
Suite 513 First Nat'l Bank Bld'g,
30 Atf CHICAGO, ILL.
Mention the American Bee Journal.

THROAT
AND LUNG DISEASES,
DR. PEIPO, Specialist
Offices: 1019, 100 State St.,
CHICAGO. Hours 9 to 4.

Mention the American Bee Journal.

DUQUESNE COLLEGE!

PENN. AVE. AND EIGHTH ST.

PITTSBURG, PA.

Thorough Courses—Classical, Scientific, Normal, English, Commercial, Preparatory, and Ladies Literary. Efficient and experienced instructors. Day and Night sessions.

Send for Catalog.

Mention the American Bee Journal.

IF YOU WANT THE BEE-BOOK

That covers the whole Apicultural Field more completely than any other published, send \$1.25 to Prof. A. J. Cook, Claremont, Calif., for his

Bee-Keeper's Guide.

Liberal Discounts to the Trade.

Mention the American Bee Journal.

Extracted Honey For Sale!

We can furnish **Basswood** Extracted Honey, in 60-pound tin cans, on board cars in Chicago, at these prices: 1 can, in a case, 8 cents per pound; 2 cans in one case, 7½ cents; 4 cans (2 cases) or more, 7¼ cents; or in kegs holding about 275 lbs., net, at 7 cents. Cash must accompany each order.

A sample of the honey will be mailed to an intending purchaser, for 10 cents, to cover postage, packing, etc. We guarantee purity, and what we ship will be equal to sample.

Now it seems to us here is a splendid chance for any bee-keeper to supply his home demand after his own crop is all sold. Or, why not begin now to create a local honey-trade? Order one 60-pound can first, and start out among your neighbors and friends, and see what you can do. You ought to get at least 15 cents per pound in 5-pound lots, or 50 cents for 3 pounds. Some may be able to do even better than that, though we think that enough ought to be sold at these prices to make a fairly paying business out of it. Give it a good trial. Push it. It may grow into a nice winter's work for you.

GEORGE W. YORK & CO., 118 Michigan Street, CHICAGO, ILL.

fact, I have never known an instance where a colony left with the virgin queen when she took a bridal trip, and doubt very much that such an instance has ever occurred. I do not say that such has never been the case, but I have never seen proof of it.

Rev. M. Mahin—I have never personally known the bees of either a full colony or a nucleus to swarm out when the young queen came out on her bridal trip. If a colony should do so I would not expect them to return, unless the queen and the bees should get separated, which they would not be likely to do. But this is only my guess.

General Items.

Good Prospects for Next Year.

My crop this year is not very large—about 500 pounds of comb honey from 25 colonies, spring count, and increased to 40. The prospect for another year is good; there will be lots of clover. A year ago it was very dry here, so that clover was a failure. L. M. CUDNEY.

Flint, Mich., Oct. 6.

Appreciated All Around.

I expected my paper would stop soon after my subscription expired, and was greatly surprised to meet it every week as usual, and I was highly pleased, too, as the "Old Reliable" is like celery—the more you get of it the better you like it; and it has grown to be a most intimate friend of mine. I must thank you for sending it right along, and trusting to the honesty of an entire stranger for your pay; although, when a person is trusted like that, he must indeed be a sneaking thief to beat an editor out of his pay. E. B. TYRRELL.

Davison, Mich., Oct. 10.

Good Season—10-Frame Hives.

The past season has been a good one with me. I commenced with 60 colonies, increased to 118 by natural swarming, and secured 3,000 pounds of honey, all of which is clover and basswood. Eighty-five colonies have queens which were reared this year.

All of my bees are in 8-frame hives. I do not like them as well as the 10-frame, having been forced to the conclusion that in this locality bees will winter better and give larger swarms if kept in 10-frame hives. I have tried them both, side by side, but dropped the 9 and 10 frame hives because I had introduced the 8-frame hives in large numbers, supposing that they were superior to the others. I would change back to the 10-frame hive were it not for the cost of doing so. G. F. TUBBS.

Annin Creek, Pa., Oct. 7.

Sweet Clover Cut Down.

I see in the "Editorial Comments" for Oct. 1, that a Wisconsin bee-keeper has a patch of sweet clover growing on his farm, and that he has been ordered by the Weed Commissioner to destroy it.

Well, I am also a Wisconsin bee-keeper (though my post-office is in Illinois), and I have a similar case on hand. I have

**Warner's
Safe
Cure**

Has for a Fifth of a Century
Cured all forms of . . .

KIDNEY and LIVER DISEASES.

**THE DREAD
BRIGHT'S
DISEASE**

is but advanced Kidney Disease.
Either is Dangerous.
Both can be Cured
if treated in time with Warner's
Safe Cure.

Large bottle or new style smaller
one at your druggist's. Ask for
either and accept no substitute.

WHEN ANSWERING THIS ADVERTISEMENT, MENTION THIS JOURNAL.

RAILROAD LANDS

For Sale at Low Prices and
on Easy Terms.

The Illinois Central Railroad Company offers for sale on easy terms and at low prices, 150,000 acres of choice fruit, gardening, farm and grazing lands located in

SOUTHERN ILLINOIS.

They are also largely interested in, and call especial attention to the 600,000 acres of land in the famous

YAZOO VALLEY OF MISSISSIPPI

lying along and owned by the Yazoo & Mississippi Valley Railroad Company, and which that company offers at low prices and on long terms. Special inducements and facilities offered to go and examine these lands, both in Southern Illinois and in the "Yazoo Valley," Miss. For further description, map, and any information, address or call upon E. P. SKENE, Land Commissioner, No. 1 Park Row, Chicago, Ill. 33D6t

Mention the American Bee Journal.

Bee-Keeper's Guide—see page 685.

some sweet clover growing on my farm, and was ordered to cut it, but not complying, the Weed Commissioner cut it, and I presume he has put in a charge against me on the tax roll, for destroying a plant that I want to grow on my land.

I am a member of the National Bee-Keepers' Union, and wrote the General Manager about it, but he does not seem to want to do anything about the matter; he thinks the way to do is to change the law. I think the case ought to be tried by the Union. It is a subject that all bee-keepers are interested in.

C. H. STOROCK.

Durand, Ill., Oct. 6.

[We may be wrong in the matter, but we think that the quickest way to get such obnoxious laws repealed, is for the Union to come forward and make a test case of the matter. It is sure to win, and probably only one successful case would be necessary in order to wipe out all such laws in other States. Surely, it is a matter in which every bee-keeper is interested. We hope the Union will yet see its way clear to "take a hand" in all such cases, and push them to a satisfactory settlement.—EDITOR.]

Bees Did Well.

Bees have done well here this year, there being a good fall flow of honey. Comb honey sells at 12½ to 15 cents per pound. There was no honey extracted here that I know of.

G. H. DENNIS.

Weeping Water, Nebr., Oct. 5.

Bee-Hunting Experiences.

I have thought for some time of giving the readers of the Bee Journal some of my experience in hunting wild bees, which has been very extensive, and a thing that I have taken a great glory in. I have in some seasons made it very profitable, especially in that of 1869, when I took a job of working in the timber on Indian creek, Morgan Co., Ill., 12 miles north of Jacksonville. This was the greatest honey season I ever saw. I found a tree close to my cabin, cut it, and put the bees into a large box-hive. I would work in the cool part of the day, making about \$1.00 in the morning, then take a bee-hunt for a few hours, after finding a bee-tree, and as many as three, say from 10 a.m. until 2 or 3 p.m.; then take my axe and make five more railroad ties, for which I got 20 cents each; or cut a cord of wood, for which I got \$1.00. I have often thought I was in the "tallest clover" that season, of any year of my life.

Indian creek was the best stream for the size that I ever saw, for fish. My wife and I would take our hooks and go out on the bank of the creek, and in a few minutes have a fine mess of catfish, weighing from one-half to three pounds. But our good time drew to an end when fall came. We both took the chills; we shook, and we shook, and shookety shook, shuck, until one was not able to give the other a drink; but, as good luck would have it, we had a good old neighbor, by the name of John Chandler, that would always go with me, generally at night, to cut the bee-trees, or rather saw them down, as I had to get a

good many of them in that way. I thought likely the men that owned the timber would not like to be disturbed with the sound of my axe after night, and I felt sure the sound of their shot-guns would not be very agreeable to me!

As I am on this line, I will say that I learned several years ago not to be fooled out of a bee-tree, unless the owner of the land took it to bed with him. In my start at finding wild bees, back in Owen Co., Ind., 40 years ago, I sometimes was beaten by going to the owners of the land and asking them politely for the privilege of cutting the trees. They would oftentimes make a hundred excuses, such as "I have saved that tree to make boards, and could not think of having it cut." Or, "My wife ran those bees into that tree two years ago, and we never marked it." I always noticed that the tree was cut by the party soon after I told them I had found it—no difference how badly they wanted the tree for boards, it was ready for use as soon as I would find the bees! and often I would learn of them getting a large lot of honey.

But I find I have strayed from my Indian creek life, which, by the way, might be interesting to some. What bees I saved of the early ones kept myself and wife from suffering that fall. My old neighbor, Mr. Chandler, would go to market to Jacksonville every week, and I would take time between shakes to go out, pry the boards off the head of a gum, and cut out a bucketful of honey, and send it to town by Uncle John. He never failed to get 25 cents a pound for it.

I would like to tell Mr. Chapman (see page 605) that I saw a man eating brood, and the white fluid running out of the corners of his mouth. I would like to tell what I have experienced and noticed in regard to absconding swarms and the cause of the same. Bees do reason, and I think their reasoning faculties, in many things, surpass almost any other living thing. The present season surpasses any for many seasons in this locality, for honey; and now, on Sept. 19, bees drop at the entrance, loaded down with honey. A. COTTON, Pollock, Mo.

One of the Best Honey-Years.

This has been one of the best honey-years on record for this locality. My report is as follows: Spring count, 12 colonies, increased to 24, and took 800 pounds of comb honey and 750 of extracted. I sold it in my home market at 14 cents per pound. GEORGE ROBY, Chanute, Kans., Oct. 8.

Report for the Past Season.

My report for this year is this: Number of colonies in the spring, 31, increased to 65, with 1,000 pounds of comb honey and 400 of extracted—almost all from basswood. The bees didn't get much from buckwheat, on account of wet weather. G. W. BELL, Bells Landing, Pa., Oct. 9.

Sweet Clover for Honey and Hay.

Our crop of honey has been very good so far, mostly from sweet clover. Bees won't touch alfalfa till sweet clover has done blossoming. I find quite a change in the minds of some of my neighbors. They are beginning to think sweet clover

THE "NOVELTY" POCKET-KNIFE!



Your Name on the Knife.—When ordering, be sure to say just what Name and Address you wish put on the Knife.

The NOVELTY KNIFE is indeed a novelty. The novelty lies in the handle. It is made beautifully of indestructible celluloid, which is as transparent as glass. Underneath the celluloid, on one side of the handle is placed an AMERICAN BEE JOURNAL reminder, and on the other side, name and residence of the Subscriber.

The material entering into this celebrated knife is of the very best quality; the blades are handforged out of the very finest English razor-steel, and we warrant every blade. The bolsters are made of German silver, and will never rust or corrode. The rivets are hardened German silver wire; the linings are plate brass; the back springs of Sheffield spring steel, and the finish of handle as described above. It will last a lifetime, with proper usage.

Why purchase the Novelty Knife? In case a good knife is lost, the chances are, the owner will never recover it; but if the Novelty is lost, having name and address of owner, the finder will return it; otherwise to try to destroy the name and address, would destroy the knife. If traveling, and you meet with a serious accident, and are so fortunate as to have one of the Novelties, your pocket KNIFE will serve as an identifier; and in case of death, your relatives will at once be apprised of the accident.

How appropriate this knife is for a Christmas, New Year or birthday present! What more lasting memento could a mother give to a son, a wife to a husband, a sister to a brother, a lady to a gentleman, or vice versa, a son to a mother, a husband to a wife, a brother to a sister or a gentleman to a lady—the knife having the name of the recipient on one side?

The accompanying cut gives a faint idea, but cannot fully convey an exact representation of this beautiful knife, as the "Novelty" must be seen to be appreciated.

How to Get this Valuable Knife.—We send it postpaid, for \$1.00, or give it as a Premium to the one sending us three new Subscribers to the BEE JOURNAL (with \$3.00), and we will also send to each new name a copy of the Premium Edition of the book "Bees and Honey." We club the Novelty Knife with the BEE JOURNAL for one year, both for \$1.90.

Any Name and Address Put on the Knife.

GEORGE W. YORK & CO., CHICAGO, ILLS.

Allow about two weeks for your order to be filled.

California

If you care to know of its Fruits, Flowers Climate or Resources, send for a Sample Copy of California's Favorite Paper—

The Pacific Rural Press

The leading Horticultural and Agricultural paper of the Pacific Coast. Published weekly, handsomely illustrated, \$2.00 per annum. Sample Copy Free.

PACIFIC RURAL PRESS, 320 Market St., - SAN FRANCISCO, CAL.

MUTH'S HONEY EXTRACTOR PERFECTION Cold-Blast Smokers,

Square Glass Honey Jars, Etc.

For Circulars, apply to CHAS. F. MUTH & SON, Cor. Freeman & Central Aves., Cincinnati, O. Send 10c for Practical Hints to Bee-Keepers.

Mention the American Bee Journal.

COMB FOUNDATION!

Wax always wanted for Cash or in Exchange for Fdn. or other Supplies. My trade is established on Low Prices and the merit of my Foundation. Orders filled promptly.

WORKING WAX INTO FDN. BY TH. LB. A SPECIALTY. Wholesale prices to dealers and large consumers. Send for Prices and Samples to—GUS DITMER, AUGUSTA, WIS.

Reference—Augusta Bank. 1 Atf Mention the American Bee Journal.

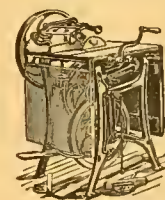

ONE MAN WITH THE UNION COMBINATION SAW

Can do the work of four men using hand tools, in Rippling, Cutting-off, Mitring, Rabbeting, Grooving, Gaining, Dadoing, Edging-up, Jointing Stuff, etc. Full Line of Foot and Hand Power Machinery Sold on Trial. Catalogue Free.

SENECA FALLS MFG. CO., 46 Water St., SENECA FALLS, N. Y. 1A1y Mention the American Bee Journal.

PROF. A. J. COOK'S BOOK FREE!

The Bee-Keeper's Guide

MANUAL OF THE APIARY.

This 15th and latest edition of Prof. Cook's magnificent book of 460 pages, in neat and substantial cloth binding, we propose to give away to our present subscribers, for the work of getting new subscribers for the American Bee Journal.

A description of the book here is quite unnecessary—it is simply the most complete scientific and practical bee-book published today. Fully illustrated, and all written in the most fascinating style. The author is also too well-known to the whole bee-world to require any introduction. No bee-keeper is fully equipped, or his library complete, without "THE BEE-KEEPER'S GUIDE."

Given For 2 New Subscribers.

The following offer is made to PRESENT subscribers only, and no premium is also given to the two new subscribers—simply the Bee Journal for one year:

Send us Two New Subscribers to the Bee Journal (with \$2.00), and we will mail you a copy of Prof. Cook's book FREE as a premium. Prof. Cook's book alone sent for \$1.25, or we club it with the Bee Journal for a year—both together for only \$1.75. But surely anybody can get only 2 new subscribers to the Bee Journal for a year, and thus get the book as a premium. Let everybody try for it. Will you have one?

GEORGE W. YORK & CO., 118 Mich. St., CHICAGO, ILL.

is a pretty good thing after all. I have sold some seed to one, and two others are talking of sowing some. It will grow on our poorest land, and make a crop, and choke out all weeds we have in this country, including sand-burrs and cockle-burrs. If it were of no other use it would pay well as a fertilizer. But it is a splendid hay crop, and, in my opinion, there is nothing better for honey. I have about 10 acres seeded down for next year. I put several acres in the corn at the last cultivating, and have a nice stand. You see, by putting it in the corn we have the crop the next season. If sown in the fall it will come up early the next spring, and make a good growth that season, but not seed. I always sow the seed with the hull on.—JOSEPH SHAW, of Kansas, in Gleanings.

Bees Did but Little.

Bees are not doing much this season. I shall not get honey enough to pay for the trouble. I live in hopes of a better season next year. Perhaps the bees will work better under a new administration; certainly they can do but little worse.

JOHN H. WHITMORE.

Minard, Mich., Sept. 23.

Beginning with Bees.

I bought a colony of Italian bees three days ago, after visiting four or five apiaries at different places. I got them from a farmer 20 miles out of town, and paid him \$3.00 for the whole thing—hive, bees, and about 50 pounds of honey. We closed them in the morning, and brought them to town over rough grounds in a spring wagon. We were about eight miles from town when the entrance came open, and the bees were flying around mad. We unhitched, took out the hive, smoked them with hay which we had in the wagon, and shut them up again, only losing a few bees. Then we started again, and reached home all right. FRED WIEMAN.

Lawrence, Kans., Sept. 22.

Two Starters in One Section.

The question is continually asked, "Does it pay to put two pieces of foundation in each section?" Yes, sir, it does. I would not use sections with only one piece, even if they were furnished free; for I want and will have my section honey built solid to the sections on all four sides, and can have them so by using sections eight to the foot, and a "Handy" slotted and cleated separator between each two sections, with two pieces of foundation fastened firmly exactly in the center of each. The reason I want this is because such sections of white honey will look "just splendid," and I can ship them a thousand miles without a broken comb, if properly crated. I put a half-inch piece of rather heavy foundation in the bottom, and the top piece wide enough to come within $\frac{1}{4}$ inch of this, and all to be $\frac{1}{4}$ inch from the sides of the sections. I know the order is generally given to fill the sections chuck full of foundation; but I tell you, after much experience, that foundation should not touch the sides of either brood-frames or sections until the bees have drawn it partially out; for if the foundation touches the wood, the bees will immediately stick it fast, whether it is in the right or wrong place.—B. Taylor, in Gleanings.

NOW WE HAVE IT! GLEASON'S HORSE-BOOK!

The Only Complete and Authorized Work
by America's King of Horse-Trainers,
PROF. OSCAR R. GLEASON,

Renowned throughout America and recognized by the United States Government as the most expert and successful horseman of the age. The whole work comprises History, Breeding, Training, Breaking, Buying, Feeding, Grooming, Shoeing, Doctoring, Telling Age, and General Care of the Horse.

You will know all
about a horse
after you
have
read
it.

No one can fool you
on the age of a
horse after
you have
read
it.

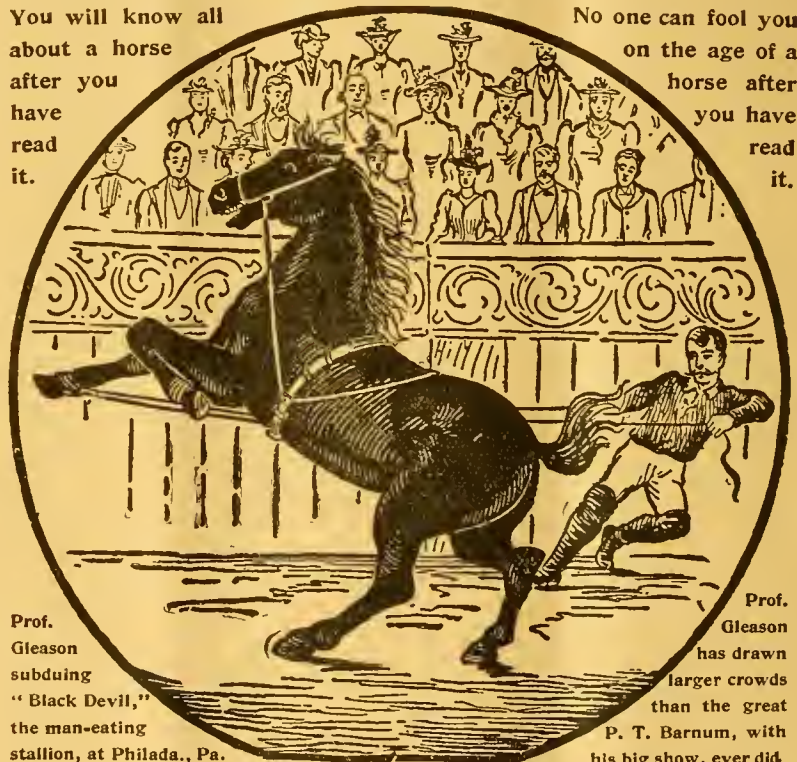

Prof.
Gleason
subduing
"Black Devil,"
the man-eating
stallion, at Philada., Pa.

Prof.
Gleason
has drawn
larger crowds
than the great
P. T. Barnum, with
his big show, ever did

416 Octavo Pages—173 Striking Illustrations.

Produced under the direction of the U. S. Government Veterinary Surgeon.

In this book Prof. Gleason has given to the world for the first time his most wonderful methods of training and treating horses

100 000 SOLD AT \$3 00 EACH.

But we have arranged to supply a limited number of copies to our subscribers absolutely free. First come, first served

Here are Our Offers of this Great Book.

Regardless of the fact that thousands upon thousands of these books in cloth binding have been sold at \$3.00 each, we are enabled to, and will for a limited period, send a heavy-paper-bound copy FREE as a premium to our present regular subscribers for sending us **ONE NEW Subscriber** to the Bee Journal for a year at \$1.00; or we will mail the book and the Bee Journal for a year to any one sending us \$1.60. Address,

GEORGE W. YORK & CO.,

118 Michigan Street,

CHICAGO, ILL.

"THE LITTLE GIANT BOOK-KEEPER."

BOOK-KEEPING

AT A GLANCE.

By Expert J. T. BRIERLEY.

A SIMPLE AND CONCISE METHOD OF PRACTICAL BOOK-KEEPING.



With instructions for the proper keeping of Books of Accounts and Numerous Explanations and Forms used in a Commercial business; showing an ENTIRE SET OF BOOKS BASED UPON ACTUAL TRANSACTIONS.

How to take off a Trial Balance sheet; and finally CLOSE AND BALANCE ACCOUNTS; EQUATION OF PAYMENTS; METRIC SYSTEM OF WEIGHTS and Measures.

Containing 144 pp., size, 5 x 2 3/4 inches, bound in Flexible Russia, indexed, 75 cents each, postpaid.

Special offer: We will mail this book free sending us two New Subscribers to the Bee Journal for one year (with \$2.00), and also send a copy of the premium book "Bees and Honey" to each of the new subscribers; or we will club the book with the Bee Journal for a year—both for \$1.60.

GEORGE W. YORK & CO.,
CHICAGO, ILLS.

YOUR BEESWAX!

UNTIL FURTHER NOTICE, we will allow 25 cents per pound for Good Yellow Beeswax, delivered at our office—in exchange for Subscription to the BEE JOURNAL, for Books, or anything that we offer for sale in the BEE JOURNAL. Or, 23 cts. cash.

GEORGE W. YORK & CO.,
CHICAGO, ILLS.

Mention the American Bee source.

My price for **Untested Queens** for the next two weeks:
1 Queen, 40 cts.; 2 Queens, 75 cts.; 3 Queens \$1.00.

E. L. CARRINGTON,

16A St. PETTUS Bee Co., TEX
Reference—1st National Bank of Beeville.
*Mention the American Bee Journal

Payne's Business Letter Writer and Manual of Commercial Forms.—Containing specimen Letters on all possible business topics, with appropriate answers. Containing general information with regard to business matters, the rules for punctuation, the abbreviations most used in the mercantile world, a dictionary of mercantile terms, 2 table of sponyms, and other information which may be of value

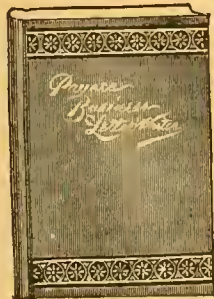

to the business man. New edition, revised and enlarged. 216 pages, Extra Cloth, 75 cts.

Special offer: We will mail this book free as a premium to any one sending us two New Subscribers to the Bee Journal for one year (with \$2.00), and also send a copy of the premium book "Bees and Honey" to each of the new subscribers; or we will club the book with the Bee Journal for a year—both for \$1.60.

GEORGE W. YORK & CO.,
CHICAGO, ILLS.

Mention the American Bee Journal.

HONEY and BEESWAX

MARKET QUOTATIONS.

The following rules for grading honey were adopted by the North American Bee-Keepers' Association, and, so far as possible, quotations are made according to these rules:

FANCY.—All sections to be well filled; combs straight, of even thickness, and firmly attached to all four sides; both wood and comb unsoiled by travel-stain, or otherwise; all the cells sealed except the row of cells next the wood.

No. 1.—All sections well filled, but combs uneven or crooked, detached at the bottom, or with but few cells unsealed; both wood and comb unsoiled by travel-stain or otherwise.

In addition to this the honey is to be classified according to color, using the terms white, amber and dark. That is, there will be "fancy white," "No. 1 dark," etc.

Chicago, Ill., Oct. 7.—Fancy white, 12 1/2@13c.; No. 1, 11@12c.; fancy amber, 9@10c.; No. 1, 8c.; fancy dark, 8@10c.; No. 1, 8c. Extracted, white, 5@7c.; amber, 5@6c.; dark, 4 1/2@5c. Beeswax, 25c.

The demand for the past two weeks has been of fair volume, enabling us to close out receipts promptly. We usually have the best trade of the year at this time, and it is also the season when comb honey bears transportation well.

Philadelphia, Pa., Sept. 30.—Extracted, white, 8-10c.; amber, 4-5c.; dark, 3-4c. Beeswax, 25c.

No new comb in this market yet. Old comb cleaned out.

Detroit, Mich., Sept. 30.—No. 1 white, 12-1 1/2c.; fancy amber, 10-11c.; No. 1 amber, 9-10c.; fancy dark, 8-9c. Extracted, white, 5 1/2-6c.; amber, 5-5 1/2c.; dark, 4-5c. Beeswax, 24-25c.

Indianapolis, Ind., Oct. 3.—Fancy white, 11-15c.; No. 1 white, 12-13c. Extracted, white, 6-7c. Beeswax, 22-25c.

Demand is fair for grades quoted, but no demand for inferior grades.

St. Louis, Mo., Sept. 30.—Fancy white, 13@14c.; No. 1 white, 12@13 1/2c.; fancy amber, 11@11 1/2c.; No. 1 amber, 10@10 1/2c.; fancy dark, 8@9c.; No. 1 dark, 7@7 1/2c. Extracted, white, in cans, 5c.; in barrels, 4@4 1/2c.; amber, 3@3 1/2c.; dark, 2 1/2@3c. Beeswax, 19@20c.

Very little honey coming in at present, and the weather is too warm to handle to advantage if it were here.

New York, N. Y., Oct. 9.—Fancy white, 12@13c.; if grades, 10@11c.; bu. k wheat, 8@9c. Extracted is in fair demand at unchanged prices. Beeswax is doing a little better, and firm at 24@25c.

There is a fair demand for fancy white comb honey, while of grades, mixed, and book-wheat are rather neglected. Receipts are heavy and stock accumulating. Sales are principally in small lots, and in order to move round quantities it is necessary to make concessions from quotations.

San Francisco, Calif., Oct. 7.—White comb, 10c.; amber, 7 1/2-9c. Extracted, white, 5-5 1/2c.; light amber, 4 1/2-5c.; amber colored and candied, 3 1/2-4 1/2c.; dark rule, 2 1/2-3c.

With light arrivals and light local stocks there is little chance for prices to fluctuate on any material degree in favor of the buying interest. Inquiry is not active, however, and mostly local. Prices in foreign centers are below the parity of values current here.

Beeswax, fair to choice, 24-7c. There is no lack of demand for choice bright, free from adulteration such being in scanty stock. It is the exception, however, where dark and inferior meets with prompt custom.

Albany, N. Y., Oct. 7.—Fancy white, 12-13c.; No. 1, 11-12c.; fancy amber, 9-10c.; No. 1 dark, 8-9c. Extracted, white, 6-7c.; dark, 4-5c.

The receipts of both comb and extracted honey are very large, and prices are somewhat lower. We have an ample stock of all styles except paper cartons weighing less than a pound.

Boston, Mass., Oct. 9.—Fancy white, 13-14c.; No. 1, 11-12c. Extracted, white, 6-7c.; amber, 5-6c. Beeswax, 25c.

Milwaukee, Wis., Sept. 30.—Fancy white, 14-15c.; No. 1, 12-13c.; No. 1 amber, 8-10c. Extracted, white, 6-7c.; amber, 5-6c.; dark, 4-5c. Beeswax, 22-24c.

New crop of honey begins to come forward. The demand is very poor and quotations almost nominal. Weather is very warm and the consumption of honey is very small. Plenty of fruit, and hence the appetite is satisfied with same in preference. Later on we expect an improved demand for honey of all kinds.

Minneapolis, Minn., Sept. 30.—Fancy white, 12 1/2c.; No. 1 white, 10@11c.; fancy amber, 9@10c.; No. 1 amber, 8@9c.; fancy dark, 7@8c.; No. 1 dark, 6-8c. Extracted, white, 5 1/2@6 1/2c.; amber, 5@5 1/2c.; dark, 4@5c. Beeswax, 23@26c.

The demand for both comb and extracted is very quiet, and for the latter, nominal. The hot weather of the past week or so has checked demand for comb honey.

Cleveland, Ohio, Sept. 30.—Fancy white, 14 1/2@15c.; No. 1 white, 12 1/2@13c. Extracted, white, 6@7c.; amber, 4 1/2@5 1/2c. Beeswax, 22@25c.

There is not very much honey in our market. Selling rather slow. Demand beginning to be a little better. Think trade will be fair in this line this fall.

Kansas City, Mo., Sept. 30.—Fancy white comb, 15c.; No. 1 white, 13@14c.; fancy amber, 12-13c.; No. 1 amber, 11-12c.; fancy dark, 10-11c.; No. 1, 8-10c. Extracted, white, 6-6 1/2c.; amber, 5-5 1/2c.; dark, 4-4 1/2c. Beeswax, 22-25c.

Buffalo, N. Y., Oct. 19.—Fancy comb, 1-pound, 12-13c., occasionally 14c.; No. 2, 8-10c.; No. 3, 4-7c. Extracted, 4-5c.

Demand better, and quite a consumptive trade now.

List of Honey and Beeswax Dealers.

Most of whom Quote in this Journal.

Chicago, Ills.

R. A. BURNETT & Co., 163 South Water Street.

New York, N. Y.

HILDRETH BROS. & SEGLER,
120 & 122 West Broadway.
CHAS. ISRAEL & BROS., 486 Canal St.

Kansas City, Mo.

C. C. CLEMOMS & Co., 423 Walnut St.

Buffalo, N. Y.

BATTERSON & Co., 167 & 169 Scott St.

Hamilton, Ills.

CHAS. DADANT & SON.

Philadelphia, Pa.

WM. A. SELSER, 10 Vine St.

Cleveland, Ohio.

WILLIAMS BROS., 80 & 82 Broadway.

St. Louis, Mo.

WESTCOTT COM. CO., 213 Market St.

Minneapolis, Minn.

S. H. HALL & Co.

Milwaukee, Wis.

A. V. BISHOP & Co.

Boston, Mass.

E. E. BLAKE & Co., 57 Chatham Street.

Detroit, Mich.

M. H. HUNT, Bell Branch, Wayne Co., Mich.

Indianapolis, Ind.

WALTER S. POWDER, 162 Massachusetts Ave.

Albany, N. Y.

CHAS. MCCULLOUGH & Co., 380 Broadway.

Cincinnati, Ohio.

C. F. MUTH & SON, cor. Freeman & Central avs.

READERS Of this Journal who write to any of our advertisers, either in ordering, or asking about the Goods offered, will please state that they saw the Advertisement in this paper.

Bottom Prices

**BRING US BIG TRADE.
GOOD GOODS KEEP IT.**

If you want the best supplies that can be made at a little less cost than you can buy the same goods for elsewhere, write to us for low prices. 1896 Catalogue now ready—ask for it and a free copy of **The American Bee-Keeper** (36 pages).

Address,
**THE W. T. FALCONER MFG. CO.,
JAMESTOWN, N. Y.**

Mention the American Bee Journal.

Honey-Clovers & Buckwheat SEED FOR SALE.

We have made arrangements so that we can furnish seed of several of the Clovers and Japanese Buckwheat, by freight or express, at the following prices, cash with order

	5lb	10lb	25lb	50lb
Alsike Clover	\$.70	\$1.25	\$3.00	\$ 5.75
Sweet Clover75	1.40	3.25	6.00
White Clover.....	1.25	2.00	4.50	8.00
Alfalfa Clover.65	1.10	2.70	5.00
Crimson Clover....	.55	.90	2.00	3.50
Jap. Buckwheat....	.20	.35	.90	1.25

Prices subject to market changes.

Add 25 cents to your order, for cartage, if wanted by freight.

Your orders are solicited.

**GEORGE W. YORK & CO.,
CHICAGO, ILLS.**

BEGINNERS.

Beginners should have a copy of the **Amateur Bee-Keeper**, a 70-page book by Prof. J. W. Rouse. Price 25 cents; if sent by mail, 28c. The little book and the **Progressive Bee-Keeper** (a live, progressive 28-page monthly journal) one year, 65c. Address any first-class dealer, or

LEAHY MFG. CO., Higginsville, Mo
WHEN ANSWERING THIS ADVERTISEMENT, MENTION THIS JOURNAL.

HONEY-JARS!

1-lb. square Flint Jars, with Corks, \$4.85 per gross. Including Labels, name and address on same, \$5.10 per gross.

A Full Line of Supplies on hand.
Catalogue.

**I. J. STRINGHAM,
105 Park Place. NEW YORK, N. Y.
APIARY—Glen Cove, L. I.**



DOOR YARD HORSES

A name applied to such as put on style on short drives, but soon "peter out." Many of the three rod samples of wire fences shown at the fairs, are built on this plan. The strong spring works nicely, but when required to regulate 40 or 80 rods it fails. The only "long distance" regulator is made by

PAGE WOVEN WIRE FENCE CO., Adrian Mich.
Mention the American Bee Journal.

READERS Of this Journal who write to any of our advertisers, either in ordering, or asking about the Goods offered, will please state that they saw the Advertisement in this paper.

19th Year Dadant's Foundation 19th Year

Is still in the lead, for we use all the latest improvements, including the

NEW WEED PROCESS,

and still make the best goods. Remember that we do not use any acid to purify our beeswax, and that is why our Foundation preserves the smell of the honey and is more acceptable to the bees, than any other. It is kept for sale by

T. H. Strickler, Solomon City, Kansas.
G. K. Hubbard, Fort Wayne, Ind.
L. Hansen, Davenport, Iowa.
C. Theilmann, Theilmannton, Minn.
E. C. Eaglesfeld, Berlin, Wis.
E. T. Abbott, St. Joseph, Mo.
J. M. Jenkins, Wetumpka, Alabama
John Rey, East Saginaw, Mich.
Vickery Bros., Evansville, Ind.

The Jennie Atchley Company, Beeville, Texas.
C. F. Muth & Son, Cincinnati, Ohio
E. Kretzmer, Red Oak, Iowa.
G. B. Lewis Co., Watertown, Wis.
James Reynolds' Elevator Co. Poughkeepsie N Y
Louisiana Bee-Keepers' Supply Manufactory,
Donaldsonville, La.
Page & Lyon, New London, Wis.
John Nebel & Son, High Hill, Mo.

and many other Dealers. All agree in saying that no goods are better than ours.

We make a specialty of **Veils and Veil Stuffs** of best quality, cotton and silk.

Langstroth on the Honey-Bee, Revised

Bee-Keepers' Supplies, Smokers, Sections, Tin Pails, etc.

Samples of Foundation and Tulle FREE with Circular. Instructions to beginners with Circular. Send us your address.

CHAS. DADANT & SON,

Mention the American Bee Journal.

HAMILTON, Hancock Co., ILL.

See Campaign Book Offer on page 666! Better Have It!

* Extracted Honey *



Finest Quality, Basswood and Clover.
2 60 lb. cans in case, 7c. per pound. 1 60-lb. can in case, 8c. per pound. A sample by mail, 10 cts. **P. DUBOIS' Honey-Jars and Complete Line of Supplies.** Catalogue Free.

WALTER S. POULR,
162 Mass Avenue, INDIANAPOLIS, IND.

PATENT WIRED COMB FOUNDATION



Has No Sag in Brood-Frames
Thin Flat-Bottom Foundation
Has No Fishbone in the Surplus Honey.
Being the cleanest is usually worked the quickest of any Foundation made
J. VAN DEUSEN & SONS,
Sole Manufacturers,
Spring Brook, Montgomery Co. N. Y.

Root's Double-Walled Dovetailed Chaff Hives, and Winter-Cases for Single-Wal'ed Hives,

Have met with much success everywhere in wintering. The Double-Walled Chaff Hive is light, neat, compact, and weighs only a trifle more than the single-walled hives of the same capacity. Now is the time to lay in your stock for winter.

Send for Catalog and Prices.

THE A. I. ROOT COMPANY,

Factory and Main Office, **MEDINA, O.**

BRANCH OFFICES:

115 Michigan St., Chicago, Ill.
1024 Miss. Str., St. Paul, Minn.

Syracuse, N. Y.
Mechanic Falls, Maine.

AMERICAN BEE JOURNAL

DEVOTED EXCLUSIVELY TO THE INTERESTS OF HONEY-PRODUCERS

ESTABLISHED IN 1861
THE OLDEST BEE-PAPER IN AMERICA

Published Weekly, at \$1.00 per annum.

Sample Copy sent on Application.

36th Year.

CHICAGO, ILL., OCTOBER 29, 1896.

No. 44

CONVENTION PROCEEDINGS

THE REPORT IN FULL

OF THE
Twenty-Seventh Annual Convention
OF THE

North American Bee-Keepers' Association,

HELD AT
LINCOLN, NEBR., October 7 and 8, 1896.

BY DR. A. B. MASON, SECRETARY.

[Continued from page 677.]

WEDNESDAY AFTERNOON SESSION.

The convention was called to order by Pres. Root at 2 o'clock.

The first thing on the program was the following

President's Annual Address.

Well, friends, it is a grand thing to produce a nice crop of honey, to raise a nice crop of apples, to make a nice display in clay, to raise nice potatoes, which I know something about. It is a grand thing to succeed in any of these enterprises. We have heard something about this particular State of Nebraska, 500 miles long by 200 miles wide, and we know a little about your products here. We cannot have nice apples without taking care of them. May the Lord be praised for the nice apples. In Ohio we had great beauties this year, and it was only by hard work and labor on our part. We made a grand effort, and we succeeded beyond our expectation. We must not only prepare the soil, but we must get the best seed and best varieties; and then we must take care of them all the way through.

I have been brushing up at this forenoon's session. The veterans must have produced nice honey. We have had nicer honey this year than ever before, but there is a man—Francis Danzenbaker—that I wish to speak of. This man and I had some trouble, but we are good friends now. He has produced some fine honey. We have shipping-cases put up for the honey-boxes, not allowing the honey to drip. I believe this credit surrounds his good name. Sometimes we spend considerable time in our convention wondering where the credit of these things belongs. I think it is the evidence of better things. There is no great credit without great labor. We feel proud of our fairs and expositions. I can remember the time when I spent many hours in making foundation, and it didn't work. I can remember when my wife wanted me to burn everything up. Well, I persevered and succeeded, and now it is just as simple as can be. One difficulty after another

has been overcome as the years passed by, and I don't know as the coming generation will ever know of these difficulties.

In speaking of these various crops, of apples, nice sections of honey, etc., I have been thinking of another crop which is of more importance, and when our brother was reading in chapel this morning, it seemed to me that he had found just the right selection to read. This institution is growing; these boys and girls are being trained for that which makes them happier and nobler, and leads them into the ways of righteousness. It is something like this: "In God we trust, to him we look for progress." We are all of us children, we are all growing, we are all learning. And when I see these students with all these advantages, and hear these brothers tell of their workings with the bees, I can only say, the Lord be praised.

I do feel that these conventions cost a good deal of money, but you can afford to come: it may be only once in a lifetime.

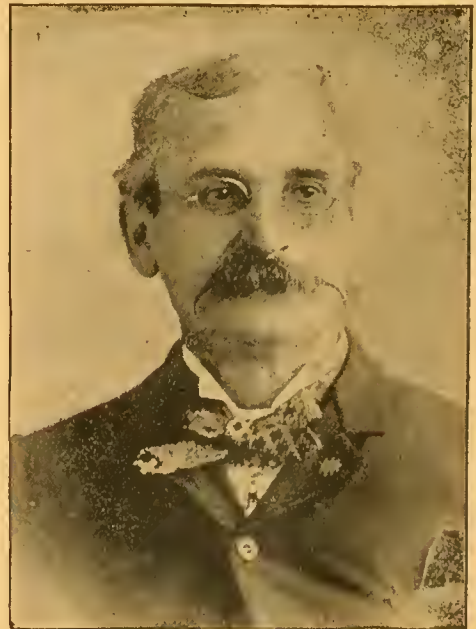

Thomas G. Newman, San Diego, Calif.—See paper on page 691.

I hope this Association will keep going. I shall never let another of these bee-keepers' conventions pass without attending if it is a possible thing, and I want to have you all present.

Brother Langstroth has gone; B. Taylor has gone; Alien Pringle has gone; some others may have gone. Perhaps I may never be present at another meeting; this may be the last chance I will have of being with you. We have the promise that in due time we shall reap if we faint not. Sitting among the assembly of the young here, we have reminders that our work in this life can be profitable. We certainly want to take as much pains with humanity as we take with the apples. We want to assist them to a higher plane, we

want to keep the enemy away, and keep the good work going on. What is grander in this life than to engage good men and women to hold up this work of ours? The enemy may be marching in upon us while we rest, and snatching up what good remains, while we know but little about it. *God bless you.*

A. I. Root.

The Secretary then read a paper written by Prof. A. J. Cook, of Claremont, Calif., entitled

A National Bee-Keepers' Exchange.

Knowing as I do the objection in the minds of some of the wisest and best of our bee-keepers, to the presenting of papers at our meetings, I will send only a few words on what seems to me one of the most important questions that confront the bee-keepers of the United States.

It need hardly be said that one of the most important characteristics of the highest civilization which marks the close of the nineteenth century, is the fact of organization. Those trades and professions where all the members can organize and act together, not only make much more rapid progress than do others less fortunate, but the general intelligence and pecuniary success is much more marked. The lawyers, doctors, and many of the trades people have become so thoroughly organized that even the price they fix upon their service is known and indeed established by all the members of their profession, and thus they have it in their power absolutely to fix their own price upon any service which they may render. Not to pay this price is to go without service, for all act together, and no honorable man will cut the stipulated price of the profession.

I had occasion not long since to inquire regarding the professional service of the California physician. I wrote to practitioners in several towns and found, as I expected to, that the rates charged for counsel, for office visits, for visits in the town, or visits in the country, were almost identical. It need not be said that this is greatly to the advantage of any trade or profession.

I recently had occasion, in the city of San Diego, to engage a livery to go 12 miles from the city. I was to leave about two o'clock and must return that evening. The road was somewhat mountainous. The charge was \$3.50. I complained of the amount, when the proprietor told me that I must take two horses. It was too hard for one unless I had the whole day for the journey, and he said the livery people of the city had fixed upon \$3.50 as the proper amount to charge for a team. We see the livery men of San Diego are united. We also see that this is better for them, as well as for their horses.

One of the great reasons why the manual labor pursuits have been so slow to advance; why the laborers in this field have had nothing to say as to prices of their service; and why success, especially in the agricultural field, has been so uncertain, has been the fact that organization, from the nature of the case is almost impossible. The farmer (and by this I include bee-keeper, horticulturist, etc.) is isolated. Association becomes difficult, and thus there is more or less suspicion, lack of confidence, so we see why associated effort is almost impossible. The fact, too, that success in agriculture, especially where people are willing to work long and hard, and practice the utmost economy, does not always require education, at least of a broad sort. This is another reason why association becomes more difficult.

I believe that we are all agreed that no laborer is more worthy or more deserving of appreciation than he who works in the agricultural field. If this is true, as we become more civilized, and have more of the spirit of Him "who went about doing good, and of whose life there was no guile," there will be no tendency to look down upon the agriculturist. Such terms of opprobrium as "hay-seed," "mudsill," will not be heard, and the farmer will be regarded as one of the noble men of the world. The thing that will bring this about will be thorough organization. To-day the farmer has nothing to say in regard to the price of his products. When he goes to market either to buy or sell, the other party always fixes the price. The merchant or doctor must live, and fixes his price accordingly. From association he is able to do this. The farmer must sell, and so takes what he can get. The amount he receives for his wares may come far from paying expenses, yet he must sell all the same, and does sell, though he sees debt and hunger staring him in the face. This is all wrong, and there is a crying need for reform.

I have already stated that because of isolation, and often because of lack of culture and knowledge of the world, the agriculturist is suspicious. He lacks confidence in others, and though he himself would not cheat another, or even think of doing so, yet he is apt to feel that every other man's hand is

against him. This fact stands strongly in the way of association among the agriculturists, yet association is the one thing desirable. It is bound to come. "Ever the right comes uppermost," and it is certainly right that the man who toils often from five o'clock in the morning till nine in the evening, at honest, noble toil—toil which is at the root of all prosperity—should be recognized as worthy of all respect and of the best of success. I believe that the one thing necessary to merited success and just recognition is thorough organization. To secure such organization there must be more general education. I believe that this education is rapidly coming to the farming class of our country. The education may not come from the school or college, but it is as surely coming. The agricultural paper is being read as never before. Farmers' clubs and institutes are carrying the college or university to the farmer. I believe that through these agencies our rural population will soon lose their suspicion and distrust, and will soon be educated to a point where they can work together, and be placed more on a level with those who labor in the village or city.

Is it not true that there is more of culture and general intelligence among the bee-keeping class than among any of the other manual laborers in the country, if we except, per-



Prof. A. J. Cook, Claremont, Calif.

haps, the horticulturist? If I am correct in this view, then it is true that there is no better place for general organization to commence among the farming class than among the bee-keepers. The work and most gratifying success of the Bee-Keepers' Union proves that this point is well taken. Every bee-keeper, worthy of the name, reads one or more bee-papers. He usually also reads the books treating of bees and apiculture. The intelligence which comes from this wider reading makes the bee-associations more interesting and valuable. It will also make it possible for bee-keepers to organize and form exchanges. Have we not, then, as bee-keepers, a duty to perform? The duty to show the value of organization, and also help forward our own success?

The gratifying success of the Citrus Fruit Exchange of Southern California shows clearly that such movements can be made of tremendous advantage to the pomologist. There is now on foot a movement to bring the deciduous fruits also into this organization. To show the need of this, I have only to state that the raisin crop of the San Joaquin Valley was marketed last year at a loss of one-half million of dollars. The raisin men have recently formed an exchange, and are already offered a price just double that of last year. We owe a debt of gratitude to the pomologists of Southern California. They prove that an exchange is practical and exceedingly desirable. Many fruit-growers, a few years since, saw bankruptcy staring them in the face. Through the Exchange, these same people are now prosperous. The honey-producer, of California at least, has no fears as to producing honey. Could he be sure of a good price for his output, he would have no ques-

tion of a very satisfactory success in his business. When he has to sell the finest honey at three cents per pound, and that, too, in years of scarcity throughout the country, he becomes discouraged, and he has good reason for his discouragement.

There are only three ways, at present at least, for the general producer to market his products. He must do it through commission-men, or through organization, f. o. b., as it is called, or else he must organize, put his own agents in the general markets and distribute and market his own products.

The commission system has been thoroughly tried in California and elsewhere, and has proved itself an entire stranger to success. There is no way for the producer to get his share of the fruits of the market if he deal with the commission-men.

The f. o. b. system is better, but provides for no distribution in the markets, and so is not found in practice to work well.

The third system, of putting agents in the field and thus distributing the products where they are needed, looking out that no market is glutted, is founded on common sense, and has been found to work remarkably well. The enormous business done by the Southern California Fruit Exchange for the past year, when all the agents were new, untried men, was done at a loss of less than one-half of one per cent! This is certainly a marvelous showing for the first year. Previous to last year, the f. o. b. system was in vogue. As the agents become known and experienced, the success will be greater, and more, if not all, the producers will join the Exchange. Indeed, the great impediment in the way of success comes from the fact that so many stay outside of the Exchange. Many of them acknowledge, that but for the Exchange, no success would be possible, yet believe that they individually can do better outside. Thus they selfishly remain outside and imperil the whole system. The fact of these outsiders keeps the commission business alive, and the commission-men circulate reports and do everything else they can to injure the organization. These are obstacles in the way which time will remove. How quick such a joyful riddance will come, depends upon the producers themselves.

I believe the Honey Exchange of Southern California will be able to move on to a bright success. My reason for this opinion is that the bee-keepers of this section, like the fruit-growers, are men of some education and breadth. They will not distrust each other, nor will they expect and clamor for perfection at once. I believe, also, that very soon the bee-keepers will unite with the fruit-men, and thus the machinery which is of necessity very expensive, will not have to be duplicated. It will also be much cheaper, from the fact that the agents in the markets of the country will have work the year through. The honey will be sold in early winter; the citrus fruits later in the season, and the deciduous fruits may go on to the market all through the summer months. The raisins and dried fruit can be used for filling, as they can be marketed at any season of the year. This whole scheme is entirely philosophic. It is founded entirely on good sense. It is necessary to the best success of our best people, and so must come sooner or later into general use. Is it not our duty and privilege, by word, pen and act, to do all we can to further this plan? I believe Southern California is already ripe for such action. I see no reason why other sections of the country may not also join us in this good work. I look forward to the time—I believe I shall live to see it—when there will be this general association among all our farmers throughout the entire country. I sincerely hope that the discussion which shall follow this paper will do much to hasten this consummation. May we not take courage from the fact that the Bee-Keepers' Union has met with such gratifying success in its good work?

I hope that our Bee-Keepers' Exchange of Southern California will receive great help from your discussion and action, and that your sessions will be in the highest degree interesting and profitable.

A. J. Cook.

Following the above paper, at the request of the Secretary, Dr. Miller read a paper written by Thomas G. Newman, of San Diego, Calif., on

The "Union" and Amalgamation.

Uniting the forces and massing the energies are always desirable when an important undertaking is at hand, providing always that there be a union of sentiment, and the work to be accomplished is based on the same lines of thought.

In the matter of uniting the "North American Bee-Keepers' Association" and the "National Bee-Keepers' Union," there has been much discussion, and there are now two distinct parties arrayed against each other—the one for it, the other against it.

In Gleanings for Sept. 15, page 669, Dr. Mason states

that before 1893, the Union was called the "North American Bee-Keepers' Union." This is an error. It never had but one name, and that was and is—"The National Bee-Keepers' Union." The words "North American" were appropriated by the "Association," and were not therefore available for the "Union," without confounding terms. It would have been appropriate, but as a matter of fact it was never used in connection with the Union.

The "nonsense" which has been published, like this: "I say away with amalgamation, and let the Union set about to re-organize itself as soon as it can"—is simply ridiculous. The Union is all right, and needs no re-organization. It asks nothing but good-will from its neighbor—the North American Bee-Keepers' Association—and can live and prosper, doing its own work—that work for which it was created—without losing its head, its temper, or its understanding. Its uniform success, and its excellent financial condition, is something all should be proud of, instead of hurling at it such crazy "shots," or empty and cracked "shells" as the foregoing quotation, and calling it a "poor fizzle," etc.

Dr. Mason well says in Gleanings, on page 670: "This country of ours is too large" to warrant annual meetings, and expensive personal representation. That is incontrovertible.

We must also be careful about forming a "National Honey Exchange" for bee-keepers. I believe that the only way such can be made to succeed is to have a large capital and buy the honey outright from bee-keepers, and then selling it as its own. Where there are too many conflicting interests, there will always be contention and strife. Let the Association beware.

To have two "classes" in the Union—one protective and the other non-protective, is impracticable—wholly so. I fully concur in the remark of the editor of Gleanings, who says, "I doubt the wisdom of having two classes of members. If any of them need protection, they all want it."

While I am quite willing to coincide with the majority, and work for anything reasonable which may be agreed upon, I advise caution and deliberation. Too hasty action may be regretted later.

THOMAS G. NEWMAN.

E. T. Abbott—It would seem to be the best possible thing we can do, to have a committee appointed to take these two papers in hand, and give us something definite to discuss. I move that a committee of three be appointed to take up the subject of a new constitution; to look over this subject and fix it the way it should be, and report in the morning.

Mr. Abbott's motion was seconded and carried. The committee appointed was as follows: Dr. Mason, Geo. W. York, and E. R. Root.

Mr. Abbott—Mr. Chairman, I would like to offer a resolution right here:

"WHEREAS, Mr. Frank Benton has wilfully insulted this Association by refusing to furnish to the printer a copy of the minutes of the St. Joseph meeting held in 1894, for which he received the sum of \$25, as per the direction of the Association; therefore, be it

Resolved, That his name be dropped from the roll of membership, and that he be debarred from again becoming a member of this Association until he has made due apology and amends for his unwarrantable action."

Mr. Abbott—Mr. Benton refused to send his full report to the printer, and would not even return the money.

A Member—Had I been in Mr. Benton's place, I would have stuck my head into the first barrel I came to.

Mr. York—Mr. Benton was asked, at the Toronto convention, whether he would send the rest of the report, and he said he would do so.

A member asked, "Is that correct?" Answered, "That is correct."

Mr. York then read from the Report of last year's meeting, where, in reply to the question by Rev. W. F. Clarke, "Will you, or will you not, turn over that Report?" Mr. Benton replied, "I will." And Pres. Holtermann said, "That settles it."

A motion was made and seconded to drop Mr. Benton's name from our roll of membership.

A Member arose and said, "He is no longer a member because his dues have not been paid." Before the question was put Pres. Root said:

"I confess I feel loth to do anything of this kind. Mr. Benton is very slow in keeping his promise. I presume he has intended to furnish us with the report, but he is very slow. Another thing, as far as sending the \$25 back again, more than one bee-keeper has been slow in sending back money. I

hope he means to send it back, but he may never do so. I think we are too easy on men of that sort. Maybe he does not have the money. I don't know."

Dr. Miller—Gentlemen, I don't want to vote on this motion, but I want you to. [Laughter.]

Mr. Abbott—I want to say another word. I don't want it to appear that it makes any particular difference to me, as far as I am concerned, that is not the question. Mr. Benton willfully circulated false reports, but this is of little concern, because no one will know whether they are true or false. He sent them through the United States mails, and when a man refuses to make any amends, then it is time for us to go our way and let him go his, and have no conversation with him. I think he can get along without us, and I think we can get along without him.

Dr. Miller—I don't want to vote for this resolution—it is an unpleasant thing to do; but I do believe, dear friends, we have allowed things to pass that should not be passed. So to be consistent, and get this sort of thing wiped out, I will vote, too.

The question was then voted upon, and carried.

A member asked, "Did Dr. Miller vote?" Answered by the President—"I heard his voice."

This was followed by a paper by Rev. Emerson T. Abbott, of St. Joseph, Mo., on

The Supply-Dealer and the Honey-Producer.

My subject is a broad one and should be of interest, as it has relation to the general make-up of society. It opens the question of the dealer's right to be, and his relation to mankind at large for good or bad.

In this age of close competition, low prices and slow profits, it has become popular to talk of doing away with the so-called "useless middlemen." If this idea should prevail, of course, society would have to be re-organized, and our methods of doing business materially changed. While I do not object to any buyer trying to get as near to the first producer as he can, yet I do think that it is a mistaken idea that all dealers belong to a class which may rightly be called "useless." In other words, I maintain that the dealer not only has a right to be, and is not a useless member of society, but he is a real producer of values, and is just as important a member of the body politic as any other producer. More, in many cases he is an absolute necessity.

This opens a wide field for discussion, but I shall confine my remarks to dealers in bee-keepers' supplies, and their relation to the honey-producer, and indirectly to the community at large. What I shall say will be equally applicable, with the necessary modifications, to dealers in any other class of goods.

First, the dealer is a producer just as truly as the man who keeps bees and markets his honey, or as the owner of a factory who takes boards and cuts and fits them into hives; or, to go back still further, as the man who grows a tree, cuts it into boards, and then cuts these boards into hives or sections. In the broadest possible sense of the word a producer is one who satisfies human desires. Some may say he is a creator of value, but what makes value? Evidently, human desire, for if no one desires a thing, it cannot be said to have any value in the sense of a market price. If no human being wanted honey, the man or woman who kept bees and secured it surely would be a *useless producer*. But just as soon as the securing of a crop of honey would satisfy a human desire, then the person thus administering to the wants of mankind would become a real producer, and a creator of value. Now, if creating a value is production, then every one who adds to the legitimate value of anything is a producer, and is not a mere trafficker in the fruits of other men's labors.

WHAT MAKES VALUE.

A thing may not have any value, or at least not very much value, in Michigan or Ohio, but it may have great value in Nebraska. If bringing an article from Michigan to Nebraska will cause it to satisfy more, or a greater, human want, than it would if left in Michigan, then whoever brings the article to Nebraska, the point of consumption, creates a value. Whoever brings an article from the place of no desire, or of little desire, to the place of greater desire, is a real producer, for he satisfies human want. To say that he is a "useless middleman," a non-producer, and that the man who chopped the article out of a log, or planed it out of a board in Michigan, is the only real producer is, in my opinion, a mistake. This idea is founded on a false conception of what production is. It limits production to the narrow field of producing value out of the original raw material. I might ask just here who it is that deals with raw material. Is it the man who cuts a hive out of a board, the man who saws the lumber, the man who

fills the tree, or the man who planted the seed and grew the tree? I hold that every man who helps to put the fruits of human labor into channels where they are best suited to satisfy human desire adds to the value of the article thus manipulated, and is therefore a producer.

Let us see, then, if we can, how this kind of production on the part of the supply-dealer is of any real benefit to the honey-producer. How does the dealer satisfy any human desire from the standpoint of the keeper of bees?

WHAT THE DEALER DOES.

It is the dealer's business to place articles in stock, such as the consumers in his line are likely to want, and hold them there until the consumer is ready for them, and then to furnish them to the consumer in such quantities as he may desire. In doing this the dealer runs many risks; especially is this true of dealers in bee-keepers' supplies. At the same time he confers special benefits upon the possible consumer, for there is much uncertainty in this business, and every dealer in bee-keepers' supplies runs the risk of having a stock of goods left on his hands until the next season, and in some cases he is lucky if he finds a market for them then.

Now, if it were not for the local dealer, the honey-producer would have to lay in a stock of goods himself, and run the risk of not having any use for them for a season or two—or possibly never. It is very hard to keep stock of any kind without its depreciating in value. This is especially true where it is kept by the ordinary bee-keeper who has no good place for storage. Even a dealer with the best of facilities is very apt to find some dead stock on his hands after he has been in the business a few years.

The losses incurred by the consumer by deterioration, and that arising from not being able to get his goods when he needs them most, and in such quantities as he may desire, I am sure will more than over-balance any profit the dealer may make. Then, it does not necessarily cheapen the article to the consumer to be able to buy it at the point of primary production. Freight on small quantities is always higher than it is on carloads, and those who are engaged in the first act of production can afford to sell their goods for less profit in large lots than they can in small quantities, so that the dealer's profit does not of necessity come out of the consumer.

A thing has real value in proportion to the amount of human labor that is required to produce it and place it at the point of consumption. If, by handling large quantities of an article at a time, each individual article of the sum total can be placed at the feet of the consumer with less outlay of human labor than would be required if only a few articles were moved at a time, then the cost of production is cheapened, even though each man through whose hands the articles may pass receives a profit on the same. In this way it comes about that the dealer is not able to provide for the satisfaction of his own desires, but he enables the consumer to satisfy his desires, and at a less cost of human energy than would be required if the dealer were eliminated from the economy of modern trade.

THE DEALER AN EDUCATOR.

Then, again, the dealer is an educator. He is constantly calling the attention of the consumer to new and better, and therefore, cheaper, methods of doing work or satisfying human desire. It is to the dealer's interest to study carefully the best methods of the industry that creates the demand for his stock in trade. From such dealers the consumer often gets information which is of much more value to him than is the cost of his entire purchase. This is especially true in our industry where so many who are engaged in it in a small way know so little about it.

It is true there may be too many dealers, but it is generally to the advantage of the consumer where this occurs. There are too many for their own good, but the consumer has no cause to call them useless on that account.

There are many other points along this line which I would gladly touch, if I had time, but I will leave them to be noticed by those who may engage in the discussion of this paper.

THE DEALER'S RIGHTS.

If the dealer is to receive recognition, then what are his rights? Has he any which other producers are bound to respect? I think he has. The first one which I will mention is his right to be freed from competition with the people who are engaged in putting into shape the goods in which he deals. The factories of the country owe it to the dealers who handle their products not to bring those dealers into unfair competition with themselves. I am compelled to say that the dealers in bee-keepers' supplies have felt the pressure of such competition during the last few years. The factories have each

been so eager for trade, and have tried so hard to over-reach the others engaged in a similar business, that they have sought for direct communication with the consumer. Many times in so doing they have ignored the rights of those engaged in the sale of their own goods. More than one dealer has bought early in large quantities, and before the season was out found that the firm from whom he secured his goods, owing to dull trade, was offering the same goods in small quantities for less than he had paid for them by the carload. This seems to me to be unjust and unfair competition, and is a disregard of the rights of the dealer by the very class of people who should be the most interested in his prosperity. A local dealer creates a demand and sells goods where a distant factory could never find a market, and it is not just for them to try to take the trade after another, by his energy and push, has created the demand.

In the second place, the dealer has a right to the pay for the goods he furnishes at the time he furnishes them. There is no greater curse to modern society than the miscellaneous credit system. Credit may be a good thing, but I am honest in the opinion that it would be a blessing to all if no man or woman could get anything for consumption before it was paid for. I do not mean to say that no man should eat who is not able to pay for what he eats, as there are many people who are proper subjects of charity, but I would like to see the time come when a man would shrink just as much from ask-



Rev. Emerson T. Abbott, St. Joseph, Mo.

ing one to trust him for goods as he would from appealing to him for charity. A good motto to adopt, especially for young people, is, "Pay as you go; if you cannot pay, don't go."

WHAT DOES THE SUPPLY-DEALER OWE TO THE HONEY-PRODUCER ?

He owes to him to fill his orders promptly, and to furnish him the best goods he possibly can for the money. He owes it to him to deal fairly with him, and to tell him the truth at all times. He owes it to him not to try to force articles on him for which he has no use, and which can in no way add to his success. The supply-dealer who does this either by personal appeal, or by a flaming and misleading "ad." in a paper, commits a grievous wrong for which he will be held morally accountable, just as much as he would if he secured money or property under false pretenses, which would be recognized as such by the laws of the land. One is just as much lying as the other, and just as criminal, morally speaking.

Lastly, the supply-dealer and honey-producer owe to each other mutual respect, confidence and forbearance. The calling of one is equally as honest and honorable as that of the other, and, as business is now conducted, each needs the other. Their interests are identical, and there should be no strife or clashing between them. In a world where there is plenty of room for all, each should be willing to give to the other all the room he needs. Thus laboring together, all can go through the world happy, contented, and without class strife or mutual denunciation.

EMERSON T. ABBOTT.

Mr. Abbott said: "I want to get credit for all the meanness I do;" and some one answered, "You will get it."

J. C. Stewart—I like the ideas just given by Mr. Abbott, very much. I think we could not get along without men who are willing to invest their money in goods. We must do things in the correct way, and should try to control the prices of our products. Let us fight to the last to accomplish this.

A Member—We are very apt to look at things just on one side, when we should study all sides.

A Member—I feel that there is a lot of thinking going on here; we might get it to the surface if a resolution were offered, that we might dispense entirely with the commission merchant and supply-dealer.

E. Kretchmer, Red Oak, Iowa—I think that the commission man could not be properly classed with the dealer. The commission man is simply my agent to sell my goods, and if I employ a man that I do not know, it is my fault if I have any trouble about it. Every one should know whether the firm with whom they deal is reliable or not.

Mr. DeLong—I am a honey-producer myself. I think I claim the ground that I am producing something, and I don't ship any honey to commission men. My plan is to keep the commission man off entirely. I have dealt with supply-dealers. I produced 450 pounds of honey this year from a single colony. I used a 10-frame, four-story hive. In 1891 I produced the same quantity.

A Member—How did you know the number of pounds ?

Mr. DeLong—I weighed the honey. I would not deal with a commission man if it were possible to avoid it.

Dr. Miller—Let me give you an illustration. I wanted some feeders. I went to a planing mill and had them cut out, and I put them together myself. I found that I did not have as good a feeder, then, and the part that I did get cost me more than the whole thing would if I had gotten them of a supply-dealer.

A Member—Take the matter of sections: How much do suppose I can get sections for? I can get them for \$2.50 per thousand.

Dr. Miller—The idea of expense comes in. I must have sections of the nicest kind, and my shipping-cases must be the best I can get, and so I go to the expense of getting the highest-priced articles. Mr. Secor thinks he must have sections and cases that cost a little more than mine, and Mr. Abbott gets goods that cost still more. We go so far with this matter that our products finally cost too much.

Mr. York—I wish to suggest that we have a recess of 15 minutes, to give the people a chance to join the society. We have as many here as there were at the meeting at Toronto last year, and yet only about 35 paid their dues at that meeting. I am sure there were over 100 bee-keepers in attendance at the last convention. We had at Toronto 50 members, but they were not quite all present.

The Secretary—There were 34 members who paid their dues at Toronto, and two absent. There were also 14 lady members, three life members, and two honorary members present. We have lost several members by death, and I move that an obituary committee of three be appointed.

The Secretary's motion was seconded and carried, and Messrs. Secor, Lang, and Abbott were appointed as said committee.

President Root—We want to get better acquainted, and we want to know more about you, so we will have a recess of 15 minutes.

(Continued on page 705.)

Contributed Articles.

Marketing Honey—Some Excellent Suggestions

BY MRS. L. HARRISON.

I've been very much interested of late in reading in the American Bee Journal what different writers have to say about marketing honey. Years ago, honey-producers complained that farmers and those who kept only a few colonies of bees, destroyed the market by lowering it, and now the tables are turned.

During the last fortnight there has been shipped from Michigan to this city fancy honey—the whitest comb, in the smoothest and whitest sections, in shipping-cases to match, holding 12 pounds. Grocers told the writer that they purchased this honey at the commission house for 15 cents per pound. The producer will probably realize 10 cents per

pound. Could not this honey have been disposed of at 20 cents per pound to consumers, located at mines, lumber camps, pleasure resorts, or small towns within a day's drive from where it was produced? If the producer has not the time to sell his honey, there are plenty of idle people who would be glad of the work.

If the families of bee-keepers were honey consumers like Dr. Gallup's, there would be much less upon the market. Many producers think that honey is to sell, not to eat. Others will not bother to sell a pound to a neighbor. I very much doubt whether the producer of that beautiful honey, lately shipped in here, would have been willing to have taken at his apiary the price that he will receive from this distant market.

Within a few days a grocer said to me: "Honey is going to be very cheap this year; the commission-houses are full of it." One season I heard of a woman who was selling honey very cheap, and I inquired where she lived, as I would like to visit her apiary. I was referred to a commission-house. This woman visited boarding-houses, hotels, grocers, etc., offering honey very low—wanted to get it out of their way as soon as possible.

A honey-route within a day's drive of an apiary would be valuable. When the route had been gone over a few times, the driver would know where to stop. It is well to sell only a few cases at a store, and keep supplying it regularly; buying your supplies only of those who patronize you. On the rounds, if a case of honey is found with a few unsightly sections in it, buy it back at the price you sold it at, and leave another in good shape. Some dealers, as long as they have a case with a few sections in it, will refuse to purchase more.

Try to have the case of honey kept in view of customers at the store. I was once shown a dozen tin pails of honey that the dealer told me he had had for one year, and had sold about one-quarter of a pound. He was located in a thickly populated part of the city, but he kept these pails of honey on a high shelf, and no one surmised that he had honey to sell.

The honey-man would soon be known along his route, and people living along it would watch and inquire for him, and request him to stop and sell them some honey. He would only require a few cases for holding the honey, as he could collect the empty ones, clean and refill. When his crop was sold, he would have double the cash than if he shipped, with less worry and expense.

I love the honey-bees, and like to work with them; yet I like some remuneration for my labor. Just as long as honey-producers persist in shipping all their honey to large cities—where in many instances it is reshipped to small towns, to find a consumer—so long will we be obliged to accept a low price for our product. I bought extracted honey in Florida at 10 per pound, that came all the way from Chicago.

Peoria, Ill.



Wide Frames and Sections as I Use Them.

BY G. M. DOOLITTLE.

Before me lies the following request: "Will you be kind enough to give the readers of the American Bee Journal a description of the wide frames you use, and also of your sections. I tried a few wide frames the past season on one colony, that giving me 65 pounds of surplus, while 28 pounds was the result where common supers were used. So I am sure a description of your surplus arrangement will be of interest to the most of the comb-honey producers who read the American Bee Journal."

I am perfectly willing to comply with the request made, but I feel it my duty to say, before doing so, that without doubt a close inspection of the colony on which the wide frames were used, during the time it was at work in the sections, would have revealed that the difference in the product, as above given, was more in the fact that this colony was in better condition to store surplus honey, than were the others. After using nearly all kinds of surplus arrangements, and trying this thing and that thing said to give the best results in honey. I have come to the conclusion that it is the *bees* which store the honey, and that Elisha Gallup was right when he said that "Bees would store just as much honey in a nail-keg, all other conditions being equal, as they would in the best hive ever invented." All that any hive can claim over a nail-keg, or any rough box, is that the owner can manipulate the hive in ways he cannot the box or keg, and that the honey stored, more than the bees need for winter, can be obtained in an easy-to-get-at and marketable shape. So I say, that a good yield of honey is to be credited to the individuality of the *man*, put into the business—an individuality which will put every colony each year in the shape the best was the year be-

fore—rather than to any *hives* or *surplus arrangement* in existence.

But as there is some difference in surplus arrangements, as to securing honey in the best shape for market, ease of manipulation, and enticing attractiveness to the bees, this latter securing an early entrance for work in the sections, I will briefly describe what I use, for the benefit of those who are not satisfied with what they are already using.

My wide frames are 15 inches long, by 5 13/16 deep, by 1 3/8 wide, holding four sections, 5 3/8 long or deep, by 3 1/2 inches wide, by 1 3/8 thick; dimensions given, being outside measure.

On one side of the wide frame is nailed a tin separator, the same being drawn taut by the top and bottom being sprung outward while it is being nailed on, the top and bottom when coming to their natural position again, stretching the tin tight. This separator is 1/2 inch narrower than the inside of the section, and is so put on the wide frame that it makes a 1/4 inch bee-space between the bottom and top of the same, and the inside of the bottom and top of the section. Separators thus used, I consider of no disadvantage in securing a large crop of honey, while by their use the crop is secured in the *most marketable* shape.

The ends of the wide frames are 1/2 inch thick, while the bottoms and top are only 3/16 thick. The top-bars are 3/4 of an inch longer than the bottoms, so that they have a 3/8 projection at each end to hang on rabbets where they are used in a super, and for convenience in handling when used without a super, as I use many of them by simply clamping the desired number together and setting them on the hives.

The bottom-bar is slotted or cut off 1/8 inch on each side, except at the end where it is nailed to the end pieces, so that when two of the wide frames come together this forms an entrance for the bees to pass into the sections. Where it is desired to tier up, the tops are slotted the same as the bottoms, and by thus doing we have a continuous passage-way, no matter how high the wide frames are tiered.

Where supers are used in connection with the wide frames, a given number must go on a hive at one time, and with my hives that number is 11, containing 44 sections; so I must use 44, or 88, or 132, etc.; but where they are clamped together I can use anywhere from 3 to 50, holding from 12 to 200 sections, beginning with the 12 and adding 4 sections, or any multiple of 4 as is needed by the colony. By this latter plan, and the use of sections filled with comb, or the new high-cell foundation, which we hope will soon come into general use, at a cost which will not exclude any one from using it, the bees can be gotten into the sections as soon as there is any honey coming in from the fields, and the room expanded as the bees increase, thus securing the largest yield of honey, and controlling the desire to swarm, which usually overtakes all colonies of bees worked for comb honey, in a good season.

The sections mentioned above will average one pound in weight, when filled and glassed on both sides, as the New York market calls for; or they will average about 13 ounces when filled with honey and sold without glass. Most people like an oblong comb of honey to set before guests, better than one which is square, and this was one of the reasons I adopted the size of section I am using.

Now don't let any one think they are obliged to use just the size of wide frame or section which I use, for it is not at all necessary. Just study up a size that will suit your hives and your market. Use a little common sense, and learn that it is the *I*, the *ego*, the *man*, *my own self*, I am to depend upon, and not Doolittle or any other person, and nine to ten you will succeed.

Borodino, N. Y.



Swarming with Large Hives—A Question.

BY C. P. DADANT.

I have received the following letter, which I will answer in the Bee Journal:

DEAR MR. DADANT:—I have just finished reading your article in reply to W. B., on page 609. Now I recognize you as a level-headed authority on bee-subjects, but I wish to submit this little conundrum:

I have a big hive (I made myself) holding 20 (!) usual size Langstruth frames. Last spring there was a large colony of Germans in it. They wintered well, had lots of honey last fall (York, Abbott or myself couldn't lift the hive). During the past summer the colony cast *five swarms*; one got away, and I managed to hive four of them, consequently I now have five colonies, and but little honey.

The above fact seems a little, contrary, to your opinion,

that with large hives the trouble of swarming is avoided; or have I read your statement incorrectly?

Yours truly,
Chicago, Ill., Sept. 24.

DR. PEIRO.

One swallow does not make a summer, and the experience of one hive does not create a sufficient test to decide by. If some one came to you, dear Doctor, and said that he had tried sulphate of quinine for ague, and it had not cured him, I am of opinion that you would still think that the medical fraternity is right in advising its use as a very certain cure for ague. But in treating a patient for ague, you would not advise the indiscriminate use of this drug, or in fact of any drug for any disease. It is quite possible that in your bee-case you have not used the drug in the proper manner, or it is quite possible that your patient—the colony of bees—is among the class of patients whose system is rebellious to the very best treatment.

In the first place, all does not depend upon having a strong colony in a large hive; the surplus room furnished to that colony must be in proportion to its strength. When we discussed the question of size of hives and stated that a 20-frame hive was too large, for usual purposes, we meant that it was too large for a breeding apartment, but we in no way meant that the bees should be confined to that size when the honey crop came. The statement that you make, that this colony cast off five swarms, is a very good evidence that we are right in wanting large hives for large crops, for it is a very unusual thing for a colony to cast five swarms, and this colony must have been of colossal strength—in fact, of such strength as could not be expected of any ordinary 10 or even 12 frame hive.

This fact being granted, the surplus apartment should have been proportionately large. If the brood occupied, say 14 frames, it left only 6 frames for honey, or about room for 35 or 45 pounds. A colony of such strength ought to be furnished twice as much room as an ordinary colony. Judging from your report, and that of Dr. Miller, the crop in the north of the State must have been tremendous, for a while at least. Your colony therefore should have been furnished room for say 75 pounds or 100 pounds of honey. If we had had that colony in our apiary, in such a season, we should have put two tiers of boxes upon it. I believe Dr. Miller reported several tiers of finished sections from a number of his colonies.

But room is not all that is needed—we want air, so the bees may not suffer. The entrance must be made sufficiently large that all the workers may go in and out at ease. The hot rays of the sun must be warded off. Too many drones are also a cause of swarming. Perhaps in this instance they helped to make the bees uncomfortable.

In most instances, however, with the large hives, the swarming is due to the delay in attending to the putting on of the supers. Men in business, for whom bee-culture is only a pastime, may often overlook the fact that their hives are getting well filled, and that the crop is about to open. When it has begun, and they discover it, it is often too late, for the bees have already made their preparations for the exodus of their surplus army, and no amount of manipulation will then change their decision.

It is true that it sometimes happens, with all these precautions carefully taken, that a colony will cast one or more swarms. We do not know how this may be helped, but after over 30 years of experience on this subject, we feel safe in asserting that 95 per cent. of the swarming may be prevented in the manner indicated, especially if supers with empty combs are furnished.

Hamilton, Ill.



Do Bees Gather Poisonous Honey?

BY I. W. BECKWITH.

Perhaps there has been enough said on this subject, but it seems to me there has been a tendency to look at only one side of the question, fearing that the knowledge that bees gather poisonous honey will injure the business, as the following quotations show:

"Will injure the sale of honey everywhere." "Such reports heralded broadcast will greatly damage the pursuit of bee-keeping." "Occasional reports of death from eating poisonous honey is not calculated to advance the market quotations."

Novice reports two deaths from eating honey, but assumes that it was the "bee-bread" and not the honey that killed them. Several writers, Prof. Cook among them, affirm that the great Creator, or "natural selection," produces only perfect harmony. If it would not take too much space, I might

show so many instances where the rule is seemingly broken that it almost ceases to be a rule.

Now, if there is a possibility that bees do gather honey that is unsafe for man to eat, I believe that an effort to disguise the fact will injure our business more than a fair discussion of the facts, so that people may know how to avoid being injured.

I would rather suffer a pecuniary loss, or, I should say, I would rather fail to make a profit at the expense of the health and perhaps death of my neighbor.

The evidence produced by most of those who take the negative of this question is very much like the evidence that a man proposed to offer when he was being tried for stealing a pig. When the court asked him if he had tried no defense to offer, he said: "Schurke, they brought in only two witnesses that saw me stale the poig, but if y'r honor will be so kind as to let me go out on the strrate a minute, I will bring in foive witnesses who will swarre that they did not see me stale the poig." These writers entirely ignore the statements of Geo. B. Hurley, Dr. Elmer, Prof. Wormley, W. A. Thompson, and others, their testimony being direct and positive, and consider only five witnesses who did not see Pat "stale the poig," and have no desire to call on Mr. Thompson for a sample of honey.

Prof. Cook says: "It is an unquestioned fact that in many regions along the Alleghany Mountains mountain laurel is very abundant, and is visited profusely by the bees. *Yet there is never any trouble from poisonous honey.*" (Italics mine.) In the face of such testimony as we have had, such a statement by the Professor is rather dogmatical.

Mr. Golden theorizes thus: "I cannot be persuaded that the great Creator of all things, animate and inanimate, would instill into plant-life a poisonous substance and cause it to be accessible to any of his creatures through any natural source in which created." The funny part of it is, that in the preceding paragraph he tells us that animals are killed by eating the buckeye "in the natural source in which created." And they all admit that mountain laurel does poison stock the same way.

Three years ago last spring I visited H. Rauchfuss' apiary, when he told me his bees had been dying off in great numbers. He thought he had lost half of his bees within a few days, and I saw great numbers of dead about the hives. He showed me a plant that he thought the bees gathered poisonous honey from, which killed them. The plant was nearly through blooming when I was there, and other flowers were abundant, and his bees had ceased dying. I found the plant to belong to the order *Serophulariaceae*, the same order to which fox-glove (*digitalis*) belongs, the whole order being deleterious. Mr. R. did not form his opinion from theory, for I think he knew nothing of the poisonous nature of the plant. I wish he would tell us what he now thinks of it. Perhaps this is what killed J. S.'s bees (see page 409). Mr. Rauchfuss also lives near Denver.

Now that another season of those poisonous (?) flowers has passed, and the attention of bee-keepers has been called to this subject, I hope we may learn something more definite regarding the nature of the honey.

There are two varieties of *kalmia*, mountain laurel—*K. latifolia* and *K. angustifolia*—which so closely resemble each other that it may require a botanist to distinguish them to a certainty, and this fact may have caused the difference in opinion among the different writers. Grover, Colo.

Only One Cent a Copy for copies of the American Bee Journal before Jan. 1, 1896. We have them running back for about 10 years. But you must let us select them, as we cannot furnish them in regular order, and probably not any particular copies. Just send us as many one-cent stamps as you may want old copies, and we will mail them to you.

The McEvoy Foul Brood Treatment is given in Dr. Howard's pamphlet on "Foul Brood; Its Natural History and Rational Treatment." It is the latest publication on the subject, and should be in the hands of every bee-keeper. Price, 25 cents; or clubbed with the Bee Journal for one year—both for \$1.10.

The Great Campaign Book offered on page 666, ought to be in the hands of every voter. It shows all sides of the political questions of the day. Better send for a copy of it. Orders filled by return mail.

See "Bee-Keeper's Guide" offer on page 701.

OLDEST BEE PAPER IN AMERICA

THE AMERICAN BEE JOURNAL

ESTABLISHED IN 1861

GEORGE W. YORK, Editor.

PUBLISHED WEEKLY BY

GEORGE W. YORK & COMPANY,

118 Michigan St., CHICAGO, ILL.

\$1.00 a Year—Sample Copy Sent Free.

[Entered at the Post-Office at Chicago as Second-Class Mail-Matter.]

Vol. XXXVI. CHICAGO, ILL., OCT. 29, 1896. No. 44.

EDITORIAL COMMENTS.

Here's a Whopper!—One of the would-be honey-commission firms of Chicago is still sending out circular letters—this time on white paper instead of yellow, the latter color seemingly being abandoned. Perhaps the misrepresentations printed on the suspicious yellow paper were too evident even to the writers of the same. At any rate, here's a sentence taken from a "white letter" sent to some of our subscribers, dated Oct. 9:

"Now we have been corresponding with you for a great many years in regard to honey, and you certainly must be familiar with the fact that we are one of the largest dealers in the same in this country, and it would be no mistake for you to ship yours to us and let us handle your goods."

When it is known that the firm signing their name to the above statement started *only last year*, and that we have received more complaints against them than all other firms in the whole country combined, it surely will be very clear that the quoted sentence is about as wholly untrue as anything possibly can be. But we presume our readers are pretty well warned by this time, not to notice such pleading letters as the one from which we have just quoted.

As we have said before, bee-keepers would better eat their honey themselves, or donate it to their less sweetened neighbors, than to ship it to some city firms like the ones we have had occasion to discountenance the past few months.

Unbusinesslike Methods.—We have received the following letter from Mr. Geo. W. Brodbeck, in reference to the way the publisher of the Pacific Bee Journal tries to do business:

LOS ANGELES, Calif., Oct. 10, 1896.

MR. EDITOR:—I notice that B. S. K. Bennett, in his last Pacific Bee Journal, advertises for consignments of honey, and gives as "*References by permission*," the following banks and agencies: "Merchants' National Bank, Southern California National Bank, Security Savings Bank, Dun's Mercantile Agency, Bradstreet's Mercantile Agency, and Saginaw Lumber Co.," all of which, on being asked for information (with one exception) stated positively that no such permission to refer to them had been given, and the one exception (Security) could not remember whether they had, or had not. And this is the man who attempts, by false statements, to reflect on the character of the writer.

The above I trust is sufficient evidence to prove to what class of individuals Bennett belongs. My unselfish interest in behalf of the bee-keeping interests of this State is too well known for such as he to question, and I am confident that this brief statement is enough to stamp his charges as false.

GEO. W. BRODBECK.

Of course, it is not a pleasant task to publish such reports as the foregoing, and yet, when a man like Bennett publishes such senseless, malicious and false attacks as he did against Mr. Brodbeck, in the October issue of his quarterly, we feel it

a duty to come down on him, and come down hard, too. The fact is, sometime ago we arrived at the conclusion that it is high time that honest and respectable bee-journalism should step flat-footed upon all fraud and misrepresentation whether attempted by a member of the bee-fraternity, or by those outsiders who would endeavor to cheat and defraud bee-keepers.

A leading California bee-keeper, in a letter to Mr. Brodbeck recently, said this:

"I do not think you need have any trouble; people know you too well to doubt your unselfishness or want of integrity. I am sure you may face such attacks with the utmost serenity."

Editor Root, in Gleanings for Oct. 1, after calling the last number of the Pacific Bee Journal "a pleasant surprise," somewhat modifies his compliment by saying:

"It is unfortunate that such a good start-out should be marred by the publication of an open letter from the editor directed to and attacking one of California's leading bee-keepers—Mr. Geo. W. Brodbeck, of Los Angeles—a man whom we have found to be the very soul of honor. Among California bee-keepers none stands higher. Elsewhere in the same journal is a paragraph that evidently refers to the same man in anything but complimentary terms, accusing him of slander to gain his ends."

Perhaps we have now given enough to show our readers that Mr. Bennett is utterly unworthy of patronage, and that any bee-paper starting out in a similar manner cannot hope to achieve success, for it would be entirely undeserved.

Honey Broken Down in Shipping.—About two weeks ago we happened over on South Water street, when a large honey-dealer called our attention to a shipment of comb honey from Wisconsin, that was nearly all broken down—the comb had completely broken from the section all around. It was a bad mess. The honey was in double-tier 24-pound shipping-cases, not crated.

We think the principal cause of the break-down, was that the double glass front of each case was completely covered with a thin board nailed on, thus preventing the railroad men from seeing what the contents was.

Another thing, the comb of honey in each section was not well fastened to the section-box—merely attached—the cells of honey being perhaps the width of two cells from the wood. Possibly only small foundation starters were used, and no bottom starters at all.

It is risky to ship comb honey, any way, and so about the only safe way is to put the cases in crates of about 200 pounds each, first putting in several laches of straw or hay packed down, and arranging the cases so that the glass fronts will show through the crate all around. The crate will of course have handles at each end, so that two men can handily carry it, or it can be trucked around.

Every bee-keeper knows what a sticky mess leaky honey-packages make, and he also knows that when honey is received in such condition by commission-men, it is almost impossible to get anything for it—it is so much work to melt it up, etc. Being aware of these facts, it behooves all who send comb honey away, to be extremely careful in packing for shipment—at least use every possible precaution to insure safe shipment. It won't pay to do otherwise.

Lincoln Convention Comments.—One of the things that interested us most, outside of convention hours, was the morning chapel exercise held for the students. Generally some professor or the Chancellor leads, after which all join in a closing song. It is very impressive. We wondered why this service was not held say at 8:30—that was the time set apart for it when we were in college. At Lincoln they begin at 10 o'clock—somewhat late for so enterprising a school.

The first morning all the bee-keepers were invited to take

seats upon the platform, so that no students would be compelled to stand. The second morning a few of the convention folks occupied seats on the rostrum, and the rest mixed among the students. Rev. E. T. Abbott was invited to read from the Scriptures and lead in prayer that morning, and Dr. Miller, who was on the program for an address to the students of the University the night before, had been invited to reserve his remarks until chapel time; so, after Mr. Abbott was through, Chancellor McLean introduced the Doctor, and he began to tell the six or eight hundred students about his own college days. Before closing, he gave them some splendid advice, following his talk with a most appropriate song, rendered in the Doctor's own effective manner. By request of a lady member of the convention, we here give the words, as sung by Dr. Miller, the same having been written by Mary Brown:

CONSECRATION.

It may not be on the mountains' height,
Or over the stormy sea;
It may not be at the battle's front
My Lord will have need of me;
But if by a still small voice He calls
To paths that I do not know,
I'll answer, "Dear Lord, with my hand in Thine,
I'll go where you want me to go."

REFRAIN—

I'll go where you want me to go, dear Lord,
Over mountain, or plain, or sea;
I'll say what you want me to say, dear Lord,
I'll be what you want me to be.

Perhaps to-day there are loving words
Which Jesus would have me speak—
There may be now in the paths of sin
Some wand'rer whom I should seek.
Oh, Saviour, if Thou wilt be my guide,
Tho' dark and rugged the way,
My voice shall echo Thy message sweet,
I'll say what you want me to say.

There's surely somewhere a lowly place,
In earth's harvest fields so wide—
Where I may labor thro' life's short day
For Jesus the crucified.
So trusting my all to Thy tender care,
And knowing Thou lovest me,
I'll do Thy will with a heart sincere,
I'll be what you want me to be.

Much credit for the success of the convention was due the committee of arrangements, composed of Messrs. E. Whitcomb, L. D. Stilson, and H. E. Heath. They were untiring in their endeavors to have everything pass off pleasantly and harmoniously. And they succeeded, too.

Dr. Mason—the ever-watchful Secretary—was right on hand with his endless quantity of good-nature, and contributed much to the profit of the meeting.

Dr. Miller seemed to be Pres. Root's right-hand man, though half of the time he sat at the President's left. The Doctor is right at home in a convention—always ready to help in keeping things moving. He should never be allowed to absent himself from a national convention, whether or not he has a crop of honey. Such men as he ought to be used as much as possible while they are spared on earth, for we must remember that we can't expect to have them with us here forever. But, of course, we must not over-use them, and thus hasten their departure.

Mr. and Mrs. R. C. Aikin, of Colorado, reached the convention the afternoon of the first day, having traveled by horse and wagon over 800 miles to get there. Their nice baby—about 18 months old—tried to do its part in making the proceedings interesting. Mr. Aikin and family expected to go on down into the South after the meeting, to spend the winter, and possibly to locate, we believe.

Mr. E. B. Gladish, wife and baby were also present. Mr. G. is a member of the R. B. Leahy Mfg. Co., of Higginsville, Mo. He is a pleasant young man to meet, and showed a

willingness to bear his share of the parental duties, that was very commendable. Mrs. Gladish was none the less attentive to their bright baby, which we judge was about the same age as the Aikin (not *Aching*) baby.

Mr. E. Kretschmer, of Red Oak, Iowa, was also on hand. He appeared to be well acquainted with the Nebraska bee-keepers. He is also a good man at a convention, for he talks right up, and does his part to keep things going in discussion. We met Mr. K. for the first time at the World's Fair, he having charge of the Iowa apiarian exhibit. He has a promising son attending the University at Lincoln.

At 2 p.m. of the second day, Chancellor McLean marched the convention in procession through the various buildings of the University. He said he'd put us through the complete University in the course of *one hour*. That surely seemed a short time to accomplish so much, but the bee-keepers, being used to almost everything, consented to the ordeal. When asked what "degree" was given to those taking the "One Hour Course," the cheery Chancellor replied, "Ph. D.—the 'Phool Degree.'" So far as we know, none of the attending bee-keepers have yet received their diplomas, and we think all tried hard to win the degree—of doubtful honor!

Before viewing the students hard at their studies, we felt that we'd just like to start into college work again; but *after* we had spent the hour in "sizing up" the large amount of information that we had yet to absorb before completing the University studies (for a higher degree than Ph. D., of course!) we were wholly discouraged, and will henceforth try to be contented with knowing only a little. "Where ignorance is bliss," etc.

We will reserve another installment of these comments for next week.

Geo. T. Wheadon Arrested.—The Chicago Evening Post for Oct. 15 contained the following notice referring to Geo. T. Wheadon, whom we have had occasion to refer to recently in the Bee Journal:

George T. Wheadon, a South Water street commission merchant, was arrested last evening by Constable Mulherin, of Justice Foster's court, on a warrant charging him with obtaining money under false pretenses.

Wheadon had, it is claimed, sold 840 tubs of butter and several dozen cases of eggs for J. M. McGrath, a Wisconsin farmer, and failed to turn over the proceeds of the sale.

At first, after being arrested, Wheadon denied his identity, but later admitted he was the man wanted. He was taken before Justice Hamburger, and gave bonds for his appearance before Justice Foster to-day. The case was continued to Oct. 22, the prisoner giving bonds for his appearance.

Our readers will recognize Wheadon as the one who a short time ago was flooding bee-keepers with circular letters pleading for shipments of honey. We also published a letter from Wheadon, in last week's Bee Journal, which indicated his character pretty well.

Honey as Food and Medicine.—A new and revised edition of this 32-page pamphlet is now issued. It has 5 blank pages on which to write or paste recipes taken from other sources. It is just what its name indicates, and should be liberally distributed among the people everywhere to create a demand for honey. It contains a number of recipes on the use of honey as food and as medicine, besides much other interesting and valuable information. Prices, postpaid, are: Single copy, 5 cts.; 25 copies 65 cts.; 50 for \$1.00; 100 for \$1.50. Better give them a trial. Send all orders to the Bee Journal office.

A New Binder for holding a year's numbers of the American Bee Journal, we propose to mail, postpaid, to every subscriber who sends us 20 cents. It is called "The Wood Binder," is patented, and is an entirely new and very simple arrangement. Full printed directions accompany each Binder. Every reader should get it, and preserve the copies of the Bee Journal as fast as they are received. They are invaluable for reference, and at the low price of the Binder you can afford to get it yearly.

PERSONAL MENTION.

MR. W. BISHOP, of Colorado, writes: "The Bee Journal is worth five times what it costs. It will save 100 per cent. to the one who keeps bees."

MR. AND MRS. WM. McEVoy, of Woodburn, Ont., kindly sent us an invitation to the wedding of their daughter—Miss Eliza Jane McEvoy—to Mr. Walter M. Daw, which took place Oct. 28. Our heartiest congratulations are hereby tendered the happy couple.

MR. THOS. WM. COWAN, editor of the British Bee Journal, London, England, expects to make a trip to this country shortly. We have never had the pleasure of meeting Mr. Cowan, who is probably the most widely known English bee-keeper of to-day.

PROF. LAWRENCE BRUNER—entomologist and ornithologist at the University of Nebraska, at Lincoln—in a private letter dated Oct. 20, writes this kindly sentence:

"Now that the North American Bee-Keepers' meeting has adjourned, and all of the visiting members have gone home, we begin to realize what a good thing we had in that meeting."

Yes, and what a good thing all the "visiting members" had when they were given the whole of Lincoln for several days, including all the hospitality that was thrown in with it! We are sure everybody went home feeling well repaid for going. We did.

MR. THOS. G. NEWMAN, now of San Diego, Calif., wrote us thus, Oct. 14, for which we thank him:

DEAR FRIEND YORK:—Nebraska papers are here, with the announcement of your election to the Presidency of the North American Bee-Keepers' Association. Allow me to congratulate you, and to hope that you may make it a brilliant success. The meeting seems to have been harmonious and interesting. I should have been pleased to have been there. . . . I go to Los Angeles Saturday, where I am to preach twice next Sunday. Last Sunday I was at National—near the Mexican line. They are keeping me very busy all the time. Mrs. Newman is improving. THOMAS G. NEWMAN.

MR. A. D. D. WOOD, late of Los Angeles, Calif., called on us last week when on his way to his old home in Michigan. Mr. W. has spent about a year in California, working with bees and bee-supply manufacturing. It was he that expected to rear queens on Catalina Island—some 50 miles off the coast—where, until he investigated thoroughly, he thought no wild bees were. But he found that there were already many native bees on the island, so he gave up the project. He had an apiary near Los Angeles of about 400 colonies, which he has left in charge of Mr. J. H. Martin, we believe.

Mr. Wood is a very pleasant man to meet, and one who appears to fully understand his business. His wife has been taking care of his home apiary in Michigan, during his absence, and reports a successful year; while in California, where Mr. wood was located, the season has been a complete failure.

Questions AND Answers.

CONDUCTED BY

DR. C. C. MILLER, MARENGO, ILL.

[Questions may be mailed to the Bee Journal, or to Dr. Miller direct.]

Double Hives for Wintering, Etc.

I had 7 colonies of bees, spring count, increased to 17, and got 375 pounds of comb honey, and about 100 pounds of extracted. I use the 8-frame dovetailed hives, but I had a lot of swarms leave for the woods the past summer. I tried to get the colonies strong, but the first thing I knew they had swarmed out, and they had plenty of room to work in. They would work in a super till it was one-half full, and then swarm out, which left me a lot of unfinished sections.

1. I did not want so many colonies to winter, so I doubled them up in August. I put one hive on top of the other, and

at this time I take the top hive off and leave all the bees in the lower story, which is very strong in bees and honey for winter. Is this a good plan?

2. Will the top stories be all right to leave all the honey in, and put swarms in them next season?

3. How should I prepare my hives in the cellar, which is little damp?

O. S.
Hayward, Minn.

ANSWERS.—1. Your plan will work all right providing enough honey is left for the bees. Possibly the bees would winter all the better to leave them the two stories all winter, and then in the spring you could take one story away in time to use it for another colony.

2. Yes, if there isn't enough honey in them to crowd the queen too much.

3. No special preparation of the hives is needed beyond giving abundant entrance for fresh air below. One good way is to take the floor away entirely, letting the hive be supported on each side so the bottom is entirely open. Then try to allow some way for the entrance of air into the cellar.

Wintering Queens—Bees by the Pound.

1. Please tell me how to keep extra queens over winter.

2. What kind of a receptacle do dealers put bees in for transportation, when sold by the pound? How do they send them—by mail or express?

C. C. B.

ANSWERS.—1. Not many are kept over except in weak colonies or nuclei. You may successfully keep them by having two nuclei in one full-sized hive, the nuclei being each about half as strong as a full colony. Have a solid division-board about $\frac{1}{4}$ or $\frac{3}{8}$ of an inch thick in the center of the hive, so that no bee can pass from one side to the other, and the bees of each side will cluster up against the division-board just as if all were one colony.

2. Selling bees by the pound has fallen into disrepute, and you find them dropped out of price-lists, but when they were sent, it was in light boxes provided with wire-cloth on one or more sides. Bees by the pound were probably always sent by express.

House-Apiaries—The "A B C"—Wintering.

1. Would it do to build a house and set my hives in it? How close can I put the hives together?

2. Will the "A B C of Bee-Culture" do to go by?

3. Is it best to pack the hives in chaff for winter, or leave them as when on the summer stands?

A. W. A.

Webb City, Mo.

ANSWERS.—1. If the climate of southwest Missouri, where you live, is as mild as I suppose, I doubt whether there is any better place to winter your bees than on the summer stand. Yet my opinion is not worth so much to you as that of some one in your locality who is successful in wintering. Find such a one, and learn what his custom is.

2. The "A B C of Bee-Culture" is a very safe work to go by, but I'm not sure that it doesn't speak a little too much in favor of house-apiaries in one place. Some are successful with them while others are not. Better go slow in that respect.

3. It may be all the better to have some packing about the hives.

The Alsike Clover Leaflet consists of 2 pages, with illustrations, showing the value of Alsike clover, and telling how to grow it. This Leaflet is just the thing to hand to every farmer in your neighborhood. Send to the Bee Journal office for a quantity of them, and see that they are distributed where they will do the most good. Prices, postpaid, are as follows: 50 for 25 cents; 100 for 40 cents; or 200 for 70 cents.

The Names and Addresses of all your bee-friends, who are not now taking the Bee Journal, are wanted at this office. Send them in, please, when sample copies will be mailed to them. Then you can secure their subscriptions, and earn some of the premiums we have offered. The next few months will be just the time to easily get new subscribers. Try it earnestly, at least.

Now is the Time to work for new subscribers. Why not take advantage of the offer made on page 686?

The "Premium" : A Good Watch Mailed Free !

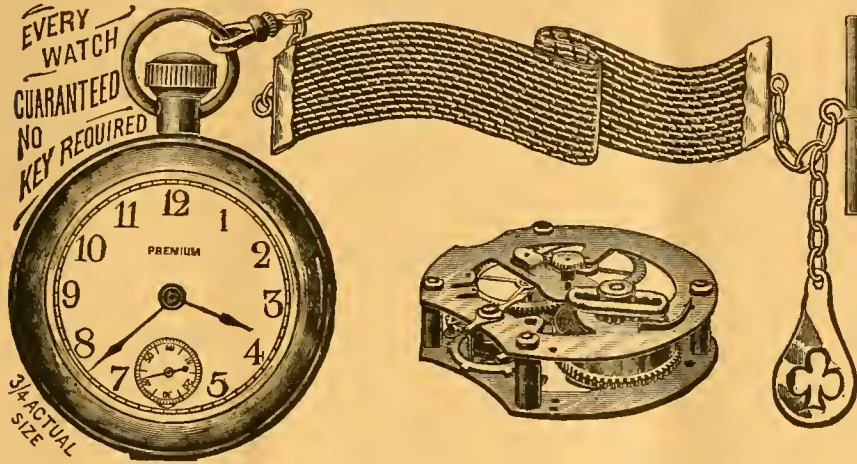

The movement of this Watch is regular American lever, lantern pinion, quick train, 240 beats per minute, three-quarter plate, short wind; runs 30 hours to one winding; dust cap over movement; every movement fully timed; regulated and guaranteed for one year, the same as a Waltham or Elgin; nickel finish, heavy bevel crystal, and back pinion wind and set.

OUR OFFERS :—We will mail the above Watch for \$1.25; or club it with the Bee Journal for a year—both together for \$2.10; or we will send it free as a premium for getting **Three New yearly Subscribers** to the Bee Journal at \$1.00 each. The Watch is mailed from New York City, so please allow a few days before expecting your order to be filled.

GEORGE W. YORK & CO., 118 Michigan St., Chicago, Ill.

✦ **MONEY SAVED IS MONEY GAINED.** ✦

THE ROYAL UNION Life Insurance Company DES MOINES, IOWA.

The Iowa Policy

Is one that definitely promises to keep an accurate account with you; credit your premiums and interest, charge the actual expense and mortuary cost, and hold the remaining funds subject to your order.

Agents Wanted.

JOHN B. KING, GENERAL AGENT,
Suite 513 First Nat'l Bank Bld'g,
20Atf **CHICAGO, ILL.**

Mention the American Bee Journal.

THROAT AND LUNG DISEASES,
DR. PEIRO, Specialist
Offices: 1019, 100 State St.,
CHICAGO. Hours 9 to 4.

Mention the American Bee Journal.

DUQUESNE COLLEGE !

PENN AVE. AND EIGHTH ST.

PITTSBURG, PA.

Thorough Courses — Classical, Scientific, Normal, English, Commercial, Preparatory, and Ladies Literary. Efficient and experienced instructors. Day and Night sessions.

Send for Catalog.

Mention the American Bee Journal.

IF YOU WANT THE

BEE-BOOK

That covers the whole Apicultural Field more completely than any other published, send \$1.25 to Prof. A. J. Cook, Claremont, Calif., for his

Bee-Keeper's Guide.

Liberal Discounts to the Trade.

Mention the American Bee Journal.

Question-Box.

In the multitude of counsellors there is safety.—Prov. 11-14.

Packages for Marketing Comb and Extracted Honey.

Query 34.—1. What size and style of shipping-cases do you prefer for marketing comb honey?

2. What size and style of package do you find best for extracted honey?—IOWA.

W. L. Larrabee—1. 20-lb. single tier. 2. 60-lb. cans.

G. M. Doolittle—1. "Prize" shipping-case, holding 20 one-pound sections. 2. 150-lb. kegs.

Mrs. L. Harrison—1. 12-lb. cases. 2. I sell but a limited amount of extracted; quart Mason jars.

Prof. A. J. Cook—1. A case not too heavy for one man to handle easily. 2. Jacketed five-gallon cans.

R. L. Taylor—1. I use one that holds 14 ordinary 7-to-the-foot sections, with a 2-inch strip of glass in one end.

C. H. Dibbern—1. Cases holding 24 to 32 4¼x4¼ sections, single tier, with one side glassed. 2. Tin lard-pails.

P. H. Elwood—1. A two-dozen single-tier section-case. 2. Tin pails for the market; barrels for the wholesale trade.

Rev. E. T. Abbott—1. 24-lb. single-tier. 2. Muth's honey-jars. Something else might be better in other localities. It all depends upon the market.

E. France—2. We use a barrel that holds 360 pounds of honey. We have tried 500-pound barrels, but don't like them; they are too heavy to handle.

Rev. M. Mahin—1. I have never shipped comb honey. 2. I have shipped extracted honey only in small lots in tin cans holding from one to four gallons.

Chas. Dadant & Son—1. One story 24-section cases, glassed on one side. 2. Tin cans or pails from 2-lbs. up to 60. The 5-lb. package sells the most honey.

Dr. C. C. Miller—1. A case holding 12 sections, glass on one side, three sections showing. Also a case of the same kind, double as high, holding 24 sections.

Mrs. J. N. Heater—1. One-tier shipping-cases, to hold 28 7-to-the-foot or 24 2-inch sections. 2. 60-pound cans for wholesale, and Mason fruit jars for retail.

Dr. J. P. H. Brown—1. I prefer small cases holding not over 24 pounds; 12-lb. cases still better. 2. I use self-sealing jars—one and two quarts—for home market.

J. M. Hambaugh—1. 12-lb-cases, glassed on two sides. 2. The two square tin cans to the case, making 120 pounds. I believe cans that would hold 50 or 100 pounds to the case would be preferable.

J. A. Green—1. For shipping to a distant market, 12-section cases. For supplying retailers near home, 24-section cases, single-tier, four sections long, six wide, glassed on one side. 2. For my wholesale trade, barrels. For retailing, pint Mason jars.

G. W. Demaree—1. I prefer a crate with glass on one side, that will hold 24 sections. 2. I have realized better prices for my honey taken with the extractor by shipping in tin buckets with the lids

Extracted Honey For Sale !

We can furnish **Basswood** Extracted Honey, in 60-pound tin cans, on board cars in Chicago, at these prices: 1 can, in a case, 8 cents per pound; 2 cans in one case, 7½ cents; 4 cans (2 cases) or more, 7¼ cents; or in kegs holding about 275 lbs., net, at 7 cents. Cash must accompany each order.

A sample of the honey will be mailed to an intending purchaser, for 10 cents, to cover postage, packing, etc. We guarantee purity, and what we ship will be equal to sample.

Now it seems to us here is a splendid chance for any bee-keeper to supply his home demand after his own crop is all sold. Or, why not begin now to create a local honey-trade? Order one 60-pound can first, and start out among your neighbors and friends, and see what you can do. You ought to get at least 15 cents per pound in 5-pound lots, or 50 cents for 3 pounds. Some may be able to do even better than that, though we think that enough ought to be sold at these prices to make a fairly paying business out of it. Give it a good trial. Push it. It may grow into a nice winter's work for you.

GEORGE W. YORK & CO., 118 Michigan Street, CHICAGO, ILL.

wired down. I have used largely three sizes—4 quarts, 8 quarts, and 10 quarts. These sizes hold for shipment, respectively, 9, 18, and 24 pounds. The last good crop of honey I procured, shipped in this way, cleared me 12½ cents per pound, when honey was quoted in the Eastern and Western cities at from 4 to 8 cents per pound.

Eugene Secor—1. One holding from 12 to 24 sections, single tier. 2. For home market, I find nothing better than glass fruit-jars—pints and quarts. My grocerymen will furnish all I want to fill. I don't buy them. For shipping, I should be governed by circumstances.

Jas. A. Stone—1. Single tier, 24-lb. cases, one side glassed. 2. This question cannot be answered, as what will suit one market, or one class of people, will not satisfy another at all. Every bee-keeper can educate his customers to a particular package so long as it is not too dear, and he sells at a figure that will keep out competition.

J. E. Pond—1 and 2. I don't produce honey for marketing, so I have no idea or practical knowledge on the subject. I have kept bees for amusement, exercise, and study only; usually only four or five colonies, and experiments with bees are always at the loss of crops. I never hesitate to destroy a colony in the attempt to prove or disprove a principle or theory, and only produce enough honey (and sometimes not that) for my own consumption.

General Items.

Secured a Good Average.

The season is now over, which was No. 1 in this locality. I got 1,200 well filled sections from 11 colonies, spring count, and an increase of three, by drawing brood in the swarming season, but that was not until August, and so I didn't get any surplus honey from the three young colonies, but I think 110 well filled sections per colony is a very good average; besides about 25 or 30 sections half-capped over, and from these on down to nothing.

JOHN H. RUPP.

Washington, Kans., Oct. 19.

Report for 1896—May Sickness.

In reply to the request of Mr. S. W. DeBusk, on page 572, my expenses for 1896, besides personal expenses, were about \$77 for supplies; my income from bees was nothing; and my loss in apianian capital (bees) was about 75 per cent., besides getting no swarms either from my own bees, or from 80 other colonies run on shares, from which I was to have had half the swarms.

The cause of this unexpected reverse was a mysterious malady confined to the immediate neighborhood of Denver, within a circle of about 10 miles radius. During the last two months of spring the bees steadily dwindled, until just before the flow the strongest were no more than nuclei. The theory was suggested by one of our number that spring fogs or dews absorbed deleterious substances from the smelter smoke in the atmosphere; then being deposited on the pollen of cottonwoods and other



Blooming Health . .

secured to every woman
by the use of

Warner's Safe Cure

Thousands of afflicted
women have been cured
by its use.

Why not You?

A Purely Vegetable
Preparation.

A Remedy with a Remarkable
Record.

Large bottle or new style smaller
one at your druggists. Write for Medical
Blank free. Warner's Safe Cure
Co., Rochester, N. Y.

Mention the American Bee Journal.

YOUR BEESWAX!

UNTIL FURTHER NOTICE, we will allow 25 cents per pound for Good Yellow Beeswax, delivered at our office—in exchange for Subscription to the BEE JOURNAL, for Books, or anything that we offer for sale in the BEE JOURNAL. Or, 23 cts. cash.

GEORGE W. YORK & CO.,

CHICAGO, ILLS

Mention the American Bee Journal.

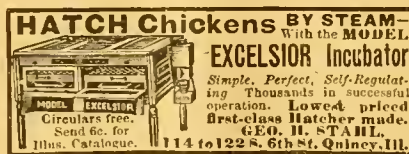

44A26t Mention the American Bee Journal.

Bee-Keepers' Photograph.—We have now on hand a limited number of excellent photographs of prominent bee-keepers—a number of pictures on one card. The likeness of 49 of them are shown on one of the photographs, and 121 on the other. We will send them, postpaid, for 30 cents each, mailing from the 121 kind first; then after they are all gone, we will send the 49 kind. So those who order first will get the most "faces" for their money. Send orders to the Bee Journal office.

See the premium offer on page 651!

plants, poisoned the bees. Later I read exactly the same theory in a German bee-paper, to account for what the Germans call "May sickness," a disease apparently identical with paralysis. But the thin feed, which the German writer used with success as a remedy (to dilute the poison), was tried here with absolutely no success.

My sentiments on specialty are of course unchanged, for "life is more than living." Besides, I see no reason to doubt that in the long run specialty is more profitable. F. L. THOMPSON.

Denver, Colo., Oct. 18.

Very Dry Year.

It has been the driest year I ever saw. There were but few seeds of the sweet clover I ordered last spring that came up, but in extremely dry weather it is living yet.

My bees have stored enough honey in the last four weeks from the cotton bloom for winter supplies.

LOUIS TEDDER.

Alvord, Tex., Oct. 10.

A Beginner's Report.

I am a beginner, starting last spring with four colonies, and now I have 11, and they have been doing well. I took 200 pounds of surplus honey from them. My uncle, in the next county, has 16 colonies, and when he went to take his surplus honey off, he had but 16 pounds in all.

JNO. STEWART.

Munson's Station, Pa., Oct. 12.

Poor Season for Bees.

Bees have done no good here. I have 35 colonies, and took 55 gallons of extracted honey—no comb honey and no increase at all. We have had a good flow of honey for the past two or three weeks, but it is too late to get a surplus. But the bees are rich in winter stores. I cannot do without the Bee Journal.

FRANK BELL

Deport, Tex., Oct. 13.

Was It Too High?

I read on page 647, that Mr. Sidney Sleeper, of Holland, N. Y., reports that his 188 colonies of bees gathered, "on Aug. 15, 1,500 pounds of basswood and 7,000 pounds of buckwheat honey;" and the Editor asks, "How's that for high?" Well, that's several thousand pounds too high. But what puzzles me is how he gets the weight to a pound; how the bees hit such round numbers exactly, with not an odd pound or fraction, more or less; and how he kept the two kinds of honey separate, so as to exactly weigh each. Yours in doubt,
Hawk's Park, Fla. W. S. HART.

[We shall have to call on Mr. Sleeper for an explanation, as he probably is the only man that can answer satisfactorily. —EDITOR.]

Results of the Past Season.

I like the Bee Journal very much, and find a great many useful things in it.

I had two colonies last spring—not very strong—and from them I got about 40 pounds of comb honey in one-pound boxes. They stored honey only about

two weeks in June. I have increased to 9 colonies, but I shall destroy two as they are black, and keep only Italians, as they are so much better to handle. I examined them the past week, and find that they will go into winter with from 30 to 50 pounds of honey. I think they ought to come out all right in spring, if looked after a little. I have kept bees for 20 years, and did not know anything about them until this year. I have learned a great deal, and have enjoyed them very much. If a good season I shall expect to get some honey next year, as I am well fixed for it. The pasture will not warrant keeping more than 10 colonies here, I think, as there are a good many here. FRANK D. KEYES.

Florence, Mass., Oct. 19.

A Beginner's Experience.

I have read the Bee Journal every Saturday since I began to take it, and now I think I could not get along without it. I can learn more from it than any other book or paper I know of.

I began a year ago with one colony; they were on eight frames, and lived till March, then starved. This fall I went bee-hunting, and found a bee-tree with about 8 pounds of bees; they had about 5 pounds of honey, and enough comb for 80 pounds of honey. They were very gentle, and did not try to sting much. I got them, put them into a hive, and fed them about 33 pounds of granulated sugar. They do not have many bees now. I like them very much. Bees stored about 75 pounds per colony here, on the average—I mean surplus comb honey. GEO. H. PORTER.

Sabael, N. Y., Oct. 15.

Report for the Season.

From 24 colonies, spring count, I have taken about 1,500 pounds of comb honey. My best colony gave me 112 well-filled one-pound sections; second best, 105 pounds; third, 95, and so on down to nothing. I have sold 400 pounds at from 10 to 13 cents at home and in adjoining towns. Last week I was out and peddled in the town of Kewanee, and sold 86 pounds by going from house to house, but it is slow work, as they will not buy more than one or two pounds at a house. I only struck one house that I could sell a whole case of 24 pounds, and then had to trust them for the pay.

Bees are in good condition for winter.

G. E. NELSON.

Bishop Hill, Ill., Oct. 15.

CORRECT MANNERS: HOW TO BEHAVE IN SOCIETY

Containing clear and concise directions for correct manners and usages of polite society. Many people have been misjudged for years simply because they had neglected to perform some little polite act at the proper time; many young men and women have lost the opportunities of a life-time on account of their ignorance of some trifling customary rule of Society. Our Book tells all about it. 186 pages. Russia. Red Edges. Price, 75 cts.



Special Offer. We will mail this book free as a premium to any one sending us two New Subscribers to the Bee Journal for one year (with \$2.00), and also send a copy of the premium book "Bees and Honey" to each of the new subscribers; or we will club the book with the Bee Journal for a year—both for \$1.60.

THE "NOVELTY" POCKET-KNIFE!



Your Name on the Knife.—When ordering, be sure to say just what Name and Address you wish put on the Knife.

The NOVELTY KNIFE is indeed a novelty. The novelty lies in the handle. It is made beautifully of indestructible celluloid, which is as transparent as glass. Underneath the celluloid, on one side of the handle is placed an AMERICAN BEE JOURNAL reminder, and on the other side, name and residence of the Subscriber.

The material entering into this celebrated knife is of the very best quality; the blades are handforged out of the very finest English razor-steel, and we warrant every blade. The holsters are made of German silver, and will never rust or corrode. The rivets are hardened German silver wire; the linings are plate brass; the back springs of Sheffield spring steel, and the finish of handle as described above. It will last a lifetime, with proper usage.

Why purchase the Novelty Knife? In case a good knife is lost, the chances are, the owner will never recover it; but if the Novelty is lost, having name and address of owner, the finder will return it; otherwise to try to destroy the name and address, would destroy the knife. If traveling, and you meet with a serious accident, and are so fortunate as to have one of the Novelties, your pocket KNIFE will serve as an Identifier; and in case of death, your relatives will at once be apprised of the accident.

How appropriate this knife is for a Christmas, New Year or birthday present! What more lasting memento could a mother give to a son, a wife to a husband, a sister to a brother, a lady to a gentleman, or vice versa, a son to a mother, a husband to a wife, a brother to a sister or a gentleman to a lady—the knife having the name of the recipient on one side?

The accompanying cut gives a faint idea, but cannot fully convey an exact representation of this beautiful knife, as the "Novelty" must be seen to be appreciated.

How to Get this Valuable Knife.—We send it postpaid, for \$1.00, or give it as a Premium to the one sending us three new Subscribers to the BEE JOURNAL (with \$3.00), and we will also send to each new name a copy of the Premium Edition of the book "Bees and Honey." We club the Novelty Knife with the BEE JOURNAL for one year, both for \$1.90.

Any Name and Address Put on the Knife.

GEORGE W. YORK & CO.,

CHICAGO, ILLS.

Allow about two weeks for your order to be filled.

California

If you care to know of its Fruits, Flowers Climate or Resources, send for a Sample Copy of California's Favorite Paper—

The Pacific Rural Press

The leading Horticultural and Agricultural paper of the Pacific Coast. Published weekly, handsomely illustrated, \$2.00 per annum. Sample Copy Free.

PACIFIC RURAL PRESS,
220 Market St., - SAN FRANCISCO, CAL.

MUTH'S HONEY EXTRACTOR PERFECTION Cold-Blast Smokers,

Square Glass Honey Jars, Etc.

For Circulars, apply to CHAS. F. MUTH & SON, Cor. Freeman & Central Aves., Cincinnati, G. Send 10c for Practical Hints to Bee-Keepers.

Mention the American Bee Journal.

COMB FOUNDATION!

Wax always wanted for Cash or in Exchange for Fdn. or other Supplies. My trade is established on Low Prices and the merit of my Foundation. Orders filled promptly.

WORKING WAX INTO FDN. BY THE LB. A SPECIALTY. Wholesale prices to dealers and large consumers. Send for Prices and Samples to—GUS DITTMER, AUGUSTA, WIS.

Reference—Augusta Bank.

ILAtf

Mention the American Bee Journal.



ONE MAN WITH THE UNION COMBINATION SAW

Can do the work of four men using hand tools, in Rippling, Cutting-off, Milling, Rabbeting, Grooving, Gaining, Dadoing, Edging-up, Jointing Stuff, etc. Full Line of Foot and Hand Power Machinery Sold on Trial. Catalogue Free.

SENECA FALLS MFG. CO.,
46 Water St., SENECA FALLS, N. Y.
1Aly Mention the American Bee Journal.

PROF. A. J. COOK'S BOOK FREE!

The Bee-Keeper's Guide

OR
MANUAL OF THE APIARY.

This 15th and latest edition of Prof. Cook's magnificent book of 460 pages, in neat and substantial cloth binding, we propose to give away to our present subscribers, for the work of getting NEW subscribers for the American Bee Journal.

A description of the book here is quite unnecessary—it is simply the most complete scientific and practical bee-book published today. Fully illustrated, and all written in the most fascinating style. The author is also too well-known to the whole bee-world to require any introduction. No bee-keeper is fully equipped, or his library complete, without "THE BEE-KEEPER'S GUIDE."

Given For 2 New Subscribers.

The following offer is made to PRESENT subscribers only, and no premium is also given to the two new subscribers—simply the Bee Journal for one year:

Send us Two New Subscribers to the Bee Journal (with \$2.00), and we will mail you a copy of Prof. Cook's book FREE as a premium. Prof. Cook's book alone sent for \$1.25, or we club it with the Bee Journal for a year—both together for only \$1.75. But surely anybody can get only 2 new subscribers to the Bee Journal for a year, and thus get the book as a premium. Let everybody try for it. Will you have one?

GEORGE W. YORK & CO., 115 Mich. St., CHICAGO, ILL.

BEE-BOOKS

SENT POSTPAID BY

George W. York & Co.,
Chicago, Ills.

Bees and Honey, or Management of an Apiary for Pleasure and Profit, by Thomas G. Newman.—This edition has been largely re-written, thoroughly revised, and is "fully up with the times" in all the improvements and inventions in this rapidly-developing pursuit, and presents the apiarist with everything that can aid in the successful management of an apiary, and at the same time produce the most honey in an attractive condition. It contains 250 pages, and 245 illustrations—is beautifully printed in the highest style of the art, and bound in cloth, gold-lettered. Price, \$1.00.

Langstroth on the Honey-Bee, revised by Dadant.—This classic in bee-culture, has been entirely re-written, and is fully illustrated. It treats of everything relating to bees and bee-keeping. No apiarian library is complete without this standard work by Rev. L. L. Langstroth—the Father of American Bee-Culture. It has 520 pages; bound in cloth. Price, postpaid, \$1.25.

Bee-Keepers' Guide, or Manual of the Apiary, by Prof. A. J. Cook, of the Michigan Agricultural College.—This book is not only instructive and helpful as a guide in bee-keeping, but is interesting and thoroughly practical and scientific. It contains a full delineation of the anatomy and physiology of bees. 400 pages; bound in cloth and fully illustrated. Price, postpaid, \$1.25.

Scientific Queen-Rearing, as Practically Applied, by G. M. Doolittle.—A method by which the very best of Queen-Bees are reared in perfect accord with Nature's way. 176 pages, bound in cloth, and illustrated. Price, \$1.00.

A B C of Bee-Culture, by A. I. Root.—A cyclopaedia of 400 pages, describing everything pertaining to the care of the honey-bees. It contains 300 engravings. It was written especially for beginners. Bound in cloth. Price, \$1.25.

Advanced Bee-Culture, Its Methods and Management, by W. Z. Hutchinson.—The author of this work is too well known to need further description of his book. He is a practical and entertaining writer. You should read his book. 90 pages, bound in paper, and illustrated. Price, 50 cts.

Rational Bee-Keeping, by Dr. John Dzierzon.—This is a translation of his latest German book on bee-culture. It has 350 pages; bound in cloth, \$1.25; in paper covers, \$1.00.

Bienen-Kultur, by Thomas G. Newman.—This is a German translation of the principal portion of the book entitled BEES OF HONEY. 10 page pamphlet. Price, 40 cents.

Convention Hand-Book, for Bee-Keepers, by Thomas G. Newman.—It contains the parliamentary law and rules of order for Bee-Conventions—also Constitution and By-Laws, with subjects for discussion, etc. Cloth, gold-lettered. Price, 25 cts.

Thirty Years Among the Bees, by Henry Alley.—Gives the results of over a quarter-century's experience in rearing queen-bees. Very latest work of the kind. Nearly 100 pages. Price, 50c.

Why Eat Honey?—This Leaflet is intended for FREE distribution, to create a Local Market. 100 copies, by mail, 40 cts.; 500 for \$1.50; 1000, \$2.50. If 500 or more are ordered at one time, your name and address will be printed on them FREE.

How to Keep Honey and preserve its richness and flavor. Price same as Why Eat Honey.

Apiary Register, by Thos. G. Newman.—Devotes two pages to a colony. Leather binding. Price, for 50 colonies, \$1.00; for 100 colonies, \$1.25.

Preparation of Honey for the Market, including the production and care of comb and extracted honey. A chapter from BEES AND HONEY. Price, 10 cents.

Bee-Pasturage a Necessity.—This book suggests what and how to plan. It is a chapter from BEES AND HONEY. Price, 10 cents.

The Hive I Use, by G. M. Doolittle. It details his management of bees, and methods of producing comb honey. Price, 5 cents.

Dr. Howard's Book on Foul Brood.—Gives the McEvoy Treatment and reviews the experiments of others. Price, 25 cts.

Dictionary of Apiculture, by Prof. John Phil. Gives the correct meaning of nearly 500 apicultural terms. Price, 50 cts.

Winter Problem in Bee-Keeping, by G. R. Pierce. Result of 25 years' experience. 50 cts.

Handling Bees, by Chas. Dadant & Son.—A Chapter from Langstroth Revised. Price, 8 cts.

Bee-Keepers' Directory, by H. Alley.—Latest methods in Queen-Rearing, etc. Price, 50c.

Foul Brood Treatment, by Prof. F. R. Cheshire.—Its Cause and Prevention. Price, 10 cts.

Foul Brood, by A. R. Kohnke.—Origin, Development and Cure. Price, 25 cts.

History of Bee-Associations, and Brief Reports of the first 20 conventions. Price, 15 cts.

Honey as Food and Medicine, by T. G. Newman.—A 32-page pamphlet: just the thing to create a demand for honey at home. Should be scattered freely. Contains recipes for Honey-Cakes, Cookies, Fudings, Foam, Wines, and uses of honey for medicine.

Prices, prepaid—Single copy, 5 cts.; 10 copies, 35 cts.; 50 for \$1.50; 100 for \$2.50; 250 for \$5.50; 500 for \$10.00; or 1000 for \$15.00.

When 250 or more are ordered, we will print the bee-keeper's card (free of cost) on the front cover page.

Bee-Keeping for Profit, by Dr. G. L. Tinker.—Revised and enlarged. It details the author's "new system, or how to get the largest yields of comb or extracted honey." 80 p.; illustrated. 25c.

Emerson Binders, made especially for the BEE JOURNAL, are convenient for preserving each number as fast as received. Not mailable to Canada. Price, 75 cts.

Commercial Calculator, by C. Ropp.—A ready Calculator, Business Arithmetic and Account-Book combined in one. Every farmer and businessman should have it. No. 1, bound in water proof leatherette, calf finish. Price, 40 cts. No. 2, in fine artificial leather, with pocket, silicate slate, and account-book. Price, 60 cts.

Green's Four Books, by Chas. A. Green.—Devoted to, 1st, How We Made the Old Farm Pay; 2nd, Peach Culture; 3rd, How to Propagate Fruit-Plants, Vines and Trees; 4th, General Fruit Instructor. Nearly 120 pages. Fully illustrated. 25 cts.

Green's Six Books on Fruit-Culture, by Chas. A. Green.—Devoted 1st, to Apple and Pear Culture; 2nd, Plum and Cherry Culture; 3rd, Raspberry and Blackberry Culture; 4th, Grape Culture; 5th, Strawberry Culture. 129 pp.; illustrated. 25 cts.

Garden and Orchard, by Chas. A. Green.—Gives full instructions in Thinning and Marketing Fruits; Pruning, Planting and Cultivating; Spraying, Evaporation, Cold Storage, etc. 94 pages, illustrated. Price, 25 cts.

Kendall's Horse-Book.—35 pictures, showing positions of sick horses, and treats on all their diseases. English or German. Price, 25 cts.

Silo and Silage, by Prof. A. J. Cook.—It gives the method in operation at the Michigan Agricultural College. Price, 25 cts.

Lumber and Log-Book.—Gives measurements of lumber, logs, planks; wages, etc. 25c.

Maple Sugar and the Sugar Bush, by Prof. A. J. Cook.—Full instructions. Price, 35 cts.

Grain Tables, for casting up the price of grain, produce, hay, etc. Price, 25 cts.

Caponizing and Caponizing, by Dr. Sawyer, Fanny Field, and others.—Illustrated. All about caponizing fowls, and thus how to make the most money in poultry-raising. 64 pages. Price, 30 cts.

Our Poultry Doctor, or Health in the Poultry Yard and How to Cure Sick Fowls, by Fanny Field.—Everything about Poultry Diseases and their Cure. 64 pages. Price, 30 cts.

Poultry for Market and Poultry for Profit, by Fanny Field.—Tells everything about the Poultry Business. 64 pages. Price, 25 cts.

Turkeys for Market and Turkeys for Profit, by Fanny Field.—All about Turkey-Raising. 64 pages. Price, 25 cts.

Rural Life.—Bees, Poultry, Fruits, Vegetables, and Household Matters. 100 pages. 25 cts.

Potato Culture, by T. B. Terry.—It tells how to grow them profitably. Price, 40 cts.

Hand-Book of Health, by Dr. Foote.—Hints about eating, drinking, etc. Price, 25 cts.

Alsike Clover Leaflet.—Full directions for growing. 50 for 25 cts.; 100 for 40 cts.; 200, 70c.

Book Clubbing Offers.

(Read Carefully.)

The following clubbing prices include the American Bee Journal one year with each book named. Remember, that only ONE book can be taken in each case with the Bee Journal a year at the prices named. If more books are wanted, see postpaid prices given with

the description of the books on this page. Following is the clubbing-list:

1. Langstroth on the Honey-Bee.....	\$2.00
2. A B C of Bee-Culture.....	2.00
3. Bee-Keepers' Guide.....	1.75
4. Bees and Honey [Cloth bound].....	1.65
5. Scientific Queen-Rearing.....	1.75
6. Dr. Howard's Foul Brood Book.....	1.10
7. Advanced Bee-Culture.....	1.30
9. Bienen-Kultur [German].....	1.25
10. Rational Bee-Keeping [Cloth bound].....	2.00
11. Rational Bee-Keeping [Paper bound].....	1.75
12. Thirty Years Among the Bees.....	1.30
13. Bee-Keeping for Profit.....	1.15
14. Convention Hand-Book.....	1.15
15. Poultry for Market and Profit.....	1.10
16. Turkeys for Market and Profit.....	1.10
17. Capons and Caponizing.....	1.10
18. Our Poultry Doctor.....	1.10
19. Green's Four Books.....	1.15
20. Green's Six Books on Fruit-Culture.....	1.15
21. Garden and Orchard.....	1.15
23. Rural Life.....	1.10
24. Emerson Binder for the Bee Journal.....	1.60
25. Commercial Calculator, No. 1.....	1.25
26. Commercial Calculator, No. 2.....	1.40
27. Kendall's Horse-Book.....	1.10
30. Potato Culture.....	1.20
32. Hand-Book of Health.....	1.10
23. Dictionary of Apiculture.....	1.35
34. Maple Sugar and the Sugar Bush.....	1.20
35. Silo and Silage.....	1.10
36. Winter Problem in Bee-Keeping.....	1.30
37. Apiary Register (for 50 colonies).....	1.75
38. Apiary Register (for 100 colonies).....	2.00
39. Bee-Keepers' Directory.....	1.30

INFORMATION GOLD!

Worth It's Weight in

For your name and address on a postal card, we will tell you how to make the best wire fence on earth, horse-high, bull-strong and pig-tight, at the actual wholesale cost of wire. Kitzelman Bros., Box B, Ridgeville, Ind.

48Etf Mention the American Bee Journal.

THROAT AND LUNG DISEASES,
DR. PEIRO, Specialist
Offices: 1019, 100 State St.,
CHICAGO. Hours 9 to 4.
Mention the American Bee Journal

INCUBATION



is the first step in the poultry business and much of future success depends upon its completeness. There is no failure where RELIABLE INCUBATOR is used. It is fully warranted and is the product of twelve years of experience. It has never been beaten in a Show. It is not like its competitors—it is better. We tell why in new book on poultry. Send 10c for it. RELIABLE INCUBATOR AND BROODER CO., QUINCY, ILLS.

36E17t Please mention the Bee Journal.

Queens and Queen-Rearing.—

If you want to know how to have queens fertilized in upper stories while the old queen is still laying below; how you may safely introduce any queen, at any time of the year when bees can fly; all about the different races of bees; all about shipping queens, queen-cages, candy for queen-cages, etc.; all about forming nuclei, multiplying or uniting bees, or weak colonies, etc.; or, in fact, everything about the queen-business which you may want to know—send for Doolittle's "Scientific Queen-Rearing"—a book of over 170 pages, which is as interesting as a story. Here are some good offers of this book:

Bound in cloth, postpaid, \$1.00; or clubbed with the BEE JOURNAL for one year—both for only \$1.75; or given free as a premium for sending us three new subscribers to the BEE JOURNAL for a year at \$1.00 each.

National Bee-Keepers' Union.

PRESIDENT—Hon. R. L. Taylor. Lapeer, Mich.
GEN'L MOR.—T. G. Newman. San Diego, Cal.

"THE LITTLE GIANT BOOK-KEEPER!"

BOOK-KEEPING

AT A GLANCE.

By Expert J. T. BRIERLEY.

A SIMPLE AND CONCISE METHOD OF PRACTICAL BOOK-KEEPING.



With instructions for the proper keeping of Books of Accounts and Numerous Explanations and Forms used in a Commercial business; showing an ENTIRE SET OF BOOKS BASED UPON ACTUAL TRANSACTIONS.

How to take off a Trial Balance sheet; and finally CLOSE AND BALANCE ACCOUNTS; EQUATION OF PAYMENTS; METRIC SYSTEM OF WEIGHTS and Measures.

Containing 144 pp., size, 5 x 2 3/4 inches, bound in Flexible

Russia, indexed, 75 cents each, postpaid.

Special Offer: We will mail this book free sending us two New Subscribers to the Bee Journal for one year (with \$2.00), and also send a copy of the premium book "Bees and Honey" to each of the new subscribers; or we will club the book with the Bee Journal for a year—both for \$1.60.

GEORGE W. YORK & CO.,

CHICAGO, ILLS.

40,000.

THE Nebraska Farmer

Has made a contract with the Nebraska Club, to print for them 40,000 copies over and above the regular weekly issue, each month for six months, of reliable information about Nebraska.

If interested, send for free copy, to

MR. CHAS. E. WILLIAMSON,
Secretary Nebraska Club,
OMAHA, NEBR., or

Nebraska Farmer Co.
Lincoln, Nebr.

44A13 Mention the American Bee Journal.

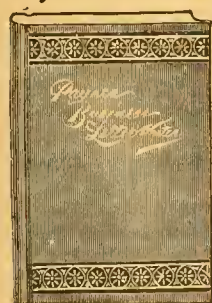
Payne's Business Letter Writer**and Manual of Commercial Forms.**

Containing specimen Letters on all possible business topics, with appropriate answers. Containing general information with regard to business matters, the rules for punctuation, the abbreviations most used in the mercantile world, a dictionary of mercantile terms, a table of synonyms, and other information which may be of value

to the business man. New edition, revised and enlarged. 216 pages, Extra Cloth, 75 cts.

Special Offer: We will mail this book free sending us two New Subscribers to the Bee Journal for one year (with \$2.00), and also send a copy of the premium book "Bees and Honey" to each of the new subscribers; or we will club the book with the Bee Journal for a year—both for \$1.60.

GEORGE W. YORK & CO.,

CHICAGO, ILLS.

Mention the American Bee Journal.

HONEY and BEESWAX**MARKET QUOTATIONS.**

The following rules for grading honey were adopted by the North American Bee-Keepers' Association, and, so far as possible, quotations are made according to these rules:

FANCY.—All sections to be well filled; combs straight, of even thickness, and firmly attached to all four sides; both wood and comb unsoiled by travel-stain, or otherwise; all the cells sealed except the row of cells next the wood.

NO. 1.—All sections well filled, but combs uneven or crooked, detached at the bottom, or with but few cells unsealed; both wood and comb unsoiled by travel-stain or otherwise.

In addition to this the honey is to be classified according to color, using the terms white, amber and dark. That is, there will be "fancy white," "No. 1 dark," etc.

Chicago, Ill., Oct. 20.—Fancy white, 12@13c.; No. 1, 11@11 1/2c.; fancy amber, 10c.; No. 1, 9c.; fancy dark, 9c.; No. 1, 7@8c. Extracted, white, 5@7c.; amber, 5@6c.; dark, 4 1/2@5c. Beeswax, 25c.

Receipts liberal; demand limited for all kinds.

Cincinnati, Ohio, Oct. 17.—Choice white comb, 12@14c.; dark grades, 8@12c. Extracted, 4@6c., according to quality. Demand is slow for all kinds of honey. Prices too low. Beeswax is in good demand at 20@25c. for good to choice yellow.

Philadelphia, Pa., Sept. 30.—Extracted, white, 8-10c.; amber, 4-5c.; dark, 3-4c. Beeswax, 25c.
No new comb in this market yet. Old comb cleaned out.

Detroit, Mich., Sept. 30.—No. 1 white, 12-12 1/2c.; fancy amber, 10-11c.; No. 1 amber, 9-10c.; fancy dark, 8-9c. Extracted, white, 5 1/2-6c.; amber, 5-5 1/2c.; dark, 4-5c. Beeswax, 24-25c.

Indianapolis, Ind., Oct. 3.—Fancy white, 14-15c.; No. 1 white, 12-13c. Extracted, white, 6-7c. Beeswax, 22-25c.
Demand is fair for grades quoted, but no demand for inferior grades.

St. Louis, Mo., Sept. 30.—Fancy white, 13@14c.; No. 1 white, 12@12 1/2c.; fancy amber, 11@11 1/2c.; No. 1 amber, 10@10 1/2c.; fancy dark, 8@9c.; No. 1 dark, 7@7 1/2c. Extracted, white, in cans, 5c.; in barrels, 4@4 1/2c.; amber, 3@3 1/2c.; dark, 2 1/2@3c. Beeswax, 19@20c.
Very little honey coming in at present, and the weather is too warm to handle to advantage if it were here.

New York, N. Y., Oct. 9.—Fancy white, 12@13c.; off grades, 10@11c.; buckwheat, 8@9c. Extracted is in fair demand at unchanged prices. Beeswax is doing a little better, and firm at 24@25c.

There is a fair demand for fancy white comb honey, while off grades, mixed, and buckwheat are rather neglected. Receipts are heavy and stock accumulating. Sales are principally in small lots, and in order to move round quantities it is necessary to make concessions from quotations.

San Francisco, Calif., Oct. 7.—White comb, 10c.; amber, 7 1/2-9c. Extracted, white 5-5 1/2c.; light amber, 4 1/2-5c.; amber colored and candied, 3 1/2-4 1/2c.; dark tulle, 2 1/2-3c.

With light arrivals and light local stocks there is little chance for prices to fluctuate to any material degree in favor of the buying interest. Inquiry is not active, however, and mostly local. Prices in foreign centers are below the parity of values current here.

Beeswax, fair to choice, 24-27c. There is no lack of demand for choice bright, free from adulteration, such being in scanty stock. It is the exception, however, where dark and inferior meets with prompt custom.

Albany, N. Y., Oct. 7.—Fancy white, 12-13c.; No. 1, 11-12c.; fancy amber, 9-10c.; No. 1 dark, 8-9c. Extracted, white, 6-7c.; dark, 4-5c.

The receipts of both comb and extracted honey are very large, and prices are somewhat lower. We have an ample stock of all styles except paper cartons weighing less than a pound.

Milwaukee, Wis., Sept. 30.—Fancy white, 14-15c.; No. 1, 12-13c.; No. 1 amber, 8-10c. Extracted, white, 6-7c.; amber, 5-6c.; dark, 4-5c. Beeswax, 22-24c.

New crop of honey begins to come forward. The demand is very poor and quotations almost nominal. Weather is very warm and the consumption of honey is very small. Plenty of fruit, and hence the appetite is satisfied with same in preference. Later on we expect an improved demand for honey of all kinds.

Minneapolis, Minn., Sept. 30.—Fancy white, 12 1/2c.; No. 1 white, 10@11c.; fancy amber, 9@10c.; No. 1 amber, 8@9c.; fancy dark, 7@8c.; No. 1 dark, 6-8c. Extracted, white, 5 1/2@6 1/2c.; amber, 5@5 1/2c.; dark, 4@5c. Beeswax, 23@26c.

The demand for both comb and extracted is very quiet, and for the latter, nominal. The hot weather of the past week or so has checked demand for comb honey.

Cleveland, Ohio, Sept. 30.—Fancy white, 14 1/2@15c.; No. 1 white, 12 1/2@13c. Extracted, white, 6@7c.; amber, 4 1/2@5 1/2c. Beeswax, 22@25c.

There is not very much honey in our market. Selling rather slow. Demand beginning to be a little better. Think trade will be fair in this line this fall.

Kansas City, Mo., Sept. 30.—Fancy white comb, 15c.; No. 1 white, 13@14c.; fancy amber, 12-13c.; No. 1 amber, 11-12c.; fancy dark, 10-11c.; No. 1, 8-10c. Extracted, white, 6-6 1/2c.; amber, 5-5 1/2c.; dark, 4-4 1/2c. Beeswax, 22-25c.

Buffalo, N. Y., Oct. 19.—Fancy comb, 1-pound, 13c., occasionally 14c.; No. 2, 8-10c.; No. 3, 4-7c. Extracted, 4-5c.

Demand better, and quite a consumptive trade now.

Boston, Mass., Oct. 9.—Fancy white, 13-14c.; No. 1, 11-12c. Extracted, white, 6-7c.; amber, 5-6c. Beeswax, 25c.

List of Honey and Beeswax Dealers.

Most of whom Quote in this Journal.

Chicago, Ills.

R. A. BURNETT & Co., 163 South Water Street.

New York, N. Y.

HILDRETH BROS. & SEGELKEN,
120 & 122 West Broadway
CHAS. ISRAEL & BROS., 486 Canal St.

Kansas City, Mo.

C. C. CLEMOMS & Co., 423 Walnut St.

Buffalo, N. Y.

BATERSON & Co., 167 & 169 Scott St.

Hamilton, Ills.

CHAS. DADANT & SON.

Philadelphia, Pa.

WM. A. SELSER, 10 Vine St.

Cleveland, Ohio.

WILLIAMS BROS., 80 & 82 Broadway.

St. Louis, Mo.

WESTCOTT COM. CO., 213 Market St.

Minneapolis, Minn.

S. H. HALL & CO.

Milwaukee, Wis.

A. V. BISHOP & CO.

Boston, Mass.

E. E. BLAKE & Co., 57 Chatham Street.

Detroit, Mich.

M. H. HUNT, Bell Branch, Wayne Co., Mich.

Indianapolis, Ind.

WALTER S. POWDER, 162 Massachusetts Ave.

Albany, N. Y.

CHAS. McCULLOUGH & Co., 380 Broadway.

Cincinnati, Ohio.

C. F. MUTH & SON, cor. Freeman & Central avs.

Bee-Keeper's Guide—see page 685.

Bottom Prices

**BRING US BIG TRADE.
GOOD GOODS KEEP IT.**

If you want the best supplies that can be made at a little less cost than you can buy the same goods for elsewhere, write to us for low prices. 1896 Catalogue now ready—ask for it and a free copy of **The American Bee-Keeper** (36 pages).

Address,
THE W. T. FALCONER MFG. CO.,
JAMESTOWN, N. Y.
Mention the American Bee Journal.

Honey-Clovers & Buckwheat SEED FOR SALE.

We have made arrangements so that we can furnish seed of several of the Clovers and Japanese Buckwheat, by freight or express, at the following prices, cash with order:

	5lb	10lb	25lb	50lb
Alske Clover.....	\$.70	\$1.25	\$3.00	\$ 5.75
Sweet Clover.....	.65	1.20	2.75	5.00
White Clover.....	1.25	2.00	4.50	8.00
Alfalfa Clover.....	.65	1.10	2.70	5.00
Orlson Clover....	.55	.90	2.00	3.50
Jap. Buckwheat...	.20	.35	.90	1.25

Prices subject to market changes.

Add 25 cents to your order, for cartage, if wanted by freight.

Your orders are solicited.

GEORGE W. YORK & CO.,
CHICAGO, ILLS.

BEGINNERS.

Beginners should have a copy of the **Amateur Bee-Keeper**, a 70-page book by Prof. J. W. Rouse. Price 25 cents; if sent by mail, 28c. The little book and the **Progressive Bee-Keeper** (a live, progressive 28-page monthly journal) one year, 65c. Address any first-class dealer, or

LEAHY MFG. CO., Higginsville, Mo.

WHEN ANSWERING THIS ADVERTISEMENT, MENTION THIS JOURNAL.

HONEY-JARS!

1-lb. square Flint Jars, with Corks, \$1.85 per gross. Including Labels, name and address on same, \$5.10 per gross.

A Full Line of Supplies on hand.
Catalogue.

I. J. STRINGHAM,
105 Park Place. NEW YORK, N. Y.
APIARY—Glen Cove, L. I.
Mention the American Bee Journal.

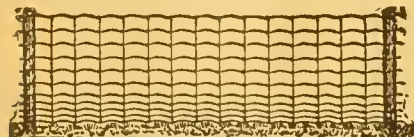

"It's better to be Right Than to be President"

Page fence is right and that is why it is the acknowledged ruler of the animal kingdom. If the people will only select as competent a ruler for themselves, everybody will be happy.

PAGE WOVEN WIRE FENCE CO., Adrian, Mich.

Mention the American Bee Journal.

READERS

Of this Journal who write to any of our advertisers, either in ordering, or asking about the Goods offered, will please state that they saw the Advertisement in this paper.

19th Year Dadant's Foundation 19th Year

Is still in the lead, for we use all the latest improvements, including the

NEW WEED PROCESS,

and still make the best goods. Remember that we do not use any acid to purify our bees-wax, and that is why our Foundation preserves the smell of the honey and is more acceptable to the bees, than any other. It is kept for sale by

T. H. Strickler, Solomon City, Kansas.
G. K. Hubbard, Fort Wayne, Ind.
L. Hanssen, Davenport, Iowa.
C. Theilmann, Theilmanton, Minn.
E. C. Eaglesfield, Berlin, Wis.
E. T. Abbott, St. Joseph, Mo.
J. M. Jenkins, Wetumpka, Alabama
John Rey, East Saginaw, Mich.
Vickery Bros., Evansville, Ind.

The Jennie Atchley Company, Beeville, Texas.
C. F. Muth & Son, Cincinnati, Ohio
E. Kretchmer, Red Oak, Iowa.
G. B. Lewis Co., Watertown, Wis.
James Reynolds Elevator Co., Poughkeepsie, N. Y.
Louisiana Bee-Keepers' Supply Manufactory, Donaldsonville, La.
Page & Lyon, New London, Wis.
John Nebel & Son, High Hill, Mo.

and many other Dealers. All agree in saying that no goods are better than ours.

We make a specialty of **Veils and Veil-Stuffs** of best quality, cotton and silk.

Langstroth on the Honey-Bee, Revised

Bee-Keepers' Supplies, Smokers, Sections, Tin Pails, etc.

Samples of Foundation and Tulle FREE with Circular. Instructions to beginners with Circular. Send us your address.

CHAS. DADANT & SON,

Mention the American Bee Journal.

HAMILTON, Hancock Co., ILL.

There Is No Doubt About the MERIT of **THE KEYSTONE DEHORNING KNIFE**. It cuts both ways, does not crush. One clip and the horns are off close. Write for circular. **A. C. BROSIUS, Cochransville, Pa.**

Mention the American Bee Journal

40E13t

* Extracted Honey *



Finest Quality, Basswood and Clover.
2 60-lb. cans in case, 7c. per pound. 1 60-lb. can in case, 8c. per pound. A sample by mail, 10 cts. **POUDER'S Honey-Jars and Complete Line of Supplies.** Catalogue Free.

WALTER S. POWDER,
162 Mass. Avenue, INDIANAPOLIS, IND.

PATENT WIRED COMB FOUNDATION



Has No Sag in Brood-Frames

Thin Flat-Bottom Foundation

Has No Fishbone in the Surplus Honey.

Being the cleanest is usually worked

the quickest of any Foundation made

J. VAN DEUSEN & SONS,
Sole Manufacturers,
Sprout Brook Montgomery Co., N. Y.

Root's Double-Walled Dovetailed Chaff Hives, and Winter-Cases for Single-Wal'ed Hives,

Have met with much success everywhere in wintering. The Double-Walled Chaff Hive is light, neat, compact, and weighs only a trifle more than the single-walled hives of the same capacity. Now is the time to lay in your stock for winter.

Send for Catalog and Prices.

THE A. I. ROOT COMPANY,

Factory and Main Office, MEDINA, O.

BRANCH OFFICES:

118 Michigan St., Chicago, Ill.
1024 Miss. Str., St. Paul, Minn.

Syracuse, N. Y.
Mechanic Falls, Maine.

AMERICAN BEE JOURNAL

DEVOTED EXCLUSIVELY TO THE INTERESTS OF HONEY-PRODUCERS

ESTABLISHED IN 1861
THE OLDEST BEE-PAPER IN AMERICA

Published Weekly, at \$1.00 per annum.

Sample Copy sent on Application.

36th Year.

CHICAGO, ILL., NOVEMBER 5, 1896.

No. 45.

CONVENTION PROCEEDINGS

THE REPORT IN FULL

OF THE
Twenty-Seventh Annual Convention
OF THE

North American Bee-Keepers' Association,

HELD AT

LINCOLN, NEBR., October 7 and 8, 1896.

BY DR. A. B. MASON, SECRETARY.

[Continued from page 693.]

WEDNESDAY AFTERNOON SESSION—CONTINUED.

After recess there was a discussion on the subject of

Honey Production and Plants.

Mr. DeLong was asked how many colonies he has.

Mr. DeLong—I have 20 colonies now. I took 450 pounds of honey from each of two colonies this year. I had a number from which I took 300 or 350 pounds each.

Ques.—When did the honey-flow commence?

Mr. DeLong—July 25. I live in Nuckolls county, Nebr., between Edgar and Nelson. Let me say that I got 8 cents a pound for most of this honey.

A discussion arose as to which is the best honey-producing plant—the alfalfa or the white clover. The majority agreed upon white clover.

R. C. Alkin, Loveland, Colo.—When I lived in eastern Iowa we produced heart's-ease honey. In going from there to Colorado I met a man who had heart's-ease honey. I recognized the old honey we produced in Page county, Iowa. This man gave me a couple of sections, and when I took it and let it run into the alfalfa honey it became very dark. Alfalfa honey is white. Now, if I remember correctly, Mr. Wallenmeyer, of Indiana, mixes heart's-ease and alfalfa honey together, and then sells it. Heart's-ease honey is lighter-colored in Iowa than in Kansas.

The Secretary said alfalfa honey is the lightest colored honey there is, and others said the same.

Mr. DeLong—My experience has been that we always get more honey when we have plenty of rain than during a dry season.

Mr. Stewart—One fall, I think in 1891, I took an average of 80 pounds of comb honey per colony of white clover honey, and it was the best in the market.

Mr. DeLong—I claim that some of my hives have a bushel of bees.

Mr. Lang.—I had the pleasure yesterday of calling upon

Mr. Davidson, at Omaha, and while there he said that his average one year with another was 50 pounds per colony. He claimed that Nebraska was not as good as some other States in the production of honey. I came from Ontario. I have a cousin who has bees, and he took 400 pounds from a single colony. My average has been 100 pounds per colony—seventy-five pounds of extracted honey per colony. My cousin started with 40 colonies, and he took 6,000 pounds of honey from them.

Mr. Stilson—I asked one of our bee-keepers in this State what his average had been for 10 years past, and he said 125 pounds per colony. I don't know what increase he had, but I know that he usually intends to a little more than double. Bees sell for \$10 a colony here. I could sell every colony I have at that price. I can make more money from one colony of bees than I can from my best dairy cow.

L. M. Brown, Glen Ellen, Iowa—We have two kinds of



Hon. Eugene Secor, Forest City, Iowa.—See poem on page 707.

smartweed—one grows in marshy places, and it yields red honey, while the other kind usually grows in cornfields, and gives dark honey. We have another variety which yields a great deal of honey.

Mr. Whitcomb—In regard to heart's-ease honey, the color depends entirely upon the time of the year that the honey is produced. Heart's-ease is like every other flower, the earlier the honey is gathered the lighter the color, and the later, the darker the color. Heart's-ease honey taken 15 days apart

differs exceedingly in color. Heart's-ease honey is lighter here than in any other part of the State.

F. C. LaFever, Junieta, Nebr.—In regard to the color of heart's-ease honey, I do not agree with Mr. Whitcomb. I believe early in the season it has a dark color, and later a light color.

A Member—I had 38 colonies and took 2,280 pounds of honey, or an average of 60 pounds per colony. From 10 colonies I took 1,050 filled sections, and from 3 colonies 360.

J. C. Knoll, Kearney, Nebr.—I consider this year a failure in honey-production for me. I had 16 colonies, and so far I have only taken 100 pounds of extracted honey. I live 6 miles north of Kearney. One man, to whom I sold a colony, got 240 pounds from the single colony this year.

Mr. Aikin—I had almost a failure. There has been bloom all over, and it has been a good year, but I have taken very little honey. I live north of Denver, in Colorado. In 1889 my average from 165 colonies was 150 pounds; the next year from the same number of colonies, 100 pounds average; the next year about 25 pounds; the next year about the same; the next year about 50 or 60; the next year 10 pounds, and this year almost nothing. In Iowa I have taken 227 pounds per colony from 11 colonies. A man can get double the amount of extracted honey from a colony that he can of comb honey. I can make more money by producing extracted than by producing comb honey.

Mr. Whitcomb—In the western part of this State there is no sweet clover, and I hope they will not stop us sowing it, for it makes fine honey. When bees can get both alfalfa and sweet clover, it has been my experience that they generally select the sweet clover.

C. L. Luce, Republican City, Nebr.—Four years ago I started in with two colonies, and the first year I had no increase, but took 75 pounds of comb honey per colony. The next year I had no increase, and took 96 pounds of comb honey per colony. In 1895, I increased to 9 colonies, and got one swarm from one of my neighbors, and I averaged 60 pounds of comb honey. This year I had 14 colonies, and I bought one, and I now have 33. I attribute the honey to alfalfa. I have 40 acres of alfalfa, and I find it alive with bees.

Mr. Masters—I have not seen a bee on my alfalfa for two years. I would not give one acre of sweet clover for ten of alfalfa. In western Nebraska alfalfa is better.

Mr. Abbott—We have the best things in Missouri on earth, but at Garden City, Kans., they get honey every year from alfalfa.

Dr. Miller—My average of comb honey this year has been about 600 pounds per each 10 colonies.

Dr. Mason—I have a colony of bees in the barn, and I have taken an average—according to Dr. Miller's way of reckoning—of 1,120 pounds of honey from 10 colonies.

Mr. Aikin—I came from Loveland, Colo., through Pueblo and through Kansas to get here, and I consider alfalfa to be an excellent and reliable honey-plant. In the irrigated country where I live, we are less liable to have a failure than where they have a small amount of rain. In Iowa, since I have been there, they had only about one complete failure in 15 years. At Greeley, Colo., they had a complete failure this year, and nearly so at Loveland. North of Loveland they have done better. At Denver, just before the honey-flow, the bees vanished, and no one could tell where they went. One man said he had 225 colonies, and could only find 25 colonies afterward. Mr. W. L. Porter, a bee-keeper near Denver, said that after the bees had gone he did not have enough bees left to cover his hand.

A Member—What time of the year was that?

Mr. Aikin—The last days of May. This territory from which the bees went was about 20 miles in diameter.

Mr. Whitcomb—The bee-keepers have been invited to take an excursion through the city to-morrow at 11 a. m. I move that we accept the invitation. Carried. The convention then adjourned until 7:30 p. m.

WEDNESDAY EVENING SESSION.

The meeting was called to order at 8 o'clock by Pres. Root, who stated that as the speakers had not yet arrived, an opportunity was offered for any questions or discussions that the members would like to make.

A Member—Suppose we have a song by Dr. Miller.

Comb Honey vs. Extracted.

Dr. Miller—Instead of a song, I would like to make a few remarks on the subject of comb-honey production. I am in favor of producing comb honey because I think I can get more out of it; but I am glad that there are those who do not agree

with me. Others favor extracted honey because they get better results from it. For example, if it were down South, I believe the production of extracted honey would be better. Although I am a producer of comb honey, I very much prefer extracted honey for my own table use, as we do not have the wax in it. My experience with extracted honey has not been very great. I had some Punie bees which we allowed to build up four stories high. They worked splendidly, and everything indicated a fine return, but when we came to extract the honey it took so much time that I concluded we could produce comb honey, sell it, and buy extracted honey at a profit.

Pres. Root—What was the yield from your Punies? How many pounds to the colony?

Dr. Miller—We got 175 to 180 pounds to the colony. I suspect that if some of you who are used to extracting honey, should attempt to produce comb honey, you would not have better success than I did with extracted honey.

At this point Pres. Root introduced Hon. R. E. Moore, Lieutenant-Governor of Nebraska, who spoke as follows:

Address of Welcome by Lieut.-Gov. Moore.

Mr. President, Ladies and Gentlemen of the North American Bee-Keepers' Association:—

In the absence of the Governor, I bid you a most cordial welcome in behalf of the State of Nebraska and the city of Lincoln. This meeting of your Association is an indication that our people—some of them at least—have an intelligence for something besides politics. Our Governor is necessarily absent this evening. He is out looking after his political fences—making hay while the sun shines—like a good agriculturist; saving the country, and incidentally saving himself. Although not of the same political party, I can say of Gov. Holcomb, that I believe he has given satisfaction to his friends and disappointed his enemies during his administration as Governor of this State; and that he has been regarded as a straightforward and honorable gentleman. [Applause.]

I take pleasure in seeing this Association, because it proves that we can give attention to something besides politics. Politics is a good thing, and must be looked after, but I think there is too much attention given to it. In the summer and fall we have nominations and elections; then in the winter comes the legislature, and in the summer elections again. And then the politicians make such promises to the people that they think wealth and employment can be made for them by law, instead of by exertion on the part of labor. And they long and wait for the time when their political party will be in power, and plenty and prosperity will be seen where now is want and distress. It would be a good thing to impress on the minds of our people that something is necessary besides law. Patient and intelligent effort on the part of the individual is the only sure way to happiness. While law may have something to do with prosperity, it is by no means all that is required.

Your Association has set to work in a field that cannot be regarded as the most wealth-producing; but it is a benefit both to yourselves and to the people. The force of the example will be great to the American people. We have two million people now idle. We are passing through a period of commercial depression and great distress. These people are looking to legislation alone to afford them labor. But I believe that work would be offered to the people if they would exert themselves to find something to do—some field of employment that has not as yet been attempted by others. We import several million of dollars worth of goods every year. I believe that many of these articles we import might be produced here with profit both for the producers and for the people. The money that is sent abroad might enrich our own nation instead of foreign countries. And if the unemployed people should seek some overlooked—some hitherto neglected—field of employment, they might be occupied.

While in Utica, N. Y., some years ago, I observed five or six thousand laborers engaged in making ready-made clothing. That industry could be carried on here in the West as well as in New York. In Lyons, France, I was also impressed by the industry of silk manufacture. These factories were not very extensive; each one employed not a great number of men, but, in the aggregate, many millions of people obtain employment from this industry. It brought wealth to them, to their city, and to their nation.

We imported \$100,000,000 worth of sugar last year, and paid for it with gold. Yet we have land, the climate, the labor—all that is necessary to produce this wealth. We could have retained that money at home, and made peace and plenty in many homes that are now in want and despair. I speak of these things to show that you have engaged in something that is beneficial to you and to the world, and you are doing much

more good than the people who sit on the street corners and talk politics while their wives are waiting at home for the box of bluing which they sent them for. [Laughter.]

I trust that your meeting will be profitable and enjoyable to you; and I extend to you once again a most cordial welcome to this State. R. E. MOORE.

Pres. Root—I now take pleasure in introducing to you Chancellor George E. MacLean, of this University.

Chancellor MacLean's Address of Welcome.

Mr. President, Ladies and Gentlemen of the North American Bee-Keepers' Association:—

It is strange that so orthodox a body as this should reverse the standard chorus of the standard hymn, and have us no longer sing "More to follow," Moore have having preceded me. But it seems to be sometimes the case that the less is as important as the "Moore." We see an example in the little bee which is so big when considered in the light of what it does.

I come for the purpose of bidding welcome to the North American Bee-Keepers' Association. In my early days, in my grandfather's garden in Connecticut, I became acquainted with bees. At that time the bees saw fit to consecrate me for this occasion. A bee stung me on the tongue. And hence you shall have a "honeyed tongue" to-night. I come, then, not to flatter, but simply with that tongue which the bee enlarged for me. And so with that honeyed tongue I come to say "Welcome," in behalf of the University of Nebraska. Welcome to the "bee-hive" of the State of Nebraska. Where the Governor comes from, they have electric cars which have on them this motto: "CAPITAL—TO THE PENITENTIARY." There is no line from this place to the Penitentiary; the University is the bee-hive of the State. We have here, when there is idleness elsewhere, industry and life. A "swarm" is almost constantly in the great "hive." We have more students than we can comfortably get into our lecture rooms; 1,537 students in this University last year.

People talk of hard times; but our students are here to give proof that the hard times are possibly a blessing. These times show that the parents and the children of Nebraska have opinions that look higher even than dollars. And the people of the State show what they are made of in sacrificing as they do to have the boys and girls here. Here, like busy bees, they not only gather honey, but carry honey home to the hive.

In welcoming you, then, in behalf of the University, the bee-hive swarming with that which is most precious in the State—youth—I welcome you, as you see, to that which is full of sweetness even in these times of bitterness; that which is full of promise for the future. In giving you this welcome, I wish—following one line which the Lieutenant Governor opened up—to emphasize the importance and the diversity of the various forms of our agricultural pursuits. When I was in Europe, I discovered that interests in bee-keeping prevailed. In looking at these, I wondered how great might be the interest in bee-keeping in the United States. I was surprised to find that there was an interest of nearly twenty million dollars in the products of the bee; that there was about seven million dollars worth of honey and wax yielded every year. I discovered that there are 300,000 people engaged in bee-keeping work. I was especially delighted to learn of the intelligence attending upon this occupation. There are 114 societies and 8 journals especially devoted to bee-keeping. And I rejoice that there is one of these journals in the State of Nebraska. When these statistics are set before us, we see the need of fostering this society.

I perceived that it came upon you to advance the hygienic condition of our people, by seeing to it that this honey, so excellent as food, should be furnished to the people more pure—that our honey should be unadulterated. [Applause.] Then, looking forward, as the estimates have been made by authorities on the subject, I discovered that you could increase this industry, with things as they now are in the United States, ten times—and still find support for your bees. The flora is here to support ten times the colonies of bees that are flying over our forests and fields. And thus your industry is that industry that is called "blessed." It is well that many, others as well as members of your industry, have called the bee "the blessed bee." It is this insect that teaches us how we may increase the yield of our fruits and grain, and so the bee carries manifold blessings to the vegetable environment in which she lives. How important then is your convention! We should all receive an impulse from it. This University, not represented here to-night as I would like to see it, because of the many duties upon our students, shall receive, if our professors have their will, an impulse from your work. You lay the

sciences under tribute. As they are applied, we learn more and more of the great industries; how to test the products; how to make the bee a blessing as Nature intended it to be.

In the welcome that I give, I am delighted that we welcome some "queens" among the bee-keepers. Now England is very proud of the fact that she has one queen. But I perceive that you advertise that you mail 20,000 queens a year through the mails of the United States. Over there we read of the one queen's mail—of Her Majesty's mail. But I am thankful that here you have not only bee-queens, but that every American woman is a queen engaged in the work with you; who will see to it that this heretofore overlooked industry shall be made what it should be. For man alone can never carry on any great industry without the help of woman side by side with him in the work.

I welcome you, as you know, to a University in which the women have proved their scholarship equal to that of the men, though there are as yet but one-third as many women as men in this University.

By way of proving the sincerity of the welcome, to-morrow you are invited to set an hour, at your convenience, when you will make an excursion through this "bee-hive," and see our "bees" at work. If you find one that is not at work, you may put him or her out of the hive. Also please remember that the University has a great University farm consisting of 320 acres. There, though we cannot show you much in the way of bee-keeping, we can show you that renewed life has been given to agricultural interests.

Welcome, then, and come again as soon as you can. [Applause.] GEORGE E. MACLEAN.

Pres. Root then announced a song by a Lincoln quartet, composed of Messrs. Cameron, Evans, Congdon and Lansing. The song rendered was entitled "Bee-Keepers' Reunion Song." At the close of the song, the President announced that Mr. Secor, the author of the words of the song that had just been sung, was present, and would respond to the addresses of welcome.

Response to the Addresses of Welcome.

We're glad to be invited to the "wild and woolly West,"
Where the cowboys run the country with neither coat nor vest—
(According to the silly claim of many Eastern folk
Who never seem to comprehend a breezy Western joke).
But some of us have "traveled"—in fact, been here before;
Have felt the grip of Western hand extended at the door;
We don't expect that Indian raids are every-day affairs,
Or that the hungry prairie wolf will snap us unawares;
And neither do we look for men in this new prairie State,
Who lack in kindness or in worth because 'twas peopled late.
We know that all of virtue and of hospitable cheer
Are not confined to older States, they've taken root out here.
The hearts of these, our brethren, we should expect to find
Responsive as their generous soil—the richest of its kind.

Boast not, ye Yankee truck-raisers—pent up between the hills—
Of the greenness of your verdure, or the music of your rills.
Here broad and fertile acres wait for millions yet to be—
Wait but the march of Empire West—the bivouac of the free.
These prairies, like an ocean vast in billowy grandeur roll—
A blessing in each valley, and a promise on each knoll.
There's food enough in this rich soil, stored up long, long ago,
For ten times ten the present needs of population's flow.

So if the hive of industry be over-crowded East,
There's room for several swarms out here ("priority rights" released).
But from an economic view my mental kodac shows,
No drones need be imported here—the *worker* is what "goes."
This climate is a little "hard" (so I have been informed)
On idlers, and, if such migrate, they'll wish they'd never
"swarmed."

I said that none but *workers* are in demand out here;
Perhaps you bee-men present may think it somewhat queer
That *queens* are not a vital part of such a colony.
They are, my friends, important, but, don't you clearly see
Nebraska queens are just as good—and acclimated, too—
As any foreign race or blood, albeit old or new?
So if you've not contracted, and you chance to find one here,
She's warranted, I'll venture, to be without a peer.
'Tis Eastern blood and Western vim that make the world go round;
In other words, they make things "hum"—to us a cheerful sound.

The greeting which your speakers give is prized by us bee-men;
We take most kindly to sweet things—perhaps we'll come again;
We'll not, I hope, inflict a sting for kindness you have shown—
Such honeyed words, such royal cheer, demand our love alone.

We represent a brotherhood whose craft, for ages past,
Has been esteemed a worthy one, because their lot is cast
With those who in the field of toil create the world's great wealth,
And at the same time lessen not its pleasures or its health.
The sweets of life we gather in; we garner Nature's waste;
We horde the nectar from the flowers to cater to man's taste;
We fructify, with busy elves, the orchard and the field;
The spoils we get is but the fee for making blossoms yield.
Without our winged wizard-priests that marry distant flowers,
This earth might be a desert waste where now are fruitful bowers.
Bespeak we, then, for these our aids, and keepers, too, as well,
The word of praise that worth demands—that worth their works
do tell.

I notice that *you* have a bee, quite common everywhere—
At least in Uncle Sam's domains she is by no means rare;
And like the "busy bee" of song she buzzeth night and day
(In bonnets mostly worn by men) in a most bewitching way.
The "Presidential Bee" is here, as vanguard of our host,
With *silver* bands instead of gold—the marks bee-men prize most.
In this campaign 'twixt yellow and white, *we* look with longing eye
For some bright ray—some star of hope—from out the murky sky.

For whether gold or silver wins, *we* want *prosperity*,
We need the *factory's* busy hum to stimulate the bee;
For people eat best when they work, and bees increase and thrive
When some one buys the royal food found only in the hive.

The city where now congregate the chosen of our clan,
Was named for one immortal in the heart of every man.
Immortal may the friendships be which on this spot we form,
That, like the granite hills of God, shall stand both time and storm.
And may the bond of union, between the West and East,
Grow stronger as the years go by, and each returning feast.
Fair city of this Western plain, the salted seas between—
Gem of mid-continent beauty, of prairie cities queen—
We bid thee prosper and grow strong, and, like thy giant name
Whose hallowed sound is Freedom's boast, be ever known to fame.

EUGENE SECOR.

Another song was sung, entitled, "Dot Happy Bee-Man;"
Dr. Miller, the composer of the music, singing the solo part,
and the Lincoln quartet joining in the chorus.

Dr. Miller being called on for another solo, responded by
singing "The rock that is higher than I."

Pres. Root—Gov. Saunders, who was to address the Association could not be present. We will now have an address
by Rev. E. T. Abbott, of St. Joseph, Mo.

Mr. Abbott's Address.

Mr. President, Ladies and Gentlemen:—

Your chairman has put a "handle" to my name that would indicate that speaking was my profession. It is not so at present, nor has it been for 15 years. I simply appear before you as an ordinary, every-day man—a common-place bee-keeper. If there were more students here, I had thought of some things that I might say. But notwithstanding there is only a small representation of young people, perhaps what I shall say to them will not be out of place to older people. It is hard to tell what to say and what not to say under such circumstances. And when we have had such a flow of eloquence, and poetry, and music, and been carried so high above the ordinary things of life, it is very hard to come down to everyday, practical affairs. And after we have been up among the stars, it is very hard for us again to place our feet on the soil, and plod along in the mud and rain, the joys and mishaps and sorrows of life. But this is the lot of all of us; we sometimes see visions and dream dreams, and look beyond the practical realities of life, but the most of life is made up of every-day affairs. Life is serious, earnest, practical. It means work, it means constant exertion, it means continual effort, if we would get the best out of it.

In a great University like this, where young men and women come to fill their minds with the practical wisdom of the ages, and sometimes to investigate new things, and give to the world new wisdom, there is one danger. These young men and women come mostly from the farms, and I apprehend that at least 90 per cent. of them are very apt to get the idea that the attaining to success happens only in the professions

or in commerce; that, in order to succeed in life, to make their mark and take their place among men of influence, they must lose their respect for rural surroundings; that they must get beyond their fathers and mothers, and launch out into new enterprises. If the country at large is making any serious mistake, it is the tendency away from the farm, away from rural surroundings; the tendency to concentrate itself in cities. In these great avenues, it is true, men succeed and commerce goes on, but, at the same time, vice stalks abroad at noonday, and the unwary finds his feet slipping in the downward path, and he has gone the way of despair and lost hope, and his life is blighted.

What I would do, if possible, is to impress upon the mind of these young people that it is well to get an education; to learn all you can; to grasp every science, know every language, learn everything that is spread out before you in this University. And while you are learning all that, it is well to learn the character of the lives of these men who teach you day by day. You can learn something in the study of their lives, as well as from the books that you study.

Yet at the same time I would advise you to keep near to rural scenes. Don't forget the "old oaken bucket," the orchard, the meadow; don't forget the home where mother uttered her last "God bless you," where she said, "Go, my boy, and prepare yourself for life." Don't forget that sacred home, the glorious spot where your eyes first saw the light of day, and your feet first learned to tread the pathway of life. Don't forget the rural scenes. Don't get the idea that all the glory, all the wealth, all the fame and success of life is within the walls of a city. A citizen of your place said well upon one occasion—and I am saying nothing about the political principles which he advocates—he said well, "You may destroy your cities, and agriculture will raise prouder cities; but take away agriculture, and grass will grow in the streets of every city in this land." And that is true; all the wealth rests upon agriculture. All the success of this world is dependent upon the success of the plain, plodding, practical farmer that tills the soil day by day. [Applause.]

Because of the fact that a man is a farmer, it does not follow that he should be ignorant and uneducated. The theory is that any fool can farm. It is true that any fool can stay on a farm, but any fool cannot make two blades of grass grow where there is one now. There was a time when the responsibility was all on the soil. Now you must go back and learn the first principles, and come in contact with the soil in an intelligent way. The farmer should have a knowledge of chemistry; should know something of entomology—what insects are helpful and what destructive to the products of his farm. Thus a great, wide field opens to the farmer.

It is a grand thing to study the science of astronomy. But there are just as many wonders under our feet when we tread the soil of our farm, with our grass, and spiders, and bees, as there are in the air with all the constellations that glisten and sparkle in the heavens.

In conclusion, keep near to rural scenes; keep in touch with the tiller of the soil. Don't be afraid that you will soil your hands or degrade your body by coming in contact with your native soil. Stand near to the Creator of all things; stand for right, justice, truth; stand for intelligent agriculture. [Applause.]

EMERSON T. ABBOTT.

Chancellor MacLean—Mr. President, I see that you have next on your program an address to the students, by Dr. Miller. The students are not here to-night, but they will be here to-morrow at chapel time. I would suggest that Dr. Miller hold his fire until then.

Dr. Miller—I am willing, if I don't burn up in the meantime!

Chancellor MacLean—Mr. President, allow me to suggest that the Association make some provision to give us time for an excursion through the University buildings and grounds, at 2 o'clock to-morrow.

Mr. York—Mr. President, I move that the generous suggestion of the Chancellor be adopted. I suppose one hour will be sufficient.

Chancellor MacLean—Yes, sir; we are in the West; we can put you through the University in one hour.

The motion of Mr. York was carried.

Pres. Root—To accommodate those of us who must leave to-morrow afternoon, our trip through the city will be made at 11 o'clock, if there is no objection.

Chancellor MacLean—May I say that to-morrow your sessions will be held in Union Hall—a room which I think you will find more comfortable than this.

It being 9 o'clock, the convention adjourned to meet at 8:30 o'clock, Thursday morning.

(Continued on page 721.)



Surplus-Honey Room Above Brood-Chamber.

BY CHAS. DADANT & SON.

We have received the following letter, requesting a reply thereto in the American Bee Journal:

MESSRS. CHAS. DADANT & SON:—Pardon me for calling on your generosity to answer a question concerning a statement you made a short time ago in the American Bee Journal, when you said your only objection to the American style of frame (12x13 inches) was that it gave less surplus room above the brood-chamber than the other kinds. Now, what I wish to ask is, why do you want so much surface at the top of the brood-chamber? Why not have the brood-chamber and surplus apartments each in a compact form, *a la* Boardman, for the production of extracted honey?

Methinks your reason is that in order to get the same capacity your hives would be too tall, and the bees would have just so much further to carry their load of sweets before depositing it. But could not this be remedied by having an entrance in the super as well as in the brood-chamber? Or is it because you are afraid of those hives toppling over? But could not that also be remedied by having the hives of such a dimension that two stories high would be sufficient?

But, say, I am getting away from my subject. What I really want to know is, why is it better to have the brood spread out in order to give more *surplus surface*, than it is to have both in a compact form? As it seems to me, the latter would be preferable.

E. B. TYRRELL.

Davison, Mich., Oct. 6.

We think Mr. Tyrrell slightly misunderstands our position. We do not consider the American hive as making the brood more compact, for the same quantity of it has to be spread over more frames in this hive than in the Qninby, since the 12x13 frame contains only 156 square inches, while the Qninby, 11x18, contains 198 inches. The only difference is that the Qninby is flatter, or more shallow, and the brood-nest has to be slightly elongated horizontally, but the same number of bees may be reared in a less number of frames, while the regular Langstroth frame produces less bees in the same number of frames when compared to the American hive, since it contains a less number of cells. Our objection to the American hive is that in order to have the same surplus room above, we have to make a hive containing 16 frames, and this causes too much surplus to be placed in the brood-combs. For extracting, this objection is not insuperable. That is the reason why we have kept our American hives in use, of which we have had some 65 for 20 or 25 years.

The storifying of a large number of cases on a tall, narrow hive is objectionable, for the reasons mentioned by Mr. Tyrrell. It is so, at least with us, for we have tried it and do not like it.

We have also tried the entrance in the super, and object to that, for two reasons. The bees become accustomed to that entrance and are very much annoyed when it is closed up for winter; and the other reason is, that the bees do not place any honey in that part of the super which is close to that upper entrance, following in this matter that instinct which warns them against robbers. It is owing to this instinct that they always store their honey above or behind the brood-nest. The process of inverting, which caused such a craze a few years ago, took advantage of this instinct of the bees to compel them to move their stores into the supers. The brood-chamber being inverted, the bees found their honey below their brood and next to the entrance. They hastened to move it, but as the brood then occupied the top of the brood-nest, they were compelled to store the honey in the supers. This practically took from the bees all their honey.

We have tried upper entrances during very hot seasons, when it seemed impossible to give the bees sufficient ventilation from below. In every instance where the upper entrance was left for a short length of time after the end of the crop, we found a large amount of dry combs near this upper en-

trance, both above and below it. This has caused us to discard the practice altogether.

In all these arguments on hives, we do not wish to lay down any particular rule for all to follow. We simply give our experience and our explanation of the facts that we have noticed. Climatic conditions undoubtedly change the comparative condition of the bees, and what proves true with us may not turn out the same in another climate; but what we report here is the deduction taken from the facts noticed in a life experience with bees, in different styles of hives.

Hamilton, Ill.



Starting in Bee-Keeping—Various Points.

BY DR. E. GALLUP.

For a "beginner" in bee-keeping, I wish to tell my friends that I have Langstroth Revised, Root's A B C of Bee-Culture, Newman's Bees and Honey, Doolittle's Queen-Rearing, Alley's Thirty Years Among the Bees, Heddon's Success in Bee-Culture, Dr. Tinker's Bee-Keeping for Profit, and Hutchinson's Advanced Bee-Culture; and I have also read the American Bee Journal and Gleanings in Bee-Culture. So you can readily see that I was not quite so green in the business as many might suppose.

There is one man here that claims that he has beat me. He started in last spring with one colony, and now has 35. But he took his from houses and buildings. I presume that if I had the time I could have had over 100 colonies now, for there has been quite a number of people after me to take them away, and some are even willing to pay for removing them, so any one can see that it is a very easy matter to start an apiary here. Or if one wishes, he can gather up a large apiary of wild bees from caves and rocks on Catalina Island—where a certain party was going to start a queen-rearing establishment, isolated from all the rest of the world. It was a grand idea, but it never materialized. Any one starting an apiary in the Island could work up quite a home market for honey, for it is a great resort for health, pleasure seekers, fishing, etc.—probably one of the finest in the known world. At least so it is said by those who ought to know.

We have no winter problem to solve here in the valley; even a small nucleus can be wintered as readily as a large colony, and one flow of orange-blossom honey is almost, if not quite, equal to the Eastern basswood flow. I made a test last spring with my one colony, believing that the reason why so little of it was stored, was that we did not have the working force on hand at the right time. The orange trees are in bloom over two months, taking the early and late varieties into account, and the flow of nectar was so profuse that in cultivating among the trees with a team, the horses' hair and harness would be glazed over with nectar, and one could scent the smell of nectar for a long distance. So one can scent alfalfa when in bloom, and it is wonderful how the bees do hum on both the orange and alfalfa.

Well, I am off the track a trifle.

The last of January I bored a 3/4-inch hole in the cover of the hive, and fitted in a plug. Every evening I would pour in three or four table-spoonfuls of quite thin diluted sweet. The bees had plenty of honey in the hive, so it only took a little stimulating to set the queen to breeding, and by the first of March, when the oranges are in profuse bloom, I had a strong working force, but did not get the time to attend to them as I ought, as they filled six combs in the super before I was aware of it, so we had some nice, white comb honey for table use, and it satisfied me of the fact that I started in to demonstrate.

Right here I will say that for stimulating I prefer to pour the feed right on the bees. If the feed is of the right consistency, it never injures them at all. It takes but very little feed to stimulate to start breeding, and keep it up, providing we have abundance of honey in the hive for the bees to draw from. It would be poor policy to stimulate to rear a lot of bees and then allow them to starve. No danger of starving as soon as they can gather nectar from outside forage.

Bees can gather pollen here at all seasons of the year. Loquats or Japanese plums blossom in November and December, and the eucalyptus nearly all winter.

I hear of one person that has an apiary in the mountains letting his bees starve to death now; and others say their bees have stores enough, by equalizing, to last them through. Mr. Oderlin has extracted three tons, and says his bees are in good condition. His bees had access to 40 acres of Lima beans. My bees are yet gathering more than they consume. I have no extractor yet, and I find many of my colonies have restricted their queen down to pretty close quarters, after all my drawing out so many combs to build up increase; yet,

whenever I have drawn out a comb, I have replaced it with foundation. If I had not, I should have had lots of drone-comb. As it now is, I have splendid worker-comb in the breeding apartments.

By the way, I heard quite favorable reports of the Adel bees, or golden Carniolans; so I sent \$1.00 for an Adel queen to test for my own satisfaction, and the scamp of a breeder sent me two in place of one. They were introduced last Monday (Sept. 14). Some object to them because they are such prolific breeders. When I have a queen that is so prolific that her bees will fill three supers with honey while ordinary queens only fill one, it never frightens me one particle. Have had such.

Santa Ana, Calif.



Bees Puncturing Grapes—Sweet Clover, Etc.

BY PETER J. SCHATZ.

Mr. W. S. Fultz fully admits, on page 492, that something else does the puncturing of fruit when there are no bees on them. To more fully show that bees do not puncture fruit, I will give my reasons and experience.

My bees are located on what we call "Grape Hill," with a slope of about 45° facing east, containing in all two acres. These vines run north and south in rows eight feet apart. Directly back of the rows my bees are located, while in front, not three feet from the hives, hang large clusters of ripe grapes; still they are punctured, and the bees do not touch them, which goes to show that bees will not work on fruit when they have forage. Then, is it not proper for bee-keepers to provide this forage as much as possible? Would it not be to their interest, as well as to that of their neighbors? and would it not keep the bees out of mischief, and keep all in good humor, the bee-keeper as well as his bees? The old saying, "By industry we thrive," is very good in its place, but this industry must be provided for or we cannot thrive, and points as much to bees as to human beings. We must labor to make a living, but when labor is not to be gotten, then we must starve, or live from the hands of others.

Mr. Fultz asks to be told how to produce that forage in paying quantities on land that is worth \$75 per acre. Let me say that it is not the value of the land that is of any benefit to the farmer, but the condition of the soil and what it will produce. Land here is valued all the way from \$65 to \$125 per acre, depending upon location, and rents from \$3.00 to \$4.00 per acre. Now, why is it that farmers who rent this valuable land leave it a year after? Simply because it does not pay the rent. Farming is not what it is "cracked up" to be, nor is it what it used to be, still, by using good judgment, farming can be made to pay.

Mr. F. asks what it is that we must plant that will produce honey, and pay us for our time and labor, and the use of our land? Simply this very small, innocent-looking plant—*sweet clover*, which blooms here in June, and continues to bloom until frost kills it. The honey is of the best quality that can be produced, and of very fine flavor. Sweet clover is one of the best honey-plants we have, and will stand any amount of cold or heat, will grow on any soil, either sand, clay, or gravel—except on a solid rock; it also grows in swamps, or any place where it can catch root; drouth does not affect it, and I find that the drier the season the more honey it produces. Mr. F. does not need to sow it on his valuable land (for it needs no cultivation whatever), but sow it along the roadsides and waste places. If he lives close to the road, I would advise him to sow the seed for a distance of two or three miles each way, which will give considerable forage for his bees.

Again, Mr. Fultz says that the dairy proved to be more profitable than the apiary, etc. The dairy must be provided for, or it would not be profitable. Suppose the dairyman did not feed his cattle, or have pasture provided for them, how long would he remain in the business? The dairy is a very particular piece of business, for the dairyman has to provide the best of care and the best of feed, because all the milk that is shipped to the creamery is tested, and must come up to the standard, for if it does not it is discarded, or he receives much less for his milk. Then why should we not provide the best of forage, as much as we can, for our bees? Bees are a paying institution if rightly managed, but the slipshod manner of keeping bees will never be profitable.

Mr. Fultz may say that I am "blowing pretty hard;" may be I am, but then I know a good thing when I see it, and I am going to keep right on tooting it for every bee-keeper's good.

Lemont, Ill.



See "Bee-Keeper's Guide" offer on page 717.

PERSONAL MENTION.

MR. JOS. H. BOLTON, of St. Paul, Minn., is the late B. Taylor's successor in the "Apiary Department" of the Farm, Stock and Home. Mr. Bolton has the honor of following a successful bee-keeper—one of the few apiarian leaders of the present decade.

MR. A. W. DARBY, of Vermont, writes these appreciated words concerning the Bee Journal:

"Every bee-keeper should take the American Bee Journal, if he owns one colony or 100. I often find a single article in it that is worth more to me than a year's subscription to the Bee Journal."

MR. G. M. DOOLITTLE, although a very busy bee-man, finds time to write articles on political reform quite frequently. He is a great student on the subjects of finance, temperance, and other public questions of the day. Like all his bee-writings, Mr. Doolittle's productions in other lines are fraught with the same clearness and sincerity of expression.

EDITOR MERRILL, of the American Bee-Keeper, does not think it out of place for publishers of bee-papers to air their political views in their own papers. He is right so far as his particular paper is concerned, for at least half of its monthly contents are on subjects entirely foreign to bee-culture. Might as well be politics as love-stories, true enough, Mr. Merrill.

MISS MATHILDA CANDLER, of Wisconsin, is again in Chicago, prosecuting her studies in the Art Institute. Miss Candler has 58 colonies of bees now in winter quarters, having averaged about 50 pounds of comb honey per colony the past season. She increased from 54 to 90 colonies, and then doubled back again to 58. Miss C. is so fortunate as to have a fairly good crop nearly every year—and some years a big crop. She deserves all her success.

MR. THOMAS G. NEWMAN has been specially invited to be present and address the next annual meeting of the California State Bee-keepers' Association, which will be held in Los Angeles, on Tuesday and Wednesday, January 12 and 13, 1897. The bee-keepers of that State will then have a good opportunity to make Mr. Newman's acquaintance. As the honey-crop in Southern California for this season has been an entire failure, the bee-keepers are all the more hopeful for a large crop next season. We trust they may have a splendid convention in January.

MR. BYRON WALKER—the tall honey-producer of Michigan—again harvested about 30,000 pounds of extracted honey this year, principally from basswood and willow-herb. So reports Gleanings for Oct. 15. Since learning the foregoing, we have heard that Mr. Walker is now selling honey in large cities, having disposed of 10,000 pounds in Toledo quite recently. He generally spends the winters in Chicago, where last winter he placed upwards of 50,000 pounds of mostly extracted honey. Mr. Walker is a whole "honey exchange" himself, on a small scale. He knows *how* to do it. Nothing succeeds like success—so it is said.

A New Binder for holding a year's numbers of the American Bee Journal, we propose to mail, postpaid, to every subscriber who sends us 20 cents. It is called "The Wood Binder," is patented, and is an entirely new and very simple arrangement. Full printed directions accompany each Binder. Every reader should get it, and preserve the copies of the Bee Journal as fast as they are received. They are invaluable for reference, and at the low price of the Binder you can afford to get it yearly.

BIOGRAPHICAL

WILLIAM RAPP HOWARD, M. D.

The subject of this sketch was born Sept. 13, 1848, in Fulton county, Ark. The town of Mountain Home, with its beautiful cottages, occupies the ground where his father settled in the forest in 1847. His family moved to Ozark county, Mo., when he was 4 years of age, and opened a farm in the forest in the fertile bottoms of the "north fork" of White river, where they lived till the beginning of the War, when they moved to Marshfield, Webster county, Mo., nearly a hundred miles north of the old home.

At the close of the War his father, a physician, was left with his profession and a large family, of which William was the oldest. A farm was secured, and the boys worked on the farm and attended school in the winter. In the autumn of 1866, when he was 18 years of age, he was examined by the county superintendent of public schools of Webster county, and obtained a first grade teacher's certificate. By teaching

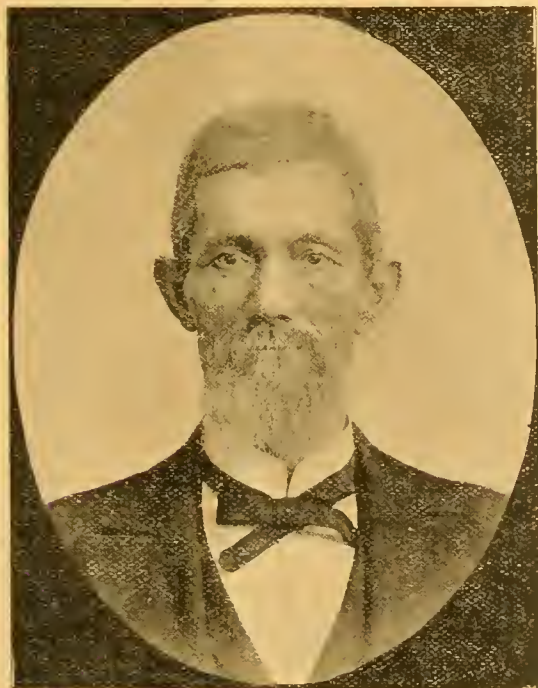

Dr. Wm. R. Howard, Ft. Worth, Tex.

and using the means in attending the schools and colleges of the country, he advanced to the head of his classes, and graduated with honors in 1870, with the degree of B. A. About this time, the family having moved to Taney county—one of the southwestern border counties of the State—he made his permanent home with them, and was elected by a majority over two other candidates, in 1871, as county superintendent of public schools. During his term of his office he organized the county into school districts, the first attempt at such an undertaking after the close of the War. He secured good teachers, and placed the county on a good educational system.

In 1873 he graduated in medicine at the St. Louis Medical College, and returned to the family home, and with his father did a large country practice. During the years 1870-73, he devoted his spare time to the study of botany and entomology—two branches in which he was much interested. He made a great deal of original investigation in entomology. He was a close personal friend of the late Prof. Chas. V. Riley, then State Entomologist of Missouri, in whose State reports

due credit is given for the assistance Dr. Howard rendered. He was a member of the Entomological Society of Ontario, honorary member to the Boston Society of Natural History, and quite a number of scientific societies.

□ In 1875 Dr. Howard went to Texas on a prospecting tour, and made the entire round trip of over 1,000 miles on horseback, writing a history of his trip for the literary journals.

In 1876 he moved his family, consisting of wife and 2-year-old son, to Texas. He settled in Hunt county, near where the town of Kingston was established five years later, when the railroad came. Here he practiced his profession for 10 years on horseback, never, perhaps, a day without being on his horse.

In the early part of 1877, Dr. H. became acquainted with W. R. Graham, and in the summer of that year these two gentlemen concluded to issue a call for a State organization of the bee-keepers, and with the late and lamented Judge Andrews at the head of the list, the Texas State Bee-Keepers' Association was formed. The Judge was its first president, and the Doctor was the first secretary. W. R. Graham, of Greenville; Rev. W. K. Marshall, of Marshall; George Wilson, of McKinney; and Rev. I. H. Hightower, of Kingston, were prominent among the charter members. This is now the oldest society pertaining to any branch of agriculture in the State, and has never failed to have an enthusiastic annual meeting.

During the years 1878 to 1883, the Doctor devoted as much of his time as his professional duties would permit to bee-keeping and the supply business, his being the first supply factory ever started in the State. During this time he entered largely into the discussions of the day through the journals, and made many original investigations. His paper on the "Honey-Plants of Northern Texas"—in which the technical name of the plant, its time of flowering, whether sought for honey or pollen, or both, how long in bloom, character and quality of honey produced, market value, etc., were given at full length—was of great value to Texas bee-keepers, enabling apiaries to be established in places where none heretofore existed, relying upon the pasturage for the location. His paper on "The Parthenogenesis of the Honey-Bee," being the most enthusiastic paper on the subject ever written, attracted much attention, and brought out much discussion. Many other able papers were contributed from his pen.

In 1884 the Doctor's professional duties demanding all his time, he sold out everything pertaining to the bee-business, and in the early part of 1886 moved to Fort Worth, Tex.

□ In 1894 he published his little work on "Foul Brood," which gained for him an international reputation. Later, his "White Fungus Disease" has solved a very puzzling problem. This latter appeared in the American Bee Journal for Sept. 10, 1896.

The Doctor's active interest taken in scientific agricultural affairs has won for him friendship wherever his name is known. Besides being a member of the Texas State Bee-Keepers' Association, he is a member of the State Horticultural Society. Of the societies devoted to other branches of science, of which he is a member, here are a few: Member of the North Texas Medical Association. Fellow of the Texas Academy of Science. Professor of History, Pathology and Bacteriology in the Medical Department of Fort Worth University. Secretary and Curator of the Pathological Museum.

"Dr. Howard's Biological Laboratory," in which all his work is done, is a private enterprise of his own, and not connected with the medical school.

In the medical world the Doctor stands at the head of his profession. His ability as a pathologist has won the confidence of the physicians of the country, and his laboratory and microscopical work is much in demand where a diagnosis dependent upon these methods is necessary. The Doctor has made much original research in this line, and suffering humanity has been the beneficiary. He reports through medical journals the results of his works, though he does not write much now, on any branch of science, his other duties employing his time.

His father and mother still live at their old home in Taney county, Missouri.

A FRIEND.

Honey as Food and Medicine.—A new and revised edition of this 32-page pamphlet is now issued. It has 5 blank pages on which to write or paste recipes taken from other sources. It is just what its name indicates, and should be liberally distributed among the people everywhere to create a demand for honey. It contains a number of recipes on the use of honey as food and as medicine, besides much other interesting and valuable information. Prices, postpaid, are: Single copy, 5 cts.; 25 copies 65 cts.; 50 for \$1.00; 100 for \$1.50. Better give them a trial. Send all orders to the Bee Journal office.

OLDEST BEE PAPER IN AMERICA

THE AMERICAN BEE JOURNAL

ESTABLISHED IN 1861

GEORGE W. YORK, Editor.

PUBLISHED WEEKLY BY

GEORGE W. YORK & COMPANY,

118 Michigan St., CHICAGO, ILL.

\$1.00 a Year—Sample Copy Sent Free.

[Entered at the Post-Office at Chicago as Second-Class Mail-Matter.]

Vol. XXXVI. CHICAGO, ILL., NOV. 5, 1896. No. 45.

EDITORIAL COMMENTS.

Apis Dorsata is not held in very high favor with most of those who answer questions for the Bee Journal, as will be seen by referring to page 715 of this issue. Neither did the Lincoln convention endorse their importation, as will be seen by the report later on. If our Government wishes to spend any money in the interest of bee-keepers, let it make a liberal grant to the "United States Bee-Keepers' Union," as it was decided at Lincoln to call our national bee-association after this year. That would likely prove a better investment for all, than to attempt to get any new race of bees.

Sawdust and Shavings in Honey.—All the careless people it seems are not found outside the ranks of bee-keepers, as will be seen by reading the following from a Chicago honey-dealing firm:

"Mr. York:—Occasionally we get extracted honey in new packages, that are not washed out before filling with honey, but used just as they come from the cooper-shop. These often contain sawdust and shavings. We have such a lot on hand now, the honey being mixed with sawdust and shavings."

Those using kegs or barrels for holding honey, should see to it that their coopers use a little more care when making their large honey-packages. And then, bee-keepers should always be sure that the kegs or barrels are thoroughly clean before putting in the honey. We are glad the above complaint has been sent in, for it oughtn't to require more than a reminder to prevent a recurrence of the trouble. Above all things, pure extracted honey should be kept entirely free from any foreign substances.

Lincoln Convention Comments.—Besides several samples of both comb and extracted honey on exhibition at the convention, Mrs. E. Whitcomb showed a beautiful piece composed of a cross, and wreath of flowers overhanging it, made entirely out of beeswax. It was greatly admired by all. Mrs. Whitcomb is an expert in this line. She also exhibited her womanly thoughtfulness in presenting the convention with a fine bouquet of cut flowers, whose fragrance continued a constant delight during the two days' meetlog.

Miss Stilson, daughter of Mr. L. D. Stilson, had neatly pressed and mounted on cards over 200 varieties of honey-yielding flowers hanging on a line stretched across the rear of the platform in the chapel of the University. We think it was the finest show of honey-plants we ever saw, and much credit is due Miss Stilson for the great efforts she must have put forth to secure such a beautiful botanical display in the interest of bee-culture.

Mrs. J. N. Heater is perhaps the most prominent lady

bee-keeper in Nebraska; at least she is the only lady supply dealer we know in that State, or any other State, we believe. Her bee-business has been somewhat profitable, too, we understand. Her paper, read before the convention, was listened to with marked attention. It is a real pleasure to meet both Mrs. Heater and her husband. We met them the first time at the World's Fair convention, in 1893.

What a big man "Uncle" Whitcomb is—in more ways than up and down, but in that way he is six feet and one inch! At the time of the convention he was running for the office of State senator. By the time he reads this number of the Bee Journal he will know his fate. But if he doesn't win the political office, he can find some satisfaction in having been unanimously elected Vice-President of the Association. He's sure of one office, any way. But if he was elected State senator this week, we shall look for some legislation in the interest of bee-keeping and honest honey-production in Nebraska very shortly. If Whitcomb can't "bring it to pass" we don't know who can. We hope he'll have the chance.

Prof. Chas. E. Bessey is a man whom all seemed to be proud of. And after making his acquaintance we no longer wondered about it. He's "pure gold"—(though for ought we know he may have a leaning toward "silver"). At any rate, it was a treat to listen to his lecture on "A Botanist Among the Bees." But it had one serious fault—it was altogether too short! In that respect it was similar to Prof. Bruner's lecture given the previous day. It is a rich University that has such material as Professors Bessey and Bruner—two splendid B's—in its faculty. Fortunate students, those, who can attend that place of learning. We doubt not they all appreciate their opportunities, for all that we saw seemed to know what they were attending the University for. Unbounded success be unto both Professors and students!

On our way home from the convention we found that we could stop off at Omaha for about six hours. We improved the time by calling on Mr. Louis R. Lighton, who is a bee-keeper in one of the suburban towns. It was Mr. Lighton who reported in shorthand the proceedings of the convention held in St. Joseph, Mo., in 1894—the full report of which he promptly turned over to Mr. Benton, as he agreed to do, but which Mr. Benton afterward failed to forward to the office of publication, as directed by the Association. Fortunately, however, Mr. Lighton kept one extra typewritten copy, which we purchased of him and brought along home. We expect soon to begin where we were compelled to stop on account of Mr. Benton's contrariness, and complete the report. To some it may be somewhat like "ancient history," perhaps, and yet to the majority we think it will be very readable.

Mr. Lighton and his brother are expert shorthand reporters, and are kept very busy almost day and night. Mr. L. was very kind to us during our short stay, and showed us quite a little of the city of Omaha. He will endeavor to be present at the convention in Buffalo, next year, and would have been at the Lincoln meeting had it not been for extra reporting that he was called upon to do at that time.

Mr. Lighton keeps 15 or 20 colonies of bees, mainly for recreation, and averaged about 120 pounds of extracted honey per colony the past season. He gets 20 cents per pound for it.

While in Omaha we remembered that some of our old schoolmates and college chums were located there. Among them we found Chas. A. Goss, now a prominent attorney; and learned that our old schoolmate and afterward esteemed teacher—Willard W. Slabaugh—is now Judge of the Circuit Court. Both were excellent students in school years ago, and are now reaping the benefits of the hard study and close application of other days.

Perhaps we have drawn out these "convention comments" sufficiently long now, so we may as well stop right

here. Of course the full report of the proceedings will be read by all as they appear from week to week in these columns. We hope to complete them this month.

A Good Cement is made of four parts of rosin, one of beeswax, and one of brickdust, melted together. It will fasten the handles of knives, forks, and similar tools which may have become loosened. So says R. V. Murray, in *Gleanings*.

The Queen's Arrival.—Mr. R. B. Ross, Jr., of Montreal, Canada, sends us the following account of the way in which a queen-bee was received in the land where there are two kinds of queens:

A loquacious telegraph operator grievously misled a crowd of loyal Britishers the other day and made them ridiculous. It seems that the son of the Marquis of Salisbury keeps bees, and being in need of a queen-bee, he sent to the nearest town for one, receiving, at Hatfield house, in reply to his message, a telegram to the effect that "the Queen will arrive by 3:40 this afternoon." The operator, supposing it to refer to her Majesty, was unable to keep such important news to himself, and an immense crowd had assembled at the station when the bee arrived. The fate of the operator is unknown, but the bee reached its destination in safety.

Apicultural Patents.—The following paragraphs are taken from the Official Gazette of the United States Patent Office issued last May:

BEE-CULTURE.—In this class 1,001 patents have been issued. The first movable-comb frame for bee-hives was patented to Laogstroth, No. 9,300, Oct. 5, 1852; and improvements thereon, disclosing simple and effective means for holding removable-comb frames in the hive were patented to Heddin, No. 327,268, Sept. 29, 1885; to Shuck, No. 329,341, Oct. 27, 1885, and to Danzenbaker, No. 547,164, Oct. 1, 1895.

The first artificial comb foundation was made in Germany about 1842. An effective improvement thereon is the employment of a wire support embedded in the foundation, and patented to Hetherington, No. 208,595, Oct. 1, 1878; reissued Nov. 11, 1879, No. 8,962. An artificial honey-comb was made prior to 1853; and on Jan. 29, 1889, No. 397,046, to Aspinwall was patented one of wood, from which the honey may be separated in a centrifugal machine; and on Aug. 30, 1892, No. 481,578, to Mason and Moskovitz was patented an improved process for making a honey-comb from wax.

It hardly seems possible that 1,001 patents have been issued relating to improvements in apicultural interests. But we presume the record is correct. When we think of the very few inventions that have proven at all useful, it will readily be seen that a good deal of hard-earned money has been wasted in fruitless efforts. It is almost safe to say that it does not pay to patent anything relating to bee-culture, so few of the 1,001 having amounted to enough to offset the cost of securing a patent.

Illinois State Convention Nov. 18 and 19.

—The Illinois State Bee-Keepers' Association will meet in Chicago on Wednesday and Thursday, Nov. 18, and 19, 1896, during the meeting of the Luther Leagues of America. Railroad rates will be one fare and a third, on the certificate plan. Every one at the time he purchases his railroad ticket must ask the agent for a certificate, which must afterward be presented at the Luther League headquarters, at the Sherman House, in Chicago, corner of Clark and Randolph streets, on the morning of Nov. 19.

Next week we will announce the hall or room where the bee-convention will be held. Let every bee-keeper who possibly can do so, arrange to be present.

That Fine Basswood Honey, mentioned on page 715, is going. If you want something nice to supply your private trade, you will do well to get some of it at once.

Questions AND Answers

CONDUCTED BY

DR. C. C. MILLER, MARENGO, ILL.

[Questions may be mailed to the Bee Journal, or to Dr. Miller direct.]

Late Drone-Rearing—Spacing Frames.

1. In the Bee Journal for July 11, 1895, in answer to the question of C. R. R., of Harden Station, N. C., you say it is very hard to get bees to rear drones in the fall. In my experience, which is very short, I will say that in July, 1896, I introduced 15 Italian queens, and they have been continually at it (drone-rearing) since, to such an extent that I had to kill them out to keep them from eating all the stores. The bees have never killed any drones; they kept rearing them until five days ago, when a cold spell stopped them. Now they are bringing out young drones in all stages of development. What is the cause of it? I have had no swarms since the introduction of the queens.

2. I am using the Hoffman self-spacing frames, outside dimensions about 9x19. I want the same size frame, but I prefer a frame that has nails in the edges to hold them apart to keep the bees from gluing. What frame do you think preferable? Where can I get them? T. J. B.

New Berne, N. C., Oct. 12.

ANSWERS.—1. Without drone-comb no drones can be reared. Without a fairly strong colony and plenty of stores coming in, few are likely to be reared. The probability is that you had in your hives more drone-comb than you should have, and with plenty of stores coming in the bees felt warranted in rearing lots of drones, continuing at this so long as nectar continued to come in freely, and then when forage became scarce, the drones were driven out. Cut out from your combs the drone-comb, replacing it with worker-comb or foundation, and you will have comparatively few drones. Just why it is I don't know, but some bees seem more inclined to rear drones than others, although any colony with an old queen is more likely to rear drones than one with a young queen.

2. I don't know of any particular make of frames such as you describe, but you can have them made to order at any hive factory. I have some now in use with end-bars $1\frac{1}{4}$ inch wide, spaced by means of common wire nails driven in until the heads project out just a quarter of an inch. Four such nails go to each frame, one at top and one at bottom on the same side at one end, and at the other end on the opposite side one at top and one at bottom. With such frames the bees make very little trouble with propolis.

Crock-and-Plate Method of Feeding.

In an issue of the American Bee Journal I read something about Ernest Root feeding bees simply by inverting a crock containing syrup over the frames. Isn't this a return to the simple, old, old method? Personally, I find it superior to any of the more complicated feeders. This is how I arrange that part of the business:

Firstly, a glazed quilt (that cheap stuff Root supplies), said quilt being $\frac{1}{4}$ inch longer and wider than the *outside* measurement of the hive, an empty super's sides resting right on the quilt, and which slightly overlaps the brood-nest, hence no bees can possibly come up into the super. Cut a hole 2 inches square in the middle of the quilt—only cut three sides, and then turn over the piece, thus partly cut out.

2ndly, over this hole place what I call a "feeding cage," and which consists of a bit of plank 5 inches or so square, and $\frac{3}{8}$ thick, in the center of which is a 3-inch hole (cut out with a key-hole saw). This hole is covered with wire gauze. Put it on, wire side up. In this cage the bees do congregate. In feeding, you look at them and they look at you, and that's the closest acquaintance you'll make during the operation.

3rdly, take another piece of $\frac{3}{8}$ -inch stuff, cut to about 4 inches square, saw a round hole in that, to take the mouth freely of a 1-pound glass honey-jar. Tack cheese-cloth (two

thicknesses) over this hole on one side of the plank (which may as well be cleated for fear of warping). That's the whole plant. At feeding-time go around with a bucket of water, with a little tin measure in it, in one hand, and a bucket of sugar, with a correspondingly sized tin measure in it in the other hand. Gently raise the hive-cover lid; take up the glass jar, put in a measure of sugar, then one of water, stand it on the quilt, and go on to the next hive. Your assistant, who follows you, picks up the jar which you filled, takes the cheese-cloth lid off the cage, claps it over the jar's mouth, inverts the whole suddenly, places it on the cage, puts on the hive's lid, and follows you to the next. It takes an hour to feed 100 colonies in this way. S. D.

South Africa.

ANSWER.—So far as I know, the crock-and-plate method of feeding you mention—without first dissolving the sugar—had never been used until about a year ago, and is the logical outgrowth of percolating instead of cooking sugar syrup. If you give the matter an actual trial, I think you will find it simpler merely to take a crock large enough to hold all the feed needed at one filling, put a cloth over it, an inverted plate on top, upset the whole and set it on the frames. Aside from the expense, I like best the Miller feeder with rags stuffed in so as to allow sugar syrup to soak through as fast as the sugar dissolves.

May Be Foul Brood.

I have some strange bee-trouble. I found a hive beeless, that stored some surplus the past summer, notwithstanding over 150 days of drouth. Yesterday I noticed no bees were about the hive, and on examination I found neither live nor dead bees in it, and a horrible stench in the hive. After removing that one I noticed the same odor in another one, that has plenty of bees. The smell is very offensive, and can be smelled 50 feet from the hive. Is it foul brood? After airing the hive the stench leaves. A. H. W.

Walnut Springs, Tex., Oct. 6.

ANSWER.—It is hard to tell from the description what is the trouble, but I should fear foul brood. It will be well worth your while to study up that disease thoroughly, and you will probably find nothing better than Dr. Howard's book on foul brood. It certainly is a very serious matter to have a colony perish outright, as yours has done, but it is still more serious if the disease be a contagious one, such as foul brood, so that it may spread through the whole apiary. See to it that the hive in which the diseased colony died is removed entirely from the reach of the remaining bees.

White Clover—Making Swarms—Out-Apiaries—Separators—Wintering.

1. Why did clover yield nectar so freely at Marengo and so scantily at Delmar, Iowa?

2. Will a prime swarm supplied with a virgin queen build more drone-comb, or less, than the same with a queen one year old?

3. Did you ever try making swarms by shaking the bees and queen in front of a new hive, leaving it on the old stand? If so, did they do well? And are such any more liable to have their swarming-fever to go through, than if they were allowed to increase at will?

4. How many out-apiaries (100 colonies each), with one helper, can you handle, or do you think you can run, for comb honey?

5. Do you think it best to use separators between every row of sections, or will one in every row or two do about as well? or would you have none at all?

6. Won't bees build even comb in narrow sections than in $1\frac{1}{4}$ wide?

7. Do you think it best to dig a cave for out-apiaries, or haul all the bees home to one big cellar, where plenty of heat and ventilation can be had? or would you have chaff hives and winter them out-doors?

It seems I am intruding on good nature by asking so many questions, but I couldn't get to Lincoln, as I had so much to do. F. C.

ANSWERS.—1. That's a question that is likely to arise to any reflecting mind, and the only reason why I don't give a full and satisfactory answer is because I don't know.

2. It will generally build less.

3. Yes, I have in more than one case shaken the bees and queen from the brood-frames, leaving in place of the frames

of brood, frames filled with foundation, and I think they are no more inclined to swarm again after such treatment than they are after swarming naturally, unless it be that in some cases more bees would be left than after natural swarming, and the stronger in bees the more likely a colony is to swarm.

4. Three; that is, one home apiary and two out-apiaries.

5. I use separators between each two sections. Possibly I might get along to omit every other one, but I wouldn't think of getting along without any separators at all so long as the honey is to be packed for shipment to a distance.

6. It seems more natural for them to build straight in the narrower sections, and yet I have no fault to find with the straightness of the combs my bees build in $1\frac{1}{4}$ sections.

7. So far I have thought best to haul my bees home each fall, but if I had the right kind of cave, or the right kind of climate for wintering out-doors, I should be glad to be rid of the trouble of hauling back and forth.

I should have been glad to have met you in Lincoln, and it was a real pleasure to meet some there whom I had previously known only through their questions, but so long as the publisher of the American Bee Journal is large-minded enough to pay me for answering questions, I'm sure I ought not to complain at the number.

Poor Season—Crooked Combs.

The honey season in this locality was very poor, and beekeepers hardly got any surplus honey. I have only three colonies of hybrids, in frame hives. From one colony I succeeded in getting a fair swarm, but no honey; from the other colony, which did not swarm, I got about two gallons, and from the third, or new swarm, about one gallon. Our chief honey-plant, horsemint, failed entirely.

1. I have a hive 18 inches long and 14 inches wide, inside measure, which should hold 10 frames, but there are only 7 in it. I bought the hive and bees from a "will-be-good" bee-keeper. Now the 7 old combs are so crooked, and built together, that I cannot remove them separately, therefore, it is impossible for me to find the queen, or to examine the brood or stores. Can you not tell me how I can get rid of these crooked combs in the fall? How would it do, if I would put a full frame of straight brood foundation in the middle of the combs, by moving the old brood-combs on the sides, and placing the new, straight comb foundation in the middle—would not the queen lay eggs in this new foundation, and the bees hatch out the brood on the outside combs? As these bees are hatched, can I not remove the crooked outside combs, and put another frame of straight foundation next on the side of the first frame of straight foundation, and so on until all crooked combs are removed?

2. I hived a swarm in a large hive 22 inches long, 14 inches wide, and 12 inches deep, inside measure; I find now that this box is much too big for a colony, and I think of putting two colonies in the same hive. As this large hive has 10 frames, each frame having about 21x10 inches, inside measure, if I would put a division-board in the middle of the hive, leaving each colony five frames, would it do to put the hybrid queen with one-half of the brood on one side, and the other part of the brood on the other side, with a new Italian queen? Would not the bees kill the new Italian queen? Southern Texas. A. L. K.

ANSWERS.—1. I don't believe you would better meddle with that colony with crooked combs till next spring, in fruit-bloom, for bees will not make very good work building comb so late in the season, and they will probably winter better just as they are than to make any change. I'm a little afraid your plan of gradually changing won't work. The bees would be slow about accepting the foundation as long as they had plenty of old comb, and the old comb would be kept filled with brood on both sides of the foundation, so there never could be any time when you could take out old comb without brood in it. It is quite possible that by a little cutting the old comb can be straightened in the frames, but if not you'll perhaps do as well to let all alone till bees swarm next time, and then three weeks later treat the hive as a box-hive.

2. If your division-board is bee-tight, the queenless bees on one side the division-board would be just the same as in a separate hive. Then you could introduce a queen the same as in any hive, letting them be without a queen a reasonable time, of course.

Every Present Subscriber of the Bee Journal should be an agent for it, and get all others possible to subscribe for it. See offer on page 715.

The "Premium" : A Good Watch Mailed Free !

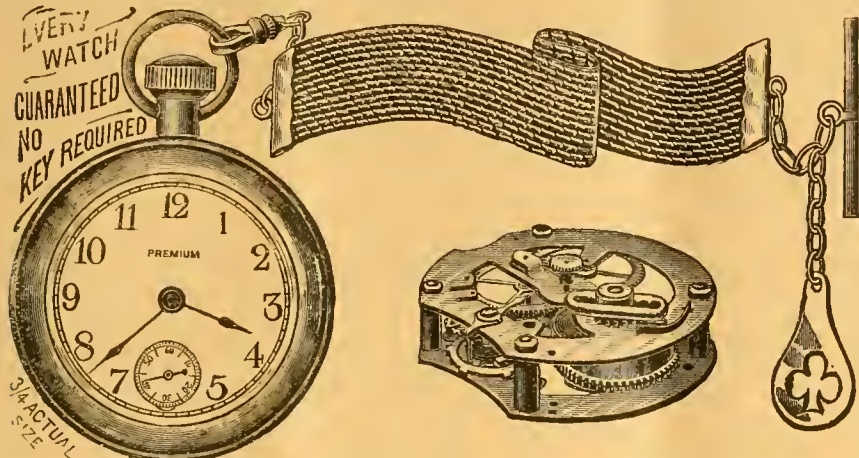

The movement of this Watch is regular American lever, lantern pinion, quick train, 240 beats per minute, three-quarter plate, short wind; runs 30 hours to one winding; dust cap over movement; every movement fully timed; regulated and guaranteed for one year, the same as a Waltham or Elgin; nickel finish, heavy bevel crystal, and back pinion wind and set.

OUR OFFERS :—We will mail the above Watch for \$1.25; or club it with the Bee Journal for a year—both together for \$2.10; or we will send it free as a premium for getting Three New yearly Subscribers to the Bee Journal at \$1.00 each. The Watch is mailed from New York City, so please allow a few days before expecting your order to be filled.

GEORGE W. YORK & CO., 118 Michigan St., Chicago, Ill.

Question-Box.

In the multitude of counsellors there is safety.—Prov. 11-14.

Shall We Get Apis Dorsata ?

Query 35.—From what you have heard and read concerning Apis dorsata ("the giant bees of India"), do you consider it advisable for the Government to import them?—N. Y.

Wm. McEvoy—No.

E. France—Yes, try them.

Mrs. J. N. Heater—I think not.

J. M. Hambaugh—I am in favor of making the effort.

J. A. Green—I consider it an experiment of doubtful value.

R. L. Taylor—No, not in the interest of bee-keepers financially.

W. G. Larrabee—Yes, if they would not turn out like the English sparrow.

Chas. Dadant & Son—We do not believe Apis dorsata would stand our climate.

C. H. Dibbern—No I think they would be of no value to the bee-keepers of America.

P. H. Elwood—Probably not. There are other things the Government might do that would help us more.

Prof. A. J. Cook—I certainly do. I think that is just the kind of work for the Government to carry forward.

G. M. Doolittle—There is lots of money spent more foolishly by the Government than in importing Apis dorsata.

Dr. J. P. H. Brown—My opinion is that they would not be a desirable acquisition to the bee-keepers of the United States.

Jas. A. Stone—I have not made up my mind. In doing so, I always think of English sparrows, and I am very slow to say yes.

Eugene Secor—If the Government wishes to experiment with Apis dorsata, I have no objections; but as a bee-keeper I shall not ask it to do so, at present.

Emerson T. Abbott—No; Government was not organized to import bees, or any other kind of live stock. The sooner people learn this the better it will be for them, and the Government, too.

Dr. C. C. Miller—It may not be safe to answer this, for fear of false charges, such as has been made, but I think if the Government does anything for bee-keepers, it might be in some better way.

Rev. M. Mahin—I do not. It is my opinion that they would not be of any advantage to the bee-keepers of America. If they were capable of domestication the people of India would have domesticated them long ago.

Mrs. L. Harrison—I do; and put them in the Everglades of Florida; they are 160 miles long and 60 miles broad. The water is from one to six feet deep, dotted with little islands. The Seminole Indian and Apis dorsata would go well together, for he likes honey, when it is to be had for the taking; also fruit, but in his wild state he has never been known to plant a tree, or keep bees in a hive.

G. W. Demaree—I would be glad if the agricultural department of the Government would take the matter in hand, and import the big honey-bee of India—

✦ MONEY SAVED IS MONEY GAINED. ✦

THE ROYAL UNION Life Insurance Company DES MOINES, IOWA.

The Iowa Policy

Is one that definitely promises to keep an accurate account with you; credit your premiums and interest, charge the actual expense and mortality cost, and hold the remaining funds subject to your order.

Agents Wanted.

JOHN B. KING, GENERAL AGENT,
Suite 513 First Nat'l Bank Bld'g,
20A1f CHICAGO, ILL.

Mention the American Bee Journal.

THROAT AND LUNG DISEASES,
DR. PEIRO, Specialist
Offices: 1019, 100 State St.,
CHICAGO. Hours 9 to 4.

Mention the American Bee Journal.

DUQUESNE COLLEGE !

PENN AVE. AND EIGHTH ST.
PITTSBURG, PA.

Thorough Courses—Classical, Scientific, Normal, English, Commercial, Preparatory, and Ladies Literary. Efficient and experienced instructors. Day and Night sessions.

Send for Catalog.

Mention the American Bee Journal.

IF YOU WANT THE BEE-BOOK

That covers the whole Apicultural Field more completely than any other published, send \$1.25 to Prof. A. J. Cook, Claremont, Calif., for his

Bee-Keeper's Guide.

Liberal Discounts to the Trade.

Mention the American Bee Journal.

Extracted Honey For Sale !

We can furnish **Basswood** Extracted Honey, in 60-pound tin cans, on board cars in Chicago, at these prices: 1 can, in a case, 8 cents per pound; 2 cans in one case, 7½ cents; 4 cans (2 cases) or more, 7¼ cents; or in kegs holding about 275 lbs., net, at 7 cents. Cash must accompany each order.

A sample of the honey will be mailed to an intending purchaser, for 10 cents, to cover postage, packing, etc. We guarantee purity, and what we ship will be equal to sample.

Now it seems to us here is a splendid chance for any bee-keeper to supply his home demand after his own crop is all sold. Or, why not begin now to create a local honey-trade? Order one 60-pound can first, and start out among your neighbors and friends, and see what you can do. You ought to get at least 15 cents per pound in 5-pound lots, or 50 cents for 3 pounds. Some may be able to do even better than that, though we think that enough ought to be sold at these prices to make a fairly paying business out of it. Give it a good trial. Push it. It may grow into a nice winter's work for you.

GEORGE W. YORK & CO., 118 Michigan Street, CHICAGO, ILL.

Apis dorsata. But, really, I fear that the undertaking might fail because the officials would most certainly entrust the management of the new bees to some favorite *dudes* who would make a windy failure of them. Say, why not organize a "stock company" and do our own importing, and put the queens under the care of practical bee-men, for trial?

J. E. Pond—No! Most decidedly not. Some years ago the matter was discussed somewhat, and from what I gathered from that discussion, I was obliged to come to the conclusion that they could not become a practical factor in modern apiculture; and I am of the opinion now, that the discussion that is being made, is more to subvert the purpose of some one who knows that cranks and an easily-gulled public always exist, and "are playing a tune to suit their desire for dancing." This, I think, is the attempt on the part of those who are trying to work up a boom on the big hum-bug—"Apis dorsata."

General Items.

No More Novels—Feeding Bees.

I don't want to miss any numbers of the American Bee Journal. I've quit reading novels since I have had access to the Bee Journal, but I wish it contained letters and experiences from Southern apiarists, for our warm climate has different needs from the North. We know nothing of housing up bees here, since they can work nearly the whole year.

I tried various methods for feeding, the past dry summer, and I hit upon a grand success, by placing honey-comb on plates, and filling with syrup.

MARY F. HUDDLESTON.

DeWitt Co., Tex.

Not Repudiators.

I did not get a pound of spring surplus honey. I began to think my bees were going to repudiate their subscription to the Bee Journal and Gleanings, but they came to time with a small yield of the finest fall honey I ever had. So you see they are *not* repudiators.

W. E. BURNETT.

Harrisburg, Ill., Oct. 23.

South Dakota Report—Golden's Plan.

As I have not seen any report from South Dakota this fall, I will send mine. I do not know whether to call it a bad or good year. I am inclined to think it was a fair one, although we did not get much honey, and the reason I think was, the bees were quite weak last spring. I got about 100 pounds of nice comb honey in sections, besides a number of unfinished sections. I had at least one colony that did well. It was a swarm that issued about June 4; I think it was two swarms on account of its large size. They have filled the brood-nest with comb from starters, and stored 50 pounds in the super, and it is now in a good condition for winter. Five others finished 50 pounds, while 30 others were selfish, and did nothing for me, but they are in a fair condition for winter.

We found a bee-tree the other day. The curiosity about it was that the bees



YOU
HAVE
BACKACHE

Get Rid of It!

It is a sign that you have Kidney Disease; Kidney Disease, if not checked, leads to Bright's Disease,

and Bright's
Disease
Kills!

Because the Kidneys break down and pass away with the urine.

Heed the Danger Signal

and begin to cure your Kidneys to-day by taking

Warrant's
Safe Cure

Large bottle or new style smaller one at your druggist's.

Mention the American Bee Journal.

RAIL ROAD LANDS

For Sale at Low Prices and on Easy Terms.

The Illinois Central Railroad Company offers for sale on easy terms and at low prices, 150,000 acres of choice fruit, gardening, farm and grazing lands located in

SOUTHERN ILLINOIS.

They are also largely interested in, and call especial attention to the 600,000 acres of land in the famous

YAZOO VALLEY OF MISSISSIPPI

lying along and owned by the Yazoo & Mississippi Valley Railroad Company, and which that company offers at low prices and on long terms. Special inducements and facilities offered to go and examine these lands, both in Southern Illinois and in the "Yazoo Valley," Miss. For further description, map, and any information, address or call upon E. P. SKENE, Land Commissioner, No. 1 Park Row, Chicago, Ill. 33D6t

Mention the American Bee Journal.

See the premium offer on page 717!

had built the combs underneath the trunk among the branches of a leaning tree.

Mr. Golden wrote an article in favor of letting the bees swarm and hiving in supers. What are the advantages and disadvantages of this plan? I should be glad to hear some more on the same subject, as I did not see the object of having a bee-space covered on the outside of the super. If the plan would work nicely, I am sure it would prove a benefit to this part of the country, as the bees have been able to fill the brood-chamber with honey, and if fairly strong would also store some surplus; and not one year in ten have the early swarms failed to build brood-combs from starters and store plenty for winter. The bees gathered most of their winter supply from golden-rod this fall.

Success to the Bee Journal.

L. A. SYVERUD.

Canton, S. Dak., Oct. 27.

Did Nothing Extra This Year.

My bees did nothing extra this year. We took 917 sections of honey from 23 colonies—not quite 40 to the hive. They are what are called "pound" sections, which, however, do not quite weigh that.

ALBERT BAXTER.

Muskegon, Mich., Oct. 22.

Got a Small Crop of Honey.

A year ago I was not able to attend to my bees, and could not attend to them last spring, or in swarming-time, so they had to run themselves. I got some honey this fall for the first in 3 years, averaging 25 pounds per colony. Some of the best gave me 50 pounds of surplus. They have become reduced from 90 to 50 colonies. I could have had them all come through nicely last winter, had I been able to attend to them, and feed the weak ones. The strong ones took what little honey the weak ones had. The honey this year is all section honey, white and good quality, gathered in August and the first week in September. I have a home market for all of it.

Pana, Ill., Oct. 18. D. C. McLEOD.

The Season of 1896.

As the honey season is closed for this year in the northern and middle States, I will endeavor to give the results of my apiary, although not a very large one. My spring count was 28 colonies, four out of that number dying out for some cause or other, which I did not fully ascertain. Four more were found to be queenless; two of them were supplied with a comb of brood and eggs from one of my best colonies of Italian bees. The four queenless colonies had laying workers, laying, and they were producing drones in large numbers. The remaining two colonies were furnished untested Italian queens from the South.

Now for the results: Out of the remaining 20 we got 12 swarms, and three of the new swarms cast a swarm each, but I lost all three of them, being the first that I have lost for a number of years, so far as I know. One of the swarms were good Italians; it was not entirely lost—only to myself, as it did not go to the timber as they mostly do, but instead of that it went right straight to our town, and clustered on a cherry tree, and the lady of the house sent

word to a bee-man in the town, and he hived them. I just happened to be passing by the place a short time after they were hived, and the operator had left the place. The lady of the house called me in to look at them. I did so, and at the same time told her that I was almost sure that they came from my apiary. She wanted to know how I could tell. I told her from the fact that they were Italian bees, and that mine were the only ones in this part of the country. She said they came from the west—the very direction of our apiary.

Sure enough, when I went home, my daughters showed me the hive the swarm had come from, and the direction it went. I immediately opened the hive, and found it almost depopulated, and the section-case full. The bees were crowded for room, causing their swarming. The man that hived them was notified of the circumstances, but he would not give them up, nor could I prove they were mine, but at the same time I was fully convinced that the bees were mine.

Now for the amount of honey from the 20 colonies of bees: I have just counted up all that was taken off at different times, and in all I find it to be 400 pounds of comb honey, and 30 pounds of extracted—a very slim report, but we had a very poor season here. We missed the sweet clover, as it was an off year for it here.

J. S. SLEETH.

Chatsworth, Ill.

Report—Wintering.

Bees did well up to the first of August, and since then they have done but little except to carry honey from the supers to the brood-chamber. During the month of July they did well, and contracted the swarming-fever; consequently they cast many swarms, and the result is, there are many weak colonies, and unless they have been properly prepared for winter, many of them will perish during the winter. I find in bee-keeping that a man should commence a year in advance to prepare his bees for the next season's work, or rather, it is easier to keep a colony of bees strong than to get them strong, therefore we should be particularly careful to keep bees with plenty of stores and brood, for without bees we cannot expect honey, and we cannot expect the bees to work without food.

I have usually wintered my bees in boxes prepared so as to put from 12 to 14 in one box. I have prepared my cellar, and intend to put a part of the bees into it, as I believe it will be a great deal cheaper and handier than to pack them in sawdust.

The Bee Journal comes regularly every Thursday, and the only thing I regret is that it does not come oftener. I noticed in last week's number a letter written by Geo. T. Wheadon & Co. Well, Mr. York, I see that they attempt to score you a little, but that is not considered any disgrace. I would sooner have it that way than otherwise.

E. B. HUFFMAN.

Homer, Minn., Oct. 26.

THE "NOVELTY" POCKET-KNIFE

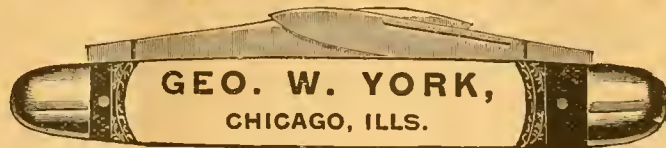

Your Name on the Knife.—When ordering, be sure to say just what Name and Address you wish put on the Knife.

The NOVELTY KNIFE is indeed a novelty. The novelty lies in the handle. It is made beautifully of indestructible celluloid, which is as transparent as glass. Underneath the celluloid, on one side of the handle is placed an AMERICAN BEE JOURNAL reminder, and on the other side, name and residence of the Subscriber.

The material entering into this celebrated knife is of the very best quality; the blades are handforged out of the very finest English razor-steel, and we warrant every blade. The bolsters are made of German silver, and will never rust or corrode. The rivets are hardened German silver wire; the linings are plate brass; the back springs of Sheffield spring steel, and the finish of handle as described above. It will last a lifetime, with proper usage.

Why purchase the Novelty Knife? In case a good knife is lost, the chances are, the owner will never recover it; but if the Novelty is lost, having name and address of owner, the finder will return it; otherwise to try to destroy the name and address, would destroy the knife. If traveling, and you meet with a serious accident, and are so fortunate as to have one of the Novelties, your pocket KNIFE will serve as an identifier; and in case of death, your relatives will at once be apprised of the accident.

How appropriate this knife is for a Christmas, New Year or birthday present! What more lasting memento could a mother give to a son, a wife to a husband, a sister to a brother, a lady to a gentleman, or vice versa, a son to a mother, a husband to a wife, a brother to a sister or a gentleman to a lady—the knife having the name of the recipient on one side?

The accompanying cut gives a faint idea, but cannot fully convey an exact representation of this beautiful knife, as the "Novelty" must be seen to be appreciated.

How to Get this Valuable Knife.—We send it postpaid, for \$1.00, or give it as a Premium to the one sending us three new Subscribers to the BEE JOURNAL (with \$3.00), and we will also send to each new name a copy of the Premium Edition of the book "Bees and Honey." We club the Novelty Knife with the BEE JOURNAL for one year, both for \$1.90.

Any Name and Address Put on the Knife.

GEORGE W. YORK & CO.,
CHICAGO, ILLS.

Allow about two weeks for your order to be filled.

California

If you care to know of its Fruits, Flowers, Climate or Resources, send for a Sample Copy of California's Favorite Paper—

The Pacific Rural Press

The leading Horticultural and Agricultural paper of the Pacific Coast. Published weekly, handsomely illustrated, \$2.00 per annum. Sample Copy Free.

PACIFIC RURAL PRESS,
220 Market St., - SAN FRANCISCO, CAL.

MUTH'S HONEY EXTRACTOR
PERFECTION
Cold-Blast Smokers.

Square Glass Honey Jars, Etc.

For Circulars, apply to CHAS. F. MUTH & SON,
Cor. Freeman & Central Aves., Cincinnati, O.
Send 10c for Practical Hints to Bee-Keepers.

Mention the American Bee Journal.

COMB FOUNDATION!

Wax always wanted for Cash or in Exchange for Fdn. or other Supplies. My trade is established on Low Prices and the merit of my Foundation. Orders filled promptly.

WORKING WAX INTO FDN. BY THE LB. A SPECIALTY. Wholesale prices to dealers and large consumers. Send for Prices and Samples to—GUS DITTMER, AUGUSTA, WIS.

Reference—Augusta Bank. 1 Atif
Mention the American Bee Journal.



ONE MAN WITH THE UNION COMBINATION SAW

Can do the work of four men using hand tools, in Rippling, Cutting-off, Milling, Rabbeting, Grooving, Gaining, Dadoing, Edging-up, Jointing Stuff, etc. Full Line of Foot and Hand Power Machinery Sold on Trial. Catalogue Free.

SENECA FALLS MFG. CO.,
46 Water St., SENECA FALLS, N. Y.
1 A1y Mention the American Bee Journal.

PROF. A. J. COOK'S BOOK FREE!

The Bee-Keeper's Guide

MANUAL OF THE APIARY.

This 15th and latest edition of Prof. Cook's magnificent book of 460 pages, in neat and substantial cloth binding, we propose to give away to our present subscribers, for the work of getting new subscribers for the American Bee Journal.

A description of the book here is quite unnecessary—it is simply the most complete scientific and practical bee-book published to-day. Fully illustrated, and all written in the most fascinating style. The author is also too well-known to the whole bee-world to require any introduction. No bee-keeper is fully equipped, or his library complete, without "THE BEE-KEEPER'S GUIDE."

Given For 2 New Subscribers.

The following offer is made to PRESENT subscribers only, and no premium is also given to the two new subscribers—simply the Bee Journal for one year:

Send us Two New Subscribers to the Bee Journal (with \$2.00), and we will mail you a copy of Prof. Cook's book FREE as a premium. Prof. Cook's book alone sent for \$1.25, or we club it with the Bee Journal for a year—both together for only \$1.75. But surely anybody can get only 2 new subscribers to the Bee Journal for a year, and thus get the book as a premium. Let everybody try it. Will you have one?

HATCH Chickens BY STEAM
With the MODEL
EXCELSIOR Incubator
Simple, Perfect, Self-Regulating. Thousands in successful operation. Lowest priced first-class Hatcher made.
GEO. H. STARR,
114 to 122 S. 6th St. Quincy, Ill.

44A26t Mention the American Bee Journal.

GEORGE W. YORK & CO., 118 Mich. St., CHICAGO, ILL.

BEE-BOOKS

SENT POSTPAID BY

George W. York & Co.,
Chicago, Illa.

Bees and Honey, or Management of an Apiary for Pleasure and Profit, by Thomas G. Newman.—This edition has been largely re-written, thoroughly revised, and is "fully up with the times" in all the improvements and inventions in this rapidly-developing pursuit, and presents the apiculturist with everything that can aid in the successful management of an apiary, and at the same time produce the most honey in an attractive condition. It contains 250 pages, and 245 illustrations—is beautifully printed in the highest style of the art, and bound in cloth, gold-lettered. Price, \$1.00.

Langstroth on the Honey-Bee, revised by Dandant.—This classic in bee-culture, has been entirely re-written, and is fully illustrated. It treats of everything relating to bees and bee-keeping. No apiarian library is complete without this standard work by Rev. L. L. Langstroth—the Father of American Bee-Culture. It has 520 pages; bound in cloth.

Price, postpaid, \$1.25.

Bee-Keepers' Guide, or Manual of the Apiary, by Prof. A. J. Cook, of the Michigan Agricultural College.—This book is not only instructive and helpful as a guide in bee-keeping, but is interesting and thoroughly practical and scientific. It contains a full delineation of the anatomy and physiology of bees. 460 pages; bound in cloth and fully illustrated.

Price, postpaid, \$1.25.

Scientific Queen-Rearing, as Practically Applied, by G. M. Donlittle.—A method by which the very best of Queen-Bees are reared in perfect accord with Nature's way. 176 pages, bound in cloth, and illustrated. Price, \$1.00.

A B C of Bee-Culture, by A. I. Root.—A cyclopaedia of 400 pages, describing everything pertaining to the care of the honey-bees. It contains 300 engravings. It was written especially for beginners. Bound in cloth. Price, \$1.25.

Advanced Bee-Culture, Its Methods and Management, by W. Z. Hutchinson.—The author of this work is too well known to need further description of his book. He is a practical and entertaining writer. You should read his book. 90 pages, bound in paper, and illustrated. Price, 50 cts.

Rational Bee-Keeping, by Dr. John Dzierzon.—This is a translation of his latest German book on bee-culture. It has 350 pages; bound in cloth, \$1.25; in paper covers, \$1.00.

Blauen Kultur, by Thomas G. Newman.—This is a German translation of the principle portion of the book called BEES OF HONEY. 10 page pamphlet. Price, 40 cents.

Convention Hand-Book, for Bee-Keepers. Thomas G. Newman.—This contains the parliamentary law and rules of order for Bee Conventions—also Constitution and By-Laws, with subjects for discussion, etc. Cloth, gold-lettered. Price, 25 cts.

Thirty Years Among the Bees, by Henry Alley.—Gives the results of over a quarter-century's experience in rearing queen-bees. Very latest work of the kind. Nearly 100 pages. Price, 50c.

Why Eat Honey?—This Leaflet is intended for FREE distribution, to create a Local Market, 100 copies, by mail, 40 cts.; 500 for \$1.50; 1000, \$2.50. If 500 or more are ordered at one time, your name and address will be printed on them FREE.

How to Keep Honey and preserve its richness and flavor. Price same as Why Eat Honey.

Apiary Register, by Thos. G. Newman.—Devotes two pages to a colony. Leather binding. Price, for 50 colonies, \$1.00; for 100 colonies, \$1.25.

Preparation of Honey for the Market, including the production and care of comb and extracted honey. A chapter from BEES AND HONEY. Price, 10 cents.

Bee-Pasturage a Necessity.—This book suggests what and how to plan. It is a chapter from BEES AND HONEY. Price, 10 cents.

The Hive I Use, by G. M. Doolittle. It details his management of bees, and methods of producing comb honey. Price, 5 cents.

Dr. Howard's Book on Foul Brood.—Gives the McEvoy Treatment and reviews the experiments of others. Price, 25 cts.

Dictionary of Apiculture, by Prof. John Phil. Gives the correct meaning of nearly 500 apicultural terms. Price, 50 cts.

Winter Problem in Bee-Keeping, by G. R. Pierce. Result of 25 years' experience. 50 cts.

Handling Bees, by Chas. Dadant & Son.—A Chapter from Langstroth Revised. Price, 8 cts.

Bee-Keepers' Directory, by H. Alley.—Latest methods in Queen-Rearing, etc. Price, 50c.

Foul Brood Treatment, by Prof. F. R. Cheshire.—Its Cause and Prevention. Price, 10 cts.

Foul Brood, by A. R. Kohnke.—Origin, Development and Cure. Price, 25 cts.

History of Bee-Associations, and Brief Reports of the first 20 conventions. Price, 15 cts.

Honey as Food and Medicine, by T. G. Newman.—A 32-page pamphlet; just the thing to create a demand for honey at home. Should be scattered freely. Contains recipes for Honey-Cakes, Cookies, Puddings, Foam, Wines, and uses of honey for medicine.

Prices, prepaid—Single copy, 5 cts.; 10 copies, 35 cts.; 50 for \$1.50; 100 for \$2.50; 250 for \$5.50; 500 for \$10.00; or 1000 for \$15.00.

When 250 or more are ordered, we will print the bee-keeper's card (free of cost) on the front cover page.

Bee-Keeping for Profit, by Dr. G. L. Tinker.—Revised and enlarged. It details the author's new system, or how to get the largest yields of comb or extracted honey." 50 p.; illustrated, 25c.

Emerson Binders, made especially for the BEE JOURNAL, are convenient for preserving each number as first as received. Not suitable to Canada. Price, 75 cts.

Commercial Calculator, by C. Ropp.—A ready Calculator, Business Arithmetic and Account-Book combined in one. Every farmer and business man should have it. No. 1, bound in water proof leatherette, calf finish. Price, 40 cts. No. 2, in fine artificial leather, with pocket, silicate slate, and account-book. Price, 60 cts.

Green's Four Books, by Chas. A. Green.—Devoted to, 1st, How We Made the Old Farm Pay; 2nd, Peach Culture; 3rd, How to Propagate Fruit-Plants, Vines and Trees; 4th, General Fruit Instructor. Nearly 120 pages. Fully illustrated. 25 cts.

Green's Six Books on Fruit-Culture, by Chas. A. Green.—Devoted 1st, to Apple and Pear Culture; 2nd, Plum and Cherry Culture; 3rd, Raspberry and Blackberry Culture; 4th, Grape Culture; 5th, Strawberry Culture. 129 pp.; illustrated. 25 cts.

Garden and Orchard, by Chas. A. Green.—Gives full instructions in Thinning and Marketing Fruits; Pruning, Planting and Cultivating; Spraying, Evaporation, Cold Storage, etc. 94 pages, illustrated. Price, 25 cts.

Kendall's Horse-Book.—75 pictures, showing positions of sick horses, and treats on all their diseases. English or German. Price, 25 cts.

Silo and Silage, by Prof. A. J. Cook.—It gives the method in operation at the Michigan Agricultural College. Price, 25 cts.

Lumber and Log-Book.—Gives measurements of lumber, logs, planks; wages, etc. 25c.

Maple Sugar and the Sugar Bush, by Prof. A. J. Cook.—Full instructions. Price, 35 cts.

Grain Tables, for casting up the price of grain, produce, hay, etc. Price, 25 cts.

Capons and Caponizing, by Dr. Sawyer, Fanny Field, and others.—Illustrated. All about caponizing fowls, and thus how to make the most money in poultry-raising. 64 pages. Price, 30 cts.

Our Poultry Doctor, or Health in the Poultry Yard and How to Cure Sick Fowls, by Fanny Field.—Everything about Poultry Diseases and their Cure. 64 pages. Price, 30 cts.

Poultry for Market and Poultry for Profit, by Fanny Field.—Tells everything about the Poultry Business. 64 pages. Price, 25 cts.

Turkeys for Market and Turkeys for Profit, by Fanny Field.—All about Turkey-Raising. 64 pages. Price, 25 cts.

Rural Life.—Rees, Poultry, Fruits, Vegetables, and Household Matters. 100 pages. 25 cts.

Potato Culture, by T. B. Terry.—It tells how to grow them profitably. Price, 40 cts.

Hand-Book of Health, by Dr. Foote.—Hints about eating, drinking, etc. Price, 25 cts.

Alsike Clover Leaflet.—Full directions for growing. 50 for 25 cts.; 100 for 40 cts.; 200, 70c.

Book Clubbing Offers.

(Read Carefully.)

The following clubbing prices include the American Bee Journal one year with each book named. Remember, that only ONE book can be taken in each case with the Bee Journal a year at the prices named. If more books are wanted, see postpaid prices given with

the description of the books on this page Following is the clubbing-list:

1. Langstroth on the Honey-Bee.....	\$2.00
2. A B C of Bee-Culture.....	2.00
3. Bee-Keepers' Guide.....	1.75
4. Bees and Honey [Cloth bound].....	1.65
5. Scientific Queen-Rearing.....	1.75
6. Dr. Howard's Foul Brood Book.....	1.10
7. Advanced Bee-Culture.....	1.30
9. Blauen-Kultur [German].....	1.25
10. Rational Bee-Keeping [Cloth bound].....	2.00
11. Rational Bee-Keeping [Paper bound].....	1.75
12. Thirty Years Among the Bees.....	1.30
13. Bee-Keeping for Profit.....	1.15
14. Convention Hand-Book.....	1.15
15. Poultry for Market and Profit.....	1.10
16. Turkeys for Market and Profit.....	1.10
17. Capons and Caponizing.....	1.10
18. Our Poultry Doctor.....	1.10
19. Green's Four Books.....	1.15
20. Green's Six Books on Fruit-Culture.....	1.15
21. Garden and Orchard.....	1.15
23. Rural Life.....	1.10
24. Emerson Binder for the Bee Journal.....	1.60
25. Commercial Calculator, No. 1.....	1.25
26. Commercial Calculator, No. 2.....	1.40
27. Kendall's Horse-Book.....	1.10
30. Potato Culture.....	1.20
32. Hand-Book of Health.....	1.10
33. Dictionary of Apiculture.....	1.35
34. Maple Sugar and the Sugar Bush.....	1.20
35. Silo and Silage.....	1.10
36. Winter Problem in Bee-Keeping.....	1.30
37. Apiary Register (for 50 colonies).....	1.75
38. Apiary Register (for 100 colonies).....	2.00
39. Bee-Keepers' Directory.....	1.30

CARLOADS



Of Bee-Hives, Sections, Shipping-Cases, Comb Foundation, and Everything used in the Bee-Industry.

I want the name and address of every Bee-keeper in America. No reason why you cannot do business with me. I have Cheap Lumber and Experienced Workmen; a good Water-Power Factory and know how to run it. I am supplying Dealers as well as consumers. Why not you? Send for Catalogues, Quotations, etc. **W. H. PUTNAM,** 1E RIVER FALLS, Pierce Co., Wis.

DO NOT ORDER UNTIL YOU HAVE WRITTEN US FOR PRICES ON

The "Boss" One-Piece Section



Also D. T. Hives, Shipping-Crates and Other Supplies.

We have completed a large addition to our Factory, which doubles our floor room; we are therefore in better shape than ever to fill orders on short notice. Send for Price-List

J. FORNCROOK,

WATERTOWN, Jeff. Co., Wis., Jan. 1st, 1896.

Barnes' Foot-Power Machinery.

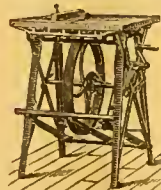

Read what J. I. PARENT, of CHARLTON, N.Y., says:—"We cut with one of your Combined Machines, last winter 500 chaff hives with 7-in. cap, 100 honey-racks, 500 broad frames, 2,000 honey-boxes and a great deal of other work. This winter we have double the amount of bee-hives, etc., to make and we expect to do it with this Saw. It will do all you say it will. Catalogue and Price-List.

Free. Address, W. F. & JOHN BARNES, 45Ct. No. 995 Ruby St., Rockford, Ill.

Mention the American Bee Journal.

The RURAL CALIFORNIAN

Tells all about Bees in California.

The Yields and Price of Honey; the Pasturage and Nectar-Producing Plants; the Bee-Rauches and how they are conducted. In fact the entire field is fully covered by and expert bee-man. Besides this, the paper also tells you all about California Agriculture and Horticulture. \$1.50 per Year; Six Months, 75 cents. Sample Free.

THE RURAL CALIFORNIAN, 218 N. Main St., LOS ANGELES, CALIF.

"THE LITTLE OLANT BOOK-KEEPER"

BOOK-KEEPING

AT A GLANCE.

By Expert J. T. BRIERLEY.

A SIMPLE AND CONCISE METHOD OF PRACTICAL BOOK-KEEPING.



With instructions for the proper keeping of Books of Accounts and Numerous Explanations and Forms used in a Commercial business; showing an ENTIRE SET OF BOOKS BASED UPON ACTUAL TRANSACTIONS.

How to take off a Trial Balance sheet; and finally CLOSE AND BALANCE ACCOUNTS; EQUATION OF PAYMENTS; METRIC SYSTEM OF WEIGHTS and Measures.

Containing 144 pp., size, 5 x 2 3/4 inches, bound in flexible

Russia, indexed, 75 cents each, postpaid.

Special Offer: We will mail this book free sending us two New Subscribers to the Bee Journal for one year (with \$2.00), and also send a copy of the premium book "Bees and Honey" to each of the new subscribers; or we will club the book with the Bee Journal for a year—both for \$1.60.

GEORGE W. YORK & CO.,
- CHICAGO, ILLS.

40,000.

THE Nebraska Farmer

Has made a contract with the Nebraska Club, to print for them 40,000 copies over and above the regular weekly issue, each month for six months, of reliable information about Nebraska.

If interested, send for free copy to
MR. CHAS. E. WILLIAMSON,
Secretary Nebraska Club,
OMAHA, NEBR., or

Nebraska Farmer Co.
Lincoln, Nebr.

44A13 Mention the American Bee Journal.

YOUR BEESWAX!

UNTIL FURTHER NOTICE, we will allow 26 cents per pound for Good Yellow Beeswax, delivered at our office—in exchange for Subscription to the BEE JOURNAL, for Books, or anything that we offer for sale in the BEE JOURNAL. Or, 24 cts. cash.

GEORGE W. YORK & CO.,
CHICAGO, ILLS
Mention the American Bee Journal.

Bee-Keepers' Photograph.—We have now on hand a limited number of excellent photographs of prominent bee-keepers—a number of pictures on one card. The likeness of 49 of them are shown on one of the photographs, and 121 on the other. We will send them, postpaid, for 30 cents each, mailing from the 121 kind first; then after they are all gone, we will send the 49 kind. So those who order first will get the most "faces" for their money. Send orders to the Bee Journal office.

HONEY and BEESWAX

MARKET QUOTATIONS.

The following rules for grading honey were adopted by the North American Bee-Keepers' Association, and, so far as possible, quotations are made according to these rules:

FANCY.—All sections to be well filled; combs straight, of even thickness, and firmly attached to all four sides; both wood and comb unsoiled by travel-stain, or otherwise; all the cells sealed except the row of cells next the wood.

No. 1.—All sections well filled, but combs uneven or crooked, detached at the bottom, or with but few cells unsealed; both wood and comb unsoiled by travel-stain or otherwise.

In addition to this the honey is to be classified according to color, using the terms white, amber and dark. That is, there will be "fancy white," "No. 1 dark," etc.

Chicago, Ill., Oct. 20.—Fancy white, 12@13c.; No. 1, 11@11 1/2c.; fancy amber, 10c.; No. 1, 9c.; fancy dark, 9c.; No. 1, 7@8c. Extracted, white, 5@7c.; amber, 5@6c.; dark, 4 1/2@5c. Beeswax, 25c.

Receipts liberal; demand limited for all kinds.

Philadelphia, Pa., Oct. 30.—Fancy white comb, 13-14c.; No. 1 white, 11-12c.; fancy amber, 10-11c.; dark, 8-9c. Extracted, white, 6-8c.; amber, 4-5c.; dark, 3-4c. Beeswax, 26c. Comb honey arriving freely and market overstocked at present.

Detroit, Mich., Sept. 30.—No. 1 white, 12-12 1/2c.; fancy amber, 10-11c.; No. 1 amber, 9-10c.; fancy dark, 8-9c. Extracted, white, 5 1/2-6c.; amber, 5-5 1/2c.; dark, 4-5c. Beeswax, 24-25c.

Indianapolis, Ind., Oct. 3.—Fancy white, 14-15c.; No. 1 white, 12-13c. Extracted, white, 6-7c. Beeswax, 22-25c. Demand is fair for grades quoted, but no demand for inferior grades.

St. Louis, Mo., Sept. 30.—Fancy white, 13@14c.; No. 1 white, 12@12 1/2c.; fancy amber, 11@11 1/2c.; No. 1 amber, 10@10 1/2c.; fancy dark, 8@9c.; No. 1 dark, 7@7 1/2c. Extracted, white, in cans, 5c.; in barrels, 4@4 1/2c.; amber, 3@3 1/2c.; dark, 2 1/2@3c. Beeswax, 19@20c.

Very little honey coming in at present, and the weather is too warm to handle to advantage if it were here.

New York, N. Y., Oct. 9.—Fancy white, 12@13c.; off grades, 10@11c.; buckwheat, 8@9c. Extracted is in fair demand at unchanged prices. Beeswax is doing a little better, and firm at 24@25c.

There is a fair demand for fancy white comb honey, while off grades, mixed, and buckwheat are rather neglected. Receipts are heavy and stock accumulating. Sales are principally in small lots, and in order to move round quantities it is necessary to make concessions from quotations.

Albany, N. Y., Oct. 7.—Fancy white, 12-13c.; No. 1, 11-12c.; fancy amber, 9-10c.; No. 1 dark, 8-9c. Extracted, white, 6-7c.; dark, 4-5c.

The receipts of both comb and extracted honey are very large, and prices are somewhat lower. We have an ample stock of all styles except paper cartons weighing less than a pound.

Cincinnati, Ohio, Oct. 27.—Comb honey, 10@14c., according to quality. Extracted, 3 1/2@6c. Demand is slow for all kinds of honey, while the supply is good.

Beeswax is in good demand at 20@25c. for good to choice yellow.

San Francisco, Calif., Oct. 21.—White comb, 10c.; amber, 7 1/2-9c. Extracted, white, 5-5 1/2c.; light amber, 4 1/2-5c.; amber colored and candied, 3 1/2-4 1/2c.; dark tulle, 2 1/2-3c. Beeswax, fair to choice, 24-27c.

Cleveland, Ohio, Sept. 30.—Fancy white, 14 1/2@15c.; No. 1 white, 12 1/2@13c. Extracted, white, 6@7c.; amber, 4 1/2@5 1/2c. Beeswax, 22@25c.

There is not very much honey in our market. Selling rather slow. Demand beginning to be a little better. Think trade will be fair in this line this fall.

Milwaukee, Wis., Sept. 30.—Fancy white, 14-15c.; No. 1, 12-13c.; No. 1 amber, 8-10c. Extracted, white, 6-7c.; amber, 5-6c.; dark, 4-5c. Beeswax, 22-24c.

New crop of honey begins to come forward. The demand is very poor and quotations almost nominal. Weather is very warm and the consumption of honey is very small. Plenty of fruit, and hence the appetite is satisfied with same in preference. Later on we expect an improved demand for honey of all kinds.

Minneapolis, Minn., Sept. 30.—Fancy white, 12 1/2c.; No. 1 white, 10@11c.; fancy amber, 9@10c.; No. 1 amber, 8@9c.; fancy dark, 7@8c.; No. 1, 8-10c. Extracted, white, 5 1/2@6 1/2c.; amber, 5@5 1/2c.; dark, 4@5c. Beeswax, 23@26c.

The demand for both comb and extracted is very quiet, and for the latter, nominal. The hot weather of the past week or so has checked demand for comb honey.

Kansas City, Mo., Sept. 30.—Fancy white comb, 12 1/2c.; No. 1 white, 13@14c.; fancy amber, 12-13c.; No. 1 amber, 11-12c.; fancy dark, 10-11c.; No. 1, 8-10c. Extracted, white, 6-6 1/2c.; amber, 5 1/2c.; dark, 4-4 1/2c. Beeswax, 22-25c.

Buffalo, N. Y., Oct. 30.—Strictly fancy comb, 1-pound, 12-13c.; fair to good, 9-10c.; dark, 7-8c.

Demand is much better for fancy, but common stock is very dull at any price.

Boston, Mass., Oct. 9.—Fancy white, 13 1/4c.; No. 1, 11-12c. Extracted, white, 6-7c.; amber, 5-6c. Beeswax, 25c.

List of Honey and Beeswax Dealers.

Most of whom Quote in this Journal.

- Chicago, Ills.**
R. A. BURNETT & Co., 163 South Water Street.
- New York, N. Y.**
HILDRETH BROS. & SEGELKEN,
120 & 122 West Broadway
- CHAS. ISRAEL & BROS., 486 Canal St.**
- Kansas City, Mo.**
C. C. CLEMOMS & Co., 423 Walnut St.
- Buffalo, N. Y.**
BATTERSON & Co., 167 & 169 Scott St.
- Hamilton, Ills.**
CHAS. DADANT & SON.
- Philadelphia, Pa.**
WM. A. SELSER, 10 Vine St.
- Cleveland, Ohio.**
WILLIAMS BROS., 80 & 82 Broadway.
- St. Louis, Mo.**
WESTCOTT COM. Co., 213 Market St.
- Minneapolis, Minn.**
S. H. HALL & Co.
- Milwaukee, Wis.**
A. V. BISROP & Co.
- Boston, Mass.**
E. E. BLAKE & Co., 57 Chatham Street.
- Detroit, Mich.**
M. H. HUNT, Bell Branch, Wayne Co., Mich.
- Indianapolis, Ind.**
WALTER S. POWDER, 162 Massachusetts Ave.
- Albany, N. Y.**
CHAS. McCULLOCH & Co., 380 Broadway.
- Cincinnati, Ohio.**
C. F. MUTH & SON, cor. Freeman & Central avs.

Wanted

—To buy quantity lots of Fancy and No. 1 White Honey at prices to suit the times. B. WALKER, 45A Evart, Mich.

WHEN ANSWERING THIS ADVERTISEMENT, MENTION THIS JOURNAL.

READERS

Of this Journal will write to any of our advertisers, either in ordering, or asking about the Goods offered, will please state that they saw the Advertisement in this paper.

Bottom Prices

**BRING US BIG TRADE.
GOOD GOODS KEEP IT.**

If you want the best supplies that can be made at a little less cost than you can buy the same goods for elsewhere, write to us for low prices. 1896 Catalogue now ready—ask for it and a free copy of *The American Bee-Keeper* (36 pages).

Address,
**THE W. T. FALCONER MFG. CO.,
JAMESTOWN, N. Y.**

Mention the American Bee Journal.

Honey-Clovers & Buckwheat SEED FOR SALE.

We have made arrangements so that we can furnish seed of several of the Clovers and Japanese Buckwheat, by freight or express, at the following prices, cash with order:

	5lb	10lb	25lb	50lb
Alsike Clover.....	\$.70	\$1.25	\$3.00	\$ 5.75
Sweet Clover.....	.65	1.20	2.75	5.00
White Clover.....	1.25	2.00	4.50	8.00
Alfalfa Clover.....	.65	1.10	2.70	5.00
Crimson Clover....	.55	.90	2.00	3.50
Jap. Buckwheat...	.20	.35	.90	1.25

Prices subject to market changes.

Add 25 cents to your order, for cartage, if wanted by freight.

Your orders are solicited.

**GEORGE W. YORK & CO.,
CHICAGO, ILLS.**

BEGINNERS.

Beginners should have a copy of the *Amateur Bee-Keeper*, a 70-page book by Prof. J. W. Rouse. Price 25 cents; if sent by mail, 28c. The little book and the *Progressive Bee-Keeper* (a live, progressive 28-page monthly journal) one year, 65c. Address any first-class dealer, or

LEAHY MFG. CO., Higginsville, Mo.
WHEN ANSWERING THIS ADVERTISEMENT, MENTION THIS JOURNAL.

HONEY-JARS!

1-lb. square Flint Jars, with Corks, \$4.85 per gross. Including Labels, name and address on same, \$5.10 per gross.

A Full Line of Supplies on hand.

Catalogue.

**I. J. STRINGHAM,
105 Park Place. NEW YORK, N. Y.
APIARY—Glen Cove, L. I.**

Mention the American Bee Journal.

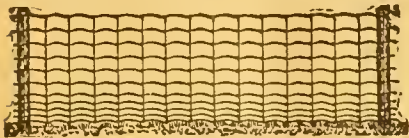

The Latest Returns!

Though incomplete, show that every State has surely gone for the **PAGE**. Where it was well known there was practically no opposition, and as it is a "stayer," this settles the question for several terms.

PAGE WOVEN WIRE FENCE CO., Adrian, Mich.
Mention the American Bee Journal.

READERS Of this Journal who write to any of our advertisers, either in ordering, or asking about the Goods offered, will please state that they saw the Advertisement in this paper.

19th Year Dadant's Foundation 19th Year

It still in the lead, for we use all the latest improvements, including the

NEW WEED PROCESS,

and still make the best goods. Remember that we do not use any acid to purify our bees-wax, and that is why our Foundation preserves the smell of the honey and is more acceptable to the bees, than any other. It is kept for sale by

T. H. Strickler, Solomon City, Kansas.
G. K. Hubbard, Fort Wayne, Ind.
L. Hansen, Davenport, Iowa.
C. Theilmann, Theilmanton, Minn.
E. C. Eaglesfeld, Berlin, Wis.
E. T. Abbott, St. Joseph, Mo.
J. M. Jenkins, Wetumpka, Alabama
John Rey, East Saginaw, Mich.
Vickery Bros., Evansville, Ind.

The Jennie Atchley Company, Beeville, Texas.
C. F. Muth & Son, Cincinnati, Ohio
E. Kretschmer, Red Oak, Iowa.
G. B. Lewis Co., Watertown, Wis.
James Reynolds Elevator Co., Pongkeepsie, N. Y.
Louisiana Bee-Keepers' Supply Manufactory, Donaldsonville, La.
Page & Lyon, New London, Wis.
John Nehel & Son, High Hill, Mo.

and many other Dealers. All agree in saying that no goods are better than ours.

We make a specialty of **Veils and Veil Stuffs** of best quality, cotton and silk.

Langstroth on the Honey-Bee, Revised

Bee-Keepers' Supplies, Smokers, Sections, Tin Pails, etc.

Samples of Foundation and Tulle FREE with Circular. Instructions to beginners with Circular. Send us your address.

CHAS. DADANT & SON,

Mention the American Bee Journal.

HAMILTON, Hancock Co., ILL.

Ask Your Friends to Take This Journal.

* Extracted Honey *



Finest Quality, Basswood and Clover.
2 60-lb. cans in case, 7c. per pound. 1 60-lb. can in case, 8c. per pound. A sample by mail, 10 cts. **POUDER'S Honey-Jars and Complete Line of Supplies.** Catalogue Free.
WALTER S. POUDER,
162 Mass. Avenue. INDIANAPOLIS, IND.

PATENT WIRED COMB FOUNDATION



**Has No Sag in Brood-Frames
Thin Flat-Bottom Foundation
Has No Fishbone in the Surplus Honey.**
Being the cleanest is usually worked the quickest of any Foundation made
J. VAN DEUSEN & SONS,
Sole Manufacturers,
Sprout Brook Montgomery Co., N. Y.

A LARGE BOOK FREE.

To every new subscriber who sends us \$1.00, we will send him our journal—

Gleanings in Bee-Culture,

one year, and the book by A. I. Root, containing 190 pages, size 6½x9½, entitled

What to Do, and How to be Happy while Doing It,

postpaid. The regular price of this work is 50 cents alone.

If you prefer, the journal may be sent to a friend, and you can keep the book for yourself.

**THE A. I. ROOT COMPANY,
MEDINA, OHIO.**

AMERICAN BEE JOURNAL

DEVOTED EXCLUSIVELY TO THE INTERESTS OF HONEY PRODUCERS

ESTABLISHED IN 1861
THE OLDEST BEE-PAPER IN AMERICA

Published Weekly, at \$1.00 per annum.

Sample Copy sent on Application.

36th Year.

CHICAGO, ILL., NOVEMBER 12, 1896.

No. 46.

CONVENTION PROCEEDINGS

[Continued from page 708.]

THE REPORT IN FULL

OF THE
Twenty-Seventh Annual Convention
OF THE

North American Bee-Keepers' Association,

HELD AT
LINCOLN, NEBR., October 7 and 8, 1896.

BY DR. A. E. MASON, SECRETARY.

THURSDAY MORNING SESSION.

The convention was called to order by Pres. Root at 8:30 o'clock.

Pres. Root—Since our speakers are not all here, we will devote some time to the discussion of questions. The following question has been handed in :

Sections and Separators.

"Are one-pound sections scalloped out enough to allow bees to pass through with ease when we use separators?"

L. O. Westcott, Swanton, Nebr.—I am not a very old bee-keeper, and I have only about 30 colonies; but recently I have used separators, and I find that some of my sections have been entirely filled up with comb by the bees, and there was no honey in them; the bees did not have enough room. The section should be cut out $1/6$ of an inch, so that when the separator is put in the bees can pass up and down more readily.

Mr. Stilson—What kind of separators do you use, straight or scalloped?

Mr. Westcott—I use scalloped sections.

Pres. Root—I should hardly think that there is any trouble about these being made shallow enough. They have been made deeper and shallower. Was the section capped over and no honey in it?

Mr. Westcott—No, it was not capped over. The space between it and the separator was closed. I have also read in the bee-papers articles complaining of this same thing.

Mr. Whitcomb—The question arose last night about extracted and comb honey. My experience is that bees always store honey in the sections in one way or the other. I produce both comb and extracted honey, but the best colonies produce comb honey. Yet I get twice as much extracted honey from a colony as I do of comb honey. But it is always under protest, especially in that part of the country where the honey is not abundant, where we have not the linden and white clover; it is where the honey-flows are moderate.

Pres. Root—My opinion is that separators are always a

hindrance, more or less. At one time I was strongly inclined to discard separators entirely.

Mr. Masters—I think these protests come on account of the bees. Some bees work readily into sections, while others refuse.

Mr. Stewart—That brings in a little hobby of mine on the size and shape of the entrance into the sections; it sprang from a statement of Mr. Heddon, that he preferred 4-piece sections because it gave a wider entrance into the sections. I used mucilage with them, but it was too much work; I did not like them, so I had sections made to order. It does not cost more than 25 cents a thousand. It gives an entrance of the same width clear across the section: that is a great improvement in the section. We can take a 24-pound case and shake nearly every bee out of it, while with the ordinary section we cannot shake them all out. They also fill up more space in the corners.

Mr. Whitcomb—I want to make a protest against Mr. Masters' remark. He lives in the best part of the country: he



Dr. C. C. Miller—See Address to Students, page 725.

has the linden and white clover. Here are his bees protesting so strongly that they go outside of the hive in the Missouri fashion. I thought we had got far beyond shaking bees out of the hive.

Mr. Abbott—Will Mr. Whitcomb explain what he means by "Missouri style?" I am here from Missouri.

Mr. Whitcomb—I was down in Missouri a little way below Mr. Abbott's, and there the bees put their honey outside of the hive.

Mr. Kretchmer—Mr. Stewart does not understand the question. I understand that the question is, the size of the notch in the side of the section.

Mr. Masters—Mr. Whitcomb misrepresents me; the colony that built the comb on the outside built some of the nicest sections I ever saw. So I want to correct his idea that my bees do not build in the sections.

Pres. Root—We will now listen to a paper by Mrs. J. N. Heater, of Columbus, Nebr. [Applause.]

The Past and Future of Bee-Keeping.

From time prehistoric bees have been kept with varying degrees of scientific intelligence and corresponding success. The Bible mentions honey in many places, though it leaves us entirely in the dark as to the methods of obtaining it in those times; but we fear no challenge to the assertion that they lived in the primitive way in rocks and cliffs, and the honey was secured either by strategy or nerve, and possibly the method would furnish a valuable suggestion to intelligent scientists of to-day. We read, not long since, of recent discoveries in Pompeii, of jugs of well preserved honey having been found in the ruins of the buried city, during official excavations; giving evidence to us 1800 years later that honey was an article of commerce at that time, though that of itself gives us no idea of their methods of producing it.

We are indebted to the Old World scholars for our first treatises on this interesting study, but "they builded better than they knew," in that they awakened an interest on the subject in the minds of thinking men on our shores, who, combining their own research and experiments with the delving of the foreign masters, have given to the world some of the most valuable and practical knowledge of our time.

In the "good old days" of our grandfathers' time, men contentedly plodded along with their ox-teams, their crude farming implements, and their native black bees in log gums or straw skeps. "Work, never ending work," was their watchword, and, the dear old souls, by frugal economy and patient industry, succeeded in accumulating wealth. But their sons, whom we may style "our fathers," came upon the field of action with a new watchword, for on every hand was heard the cry of "Progress." One invention succeeded another; the people themselves were astonished at their own achievements. The ox was sent to the stock-yards and the horse given his place in the fields to operate the wonderful new machinery. Bee-keepers were making a mighty effort to keep up in the race, and it is with interest we follow the progress of thought and experiment and see the first attempt to domesticate the native bees in the original log gum, being but a section sawed out of the tree in which they were found.

Next we see them transferred to the crude straw skep. Genius saw the possibility of further achievement, and the old box-hive was evolved; but it was reserved for our beloved Father Langstroth to improve upon all former efforts, and give to the bee-keeping fraternity the most practical movable-frame hive the world has ever seen, and which to the present time remains standard. Naturally this gave a strong impetus to bee-keeping as a business, but at that time no bees had ever been imported into this country, and every experiment had the disadvantage of having to be practiced upon the little black native.

In 1848 our German brothers introduced the Italian bees into their country, and in 1859 they were shipped into England. During the same year our brother across the line imported the first Italian bees to the shores of America. Then began a period of experiments, development and improvement in bees and bee-culture such as we have never had a record of before nor since. America, we are proud to note, took the lead of all nations in expensive research in foreign fields. Bees from all the countries of the East, including many of the islands where distinct races were found, were sent to us for inspection or experiment; then was scientific work begun in earnest. The specialist bred for size, he bred for color, he bred for trait, till the poor thing hardly knew what it ought to be when it did emerge from the cell. The surprising thing was, that the workers being of the feminine gender, they were even bred for length of tongue, and those found with the longest tongue, and the greatest activity of the same, were the ones most sought after. (Happy bees!)

Truly scientific bee-keeping, then, we may say, dates back not more than 40 or 50 years, yet what gigantic proportions it has assumed, representing millions of dollars in the annual production of honey alone, to say nothing of the capital represented in stock, factories, etc.; and, not least of all, we as a body are recognized in the commercial world.

We see, then, that the past has but fitted us for the future of our work, and we feel that while we have appliances so admirably adapted to their uses, our attention in the future

should be given more to the practical management of bees, to reduce the labor and expense to the minimum, and the more the work is simplified, the more we shall feel we are advancing. We believe that "mixed farming," so to speak, in the apiary will prevail in the near future. Better results are obtained from working for both comb and extracted honey, and even a queenless nucleus can be made to care for extra queen-cells. If the manipulation of bees shall be as much improved upon in the next half century as the general knowledge and appliances have for the same length of time in the past, we can but wonder what we, as bee-keepers, will be doing 50 years hence.

Time has brought us the comb foundation, the extractor, the smoker, and many other appliances which we could not dispense with; but shall we feel that our calling has reached its zenith, and be content with what we have and what we know? So far we have kept pace with the other agricultural pursuits; but we look about us, and, behold! in many places the horse is driven from the field by the traction engine, and again we see a monster machine cutting, threshing and sacking the grain at one operation; and we ask ourselves, what are we bee-keepers going to do to keep up in the race? Are our geniuses sleeping, or are they thinking out some marvelous thing in silence with which to surprise us?

Is it reserved for some one present with us to-day to make his life a blessing to humanity, and his name immortal, by



Mrs. J. N. Heater.

telling us for a certainty how to secure satisfactory crops of honey without increase of bees? how to keep extracted combs from one season to the next, safe from the ravages of the moth? and how to gain the best general results with the least expense and labor? for since we of the present day have taken for our watchword "Protection and Reciprocity," we have no fears but we shall receive reasonable prices for our product if put upon the market in proper condition.

Mrs. J. N. HEATER.

Pres. Root—Our time is rather short. Is there anything to be said on this excellent paper?

Dr. Miller—Mrs. Heater asks how to keep a set of extracting-combs from one season to another. I would like to ask what is the trouble in keeping combs over?

Mrs. Heater—I have had some trouble with moths getting into the combs. I have tried putting them into the cellar, but some of the hives standing next to the window, where the light reached them, were filled with moth-worms.

Dr. Miller—Put them where they will freeze.

Mrs. Heater—That is where I kept them, but they were filled with moth-worms?

Pres. Root—I have had no trouble in keeping them. Place your extracting-combs under the brood-chamber, and set the colony on top of the combs.

Mr. Abbott—A very simple way to keep extracting-combs is simply to make a rick with two parallel bars as far apart as the length of the combs, and hang the combs on these 2 or 3

inches apart. Then use a tablespoonful of sulphur and saltpeter, and set fire to it. I have kept them for three or four years in this way, and no moth got into them.

Mr. DeLong—I leave my frames on the hives until I get them ready for winter. Then I rick them up until they freeze, and then keep them in the cellar. I have kept them for three years and not a moth in them.

Pres. Root—A remedy for this is bisulphide of carbon. It kills rats, mice and everything.

Mr. Abbott—It is very dangerous. Some fool might put a match to it.

Mr. Kretchmer—Sometimes tarred building-paper is used. It will keep away rats, mice and moths.

A Member—Will the President give us particulars, how to use carbon bisulphide?

Pres. Root—Make a room as tight as possible. A half-pound is enough for a whole room. It is produced very cheaply—about 10 cents a pound. If fire gets to it, it explodes. In grain mills, they just take the cork out and let it get out into the room. The fumes prevent any one from coming too near with fire.

A Member—Would it be safe to put it into a room with a ton or two of comb honey?

Pres. Root—Yes, sir; it is very penetrating. Leave the doors and windows open for several hours, and it will all disappear. It will kill bean and pea weevils inside the beans.

Pres. Root—Our next subject, by George W. York, of Chicago, Ill., is

Honey Commission-Men and Adulteration.

The subject assigned to me is not only a very important one, but is really a double one—though in some instances as closely united as were the once famous Siamese twins, for are not honey commission-men sometimes also large adulterators of the sweet product of the bee?

It may be, however, that I can make myself better understood, and also do better justice to my double subject, if I speak of the honey commission-men, and then follow with a few words on that modern abomination—the adulteration of honey.

First, I want to say that I do not for a moment question the honey commission-men's right to live. They are a necessity—I mean the *honest* honey commission-men. The other kind may be a necessary evil, though I am inclined to doubt it.

I some times think that honey commission-men are just what bee-keepers make them, or allow them to become. But some of them, I must confess, are as "wise as serpents" and fully as harmful. It is surprising how easily otherwise wide-awake bee-keepers permit themselves to be "roped in" by flaming honey-circulars, sent out by new and untried honey commission-men, quoting high prices for honey. If those who receive such consignment-soliciting circulars would stop to consider for only a moment, it seems to me they would be wise enough to know that any quoted prices higher than those given in the market columns of the bee-papers, must be entirely fictitious, and wholly unreliable—simply thrown out as tempting "bait" to catch the unwary and easily duped.

I know that we all like to get high prices for our honey or other products, and yet we should not be such blanked fools as to suppose that a *new* honey-commission firm can secure better prices than an *old* firm that perhaps has worked up a large and regular demand for honey in its years of up-right dealing.

Then the proper thing for honey-producers to do, is to let *new* honey-commission firms entirely and severely alone, *unless* satisfied beyond all doubt of their ability and willingness to do just as they propose.

Residing in what is thought by many to be the greatest honey market in the world—Chicago—I am often placed in a position to discover some things about the doings of honey commission-men that few have the opportunity to learn. For instance, you come to Chicago with one or more carloads of honey. You call upon a large honey-commission firm; they of course are fully informed as to the needs of the market, or, if necessary, they can easily communicate by telephone with all the other large honey-dealers. In fact, no one will make you an offer, but keep you running from one firm to another, yet always wanting to know *your* figures on the honey—just what *you* are asking for it. After one of the firms finally purchases your honey—likely at their own figure—they will offer to divide it with the other honey commission-men at an advance of perhaps $\frac{1}{2}$ cent per pound, or even at the same price they paid for it. Thus you see they really can work together, and there is practically no competition whatever.

Firms with plenty of available cash capital, can buy honey outright, in carload lots, at a greatly reduced rate, and throw

it on the market at a very slight advance—say one or two cents per pound on carload lots—thus making from \$250 to \$300 per carload, and running the market price down. On the other hand, permit me to quote two sentences from a private letter that I received from an honest honey-commission firm last February, referring to another firm who *claim* to have plenty of cash capital, but some of whose dealings will hardly bear investigation. The two sentences read thus:

"They boldly say that *we* are the cause of grocers having to pay over 10 cents per pound for choice comb honey. Our competition makes honey cost *them* so much—*more* than it otherwise would!"

Again, the *dishonest* honey commission-men have everything in their own hands, once they have your honey in their possession. There is scarcely a law by which you can hold them in case you catch them at all. They can sell your consigned honey for whatever they please, and return to you as little as they please. You have only to submit, and next time let such alone, if you are wise.

But there are *honest* honey commission-men. What producers should do, is to find such, and encourage them as much as possible, by giving them their patronage, and endeavoring to aid them in every way they can—by preparing and packing their honey as the particular market requires, and allowing them to be the judges as to the best time to sell. By crowding the honest and careful commission-men, you may often cause the loss of quite a good deal on your shipment. Forced sales must always be at the lowest figures.

But honey commission-men are not the worst evil with which honey-producers must contend, as we shall presently see.

The world has had what is known in archæology as "Ages"—the Stone Age, the Bronze Age, and the Iron Age. But just now we seem to be in the midst of another "Age," namely, the *Adulteration Age!* It appears that everything susceptible of adulteration is besmirched with this growing, devastating fraud. Sanded sugar, corncobbed maple syrup, watered milk, paraffined beeswax, and glucosed or corn-syruped honey. But enough for our consideration, perhaps, is that of honey adulteration.

Who are the slimy bipeds, guilty of the adulteration of our pure, sweet product? They are mainly the city wholesale grocers, the syrup mixers, and some of the so-called honey commission-men! I am credibly informed that out of 40 of the largest city customers of a certain Chicago honey-dealer, 27 adulterate the honey they purchase! Think of that, my fellow bee-keepers! How many times over can those 27 frauds multiply the honey product, when the price of glucose to-day in Chicago is but a *trifle over one cent per pound?*

You have often seen one-pound tumblers holding a clear liquid with a piece of honey-comb in it. Well, at least one honey commission-man in Chicago puts up such, and there is just one cent's worth of pure honey in each tumbler, and the rest is glucose. It retails at 10 cents, and costs 3 cents, including the glass tumbler.

Why is glucose used almost wholly as a honey adulterant? Because it carries no taste or flavor of its own—so that when only a *little* honey is added it gives the honey flavor to the whole. Another reason is, that glucose does not granulate as does most of the pure extracted honey; this latter is looked upon with suspicion, hence as glucose does not candy, it is a feature in its favor with the uneducated.

The agent of one Chicago adulterating firm said they had to have a piece of comb in each tumbler, as that is the only way people would buy honey (?) put up in glasses nowadays. And that shows there is a great lack of education or information on the part of the consumers these days concerning pure honey.

So long as the glucose business holds out, it matters not how limited is the genuine honey product on the market, under existing circumstances.

Now, fellow bee-keepers, what can we do to stop this gigantic evil which threatens to destroy the legitimate and honorable industry of honey-production? Why, *write*, and *push* for the enactment of a *prohibitory law* that will compel the entire cessation of honey and other adulteration, or the requirement that every package of food products offered for sale shall bear upon it, in conspicuous letters, the true name or names of the contents. Then if the consumer desires to purchase glucosed honey, let him do so, and not be deceived into buying the adulterated article when he thinks he is getting the Simon-pure honey.

But some will say, "You can't enforce such a law!" I say *we can*. How? Elect men to office, and *not politicians*; men who are *honest*, who are *not afraid* to do their duty. Then when our officers attempt to put down our common enemy—the honey adulterators—let us give them all the help within

our power, instead of standing around and whining, "You can't enforce it!"

Until bee-keepers have in their hands this legal weapon with which to pulverize the monster of honey-adulteration, I can see in the future no encouragement for our beloved pursuit. But equipped with an adequate *anti-adulteration law*, bee-keeping would go marching onward with the full assurance that its devotees have an even chance to become thrifty and prosperous in a pursuit that endeavors to place upon the table in every home, one of Heaven's purest and best sweets—honey, as gathered by the blessed bee.

Chicago, Ill., Oct. 1, 1896.

GEORGE W. YORK.

At the close of Mr. York's paper, Pres. Root said: "Now friends, go on."

Dr. Miller—I endorse the whole thing, heartily.

Mr. Abbott—I think it one of the most important papers that have been read here. It ought to be a basis for some definite action. Mr. York has struck the key-note. His suggestion is a movement in the interest of pure honey. We have been going through this battle in Missouri as to "oleo." The dairymen have this down very fine. The men who manufacture "oleo" are not allowed to use any kind of oil in the manufacture of it that will give it the color of butter. That seems to be all right from the standpoint of pure food. But that is simply interfering with the rights of the men who manufacture a thing and are willing to call it by its right name. If a thing is harmless in itself we have no right to interfere with its manufacture. But we have a right to insist that the man who manufactures a thing shall call it by its proper name. And I have insisted that our dairymen have made a mistake when they attempted to say whether "oleo" should be white or black or yellow. But make them call it what it is, no matter what the color. It is like the sale of rum. We cannot make a law that people shall not drink rum; but we can make a law that when a man sells rum, he shall call it rum; when he sells "oleo" he shall call it oleo; and when he sells glucose he shall call it *glucose*! [Applause.] Every man is scrambling for dollars. Every society is besieging the legislature. It would take a room as large as this to hold the laws enacted by the legislature. The lawyers like that; it gives them employment. They don't know any more about the laws than you do. When they get a case, they read up a little, then go into court and look wise, and charge you \$100 for their services. Now, if we can get rid of these laws, and have them reduced to three or four good laws, and have one pure food law, and one man whose business it is to enforce that law, as to butter, honey—everything that is adulterated—then we can unite our forces in backing him up. But if we have one man to chase down the butter adulterator, and one to chase down the honey-adulterator, we would never accomplish anything. Now if we can make some move in the direction of co-operation to secure a law like they have in Ohio, that would be a step in the right direction.

Dr. Mason—Mr. President, it is not the law that we have that does the work; it is the men we put in power. We have a man in Ohio called the Pure Food Commissioner. Through a large number of deputies he watches for adulterated food all over the State. We have had a large number of convictions under the pure food law in Toledo alone. The dealers don't dare to offer anything that they mistrust is adulterated. Every court that has fined a man the first time has simply said, "Don't do this again," and it works nicely.

Dr. Miller—Suppose we get that man from Ohio over into Illinois. With the laws we have in Illinois, will he do as well?

Dr. Mason—You can't get him. We want him ourselves.

Mr. Alkin—There is a firm in our State (Colorado) to whom I have sold considerable extracted honey. I have been in their establishment often. They openly charge all bee-keepers in and about Denver with adulterating. I cannot say positively that they adulterate, but I do question some of their methods of advertising. I once talked with them about the honey they were selling. Alfalfa honey has a very mild flavor, white clover honey has a very decided twang. They told me they could take a can of alfalfa honey, and put into it a very little white clover honey, and sell it to their customers as "white clover honey." Mr. York spoke in his paper of glucose as not having a very decided flavor. I am under the impression that this firm uses glucose very largely—put in a little of the stronger-flavored honey, and sell it for the pure article at good, round prices. It is said that this firm has done a good deal towards holding up prices; but I fear they have done a great deal toward adulterating the product. Thus, to show you what may be done by the use of glucose, any syrup may be made to seem like the pure article.

Mr. McIntosh, a business man of Omaha, Nebr.—I am a

consumer of honey, not a producer. I never ate any adulterated honey. We always use comb honey. I don't think that is adulterated. I would not buy extracted honey any more than oleo. We don't expect to get it pure. How do we know that commission dealers are the only ones who adulterate it? The producer gets only 8 or 10 cents a pound for his honey, while we pay 20 cents for it. It is a luxury. We don't want to pay 100 per cent. more than the producer gets for it. Don't produce extracted honey.

Mr. Westcott—The other day I was talking to a man about selling comb honey to him. He said: "Comb honey is adulterated. They will even uncap it and pour glucose into it. They feed bees on glucose, and they carry it in. We have just as much in comb as in any other form."

Dr. Mason—It is a very nice thing to have consumers attend our conventions, so that we can educate them, for when a man makes the statement that he never expects to get pure extracted honey, he needs to be educated. If everybody was like Mr. McIntosh, some of us would have to go out of the business; nobody would buy extracted honey, and some of us don't know how to produce comb honey. Mr. McIntosh, buy your honey right from the producer. Find a man that you know is straight and true, and buy it of him every time. [Applause.] We are always preaching up the home market. It is the best market in the world. I have never sent a pound of honey away from home yet. I am getting 112 pounds from each of 30 colonies every summer.

A Member—What do you get for your honey?

Dr. Mason—I sell only extracted honey. I get 15 cents per single pound, and 11½ cents per pound by the gallon; never anything less. They are glad to get it. They know it is pure. I have educated them. Don't you be going around the country preaching that extracted honey isn't pure any more!

Mr. Aikin—If clover and alfalfa honey are put together—is that adulteration? We had some at the hotel; I am sure it was clover with a tinge of alfalfa. It makes it better; gives a flavor just fine. Consumers very often want something that has a fine, nice flavor. Take that which has a fine flavor and mix it with something stronger, and sell it that way. I said that a certain firm would mix a whole lot of alfalfa and a little white clover and sell it for pure white clover. If they misrepresent in that, would they not also use glucose?

Mr. Abbott—What would anybody mix the two for?

Mr. Aikin—They have customers who demand white clover honey.

Mr. York—I was very sorry to hear from Omaha, that they don't get pure honey. With all the adulteration in Chicago, we expect to get pure honey. Mr. Walker, of Michigan, furnished 50,000 pounds of extracted honey to some of the 5,000 grocers in and around Chicago, last winter, and that was pure honey. In the last few weeks I have also been bottling honey, and it is pure honey. The people want to buy pure honey, but many of the grocers say the people want the adulterated, in order to get something *cheap*. They want it for 10 cents per pound. I believe there are two kinds of glucose—the refined and the commercial. There is not the least taste to refined glucose. The adulterators mix about ½ part basswood honey and the rest glucose, and few of the consumers can tell whether it is honey or not. Three weeks ago I had a man take a wagon-load of bottled honey in ½, ¾, and 1 pound sizes. He sold the pound bottles to grocers at \$2.40 a dozen. The actual cost of the load was about \$80. He sold it for \$120. So you see there is a great field in the grocery line. I was at Springfield—the capital of Illinois—last week, attending the State Fair, and I found there was no one selling honey in that city. See what a market could be worked up in a city like that!

Dr. Mason—How long did it take to sell that load of honey?

Mr. York—About a week. In Chicago we have at least one firm which sells honey just as they get it from the producers. Something could be done for the cause of honey, if it were not for the commission sharks, whom I have been fighting in the American Bee Journal the past few months. I think we will get the frauds under control before long. The Union should back us up in the fight against them. I hope this matter will be fairly discussed, and that when the committee reports, we may all unite on something. Of course, we must have a law first, but the thing is to elect men instead of politicians. If you have not the men to enforce the law, it is worth nothing. Let us work for the anti-adulteration laws, and then have the men to enforce them. A commission man in Chicago told me that one-half more pure honey could be sold in Chicago if it were not for adulteration. Think what a market we would have then, while even to-day it is considered the best market

in the world. In 1895, 1,200,000 pounds of honey were sold in Chicago.

Pres. Root—It is now 10 o'clock, the time for the chapel exercises of the University. In accordance with the agreement last night, we will now go to the chapel, where Dr. Miller will deliver an address to the University students.

The regular devotional exercises of the students were conducted by Rev. E. T. Abbott, at the close of which Chancellor MacLean said to the students: "We are favored this morning by the attendance of the North American Bee-Keepers' Association. We will now listen to an address by Dr. C. C. Miller, of Marengo, Ill., a man famous as a musician, bee-keeper, humorist and orator."

Dr. Miller's Address to the Students.

As I look over the bright and earnest faces before me, a feeling of envy comes into my heart, to think that I cannot have the place the Chancellor has here. [Laughter.] And, then, I think if I had that place, I would be glad to exchange it for the place of one of those under his care. Dear friends, I wonder if you know what you have these opportunities, these professors and this Chancellor for.

When I look upon you, I go back—as I sometimes go back in dreams—to the time when I was in college. And when I wake from those dreams I wish it was true. My mind goes back this morning just 45 years. I go back to the time when, for two years—the last two years of my college course—for the sake of being able to write A. B. after my name, I kept house myself. I will give you an inventory of my China closet: One plate, one tablespoon—I didn't need a teaspoon; one fork; one knife; one kettle. I lived on corn-meal—I could get that for less than anything else. I boarded myself for 35 cents a week. I would not advise any of you to try it. I nearly ruined my health, but I am not sorry for the experience I had in those days. But, it seems to me, you ought to be thankful that you have a better chance than I had.

What did I work so hard for? I wanted a degree. If I could only write A. B. after my name, I would be one of the happiest men in the world. I don't know where the diploma is that has that on it. It didn't bring me the happiness that I supposed it would. When you get through your course, you will find that alone will not make you happy. You are here with advantages that will prepare you to have an influence over your fellow-beings, that you could not have without the training that you get here. It is valuable to you. I hope you will prepare for usefulness and happiness. Some of you are thinking only of what will make you happy. Advancement in study will not make you happy. There will be a vacancy left. Dear friends, I hope God will give me the grace and power this morning to impress upon your minds that the thing that will make you happy is to be useful to your fellowmen. To try to get some one to live a better life, to get a little nearer to the road that will lead him up to the life where all is joy and happiness.

Some of you may be thinking that you are to fill some great place in this world. I used to think about that. "Oh, if I could be a great man!" One of the greatest disappointments of my life was that I was not appreciated, and elected President. I thought I was made up for President of these United States.

[The Chancellor—You must be a Nebraskan.] [Laughter.]

And there were other things; nobody appreciated me. But I found after a while that there was One who could measure me, and know exactly what I was fitted for. The God that made me knows me through and through, better than I do. He placed me in a certain point, and then I found that I was to do his work joyfully, wherever he put me. Whenever you are ready to do that, you are going to be the happiest people in the world. I am the happiest man in our family, which consists of myself and two other women. [Laughter.] I am a happy man because I think I am doing the work that has been given me to do from day to day. I don't want to go away to foreign shores. I don't want to step into the Chancellor's place. I just want to do from day to day what the Lord wants me to do.

Now if you forget everything else, I want you to remember what I am going to sing to you. It is this sort of feeling that makes life worth a great deal to me. I want you to be happy in just the same way. The Lord bless you, and lead you for the betterment of the world and the salvation of souls.

C. C. MILLER.

[Then the Doctor sang the song we printed two weeks ago.—EDITOR.]

At 10:30 the Association returned to Union Hall.

Pres. Root—Dr. Bessey informs me that owing to other engagements, the only time in which he will be able to ad-

dress us is within the next five minutes. Are there any questions at present?

Wintering and Foul Brood Questions.

A Member—My bees have 50 pounds of capped honey in the brood-nest with 10 frames, chaff hives. Shall I contract to 6 frames for winter?

Dr. Miller—Let them alone.

A Member—That depends upon whether he winters them out-doors or in the cellar.

Asker of Question—Out-of-doors.

General cries—"Let them alone!"

Dr. Mason—What can be done by bee-keepers towards securing legislation in the various States for the eradication of foul brood?

Dr. Miller—I would write to some of those States that have been successful in securing legislation, and see how they have done it.

Pres. Root then introduced Prof. Chas. E. Bessey, who spoke on

A Botanist Among the Bees.

Mr. President, I have brought here for distribution a few copies of the bulletin which I have published—a preliminary list of the honey-producing plants of Nebraska.

Now, the subject which I have is "A Botanist Among the Bees." I suggested to the Secretary that I should prefer to have it read this way, because I am merely a botanist. I am sorry that I am not a bee-keeper. I was once for a little while. But the cares of this world and other brambles sprang up—and you can carry out the parable. The bee-keeping was choked off. So my knowledge of bee-keeping is merely a reminiscence. I am a botanist, but I have never been able to get away from the bee-keepers. They have been after me from year to year just as the bees used to get after me.

What can a botanist do among the bees? What can he bring to a company of men like you, that will be of any service? My business is to know plants; not merely to know them by name, for that idea of botany, which is the prevalent one, is not the idea that is held by botanists. Not merely to know the names of plants—that is a minor matter; but to know what plants are, how they live and get on in the world. Right here is where the botanist may be of use to the bee-keeper, and, through the bee-keeper, may be of use to the bees, which are domesticated, and under the control of the bee-keeper.

Among the matters that have come to the botanist these later years, are such things as the investigation of the relations existing between insects and plants. Now, these relations that the botanist discusses are not those that the entomologist takes up. The botanist investigates the use which plants make of insects; the entomologist studies the manner in which insects use the plants. The plants use insects, as was suggested last evening in one of the addresses. It is a fact that very many plants are almost entirely, and some of them entirely, dependent upon the presence of insects in order that they may propagate themselves. We have learned that the higher insects have these relations to plants in a very large degree. And the bees are among the most important of these insects, which aid in the fertilization, carrying the pollen from plant to plant, in order that there may be seed.

A plant is a good, honest thing, and always renders an equivalent. Instead of beguiling the insects to come and do some work, and then rendering no equivalent, these plants furnish something which the bees want. Now, there is where the nectar comes in. I may forget myself and call it "honey," but you will understand what I mean. It is the sweet bait which plants put somewhere in their flowers for the purpose of enticing insects to come. Now there is the philosophy of this relation between plants and bees. We have found that the flower puts some nectar here or there, in order that the bee or other insects may persistently come to these flowers; and in the search for this nectar, they manage to get themselves covered with pollen.

I am boiling down, as you will see, a good many botanical lectures into this short discussion.

Where, then, is the nectar in the flower? You may just as well ask, "Where is the bait put in the mouse-trap?" It is never put in front of the trap; it is always back of the essential part of the trap. The mouse-trap has a certain business to do—either to snap a spring down and kill the mouse, or to entrap the live mouse. The bait is, then, always put behind the essential part of the trap. The nectar is bait, pure and simple; and this is always put back of the place in the flower where the bee is to do its work of getting or leaving pollen. So, in looking for the place where the nectar is, you will always find that it stands in just that position. It is

at the farther side of something. This, then, is what the nectar is for; it is the bait to attract the insects. And so far as the bee is concerned, a bait to attract the bee.

Now, color, and odor, and the presence of pollen, perhaps, have something to do with the bee, also. These are accessories, now speaking from the standpoint of the bee. Now, why are flowers colored? I think this is a point which the bee-keeper has rarely thought of. Certainly the insect is not attracted primarily by color. Insects will not waste their time standing off and admiring the gaudy colors of flowers. But the flowers that have something in the way of nectar to offer—the flowers that are of most service to insects—are colored flowers. There is a relation, then, between color and the insect visitation. We must not overlook the fact that color is a part of this apparatus in which the bait is put. We must not overlook it or ignore it in our practice.

It is true that many flowers which have much color have little honey. Other flowers have marked color. Other things being equal, then, the botanist will say to you that the flower with color is an advantageous flower for you to use for your bees to feed upon. Why? We have found that the color of the flower, as Dr. Gray used to say, is a flag or banner put up over the place where there is this treasure that the bees are seeking. There is an indication that the bees pay some attention to the things that they see. Not like the artist does, but in the way the school-boy does. When he goes along the road and sees an orchard, the bright color of the fruit tells him that it is ready to be eaten. It is attractive in that way. Let us not ignore the fact that the color is an advertisement, other things being equal. Odor in like manner. Insects are attracted by odor merely because they have learned that odor goes frequently with the presence of nectar.

So let us put it this way: The bait is the nectar. It is placed always in the back part of the flower. The color and the odor are accessory. And, other things being equal, that flower is best, which, having nectar, has color to serve as guide, and odor to serve as a still further guide.

There is another considerable reason why white clover is an excellent plant for furnishing honey. The white flowers stand out so prominently that even a half-blind bee might find the flower. Added to them is a delicate and delightful odor which goes with it. This, then, is one part of what the botanist has to say. Don't overlook the fact that color is worth something and odor a good deal. They enable the bees to quickly find what they want.

Now, I have another point. Flowers are not all alike in shape. Some flowers are what I have called elsewhere "flat flowers." That is, they open out flat. Every petal stands out away from every other petal. The Germans sometimes call them "star flowers." I prefer to call them flat flowers. They have the general shape, when open, of a saucer. A good example is the buttercup, strawberry and poppy. The basswood has a flower of this form.

Now many of these flat flowers, which are rather primitive—they probably are the kinds of flowers which came into existence away back in early times—have a good deal of honey. You can't hide the honey very effectually in the flat saucer. It is put as far down as possible among the stamens before it can be hidden.

Then there are some flowers like the cherry, plum, etc. There the upper part of the flower is flat, but the little calyx of the flower is dished out into a little cup at the bottom. In that cup the honey is found. So that if you compare the flower of the strawberry with that of the plum or cherry, the honey is dropped down into a deep little cup. Not a very narrow cup; rather flaring, but still affording more protection for the honey.

Then pass over to such as the clover. Here you do not have a flat flower at all. I presume it is generally understood that the clover head is made of many flowers. Take out one of these little flowers. You will find that it has the same number of parts practically that you have in the cherry, or buttercup, or strawberry. But instead of being flat, its parts are brought together so that they form a tube; the parts are still separate, but there is a tubular arrangement, and the honey is away down at the bottom.

Now take the flower of a verbena—not a very good honey-flower, but very gaudy. You have these parts of the flower brought together in the form of a tube, and even grown together. This tube, with the leaves that make it up, protects the honey better than the flowers. The point to which I wish to direct your attention is this: That, as you look at flowers, the honey in some is not much protected. There may be a great deal of it, but it is open—in an open cup or saucer. In others, it is farther, and farther down, and more and more protected. In the white clover you have an additional protection, namely, that these little flowers are crowded together, side by side, so

that you have a lot of these little tubes, and at the bottom, where they furnish the best protection, there the honey is kept.

Now, what is the significance of this? Take some water and put a little in a saucer, some more in a cup, some more in a tube. Or, take some honey and do the same. You will find that the evaporation is much greater in the saucer, less in the cup, and still less in the tube. The same thing occurs in flowers. The nectar is something that evaporates very readily. When you have good weather, and suddenly there come on several days of dry air, the honey-flow is checked completely. Now, here is something to which attention has not been directed as it should be. And here I think the botanist may offer some suggestions. In the selection of honey-producing plants, other things being equal, again give preference to those in which the honey is placed at the bottom of a tube instead of in an open flower. Now, I know this is hard on the basswood. But the basswood does not cut any figure here on the plains. The further west you go, the more this is true. But in the great forests, the dry days do not come as frequently as they do here in the West. Where the dry air is likely to check the flow of honey, by drying up the nectar, we must look to it that we select flowers for nectar that have the deep cups or tubes. In the case of the white clover we have almost—not quite—an ideal plant. And while they are crowded together, they protect the honey so that there is practically no evaporation.

My time is up. Let me then repeat. My method is this, as a botanist making merely suggestions: Don't ignore color and odor in honey-producing plants, because, while you don't store up color and odor, they are advantageous in leading bees more quickly to come to their place of work. If you doubt this, you need simply to go and run over the plant kingdom. You will find that whenever plants need insects most, they develop color and odor more. Now, bees, being more intelligent, will be drawn to these more than other insects.

Second: Other things being equal, give preference to those in which the nectar is stored down in tubes. Of course, these tubes must not be too long for the tongues of the bees; but where the storage is down in the tubes, where the dry air will not take up the moisture of the nectar and carry it away. If we had a list of the honey-producing plants with the nectar stored in deep tubes, we would find that the bee-keeper would complain less and less of the sudden stoppage in the honey-flow. The list I have prepared will doubtless be suggestive to those who come from other parts of the State, as to the richness of the honey-flora of this part of the State.

I am very glad to be able to meet with you. I am sorry that my duties to my students, which are many, are such that I cannot take more part in your discussions.

CHARLES E. BESSEY.

Dr. Miller—I very seriously doubt if any feature of our convention will prove more helpful to us than the address of Prof. Bessey. I believe that we will live better in the future for the talk that we have heard. I move that a rising vote of thanks be tendered Prof. Bessey for this address. (Motion carried.)

Prof. Bessey—Gentlemen, I am very much obliged to you for this expression of kindness on your part.

At 11 o'clock the convention adjourned to go on a trip around the city, to assemble again at 3 in the afternoon.

(Continued on page 737.)

A New Binder for holding a year's numbers of the American Bee Journal, we propose to mail, postpaid, to every subscriber who sends us 20 cents. It is called "The Wood Binder," is patented, and is an entirely new and very simple arrangement. Full printed directions accompany each Binder. Every reader should get it, and preserve the copies of the Bee Journal as fast as they are received. They are invaluable for reference, and at the low price of the Binder you can afford to get it yearly.

The Names and Addresses of all your bee-friends, who are not now taking the Bee Journal, are wanted at this office. Send them in, please, when sample copies will be mailed to them. Then you can secure their subscriptions, and earn some of the premiums we have offered. The next few months will be just the time to easily get new subscribers. Try it earnestly, at least.

Now is the Time to work for new subscribers. Why not take advantage of the offer made on page 734?

PERSONAL MENTION.

MR. W. H. DANCER, of Decatur county, Iowa, made us a short call week before last. Mr. D. had 17 colonies of bees the past season, and secured about 2,500 pounds of honey. Some of his colonies averaged 240 pounds of extracted honey each. For a part of the honey he got 8½ cents per pound on board the cars at his place. He reports that white clover yielded again this year, and the prospect is that next year it will do even better. We hope it will.

MR. W. Z. HUTCHINSON, editor of the Bee-Keepers' Review, has been very unfortunate in that his young daughter, Miss Ivy, is still under the doctor's care, and his wife also is not at all well. We know something of the care and work connected with publishing a bee-paper, which of itself is sufficient without severe and long-continued sickness in the family besides. Mr. Hutchinson surely will have the heartfelt sympathy of all the bee-keeping friends, who unite most sincerely in the earnest hope that his loved ones may soon be restored to permanent good health once more.

PROF. A. J. COOK, of California, wrote this in a letter dated Oct. 29:

"I think we will have a good year next year in California. We have just had over five inches of rain, which is exceedingly encouraging. . . . I should have been very glad to have been with you at the Lincoln convention. The only objection to a home in California is our inability to meet with our friends in the East, fraternally and otherwise."

We are very glad to learn of the good prospects for California bee-keepers next year. We are anxious to see how the new Bee-Keepers' Exchange works, and that cannot be ascertained until it has an opportunity to handle a good crop of honey.

MR. JOHN TURNBULL, of Minnesota, writes us in a private letter:

"I am glad our editor is careful in regard to commission-men, for I have very little faith in them."

While it has been necessary for us to be rather severe on certain would-be commission-men, we would have our readers remember that there are also reliable dealers. Not all are frauds, by any means.

We are glad to know that our subscribers appreciate the stand we have taken against crooked dealing on the part of some commission-men, and we believe we shall not be disappointed if we look for a substantial indication of that appreciation on the part of honey-producers by a prompt renewal of subscriptions between now and Jan. 1. We can assure you in advance that such an "appreciation" would be felt here.

SKYLARK, once such a high-flier in Gleanings, seems to have migrated (like other birds) to the summery clime, for in the last Southland Queen he gives this witty reply to our proposed "amalgamation" of himself and Somnambulist:

"The editor of the American Bee Journal proposes that Skylark and Somnambulist amalgamate.

"Before I 'cross the Rubicon,' I would like to have one very important question settled. It is uncertain whether 'Sommy' is a man or woman. If he is a woman—a nice, dear little woman—'Barkis is willin'.' But if she should turn out to be a nasty, great big man, Skylark would be liable for damages, breach of promise, etc.

"No, sir; the main question must be settled first. I must know whether I am to be a husband or a wife."

As to the settlement of the main question, we shall have to call on Editor Leahy (of the Progressive bee-keeper) to do that. But, really, we have already acknowledged our mistake

in ever suggesting such an amalgamation, for we soon saw that such an ordeal would soon annihilate both "Skyke" and "Sommy," and that result was furthest from our thoughts when first making the suggestion. Judging from the tone of Skylark's sharp comment, we must conclude that it will be more conducive to the good health and long life of both himself and "Sommy,"—and also to future generations—if the former remains in California and the other in Dreamland.

DR. MILLER receives all kinds of questions from bee-keepers, among them being requests for prices of his honey and a description of it. In order that those asking the kind mentioned may save their time and stamps, the Doctor sends the following reply for publication:

"To this request and others like it, I can only say that I have no honey to ship. I did have about 10,000 of comb honey, but no longer have any to sell. I am thankful for getting that amount from 149 colonies, spring count, but feel just a little envious of the editor of the 'Old Reliable,' who kept very quiet about it but beat me in the yield per colony. I think the past was about the best season I ever had, except the year 1882, when from 174 colonies I got 16,549 pounds, a small part of it being extracted honey.

"The 149 colonies of the past season increased to 271, mostly strong colonies, but if they don't reduce the number during winter of their own accord, they will be doubled up next spring to make the number 240. At least that's what I think about it now."

HON. EDWIN WILLETS, of Michigan, died in Washington, D. C., on Saturday, Oct. 24, 1896, aged 66 years. Mr. Willets has been a well-known figure in politics for a number of years, and also held many positions of honor and trust. He was a graduate of the Michigan University, was three times a member of Congress from the district in which his home, Monroe, is situated; was President of the State Normal School, which position he resigned to accept the Presidency of the Agricultural College. When Mr. Rusk was made Secretary of Agriculture by President Harrison, Mr. Willets was appointed Assistant Secretary, which position he also held for a time under J. Sterling Morton. Since then he has practiced law when his health permitted.

The foregoing paragraph we take from the Michigan Farmer. We believe it was Mr. Willets who co-operated with Prof. Cook in getting the Post-Office Department at Washington to make an exception in favor of allowing live queen-bees to pass through the mails. This was of great advantage to bee-keepers as all know, hence a debt of gratitude was due Mr. Willets from the apiarian fraternity.

The Alsike Clover Leaflet consists of 2 pages, with illustrations, showing the value of Alsike clover, and telling how to grow it. This Leaflet is just the thing to hand to every farmer in your neighborhood. Send to the Bee Journal office for a quantity of them, and see that they are distributed where they will do the most good. Prices, postpaid, are as follows: 50 for 25 cents; 100 for 40 cents; or 200 for 70 cents.

Only One Cent a Copy for copies of the American Bee Journal before Jan. 1, 1896. We have them running back for about 10 years. But you must let us select them, as we cannot furnish them in regular order, and probably not any particular copies. Just send us as many one-cent stamps as you may want old copies, and we will mail them to you.

The McEvoy Foul Brood Treatment is given in Dr. Howard's pamphlet on "Foul Brood; Its Natural History and Rational Treatment." It is the latest publication on the subject, and should be in the hands of every bee-keeper. Price, 25 cents; or clubbed with the Bee Journal for one year—both for \$1.10.

OLDEST BEE PAPER IN AMERICA ESTABLISHED IN 1861

THE AMERICAN BEE JOURNAL

GEORGE W. YORK, Editor.

PUBLISHED WEEKLY BY

GEORGE W. YORK & COMPANY,

118 Michigan St., CHICAGO, ILL.

\$1.00 a Year—Sample Copy Sent Free.

[Entered at the Post-Office at Chicago as Second-Class Mail-Matter.]

Vol. XXXVI. CHICAGO, ILL., NOV. 12, 1896. No. 46.

EDITORIAL COMMENTS.

The Chicago Convention of the Illinois State Bee-keepers' Association, as announced last week, will be held Wednesday and Thursday of next week—Nov. 18 and 19. We have arranged with the New Briggs House—northeast corner of Fifth Ave. and Randolph St.—to hold the meeting in the club-room there. The hotel rates will be 75 cents each per night if two in a room; \$1.00 if one in a room. A most excellent restaurant is run in connection with the New Briggs House, where meals can be had, paying for what you order.

The railroad rates will be one and one-third for the round trip, taking advantage of the excursion rates of the Luther Leagues of America, which meet in Chicago Nov. 17 to 20. Don't fail to take a receipt from your local agent for your fare to Chicago, then when here you can get it signed so as to return for the one-third rate.

Now, we want to urge every bee-keeper within 200 miles (or further) from Chicago, to be present. This Chicago meeting ought to be next to the North American in point of attendance and importance. It can be made so if only bee-keepers near the city will come out. Indiana, Wisconsin and Michigan should also be well represented. At the last meeting held here—in January—Mr. Ernest R. Root, of Ohio, was present. He may be here next week. Dr. Miller will preside. Come, and bring along your questions for discussion.

The Work of the Honey-Bee has been a subject of investigation and analysis by the French Review of Natural Science, which finds that in fine weather a good worker can visit 40 to 80 flowers in 6 to 10 trips, collecting for all this labor one grain of nectar. The bee must visit 200 to 400 flowers in order to gather five grains. So under favorable circumstances it would take 14 days to gather 15 grains of nectar. A pound of honey will fill about 300 cells, and would require several years' labor of one bee to store it. So says the Frenchman.

Rival Bee-Papers and Their Policy.—In the last number of Gleanings, Editor Ernest R. Root has an item on the above subject, which we wish to reproduce, as it shows a condition of things for which we think there should be the highest commendation, if not of gratitude. Here is the item:

Two rival editors of two separate rival bee-periodicals took the train at Chicago, rode in the same car, slept in the same berth, in the same bed, ate at the same tables—in fact, were together much of the time for a whole week, and did not even quarrel, nor were they jealous of each other in convention. Suppose, for instance, that the two aforesaid editors were not on friendly terms; that they went to the convention

on separate roads; that they sat on opposite sides of the convention room; that whenever one proposed a policy the other would oppose it. The actual situation at the Lincoln convention—in fact, at every other in later times—has been the very opposite. At two different conventions the editors of the American Bee Journal and Gleanings have sat on the same chair. A very few delight in calling this condition of things "mutual admiration." Call it what they may, it is doing ten-fold more for the bee-keeping world than the other policy could give.

While Editor Root and ourselves are the keenest of rivals, yet we truly believe that each would spurn the success that might come through the overthrow of the other. Both of us are willing to "live and let live," and desire only to win honorably and in such a way as shall meet the approval of the best bee-keepers in the land!

If the doctrine of sincere "mutual admiration" were only believed in and lived up to, universally, this would be a very different world to live in. Instead of decrying such doctrine, all should strive to spread it until its beneficent influence might be felt, not only among bee-keepers, but among all mankind.

California Bee-keepers' Exchange.—Mr. J. H. Martin, the tireless Secretary of the Exchange, has this to say about it in the last number of the Rural Californian:

If anything pressages success in any enterprise, it is staying qualities. This seems to be the case with the California Bee-keepers' Exchange. In the face of a dry season and no honey to market, the members have held together remarkably well.

The Directors have held several meetings, and always at their own expense, and up to Sept. 1 not a dollar had been expended for individual expenses. There is every reason to believe that the Exchange will move forward to success, as several factors are at work which give encouragement.

We have the strongest reasons to believe that within the next two years every pound of our best grades of honey (table honey) will net the producer at least 6 cents per pound. The Exchange is working to accomplish this desirable end, and it can be accomplished if the bee-keepers will support the enterprise.

If the prediction made in the last paragraph above should prove true, we verily believe that it would result in better prices for honey produced by bee-keepers outside of California also. It seems to us that the Exchange idea, when once in working order, must be to the advantage of all, but particularly beneficial to those who are members of the Exchange. Every California bee-keeper should hasten to join at once, and share in the promised blessings. Send your name and address to Secretary J. H. Martin, 213 N. Main St., Los Angeles, Calif., and ask for instructions as to membership in the California Bee-keepers' Exchange.

Introducing Queens.—Young bee-keepers, of course, follow the printed directions for introducing queens that accompany them. But Rev. E. T. Abbott, in the October Canadian Bee Journal, says he knows "a more excellent way," and gives it in the following words:

When the queen reaches you, if ordered by mail from a queen-breeder, she will be enclosed, with some attendant bees, in a small wooden cage divided off into two or three compartments, one of which should contain food enough for her, and the bees which accompany her, for several days. Over the side of the cage will be tacked a piece of wire-cloth, and over this a thin board. The board should be removed and the queen examined at once to see if she is all right. Then examine and see if there is plenty of food in the cage to last the bees two or three days. Tack a piece of thin wood over the end of the cage which contains the candy, but leave the other end uncovered, so the bees in the hive where the queen is to be introduced can get at the wire-cloth. Pay no attention to the old queen until you are ready to release the new one, as per the directions given below.

Place the cage containing the new queen on top of the colony to which you want to introduce the queen. Place the

wire slide down, between two of the frames, so that the bees in the hive will have opportunity to communicate freely with the queen and bees in the cage, and thus enable them to become acquainted with each other. If the frames are covered with board, it will be better to substitute a heavy cloth for this until the queen is released. Leave the bees and queen in the cage on the hive for two or three days, and then open the hive and hunt out the old queen, being careful to disturb the bees as little as possible. As soon as the old queen is found, cage her or kill her at once and close up the hive as expeditiously as possible. Remove the board from over the candy, and turn back the wire-cloth just a little ways, so the bees in the hive can have access to the candy, and then place the cage back on the hive the same as before. Some cages have a plug in the end containing the food, so that it is only necessary to remove this to give the bees access to the candy. Close up the hive and leave it alone, and in a short time the bees will eat their way into the cage and release the queen and bees, and the work is done.

A colony treated in this way will not be queenless to exceed two or three hours, and but little time will be lost, as the new queen is apt to commence laying the next day. Queens can be introduced in this way at any season of the year, and there is no danger of loss if these instructions are carried out properly. Dealers, if they so desire, can keep several queens on a hive, in the way suggested above, for a week or more at a time, and then introduce any one of them to the colony whenever they wish, after the third day, as the bees would accept any one of the queens thus kept on the hive.

“The Principal Household Insects of the United States,” is the title of Bulletin No. 4 (New Series), just issued by the United States Department of Agriculture, Division of Entomology. The authors are Professors L. O. Howard and C. L. Marlatt. It also contains a chapter on “Insects Affecting Dry Vegetable Foods,” by F. H. Chittenden. Every housekeeper will want a copy of this Bulletin, as it not only tells all about the various pestiferous household insects, but also how to annihilate them. Send to the Department of Agriculture, Washington, D. C., for a free copy.

Bee-Keeping Editors.—Mr. D. Talmage, of Podunk, N. Y., has lots of sympathy for the editors of bee-papers, and tells about it in this language in the October Progressive Bee-Keeper:

One of the great trials of the editors of bee-papers, is that they are compelled to see more sham than any other part of the profession. Through every bee-journal office day after day go all the weaknesses of bee-keeping; all the vanities of yellow 5-banded bees that want to be puffed; all the revenges that want to be reaped; all the mistakes that want to be corrected; all the dull writers to be thought too smart; all the meanness that wants to get its wares noticed gratis (where meanness has been baptized and called religion, it is as deadly as the small-pox) in order to save the tax on the advertising column. All the bee-keepers who want to be set right, who never were right, and never will be; all the cracked-brained would-be professionals; through the editorial rooms all the follies and shams of bee-keeping are seen day after day, and the temptation is never to believe in God, man or woman. It is no surprise to me that in the profession there are some skeptical men. I only wonder that bee-keeping editors believe anything.

We fear that Mr. Talmage has under estimated the abilities of most bee-editors to withstand such a deluge as he enumerates. Why, they get accustomed to everything—even are compelled, some times, to endure the rasping dishonesty of a bee-keeper who will continue to take and read a bee-paper for two or more years, and then call the publisher a fool for having trusted him! But there is some satisfaction in the belief that such fellows will get their just deserts some day—if not in this world, then hereafter.

It is rather trying, after one has endeavored to be accommodating, to learn that the one receiving the favors was entirely unworthy. Still, we must not “weary in well doing,” “for in due time we shall reap if we faint not.”

Questions AND Answers

CONDUCTED BY

DR. C. C. MILLER, MARENGO, ILL.

[Questions may be mailed to the Bee Journal, or to Dr. Miller direct.]

Keeping Combs Over Winter.

The “A B C of Bee-Culture” recommends wintering bees on six frames, placing chaff division-boards in the hive in place of the two outside frames taken away. How are the combs removed from the bees to be kept free from moth-worms?

I have some old, odd-sized frames, very well stored with pollen, that I acquired in trade, and I am puzzled to know how to protect them until I can give them bees to occupy them. Thus far I have had them taken care of by placing them under a colony, with queen-excluding zinc between.

St. Louis, Mo.

W.

ANSWER.—There is probably no better way to keep the combs not in use than the way you have already used, namely, keeping them under a colony, and it is hardly necessary to have a queen excluder over them. If for any reason you do not want to keep them under the bees all winter, there need be little fear that any harm will come to them from worms from this time till late next spring, when you can again give them in charge of the bees. Or, after the winter is over, and they have been subjected to severe freezing, they may keep all right in a cellar, although it might be well to look occasionally to see whether worms had hatched in them.

Three Colonies in One.

I purchased a colony of bees last March, from which two swarms issued during the summer. The first swarm came off in June—a strong one—which I put into a large section of a hollow log. I intend getting the frame hives next spring. They stored, I should think, about 70 pounds of honey. The second swarm issued a few weeks later from the original hive. This was a small swarm. They were also lived in a hollow log. They stored but very little honey—about 17 pounds. The second swarm was robbed of all its honey, and having killed its queen, I moved their hive and placed the hive containing the strong colony in its place. The bees robbed of their queen were easily induced to enter the large hive. The original colony not having sufficient honey to winter on, was treated in the same manner. It was a small colony. Is there any likelihood of this being a success—three colonies in one hive, with sufficient honey to keep them?

Little Sioux, Iowa.

O. L. S.

ANSWER.—There is probably no reason why the combined colony may not do well. But after you have increased the number of your colonies to some extent, you will find you cannot repeat the same thing with the same result. You put a strong colony in the place of a weak colony, and the two united all right, the bees of the strong colony following their hive and accepting the new location. If a number of colonies had been sitting around, the result might have been somewhat detrimental to the strong colony. For instead of finding their own hive, they would probably have united with the colony that stood nearest their own old location.

Using Unfinished Sections Another Season—Leaving Supers of Sections on During Winter.

1. If I take sections filled, or partly filled, with nice white comb, and keep them so during the winter, fill supers with them and put them on the hives in the spring for the first flow of honey, will my customers complain of “fishbone?” Will honey put in a section from a “starter” be any nicer or more tender than the other? I never have any trouble getting bees started in supers, but if so, I could use some of them for baits. I have plenty of foundation, and do not want to spoil my honey crop by using these filled sections on a venture.

2. I have a good many supers still on the hives, filled and

partly filled with these same sections. I have always heretofore taken them off; however, I never had so many before, we having no fall crop this season on account of a prolonged drouth, and the bees have taken all the honey out of unfinished sections and carried it below. Would you advise taking all off, or leave them till spring and manipulate them just before the flow begins? I am about on an air-line due east and west, drawn from Savannah to Montgomery, Ala. Of course, I winter my bees on the summer stands. When taking off supers I simply put over the brood-chamber a piece of medium paste-board, and the top board or cover on that, and my bees come out all right in the spring. Some writers contend that they winter better to have the super on. Which is best?

Smithville, Ga., Oct. 21.

R. P. J.

ANSWERS.—1. The comb of the unfinished sections will be all right. The only question is about what is in the comb. If they are partly filled at the time of taking off, and some or all of the honey is left in them to be granulated, then perhaps the best thing is to melt them up. But if, before any granulation takes place, the bees have the opportunity to remove from them the least and last trace of honey, whether they have been previously extracted or not, then they will be all right to use again. Possibly it might do to keep them till spring and then let the bees clean them, but I don't know about that. I would hardly want to trust to such sections being sufficiently cleaned by putting them on or under a hive so that only the bees of one colony could get at them. They must be open plunder, so that there shall not be left the least particle, for you understand it is the little granules left that have the effect of starting all the contents of the section to granulating.

2. Leaving the supers on with unfinished sections through the winter may be all right for the bees, but it isn't all right for the sections. Better get them off right away and give the bees full sweep at them. If there are enough of them they can be put out so that there will be no hindrance to any number of bees getting at each section, but if only a few are put out in that way the bees will tear the combs. In that case put three or four supers in a pile and allow an entrance for only one bee at a time.

Dequeening and Italianizing — House-Apiary — Cyprian Bees.

1. We have read repeatedly of others getting a greater surplus of comb honey by dequeening at the beginning of the honey-flow, so we thought we would do likewise, and Italianize our apiary at the same time. So at the beginning of the honey-flow we killed off all the queens we wanted to supersede, and in five days we cut out all the cells they had started and gave them cells from our Italian breeders; they tore every one of them down, and so we gave them more, and they tore them down. Then we gave each a frame of eggs and larvae, and succeeded in getting them requeened, but they did not store a bit of surplus, while the others that we did not bother filled 3 or four supers each. What was the trouble?

2. We have a new bee-house about 300 feet from our apiary, where we wish to keep our bees permanently, summer and winter. When will be the best time to move them, with the least loss of bees? and how close can they be placed to each other with safety? They will be four inches from the ground, and the entrances all one way.

3. What do you know of the Cyprian bees? Would you advise our trying them?
Gazelle, Calif. J. W. G.

ANSWERS.—1. I confess I don't know enough to give a very satisfactory answer. It very often happens that bees tear down queen-cells that are given them, but I don't know why. Sometimes the plan is followed of putting the cell right in the place where one of their own has been cut out, and it is said to favor success. A good plan is to put the queen-cell in one of West's spiral cages. That leaves the end of the cell free for the queen to emerge, but prevents the workers from getting at the sides of the cells to gnaw them down.

2. Probably your best time will be in winter for moving your bees. If you could only know about such things beforehand, the right time would be immediately after a flight at the time when they will have the longest wait for the next flight. If all are moved from the old place the danger of loss will be much less than if some colonies remain at the old place. For bees returning to the old stand and not finding their own hive they will unite with one of the colonies nearest their old home, whereas if no hives are there they are more likely to return to the new place. It will be a good plan, if you can, to make such changes in the old place as to make

it look as unlike as possible. Another thing that will help, is to put a board up before the entrance of the new hive for some time. If a bee has some difficulty in getting out of its hive, it is more likely to mark the location. For the same reason, if the entrance is closed so as to prevent flight for a time, the locality is more likely to be marked.

The distance at which entrances can be placed with safety from each other depends somewhat on circumstances. The number of entrances has something to do with it. If a hundred entrances are placed in a row, there's a good deal more danger of mixing than if the number is reduced to three. Much depends upon surrounding objects. If there are no surrounding objects, 50 entrances all facing the same way and at equal distances from each other would need to be five or six feet apart, at the least. But if one or more trees are near the entrances, they will be of the greatest use. Even a post or a board set up in front of the entrances will help. Paint of different colors at the different entrances is said to be effective. Having the entrances in pairs will allow you to have the hives just half as far apart as if the entrances are at equal distances. For the sake of economy of room, the hives should be as close as they will stand, then have the entrances in pairs and use posts or boards to help mark the entrance if no trees or other objects are present.

Possibly it may be well to explain what is meant by having the entrances in pairs. Suppose the hives are 16 inches apart from center to center, and the entrances are four inches long and two inches high. If each entrance is at the middle of the hive, there will be a space of 12 inches between each two entrances. Say the entrances face east. Now instead of having the entrance of the hive at the north end at the middle of the hive, let it be at the south part, and let the entrance of the second hive be at the north part, the third at the south, the fourth at the north, and so on. Now you will see that the entrances of the first two will form a pair, those of the third and fourth a pair, and so on. If there is a space of four inches between the first and second entrances, then there will be 20 inches between the second and third entrances. A bee that belongs to the south one of a pair of entrances will never make the mistake of entering the north one. Even if there is only one inch of space between them, if a little board is nailed on in front so bees cannot readily crawl from one to the other, there will be no trouble.

3. The Cyprians are not at present in very great favor, and you will do well to stick to the Italians till you have first tried the Cyprians on a small scale.

Unsealed Stores for Winter.

I have been looking over my bees, and I find one colony of Italians with the frames nearly all full of unsealed honey. I have been giving them all the sugar they could use, and I am doing the best I can to get the honey ripened. I put a box over the hive to keep the heat up to help the bees to ripen the honey. I am still feeding them with sugar, and will do so as long as they can use it, or until I hear from you. It is one of my pet colonies.
Gillespie, Ill. J. C.

ANSWER.—As a rule, sealed stores are better than unsealed. The sealing helps keep out the air and moisture, and it is also an evidence that the contents of the cells are evaporated, for the bees do not generally seal the cells till the contents are well ripened. But it sometimes happens that the cells are sealed before the honey is fully evaporated, and in other cases the sealing is delayed for some time after the contents are ready to seal. So whether the bees will do as well on unsealed honey depends upon the character of the honey. Generally speaking, unsealed stores are not so good.

If the bees have all the stores they need, the best thing to help them to get them ripened is to stop feeding them more. At this season it's uphill business to ripen stores, and they ought not to be asked to do more of that sort of thing than is absolutely necessary.

Timothy Chaff for Packing.

How will timothy chaff do to pack around bees in chaff hives? It seems to me it would be first-class.
E. J. P.

ANSWER.—"After trying a great many kinds I have decided in favor of soft wheat chaff," says A. I. Root in "A B C of Bee-Culture." But if much more convenient to use timothy chaff, you will probably find it to answer quite well.

The "Premium" : A Good Watch Mailed Free !

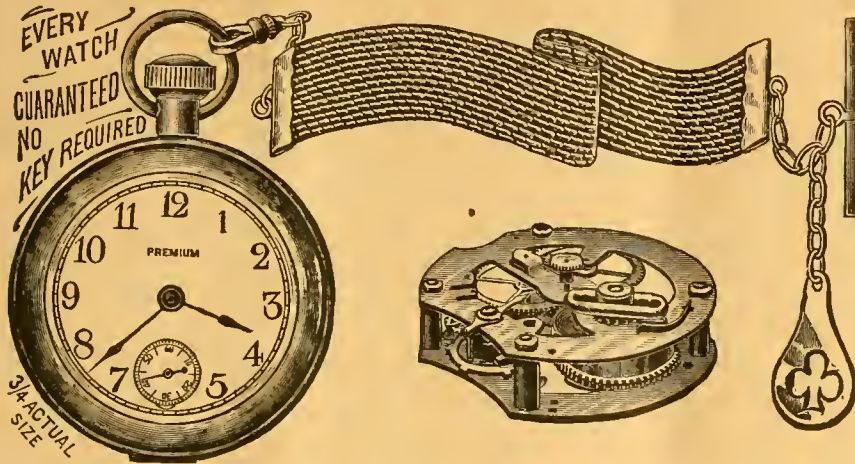

The movement of this Watch is regular American lever, lantern pinion, quick train, 240 beats per minute, three-quarter plate, short wind ; runs 30 hours to one winding ; dust cap over movement ; every movement fully timed ; regulated and guaranteed for one year, the same as a Waltham or Elgin ; nickel finish, heavy bevel crystal, and back pinion wind and set.

OUR OFFERS :—We will mail the above Watch for \$1.25 ; or club it with the Bee Journal for a year—both together for \$2.10 ; or we will send it free as a premium for getting **Three New yearly Subscribers** to the Bee Journal at \$1.00 each. The Watch is mailed from New York City, so please allow a few days before expecting your order to be filled.

GEORGE W. YORK & CO., 118 Michigan St., Chicago, Ill.

✦ MONEY SAVED IS MONEY GAINED. ✦

THE ROYAL UNION Life Insurance Company DES MOINES, IOWA.

The Iowa Policy

Is one that definitely promises to keep an accurate account with you ; credit your premiums and interest, charge the actual expense and mortuary cost, and hold the remaining funds subject to your order.
Agents Wanted.

JOHN B. KING, GENERAL AGENT,
Suite 513 First Nat'l Bank Bld'g,
20 Atf **CHICAGO, ILL.**
Mention the American Bee Journal.

THROAT AND LUNG DISEASES,
DR. PEIRO, Specialist
Offices: 1019, 100 State St.,
CHICAGO. Hours 9 to 4.
Mention the American Bee Journal.

DUQUESNE COLLEGE !

PENN AVE. AND EIGHTH ST.

PITTSBURG, PA.

Thorough Courses — Classical, Scientific, Normal, English, Commercial, Preparatory, and Ladies Literary. Efficient and experienced instructors. Day and Night sessions.

Send for Catalog.

Mention the American Bee Journal.

IF YOU WANT THE

—BEE-BOOK

That covers the whole Apicultural Field more completely than any other published, send \$1.25 to Prof. A. J. Cook, Claremont, Calif., for his

Bee-Keeper's Guide.

Liberal Discounts to the Trade.

Mention the American Bee Journal.

BASSWOOD Willow-Herb Extracted Honey.

We can furnish **Willow-Herb** Extracted Honey, in 60-pound tin cans, on board cars in Chicago, at these prices : 1 can, in a case, 8 cents per pound ; 2 cans in one case, 7½ cents ; 4 cans (2 cases) or more, 7¼ cents.

Basswood Honey in kegs holding about 270 lbs., net, at 7¼ cents. Cash must accompany each order.

A sample of the honey will be mailed to an intending purchaser, for 10 cents, to cover postage, packing, etc. We guarantee purity, and what we ship will be equal to sample.

Now it seems to us here is a splendid chance for any bee-keeper to supply his home demand after his own crop is all sold. Or, why not begin now to create a local honey-trade ? Order one 60-pound can first, and start out among your neighbors and friends, and see what you can do. You ought to get at least 15 cents per pound in 5-pound lots, or 50 cents for 3 pounds. Some may be able to do even better than that, though we think that enough ought to be sold at these prices to make a fairly paying business out of it. Give it a good trial. Push it. It may grow into a nice winter's work for you.

GEORGE W. YORK & CO., 118 Michigan Street, CHICAGO, ILL.

General Items.

Bees Did Exceedingly Well.

My bees have done nothing for me the past two years, but this year they did exceedingly well. I had 26 colonies, spring count, have increased to 37, and extracted about a ton and a half of honey. The honey is nearly all white, and I think it is the best quality of any I have ever produced.

Geo. S. PERRY.
Farmington, Minn., Nov. 3.

Report for the Season of 1896.

I commenced last June with two colonies of bees, increased to 18, and got 200 pounds of nice comb honey. The combined weight of the 18 is 1,420 pounds. My neighbor got nothing.

I never saw a book on bee-culture till 1872, when, by chance, I saw a mention of the American Bee Journal. I have since gotten several standard books. I can't do without the Bee Journal. It has been a friend indeed, to me. Sometimes a single number is worth more than \$1.00 to me.

W. D. CRAIG.
Hindsboro, Ill., Oct. 27.

Odor from New Honey-Cans.

On page 598, Dr. Miller asks a question regarding odor from new honey-cans. I have bought thousands of them from experienced manufacturers, and have had them fresh and clean, no odor, and not any honey affected. There is a distinct odor from kerosene cans, no matter as to how they are cleaned, and I should not advise any one to use them. New honey-cans, from new hands at the business, have a fault of using too much muriatic acid for dipping the ends, consequently there will be an acid odor.

M. H. MENDLESON.

Ventura, Calif.

Bee-Keeping in Indian Territory.

I have 7 colonies of bees, and got about 50 pounds of comb honey in all. I am not disgusted yet, although I have had many a tussle with my bees. I am just a boy, yet the folks call me "the bee-man," for a joke. I could not get along without the Bee Journal. There are only three colonies of bees in town besides mine. People have let the winter problem get away with their bees. It has been awfully dry here this season. I have started to use the standard 8-frame hive ; it is the thing I have been looking for, for a long time. My bees are in good condition for the winter ; they have from 50 to 60 pounds of honey per hive to winter on. I never take from the brood-chamber, as I think it a poor plan. It has been wet weather for a week or more here, but too late to do any good.

ROBT. WILLIAMSON.
Coalgate, Ind. Ter., Oct. 25.

Not Much Swarming this Year.

I had 10 colonies of bees last spring, in 10 and 12 frame hives, 12 inches deep. I had only two natural swarms, and made two artificial swarms, and had one swarm to come from somewhere else and settle right over my other hives. I saved them, so I now have 15 colonies

"THE LITTLE GIANT BOOK-KEEPER"

BOOK-KEEPING

AT A GLANCE.

By Expert J. T. BRIERLEY.

A SIMPLE AND CONCISE METHOD OF PRACTICAL BOOK-KEEPING.



With instructions for the proper keeping of Books of Accounts and Numerous Explanations and Forms used in a Commercial business; showing an ENTIRE SET OF BOOKS BASED UPON ACTUAL TRANSACTIONS.

How to take off a Trial Balance sheet; and finally CLOSE AND BALANCE ACCOUNTS; EQUATION OF PAYMENTS; METRIC SYSTEM OF WEIGHTS and Measures.

Containing 144 pp., size, 5 x 8 3/4 inches, bound in Flexible Russia, indexed, 75 cents each, postpaid.

Special Offer : We will mail this book free as a premium to any one sending us two New Subscribers to the Bee Journal for one year (with \$2.00), and also send a copy of the premium book "Bees and Honey" to each of the new subscribers; or we will club the book with the Bee Journal for a year—both for \$1.60.

GEORGE W. YORK & CO.,
CHICAGO, ILLS.

40,000.

THE Nebraska Farmer

Has made a contract with the Nebraska Club, to print for them 40,000 copies over and above the regular weekly issue, each month for six months, of reliable information about Nebraska.

If interested, send for free copy, to
MR. CHAS. E. WILLIAMSON,
Secretary Nebraska Club,
OMAHA, NEBR., or

Nebraska Farmer Co.
Lincoln, Nebr.

44A13 Mention the American Bee Journal.

For a knife that will cut a horn without crushing, because it cuts from four sides at once get

THE KEYSTONE DEHORNER

It is humane, rapid and durable. Fully warranted. HIGHEST AWARD AT WORLD'S FAIR. Descriptive circulars FREE. A. C. BROSIUS, Cochransville, Pa.

40E13t Mention the American Bee Journal.

Bee-Keepers' Photograph.—We have now on hand a limited number of excellent photographs of prominent bee-keepers—a number of pictures on one card. The likeness of 49 of them are shown on one of the photographs, and 121 on the other. We will send them, postpaid, for 30 cents each, mailing from the 121 kind first; then after they are all gone, we will send the 49 kind. So those who order first will get the most "faces" for their money. Send orders to the Bee Journal office.

Bee-Keeper's Guide—see page 733.

in all. One of my uncles, living a mile from me, had 15 colonies in the spring, and never had a swarm. Another neighbor had 36 colonies, and had no swarms. Also another man, living nine miles away, told me that he had 50 colonies, and had no swarms the past season.

It was very wet here in the spring and summer, and bees did no good until fall. My bees have done well this fall, though they have worked very curiously. They have filled the body of their hives to the bottom with honey, and capped it over, and but 4 or 5 of the colonies put anything in the upper story. I have 7 pure Italian and 8 hybrid colonies, and the former averaged fully double what the hybrids have in increase of honey and brood. I had one Italian colony that never swarmed; before I robbed it, it weighed 121 pounds gross.

W. W. BUCY.

Calloway Co., Ky., Nov. 2.

Very Poor Season.

I have 27 colonies, and secured 725 pounds of comb honey. We had a very poor season this year.

ALFRED E. SMITH.

Mt. Vernon, Ind., Nov. 2.

Honey Season Almost a Failure.

The honey season was almost a failure here this year. I got but a little surplus honey. It was too wet for the bees to gather honey. They got about enough from fall bloom for winter stores.

JACOB FRAME.

Sutton, W. Va., Oct. 27.

Report from Southeastern Nebraska.

The honey season is now over for 1896, and is about an average annual yield. It was a little too wet this year, and a little too dry last year. It should be remembered that many of our honey-plants will not secrete honey in a wet season, and I think that sweet clover secretes more nectar in a dry season.

I had 45 colonies, spring count, in my home apiary, and increased to 100, which stored 2 1/2 tons of comb honey, which I have mostly sold at 15 cents per pound, making \$750 from honey, and \$275 in increase of bees; taking out \$100 for expenses, leaves me \$925—a little over \$20 profit on each colony, or over 400 per cent.

My out-apiaries have paid from 10 to 50 per cent. profit. Some others here have done better than this, but many not so well. One colony stored 175 pounds; another swarmed once and stored 120 pounds. I believe the 10-frame hives the best for this community—at least I got the best results from them.

J. L. GANDY.

Richardson Co., Nebr., Oct. 28.

How to Sell Your Honey Crop.

I will tell how I disposed of my crop of honey this year, and it worked to perfection.

In the first place, I made up all my shipping-cases and then branded them with a rubber stamp with my name and address on each case. Then I managed to get the names of a few of the best retail merchants in four different cities. I then wrote to each one, asking them if they handled honey in their business; if so, I would be pleased to send them a

THE ADVANCE AGENT OF HEALTH

WARNER'S SAFE CURE

FOR

KIDNEY AND LIVER

BRIGHT'S DISEASE; URINARY DISORDERS; FEMALE COMPLAINTS; GENERAL DEBILITY; MALARIA,

AND ALL DISEASES CAUSED BY DISORDERED BILIOUS AND LIVER

AND SO ON BY THE BEST PHYSICIANS

NOT GENUINE UNLESS CUT OF SAFE IS ON LABEL UNLESS CUT OF SAFE IS ON WRAPPER

KEEP AWAY FROM CHILDREN

WARNER'S SAFE CURE CO.

ROCHESTER, N.Y.

Miniature Fac-Simile.

Mention the American Bee Journal.

NEVER BEATEN

in all the many shows in which it has participated, there must be something in the superiority claims of the RELIABLE INCUBATOR. Self regulating, entirely automatic, you put in the eggs, the Reliable does the rest. All about this and many things of value to the poultry man in our new book. Send 10 cts. for it. RELIABLE INCUBATOR & BROODER CO., QUINCY, ILLS.

36E17t Please mention the Bee Journal.

CORRECT MANNERS: HOW TO BEHAVE IN SOCIETY

Containing clear and concise directions for correct manners and usages of polite society. Many people have been misjudged for years simply because they had neglected to perform some little polite act at the proper time; many young men and women have lost the opportunities of a life-time on account of their ignorance of some trifling customary rule of Society. Our BOOK tells all about it. 166 pages. Russia. Red Edges. Price, 75 cts.



Special Offer : We will mail this book free as a premium to any one sending us two New Subscribers to the Bee Journal for one year (with \$2.00), and also send a copy of the premium book "Bees and Honey" to each of the new subscribers; or we will club the book with the Bee Journal for a year—both for \$1.60.

INFORMATION GOLD!

Worth its Weight in Gold!

For your name and address on a postcard, we will tell you how to make the best wire fence on earth, horse-whip, bull-strong and pig-tight, at the actual wholesale cost of wire. Kitzelman Bros. Box B. Ridgeville, Ind.

48E1f Mention the American Bee Journal.

sample case showing what kind of honey I had for sale, and the style of putting it up. I gave them the price that I asked for the honey, f. o. b. Well, the result was, in three weeks from the time I wrote them, all of my honey was sold, and I got just what I asked for it. There is hardly a mail comes in that I don't get from one to three letters asking me to give prices for my honey in large quantities. After shipping a party, down in Indiana, one shipment, he wrote me asking for the exclusive right to sell my honey in that city.

I think it pays to take pains in putting up our honey for market.

WM. CRAIG.

Sagiaw Co., Mich., Oct. 31.

Better Season than for Several Years.

I can report the season of 1896 as considerably better than any of the three previous ones for western Iowa. Last fall was the driest one I can remember, too, so I don't think the theory of rainfall or snow the previous fall can be depended upon to foretell a failure or success of the honey-yield for the next season. I think the time that dry weather hurts the honey crop worst is in spring—early spring; we must have rain then for a crop.

I had intended, for two years, to attend the convention, if it should be held at Lincoln, and then at the last moment I had to give it up. Well, we Iowa bee-keepers are pretty well used to disappointments, so I guess we can stand this one.

I put into winter quarters, last fall, 28 colonies. In spring I had 5 queenless ones, and of the 23 remaining 5 were so weak at the opening of the honey season that I did not expect anything from them, but did get 250 pounds of extracted from them. And from the 18, which were only medium in strength, I got 1,100 sections, with an average of about 15 ounces of honey in each. I had only five natural swarms and two that came out and went back. I have an increase of nine colonies altogether, from the 23.

There is more white and sweet clover in the country than there has been for four or five years; so next year bids fair to be a good one.

E. S. MILES.

Denison, Iowa, Oct. 30.

An Arkansas Bee-Experience.

Take out the satisfaction that one experiences when one is conscious of having learned something, and my experience in the "bee-business" is worth nothing to me, let alone to the readers of the Bee Journal. However, inasmuch as the editor has invited contributions, he shall have mine.

Last fall I bought eight box-hives of bees—took them in on bad doctor bills; I mean the bills were bad, not the doctor. (Pardon me if I parenthetically state that I am not as good as the honey-eating doctor in California, who cures folks without medicine.)

After bringing them home, I divided one and made two colonies, thus making nine in all. I transferred two then, and the other seven last spring. This work taught me the great advantage of experience over "book larnin'." I learned that the short methods of transferring are utterly worthless to new hands; that few old combs are worth trying to save; that pasteboard strips to fasten

A HANDY TOOL-HOLDER!

Sent by Express, for \$1.50; or with the Bee Journal one year—both for \$2.00.

Every Manufacturer, Miller, Carpenter, Cabinet Maker, Machinist, Wheelwright and Quarryman, Farmer, or any one using a grindstone, should have one of these Tool-Holders. One boy can do the work of two persons, and grind much faster, easier and with perfect accuracy. Will hold any kind of tool, from the smallest chisel to a draw shave or ax. Extra attachment for sharpening scythe blades included in the above price. The work is done without wetting the hands or soiling the clothes, as the water flows from the operator. It can be attached to any size stoue for hand or steam power, is always ready for use, nothing to get out of order, and is absolutely worth 100 times its cost.

No farm is well-equipped unless it has a Tool-Holder. Pays for itself in a short time.

How to Use the Holder.

DIRECTIONS.—The Tool is fastened securely in the holder by a set-screw and can be ground to any desired level by inserting the arm of the Holder into a higher or lower notch of the standard. While turning the crank with the right hand, the left rests on a steady the Holder; the Tool is moved to the right or left across the stone, or examined while grinding, as readily and in the same way as if held in the hands.

For grinding Round-Edge Tools, the holes in the standard are used instead of the notches.

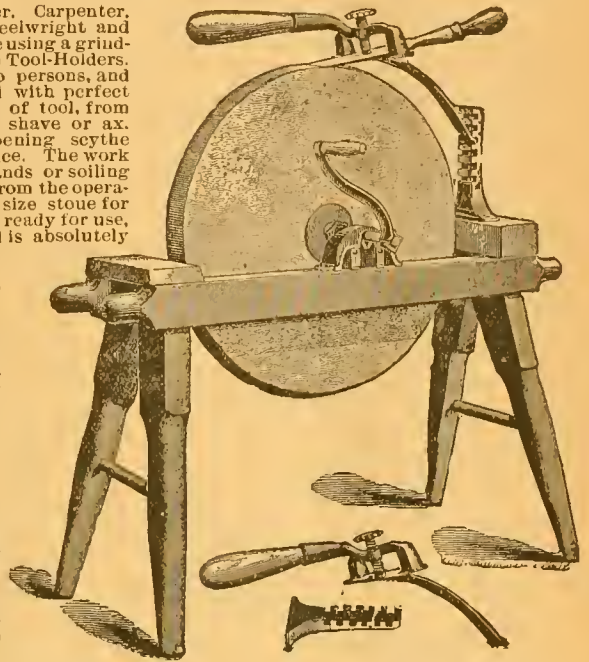

Address, GEORGE W. YORK & CO.,

CHICAGO, ILL.

California

If you care to know of its Fruits, Flowers Climate or Resources, send for a Sample Copy of California's Favorite Paper—

The Pacific Rural Press

The leading Horticultural and Agricultural paper of the Pacific Coast. Published weekly, handsomely illustrated, \$2.00 per annum. Sample Copy Free.

PACIFIC RURAL PRESS, 220 Market St., - SAN FRANCISCO, CAL.

MUTH'S HONEY EXTRACTOR PERFECTION Cold-Blast Smokers,

Square Glass Honey Jars, Etc.

For Circulars, apply to CHAS. F. MUTH & SON, Cor. Freeman & Central Aves., Cincinnati, O. Send 10c for Practical Hints to Bee-Keepers.

Mention the American Bee Journal.

COMB FOUNDATION!

Wax always wanted for Cash or in Exchange for Fdn. or other Supplies. My trade is established on Low Prices and the merit of my Foundation. Orders filled promptly.

WORKING WAX INTO FDN. BY THE LB. A SPECIALTY. Wholesale prices to dealers and large consumers. Send for Prices and Samples to—GUS DITTMER, AUGUSTA, WIS. Reference—Augusta Bank. 1 Atf

Mention the American Bee Journal.



ONE MAN WITH THE UNION COMBINATION SAW

Can do the work of four men using hand tools, in Rippling, Cutting-off, Miling, Rabbeting, Grooving, Gaining, Dadolng, Edging-up, Jointing Stuff, etc. Full Line of Foot and Hand Power Machinery Sold on Trial. Catalogue Free.

SENECA FALLS MFG. CO., 46 Water St., SENECA FALLS, N. Y. 1A1y Mention the American Bee Journal.

SOLID COMFORT

would be a good name for this chair—strong, durable, handsome. It is one of the free premiums for club sales of our Standard Teas, Coffees, Spices, Etc. You can get also a set dishes, lamps, silverware, clocks, watches, bicycles, albums, &c. Honest goods and fair prices have increased our stores from 1 to 93. No experience needed. All particulars and plans in our free catalogue. GRAND UNION TEA CO., 206 West State St., ROCKFORD, ILL.

Please mention the American Bee Journal when responding.

NOW WE HAVE IT!

GLEASON'S

HORSE-BOOK!

The Only Complete and Authorized Work
by America's King of Horse-Trainers,

PROF. OSCAR R. GLEASON,

Renowned throughout America and recognized by the United States Government as the most expert and successful horseman of the age. The whole work comprises History, Breeding, Training, Breaking, Buying, Feeding, Grooming, Shoeing, Doctoring, Telling Age, and General Care of the Horse.

You will know all
about a horse
after you
have
read
it.

No one can fool you
on the age of a
horse after
you have
read
it.

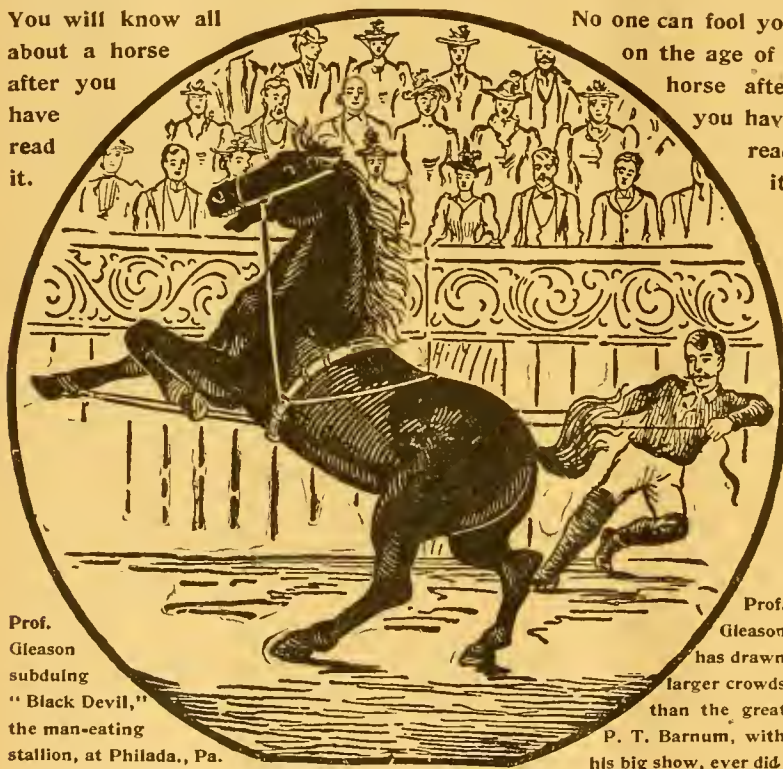

Prof. Gleason subduing "Black Devil," the man-eating stallion, at Philada., Pa.

Prof. Gleason has drawn larger crowds than the great P. T. Barnum, with his big show, ever did

416 Octavo Pages—173 Striking Illustrations.

Produced under the direction of the U. S. Government Veterinary Surgeon.

In this book Prof. Gleason has given to the world for the first time his most wonderful methods of training and treating horses

100,000 SOLD AT \$3.00 EACH.

But we have arranged to supply a limited number of copies to our subscribers **absolutely free.** First come, first served.

Here are Our Offers of this Great Book.

Regardless of the fact that thousands upon thousands of these books in cloth binding have been sold at \$3.00 each, we are enabled to, and will for a limited period, send a heavy-paper-bound copy FREE as a premium to our present regular subscribers for sending us **ONE NEW Subscriber** to the Bee Journal for a year at \$1.00; or we will mail the book and the Bee Journal for a year to any one sending us \$1.60. Address,

GEORGE W. YORK & CO.,

118 Michigan Street,

CHICAGO, ILL.

comb in the frames are better than wood strips or clamps—more easily made, and if left on will be taken off by the bees, and hold just as firmly; and many other things I learned that will do me good hereafter.

At this point let me say, while the books say that spring uniting hardly pays, I think it will, for while I was transferring in the spring, one colony left the new hive and went to a neighbor close by—the two making a strong colony. This one—composed of two—with the one I had transferred the fall before, were the only two in the eight which produced any surplus honey.

Arkansas generally was poor for honey this year, and some of the colonies came so nearly starving out that I had to unite until I now have but six out of the nine. My supplies cost me about \$25—this includes hives, foundation, smoker, etc., not the bees. I fed several dollars worth of sugar during the summer, and this fall I sent for six Italian queens, and introduced them, at a cost of \$4.00. For all this expense and my trouble, I have taken about 60 pounds of nice honey, and have six colonies of beautiful Italian bees well stocked with fall honey for winter.

You will see that so far the "business" has been one of considerable loss to me. I did not have a single swarm the entire season. I dread next season, as I fear the loss of some of my fine queens.

Let me close this letter by saying that I have never invented anything, and never expect to, but some man will do the bee-fraternity a lasting benefit by giving us a better super arrangement than is now in use.

I am coming again.

C. S. ROBERTS, M. D.
Lamar, Ark., Oct. 30.

Good White Clover Flow.

The white clover honey-flow was good here in Humboldt county, but the fall flow did not come.

I am much pleased with the Bee Journal.
J. W. SADLER.
Bradgate, Iowa, Oct. 22.

The Connecticut Convention.

The Connecticut bee-keepers met in convention Oct. 21, at the Capitol, at Hartford, Pres. G. H. Yale presiding. The day was rainy, and of the 37 members only 10 ventured out, yet it was a good meeting socially.

Although a poor year for a honey crop, yet no one seemed discouraged, and all spoke hopefully of the future. The fact is, the bee-keepers of Connecticut are a hard lot to discourage—they work on from year to year, never expecting much, therefore never disappointed. There is plenty of honey in the Connecticut flowers, and with the co-operation of the weather bureau there is no doubt our State would make a record for honey-production.

The morning session was principally devoted to discussion on the breeding, superseding, clipping, life, etc., of queens, and the afternoon to a variety of topics, practical and otherwise.

The subjects of wintering in single-walled hives and of top ventilation being warmly discussed, with the majority in favor of no ventilation at the top.

The non-swarming bees got a set-back

this year, in short, they fully demonstrated that such an insect does not exist in the State. They have broken all records, and swarmed from early morn to dewy eve, and from May to November. After the close of the meeting the question (not on the program) of how to induce the bee-keepers to attend the conventions in larger numbers, was considered. Numbers would add greatly to the interest of the meetings. If the year has been poor and the crop light, there are no better places than the conventions to talk over the failures, and if the season has been one of success, what is more stimulating than a union jubilee?

Next May we hope to shake the hand of every bee-keeper in the Nutmeg State.
MRS. W. E. RILEY, Sec.
Waterbury, Conn., Nov. 3.

PAID FOR Cash Beeswax

For all the **Good, Pure Yellow Beeswax** delivered to our office till further notice, we will pay 24 cents per pound, CASH; or 27 cents for whatever part is exchanged for the Bee Journal, Honey, Books or Seed, that we offer. If you want **cash, promptly**, for your Beeswax, send it on at once. Impure wax not taken at any price. Address as follows, very plainly,

GEO. W. YORK & CO.
118 Michigan st., CHICAGO, ILL.

HATCH Chickens BY STEAM—
With the **MODEL EXCELSIOR Incubator**
Simple, Perfect, Self-Regulating. Thousands to successful operation. Lowest priced first-class hatcher made.
Send for circulars. GEO. H. STAHL, 114 to 122 S. 6th St. Quincy, Ill.



44A26t Mention the American Bee Journal

THROAT AND LUNG DISEASES.
DR. PEIRO, Specialist
Offices: 1019, 100 State St.
CHICAGO. Hours 9 to 4.
Mention the American Bee Journal

Payne's Business Letter Writer

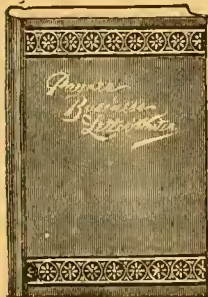

and Manual of **Commercial Forms.**—Containing specimen Letters on all possible business topics, with appropriate answers. Containing general information with regard to business matters, the rules for punctuation, the abbreviations most used in the mercantile world, a dictionary of mercantile terms, a table of synonyms, and other information which may be of value to the business man. New edition, revised and enlarged. 216 pages, Extra Cloth, 75 cts.

Special Offer: We will mail this book free as a premium to any one sending us two New Subscribers to the Bee Journal for one year (with \$2.00), and also send a copy of the premium book "Bees and Honey" to each of the new subscribers; or we will club the book with the Bee Journal for a year—both for \$1.60.

GEORGE W. YORK & CO.,
CHICAGO, ILLS
Mention the American Bee Journal.

HONEY and BEESWAX

MARKET QUOTATIONS.

The following rules for grading honey were adopted by the North American Bee-Keepers' Association, and, so far as possible, quotations are made according to these rules:

FANCY.—All sections to be well filled; combs straight, of even thickness, and firmly attached to all four sides; both wood and comb unsoiled by travel-stain, or otherwise; all the cells sealed except the row of cells next the wood.

No. 1.—All sections well filled, but combs uneven or crooked, detached at the bottom, or with but few cells unsealed; both wood and comb unsoiled by travel-stain or otherwise.

In addition to this the honey is to be classified according to color, using the terms white, amber and dark. That is, there will be "fancy white," "No. 1 dark," etc.

Chicago, Ill., Nov. 7.—Fancy white, 12@13c.; No. 1, 11c.; fancy amber, 9@10c.; No. 1, 7@9c.; fancy dark, 8@9c.; No. 1, 7c. Extracted, white, 5@7c.; amber, 5@6c.; dark, 4½@5c. Beeswax, 26@27c.

The market up to, and at this time, is dull. The volume of sales is unusually small for this season of the year; especially is this true of comb.

Philadelphia, Pa., Nov. 7.—Fancy white comb, 13-14c.; No. 1 white, 11-12c.; fancy amber, 10-11c.; dark, 8-9c. Extracted, white, 6-8c.; amber, 4-5c.; dark, 3-4c. Beeswax, 26c. Comb honey arriving freely and market overstocked at present.

Detroit, Mich., Nov. 7.—No. 1 white, 12-13c.; fancy amber, 10-11c.; No. 1 amber, 9-10c.; fancy dark, 8-9c. Extracted, white, 5½-6c.; amber, 5-5½c.; dark, 4-5c. Beeswax, 24-25c.

Indianapolis, Ind., Nov. 7.—Fancy white, 14-15c.; No. 1 white, 12-13c. Extracted, white, 6-7c. Beeswax, 22-25c. Demand is fair for grades quoted, but no demand for inferior grades.

St. Louis, Mo., Nov. 7.—Fancy white, 13@14c.; No. 1 white, 12@13½c.; fancy amber, 11@11½c.; No. 1 amber, 10@10½c.; fancy dark, 8@9c.; No. 1 dark, 7@7½c. Extracted, white, in cans, 5c.; in barrels, 4@4½c.; amber, 3@3½c.; dark, 2½@3c. Beeswax, 19@20c.

Very little honey coming in at present, and the weather is too warm to handle to advantage if it were here.

New York, N. Y., Nov. 7.—Fancy white, 12c.; off grades, 10@11c.; buckwheat, 8@9c. No change in extracted. Beeswax firm at 26@27c.

The market is well supplied with comb honey of all grades and styles. Fancy white is in fair demand, while off grades white and buckwheat are moving off rather slowly.

Albany, N. Y., Nov. 7.—Fancy white, 12-13c.; No. 1, 11-12c.; fancy amber, 9-10c.; No. 1 dark, 8-9c. Extracted, white, 6-7c.; dark, 4-5c.

The receipts of both comb and extracted honey are very large, and prices are somewhat lower. We have an ample stock of all styles except paper cartons weighing less than a pound.

Cincinnati, Ohio, Nov. 7.—Comb honey, 10@14c., according to quality. Extracted, 3½@6c. Demand is slow for all kinds of honey, while the supply is good.

Beeswax is in good demand at 20@25c. for good to choice yellow.

San Francisco, Calif., Nov. 7.—White comb, 10c.; amber, 7½-9c. Extracted, white, 5-5½c.; light amber, 4½-5c.; amber colored and candied, 3½-4½c.; dark tulle, 2½-3c. Beeswax, fair to choice, 24-27c.

Cleveland, Ohio, Nov. 7.—Fancy white, 14½@15c.; No. 1 white, 12½@13c. Extracted, white, 6@7c.; amber, 4½@5½c. Beeswax, 22@25c.

There is not very much honey in our market. Selling rather slow. Demand beginning to be a little better. Think trade will be fair in this line this fall.

Milwaukee, Wis., Nov. 7.—Fancy white, 14-15c.; No. 1, 12-13c.; No. 1 amber, 8-10c. Extracted, white, 6-7c.; amber, 5-6c.; dark, 4-5c. Beeswax, 22-24c.

New crop of honey begins to come forward. The demand is very poor and quotations almost nominal. Weather is very warm and the consumption of honey is very small. Plenty of fruit, and hence the appetite is satisfied with same in preference. Later on we expect an improved demand for honey of all kinds.

Minneapolis, Minn., Nov. 7.—Fancy white, 12½c.; No. 1 white, 10@11c.; fancy amber, 9@10c.; No. 1 amber, 8@9c.; fancy dark, 7@8c.; No. 1 dark, 6-8c. Extracted, white, 5½@6½c.; amber, 5@5½c.; dark, 4@5c. Beeswax, 23@26c.

The demand for both comb and extracted is very quiet, and for the latter, nominal. The hot weather of the past week or so has checked demand for comb honey.

Kansas City, Mo., Nov. 7.—Fancy white comb, 15c.; No. 1 white, 13@14c.; fancy amber, 12-13c.; No. 1 amber, 11-12c.; fancy dark, 10-11c.; No. 1, 8-10c. Extracted, white, 6-6½c.; amber, 5 5/8c.; dark, 4-4½c. Beeswax, 22-25c.

Buffalo, N. Y., Nov. 7.—Strictly fancy comb, 1-pound, 12-13c.; fair to good, 9-10c.; dark, 7-8c.

Demand is much better for fancy, but common stock is very dull at any price.

Boston, Mass., Nov. 6.—Fancy white, 13-14c.; No. 1, 11-12c. Extracted, white, 6-7c.; amber, 5-6c. Beeswax, 25c.

List of Honey and Beeswax Dealers.

Most of whom Quote in this Journal.

Chicago, Ills.

R. A. BURNETT & Co., 163 South Water Street.

New York, N. Y.

HILDRETH BROS. & SEGELKEN,
120 & 122 West Broadway
CHAS. ISRAEL & BROS., 486 Canal St.

Kansas City, Mo.

O. C. CLEMOMS & Co., 423 Walnut St.

Buffalo, N. Y.

BATTERSON & Co., 167 & 169 Scott St.

Hamilton, Ills.

CHAS. DADANT & SON.

Philadelphia, Pa.

WM. A. SELSER, 10 Vine St.

Cleveland, Ohio.

WILLIAMS BROS., 80 & 82 Broadway.

St. Louis, Mo.

WESTCOTT COM. Co., 213 Market St.

Minneapolis, Minn.

S. H. HALL & Co.

Milwaukee, Wis.

A. V. BISHOP & Co.

Boston, Mass.

E. E. BLAKE & Co., 57 Chatham Street.

Detroit, Mich.

M. H. HUNT, Bell Branch, Wayne Co., Mich.

Indianapolis, Ind.

WALTER S. POWDER, 162 Massachusetts Ave.

Albany, N. Y.

CHAS. McCULLOCH & Co., 380 Broadway.

Cincinnati, Ohio.

C. F. MUTH & SON, cor. Freeman & Central avs.

Wanted

—To buy quantity lots of Fancy and No. 1 White Honey at prices to suit the times. B. WALKER, 45 A Ewart, Mich.

WHEN ANSWERING THIS ADVERTISEMENT, MENTION THIS JOURNAL.

READERS

Of this Journal who write to any of our advertisers, either in ordering, or asking about the Goods offered, will please state that they saw the Advertisement in this paper.

Bottom Prices

**BRING US BIG TRADE.
GOOD GOODS KEEP IT.**

If you want the best supplies that can be made at a little less cost than you can buy the same goods for elsewhere, write to us for low prices. 1896 Catalogue now ready—ask for it and a free copy of *The American Bee-Keeper* (36 pages).

Address,
THE W. T. FALCONER MFG. CO.,
JAMESTOWN, N. Y.
Mention the American Bee Journal.

Honey-Clovers & Buckwheat SEED FOR SALE.

We have made arrangements so that we can furnish seed of several of the Clovers and Japanese Buckwheat, by freight or express, at the following prices, cash with order:

	5lb	10lb	25lb	50lb
Alsike Clover.....	\$.70	\$1.25	\$3.00	\$ 5.75
Sweet Clover.....	.65	1.20	2.75	5.00
White Clover.....	1.25	2.00	4.50	8.00
Alfalfa Clover.....	.65	1.10	2.70	5.00
Crimson Clover....	.55	.90	2.00	3.50
Jap. Buckwheat....	.20	.35	.90	1.25

Prices subject to market changes.
Add 25 cents to your order, for cartage, if wanted by freight.
Your orders are solicited.

GEORGE W. YORK & CO.,
CHICAGO, ILLS.

BEGINNERS.

Beginners should have a copy of the *Amateur Bee-Keeper*, a 70-page book by Prof. J. W. Rouse. Price 25 cents; if sent by mail, 28c. The little book and the *Progressive Bee-Keeper* (a live, progressive 28-page monthly journal) one year, 65c. Address any first-class dealer, or

LEAHY MFG. CO., Higginsville, Mo.
WHEN ANSWERING THIS ADVERTISEMENT, MENTION THIS JOURNAL.

HONEY-JARS!

1-lb. square Flint Jars, with Corks, \$4.85 per gross. Including Labels, name and address on same, \$5.10 per gross.

A Full Line of Supplies on hand.
Catalogue.

I. J. STRINGHAM,
105 Park Place. NEW YORK, N. Y.
APIARY—Glen Cove, L. I.

Mention the American Bee Journal.

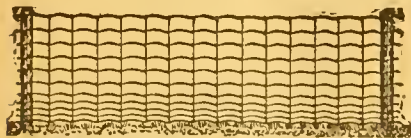

After Election, What ?

Why look after your fences, of course, and prepare for the good times coming. There will yet be time to erect a string of *Page* and watch it give and take through the winter.

PAGE WOVEN WIRE FENCE CO., Adrian, Mich.

Mention the American Bee Journal.

READERS Of this Journal who write to any of our advertisers, either in ordering, or asking about the Goods offered, will please state that they saw the Advertisement in this paper.

BEE SWAX WANTED

—FOR—

Foundation Making.

Send For OUR CATALOGUE,

SAMPLES OF FOUNDATION,

ADVICE TO BEGINNERS, Etc.

Address,

CHAS. DADANT & SON,

HAMILTON, ILL.

WHEN ANSWERING THIS ADVERTISEMENT, MENTION THIS JOURNAL.

Ask Your Friends to Take This Journal.

* Extracted Honey *



Finest Quality. Basswood and Clover.

2 60-lb. cans in case 7c. per pound. 1 60-lb. can in case, 8c. per pound. A sample by mail, 10 cts. **POUDER'S Honey-Jars and Complete Line of Supplies.** Catalogue Free.

WALTER S. POWDER,
162 Mass. Avenue. INDIANAPOLIS, IND.

PATENT WIRED COMB FOUNDATION



Has No Sag in Brood-Frames

Thin Flat-Bottom Foundation

Has No Fishbone in the Surplus Honey.

Being the cleanest is usually worked the quickest of any Foundation made

J. VAN DEUSEN & SONS,
Sole Manufacturers,
Sprout Brook Montgomery Co., N. Y.

A LARGE BOOK FREE.

To every new subscriber who sends us \$1.00, we will send him our journal—

Gleanings in Bee-Culture,

one year, and the book by A. I. Root, containing 190 pages, size 6½x9½, entitled

What to Do, and How to be Happy while Doing It,

postpaid. The regular price of this work is 50 cents alone.

If you prefer, the journal may be sent to a friend, and you can keep the book for yourself.

THE A. I. ROOT COMPANY,
MEDINA, OHIO.

AMERICAN BEE JOURNAL

DEVOTED EXCLUSIVELY TO THE INTERESTS OF HONEY PRODUCERS

ESTABLISHED IN 1861
THE OLDEST BEE-PAPER IN AMERICA

Published Weekly, at \$1.00 per annum.

Sample Copy sent on Application.

36th Year.

CHICAGO, ILL., NOVEMBER 19, 1896.

No. 47.

CONVENTION PROCEEDINGS

[Continued from page 726.]

THE REPORT IN FULL

OF THE

Twenty-Seventh Annual Convention
OF THE

North American Bee-Keepers' Association,

HELD AT

LINCOLN, NEBR., October 7 and 8, 1896.

BY DR. A. B. MASON, SECRETARY.

THURSDAY AFTERNOON SESSION.

At 2 o'clock the members of the Association were taken through the University buildings and grounds by the Chancellor of the University.

The convention assembled at 3:30, with Pres. Root in the chair.

A New Union or Amalgamation.

Pres. Root—As we are behind, we must hasten. The first thing is the report of the committee appointed to consider the papers of Prof. Cook and Mr. Newman, read yesterday.

Dr. Mason (Chairman of Committee)—Mr. President, your committee have spent considerable time in considering this matter, and have called together a goodly number of those here present to aid us with their suggestions, and without any material change from what has been prepared by correspondence and consultation before the gathering of this convention, we submit the following, and as it is somewhat difficult to decipher, if there is no objection, in order to save time, I suggest that it be read, discussed, amended and adopted, section by section. We have not called it a constitution or anything else; we have just commenced it "Article I."

Dr. Miller—In order to save time, I move that we adopt the different parts of this proposed Constitution without the formality of a motion for each part; each part that is read to stand adopted, if there is no objection. Motion was carried.

Article I of the Constitution was then read by Dr. Mason, and adopted. When Article II was read, an objection was made.

W. C. Frazier—I want that Article so that every one can stand on it.

Mr. Gale—It seems to me that that Article covers the ground.

E. R. Root—You will see that the Article covers all the ground proposed—the prosecution of all adulterators of honey.

Mr. Frazier—What I mean is this: That it takes but very little space to enumerate these little objects, and it will

draw more membership if we do. We want a broad platform to stand on. The object of this society is to get a big membership. We want 1,000 to begin with.

Dr. Miller—I think I see the point; it is a good one. I want that made so that the thing that I want shall be included in it. You have interests in some other direction, perhaps. We all want our interests included. I want it so that if any man comes to me and makes trouble for me with regard to my bees, I can be protected by it. I object to any one thing being specified. If you say merely we are going to protect our interests and carry out the laws, that will cover the ground generally. If we get the thing loaded down, it will break of its own weight.

Mr. York—I think I can suggest a way to get out of the difficulty. Simply put in another phrase, "to prosecute dishonest honey commission-men." I think we would all favor that.

Mr. Frazier—I think that that proposition will be all right.

Mr. Lovell—Before we can prosecute, we must have a law that provides for prosecuting, and this clause, of enforcing the law, covers the ground.



Mr. Ernest R. Root—See Paper on page 739.

Mr. York—I would offer as an amendment to Art. II that we insert the words, "to prosecute dishonest honey commission-men." Motion was carried.

Mr. Whitcomb—Mr. President, how many members have we?

Pres. Root—We have 41 paying members to-day.

Mr. Whitcomb—If we go to establishing salaried offices, when we are going into a war with dishonest commission-men, we will soon be out of funds. One hundred dollars will not

run many lawsuits. All dishonest honey commission-men are to be prosecuted. I find no fault with that, but I think it would be much better to steer clear of dishonest commission-men.

Dr. Miller—I think if Mr. Whitcomb recalls the work of the National Bee-Keepers' Union, he will find that this is a continuation of the same thing. That was for the defense of bee-keepers in their rights, and yet they always kept within the limits of the money they had to use. They did a great amount of good by it. If something very important comes up, or they find that they can do a big business prosecuting dishonest honey commission-men, we can make an assessment of another dollar, but can go no further. I would rather have paid an extra dollar a year to the Bee-Keepers' Union for the prosecution of such commission-men.

Mr. York—I don't think we can reach out as far in this prosecution as this Article contemplates.

Pres. Root—We have a National Bee-Keepers' Union with some money ahead, and some attorneys to look after our interests. So far as my experience has gone, it is only necessary to suggest this fact, and we are respected. We have \$700 on hand.

E. R. Root—If we go about prosecuting dishonest honey commission-men, a great number of men will come into the Union. I have received a number of letters from men who said they would join if we would prosecute such commission-men. If we get members we will have money. I think we can start with a membership of 500. If we can establish a precedent in Chicago, St. Louis, and several large cities, that will be sufficient. I believe that people will join this Union in order to get protection.

Mr. Whitcomb—I was not making any objection to this Article. I was just trying to get a little information.

Mr. Aikin—We have arrived at just the point I supposed we would when we came to adopt this Article. That is all right, except one thing. If we say in our constitution that we must do certain work, and then, when our Board of Managers is organized, undertake to do the work, where is the money coming from? If we just say what work we want done, and then leave it in the hands of our Directors to do that work, so far as we back them up with money, we are all right.

Mr. York—I think Mr. Aikin's remarks are all right. We can hardly compare this new society with the State associations. I, as a publisher of one of the bee-papers, expect to push this thing among my subscribers. The Directors can only use what money is on hand, or what is received as dues, and what can be called in in one assessment. They cannot run us into debt.

Mr. Aikin—I have no particular objection to the Article. It just puts it into the hands of the Managers to adjust it the best they can.

When Art. VII, Sec. 2, was read, it was discussed as follows:

Mr. Frazier—Shall we make the General Manager responsible for these funds?

Dr. Mason—That is what we have done.

Mr. Frazier—That is not a fair deal.

E. R. Root—I understand that is the custom in all associations. If the Treasurer holds in his possession any money, he should give bonds for it. The association should not suffer from the un wisdom of the General Manager.

Mr. Frazier—It is all right to make the General Manager give bond. But to say that he shall put the funds on interest is going too far. He should put it in some strong box. But when you require him to put it on interest, the association should be responsible for the money.

Dr. Mason—in Ohio, our county treasurer is required to deposit the money in banks, where it draws interest.

Mr. Whitcomb—The responsibility only lasts while it is in his hands. A test case was in the Capital National bank here. The United States Supreme Court gave the decision against the State.

Dr. Miller—Here are two cases: In one, the man who holds money, invests it at his own risk and gets paid for it. In the other, he is not held responsible for it.

Mr. Whitcomb—It could be added that he should put it out on the consent of the Board of Directors. When you compel a man to do a certain thing, you cannot go back on him and send him to the penitentiary for it.

Mr. York—I move that Art. VII, Sec. 2, be omitted.

Dr. Miller—I am against omitting it, but I would rather err on the safe side. Therefore, I am in favor of Mr. York's motion.

Mr. Frazier—There is another stumbling block. It says "let it out at the highest rate"

Dr. Mason—It says "the best obtainable rate," not "the highest."

Mr. York's motion to omit was carried.

After the Constitution had been read entire, Mr. Kretchmer said: "I move that the Constitution as read and amended be adopted as a whole." Carried.

Mr. Aikin—This is understood now to be our act. The next thing is, what will the National Bee-Keepers' Union say? The following is the Constitution as adopted:

The Constitution for the New Union.

ARTICLE I.—NAME.

This organization shall be known as the United States Bee-Keepers' Union.

ARTICLE II.—OBJECTS.

Its objects shall be to promote and protect the interests of its members; to defend them in their lawful rights; to enforce laws against the adulteration of honey; to prosecute dishonest honey commission-men; and to advance the pursuit of bee-culture in general.

ARTICLE III.—MEMBERSHIP.

SEC. 1.—Any person may become a member upon the payment of a membership fee of one dollar annually to the Secretary or General Manager on or before the first day of January of each year, except as provided in Section 8 of Article VI of this Constitution.

SEC. 2.—Those who are members of the North American Bee-Keepers' Association and of the National Bee-Keepers' Union when this Constitution is adopted by each organization, shall be members of this Union.

ARTICLE IV.—OFFICERS.

SEC. 1.—The officers of this Union shall be a President, a Vice-President, a Secretary and a Board of Directors which shall consist of a General Manager and six Directors, whose terms of office shall be for one year, or until their successors are elected and qualified; and the Director, aside from the General Manager, receiving the largest number of votes shall be chairman of the Board of Directors.

SEC. 2.—Those who are officers of the National Bee-Keepers' Union when this Constitution is adopted by said Union, shall constitute the Board of Directors of this Union until their successors are elected, at the next annual election in December, and qualified.

ARTICLE V.—ELECTION OF OFFICERS.

SEC. 1.—The President, Vice-President, and Secretary shall be elected by ballot by a majority of the members present at each annual meeting of the Union, and shall constitute the Executive Committee.

SEC. 2.—The General Manager and the Board of Directors shall be elected by ballot during the month of December of each year by a majority of the members voting; blank Postal Card ballots for this purpose, accompanied by a full list of the membership, shall be mailed to each member by the General Manager; and said ballots shall be returned to a committee of two members, who shall be appointed by the Executive Committee, whose names and postoffice address shall be sent to the General Manager by said Executive Committee on or before the 15th of the November preceding the election. Said committee of two shall count the ballots and certify the result to the General Manager during the first week in January.

ARTICLE VI.—DUTIES OF OFFICERS.

SEC. 1.—*President*—It shall be the duty of the President to preside at the annual meeting of the Union; and to perform such other duties as may devolve upon the presiding officer.

SEC. 2.—*Vice-President*—In the absence of the President the Vice-President shall perform the duties of President.

SEC. 3.—*Secretary*—It shall be the duty of the Secretary to keep a record of the proceedings of the annual meeting; to receive membership fees; to furnish the General Manager with the names and postoffice address of those who become members at the annual meeting; to pay to the Treasurer of the Union all moneys left in his hands after paying the expenses of the annual meeting; and to perform such other duties as may be required of him by the Union; and he shall receive such sum for his services, not exceeding \$25, as may be granted by the Board of Directors.

SEC. 4.—*General Manager*—The General Manager shall be Secretary of the Board of Directors, and shall keep a list of the names of members with their postoffice address; receive membership fees, and be Treasurer of this Union. He shall give a bond in such amount, and with such conditions as may

be required and approved by the Board of Directors, for the faithful performance of his duties, and perform such other services as may be required of him by the Board of Directors, or by this Constitution.

SEC. 5.—At the time of sending the ballots to the members for the annual election of the Board of Directors, he shall also send to each member a statement of the financial condition of the Union, and a report of the work done by said Board of Directors.

SEC. 6.—The Board of Directors shall pay the General Manager such sum for his services as said Board may deem proper, but not to exceed 20 per cent. of the receipts of the Union. Said Board shall meet at such time and place as it may decide upon.

SEC. 7.—*Board of Directors*—The Board of Directors shall determine what course shall be taken by the Union upon any matter presented to it for consideration, that does not conflict with this Constitution; and cause such extra, but equal, assessments to be made on each member as may become necessary, giving the reason to each member why such assessment is required; provided that not more than one assessment shall be made in any one year, and not to an amount exceeding the annual membership fee, without a majority vote of all the members of the Union.

SEC. 8.—Any member refusing, or neglecting, to pay said assessment as required by the Board of Directors shall forfeit his membership, and his right to become a member of the Union for one year after said assessment becomes due.

ARTICLE VII.—FUNDS.

SEC. 1.—The funds of this Union may be used for any purpose that the Board of Directors may consider for the interest of its members, and for the advancement of the pursuit of bee-culture.

ARTICLE VIII.—VACANCIES.

Any vacancy occurring in the Board of Directors may be filled by the Executive Committee; and any vacancy occurring in the Executive Committee shall be filled by the Board of Directors.

ARTICLE IX.—MEETINGS.

This Union shall hold annual meetings at such time and place as shall be agreed upon by the Executive Committee, who shall give at least 60 days' notice in the bee-periodicals, of the time and place of meeting.

ARTICLE X.—AMENDMENTS.

This Constitution may be altered or amended by a majority vote of all the members, provided notice of said alteration or amendment has been given at a previous annual meeting.

Dr. Mason—Mr. President, I move that we request the Board of Managers of the National Bee-Keepers' Union to put this Constitution to a vote of the members of that Union at their next annual election, for their adoption or rejection. Carried.

Dr. Miller—Inasmuch as E. R. Root is not to be present at the evening session, I ask that we now take up the topic assigned to him.

Pres. Root—If there is no objection we will listen to Mr. Root.

Improvements in Bee-Culture.

I have divided my subject into two parts—namely, recent improvements that have been adopted; second, the improvements not yet adopted, but which give promise of being of great value. Owing to lack of time I will merely allude to the first named. Among these I would mention self-spacing frames, formerly used by comparatively few bee-keepers, but now being generally adopted. Reversing honey-extractors, improved workmanship in bee-hives, and especially in sections. Sections of two years ago look very crude compared with the perfect products of to-day. Then we have now a tougher and better comb foundation, which is called the new Weed process.

Turning to the second half of my subject, What devices or ideas give promise of value for the future? The use of drawn, or partly-drawn, combs in the production of honey comes to my mind. You will remember that our late friend, Mr. B. Taylor, of Forestville, Minn., has been a strong advocate of the use of drawn combs in sections, leveled down by the comb-leveler. You will remember he made the statement that unfinished sections he considered were his "best stock in trade"—the more of these the better. Those that contained honey were sometimes extracted, but generally placed out in

the yard for the bees to clean out. Where great numbers of these sections were scattered out at a time, the usual excitement incident to ordinary robbing did not appear. These combs emptied were then leveled down by means of a little device illustrated and described in the bee-papers. They were then set aside, ready for the next season. When the honey-flow came on, the bees would enter into these sections immediately, and commence storing honey.

A number of years prior to Mr. Taylor's advocacy of drawn combs, it seems that Mr. Samuel Simmins, of England, had been advocating something similar; but at the time, bee-keepers seemed to take very little stock in these drawn combs; but within the last year or so they have begun to discover something of merit in them. I must confess, myself, that I could see very little advantage in them; but when Mr. Weed, of foundation fame, showed me in the apiary how much more readily bees accepted the drawn combs, or, rather, partly-drawn combs, than foundation, I became convinced, and have been an advocate of them ever since. I saw that, not in one case, but in numerous cases, the bees would commence upon the drawn combs at once, store honey in them, and cap them over before they would even touch foundation in sections next to them.

It is generally admitted that more extracted honey can be produced than of comb. Just how much more, no one seems to know definitely. Some say twice as much, some say a half more, some only a fourth more. Well, then, if more extracted honey can be produced than comb, why is it? The explanation is easy. In running for extracted honey, extracting-combs are given. These the bees store with their first honey, and keep on storing until they are full. They do not even have to stop to draw out foundation, much less loaf around a few days before attempting to draw it out. How is it in the case of comb honey? A super containing sections, said sections containing full sheets of foundation, is given. But before the bees enter that super they will crowd every available cell in the brood-nest, even building the combs before they will commence work on the foundation above. In the meantime the loafing habit is started, and swarming is likely to follow. The fact of the matter is, the bees seem much to prefer to store nectar in cells already drawn out; and it takes pressure, a great deal of it, to force them into supers. When they once commence drawing out the foundation, then the storing and the work on the other sections begins.

Now, then, suppose that, instead of those full sheets, we give them sections containing drawn comb, or, preferably, comb partly drawn out. What is the effect? The bees commence storing honey immediately. The loafing of three or four days preparatory to giving it sections, and occasional swarming that is induced by this loafing, will be largely avoided.

"But," you say, "your theory is all good enough, but how are you going to get the comb?" In the first place, I would save all unfinished sections, and level them down by the B. Taylor plan. In the second place, the future may give us an artificially made comb as light and as thin in cell-wall and base as the product made by the bees. It should not be heavier, because then we should have the fishbone—a thing that cannot be tolerated in first-class comb honey. As to the expense, it should not be very much above foundation per square inch.

But suppose inventive genius does not supply us with such an article? I believe it is possible to have the bees make it for us out of season, ready for the flow of honey when it does come. Mr. Otis and Mr. Baldrige, of Illinois, have already been doing something in this line; and I understand their crops of honey are larger than those of their neighbors who work on the old plan with simply foundation in the sections. Under certain conditions foundation can be drawn out, or partly drawn out, at least, in 48 hours. If this drawing out is done out of season, feeding might have to be resorted to; but I must confess I feel that we need an invention that will produce this partly-drawn-out comb, without the intervention of bees. If we can create a demand, inventive genius will be likely to commence work. The thought is father of the deed.

Now, then, turning from the subject of drawn combs to possibilities along the line of being able to produce comb honey without the necessity of scraping sections. Mr. Danzenbaker has hit upon a plan that so far seems to promise success. He places a sheet of paraffined paper on top of his super of sections. This is crowded down so as to fit snugly, by means of layers of newspapers. Over all is placed a cover. Bees dislike paraffine; and, moreover, as Mr. Danzenbaker argues, this paper, being impervious, retains the heat of the super. If there is an opportunity for circulating currents of air, the bees, he explains, commence propolizing until these cracks through which the heat escapes are sealed.

Well, Mr. Danzenbaker, on this plan, produced in Michigan quite a little crop of honey, and the same was exhibited at the recent Michigan State Fair. Not a section of it had been scraped; and yet, notwithstanding this, he secured the first prize. But perhaps you ask, "How does he prevent the bees from propolizing the upright edges of the sections?" He would have the separators paraffined; and when the whole super is made up there is very little desire or opportunity for the bees to deposit propolis.

Mr. Geo. E. Hilton, a bee-keeper in Michigan whom I regard as not inclined to be very enthusiastic regarding the value of new things, after examining the Danzenbaker system, I am informed, spoke very highly of it. Indeed, he expressed himself as saying he would use the paper next season. While Mr. Danzenbaker, almost in the same vicinity, had found it unnecessary to do any scraping at all, Mr. Hilton had been obliged to do considerable of it.

I have not yet tested paraffine paper in the manner stated; but I believe there is something in the idea, and I therefore give it to you for what it is worth.

I might say in this connection, for instance, that we found that bees dislike to have anything to do with paraffine. The past summer, in shipping queens we used what is called the "export cage." In this particular cage a compartment is provided for holding the little pieces of honey. This honey is secured, usually, by means of melted paraffine. To make sure of keeping some of these pieces of comb from leaking, the cappings were painted over with paraffine. Some of these cages thus prepared were sent to Italy, and returned with bees and queens. I was greatly surprised to note that the bees refused to gnaw through the capping that had been paraffined over; but close examination showed that they had actually tunneled under the capping, into the sides of the comb untouched by paraffine, just about as moth-worms do. In the same way, bees may show aversion to paraffine paper.

ERNEST R. ROOT.

Mr. Biesemier—I have been using this paraffine paper for the last three years. The first year I used mostly newspapers, but the bees would gnaw that and propolize it. The past summer I used only paraffine paper, and only over the top. I always raise the section-case up and put another under it. I can tier as high as I please with paraffine paper.

Mr. Kretschmer—Prof. Gersten has invented a special frame using an additional bottom above the lower frame. In this way they are using it entirely. Bees will cap the sections. They neglect the foundation simply because it is more convenient to go into the other. Two years ago I received from Germany a piece of comb foundation, $\frac{3}{8}$ inch in diameter, and $\frac{3}{8}$ in depth. I placed this in the center of a brood-comb. The bees never used it for the deposit of honey. It was made out of pure wax, apparently natural size except that it was of flat-bottom. In the construction of comb foundation, it may be well to take into consideration that there may be something to which the bees will object.

E. R. Root—Some years ago a man got the cells smaller than the bees could work in. We once made them a little too large, and the bees refused them again. They must be exactly the right size.

Dr. Miller—Some comb was sent to me from Germany, but it was very heavy. I don't think we could use anything of that kind. But there may be some improvement made, and we may yet find something to put right into our sections and fill them up. If paraffine has the effect that has been given, the question comes whether, if we paint the surface and points of contact with paraffine, that will keep the bees from gluing them together.

E. R. Root—I think it would.

Dr. Miller—Vaseline is used in England.

Pres. Root—That soils the sections.

Dr. Miller—I am only thinking of the brood-chamber; not so much of the sections.

Pres. Root—Just before I left home, Mr. Danzenbaker showed a separator which he dipped in melted paraffine. It was very smooth. I think the bees would never put any propolis on such a separator. If the bees would keep their wax and propolis off of it, it would be a good thing. Has anybody tried it?

Mr. Kretschmer—You may carry the idea of the use of paraffine too far. We know the bees object to it in any form.

Mr. Stilson—My experience with separators coated with paraffine is that the bees did not put any propolis near it—nor any honey, nor anything else. They will not go near it.

Mr. Stewart—I would like Pres. Root to put this question to the members present: If you had 1,000 pounds of section honey—smartweed or heart's-ease—in your honey-house, how many of you would extract it and melt the combs down and

keep the sections for next year's crop, the sections being new and nice?

E. R. Root—Mr. B. Taylor did not approve of such action, I think.

Mr. Stewart—I have been following him very closely for several years. In his last letter he said he kept the whole crop over.

To Mr. Stewart's question, all voted "No" but Mr. Stewart.

Dr. Miller—Let me ask another question: Suppose your sections have been filled, or partly filled. The bees have emptied out part of the honey, but the comb is there; the comb is not sealed. How many would extract such combs and keep them over?

Nine voted "Yes," and five "No."

Dr. Miller—Another question: How many would take such sections and let the bees empty them, and then use them next year?

Five voted "Yes."

A Member—That would depend upon whether your bees were well provided with honey.

Mr. Whitcomb—How many of those who empty their sections that way would expect first-class honey next year under any conditions?

One answered "Yes;" seven "No."

J. L. Patterson—I find these sections very valuable by putting one or two of them into the super when it is fresh. The bees immediately went into the super and commenced to work. I think I accomplished something by it, on the whole. If you get a bee once started to work up into the super, you can put on another super.

Dr. Miller—I don't know anything about this, though I have had a good deal of experience. I have had sections used again the second year. I don't level them down, but that I do not think is the cause. If you let bees have their sections in the fall, when they are doing no gathering, one thing they will do is to put a little propolis right on the edge of the comb. When they are filled up, those sections that have been used the previous year may be so that they will granulate. I am working on the problem, and I think this: If I take sections that have been used the year before, and put them away and keep them carefully, I might just as well throw them in the fire; they are good for nothing. But if, instead of extracting them, I let the bees clean them out thoroughly, then put them out somewhere—not in the hive—while they are wet, then these sections are good for next year, I think—I don't know. I have done it in some cases.

Mr. Whitcomb—There is a great surface of the wax exposed to the air. They come out in the spring, having lost considerable of the oil in this wax. But when you come to sell the second year's crop, it appears to be tough—something wrong with it. People say, "What is the matter with that honey?" It has dried out during the season. I believe it is cheaper to throw them away.

Dr. Miller—I think Mr. Whitcomb is mistaken about that. If the oils are lost by coming in contact with the air, the same objection would apply to comb foundation. But I have put on the market this year 10,000 pounds of honey; and that foundation was exposed to the air in the sections from three to five years. I never produced finer honey.

Mr. Whitcomb—But you live down in Illinois, in a lower altitude than this. We are 1,500 feet nearer (!) Heaven than you, and in a drier atmosphere. You will notice a great difference between this place and Marengo, Ill.

Mr. Stilson—Dr. Miller lives down in the lake region. The temperature is very different. We can expose our honey here and it will dry up more in three months than it would there in three years. We must consider the conditions under which each of us is working. We can't use foundation here that has been exposed to the air for 90 days. We dip it into warm water and expose it to the sun.

Dr. Miller—I propose a compromise by which blood-shed may be saved. Wherever the climate is moist, use these sections.

Mr. DeLong—I had a great many extracting-combs drawn out last year. I put one or two of them into the hives, and the bees refused to work on them. I find it objectionable even in extracted honey production.

Dr. Mason—Shall we have our proceedings published for the members? They will be published in the American Bee Journal, and unless you take that paper, you will not see them. It can be done at an expense of \$10.

Mr. Stilson—I move that the Secretary be instructed to contract with Mr. York, for the publication of the proceedings at the price named. Motion carried.

Dr. Mason—It is the custom to draw up something by way of thanks to all who have shown us kindness where the

meetings are held. I move that the President appoint a committee for this.

E. R. Root—Why not just pass a vote of thanks ourselves?

Mr. Secor—I move that Chancellor MacLean be made an honorary member of this society, in view of the great interest he has taken in our work since we have been here.

Mr. Gale—I agree with Mr. Secor, but why not include the two Professors?

Mr. Whitecomb—I move to amend by adding Professors Bessey and Bruner.

Mr. Secor accepted the amendment, and the motion was carried unanimously.

Dr. Miller—I move that we express our thanks as an Association to the Committee of Arrangements of the Nebraska bee-keepers, for the very kind manner in which we have been treated since we have been here. Motion carried.

Mr. Stilson—I wish to introduce the following resolution:

WHEREAS, Certain bee-keepers' societies in New York are sending out circulars to bee-keepers and bee-keepers' associations in the United States, asking them to co-operate in asking our National Government to send persons or parties to the Old World to secure and import the bee known as the "Apis dorsata," for experimental work in this country; therefore, be it

Resolved, That we as members of the North American Bee-keepers' Association do not think it for the best interest of all concerned to ask or work for the end sought; and that a copy of these resolutions be sent to the Secretary of Agriculture.

Mr. Stilson—I introduce this because of this one fact: There is a bee-keepers' association in New York that is sending out circulars, asking the co-operation of the associations of bee-keepers for the appointment of some person to go to the Old World. To my notion, this shows the underhand work of another gentleman in Washington. I do not believe it is to the benefit of this country to do it.

E. R. Root—At one time I stated in Gleanings that I did not favor any movement for the importation of bees. When it was proposed to introduce them without any expense, I supported it. I do not support the New York scheme. I am in favor of the resolution.

The resolution was adopted.

Election of Officers—Place of the Next Meeting.

Dr. Mason—I move that we proceed to the election of officers for the ensuing year.

Mr. Kretschmer—I move to amend by naming time and place for the next meeting.

Mr. York—I believe the new Constitution directs to leave this in the hands of the Executive Committee. I don't think we had better bind the Association too far in advance.

Dr. Mason—We are now under the Constitution we have adopted. The Executive Committee should fix the time and place of meeting.

Mr. Gale—I do not think that the Constitution just adopted can control our proceedings now.

E. R. Root—But the officers we would elect would be under the new Constitution.

Mr. Aikin—I believe that all we can do is to proceed to the work under the old Constitution.

Mr. Kretschmer—Mr. President, I renew my motion, that we proceed to the selection of a place and time for the next meeting. Motion carried.

Dr. Mason—I have an invitation from the Governor of Tennessee; from the Board of Trade; from the Mayor of Nashville; and from nearly everybody that holds an office in that city, that we meet in that place during their Centennial, which lasts six months, beginning next May. They offer to furnish a hall free. I have also a similar invitation (sent to Mr. Newman, and by him sent to me) for the Bee-keepers' Union to meet at Nashville. I have also one from the Erie County Bee-keepers' Society at Buffalo, N. Y., through its Corresponding Secretary, Mr. O. L. Hershiser, to hold the next meeting at Buffalo. I move that our next meeting be held in Buffalo.

Dr. Miller—We did talk at one time of meeting at the same time and place as the G. A. R. If Buffalo is that place, I am in favor of meeting there.

Dr. Mason—My idea was to take advantage of the reduced rates for the G. A. R., which meets at Buffalo next year.

Mr. Stilson—If we meet in Buffalo, we must all buy tickets before the reunion. I move that it be left to a committee.

Dr. Mason—I will change my motion to read that we meet in Buffalo, N. Y., at such time as the Executive Committee may fix upon. Motion carried.

Dr. Miller—I move that we proceed to the election of officers. Motion carried.

Pres. Root—Nominations for President are in order.

Dr. Mason—It is frequently the custom in making nominations, to praise the candidates, but the one I'm going to name is well known to you all, and needs no praise or introduction by any one. I nominate George W. York, of Chicago, Ill., for President for the coming year.

E. R. Root—I second the nomination.

Mr. York was unanimously elected.

Mr. Secor—I nominate Mr. Whitecomb for Vice-President. Mr. Whitecomb was unanimously elected.

Mr. Stilson—I nominate Dr. Mason for Secretary.

Dr. Mason was unanimously elected.

Dr. Mason—Since we are going down to Buffalo, I move that O. L. Hershiser be elected Treasurer. The motion was carried.

The New Constitution.

Mr. York—I want to ask a question about the new Constitution. Suppose the National Bee-keepers' Union, at its next election in January, decides to adopt it, does it then go into effect?

Mr. Whitecomb—We have adopted it already as far as we can.

Mr. York—Then if the Union does not adopt it, we can work under it next year. We ought to get to work and do something, even if the National Union does not adopt it.

Dr. Mason—The intention is that the Constitution that we have adopted to-day is ours. If the old Union does not accept it, we can go on just the same. We have made provision for the placing of our surplus funds, and have nothing to do with theirs. If they adopt this Constitution, our money goes to them; if not, we keep it ourselves. The old Union's work goes right on. I have said from the very beginning that I am for amalgamation, if it can be accomplished without any detriment to the old Union. We have not changed things any as regards the Union. We elect our own officers, and these have nothing to do with the work of the Board of Directors, which, under the new organization, will go right on with the work of the old Union as it is now done by them, only on an enlarged scale. If the Union does not adopt this Constitution, we can go right on and work under it, and carry out what it is intended to do.

At 5:45 p.m. the convention adjourned to meet at 7:30 o'clock.

(Continued on page 753.)



Planting for Honey in the South.

BY ADRIAN GETAZ.

Some time ago somebody suggested planting trees along the roads, both for ornamentation and nectar-production, and advised to choose linden for the purpose. But why plant only one kind? Why not plant several kinds, so as to have a honey season as long as possible?

In my locality two or three different kinds of maples and the Judas tree could furnish nectar early in the spring, before fruit-bloom. The following period, say during April or about, would be filled by the fruit-trees, and therefore need not be considered in the selection of trees. After that, the locusts and poplar, more or less overlapping each other, would call our attention. Perhaps, also, some other trees which I have not in mind just now. This would run us till about the middle of May. After that, there would be two or three weeks during which I do not know what kind of trees would be in blossom. This period in some localities is filled by the white clover. Here the white clover does not amount to anything, but we often have a honey-dew in the place of it.

Early in June we have the persimmons, then the lindens, then the sourwood, more or less overlapping each other, and furnishing an unbroken succession from early in June till the middle or near the end of July, according to the seasons. That is, if we had the trees. In point of fact, the poplars

and locust trees are very scarce, the persimmons not very numerous, the sourwoods plentiful; but I know only *one* linden in the whole neighborhood of my apiary at Mr. Thompson's. In the other, at Mr. Pavid's, the conditions are somewhat better, as there is an abundance of maples, and quite a number of poplar trees in a tract of land one-half mile away, which belongs to the county.

I may add that there are several varieties of lindens which do not bloom exactly together. They ought to be secured so as to prolong the season as much as possible.

SOWING ALONG THE ROADS.

Planting trees along the roads naturally leads to sowing along the roads, and in other waste places. This requires some consideration. Where hogs are allowed to run at large, as is the case in most of the Southern States, it would be perfectly useless to plant anything at all, as they will dig out everything in sight. Where only the cattle are allowed out, there it would be necessary to select some plant that they will not touch, or at least not like very much. This depends somewhat upon the number of animals out, and how hungry they are. This condition cuts out the sweet clover entirely. There is in the South another objection to sweet clover, that is, it blossoms too soon. It begins here early in June, and follows on, until there is a great number of seeds on the plant. By that time the strength of the plant gives out, it ceases blooming, and dies out in the early part of August. The yield from that source would, therefore (in this locality), extend only one, or perhaps, sometimes, two weeks beyond the sourwood.

Our great drawback here from Aug. 1 till winter, is the dry weather. With enough rain, we would have something like a yield during August and September from some minor sources, and plenty during October from the golden-rods and asters.

What we need is something that resists pasturing by the cattle, that stands a strong drouth, and that blossoms during August and September. Where to find it, I don't know, but perhaps it might be found in California, judging by the excellent articles of Prof. Cook on the California flora.

PLANTING FOR HONEY AND FORAGE.

A good deal has been written lately about sowing Alsike clover and sweet clover instead of red clover. To these people I will say that Alsike clover and sweet clover have been tried again and again, in different countries, during the last hundred years or so, and invariably abandoned because they are inferior to their competitors—the red clover, alfalfa and sainfoin. The alfalfa gives the best results for hay when cut just before it blossoms, which cuts off much of its usefulness as a honey-plant. The sainfoin, on the other hand, is at its best when the blossoming is nearly ended, and gives a strong yield of first-class honey during about two weeks. I do not know at what time of the year it would blossom here.

The crimson clover has the disadvantage of blossoming at a time of the year when the nectar from other sources is already abundant.

There is, however, a way in which sweet clover might be profitably cultivated. There are plenty of worn-out lands in the Southern States that can be bought for a low price—from \$5 to \$10, or perhaps \$15, an acre, according to the location. These could be sown to sweet clover, left to themselves a few years, and finally the last growth of sweet clover turned under, and by this their fertility would be restored at a very small cost. In order to get the most honey possible, it would be necessary so cut down at least a part of the sweet clover before it blossoms, so as to retard the blossoming. The period of nectar-producing might be thus extended perhaps several weeks.

Knoxville, Tenn.



A Criticism on the New Constitution Adopted at the Lincoln Convention.

BY THOMAS G. NEWMAN.

To the Officers and Members of the North American Bee-Keepers' Association:

Having received a proof of the Constitution of the proposed "United States Bee-Keepers' Union," kindly sent me for criticism by the genial Secretary, Dr. A. B. Mason, with the request to have it submitted to the National Bee-Keepers' Union at the next election, I have carefully weighed each of its provisions, and will in all kindness and candor point out some of its incongruities, as well as its lack of consistency and completeness.

If there is a successful "amalgamation," the new organi-

zation should have a Constitution as near perfection as possible, and as I have been requested to criticize it, I do so cheerfully; and, with the best of intention, submit the following remarks:

Section 2 of Art. III. and Sec. 2 of Art. IV. are inappropriate in a Constitution. They prescribe as to who shall be officers and members in the event of the adoption of the New Constitution by the two societies if amalgamated, and are clearly "out of order" in the Constitution—the document to be thus submitted. They might have been subsequent "resolutions," providing for exigencies, in case of the adoption of the Constitution by both societies.

Article V. creates an "Executive Committee," but nowhere are the duties and powers of that committee defined. Should the Executive Committee attempt to do anything, it must necessarily interfere with the duties of the Board of Directors, and a conflict of authority would ensue, which might disrupt the organization and destroy its usefulness.

If the Board of Directors be not the Executive Committee, what is that Board created for? What are its duties? And, *vice versa*, it may be demanded—if the members of the Executive Committee are not to "direct" the business of the organization—what are they to do? What are their duties?

When it is sought to obtain an incorporation under the laws of the United States, or any one State, it will be found that the Board of Directors is the *only* executive authority recognized by the law, and the *only* body that can be elected by the members; that it is the duty of the Board of Directors even to elect the officers of the organization; that all business done by any other person is illegal and useless; in other words, that the Board of Directors is the only legal "Executive Committee"—the only power to make or execute the laws made for the government of the organization. If the Constitution and By-Laws of the organization sought to be incorporated are not in accordance with the law, they will be ordered changed by the State officers. That will cause serious delay—for as the convention ADOPTED the Constitution, after considering it section by section (as the Secretary informs me by letter), the committee was discharged, and can have no further power to change or modify anything; their duties are ended—that committee in fact no longer exists.

Again, in Sec. 2, Art. V., there is another serious mistake. The postal card ballots are required to be returned to a committee of *two members*, appointed by the Executive Committee, to "count" and "certify the result." Whoever heard of a secret ballot being sent on a "postal card?" and more ridiculous is the idea that it should be mailed to *two members*—unless it is made in duplicate! Or, was it contemplated to send some to *one* member of the committee and some to the other member? Suppose those "two members" should reside at different points—perhaps some distance apart—how about their getting together to "count" them, and who is to pay the expense incurred? Or would they be required to pay their own expenses for the "honor" conferred on them by the "Executive Committee?" Manifestly they ought to be sent to one, and should be in a sealed envelope, to be opened in the presence of the *whole* committee, so as to preserve their secrecy and integrity.

Again these ballots will be accompanied with the dollar for Dues, and in many cases (if not all), will be forwarded to the General Manager. If they are sealed as they were last year, is that not the proper person to receive them as well as the Dues, for he only can determine who is entitled to vote, by the Dues being paid; then for him to call the committee together is consistent and proper, in order to open, count and certify as to who are elected?

Article VI., Sec. 3, provides that the Secretary of the Union "shall pay to the Treasurer of the Union *all moneys left* in his hands after paying the expenses of the annual meeting." Here is a big "loop-hole!" Article IX. states, "this Union shall hold annual meetings at such times and places as shall be agreed upon," etc. Does the Secretary pay the mileage and per diem of the officers or members, or both? If not, it would be better to have it definitely stated.

Section 6 of Art. VI. provides also that the Board of Directors "shall meet at such time and place as it may decide upon." How are their expenses to be paid? If mileage and per diem are to be paid, it should be so stated, and the rates ought to be determined by the Constitution or By-Laws. If they are to pay their own expenses, that fact should also be mentioned before they are elected, for some may object to being so taxed. This is a broad country, and such a Board should be located so as to represent the whole of it, and the expense of such a compulsory meeting would be no mean item, whether it came out of the funds of the Union or out of the pockets of the honorary Board. This is a serious matter,

and in enacting such important legislation, is it not better to "make haste slowly?"

There are quite a number of other incongruities which call for discussion and review. Section 8 of Art. VI. should be changed in verbiage and made Sec. 2 of Art. III. And in Art. X. the words "altered or amended" occur twice. Amendments are always alterations. Why such tautology?

Section 7 of Art. VI. needs a complete revision. If there can be collected no more than the regular annual dues, without a majority of all the members of the Union, why talk about calling for or making *extra* assessments?

If expensive annual meetings are to be held, there must of necessity be a limit to the liability of the Union for their expenses, or it will soon be bankrupt. I fully concur in Dr. Mason's remarks in *Gleanings*, on page 670, when he says: "This country of ours is too large" to warrant annual meetings, and expensive personal representation. If it is attempted to make it representative, it will fail, unless the Union pays the expenses of the delegates; and if the Union pays the expenses of the delegates, then it will have but little money left (if any) to pay for its only legitimate work—the defense of its members in their legal rights, when unlawfully assailed by ignorance, prejudice, and maliciousness.

The whole thing is so incongruous and incomplete that it seems necessary to refer it back to the next convention at Buffalo for revision. Before it is in proper shape to present to the "National Bee-Keepers' Union" it needs a thorough overhauling and reconstruction, and as the convention considered it section by section, and then adopted it, no one now can have the right to alter its language or requirements. There is, therefore, nothing left for its advocates now to do, but to await the action of the convention next year; at least, so it seems to,

Yours for every progressive step,

THOMAS G. NEWMAN,

General Manager National Bee-Keepers' Union.

San Diego, Calif.

[See New Constitution in full on page 738, and editorial comments on the foregoing "criticism" on page 744.—Ed.]



Rearing of Queens, and Their Purity.

BY DR. E. GALLUP.

On page 596 Wm. S. Barclay mentions his surprise at the purity of a black-Italian queen, etc. In old times, it was first advocated, and we started into rearing Italian queens in a small box about 6 inches square, and with very few bees, without any regard to their age, or whether there were any nursing bees or not. Give them a small frame of brood and eggs, and they would usually start two queen-cells, and often from larvæ too far advanced, etc. A queen was a queen in those days, and we paid from \$5 to \$10 each for such queens, and they usually came up missing in from 15 to 30 days from the time of introducing.

I started in, as recommended by the man that I purchased my first queen from, but it did not take me long to discover that I could rear no good queens in that manner. From a well-marked mother we could rear queens as black as crows. They lacked all the requisites for rearing queens.

Soon after, Mr. Aaron Benedict received his first imported queen, and went with his little boxes on Kelley's Island, in Lake Erie. Well, his queens reared from her were as black as crows, and he decided that the mother queen was worthless, and destroyed her. I had quite a discussion with him in N. C. Mitchell's bee-journal, but could not make him own up; for if you convince a man against his will, he is of the same opinion still. So I dropped him in disgust.

If we rear queens without proper nourishment, or lack of warmth, etc., we can rear black queens from the very best marked mother. A queen-cell may be so located in the hive that a few days (just at the right age) of cool, damp, rainy weather, will change the queen's color entirely; yet it does not affect her purity. Again, a lack of nourishment will change the color.

The past summer I inserted a queen-cell in a colony that had been queenless several days, in the cool weather we had in the spring; I cut out all queen-cells, as I supposed. On looking to see if the cell had hatched, I found it torn down, and a small, black queen in the hive. I left her until I could receive a queen that I had sent for. On receiving my queen, I looked for the small queen; she had laid a few eggs and disappeared, and the bees had half-sized cells and larvæ nearly ready to seal in them. This small, black queen was from a pure mother, fertilized by an impure drone.

All queen-cells should be started in a full, strong colony, with abundance of nursing-bees, and if from any cause the colony cannot gather food, they should be abundantly stimulated, for stimulation creates activity and warmth, whether that stimulation is natural or artificial.

The cells can be transferred, after they are sealed, into small nucleus hives containing two or three combs. I always like to have my nuclei strong with bees. I kept my observation hive strong with bees, and reared four queens in it so the boys could see the whole process. Orange Co., Calif.



Uniting Weak Colonies in the Fall.

BY G. M. DOOLITTLE.

When the time comes to unite I select the hive having the queen I wish to retain, as the one to contain the united colony. I now open this hive and take out what combs I think will be necessary, leaving those containing the most honey, or otherwise, as the circumstances may direct, although it is seldom that united colonies have too much honey, when those that are left, being sure the queen is on one of them, are placed next one side of the hive, as closely together as I wish them to be left for wintering.

The bees which are on the combs to be taken are now shaken off the combs and allowed to run into the hive, when, after closing, it is left as it is, ready to receive whatever is to be united with it.

I next go to the one or more colonies which are to be united with this first one; and if they have a queen she is hunted out and disposed of as I desire, when all of the frames are removed but one, two, or three, in accord with the number of bees there are in this colony; few being so small that only one comb is left, and in no case is a colony weak enough in bees to need uniting, unless they can crowd on three combs fixed as I am about to tell you.

The combs left are generally those containing the most honey, although some years there is little choice of combs on account of all being liberally supplied with honey. The combs (two or three) are now spread apart from one to one and one-half inches, and placed in the center of the hive, when the hive is closed and the bees shaken off the combs taken out, so that they can run in with those left on the spread-apart combs. I fix any others that are to be united in the same way, in some cases putting as high as four or five in with the one having the queen, but not usually more than one, two, or three, according to the number of bees each contains.

I now wait till some cool, cloudy, raw, windy day, or some morning when there has been a frost, or nearly so, when I am ready for the uniting, which is very simple. The hive having the queen is uncovered, or, if the cover is a mat or quilt, this is rolled back till the comb next the vacant side of the hive is exposed, when I go, smoker in hand, to those ready to be united with it, blow a few dense puffs in at the entrance, quickly uncover the hive, blow in freely of smoke over and around the three spread-apart combs, when I place the first finger of each hand between the first two combs, and if three, the big fingers between the next, when the third and little fingers clasp over on the outside of the outside frame, the thumb tightening on the other side at the same time, when the three frames, bees and all, are lifted out all together and carried to the open hive having the queen, and all lowered into said hive in a body, the same being placed close up to the side of the exposed comb. The quilt is now rolled over all the frames but the last, when another and another lot is brought in the same way till the required number are in, when the hive is closed and the uniting accomplished.

If the day is cool and raw enough, or the night has been cold enough, the bees which are to be carried will be compactly clustered on and between the spread-apart combs, and after you get the "hang" of the thing a little you can carry them where you wish without any flying in the air or being left in the hive. Why only three combs are to be left under any circumstances is that a person cannot grasp more than these with his hands, and to separate the clustered bees in any place is to make a bad job in losing bees and have them fly all over you and out into the cold to perish. By removing the hive and stand from the old location no bees are lost by returning, although some will return and hover over the old spot on the first flight for a little time; but you will soon find them with fanning wings at the entrance of their new home, which they accept ever afterward.—*Gleanings*.



☞ See "Bee-Keeper's Guide" offer on page 717.

OLDEST BEE PAPER IN AMERICA ESTABLISHED IN 1861

THE AMERICAN BEE JOURNAL

GEORGE W. YORK, Editor.

PUBLISHED WEEKLY BY

GEORGE W. YORK & COMPANY,

118 Michigan St., CHICAGO, ILL.

\$1.00 a Year—Sample Copy Sent Free.

[Entered at the Post-Office at Chicago as Second-Class Mail-Matter.]

Vol. XXXVI. CHICAGO, ILL., NOV. 19, 1896. No. 47.

EDITORIAL COMMENTS.

Quoting the Honey Market.—We see that at least one of our apicultural exchanges has market quotations from a commission firm that we understand failed four months ago, and also from two other firms whose reputations for honorable dealing are not entirely above question. We think that all bee-papers should unite in refusing to keep in their market columns any firms who are not perfectly square in every way. If any now in the Bee Journal's dealers' list are not all right, we would like to know it. We won't knowingly aid any crooked firm to get business. Down with all honey-dealing frauds, we say. And we are willing to *help* down them, too.

Name and Address Wanted.—We would like to have the careless subscriber in Texas, who enclosed 60 cents in 2-cent stamps, on Nov. 7, kindly send us his or her name and address. All we can make out on the envelop post-mark is "Tex." The letter was not signed—simply the words "Please discontinue" were written with lead-pencil, and the 60 cents enclosed. Now we'd like to know how we can "discontinue" the Bee Journal to that economical writer, when no name or address is given!

We often feel like administering a severe rebuke to the careless folks who try to do business, and should do so were it not for the fact that the very ones for whom such a rebuke is intended, would be too careless to see and read it. We can only say, then, *please be sure to sign your letters with full name and address every time.*

Also, when asking us to change your address on our mail list, don't fail to give the *old* address as well as the new.

The New Constitution, as adopted at the recent Lincoln convention, seems to be a rather verdant and crude affair, as viewed through the spectacles of General Manager Newman, on page 742 of this issue of the Bee Journal. But we think that most of the criticisms offered are mainly the result of a vivid imagination, perhaps traceable, in a measure, to the exhilarating climate in which Southern California is said to superabound.

To begin, Sec. 2 of Art. III. and Sec. 2 of Art. IV., we think, are perfectly proper in the New Constitution until it is adopted by both organizations, when, at the next annual election, both Sections can be ordered dropped. Certainly they do no harm where they are now, and serve the good purpose for which they were intended, until after the amalgamation takes place. So the very first criticism is somewhat "out of order" at this juncture of the proceedings.

Next as to the Executive Committee and Board of Directors: There need be no conflict of authority at all, and, so far

as the present Executive Committee is concerned, there would be no trouble whatever. It is pretty clearly indicated that this Committee is to have in charge the annual meetings, and has nothing to do with the work of the Board of Directors—they do not interfere with each other at all. As to the duties of the Board of Directors, see Sec. 7, Art. VI.

Mr. Newman speaks of incorporation. We believe the old Bee-Keepers' Union is not incorporated, but when the time comes to incorporate the new society, if such action is deemed best, and we find that our Constitution is not quite suitable in some minor detail, we think that can then be easily remedied, or so altered as to conform to the requirements of the incorporation laws.

As to Sec. 2, Art. V., which seems so "ridiculous" to Mr. Newman, we may say: First, no one but himself has referred to a "secret ballot" in connection with the New Constitution, and, besides, during the recent presidential election, the largest Chicago daily newspaper conducted a "postal card ballot," in which we took a part, and it worked nicely. Again, we think it will not be so very hard to find "two members" whose post-office address is the same. The object of the postal card ballot is to save as much expense as possible, and we have not the slightest doubt that it will be found to be all right when put into practice. However, if, after trial, the plan is found wanting in any way, some other method can be adopted in its stead. Surely, there is no need for alarm yet.

Mr. Newman says the ballots would be accompanied by "the dollar for Dues." Whenever he tells us how a dollar bill can be put into a postal card, it will then be time to consider this objection. It is of course understood that the postal card ballots are to have upon them the printed address of the counting committee; and on the opposite side the blanks for voting. So you see not one of them would be returned to the General Manager. The envelopes for mailing the Dues would have upon them the printed address of the General Manager, and he would thus get them all right.

Section 3, Art. VI. seems to be a source of worry to our usually serene General Manager. While there may be a slight "loop-hole," we do not believe that there is the least danger of the annual meeting falling into it. About the only expense is the \$25 for the Secretary of the annual convention. That should not bankrupt the proposed Union—at least heretofore the North American has been quite able to meet the necessary expense of a Secretary. We don't believe that any one need distrust the careful wisdom of the members attending the annual convention. No expensive annual meetings are contemplated.

As no intimation is given in Art. IX., of any mileage or per diem to be paid, we see no need of mentioning it at all. No mileage or per diem has been paid heretofore, and no previous Constitution has contained any reference to it. Why should this one? Of course, all go to the annual meeting at their own expense, if they go at all. But no one will be compelled to go, any more than has been the case in the past with the North American. It is quite likely, however, that the Executive Committee will be present in the future as heretofore.

As to the Board of Directors meeting "at such time and place as it may decide upon," they can likely get together at the annual meetings. And if they "decide" not to meet—not being need for it—we see nothing to compel them to do so. We think no one would hesitate to accept a place on the Board of Directors, fearing that he would be compelled to lose money by it.

We think it hardly necessary for us to go any further at this time in answering Mr. Newman's criticisms. We do not assert that the New Constitution is infallible, but we do think that no great difficulties would be encountered if an honest effort were made to work under its provisions. While it may contain a few inconsequential "incongruities," we believe

that the great majority of the members of the National Bee-Keepers' Union will show themselves quite willing to adopt it, and trust to the wisdom and experience of the future to strengthen such portions as may prove to be inadequate for any emergencies.

It will be seen that it was not contemplated to interfere in any way with the good object of the old Union, but to broaden out and take in the enforcement of anti-adulteration laws and the prosecution of dishonest honey commission-men. Surely, this is a wise move, and should be encouraged in every way by all who have the best interest of bee-keeping at heart.

We certainly do not wish to seem to desire to discountenance any criticisms of the New Constitution, but let us have such that are of real importance. We do not doubt Mr. Newman's sincerity at all, but to us nearly all that he has advanced on page 742, seems to be of so little significance, or that can be so easily and satisfactorily answered, that no fears need be aroused by reason of them.

Let us not delay a whole year the good work proposed to be undertaken by the New Constitution (as published on page 738), but let all unite in making an honest attempt to get together and push hard against honey-adulteration, fraudulent honey commission-men, and also continue to defend bee-keeping in all its legal rights.

PERSONAL MENTION.

MR. C. A. HATCH, formerly of Ithaca, Wis., now turns up at Pasadena, Calif. At least he has written an article for *Gleanings* for Nov. 1 from that place. It seems he has been keeping bees in Arizona the past year or two.

MR. THOS. WM. COWAN, editor of the *British Bee Journal*, wrote us Nov. 3, from London, that he expected to "sail by the *Etruria* on Nov. 14, and, after arriving in New York, to go south to escape the cold; then on to California." He hopes to see us "in the spring, when it is not too cold." We trust our brother editor may have a safe voyage, and pleasant trip all the way around. We shall be glad to meet him when he reaches Chicago.

HON. EUGENE SECOR's poem, published in last week's *Bee Journal*, was considered the gem of the whole convention at Lincoln. He not only wrote it, but recited it from memory upon the platform after the addresses of welcome by Lieut.-Gov. Moore and Chancellor MacLean. How proud we all were of our poet-laureate! It was a delightful surprise, and won for our esteemed fellow bee-keeper new laurels, which will be worthily worn.

MR. BYRON WALKER is again in Chicago. He expects to have his family with him this winter. From about 300 colonies this year he obtained 32,000 pounds of honey, almost all extracted. He has been visiting other cities the past month or two, and has disposed of several carloads of honey. In one city he sold 16,000 pounds in two days. Mr. Walker is a great pusher of pure honey among the people. Every bee-keeper ought to be known in the same way. It would greatly help the demand for honey.

REV. E. T. ABBOTT, of St. Joseph, Mo., expected to start out on Monday, Nov. 9, for two months' institute work in Missouri. Mr. Abbott is a good talker, as all know who heard him at the Lincoln convention.

At the Farmers' Institute to be held at St. Joseph, Nov. 31, there is to be an agricultural exhibit, which of course includes honey and beeswax. There are 157 premiums offered by the merchants of that city, and the winner in any case is to give his exhibit in exchange for the premium offered. That's a splendid arrangement. For instance, \$2.00 worth of coffee is offered by a grocer for the best 5-pound display of beeswax. The grocer gets the beeswax, and the winning exhibitor takes the coffee. There should be no trouble to get a host of premiums for any institute or fair if secured in that way.

Questions AND Answers

CONDUCTED BY

DR. C. C. MILLER, MARENGO, ILL.

[Questions may be mailed to the *Bee Journal*, or to Dr. Miller direct.]

Feeding Flour for Pollen—Chaff in Wintering.

1. How do you feed bees flour for pollen in the spring?
2. Can I put chaff hives around the bees in the fall before I put them into the bee-cellar, and then take it off again?
Sabacl, N. Y. G. H. P.

ANSWERS.—1. All that is actually necessary is to put the flour in any place where the bees can get at it, and let them do the rest. It is well to put it in a sheltered place where they are protected from the winds, but not from the sun. Rye flour is often spoken of, but it is perhaps not best to give any kind of flour clear. Ground feed, such as is fed to horses and cattle, will likely suit them better. They will eat out the fine parts, and the remainder can be fed to the four-footed stock. Ground oats and corn is the kind I generally use. Put it in a shallow box anywhere from one foot to two feet square. Put a block or a stone under one edge, and when the bees have worked the feed down level, put the stone under the opposite edge. If the bees don't commence on it promptly, bait them with a little honey. If natural pollen is yielding they will not need it, neither can you get them to take it.

2. The chaff in chaff hives is generally left all the year round, even when put into the cellar.

Straight Combs from Starters in Wired Frames.

In reply to a query I once addressed you, you seemed inclined to doubt whether bees would build the wire nicely into the comb where only starters were given on *wired frames*. I am happy to say that experience has since taught me that in nearly every case they have given the most perfect satisfaction—combs straight, level, and the wires well in the septum. It may please some readers of the *American Bee Journal* to know this. S. A. D.

ANSWER.—I'm glad to know that you've been very successful in getting combs built over wires, but there's no certainty that every one else will have the same success. You are a very careful man, and had everything in the right shape to get combs built straight and level, but I greatly doubt whether the presence of the wire had anything to do with the proper building of the combs. The wire will be built in the septum if the wire happens to be where the bees want to build the septum. But I think you'll find they'll not turn aside a hair's breadth to follow the wire. My own experience in the matter is that the wire helps to strengthen the comb and keep it from breaking out of the frame, yet for the purpose of securing straight combs it is utterly worthless unless foundation be used.

Stores for Winter—Introducing Queens.

1. Will 10 pounds of honey and 5 pounds of granulated sugar, dissolved in two quarts of boiling water and fed to colonies of bees that cover (not the entire length of) four Langstroth frames, winter them from Nov. 1, 1896, to April 15, 1897? I have 12 such colonies, and have given them two Langstroth frames of honey each, and fed them the above mentioned syrup.

2. Will six Langstroth frames of honey winter colonies that cluster on five frames? and will I have to feed anything to them in the spring?

3. Can I introduce successfully queens at this late date—I don't want to rear any black drones next spring. I have 10 colonies of golden Italians, and 20 of black, which I wish to change. P. O.

Northampton, N. Y., Nov. 2.

ANSWERS.—1. There is great variation as to the amount of stores consumed by colonies that appear to be alike in

strength, some using twice as much as others. Five pounds of sugar are equivalent to 7 pounds of honey, and that makes the same as 17 pounds of honey for a colony covering four frames. That ought to last out-doors till April 15, although an exceptional one of the lot may want more. In the cellar they can do with less. But it's a good plan always to give them what you think will last till the middle of May or later. I would rather, however, run the risk of losing one or two than to try to feed syrup as late as this. It may be well to say that it takes two very heavy Langstroth combs to contain 10 pounds of honey, and there may be a question as to the amount of honey in the two combs you have given. They may weigh 12 pounds and contain less than 8 pounds of honey. An old comb weighs a good deal when it's empty, and there may be a large amount of pollen present.

2. That depends. If the combs are plumped as full as possible, no feeding ought to be needed in the spring.

3. I don't know anything about it from experience, and think I would rather wait till spring. You can take pains to keep all drone-brood out of the black colonies, or you can keep drone-traps at the entrance. Still it might work all right to give queens now or later. During winter bees are little inclined to quarrel with new comers. But one trouble in the case is that you cannot always be sure of warm weather to make the change, and you can do a lot of harm by hunting a queen when it is too cold for bees to fly.

Separators—Cellar-Wintering.

1. Can I use separators, either tin or wood, in the Improved-Langstroth Simplicity supers? If so, is there any particular kind?

2. I took off all surplus honey as soon as the honey-flow ceased. I then placed the empty supers back on the hives, put a piece of burlap on the pattern slats (full size of super), then filled the supers with clean, dry wheat chaff. Would you consider this all right for cellar-wintering, providing the bees have plenty of stores?

3. Would you leave the covers off? My cellar is frost-proof and dry.

Wadena, Minn., Oct. 12.

J. E.

ANSWERS.—1. I'm not sure exactly what you mean by "Improved-Langstroth Simplicity" supers, but there is probably no super on the market now that does not admit the use of separators. The kind called "section-holders" have tin separators attached to the holders, and T supers have loose wooden separators.

2. That's all right. Whether the bees will winter enough better in the cellar to pay for the trouble of putting in the chaff is a question. Try one or two with no super or chaff, just the cover, and see whether there is any difference in wintering.

3. Probably it will make little difference. If there is very little chance for ventilation at the entrance, then it may be best to leave the covers off, but I should leave abundant room for ventilation at the entrance in either case. You can hardly do any harm by having the entrance too open in the cellar.

Covering Over Frames—Wintering Two Colonies in One Hive.

1. What sort of cloth or covering over the frames is best for wintering colonies?

2. Can two small colonies be wintered in one hive with a division-board between, with plenty of honey also, without having either queen destroyed?

We had a good season for honey, and fine honey, too. I have successfully kept down swarming the past season, having had but one swarm from three strong colonies.

The Bee Journal should be read by all bee-keepers, whether large or small; certain articles, alone, being worth the subscription price.

W. G.

ANSWERS.—1. Perhaps the most popular covering nowadays is a pine board with no cloth whatever. If you winter your bees out-doors, having a very small entrance and depending on what are called absorbents—that is, some kind of packing on top that shall allow the air and vapor to pass up through very slowly—then there is nothing perhaps better than some coarse, open cloth such as burlap. If you have a large entrance so that all can be closed above, then it matters little what kind of cloth is above, or whether it be a board. But in any case it is probably better to have a packing over the top, for without that there is danger of the moisture in the hive condensing above the bees and giving them a cold

bath. In the cellar it doesn't make so much difference, but even there it's a good thing to have them warm overhead, then you can give them unlimited ventilation below.

2. No trouble at all about it. I've wintered dozens in that way. Be sure that your division-board is bee-tight. Make it of thin boards not more than $\frac{3}{4}$ thick. Have the entrances five or six inches apart. Let the cluster of bees on each side be close up to the division-board. Then the two nuclei will cluster in one sphere just as though there was a single colony with the thin board pushed down through the middle.

"Adels" vs. Italians—Some Bees that Work More than Others.

1. What difference is there between the Adel bees and the Italians? (Our bees are mixed, Italian and German.) I cannot see any difference in the markings. I think the Adels are about the size of the mongrels, and probably the abdomen is a little flatter and blunter. I think the Italians are a little smaller, and in shape like the mongrels. Are the Adels non-swarmers, and don't they sting? Are they good workers?

2. I have just been looking at the bees, and one colony is working like in summer, and most of the others not a bee is out. It is a hybrid that is working. Why?

Steveston, B. C., Oct. 14.

M. S.

ANSWERS.—1. If I am rightly informed, the Adel bees are Carniolans. The name was given to them in this country, and I suppose you have the same right to give any name you please to any strain of bees you may cultivate. Adel is the German word for "nobility," and the claim is made for these bees that they have not swarmed, a claim that has been made for other strains, but so far this trait does not seem to have remained permanently with any. I did not know that the Adels were non-stingers, but you probably can tell whether yours are or not.

2. It isn't easy to say. Of course, there must be some reason for it, and that reason may lie in the natural traits of the colony, or it may lie in the different conditions. Some families seem to be more industrious than others under the same conditions. A very strong colony might have bees out at work while the bees of weaker colonies remained at home. A colony whose queen had lately begun to lay might show more industry, and other conditions might also make a difference.

Uniting Late in the Fall—When to Sow Sweet Clover Seed.

1. What can I do with weak colonies that have not sufficient stores for wintering? Is it too late to feed them sugar syrup? or can I unite them? and how is that done at this time of the year?

Bees did not do well here the past summer. But very few people keep bees here, and those that do, want to sell. If I can unite or feed them I would like to buy, as I can buy at a trifle over the cost of hives.

2. I would also like to know when to sow sweet clover seed in this latitude.

J. U.

Glandorf, Ohio, Oct. 30.

ANSWERS.—1. Better unite than try feeding so late. Suppose you have two to unite. Go to the stronger of the two and take out the unoccupied frames, putting to one side of the hive the frames covered with bees. Then go to the weaker one and do the same thing, only instead of putting the frames to one side, put them in the center of the hive. Let them be so far from each other that you can squeeze the ends of your fingers between the top-bars. This can be done almost any time, but perhaps better on a day warm enough for bees to be astir. A day, or several days, later, when it's too cool for bees to be flying, carefully uncover the stronger colony, then go to the weaker one, lift out all the frames together—there will be only three or four of them, and you can lift all together by putting your fingers between them—then carry them to the other hive and space them up close to the frames already there. Then add the best frames of honey saved from each or got elsewhere. This is the plan followed by that excellent authority, G. M. Doolittle. But remember that no amount of uniting will be successful without stores, and be sure there are stores in plenty, only it will take less stores for the two together than if left separate. If you want to unite three, the third will be managed just as the second.—[For a detailed description of Mr. Doolittle's method of late uniting of colonies, see page 743 of this number.—EDITOR.]

2. [For a reply to this question see page 749.—EDITOR.]

The "Premium": A Good Watch Mailed Free!

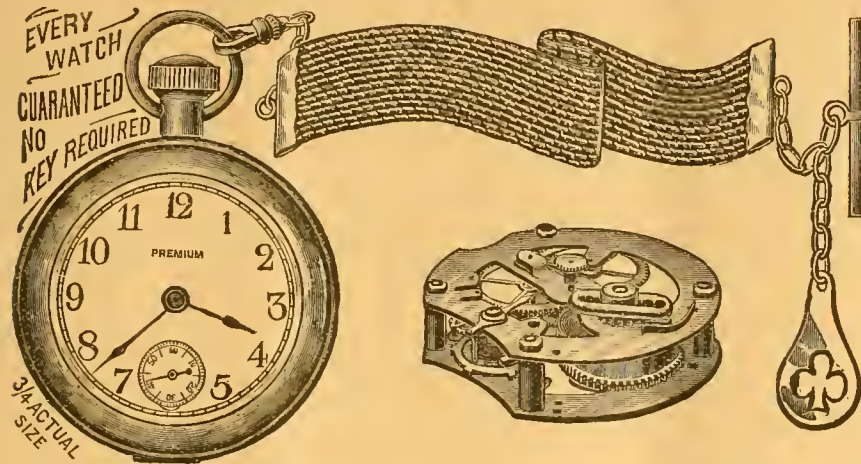

The movement of this Watch is regular American lever, lantern pinion, quick train, 240 beats per minute, three-quarter plate, short wind; runs 30 hours to one winding; dust cap over movement; every movement fully timed; regulated and guaranteed for one year, the same as a Waltham or Elgin; nickel finish, heavy bevel crystal, and back pinion wind and set.

OUR OFFERS:—We will mail the above Watch for \$1.25; or club it with the Bee Journal for a year—both together for \$2.10; or we will send it free as a premium for getting Three New yearly Subscribers to the Bee Journal at \$1.00 each. The Watch is mailed from New York City, so please allow a few days before expecting your order to be filled.

GEORGE W. YORK & CO., 118 Michigan St., Chicago, Ill.

❖ MONEY SAVED IS MONEY GAINED. ❖

THE ROYAL UNION Life Insurance Company

DES MOINES, IOWA.

The Iowa Policy

Is one that definitely promises to keep an accurate account with you; credit your premiums and interest, charge the actual expense and mortuary cost, and hold the remaining funds subject to your order.

Agents Wanted.

JOHN B. KING, GENERAL AGENT.
Suite 513 First Nat'l Bank Bld'g,
20A St CHICAGO, ILL.
Mention the American Bee Journal.

THROAT AND LUNG DISEASES,

DR. PEIRO, Specialist
Offices: 1019, 100 State St.,
CHICAGO. Hours 9 to 4.

Mention the American Bee Journal.

BASSWOOD Willow-Herb Extracted Honey.

We can furnish Willow-Herb Extracted Honey, in 60-pound tin cans, on board cars in Chicago, at these prices: 1 can, in a case, 8 cents per pound; 2 cans in one case, 7½ cents; 4 cans (2 cases) or more, 7¼ cents.

Basswood Honey in kegs holding about 270 lbs., net, at 7¼ cents. Cash must accompany each order.

A sample of the honey will be mailed to an intending purchaser, for 10 cents, to cover postage, packing, etc. We guarantee purity, and what we ship will be equal to sample.

Now it seems to us here is a splendid chance for any bee-keeper to supply his home demand after his own crop is all sold. Or, why not begin now to create a local honey-trade? Order one 60-pound can first, and start out among your neighbors and friends, and see what you can do. You ought to get at least 15 cents per pound in 5-pound lots, or 50 cents for 3 pounds. Some may be able to do even better than that, though we think that enough ought to be sold at these prices to make a fairly paying business out of it. Give it a good trial. Push it. It may grow into a nice winter's work for you.

GEORGE W. YORK & CO., 118 Michigan Street, CHICAGO, ILL.

General Items.

A Good Report.

From 12 colonies, spring count, I have taken 975 full sections, and 550 pounds of extracted—all white honey. I increased to 26 colonies—6 natural swarms and 8 artificial. They are all strong colonies, and have 30 to 40 pounds of honey for stores to each hive. My best colony gave me 176 sections of capped honey. I have sold most of my honey at home. There are no other bees within 50 miles of me.

The Bee Journal has been worth ten times its price to me; also Prof. Cook's "Manual of the Apiary." This is my second year in bee-keeping.

A. C. PORTER.
Merritt, Wash., Nov. 6.

Honey Candying as Fast as Stored.

Bees did fairly well the past season, which has just closed here. Tanglefoot is our last honey-plant to blossom, and is just now going out of bloom.

I ran my bees this year for extracted honey, and was confronted with a trouble which I never had to much of an extent before, which was the candying of the honey almost as soon as put into the hive. This caused me to get very little honey.

I should have said that tanglefoot generally furnishes winter stores, but failed to yield this fall, likely owing to a very light rainfall for the last seven months.

Success to the American Bee Journal.
JNO. M. KELLY.
Jackson Co., Ala., Nov. 4.

Thawing Out Bees and Uniting.

Since about the middle of September I have been on the bed a good deal of the time, with my old malady—heart disease. For a few days of this time my thoughts were not much of bees nor anything else terrestrial. Matters have lately taken a more favorable turn, and I am now taking care of my bees and some other things.

On election day I heard a neighbor, who lives about two miles away, say that he had cut a bee-tree in his pasture two or three days before. A bystander said the bees were still there, clustered near their old home. I felt some compassion for those forlorn bees, and, besides, I wanted some bees to strengthen a nucleus for wintering. It was too late to go for them that day, but the next morning I started with a box and cloth to cover it, and a section of honey in the box. The night had been cold, and I found the cluster stiff and motionless as if dead, but I scraped it into the box and saw some signs of life in the center of the cluster. When I got home with the bees there were no signs of life at all. I placed them near the fire and in the course of three or four hours all were lively. There is not much left of that section of honey, and some more sections which have been given them since I got them warmed into life.

It may be of interest to some of the readers to know how I united the cluster of bees referred to above, with the nucleus colony. I first place a queen-excluder on the hive containing the nucleus, and then spread a newspaper over

DUQUESNE COLLEGE!

PENN AVE. AND EIGHTH ST.

PITTSBURG, PA.

Thorough Courses—Classical, Scientific, Normal, English, Commercial, Preparatory, and Ladies Literary. Efficient and experienced instructors. Day and Night sessions.

Send for Catalog.

Mention the American Bee Journal.

IF YOU WANT THE

BEE-BOOK

That covers the whole Apicultural Field more completely than any other published, send \$1.25 to Prof. A. J. Cook, Claremont, Calif., for his

Bee-Keeper's Guide.

Liberal Discounts to the Trade.

Mention the American Bee Journal.

the excluder. Then I put on an empty hive and in this placed a few sections of unsealed honey. Then I tore out a little bit of the paper over the cluster of bees below, so as to leave one or two openings in the excluder bare. This was done in the early morning while the bees I wished to unite were clustered on the underside of the cloth which covered the box. Then I shook the bees from the cloth into the empty hive and put on the cover.

An hour or two later an examination showed the bees clustered on the under side of the cover. A later examination showed them on the sections of honey. An examination the next morning showed that the bees were all in the lower hive except the queen. She was running around the openings in the zinc. I placed my finger at the opening and the queen ran up on it, and I threw her out of the hive.

I had an idea that the sections of unsealed honey might in some way help to facilitate a peaceable union, but whether they cut any figure or not I am unable to say. If the bees had persisted in maintaining a separate existence for any considerable length of time, the honey might have been of some use. If the bees had not united in the course of two or three days, it was my intention to withdraw the newspaper and so force a union.

I may be in error, but I believe the above to be a safe and sure way of uniting.

EDWIN BEVINS.

Leon, Iowa, Nov. 6.

Weather Fine Every Day.

Bees were flying to-day as strong as in August. The weather is fine every day just now, with cool nights, but no frost. Bees are visiting the sugar refinery.

R. H. LANGDALE.

Vanconver, B. C., Oct. 26.

No Surplus Honey.

We had no surplus from our bees the past season in this locality, but have had to feed for winter. I have fed 1,500 pounds of syrup to 50 colonies in my apiary of 125.

J. FEW BROWN.

Winchester, Va., Nov. 5.

Bees Did Well.

My bees did well the past summer. My average was 45 pounds per colony, and all No. 1 comb honey. I get 20 cents per pound. I have 21 colonies, and transferred six into Improved Langstroth-Simplicity hives now; and arranged for comb honey. My hives are all 10-frame, 2-story, and well painted. I sowed two acres of sweet clover. It is something new in this part of the country. If it does well we will have more of it.

I hope the Bee Journal will keep on and increase its subscription list.

JOHN H. BECHTLE.

West Norwalk, Conn., Nov. 9.

Did Well for a New Hand.

I had 24 colonies of bees, spring count, and the average yield per colony was 35½ full sections of honey and 11 sections per colony that were not capped sufficiently for market. I attribute to bad management, having so many partly filled sections. We have had one of the



REV.
T. DE WITT
TALMAGE

In one of his wonderful sermons very truthfully said, "My brother, your trouble is not with the heart; it is a gastric disorder or a rebellious liver. It is not sin that blots out your hope of heaven, but bile that not only yellows your eyeballs and furs your tongue and makes your head ache but swoops upon your soul in dejection and forebodings,"—and

Talmage is right! All this trouble can be removed! You can be cured!

How? By using

Warner's
Safe Cure

We can give you incontrovertible proof from men and women, former sufferers,

But to-day well, and stay so.

There is no doubt of this. Twenty years experience proves our words true.

Write to-day for free treatment blank.

Warner's Safe Cure Co., Rochester, N. Y.

Mention the American Bee Journal.

RAIL ROAD LANDS

For Sale at Low Prices and on Easy Terms.

The Illinois Central Railroad Company offers for sale on easy terms and at low prices, 150,000 acres of choice fruit, gardening, farm and grazing lands located in

SOUTHERN ILLINOIS.

They are also largely interested in, and call especial attention to the 600,000 acres of land in the famous

YAZOO VALLEY OF MISSISSIPPI

lying along and owned by the Yazoo & Mississippi Valley Railroad Company, and which that company offers at low prices and on long terms. Special inducements and facilities offered to go and examine these lands, both in Southern Illinois and in the "Yazoo Valley," Miss. For further description, map, and any information, address or call upon E. P. SKENE, Land Commissioner, No. 1 Park Row, Chicago, Ill. 33D6t

Mention the American Bee Journal.

See the premium offer on page 749!

best honey seasons for three years, if I had been running the bees for extracted honey. It got so cold in August that the bees could not build combs. I did not get surplus honey of any amount after July, but I think I have done pretty well for as new a hand, and I credit my success to the American Bee Journal and "Langstroth on the Honey-Bee." Three years ago, when I subscribed for the Bee Journal, I did not know any more about a bee than a bee knew about me. I receive the Bee Journal every Thursday, generally read it over twice, and then get anxious for the next Thursday to come.

DANIEL SMETHURST.

Seneca, Wis., Nov. 9.

Not a Good Honey Year.

I had 9 good colonies last spring, increased to 18—5 natural swarms and lost three, and built up 4 colonies from others that didn't swarm, so now I have 18 in good condition for winter, that I will put into the cellar very soon if the snow doesn't go away.

I got 150 pounds of comb honey and about the same of extracted, and I have a fine lot of young queens for next season. This has not been a good year around here, as there has not been any white clover, and that is our main source here.

G. R. McCARTNEY.

Winnebago Co., Ill., Nov. 8.

One Pound from Ten Colonies!

One idea in the American Bee Journal is worth more than the price of the paper. My bees have not done much, as it has been so dry here, and as they were transferred from box-hives I did not expect them to do as well, but I shall claim the smallest record I have seen this year, viz., one solitary pound section from 10 colonies, and it was a full section of No. 1 honey. Who can beat this? I know of one colony in town which has put up 60 pounds of surplus this year, and we call that very large for the northeast. I wish that bee-keepers in the northeast would write more for the Bee Journal. I should be pleased to read some of Geo. S. Wheeler's articles, which he could write.

H. A. FISH.

S. Duxbury, Mass.

A Beginner's Report.

I am a beginner in bee-keeping. I started this year, by buying four colonies last winter. I could not wait until apple-blossom to transfer to my new 8-frame dovetailed hives, so I did it in April. I bought 6 colonies more in box-hives in May, transferred, and afterward I got 10 swarms from them. I cut 3 bee-trees and saved the bees, and caught 2 wandering swarms, the last one on the eve of July 21, and the morning of Aug. 11 I removed three 24-pound supers of honey, and each one of the 72 sections was perfect—the only colony that completed each section. My crop was 550 pounds of comb honey. Next fall I expect to go into winter quarters with 100 colonies. I now have 30.

Fulton Co., N. Y.

BEGINNER.

A Colony 114 Feet High.

Henry county has a beautiful court house, just completed, with a magnificent clock tower rising 114 feet above the busy little city of Paris. This house

cost Henry county between 35 and 40 thousand dollars. The cupola of the tower is covered with copper, and at the top forms a hollow, something like a large farm-bell with the clapper removed. In two or three days after this was finished, being somewhere near the first of October, an enormous swarm of black honey-bees settled on this place, and took possession of the hollow; on Oct. 10 thousands of the little black bees could be seen as they passed in and out of their copper home, paying no attention to the hundreds of people gathered below to listen to a big political speech. Although too late in the season for the bees to gather any honey, they seemed perfectly contented and at home.

For several years previous to removing the old court house, it was inhabited by a colony of the above-named "bugs." Paris, Tenn., Oct. 29. J. R. ADEN.

Our Darling Baby Hugh.

Died Sept. 30, 1896.

He played with me that very night
Before he went to bed,
And long before the morning light
My darling boy was dead.

And in the midst of all his pain
He sung his little song,
And then I knew our darling Hugh
Would not be with us long.

His troubles ended on this earth,
Upon that stormy night,
But Jesus led him by the hand,
And made his pathway bright.

He led him through the wilderness
And o'er the stormy sea,
And now he's on that brighter shore—
From pain and sorrow free.

I think I hear that gentle voice
When singing songs of love,
And calling us to come and join
The heavenly host above.

For Jesus said of children, dear,
Who unto him shall come,
That they should in his glory dwell,
And shine as doth the sun.

And now I know my darling boy
Is on that peaceful shore,
And ne'er again shall bear the pain
Of parting, sad and sore.

G. R. McCARTNEY.

Winnebago Co., Ill.

Sweet Clover Questions.—In

Gleanings for Nov. 1, we find the following enquiries regarding sweet clover:

For two years past I have gathered and sent to you the seed of sweet clover, without knowing whether it was of any value to farmers, having taken it mostly from the gravel-pits where the soil was removed to a depth of several feet. But noticing some peculiarities about the plant, I have become interested in it. I particularly want to know when and how it should be sown, and how much per acre. How should the crop be managed? I have seen it growing on very poor and hard clay land, and where the soil had been removed—places where red clover would not grow—and the question arises with me now, "Would not sweet clover be the proper crop on such lands for fodder, and to restore fertility?" I also noticed that in places where I cut a heavy crop last year, it was very small this year; and where I got none last year I cut a heavy crop this year. Why was this? Will it succeed if sown in

USEFUL AND POPULAR BOOKS.

WORKS OF INTEREST AND VALUE TO PEOPLE OF ALL CLASSES AND TASTES.

Each Book Consists of a Handsome Octavo Volume of 64 Large Double-Column Pages, Neatly Bound in an Attractive Paper Cover.

Brief descriptions of a select list of useful and popular books will be found below. These books cover a wide range of subjects, the object being to please all tastes and requirements. Each is a complete text-book upon the special theme of which it treats, and they are offered upon such terms as to place them within the reach of all. No man or woman can fail to be profited by the possession of these books; no home should be without them. Each book consists of a handsome octavo volume of 64 large double-column pages, nicely printed and bound in attractive paper covers. Many of them are handsomely illustrated:

No. 123. **How to Train Animals.** This book, written by an experienced animal trainer, tells how, to teach horses, dogs, cats, mules, goats, hogs and other animals, also birds, to perform the most remarkable tricks and feats of intelligence.

No. 132. **Every Boy His Own Toy-Maker.** A great book for boys, telling how to make a Steam Engine, Photographic Camera, Windmill, Microscope, Electrical Machine, Galvanic Battery, Electric Telegraph, Telephone, Magic Lantern, Boats, Kites, Balloons, and many other things.

No. 129. **The Practical Guide to Floriculture,** a complete practical guide to the culture of flowers and plants, by Ebea E. Rexford, one of the leading authorities upon all matters pertaining to floriculture.

No. 125. **Home Amusements,** a splendid collection of Games, Puzzles, Tricks, Diversions, Pastimes, Experiments, Tableaux Vivants, Shadow Pantomimes, Acting Charades and Proverbs, for social gatherings, public and private entertainments and evenings at home.

No. 130. **Modern Etiquette for all Occasions.** An excellent work upon this subject, containing the rules of deportment for all occasions, both for ladies and gentlemen, as observed by the best society.

No. 131. **The Ready Reference Manual of Facts, Figures and Statistics.** A collection of useful facts, figures, statistics and dates—a compendium of valuable information for the use of every man, woman and child, conveniently arranged for ready reference.

No. 117. **The Practical Poultry Keeper.** An entirely new book on poultry keeping, just published, involving the experience of successful poultry keepers, and embracing all the latest ideas on the subject.

No. 116. **The Practical Horse and Cattle Doctor.** This valuable book describes the symptoms of every disease with which horses and cattle are afflicted, gives the causes of such diseases, together with plain and explicit directions for their treatment.

No. 111. **The Handy Cyclopaedia of Every Day Wants,** a compendium of useful and valuable information, filled with practical receipts, hints, helps and suggestions, of the greatest use to every housekeeper.

No. 113. **The Family Doctor Book,** containing plain and simple directions for the treatment of every known disease or ailment of the human frame, and suggesting simple home remedies which usually effect a cure without the necessity of employing a physician.

No. 112. **The National Handy Dictionary,** a complete pocket dictionary of the English language, containing 33,000 words, with their orthography, definition and pronunciation, and 237 illustrations.

No. 115. **The Ladies' Model Fancy-Work Manual.** An entirely new book embodying all the latest ideas in needlework, crochet, knitting and embroidery. It contains many new lace and crochet patterns, and directions for making many articles of wearing apparel and for decorative purposes.

No. 115. **The American Family Cook Book.** A complete cook book, compiled by an experienced housekeeper, and containing more than seven hundred of the choicest recipes, classified for ready reference.

No. 135. **The Ladies' Guide to Beauty.** This book contains minute and practical instructions, accompanied by many valuable recipes, for securing a handsome form, a clear and smooth skin, a beautiful complexion, beautiful hair, etc., etc.

No. 117. **Mrs. Partington's Grab-Bag,** the contents of which are very, very funny. The last and best book written by B. P. Shillaber, the original Mrs. Partington.

No. 115. **Everybody's Law Book.** The object of this volume is to impart, in a simple, concise manner, the fullest information regarding legal matters. In all ordinary emergencies it will save employing a lawyer.

No. 137. **Phrenology Made Easy.** This book tells you how to read a person's character by the simple act of passing the fingers over the head, and the accuracy of these revelations will be a surprise to you and all your friends.

No. 113. **Lessons in Shorthand,** on Gurney's System. A complete instruction book in the art of phonography or shorthand writing, showing how any one may acquire and become proficient in this valuable art.



The above books in other editions are usually sold at 25 cents each, but

Read Our Liberal Offer: We will send any one of the above books by mail post-paid upon receipt of only Ten Cents; any four for Twenty-five Cents; any Ten for Fifty Cents. By buying ten books at a time you get them at half price. Please order by the numbers as given.

Read these Premium Offers: We will send any 5 (50 cents' worth) of the above-named books by mail post-paid, also the American Bee Journal for one year, upon receipt of only \$1.25; or we will send any 10 books (one dollar's worth) also the American Bee Journal for one year, upon receipt of only \$1.50. Send us **One New Subscriber** to the Bee Journal for one year (at \$1.00), and we will mail you free, as a premium, your choice of 10 of the above books. Address,

GEORGE W. YORK & CO., 118 Mich. St., CHICAGO, ILL.

fall or spring with wheat, like red clover, or should it be sown separate?

H. P.

East Bethany, N. Y., Sept. 29.

Mr. A. I. Root then gives this reply to H. P.'s questions:

Sweet clover can be sown at almost any season of the year, even late in the fall. We are sure this late sowing is all right; for where the railroad runs through our grounds the clover comes up every spring from self-sown seed dropped from plants where it grew. It is peculiar, and unlike any other plant in its wonderful habit of growing rank and strong on hard sub-soil, barren hill-sides, such as railroad embankments, gravel-pits along the highways, etc. In regard to its value for reclaiming barren soils, the Ohio Experiment Station made a test by plowing under a heavy growth of it before putting in wheat. Where no sweet clover was turned under the yield was about 18 bushels per acre; but on the ground fertilized by turning under the sweet clover, the yield was over 26 bushels per acre, and a corresponding increase in the amount of straw. One reason why it prepares the land for other crops is because the great roots going down to such a depth act somewhat as underdrains. Its value for cattle, horses, and other stock, has now been fully settled; but it must be cut or pastured when the plants are small, say a foot or two high. Of course, stock will eat it after they have become accustomed to it, when it is several feet high and in bloom. But its great value is to cut it before the buds show. The reason it is found in certain places one year and not the next is that it takes two years to perfect blossoms and seed. The old stalks will die, root and branch, after having produced seed. This seed, dropped on the ground, produces small plants that must grow one year before they in turn produce blossoms and seed.

Some years D. A. Jones, of Canada, suggests it in strips 10 or 15 feet wide, sowing alternate strips alternate years. In this way the tall plants will reach over the vacant strip and almost meet overhead. Then, after they die down, the young plants in the other strips will in like manner reach over, getting honey on the same ground every year. Its value for stock is easily shown by the fact that it is never found where horses or cattle are pastured. It makes its prodigious growth only along railroad grounds and highways, where stock is never turned out. I believe it does not succeed very well sown on wheat in the spring. In fact, I have never seen a real success with it on rich cultivated ground. If others have, I wish they would report.

APIARY FOR SALE 100 Coils, BEES, 2000 Surplus Combs, an Extractor, etc. 8 acres of land, house, shop, etc. 10 min. walk from P. O. Will sell land and bees separately. **J. M. BOUDNA,** 47A2 ALEXANDRIA, MINN.

Bee-Keepers' Photograph.—We have now on hand a limited number of excellent photographs of prominent bee-keepers—a number of pictures on one card. The likeness of 49 of them are shown on one of the photographs, and 121 on the other. We will send them, postpaid, for 30 cents each, mailing from the 121 kind first; then after they are all gone, we will send the 49 kind. So those who order first will get the most "faces" for their money. Send orders to the Bee Journal office.

THE "NOVELTY" POCKET-KNIFE!

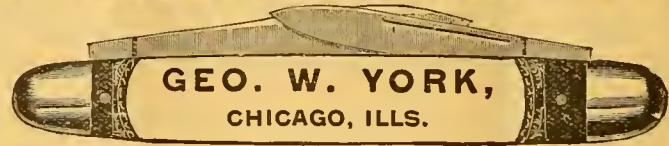

Your Name on the Knife.—When ordering, be sure to say just what Name and Address you wish put on the Knife.

The NOVELTY KNIFE is indeed a novelty. The novelty lies in the handle. It is made beautifully of indestructible celluloid, which is as transparent as glass. Underneath the celluloid, on one side of the handle is placed an AMERICAN BEE JOURNAL reminder, and on the other side, name and residence of the Subscriber.

The material entering into this celebrated knife is of the very best quality; the blades are handforged out of the very finest English razor-steel, and we warrant every blade. The bolsters are made of German silver, and will never rust or corrode. The rivets are hardened German silver wire; the linings are plate brass; the back springs of Sheffield spring steel, and the finish of handle as described above. It will last a lifetime, with proper usage.

Why purchase the Novelty Knife? In case a good knife is lost, the chances are, the owner will never recover it; but if the Novelty is lost, having name and address of owner, the finder will return it; otherwise to try to destroy the name and address, would destroy the knife. If traveling, and you meet with a serious accident, and are so fortunate as to have one of the Novelties, your pocket KNIFE will serve as an identifier; and in case of death, your relatives will at once be apprised of the accident.

How appropriate this knife is for a Christmas, New Year or birthday present! What more lasting memento could a mother give to a son, a wife to a husband, a sister to a brother, a lady to a gentleman, or vice versa, a son to a mother, a husband to a wife, a brother to a sister or a gentleman to a lady—the knife having the name of the recipient on one side?

The accompanying cut gives a faint idea, but cannot fully convey an exact representation of this beautiful knife, as the "Novelty" must be seen to be appreciated.

How to Get this Valuable Knife.—We send it postpaid, for \$1.00, or give it as a Premium to the one sending us three new Subscribers to the BEE JOURNAL (with \$3.00), and we will also send to each new name a copy of the Premium Edition of the book "Bees and Honey." We club the Novelty Knife with the BEE JOURNAL for one year, both for \$1.90.

Any Name and Address Put on the Knife.

GEORGE W. YORK & CO.,
CHICAGO, ILLS.

Allow about two weeks for your order to be filled.

California

If you care to know of its Fruits, Flowers Climate or Resources, send for a Sample Copy of California's Favorite Paper—

The Pacific Rural Press

The leading Horticultural and Agricultural paper of the Pacific Coast. Published weekly, handsomely illustrated, \$2.00 per annum. Sample Copy Free.

PACIFIC RURAL PRESS,
220 Market St., - SAN FRANCISCO, CAL.

MUTH'S HONEY EXTRACTOR

PERFECTION
Cold-Blast Smokers,
Square Glass Honey Jars, Etc.

For Circulars, apply to CHAS. F. MUTH & SON, Cor. Freeman & Central Aves., Cincinnati, O. Send 10c for Practical Hints to Bee-Keepers.

Mention the American Bee Journal.

COMB FOUNDATION

Wax always wanted for Cash or in Exchange for Fdn. or other Supplies. My trade is established on Low Prices and the merit of my Foundation. Orders filled promptly.

WORKING WAX INTO FON. BY THE LB. A SPECIALTY. Wholesale prices to dealers and large consumers. Send for Prices and Samples to—GUS DITTMER, AUGUSTA, WIS.

Reference—Augusta Bank. 1A1f

Mention the American Bee Journal.

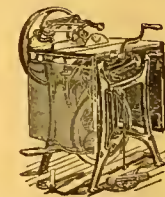

ONE MAN WITH THE UNION COMBINATION SAW

Can do the work of four men using hand tools. In Rippling, Cutting-off, Mitring, Rabbering, Grooving, Gaining, Dadoling, Edging-up, Jointing Stuff, etc. Full Line of Foot and Hand Power Machinery Sold on Trial. Catalogue Free.

SENECA FALLS MFG. CO.,
46 Water St., SENECA FALLS, N. Y.
1A1y Mention the American Bee Journal.

PROF. A. J. COOK'S BOOK FREE!

The Bee-Keeper's Guide MANUAL OF THE APIARY.

This 15th and latest edition of Prof. Cook's magnificent book of 460 pages, in neat and substantial cloth binding, we propose to give away to our present subscribers, for the work of getting NEW subscribers for the American Bee Journal.

A description of the book here is quite unnecessary—it is simply the most complete scientific and practical bee-book published today. Fully illustrated, and all written in the most fascinating style. The author is also too well-known to the whole bee-world to require any introduction. No bee-keeper is fully equipped, or his library complete, without "THE BEE-KEEPER'S GUIDE."

Given For 2 New Subscribers.

The following offer is made to PRESENT subscribers only, and no premium is also given to the two new subscribers—simply the Bee Journal for one year:

Send us Two New Subscribers to the Bee Journal (with \$2.00), and we will mail YOU a copy of Prof. Cook's book FREE as a premium. Prof. Cook's book alone sent for \$1.25, or we club it with the Bee Journal for a year—both together for only \$1.75. But surely anybody can get only 2 new subscribers to the Bee Journal for a year, and thus get the book as a premium. Let everybody try for it. Will you have one?

GEORGE W. YORK & CO., 118 Michigan St., CHICAGO, ILL.

Cash PAID FOR Beeswax

For all the **Good, Pure Yellow Beeswax** delivered to our office till further notice, we will pay 24 cents per pound, CASH; or 27 cents for whatever part is exchanged for the Bee Journal, Honey, Books or Seed, that we offer. If you want **cash, promptly**, for your Beeswax, send it on at once. Impure wax not taken at any price. Address as follows, very plainly,

GEO. W. YORK & CO.
118 Michigan st., CHICAGO, ILL.

HATCH Chickens BY STEAM
With the MODEL **EXCELSIOR Incubator**
Simple, Perfect, Self-Regulating. Thousands in successful operation. Lowest priced first-class Hatcher made.
GEO. H. STALL,
114 to 122 S. 6th St. Quincy, Ill.



44A26t Mention the American Bee Journal

40,000.
THE Nebraska Farmer
Has made a contract with the Nebraska Club, to print for them 40,000 copies over and above the regular weekly issue, each month for six months, of reliable information about Nebraska.
If interested, send for free copy, to
MR. CHAS. E. WILLIAMSON,
Secretary Nebraska Club,
OMAHA, NEBR., or
Nebraska Farmer Co.
Lincoln, Nebr.

44A13 Mention the American Bee Journal.

THROAT AND LUNG DISEASES,
DR. PEIRO, Specialist
Offices: 1019, 100 State St., CHICAGO. Hours 9 to 4.
Mention the American Bee Journal

Payne's Business Letter Writer and Manual of Commercial Forms.

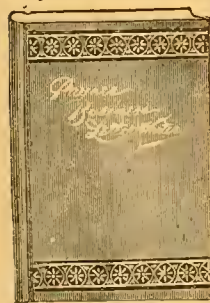

Containing specimen Letters on all possible business topics, with appropriate answers. Containing general information with regard to business matters, the rules for punctuation, the abbreviations most used in the mercantile world, a dictionary of mercantile terms, a table of synonyms, and other information which may be of value to the business man. New edition, revised and enlarged. 216 pages, Extra Cloth, 75 cts.

Special Offer: We will mail this book free as a premium to any one sending us two New Subscribers to the Bee Journal for one year (with \$2.00), and also send a copy of the premium book "Bees and Honey" to each of the new subscribers; or we will club the book with the Bee Journal for a year—both for \$1.60.

GEORGE W. YORK & CO.,
CHICAGO, ILLS

HONEY and BEESWAX

MARKET QUOTATIONS.

The following rules for grading honey were adopted by the North American Bee-Keepers' Association, and, so far as possible, quotations are made according to these rules:

FANCY.—All sections to be well filled; combs straight, of even thickness, and firmly attached to all four sides; both wood and comb unsoiled by travel-stain, or otherwise; all the cells sealed except the row of cells next the wood.

No. 1.—All sections well filled, but combs uneven or crooked, detached at the bottom, or with but few cells unsealed; both wood and comb unsoiled by travel-stain or otherwise.

In addition to this the honey is to be classified according to color, using the terms white, amber and dark. That is, there will be "fancy white," "No. 1 dark," etc.

Chicago, Ill., Nov. 7.—Fancy white, 12@13c.; No. 1, 11c.; fancy amber, 9@10c.; No. 1, 7@9c.; fancy dark, 8@9c.; No. 1, 7c. Extracted, white, 5@7c.; amber, 5@6c.; dark, 4½@5c. Beeswax, 26@27c.

The market up to, and at this time, is dull. The volume of sales is unusually small for this season of the year; especially is this true of comb.

Philadelphia, Pa., Nov. 7.—Fancy white comb, 13-14c.; No. 1 white, 11-12c.; fancy amber, 10-11c.; dark, 8-9c. Extracted, white, 6-8c.; amber, 4-5c.; dark, 3-4c. Beeswax, 26c. Comb honey arriving freely and market overstocked at present.

Detroit, Mich., Nov. 7.—No. 1 white, 12-12½c.; fancy amber, 10-11c.; No. 1 amber, 9-10c.; fancy dark, 8-9c. Extracted, white, 5½-6c.; amber, 5-5½c.; dark, 4-5c. Beeswax, 24-25c.

Indianapolis, Ind., Nov. 7.—Fancy white, 14-15c.; No. 1 white, 12-13c. Extracted, white, 6-7c. Beeswax, 22-25c. Demand is fair for grades quoted, but no demand for inferior grades.

New York, N. Y., Nov. 7.—Fancy white, 12c.; off grades, 10@11c.; buckwheat, 8@9c. No change in extracted. Beeswax firm at 26@27c.

The market is well supplied with comb honey of all grades and styles. Fancy white is in fair demand, while off grades white and buckwheat are moving off rather slowly.

Albany, N. Y., Nov. 7.—Fancy white, 12-13c.; No. 1, 11-12c.; fancy amber, 9-10c.; No. 1 dark, 8-9c. Extracted, white, 6-7c.; dark, 4-5c.

The receipts of both comb and extracted honey are very large, and prices are somewhat lower. We have an ample stock of all styles except paper cartons weighing less than a pound.

Cincinnati, Ohio, Nov. 7.—Comb honey, 10@14c., according to quality. Extracted, 3½@6c. Demand is slow for all kinds of honey, while the supply is good. Beeswax is in good demand at 20@25c. for good to choice yellow.

Cleveland, Ohio, Nov. 7.—Fancy white, 14½@15c.; No. 1 white, 12½@13c. Extracted, white, 6@7c.; amber, 4½@5½c. Beeswax, 22@25c.

There is not very much honey in our market. Selling rather slow. Demand beginning to be a little better. Think trade will be fair in this line this fall.

St. Louis, Mo., Nov. 9.—Fancy white, 14c.; No. 1 white, 12@13c.; fancy amber, 11@12c.; No. 1 amber, 10@10½c.; fancy dark, 9@9½c.; No. 1 dark, 7@8c. Extracted, white, in cans, 6@7c.; in barrels, 5@5½c.; amber, 4½@4¾c.; dark, 3½@4c. Beeswax, 26½@27c. Baker stock of extracted honey, 4@5c.; stock very scarce. Fair receipts of comb. Beeswax in good demand.

San Francisco, Calif., Nov. 7.—White comb, 10c.; amber, 7½-9c. Extracted, white, 5-5½c.; light amber, 4½-5c.; amber colored and candled, 3¾-4¼c.; dark tulle, 2¾-3c. Beeswax, fair to choice, 25-27½c.

Milwaukee, Wis., Nov. 7.—Fancy white, 14-15c.; No. 1, 12-13c.; No. 1 amber, 8-10c. Extracted, white, 6-7c.; amber, 5-6c.; dark, 4-5c. Beeswax, 22-24c.

New crop of honey begins to come forward. The demand is very poor and quotations almost nominal. Weather is very warm and the consumption of honey is very small. Plenty of fruit, and hence the appetite is satisfied with same in preference. Later on we expect an improved demand for honey of all kinds.

Minneapolis, Minn., Nov. 7.—Fancy white, 12½c.; No. 1 white, 10@11c.; fancy amber, 9@10c.; No. 1 amber, 8@9c.; fancy dark, 7@8c.; No. 1 dark, 6-8c. Extracted, white, 5½@6½c.; amber, 5@5½c.; dark, 4@5c. Beeswax, 23@26c.

The demand for both comb and extracted is very quiet, and for the latter, nominal. The hot weather of the past week or so has checked demand for comb honey.

Kansas City, Mo., Nov. 7.—Fancy white comb, 15c.; No. 1 white, 13@14c.; fancy amber, 12-13c.; No. 1 amber, 11-12c.; fancy dark, 10-11c.; No. 1, 8-10c. Extracted, white, 6-6½c.; amber, 5-5½c.; dark, 4-4½c. Beeswax, 22-25c.

Buffalo, N. Y., Nov. 7.—Strictly fancy comb, 12-pound, 12-13c.; fair to good, 9-10c.; dark, 7-8c.

Demand is much better for fancy, but common stock is very dull at any price.

Boston, Mass., Nov. 6.—Fancy white, 13-14c.; No. 1, 11-12c. Extracted, white, 6-7c.; amber, 5-6c. Beeswax, 25c.

List of Honey and Beeswax Dealers.

Most of whom Quote in this Journal.

Chicago, Ills.
R. A. BURNETT & Co., 163 South Water Street.

New York, N. Y.
HILDRETH BROS. & SEIGELCO.

Kansas City, Mo.
O. C. CLEMOMS & Co., 423 Walnut St.

Buffalo, N. Y.
BATERSON & Co., 167 & 169 Scott St.

Hamilton, Ills.
CHAS. DADANT & SON.

Philadelphia, Pa.
WM. A. SELSER, 10 Vine St.

Cleveland, Ohio.
WILLIAMS BROS., 80 & 82 Broadway.

St. Louis, Mo.
WESTCOTT COM. Co., 213 Market St.

Minneapolis, Minn.
S. H. HALL & Co.

Milwaukee, Wis.
A. V. BISHOP & Co.

Boston, Mass.
E. E. BLAKE & Co., 57 Chatham Street.

Detroit, Mich.
M. H. HUNT, Bell Branch, Wayne Co., Mich.

Indianapolis, Ind.
WALTER S. POWDER, 162 Massachusetts Ave.

Albany, N. Y.
CHAS. MCCULLOCH & Co., 380 Broadway.

Cincinnati, Ohio.
C. F. MUTH & SON, cor. Freeman & Central avs.

Convention Notices.

MINNESOTA.—The annual meeting of the Minnesota Bee-Keepers' Association will convene at the court house in Minneapolis on December 3, and continue in session two days. Crystal, Minn. E. K. JACQUES, Sec.

Wanted—To buy quantity lots of Fancy and No. 1 White Honey at prices to suit the times. B. WALKER, 45A Ewart, Mich.

WHEN ANSWERING THIS ADVERTISEMENT, MENTION THIS JOURNAL.

Bottom Prices

**BRING US BIG TRADE.
GOOD GOODS KEEP IT.**

If you want the best supplies that can be made at a little less cost than you can buy the same goods for elsewhere, write to us for low prices. 1896 Catalogue now ready—ask for it and a free copy of *The American Bee-Keeper* (36 pages).

Address,
THE W. T. FALCONER MFG. CO.,
JAMESTOWN, N. Y.
Mention the American Bee Journal.

Honey-Clovers & Buckwheat SEED FOR SALE.

We have made arrangements so that we can furnish seed of several of the Clovers and Japanese Buckwheat, by freight or express, at the following prices, cash with order:

	5lb	10lb	25lb	50lb
Alsike Clover.....	\$.70	\$1.25	\$3.00	\$ 5.75
Sweet Clover.....	.65	1.20	2.75	5.00
White Clover.....	1.25	2.00	4.50	8.00
Alfalfa Clover.....	.65	1.10	2.70	5.00
Crimson Clover....	.55	.90	2.00	3.50
Jap. Buckwheat....	.20	.35	.90	1.25

Prices subject to market changes.
Add 25 cents to your order, for cartage, if wanted by freight.
Your orders are solicited.

GEORGE W. YORK & CO.,
CHICAGO, ILLS.

BEGINNERS.

Beginners should have a copy of the *Amateur Bee-Keeper*, a 70-page book by Prof. J. W. Rouse. Price 25 cents; if sent by mail, 28c. The little book and the *Progressive Bee-Keeper* (a live, progressive 28-page monthly journal) one year, 65c. Address any first-class dealer, or

LEAHY MFG. CO., Higginsville, Mo.
WHEN ANSWERING THIS ADVERTISEMENT, MENTION THIS JOURNAL.

A Liberal Discount,

On **SUPPLIES** until Jan. 1, 1897. Write to us for prices on what you need, before placing your order.

Clover Ex. Honey, in Kegs, 7c per lb.

I. J. STRINGHAM,
105 Park Place. NEW YORK, N. Y.
APIARY—Glen Cove, L. I.

Mention the American Bee Journal.

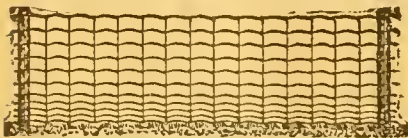

A Zoological Clearing House.

We are not only fencing the animals in the leading parks but furnishing specimens, when needed, and buying their surplus. In this way whole droves of deer, elk and buffalo have changed hands and the Page keeps right on holding them.

PAGE WOVEN WIRE FENCE CO., Adrian, Mich.
Mention the American Bee Journal.

READERS Of this Journal who write to any of our advertisers, either in ordering, or asking about the Goods offered, will please state that they saw the Advertisement in this paper.

BEE SWAX WANTED

—FOR—

Foundation Making.

Send For OUR CATALOGUE,

SAMPLES OF FOUNDATION,

ADVICE TO BEGINNERS, Etc.

Address,

CHAS. DADANT & SON,

WHEN ANSWERING THIS ADVERTISEMENT, MENTION THIS JOURNAL.

HAMILTON, ILL.

Ask Your Friends to Take This Journal.

* Extracted Honey *



Finest Quality. Basswood and Clover.
2 60-lb. cans in case, 7c. per pound. 1 60-lb. can in case, 8c. per pound. A sample by mail, 10 cts. **POUDER'S Honey-Jars and Complete Line of Supplies.** Catalogue Free.
WALTER S. POUDER,
162 Mass. Avenue. INDIANAPOLIS, IND.

PATENT WIRED COMB FOUNDATION



Has No Sag in Wood-Frames
Thin Flat-Bottom Foundation
Has No Fishbone in the Surplus Honey.
Being the cleanest is usually worked the quickest of any Foundation made
J. VAN DEUSEN & SONS,
Sole Manufacturers,
Sprout Brook Montgomery Co., N. Y.

A LARGE BOOK FREE.

To every new subscriber who sends us \$1.00, we will send him our journal—

Gleanings in Bee-Culture,

one year, and the book by A. I. Root, containing 190 pages, size 6¼x9½, entitled

What to Do, and How to be Happy while Doing It,

postpaid. The regular price of this work is 50 cents alone.

If you prefer, the journal may be sent to a friend, and you can keep the book for yourself.

THE A. I. ROOT COMPANY,
MEDINA, OHIO.

AMERICAN BEE JOURNAL

DEVOTED EXCLUSIVELY TO THE INTERESTS OF HONEY-PRODUCERS

ESTABLISHED 1861
THE OLDEST BEE-PAPER IN AMERICA

Published Weekly, at \$1.00 per annum.

Sample Copy sent on Application.

36th Year.

CHICAGO, ILL., NOVEMBER 26, 1896.

No. 48.

CONVENTION PROCEEDINGS

[Continued from page 741.]

THE REPORT IN FULL

OF THE
Twenty-Seventh Annual Convention
OF THE

North American Bee-Keepers' Association,

HELD AT
LINCOLN, NEBR., October 7 and 8, 1896.

BY DR. A. B. MASON, SECRETARY.

THURSDAY EVENING SESSION.

Pres. Root having started for home, the convention was called to order at 7:45 by the newly-elected President, George W. York.

Pres. York—I shall do my best in the office of President of this Association. I hope we will all work together to do what we can for its upbuilding. The first thing on our evening's program is a paper by Mr. C. P. Dadant, on "The Economic Value of Bees and Their Products."

Mr. Dadant being absent, his paper was begun by Secretary Mason and finished by Pres. York, as follows:

The Economic Value of Bees and Their Products

The discussion of the above subject may be made to embrace such an immense scope that it would be useless to try to point out more than a few of the leading questions involved in it. Being adverse to long essays myself, knowing also, by past experience, that essays, in a meeting like this, are only needed to introduce the subject, I will make my remarks very short.

In the consideration of this question, I would prefer to have had the bees left out, by the committee who ascribed this subject to me, for I confess that I cannot see any actual, direct economic value in the bees themselves, but only indirectly, through their products of honey and beeswax, and still more indirectly, through their action as pollen-carriers, upon the bloom of our domestic trees, plants and shrubs, to help fertilization, and thereby increase the yield of our farms, orchards and gardens. The discussion of this, it seems to me, should come under a different head.

The economic use of honey and its demand as an article of daily use in the household have greatly lessened since sugar has been produced cheaply and has become a part of the regular diet of every family. Honey, centuries ago, used to be the only sweet that was produced in abundance, and it filled many a purpose which is now fulfilled much more plentifully by

sugar. To-day honey should take the second place in price as well as in equality of demand and consumption were it not for its superiority in flavor. But although it takes but a comparatively small place in the enormous consumption of sweets, it is still the leader in price, for it is far above the other sweets as an unprepared or raw article of diet, manipulated only by the skill of Nature's chemistry. Evidently the choice article, the high-grade honey, will always keep its price far above that of all manufactured sweets.

But Nature's laboratory does not confine itself to one grade, and we have much honey which must needs compete on a level with the sweets of commerce, and it is for the sale of these grades that the bee-keeper is most in need of creating an increase of demand. In other words, it is most important for us to increase the economic value of the lowest grades of honey, by finding new channels for them, creating new uses.

In tobacco manufacturing, in candy-making, in the medicinal and veterinary uses, in baking, in brewing, in wine



C. P. Dadant.

and vinegar making, new markets have been opened, but we need still more uses for the product, for if we can find a ready sale for the cheapest grades of honey harvested in the apiary, the high grades will no longer drag on our markets. It is on this part of the economy of the apiary that more suggestions are needed.

In the Bulletin of the Society of "La Somme," which I received from France yesterday, I saw an article which has a bearing upon the question. A new use for honey has been discovered by a Mr. Poulet, who has succeeded in employing

it in the manufacture of chocolate, obtaining a most savory article of this substance by the use of honey with the cocoa. The advantage of this discovery, it is claimed, lies in being able to produce a better article at lower prices than the chocolate now manufactured. This discovery seems to have created quite a sensation in the above-mentioned association, and a committee was appointed to investigate the matter, in view of taking steps to establish a chocolate factory.

Is it necessary for us to mention the economic uses of beeswax? This article has so long been needed for so many different purposes in the arts as well as in medicine, in house-keeping and in manufacturing, its peculiar properties are so unique, and its need so well established, that all the cheap products that have been brought forward have been unable, in spite of adulteration and deception, to affect its price or the demand for it in its pure state. Beeswax never goes a-begging, and even if the prices fluctuate according to the greater or less production, it always commands as ready a sale at or about market quotations as the most staple products of the world.

Our attention is therefore most emphatically needed in the direction of the economic value of honey, and no pains should be spared by the bee-keepers to find new channels for the use of it.

C. P. DADANT.

Pres. York—Mr. Dadant's paper is how before you for discussion.

A. Laing—Does any one present know to what extent honey can be used in the manufacture of vinegar?

Dr. Mason—We have nine barrels of vinegar in our cellar. That is the way we get rid of the dark honey.

Mr. Laing—Is there any money in it?

Dr. Mason—Yes, sir; we sell it for 20 cents a gallon.

Mr. Kretchmer—We have several barrels of vinegar. Honey makes good vinegar, and a great amount of it can be produced.

Mr. Laing—What is the capacity of those barrels?

Dr. Mason—They hold 40 to 46 gallons. We use soft water; but hard water will do.

Pres. York—How many present have ever made honey-vinegar?

About ten voted.

Pres. York—I received a question on this subject about a week ago, and I have invited the Dadants to give an article on it, which will appear in the American Bee Journal.

Mr. Whitecomb—If it is prepared in this way, and then about three gallons of good honey-vinegar is added, and the mixture put out in the light, it will make vinegar in about four weeks.

Mr. Laing—Do you use about one pound of honey to a gallon of water?

Dr. Mason—Yes.

Mr. Kretchmer—We must consider that light and air are the two principal agents which convert sweets into alcohol, and alcohol into vinegar. Let the air and light get upon it, and your vinegar will be made in a very short time.

Dr. Mason—Our vinegar stands in the cellar with a cheese-cloth over it. If you want more rapid action, light, air, and warmth are desirable.

Pres. York—I would like to invite Professors Bessey and Bruner to the platform. Gentlemen, it gives me pleasure to inform you that you were to-day elected honorary members of this society.

Prof. Bessey—Mr. Chairman, it gives me very great pleasure to accept. I regard this as an honor uninvited on my part. If there is anything that I can do for you, I shall only be too happy to do so.

Prof. Bruner—Prof. Bessey has expressed my sentiments in a much better way than I could do it myself. I certainly appreciate this honor, and will do what I can to show you that I do. I shall give some study to bees in the near future, if not to bee-culture.

The following essay by Mr. Wm. Stolley, of Grand Island, Nebr., was read by Pres. York:

Sweet Clover (Melilot) as a Honey-Plant.

My experience respecting sweet clover was gained during the last 16 years. In the autumn of 1880, I sowed the first seed, and in the summer of 1882 I had the first sweet clover bloom for my bees to work on. My location is naturally not well adapted to bee-keeping, and what success I have had in the production of honey, I may say is nearly exclusively attributable to sweet clover growing in easy reach of my bees. Before sweet clover grew in larger quantities, I got some surplus in favorable seasons, but the honey was of a very inferior quality. Since I have sweet clover growing in sufficient quantity within easy reach of my bees, I consider that I have

a very satisfactory location with reliable resources for my bees.

I honestly believe that there is no nectar-yielding plant (having reference to Nebraska and adjoining States) that can in any way cope with sweet clover as to reliability as a honey-yielder.

While I write this (Sept. 20) the uncut melilot has considerable bloom on new shoots on the lower part of the stalks, while the ripe seed on the upper branches has already dropped to the ground. Sweet clover, which was cut about the first of July, is white with bloom, and bees work well on it. What final result the eventual spreading of sweet clover all over our State will bring about, remains to be seen.

I believe that sweet clover will soon enable the so-called Western States to rank with the best in the Union as to honey-production, although without sweet clover this never would be possible.

I have found that the driest seasons, and when nearly all other crops fail, sweet clover is at its best—and therefore I believe that tracts of sandy land, not redeemable by irrigation,

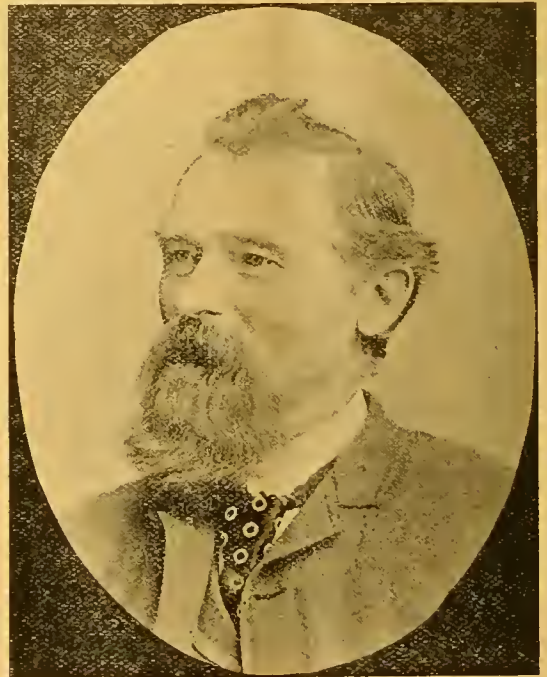

William Stolley.

will gradually be converted into first-class honey-ranches, with sheep-raising as an adjunct, by the rational culture of melilot.

The past summer's experience has taught me two new lessons about sweet clover. One of them is, that while a destructive hail storm destroyed the entire small grain crop in my neighborhood, sweet clover recovered so quickly from the temporary setback received, that hardly anything was lost to the bees. The other lesson is, that the early cutting of sweet clover, in June, does not always insure a second growth of it, if it happens that a very wet spell follows the cutting, and when the cutting is very close to the ground.

I lost a field of about four acres, which was cut on June 15, and was cut very close to the ground. The following 10 days we had nearly 5 inches of rainfall, and the land, although not overflowing, was kept very wet, and the result was that the entire field of melilot was killed out, hardly a plant escaping.

This season (1896) melilot began to bloom as early as June 15; in other seasons it is sometime a week later in blooming.

Now, when I state the result obtained in my apiary for the years 1895 and 1896, keeping in view that sweet clover was nearly my only reliable resource up to Sept. 1, as to surplus this year, I have said about all I can say about sweet clover as a honey-plant.

In 1895, my average surplus per colony was a little over 175 pounds, and my best colony gave me 236 pounds of surplus extracted honey.

This year (under adverse conditions) my average surplus per colony has been a little over 100 pounds, with from 35 to 40 pounds of winter stores in the brood-chambers; and my best colony has given me 210 pounds of surplus extracted honey. I had but 3 swarms from 26 colonies, but was compelled to increase up to 35 colonies, so as to prevent swarming as much as possible.

WM. STOLLEY.

Pres. York—Before I leave for my train, I wish to thank you all for the honor conferred on me. I hope to see every one of you at Buffalo next year, when we can have another reunion.

As Pres. York and E. R. Root had to leave to take the train for home, the convention took a recess of 10 minutes.

At 8:10 the newly-elected Vice-President, Mr. E. Whitcomb, took the chair, and announced that the discussion on Mr. Stolley's paper was open to the members.

Mr. Kretchmer—Sweet clover is a plant that should be propagated wherever it is possible. It will grow on the roadside without any attention, better than alfalfa. It will furnish pasturage for cattle. If cut before it gets too heavy or coarse, it makes excellent hay, but is better mixed with some other feed.

Mr. Stilson—We have had at the State Fair some very fine displays of sweet clover honey. I am convinced that nothing except irrigated alfalfa will produce as much honey as sweet clover. My bees gather honey from sweet clover from the first of June to the middle of October. If it is mowed off too low down the plant dies. As a forage plant, I consider it equal to alfalfa. If left till it grows too rank, it becomes a stiff stalk, and the leaves drop off. It should be cut for hay by the time the upper blossoms are beginning to ripen. It furnishes a very rich honey, which keeps well. It stands heat under almost any conditions. I kept a specimen in the sun for several weeks, but it stood up like loaf sugar. I am very much in favor of sweet clover. It will crowd out noxious weeds.

Dr. Mason—Mr. N. E. France, Secretary of the Wisconsin State Bee-Keepers' Association, sends a question concerning sweet clover as a noxious plant.

Miss Raser—Will cattle and horses eat this clover without being used to it?

Mrs. Amos—My cattle and horses eat sweet clover, and even reach over the fence after it.

Mr. Stilson—If stock get a taste of sweet clover in the spring of the year, they prefer it to anything else. If it gets rank, they will not touch it.

Mr. Aikin—We have considerable sweet clover in Colorado, but our farmers are fighting it continually. The question with them is how to get rid of it. They say it obstructs the irrigation ditches. I have seen it growing very luxuriantly on the very edge of the water in the ditches, where it cannot be mowed. The farmers say that no stock will touch it; but I have seen stock pastured on it to some extent. As a honey-plant it is certainly good. As long as it is in bloom, the bees are thick on it. I have one apiary located near sweet clover, and that gives me a better yield than any other.

Dr. Mason—I have but one colony at home, and that gave me 112 pounds of sweet clover comb honey this year.

Mr. Herrick—I have had some experience with sweet clover. It grows along a roadside near my place, in northern Illinois. I had a gravel pit on my farm. I scattered the seed in this because it was on my place. The other people carried it out along the roadside; I didn't do it. My cattle keep it eaten off so that it never blossoms to amount to anything. I think it makes excellent honey.

Mr. Laing—What would be the average crop of sweet clover honey to the colony?

Mr. Stilson—I have known 200 pounds in 30 days from sweet clover. I think it would yield as much or more than basswood, white clover, or anything else. The bees start on it not later than the first of July, and keep it up till August.

A Member—I have seen two kinds of sweet clover; one with a yellow blossom, the other with white. I would like to know the difference.

Prof. Bessy—Simply yellow sweet clover.

Vice-Pres. Whitcomb—We have a standing offer of \$100 to any one who will furnish evidence that sweet clover has encroached on any well cultivated land anywhere. The root serves the purpose of loosening the subsoil. It only lives two years. I regard it as one of the best honey-producing plants. It will produce from July 1 till frost, all the honey your bees can carry in. The bees work in sweet clover in hot days all the day long. I have been sowing it in the by-ways around my apiary. It has grown, although there has been a great drouth. It thrives anywhere, under almost any condition. I regard it as the stepping-stone for the bee-keeper in Nebraska.

Dr. Mason—Sometimes sweet clover does not yield honey. You cannot always rely on it in my locality in Ohio. One season I had 75 colonies, and they furnished me 70 pounds to the colony, and the nearest sweet clover was two miles away. Sweet clover will kill itself. It is the easiest plant in the world to eradicate. You need only to cut it very low down and it dies.

Mr. Kretchmer—The seed costs about \$6.50 a bushel. We sow about 12 pounds to the acre.

Vice-Pres. Whitcomb—We will now listen to the report of the Committee on Obituary.

Report of Committee on Resolutions.

The unwelcome shadow of death has invaded our Association since our last meeting, by the removal of three of our beloved and honored members.

It has pleased the All-wise Father to call to his eternal reward the Rev. L. L. Langstroth—the father of American bee-keeping—author, preacher, orator, Nature's nobleman—a man of pure character and life, a sweet and generous disposition. Improved bee-keeping in this country owes a great deal to his patient investigations and inventive mind. History will write his name in the roll of honor high among those who have been a blessing to his fellowmen. We offer only a just tribute to his memory when we record our appreciation of his great services to the bee-keeping fraternity, the cause of science, and the great army of consumers who are permitted to use more of Nature's perfect sweet than might have been possible had our honored friend never lived.

In the death also of Allen Pringle, of Ontario, Canada, and B. Taylor, of Minnesota, this Association has lost two able and valued members. Therefore, be it

Resolved, That we deplore the loss of these brothers and fathers in bee-keeping. We shall miss their pleasant faces at our meetings; and we shall miss their valued contributions to our journals. We extend to the bereaved families of these deceased members the warmest sympathy of the members of this Association.

EUGENE SECOR,
E. WHITCOMB, } Com.
A. LAING,

Mr. Stilson—I move the adoption of the resolutions read by a rising vote. The motion was carried, and the report of the committee adopted.

Mr. Herrick—I move that a copy of these resolutions be sent to the families of the deceased. Carried.

Vice-Pres. Whitcomb—I will appoint Mr. Secor as a committee to draft resolutions of thanks to the city of Lincoln, the Chancellor, Professors Bruner and Bessey, and the University for the use of these rooms.

Dr. Mason—We want these thanks extended to all of them, including Messrs. Stilson, Whitcomb, Heath, etc.

Vice-Pres. Whitcomb—Mr. Stilson and myself have done nothing but come down here and live on the city of Lincoln.

The next thing was a paper by Mr. N. E. France, of Platteville, Wis., and read by Dr. Mason, on

The Production of Extracted Honey.

Much depends upon location, markets and management, as well as kind of hives, bees, and supplies used.

First of all, have a system to the business; everything to have a place, and when not in use will be found cleaned and in its proper place.

As soon as our harvest season is over, we begin to make everything possible ready for next season's harvest. It takes less time and money to have all hives, frames, with either full combs, or full sheets of foundation, packages for next crop, tools, etc.—in fact, everything to be ready by spring.

One of America's greatest business men was invited for a speech to a University graduating class. Subject—"How to be Successful." His speech consisted of these words: "Know your business first, then push it; but never let it push you." Fellow bee-keepers, that will apply to our industry as well.

Large hives, strong colonies, plenty of good honey in store, especially for winter, abundance of full combs in upper stories, no swarming or laying out in working season, with room for the queen and storage of honey, young laying queens in early fall, and best of improved supplies to work with. Add to these good location for honey and marketing with favorable seasons, and *paying* harvests will be in return.

We prefer out-door wintering in large chaff-packed hives, as our colonies are better able to stand the spring weather, and have an abundance of young bees by the first spring bloom. As the most of our bees are in out-aparies, 4 to 6

miles from home, we rent the ground they occupy in the pasture, and do all the work ourselves. We clip all queens in spring while equalizing. On each hive we keep a record of the queen and work done, which I think is necessary.

As soon as the harvest season begins, our colonies are very strong, often queen-cells started. We then divide them as we think best, taking from each colony from one to three or four brood-combs with adhering bees, and form new colonies on new stands, as strong as any in the yard. We leave them a queen-cell from selected stock, and put on all hives the upper stories of full combs.

With plenty of room for brood and honey, the bees are always busy, with no time for swarming or loafers on the outside of the hive.

It has been my pleasure to visit many bee-keepers, and often I have been surprised to see them working hard, and to their loss, by using old, out-of-date tools. It is not economy to work with such implements if one's time is worth anything.

I have no ax to grind, nor supplies to sell, nor interested in any dealer, but, as I said, we can't afford to use such old tools, if our time is of any value. I have tried many kinds, and my choice for extracted honey is a Crane smoker, Bingham uncapping knife, Dadant's uncapping can, Van Allen &



N. E. France.

Williams reversible extractor; a good straw hat with cotton-tulle veil with wide silk-tulle face; Weed process full sheets of foundation; and a good-seasoned white-oak barrel, iron-hooped, that never leaks, and will stand shipping any distance.

N. E. FRANCE.

Vice-Pres. Whitcomb—The discussion on this paper is now open to the members.

Mr. Kretchmer—I desire to bring up one thing which Mr. France mentions, and that is the use of white-oak barrels for the storage of honey. I think galvanized-steel tanks are better.

Mr. Aikin—I used white-oak barrels for two years, then put more hoops on them, driving them tight, and used them to ship heart's-ease honey from Iowa to Colorado. When we arrived, I put them out in the weather. Before long you could push the hoops off with your hands. And these were extra good barrels.

Mr. Stinson—These gentlemen have not given us the relative amounts of extracted and comb honey produced by them. Here in Nebraska I produce four pounds of extracted honey where I can produce one of comb. My reason for this is that the honey-comb is already made. It is better to dip the combs, frames and all, into warm water, then put them in the hot sunshine and let them dry. I hold my bees back in the spring as long as I can. Then I feed them their syrup as fast as possible. I use the Hill feeder. I begin to build up my

hives with frames about the middle of April. We keep them warm by packing.

Mr. Kretchmer—I keep my bees in the cellar till they can come out and feed on the pollen—till the elm is in bloom. We produce both comb and extracted honey. The amount of extracted honey will double the comb honey, or even more than that.

Mr. Frazier—I produce chiefly extracted honey, and get about three times the yield of it that I get of comb honey.

Mr. Gale—I would like to know how many use queen-excluders. [8, yes; 4, no.]

Dr. Mason—In my locality the honey-yield is so uncertain that sometimes the bees scarcely get enough to keep themselves unless I use a queen-excluder; but when I use it I seldom fail to get a surplus.

Mr. DeLong—I produced four times as much extracted as comb honey. I never used a queen-excluder, and I never knew the queen to go higher than the second story. I use the Boardman feeder constantly till the first of August. I want as much as two colonies to a hive—with not less than 50,000 to 80,000 bees to a colony.

Vice-Pres. Whitcomb—Let us now have the report of the Committee on Thanks.

The report was read by Mr. Secor, and unanimously adopted as follows:

Resolved, That this Association hereby extends its sincere and hearty thanks to the Local Committee of the Nebraska Bee-keepers' Association, who have so successfully provided for the comfort of the members of the North American Bee-keepers' Association from outside the State; to the authorities of the Nebraska University for the rooms so cheerfully placed at our disposal, and for other courtesies extended. Especially would we name the Honored Chancellor McLean, Prof. Bessey and Prof. Bruner of the University, and Messrs. Whitcomb, Stillson and Heath, for attentions constantly bestowed. Our stay in Lincoln has been a delightful recreation, and we shall carry to our homes only pleasant memories of our visit to this great State. EUGENE SECOR, Com.

Wintering and Other Subjects.

Dr. Mason—I winter my bees in the cellar, with the hives piled on top of each other, without bottom-boards, and with the quilts on as left by the bees in the fall, and in the spring the hives are overflowing with bees.

Miss Raser—Do you leave the quilts on during the summer months?

Dr. Mason—Yes.

Mr. Patterson—I would like to know about what time you get your honey?

Dr. Mason—The flow begins in April, and lasts until frost.

Mr. Aikin—If the crop be taken in hot weather, I don't believe twice as much extracted as comb honey can be produced.

Mr. Patterson—In cool nights the bees would be driven entirely from the supers.

Mr. Gale—If we give the bees plenty to eat and room to work in we will have bees enough.

Dr. Mason—Localities differ as to the time of honey-flow. Our white clover commences in April and May; you can't get too many bees.

Mr. Patterson—Why not have more queens to build up the colony, even four or five to a colony? I experimented with that once. I took several queens and destinged them. Then I cut off a little from one jaw. But when the time came to lay, they all disappeared but one. I don't know what was the matter.

Mrs. Whitcomb—I think the trouble was that he didn't "dehorn" them. [Laughter.]

Mr. Patterson—I think if I had time I could make a success of it.

Dr. Mason—It was expected that all the papers on the program would be here. The one by Mr. Holtermann could not be prepared on account of his work. Mr. Hutchinson has had so much sickness and misfortune in his family that he could not prepare his paper. Mr. Hilton is chairman of some political committee, and is probably too busy saving the country to write a paper on bees.

The Adulteration of Honey.

Vice-Pres. Whitcomb—I do not think there is any bee-keeper in Nebraska selling adulterated honey. I know there is a firm in Omaha selling glucosed honey, but they are not bee-keepers.

Mr. Kretchmer—Bee-keepers could not buy glucose, etc., and adulterate honey, because they would buy it in small quantities, and it would cost them more than the real honey.

Mr. Stilson—There is a practice of putting a small piece of honey-comb in a tumbler of glucose. I understand there is a firm in Omaha putting up such a compound. At the last session, our legislature passed a law giving a bounty to such manufacture!

Mr. Patterson—I am sorry to say that I differ from the gentlemen when he says there are no bee-keepers who adulterate honey. I know a man who used to "wear the stripes," who is now a bee-keeper, and I have been told that he now buys glucose by the barrel.

Mr. Stewart—This glucose business is a serious question. The question is how to drive the imitation honey out of the market. Dealers say they know it is not honey, but it sells. The people buy it because it is cheap, and they like the glass jars it is put up in. This is not only done in Omaha, but in other large cities, I believe. I know it is done in Burlington.

The following members paid their annual dues, and all except a few were present:

Rev. E. T. Abbott, St. Joseph, Mo.
 R. C. Aikin, Loveland, Colo.
 S. H. Beaver, Seward, Nebr.
 Fred Biesemier, Sterling, Nebr.
 L. M. Brown, Glen Ellen, Iowa.
 H. W. Congdon, Weeping Water, Nebr.
 B. F. Cowgill, Villisca, Iowa.
 Rev. Clay C. Cox, Lincoln, Nebr.
 T. R. DeLong, Angus, Nebr.
 Richard Douglas, Palmyra, Nebr.
 W. C. Frazier, Atlantic, Iowa.
 Geo. Gale, Adams, Nebr.
 E. B. Gladish, Higginsville, Mo.
 J. N. Heater, Columbus, Nebr.
 H. E. Heath, Lincoln, Nebr.
 S. H. Herrick, Rockford, Ill.
 O. L. Hershiser, Buffalo, N. Y.
 M. B. Holmes, Athens, Ont.
 R. F. Holtermann, Brantford, Ont.
 J. C. Knoll, Kearney, Nebr.
 E. Kretchmer, Red Oak, Iowa.
 R. W. Kretchmer, Red Oak, Iowa.
 A. Laing, Acton, Ont.
 F. C. LeFever, Junietta, Nebr.
 J. S. Lovell, Council Bluffs, Nebr.
 C. A. Luce, Republican City, Nebr.
 Geo. Ludwig, Lincoln, Nebr.
 Dr. A. B. Mason, Toledo, Ohio.
 J. H. Masters, Nebraska City, Nebr.
 J. W. Palsey, Wauhoon, Nebr.
 H. N. Patterson, Humboldt, Nebr.
 J. L. Patterson, Kearney, Nebr.
 J. C. Stewart, Arkangel, Mo.
 Richard Silver, Tamora, Nebr.
 L. D. Stilson, York, Nebr.
 L. O. Westcott, Swanton, Nebr.
 Hon. E. Whitcomb, Friend, Nebr.
 Charles White, Aurora, Nebr.
 G. M. Whitford, Arlington, Nebr.
 George W. York, Chicago, Ill.

LIFE MEMBERS PRESENT.

Dr. C. C. Miller, Marengo, Ill.
 A. I. Root, Medina, Ohio.
 E. R. Root, Medina, Ohio.
 Hon. Eugene Secor, Forest City, Iowa.

LADY MEMBERS PRESENT.

Mrs. E. T. Abbott, St. Joseph, Mo.
 Mrs. R. C. Aikin, Loveland, Colo.
 Mrs. A. L. Amos, Coburg, Nebr.
 Mrs. V. Collius, Chapman, Nebr.
 Mrs. M. V. Cook, Lincoln, Nebr.
 Mrs. J. N. Heater, Columbus, Nebr.
 Mrs. A. L. Hallenbeck, Millard, Nebr.
 Miss Jennie Raser, Chapman, Nebr.
 Mrs. Eugene Secor, Forest City, Iowa.
 Mrs. E. Whitcomb, Friend, Nebr.

HONORARY MEMBERS PRESENT.

Chancellor Geo. E. MacLean, University of Nebraska, Lincoln, Nebr.
 Prof. Charles E. Bessey, University of Nebraska, Lincoln, Nebr.
 Prof. Lawrence Bruner, University of Nebraska, Lincoln, Nebr.

The convention adjourned at about 10 a.m. to meet in Buffalo, N. Y., at the call of the Executive Committee.

A. B. MASON, Sec.

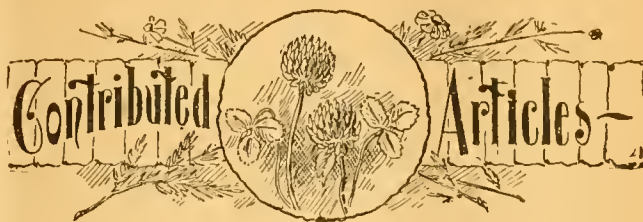

Bees and Pollen—Food of Larval Bees.

BY G. M. DOOLITTLE.

A correspondent wishes me to answer through the columns of the American Bee Journal these questions:

"Do old bees eat pollen? If so, under what circumstances? And is the food of the larval bee an animal secretion, or do the larvæ eat pollen?"

From careful observation for the past 25 years, I am certain that sometimes old bees eat pollen, but always under the same conditions and for the same purpose, that purpose being to bridge over a time of scarcity. But there may be times of scarcity when no pollen will be eaten, the eating of the pollen being conditioned on whether there is brood in the hive or not.

One year my bees had hardly a cell of honey in their hives during the forepart of June, at which time of year we have a scarcity of honey, but always plenty of pollen. By way of experiment I fed a part of the colonies, and let the rest go without feeding, to see if the bees in those hives having scarcely a cell of honey in them, but plenty of brood in all stages, would live if provided with pollen, which was given in abundance, as I had combs stored away which had plenty of pollen in them. As the weather at that time was so unfavorable that the bees did not fly for several days, I anxiously watched for them to see what they would do as soon as the few cells of honey which they had were gone. The first thing noted was, that, as soon as all the honey was gone, the larvæ were scrimped of food, and the eggs were removed from the cells and eaten by the bees (in my opinion, as I have seen bees eat eggs dropped by the queen), while, during the next day, there was a general eating of the larvæ.

The next day after, the sealed drone-brood was taken from the cells and sucked dry, while the harder parts were scattered about the entrance and bottom-board of the hive. At this time I noticed the bees putting their tongues together, as they do when young bees take a load of nectar from the field bees in time of plenty, which thing was continued till nearly all the pollen was used up in the hive, which lasted for several days, when it came good weather again, so new supplies were gathered. Since then I have noticed the same thing several times under like circumstances, but always when there was brood in the hive.

Remembering these facts, I tried the same experiment in the fall when there was no brood in the hive, at two different times, but in each case I succeeded in starving the colonies without a single cell of pollen being touched, as far as I could discover. From these experiments and observations I have formed the opinion that old bees partake of pollen only in the form of chyme, and that this chyme is prepared only when there is or has been brood lately in the hive.

As regards what the larval bees eat, I am not quite sure, but my opinion is that those who argue that the food fed them is purely an animal secretion are mistaken, for I have given this matter much careful thought, and have made many observations, and from this I have been led to believe that the food of the larval bee is composed of about two parts of honey or saccharine matter, four parts pollen or flour (when such is used in early spring as a substitute), and one part water, the whole being taken into the stomach of the bee and there through a partial digestion or otherwise formed into chyme, after which it is regurgitated and given to the larval bees by the nurse-bees, in the cream-like form as we see it in the cells. That the larval bee subsists wholly on this creamy food, or chyme, I think no one will deny; and if, from my personal observations I am correct, the largest element in the food is pollen.

As the larva absorbs this food, the grosser part of the pollen forms into the yellow line seen in all larvæ when taken out of the comb, but more plainly in the drone larvæ, which line is finally inclosed by the intestines of the newly-hatched bee, and evacuated on its first flight. Many others incline to the same belief, and to show how nearly they are to the above I will quote from a few of them.

A. I. Root says: "It is supposed that this larval food is pollen and honey, partially digested by the nursing-bees. Bees

of this age, or a little older, supply the royal jelly for the queen-cells, which is the same, I think, as the food given to the very small larvæ. Just before the larvæ of the worker-bees and drones are sealed up, they are fed on a coarser and less perfectly digested mixture of honey and pollen."

Prof. Cook says: "The food is composed of pollen and honey—certainly of pollen, for as I have repeatedly proven, without pollen no brood will be reared." Again he says: "The function of bee-bread is to help furnish the brood with proper food. In fact, brood-rearing would be impossible without it."

Quinby says: "How this food is prepared is mere conjecture. The supposition is, that it is chiefly composed of pollen. This is strongly indicated by the quantity which accumulates in colonies that lose their queens and rear no brood."

E. Gallup says: "Every bee-keeper ought to know that bees do not feed pollen directly to their young; but it is elaborated in the stomach of the bees into chyme to feed the young on."

Kirby says: "With this pollen, after it has undergone a conversion into a sort of whitish jelly by being received into the bee's stomach, where it is mixed with honey and regurgitated, the young brood, immediately upon their exclusion, and until their change into nymphs, are diligently fed by other bees, which anxiously attend them, and several times a day afford a fresh supply."

Neighbour says: "A portion of this pollen is taken at once by the nursing-bees, which are supposed to subject it to some change before offering it to the larvæ."

Gundelach says: "The larvæ is immediately fed by the workers with a pellucid jelly prepared in the chyle-stomachs by the digestion of honey and pollen mixed with water."

Thus it will be seen that all agree, that pollen enters largely into the food of the larval bee, and I think that it must be conclusive to all but the most skeptical that this is right.

Onondaga Co., N. Y.



Peddling Honey—Getting People to Buy.

BY F. A. SNELL.

I have found from experience that much more honey, especially extracted, can be sold by going from house to house, and allowing the people to sample the honey, than will be sold when left with the grocers on sale. Getting the people to sample the honey goes quite a way in the making of a sale or sales. Even if some desire to buy honey they forget it when in town trading, and so perhaps go without it for some time. When I desire to peddle honey I put a little comb honey up in crates holding 4, 8, or 12 boxes each. The extracted I now put up in 10-pound cans, mostly; but a few 5-pounds are put in so that, if a sale of a 10-pound can cannot be made, the 5-pound can may be just what is wanted by a customer.

A quantity of honey in the different packages is loaded into my buggy, and the start is made. I meet Mr. A., who lives about three miles from my home. I stop, take a can of honey, and loosen the screw-cap, and he samples it. I tell him I am out selling, and ask him if he doesn't want a can. The can is bought and paid for, and I drive on.

I stop at the next house, take in a can, and inquire if they are not ready for more honey. I am told that they yet have some of my honey on hand. I bid them good-day, and drive to the next place, at which I have sold honey for many years. A sale of one 10-pound can is made. We chat a little while, and I take my leave.

The next call is made. Mrs. D. does not desire to buy, but desires me to learn of Mr. D. as to the purchase, as he is from home. A few days later I see him, and he takes a can of 10 pounds. I next see Mr. E., have him sample my honey, and he takes a can. I next ask Mr. F. to sample my honey. He does so. I ask if he would not like a can of 10 pounds. He buys, and I deliver the can at his house. After a pleasant good-morning I state that Mr. F. bought a can of honey of me which I deliver. Mrs. F. is surprised, and says that she doesn't care much for honey, and her husband would have it to eat, and states they had some comb honey on hand, but did not eat any of it, and she had thrown it out. Some ten days later I saw Mr. F., and asked how the honey was going, and I stated what his wife had said. He laughed and said that she seemed to manage her share all right at least. He engaged the second can, to be bought later. In due time it was delivered. Mrs. F. said that she liked that honey well, and thought it very nice, and made no protest this time. The honey, I will say, was well ripened and very thick.

There is very much in properly caring for honey after its removal from the hives.

I next see Mr. G.; get him to sample my honey, and I sell him a 10-pound can.

Mr. H. is next seen. My honey is sampled, but he would wish only 5 pounds, and I sell him a 5-pound can.

I next call at the home of Mr. I. Mrs. I. samples the honey, and is pleased with it; inquires if I have 5-pound cans, stating that she would not care to buy so much as 10 pounds. I inform her that I have a few of the 5-pound cans, and will get one from the buggy. I do so, and receive pay for it. The price is 10 cents per pound for all extracted honey retailed.

Then two or three calls are made and no sales effected. The next sale made is of comb honey, that being preferred. I make the effort to sell 10 pounds at each sale, hence take the cans of that size when making my calls. Having the smaller cans, and some comb honey, I am prepared to suit the wish of all as to quantity. Very seldom do any wish less than 5 pounds; but if any will not use that amount I sell them 2½ or 3 pounds. A honey-leaflet is left with any new customers, which is helpful.

The bee-keeper can, when not busy with other work, take a load of principally extracted honey and sell it, when perhaps he would not be otherwise employed, and thus earn something more toward the keeping of the family. Any leisure time, be it half a day at a time only, and during autumn, I sell quite a nice lot of honey; or if, having business with some one several miles from home, several cans may be thus sold. On such a trip I called at the different families. To the family first called on I sold one 10-pound can; at the second place I took in a can, asked them to give me a saucelike dish so that I might let them sample the honey I had. The honey was tried, and seemed to please. The lady remarked that she had intended to get some at the store, but forgot it when in town, so they had been going without. They bought a 10-pound can, and, after a few minutes' chat, I took my leave. At the next place the family were from home. I called at the next house, and after sampling the honey, the people bought two cans, or 20 pounds. I was informed that they were short of change, but would leave the pay for the honey with our postmaster in a short time, which was satisfactory to me, as I well knew these people to be reliable. I next called at the place of my destination, and before leaving sold a 10-pound can and received my pay.

Thus five cans, or 50 pounds, were sold, bringing me \$5.00. The cans were returned, as I arranged to have them back when the sales are made near home. If the buyers neglect to return the cans, I call for them when passing that way. So it will be seen that the net price of the honey is 10 cents per pound when thus sold, the buyer retaining the cans until emptied. The extra time consumed in selling the 50 pounds on this trip did not exceed one hour, and my horse did not object to the short rests on the way in the least.

Many times I have taken along a few cans when going on similar trips, and sold from two to four or five cans on the way, at times going one road and returning by another, making stops both ways.

In peddling honey one must not be easily discouraged, for sometimes a number of calls may be made and no sales effected; and then, again, it is quite the reverse, and honey will be sold at nearly every point at which a stop is made. One must start out with full faith in his honey as being of fine quality, and cheerful in spirit, and a determination to sell to every family possible, even if only two or three pounds, leaving a leaflet at each place, and his honey-label on each can, with name and address, which should mention the candying of honey in cool weather, and how to liquefy.

I cannot agree with some bee-keepers who advise the selling of the poorer grades of extracted honey at home or in the home market. I believe a poor grade of this honey should never be sold at home, but sent off to be used in the packing of meats, or in factories where cheaper sweets are used. If this grade of honey be sent to a commission house, the apiarist should advise the firm of the shipment, grade of the honey, and the company to whom the honey is shipped will know at once where to place it in selling.

The selling of inferior extracted honey, or of a low grade, has, when sold for family use, done a great deal to injure the sale of honey, and is, I think, very unwise on the part of the apiarist who wishes to build up a good trade in honey, or hold one already obtained. One season the quality of our honey was very much injured by a mixture of so-called honey-dew. I offered no extracted honey for sale at home that season; and when asked by old customers if I had honey to sell, I informed them that I had no honey that I had extracted which was fit to eat, as it was mixed with so-called honey-dew, and dark and rank in flavor. Of our comb honey that season, the bet-

ter sections were picked out and sold; the dark (almost black) ones were given the bees the next spring. The extracted was sent to a commission firm and sold for the purposes above suggested, at the low figure of 5 cents per pound.—Gleanings.



The Laws of Breeding—Application to Bees.

BY PROF. A. J. COOK.

There is no chapter in recent history more replete with marvel, fascination, and real economic importance than that devoted to the laws and practice of breeding. A single generation has seen the startling development of the Hambletonian trotting-horse. What can rival in interest the work of the florist or plant-breeder as he originates those gems of the floral world, or those wonders of the garden? Who can eat the delicious chop from the Shropshire or Southdown; the appetizing steak from the Hereford or short-horn; or feast on our luscious fruits, without grateful acknowledgment of the blessings received at the hands of those who have applied the laws of breeding to the arts of life?

It is difficult to name a man who has done more brilliant service in the realm of scientific research than the late Charles Darwin. His writings have stimulated research to a marvelous extent; have quickened thought in all lines of investigation; have revolutionized ideas and theories in all the domains of investigation. Yet Darwin was directed to his fascinating and wonderful studies, by consideration of the breeding of plants and animals.

When Theodore Schwann, in 1839, discovered the nature of the cell, that it was the basal structure alike of all animal and vegetable tissue, he conferred an invaluable blessing on the world. Not only have all animals fundamentally the same structure, but all plants have just the same that all animals possess; and so the same laws of growth and development maintain with the simplest plant, like the seaweed, and the most complex shrub or tree, and also with the almost structureless protozoan, and the highest of animals—even to man himself. With this truth in view, we may, with sufficient caution, assume a truth regarding animal function or law from knowing it true of the vegetable world; likewise, and more safely, can we deduce a law of highest animals, even of man, from the fact that it always holds true of the lower, and contrariwise, a law of function in the higher will be likewise true of the lower. We hardly appreciate our indebtedness to this knowledge of the similarity of structure and functions between higher and lower animals.

The wondrous strides in surgery come from knowledge gained by work with lower animals. The beneficent work being done by the student of microbes, owes its value to the fact that all animals are similarly affected by the virus resulting from microbe affection. The human death rate is diminishing rapidly in all civilized countries, and the expectancy of life is correspondingly increasing. This gracious consummation is the result of the knowledge referred to above. Man has studied the lower animals, and by experimentation has arrived at conclusions that are of tremendous importance in maintaining health and prolonged life.

The method of reasoning referred to above, applies to the matter of inheritance and variation among animals; and consequently to the laws of breeding. And it is well known that the laws of breeding plants and animals are strikingly alike. All animals and all plants tend ever to vary, probably as they are differently impressed by a different environment. All inherit ancestral characteristics, or, we may say, that the hereditary tendency is manifest in both plants and animals. We should the more expect that insects and vertebrate animals would come under the same laws of inheritance. We are safe, then, in concluding that any law of breeding that is demonstrated in the vertebrate line of animal life, will hold as true among the insect class.

ESTABLISHED LAWS OF BREEDING.

Every intelligent breeder now recognizes that all his animals are subject to the law of variation. No offspring is precisely like its parent. Marked varieties among plants are known as sports, among animal as variations or varieties. Skillful breeders like Bakewell, Bates, Booth, and the Collins Brothers, are ever keenly on the watch for variations, and as keenly active to preserve desirable variations, and to suppress unfavorable ones. The most skillful breeder must be an artist. He has his ideal of excellence, and is ever watchful for all appearance of tendencies or variations towards his ideal. He selects with severest exactitude, and thus is ever building towards his idea of perfection. The ablest breeders, the, must have good judgment to decide wisely as to what is nearest perfection; must have quick vision to recognize every

departure towards his ideal type; must be resolute that unfavorable results shall be excluded, and full of patience to wait till he may reach the goal of his hopes.

The astute breeder recognizes that a long line of excellent progenitors, bred to a type with no out-cross, is very sure to result in progeny of equal or superior excellence. He knows that the parents are practically equal in their influence to control the offspring, if both parents have been well and carefully bred for a long series of years. He knows that if he persists he will reach excellence that will bless all the future, and reward him for patient waiting. And so he labors on with the enthusiasm and faith that cheers and lifts every true artist.

To recapitulate: The master breeder must have wisdom to build, in imagination, a type of animal of highest excellence; a quick vision to note every variation towards his ideal; a fixity of purpose that will unhesitatingly exclude any offspring that reaches away from his type; patience to wait for the slow process of variation and selection to modify, and the sure law of heredity to freeze into fixity the qualities he desires.

From what we have said in the foregoing, it follows that the laws established in breeding higher animals will prove equally potent in forming new breeds or races of bees. The skillful breeder in apiculture will wisely fix upon a high type of excellence. His typical bee will be, first, a business bee; the bee that will gather most, alike in good and poor seasons; the bee that will be too occupied with storing and breeding to even think of swarming till it is forced upon it by heedless management of the apiarist; the bee that will be so intent upon useful work, that it will not think to bristle up in anger except under severe provocation; the bee that will seek out Nature's sweets with such assiduity that it will have little cause to become a free-booter among its neighbors; a bee that will satisfy the lover of beauty, because "handsome is that handsome does."

The apiarian breeder will also know from his study of the laws of breeding that both male and female give characteristics, and are equally potent to transmit qualities if equally well bred; and will also know that prepotency ever hangs upon long, careful breeding.

I think there is everything to encourage the breeder in bee-keeping. I think that there has been very little real, scientific breeding yet practiced. If I am right it is a new field, and a wider, surer success awaits the earnest, conscientious, capable artist in this line of work.

As yet, few if any breeders of bees have formed as the result of long, hardy study, a type of perfection in the mind's eye. With no correct ideal before them, they of course could not, did not, work towards the highest excellence. Often—may I not say generally—bright, high color was the one attraction, and the entire trend was towards such beauty (?). Is not this the reason that our best bee-keepers prefer the less highly-colored bees, to the very gay, showy ones? From the laws as already explained, any such narrow, one-sided idea would slight all better ideals or qualities, and tend directly towards retrogression.

Again, circumstance has made it hard for resolution and patient persistence to maintain their ground, and work unceasingly, unhesitatingly, courageously, irresistibly towards a real ideal. The commercial spirit, demand of the market, bread and butter, all stand in the way. The ideal breeder must be one who will never listen to public demand, or trade preference. He must be willing to wait, and go on unmindful of what the public think or the market desires. He must look for his reward to the away-off future. A single generation saw the trotting-horse developed to its marvelous feats of speed. It has taken two or three generations to fashion our best beeves. It will take as many to build up to as great perfection the honey-bee. The fortunate one must have the qualifications already referred to, and, in addition, leisure, means, enthusiasm. We need some philanthropic master, some Cowan or Taylor, to go into this field. This would be a grand work for some experiment station. If these institutions could only be out of politics, and be fortunate enough to be supervised by a Board, wise to forecast results, and to see that scores of years were required to develop a Rothamstead, even though in the hands of a Sir John Lawes.

Claremont, Calif.



The McEvoy Foul Brood Treatment is given in Dr. Howard's pamphlet on "Foul Brood; Its Natural History and Rational Treatment." It is the latest publication on the subject, and should be in the hands of every bee-keeper. Price, 25 cents; or clubbed with the Bee Journal for one year—both for \$1.10.

OLDEST BEE PAPER IN AMERICA

THE AMERICAN BEE JOURNAL

ESTABLISHED IN 1861

GEORGE W. YORK, Editor.

PUBLISHED WEEKLY BY

GEORGE W. YORK & COMPANY,

118 Michigan St., CHICAGO, ILL.

\$1.00 a Year—Sample Copy Sent Free.

[Entered at the Post-Office at Chicago as Second-Class Mail-Matter.]

Vol. XXXVI. CHICAGO, ILL., NOV. 26, 1896. No. 48.

EDITORIAL COMMENTS.

The Lincoln Convention Report is completed in this number. We have tried to crowd it through as rapidly as possible, and have succeeded in giving a full session each week since we began it. We expect very soon to have it bound in pamphlet form and mail it to those who are now members of the Association.

California Bee-Keepers' Exchange.—Prof. Cook has this say about the prospects of the Exchange, and also regarding next year's honey crop in California:

The California Bee-Keepers' Exchange shows great vigor. Though born in a year of entire failure of the honey crop, it still holds on, and will be heard from in 1897, when we have reason to expect that California will harvest a phenomenal honey crop. If the bee-keepers of California will all join this organization, we believe that a saving of 25 per cent. on supplies can be secured, and a market obtained for all our best extracted honey at a minimum of six cents per pound.

Californians are now jubilant with hope. It is generally felt that early rains presage a wet season. It is rare in October to have any considerable rain. This season we have already had two fine rains—one prolonged for hours.

A Chapter on Swindlers.—In the October number of the Bee-Keepers' Review, Editor Hutchinson comes out in forcible style against Geo. T. Wheadon & Co., whom he investigated when in Chicago recently. Mr. H. tells his experience so interestingly, that we feel we can do no better than to copy it entire. It is rather lengthy, but it will well repay a reading, as it shows just how swindling commission firms "do business." Here is the story:

Twice, now, the Review has been led into accepting the advertisements of unreliable firms. That is putting it too mild, as in the last case, that of Geo. T. Wheadon & Co., it is a case of deliberate robbery. Gleanings has been wary and kept its foot out of the trap. The American Bee Journal and the Review were both caught by Horrie & Co., but only the Review was foolish enough to be caught by the Wheadon gang. I don't know as they tried to get Bro. York to advertise for them, but if they didn't, it was because they knew that he was on the spot and would "spot" them too quick. In both instances the Review took all ordinary precautions, but men who go to work to swindle the readers of a paper, see to it that the editors are well used and well paid, and that promptly, too. It is to their advantage to do so.

Of course, the Review doesn't lose money by accepting these advertisements, but it loses what is eventually money—the confidence of its readers. I am well aware that the readers of the Review well know that the Review would not *knowingly* accept the advertisement of a swindler; all the same, its endorsement of a new firm would not, I fear, now have enough weight to help that firm very much. There has been much said in the journals about patronizing only the old, established firms, but, somehow, I have felt that a new firm deserving of confidence ought to be encouraged, which may be true, but the

trouble is that some of the late new firms have been composed of old rascals. There seems to be a gang of swindlers that blossom out in a new place whenever the old location becomes too hot for them.

While on my way home from the fairs I stopped off in Chicago one day, and half of that time was passed in the office and warehouse of Geo. T. Wheadon & Co. They occupied one-half of a store, and some other commission firm the other half. Wheadon was not there. He would be there later. If I would come in between four and six o'clock I would surely catch him. I stayed all of the afternoon until the shades of night fell and the store was closed, but no Wheadon appeared, although some of his victims did. Nothing could be done, as Wheadon wasn't in. Neither was there any produce "in." Two 12-pound cases of honey was all there was on hand. Two crates of ducks were there when I came in, but they soon went out. A two-horse dray with "Geo. T. Wheadon & Co.," painted on its side came in several times loaded with barrels of apples. The driver said he was unloading a car for Wheadon, but the apples were taken in next door to Wheadon's. It is my opinion that they were sold to the neighbor before they were even unloaded. I had quite a talk with Wheadon's man (and he was an ill-looking imp, too, I can tell you), and he said that he knew very little about Wheadon's business. He was employed to receive whatever came in and sell it and turn the money over to Wheadon. At the end of the week he received his salary, and that was all he knew about it. I am well satisfied that he knew *exactly* what was going on.

Two or three times during the afternoon a tall, well-dressed, light-complexioned, good-looking fellow came in, and there were private conversations between the two, accompanied by many smirks, and winks, and sardonic grins, and finally I asked one of the men who worked for the other firm who that man was, and was told that it was McConkey. He is the man that was in partnership with C. R. Horrie. I had a long talk with one of the men who worked for the other firm, and he told me that Wheadon & Co. began business there last February, and for several months did an apparently honest business. They kept a half a dozen girls busy all of the time sending out circulars. Having in this way established confidence, they began holding on to all the money that they could get, paying no bills unless compelled to do so, and finally paying *nothing*, simply keeping a man there to receive any produce that came in and sell it at once and turn over the money. If irate shippers came in, none of the principals could be found.

While I was there a constable came there to arrest Wheadon. I knew this because he called me one side and asked me if I knew Wheadon, and finally he told me what he wanted, and showed me the warrant. I see by the last American Bee Journal that Wheadon has finally been arrested, and I only hope that he will get his just deserts. You see, when it gets too hot for these fellows, they keep out of sight, but keep a man there to receive and sell what produce comes in. An honest (?) thief is a respectable person compared to these human vampires that induce hard-working men and women to send in their products, representing, perhaps, the toil of a whole season, and then cheat them out of it.

I have taken all this space that my readers may know something of these human spiders and their dens, and when sending away their honey let them beware that it does not get into one of these dens. Never send honey to any dealer unless you *know* that he is reliable. There are such dealers, and we can learn which they are if we will take pains enough.

Remember, friends, that these same men are likely to turn up again, if not in Chicago, then in some other city, and they will play the same game, but I beg of you, *don't* send your honey to new, unknown firms, even if they do give what seems like the best of references.

It will scarcely be believed, and yet it is true, that the Atchleys—publishers of the Southland Queen—also published a full page advertisement for this same Wheadon & Co., in their October number, and that, too, after all we have said in the Bee Journal. To show how smart they are, the Atchleys gave this editorial explanation in the same issue of their paper:

"The advertisement of George T. Wheadon & Co. appears in this issue. The American Bee Journal says 'snide,' while Bradstreet's report for July gives them a rating of '\$10,000 to \$20,000—credit fair.' You pays yo' money an' takes yo' choice."

The Illinois State Convention was held in Chicago last week, and a very profitable meeting it was. While the attendance was not large, there was a deep interest

the entire two days. As perhaps many know, the Illinois State convention "goes it blind," as some might think, so far as a previously prepared program is concerned. It simply passes slips of paper among those in attendance, who hand in such questions as they most desire to have discussed. Of course, such a plan, in order to be a success, requires an unusually bright and active presiding officer, but Dr. Miller (the well-known President of the Illinois State Association) meets all requirements.

We expect soon to begin the publication of the report of the proceedings in full. We can promise you a rare treat, as an expert shorthand reporter did the work for us.

PERSONAL MENTION.

DR. C. C. MILLER spent several days with us last week, while attending the convention here. Although he's 65 years old, he seems as young-hearted as ever. We hope he may be spared yet many years to help on the work of practical bee-keeping.

MR. JONATHAN PERIAN, for many years the able editor of the *Prairie Farmer*, favored the Chicago convention with his presence at two of its sessions. He also took an active part in the discussion of the sweet clover question. His ideas will appear in the regular report, soon to be published in these columns.

MR. A. E. MANUM, of Vermont, has been secured to give a lecture on "Bees, Bee-Keeping, the Production of Honey, and Queen-Rearing," on Wednesday evening, Nov. 25, before the Bee-Keepers' Educational Society of Rhode Island, at Providence. Mr. Manum is one of the largest producers of honey and oldest queen-rearers in New England, and should be able to give a very instructive lecture. Mr. W. G. Gartside, 289 Globe St., Providence, R. I., is the Secretary of the Society.

MR. JAMES A. STONE, the friendly Secretary of the Illinois State Bee-Keepers' Association was able to be at the convention in Chicago last week only the second day. But all were very glad to have his presence half the time, if not at all the sessions. We don't know of another State secretary who works as hard for their association as Mr. Stone—and for so little pay. At the February Springfield meeting, he desires to meet every bee-keeper of Illinois. A full announcement of that occasion will appear soon. Begin to prepare to go.

THE FRANK B. WHITE COMPANY, a pushing young advertising firm of this city, gave the fourth annual banquet to the agricultural publishers and advertisers last Thursday evening, Nov. 19. About 150 partook of the splendid menu, and afterward listened to a number of the leading men who spoke upon various topics of interest to those present. Dr. Miller was honored with a place on the program, and talked on "The Busy Bee Advertiser." He stuck to his text about as closely as some colored preachers we have heard of. Perhaps we ought to add that he was informed in advance that he would "not have any trouble in saying almost anything he wanted to under that title." He simply took advantage of the liberty indicated, and finished on time.

The F. B. W. Co. is to be congratulated upon the great success of their annual "round ups."

Honey as Food and Medicine.—A new and revised edition of this 32-page pamphlet is now issued. It has 5 blank pages on which to write or paste recipes taken from other sources. It is just what its name indicates, and should be liberally distributed among the people everywhere to create a demand for honey. It contains a number of recipes on the use of honey as food and as medicine, besides much other interesting and valuable information. Prices, postpaid, are: Single copy, 5 cts.; 25 copies 65 cts.; 50 for \$1.00; 100 for \$1.50. Better give them a trial. Send all orders to the Bee Journal office.

White Comb Honey Wanted.—We would like to correspond with those having white comb honey for sale. Please let us know at once how much you have, etc. Address the Bee Journal office, 118 Michigan St., Chicago, Ill.

Questions AND Answers

CONDUCTED BY

DR. C. C. MILLER, MARENGO, ILL.

[Questions may be mailed to the Bee Journal, or to Dr. Miller direct.]

Candy for Wintering Bees.

1. I have 62 colonies of bees, all in 8-frame dovetailed hives. I am trying to farm and keep bees, and often I have so much to do on the farm that the bees have to take care of themselves. I have been looking them over, and some of them are pretty light. I could feed them syrup now, but the weather is so cold they will not carry it down. Can I feed them in the cellar after they are put in? Would not the soft candy do? How is it made? J. W. S.

Bradgate, Iowa.

ANSWERS.—1. It would hardly be wise to feed syrup at this time of the year, either in or out the cellar. Candy, either hard or soft can be fed. The materials for soft candy are powdered sugar and extracted honey. Use the very best quality of honey you have. Make a dough of the honey and sugar very stiff. You cannot do better than to follow the very explicit instructions given in Root's "A B C of Bee-Culture," which are as follows:

There is just one candy that is used universally by bee-keepers. Though used particularly as a food in queen-cages and pound cages, it is also used for feeding during winter or early spring. It is none other than what is popularly termed the "Good" candy, after I. R. Good, of Indiana, who introduced it in this country. It was, however, first invented by a German by the name of Scholz many years before Mr. Good introduced it. By Europeans it is therefore called the Scholz candy.

Make a stiff dough out of a first quality of extracted honey and powdered sugar. These are the directions that were given at first, but it would seem that, from the difference in results, more specific directions are necessary. Mr. J. D. Foushe (or, rather, his wife, who makes it for him) has been very successful in making candy. Their method is as follows: Take good thick honey and heat (not boil) it until it becomes very thin, and then stir in pulverized sugar. After stirring in all the sugar the honey will absorb, take it out of the utensil in which it is mixed, and thoroughly knead it with the hands. The kneading makes it more pliable and soft, so it will absorb, or, rather, take up more sugar. For summer use it should be worked, mixing in a little more sugar until the dough is so stiff as not to work readily, and it should then be allowed to stand for a day or two; and if then so soft as to run, a little more sugar should be kneaded in. A good deal will depend upon the season of the year. There should be more sugar in proportion to the honey in warm or hot weather, than for cool or cold weather. It should not be so hard in winter so but that the bees can easily eat it, nor should it be so soft in summer as to run and daub the bees. For this reason the honey, before mixing, should be heated so as to be reduced to a thin liquid. For shipping bees, the main thing to look out for is to see that the candy does not run nor yet get hard. It is one of the nice points in making this candy to make it just right. Don't delude yourself by the idea that a second quality of honey will do. Always use the nicest you have. We have had the best results with first quality of clover extracted. Sage honey, for some reason or other, has the property of rendering the candy in time as hard as a brick, and, of course, should not be used.

With the Good candy we have been enabled, with the Benton cage, to send queens not only across the continent and to the islands of the sea, but even to Australia, on a journey of 37 days. There is not very much trouble in mailing queens to Australia, if the candy can be made just right so as not to become too hard nor too soft on the journey. If it retains a mealy, moist condition, the bees will be pretty sure to go through all right.

There are some, perhaps, who would like to make the hard candy. The following are the directions we have used in the older editions of this work. The candy answers a very

good purpose, but it is a good deal more trouble to make it, and it can be used only for winter and spring feeding.

Into a tin sauce-pan put some granulated sugar with a little water—a very little water will do. Make it boil, and stir it; and when it is done enough to “grain” when stirred in a saucer, take it quickly from the stove. While it is “cooking,” do not let the fire touch the pan, but place the pan on the stove, and there will be no danger of its burning. Cover the dining-table with some newspapers, that you may have no troublesome daubs to clean up.

To see when it is just right, you can try dropping some on a saucer; and while you are at work, be sure to remember the little folks, who will doubtless take quite an interest in the proceedings, especially the baby. You can stir some until it is very white indeed for her; this will do very well for cream candy. We have formerly made our bee-candy hard and clear; but in this shape it is very apt to be sticky, unless we endanger having it burned, whereas if it is stirred we can have dry hard candy, of what would be only wax if cooled suddenly without the stirring. Besides we have much more moisture in the stirred sugar candy, and we want all the moisture we can possibly have, consistent with ease in handling.

If your candy is burned, no amount of boiling will make it hard, and your best way is to use it for cooking, or feeding the bees in summer weather. Burnt sugar is death to them if fed in cold weather. You can tell when it is burned by the smell, color, and taste. If you do not boil it enough, it will be soft and sticky in warm weather, and will be liable to drip when stored away. Perhaps you had better try a pound or two at first, while you “get your hand in.” Our first experiment was with 50 pounds; it all got “scorched” “somehow.”

As the most convenient way of feeding candy that will probably be devised is to put it into your regular brood-frames. I shall give directions for making it in that form. If you do not like it so, you can break it out, or cut it in smaller pieces with a knife, when nearly cold.

Lay your frames on a level table, or flat board; perhaps you had better use the flat board, for you need some nails or wires driven into it, to hold your frame down close, that the candy may not run out under it. Before you fasten the frame down, you will need to put a sheet of thin paper on your board, to prevent the candy's sticking. Fix the board exactly level, and you are all ready to make your candy. If you have many colonies that need feeding, you can get along faster by having several boards with frames fastened on them. You will need some sort of sauce-pan (any kind of a tin pan with a handle attached will do) that will hold 10 pounds of sugar. Put in a little water—no vinegar, cream-of-tartar, or anything of the sort is needed, whatever others may tell you—and boil it until it is ready to sugar off. You can determine when this point is reached, by stirring some in a saucer, or you can learn to test it as confectioners do, by dipping your finger in a cup of cold water, then in the kettle of candy, and back into the water again. When it breaks like egg-shells from the end of your finger, the candy is just right. Take it off the stove at once; and as soon as it begins to harden around the sides, give it a good stirring, and keep it up until it gets so thick that you can just pour it. Pour it into your frame, and get in just as much as you can without running it over. If it is done nicely, the slabs should look like marble when cold, and should be almost as clean and dry to handle. If you omit the stirring, your candy will be clear like glass, but it will be sticky to handle, and will be very apt to drip. The stirring causes all the water to be taken up in the crystallization, or graining process, and will make hard dry sugar of what would have otherwise been damp or waxy candy. If you wish to see how nicely it works for feeding bees, just hang out a slab and let the bees try it. They will carry it all away as peaceably as they would so much meal in the spring.

You can feed bees with this any day in winter, by hanging a frame of it close up to the cluster of bees. If you put it in the hive in very cold weather, it would be well to keep it in a warm room until well warmed through. Now remove one of the outside combs containing no bees, if you can find such a one, spread the cluster, and hang the frame in the center. Cover the bees at the sides and above, with cushions, and they will be all safe. If a colony needs only a little food, you can let them lick off what they like, and set the rest away until another time, or until another season. [Maple sugar, poured into wired frames while hot, makes excellent bee-candy. Cakes of maple sugar laid over the frames answer equally well.]

Drone-Laying Queen.

I have a young queen that was reared last spring. She layed well all summer, but for the last six weeks she has been

laying drone-eggs in the worker-comb. The brood is about half drone-brood. There is no attempt made to supersede, and the colony is too weak to think of swarming. The workers make no effort to drive out the drones. What is the cause of so many drones so late? Had I best supersede her next spring? Will those drones be good next spring?

Waring, Tex., Nov. 3.

A. G. A.

ANSWER.—Although the queen was reared last spring she is no doubt practically an old queen. The contents of her spermatheca are nearly exhausted, hence many of the eggs laid in worker-cells pass out without being fertilized, and can produce nothing but drones. In the spring such a queen would likely be superseded by the bees, but sometimes no such steps will be taken later in the season than the close of the honey harvest. Yes, supersede her in the spring if the colony is strong enough to be worth it, which is not at all certain. But in all probability the bees will see to the superseding in the spring without any meddling on your part. Drones from such a queen ought to be as good as any, providing they are reared in drone-cells.

Drops of Sweat over the Bees.

When I put oilcloth on top of my 8-frame hives, there are drops of sweat standing on the oilcloth. Will that do any damage? If so, what can I do to prevent it? J. S.

ANSWER.—Very decidedly, drops of sweat over the bees will do mischief. They will drop right down on the cluster of bees, chilling them badly. During very cold weather, frost will form on the oilcloth, then when it gets warmer it will melt and drench the poor bees. The drops of moisture form on the oilcloth because it is cold. Put plenty of covering of some kind over the oilcloth, then it won't be so cold. If you have nothing better, several thicknesses of old newspapers will help. If the packing cannot conveniently be put immediately over the oilcloth, it will do some good to put packing over the wood cover. A large entrance will be a help toward preventing the drops on the oilcloth. If the entrance is too small the moisture is confined in the hive and condensed on the cold surfaces.

Feeding Bees in the Cellar—Kind of Hive to Use.

1. Can I feed bees honey that has been melted in combs and all from the brood-nest?
2. Can bees be fed after they are put into the cellar?
3. Do you think it an advantage to have the bees on the supers?
4. As I am a beginner I have not fully satisfied myself as to what kind of hive I should adopt. Do you think I should try the Langstroth or Heddon? O. P. Goodhue Co., Minn.

ANSWERS.—1. You can melt up brood-combs and take the honey you get from them to feed the bees, providing the honey has not been burned. One way to avoid such overheating is to melt the combs in a vessel that stands inside another vessel containing water. For example, put a dripping-pan on the stove, and set in it the crock or dish containing the combs, first putting in the dripping-pan pieces of shingle or something of the kind to prevent the vessel from sitting close down on the bottom of the dripping-pan. Now fill up the dripping-pan with what water it will hold, and there will be no danger of burning the honey.

2. Yes, but it's ever and ever so much better to have them fed all they need as early as September, or even August. But it's better to feed them in the cellar than to let them starve. Give them combs of honey if possible, and if you can't do that give them sugar candy. [See page 761 for full directions.—EDITOR.]

3. I'm not sure whether I know what you mean by having bees on supers. If you mean giving to a swarm nothing but a super, I certainly shouldn't think there would be any advantage in that. More likely you mean having the swarm in an empty hive and then giving it the super that was on the parent hive. With the right precaution there is advantage in that. If given immediately on having the swarm, there is some danger that the queen may go up and lay in the super. To avoid this, put a queen-excluder between the hive and super, or else wait a day or so before giving the super, so the bees will make a start in the brood-chamber.

4. The majority of bee-keepers seem to prefer the Langstroth or Dovetail, so it is more likely you would be of that number; still there are a few who prefer the Heddon.

The "Premium": A Good Watch Mailed Free!

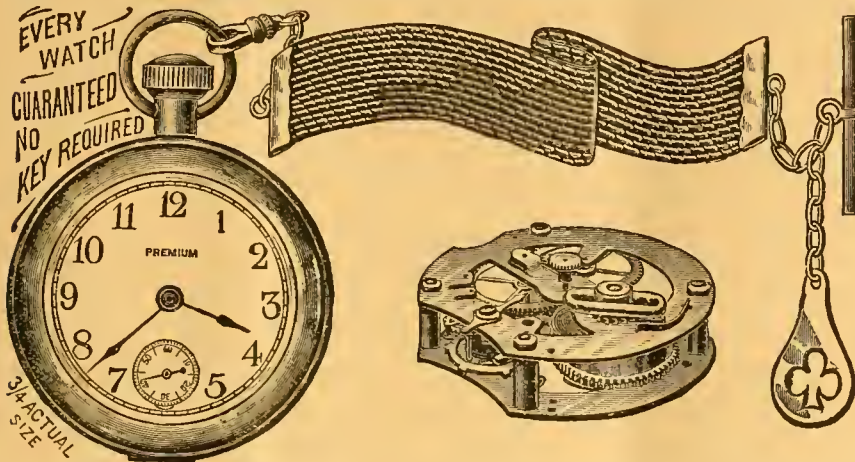

The movement of this Watch is regular American lever, lantern pinion, quick train, 240 beats per minute, three-quarter plate, short wind; runs 30 hours to one winding; dust cap over movement; every movement fully timed; regulated and guaranteed for one year, the same as a Waltham or Elgin; nickel finish, heavy bevel crystal, and back pinion wind and set.

OUR OFFERS:—We will mail the above Watch for \$1.25; or club it with the Bee Journal for a year—both together for \$2.10; or we will send it free as a premium for getting Three New yearly Subscribers to the Bee Journal at \$1.00 each. The Watch is mailed from New York City, so please allow a few days before expecting your order to be filled.

GEORGE W. YORK & CO., 118 Michigan St., Chicago, Ill.

✦ MONEY SAVED IS MONEY GAINED. ✦

THE ROYAL UNION Life Insurance Company DES MOINES, IOWA.

The Iowa Policy

Is one that definitely promises to keep an accurate account with you; credit your premiums and interest, charge the actual expense and mortuary cost, and hold the remaining funds subject to your order.

Agents Wanted.

JOHN B. KING, GENERAL AGENT,
Suite 513 First Nat'l Bank Bld'g,
20A St CHICAGO, ILL.

Mention the American Bee Journal.

THROAT AND LUNG DISEASES,
DR. PEIRO, Specialist
Offices: 1019, 100 State St.,
CHICAGO. Hours 9 to 4.

Mention the American Bee Journal.

DUQUESNE COLLEGE!

PENN AVE. AND EIGHTH ST.

PITTSBURG, PA.

Thorough Courses—Classical, Scientific, Normal, English, Commercial, Preparatory, and Ladies Literary. Efficient and experienced instructors. Day and Night sessions.

Send for Catalog.

Mention the American Bee Journal.

IF YOU WANT THE

BEE-BOOK

That covers the whole Apicultural Field more completely than any other published, send \$1.25 to Prof. A. J. Cook, Claremont, Calif., for his

Bee-Keeper's Guide.

Liberal Discounts to the Trade.

Mention the American Bee Journal.

BASSWOOD Willow-Herb Extracted Honey.

We can furnish Willow-Herb Extracted Honey, in 60-pound tin cans, on board cars in Chicago, at these prices: 1 can, in a case, 8 cents per pound; 2 cans in one case, 7½ cents; 4 cans (2 cases) or more, 7¼ cents.

Basswood Honey in kegs holding about 270 lbs., net, at 7¼ cents. Cash must accompany each order.

A sample of the honey will be mailed to an intending purchaser, for 10 cents, to cover postage, packing, etc. We guarantee purity, and what we ship will be equal to sample.

Now it seems to us here is a splendid chance for any bee-keeper to supply his home demand after his own crop is all sold. Or, why not begin now to create a local honey-trade? Order one 60-pound can first, and start out among your neighbors and friends, and see what you can do. You ought to get at least 15 cents per pound in 5-pound lots, or 50 cents for 3 pounds. Some may be able to do even better than that, though we think that enough ought to be sold at these prices to make a fairly paying business out of it. Give it a good trial. Push it. It may grow into a nice winter's work for you.

GEORGE W. YORK & CO., 118 Michigan Street, CHICAGO, ILL.

General Items.

Very Successful Year.

This has been a very successful year in the bee-business here. Bees have done well. My 67 colonies are all in winter quarters. I hope they will be all right next spring. My honey took the first and second premiums at our county fair this fall. MRS. A. A. SIMPSON.
Greene Co., Pa., Nov. 11.

Why Some Folks Can't Eat Honey.

I cannot give you a learned, scientific article, as I never had the advantage of education; still I can give my views in plain English, so as to make myself understood.

On page 642, Prof. A. J. Cook speaks of the reason why some cannot eat honey. It seems most likely that the deleterious element is the formic acid added to the sweet by the bee. Now, Professor, I am after you with some of my ideas. I have made the subject of why good, healthy food should hurt anyone's stomach a serious study for 40 years, and have come to the firm conclusion that it never does hurt anyone, as they or you suppose. God made man upright, but the foolish fellow has sought out many inventions. Now, A. I. Root will say that food certainly hurts his stomach, therefore he eats lean beef. A Mr. Huddleston, of Eimodena, Calif., drugged for three years, emaciated to a skeleton, given up to die with chronic diarrhea, was cured entirely in six treatments. He was positive his food hurt him. I was just as positive it did not.

A Mr. Willets lay at the point of death, helpless and speechless. He was up and out-doors the third day, and could eat anything. A Mr. Way was cured entirely in five treatments. All kinds of food, he said, disturbed his stomach. A Mr. Prichard was in the same fix, and was cured in three treatments. A Mr. Tolle was cured in two treatments; and I might enumerate any number of cases cured just as quickly and just as easily.

All the above cases were invalids, and drugging from two to three years each. They had paid the drug doctors and drug stores hundreds of dollars. Mr. Way said, when I discharged his case, "Why, Doctor, this is too silly and simple for anything."

"Well," I replied, "do you not think it is worth \$5.00?"

"Oh, yes," he said; "I am actually ashamed of myself," etc.

Now for the explanation: All those cases violated the laws of life and health in some manner. No doubt they did it ignorantly, but the laws of life and health are as fixed as the laws of the Medes and Persians; they do not alter to suit your or my condition. In all probability you ate at improper times, or more food than Nature required, and all over and above what Nature required did not digest, therefore it decomposed and was poison to a certain extent. You did not feel well, and commenced taking more poison, calling it "medicine." This inflamed or congested the pneumogastric and ganglionic nerves that supply the gastric juices to the stomach. Those gastric juices are actually poisonous when not natural. Every time you take certain kinds of food into the stomach,

these poisonous gastric juices flow into the stomach, and irritate the delicate nervous membrane thereof. But A. I. Root caters to these poisoned gastric juices, and gives lean beef for them to gnaw on, instead of the delicate membrane of the stomach, instead of regulating the gastric juices, as should be done, and can be done, positively, every time, by simply manipulating the above-mentioned nerves with the hand. I never have failed in a single instance. Any one can learn to do the same in short order. Therefore I know that I must be right. Certain kinds of drugs corrode, as it were, the entire nervous system. The result is what is called "nervous prostration," which is cured mechanically so quickly that many call it a miracle.

Mr. Editor, I dislike to hear of any of our bee-keeping friends being sick, when it is so simple to learn how to avoid sickness of all kinds. In olden times, one of the rulers of Israel was sick. His name was Asahel. The Good Book says Asahel was sick, and he sought not unto God, but unto the physicians, and (poor) Asahel slept with his fathers. How do you suppose Mother Eve raised Cain without a corner drug store or a drug physician?

Now I have certainly cured many cases that could not eat honey, so they could eat it like any other white person. Why should honey hurt me when no other kind of food does? Simply because honey needs no digestion! On taking honey into the stomach the poisonous gastric juices find nothing to do, and consequently gnaw, file, or rasp, as it were, on the delicate mucous membrane. The honey does *not* hurt.

The drug or disease-producing doctor has apparently sought out the invention of how to get the most of your money and keep you sick as long as he can, while the health-producing doctor has sought out the invention of how to cure you in the least possible time, with the least expenditure of your money. Furthermore, he has sought out the invention of how to avoid the sickness entirely. What are you going to do about it?

Orange Co., Calif. DR. E. GALLUP.

Poor Season for Honey.

This has been a poor season for honey in this locality—not quite one-half of an average crop. It was too cool and rainy till late in the spring, and too dry in the summer.

Three cheers for the American Bee Journal. T. H. WAALE.
Sara, Wash., Nov. 9.

Death of Ernest H. Tuttle.

It is with a sad and aching heart that I inform you of the death of my beloved son, Ernest H. Tuttle, a subscriber to, and great admirer of, the Bee Journal.

He passed away on Oct. 1, after an illness of two weeks, of pneumonia, complicated with fever and quinsy; aged 21 years, 10 months. Although a young bee-keeper, as it has been but little more than two years since he first began his work and care of bees, yet he was very successful; being very observant and enthusiastic, and having a deep love for the work. He dearly loved his bees. His greatest enjoyment was working with them and watching their habits.

He found several wild swarms the past summer, and one of the last things



The papers are full of deaths from

Heart Failure

Of course

the heart fails to act when a man dies, but "Heart Failure," so called, nine times out of ten is caused by Uric Acid in the blood which the Kidneys fail to remove, and which corrodes the heart until it becomes unable to perform its functions.

Health Officers in many cities very properly refuse to accept "Heart Failure," as a cause of death. It is frequently a sign of ignorance in the physician, or may be given to cover up the real cause.

Warns
Safe Cure

A Medicine with 20 Years of
Success behind it

will remove the poisonous Uric Acid by putting the Kidneys in a healthy condition so that they will naturally eliminate it.

Mention the American Bee Journal.

40,000.

THE Nebraska Farmer

Has made a contract with the Nebraska Club, to print for them 40,000 copies over and above the regular weekly issue, each month for six months, of reliable information about Nebraska.

If interest d. send for free copy, to
MR. CHAS. E. WILLIAMSON,
Secretary Nebraska Club,
OMAHA, NEBR., or

Nebraska Farmer Co.
Lincoln, Nebr.

44A13 Mention the American Bee Journal.

APIARY FOR SALE 100 Cols. BEES, 2000 Surplus Combs, an Extractor, etc. 8 acres of land, house, shop, etc. 10 min. walk from P. O. Will sell land and bees separately. J. M. DOUDNA,
47A2 ALEXANDRIA, MINN.

Mention the American Bee Journal.

Bee-Keepers' Photograph.—We have now on hand a limited number of excellent photographs of prominent bee-keepers—a number of pictures on one card. The likeness of 49 of them are shown on one of the photographs, and 121 on the other. We will send them, postpaid, for 30 cents each, mailing from the 121 kind first; then after they are all gone, we will send the 49 kind. So those who order first will get the most "faces" for their money. Send orders to the Bee Journal office.

he worried about in his sickness was a colony that he had been feeding. "Are they letting my poor bees starve?" was his plaintive questioning. Had he lived, he would have made a grand bee-keeper, for he was so energetic and ambitious, with an excellent capacity for business.

He looked eagerly for the weekly visits of the American Bee Journal, and read and re-read each number. Indeed, since he began taking it he cared but little for other papers, although reading everything he could find on the subject of bees.

Ernest was a noble young man, brave, manly and sincere, with an affectionate disposition, and a nature pure and true—the basis of a high and unsullied manhood. This is the third time in the past year that this terribly afflicted family has been bereaved of a beloved member. One year ago Oct. 9, the youngest and idolized brother of Ernest, after three weeks of awful suffering, passed away; and only three months later the loved and honored father followed the dear son to the silent tomb; and now our dearly loved Ernest has suddenly been cut off in the first bloom of his fair young manhood, leaving but one son for the solace of the sorely bereft mother and sisters.

Thou'rt gone; and those who loved thee here
Are left so lone and sad;
The hearth is dark where once thy smile
Had made it bright and glad.

MRS. SOPHIA J. TUTTLE.
Blue Earth Co., Minn. Nov. 6.

[The Bee Journal desires to extend to the sorrowing ones, sincerest sympathy in their bereavement.—EDITOR.]

The Poison of Tobacco.

Tobacco is a drug. Its principal constituent is nicotine, which, excepting prussic acid, is the most deadly poison known to chemistry. It is so called from John Nicot, who introduced the herb to Queen Catherine of France in 1560. Nicotine poisons the stomach, affects digestion, produces dyspepsia, and renders the whole system liable to disease. The system tries to throw off the poison, but soon it permeates blood, bone and muscle.—Anti-Tobacco Journal (England).

Wax-Extractors.

O. O. Poppleton makes the following reply to R. L. Taylor in Review:

"In speaking of rendering wax, he says: 'At best, the solar wax-extractor is cumbersome, can be used only about two months in the year, and is of no practical utility in rendering combs containing cocoons.' I challenge all three of those statements. A properly made solar extractor is easier to handle and less cumbersome than is a large boiler to be lifted on and off the stove, filled with water, etc. It can be used at least three, if not four, months in the year, instead of only two, and I have always met with excellent success in rendering the oldest and toughest of combs. Perhaps Mr. Taylor's experience with solar extractors has been limited. I cannot conceive any other reason why he should think as he does.

"One spring, in Iowa, I rendered out over 500 old combs in better shape and more satisfactorily than if I had used the method he describes. These combs had

USEFUL AND POPULAR BOOKS.

WORKS OF INTEREST AND VALUE TO PEOPLE OF ALL CLASSES AND TASTES.

Each Book Consists of a Handsome Octavo Volume of 64 Large Double-Column Pages, Neatly Bound in an Attractive Paper Cover.

Brief descriptions of a select list of useful and popular books will be found below. These books cover a wide range of subjects, the object being to please all tastes and requirements. Each is a complete text-book upon the special theme of which it treats, and they are offered upon such terms as to place them within the reach of all. No man or woman can fail to be profited by the possession of these books; no home should be without them. Each book consists of a handsome octavo volume of 64 large double-column pages, nicely printed and bound in attractive paper covers. Many of them are handsomely illustrated:

No. 123. **How to Train Animals.** This book, written by an experienced animal trainer, tells how, to teach horses, dogs, cats, mules, goats, hogs and other animals, also birds, to perform the most remarkable tricks and feats of intelligence.

No. 132. **Every Boy His Own Toy-Maker.** A great book for boys, telling how to make a Steam Engine, Photographic Camera, Windmill, Microscope, Electrical Machine, Galvanic Battery, Electric Telegraph, Telephone, Magic Lantern, Boats, Kites, Balloons, and many other things.

No. 129. **The Practical Guide to Floriculture,** a complete practical guide to the culture of flowers and plants, by Eben E. Rexford, one of the leading authorities upon all matters pertaining to floriculture.

No. 125. **Home Amusements,** a splendid collection of Games, Puzzles, Tricks, Diversions, Pastimes, Experiments, Tableaux Vivants, Shadow Pantomimes, Acting Charades and Proverbs, for social gatherings, public and private entertainments and evenings at home.

No. 130. **Modern Etiquette for all Occasions.** An excellent work upon this subject, containing the rules of deportment for all occasions, both for ladies and gentlemen, as observed by the best society.

No. 131. **The Ready Reference Manual of Facts, Figures and Statistics.** A collection of useful facts, figures, statistics and dates—a compendium of valuable information for the use of every man, woman and child, conveniently arranged for ready reference.

No. 117. **The Practical Poultry Keeper.** An entirely new book on poultry keeping, just published, involving the experience of successful poultry keepers, and embracing all the latest ideas on the subject.

No. 116. **The Practical Horse and Cattle Doctor.** This valuable book describes the symptoms of every disease with which horses and cattle are afflicted, gives the causes of such diseases, together with plain and explicit directions for their treatment.

No. 11. **The Handy Cyclopaedia of Every Day Wants,** a compendium of useful and valuable information, filled with practical receipts, hints, helps and suggestions, of the greatest use to every housekeeper.

No. 13. **The Family Doctor Book,** containing plain and simple directions for the treatment of every known disease or ailment of the human frame, and suggesting simple home remedies which usually effect a cure without the necessity of employing a physician.

No. 12. **The National Handy Dictionary,** a complete pocket dictionary of the English language, containing 3,000 words, with their orthography, definition and pronunciation, and 237 illustrations.

No. 13. **The Ladies' Model Fancy-Work Manual.** An entirely new book embodying all the latest ideas in needlework, crochet, knitting and embroidery. It contains many new lace and crochet patterns, and directions for making many articles of wearing apparel and for decorative purposes.

No. 13. **The American Family Cook Book.** A complete cook book, compiled by an experienced housekeeper, and containing more than seven hundred of the choicest recipes, classified for ready reference.

No. 135. **The Ladies' Guide to Beauty.** This book contains minute and practical instructions, accompanied by many valuable recipes, for securing a handsome form, a clear and smooth skin, a beautiful complexion, beautiful hair, etc., etc.

No. 11. **Mrs. Partington's Grab-Bag,** the contents of which are very, very funny. The last and best book written by B. P. Shillaber, the original Mrs. Partington.

No. 115. **Everybody's Law Book.** The object of this volume is to impart, in a simple, concise manner, the fullest information regarding legal matters. In all ordinary emergencies it will save employing a lawyer.

No. 137. **Phrenology Made Easy.** This book tells you how to read a person's character by the simple act of passing the fingers over the head, and the accuracy of these revelations will be a surprise to you and all your friends.

No. 143. **Lessons in Shorthand,** on Gurney's System. A complete instruction book in the art of phonography or shorthand writing, showing how any one may acquire and become proficient in this valuable art.

The above books in other editions are usually sold at 25 cents each, but

Read Our Liberal Offer: We will send any one of the above books by mail post-paid upon receipt of only **Ten Cents**; any four for **Twenty-five Cents**; any ten for **Fifty Cents**. By buying ten books at a time you get them at half price. Please order by the numbers as given.

Read these Premium Offers: We will send any 5 (50 cents' worth) of the above-named books by mail post-paid, also the American Bee Journal for one year, upon receipt of only \$1.25; or we will send any 10 books (one dollar's worth) also the American Bee Journal for one year, upon receipt of only \$1.50. Send us **One New Subscriber** to the Bee Journal for one year (at \$1.00), and we will mail you free, as a premium, your choice of 10 of the above books. Address,

GEORGE W. YORK & CO., 118 Mich. St., CHICAGO, ILL.

been subjected to some freezing, and could be kept as long as I wished before rendering. I couldn't have done this, of course, had the combs come from colonies that had died from spring dwindling. The principal objection to the solar wax-extractor is, that if one needs to work up a large amount of comb in a short time, they cannot do the work.

"I have used solar extractors for about 20 years, for apiaries varying from 25 to 500 colonies, and I have yet to be in a situation that it was best to use the old, fussy methods of rendering wax over a stove or any kind of a fire. I had supposed that such methods were entirely out of date, and relegated to the past, except in rare cases of emergencies."

Little Honey and Lots of Swarms.

From 30 colonies of bees, spring count, I took only 500 pounds of extracted honey, but they swarmed to beat the band. I now have 60 colonies, 50 of them in the winter repository, short of stores, and still I have not lost hope and courage. I will try it one more season.

L. G. REED.

Portage Co., Ohio, Nov. 11.

Report for the Past Season.

I had six colonies last spring, one weak and queenless. I increased to 10, and took 500 pounds of comb honey.

L. JONES.

Floyd Crossing, Iowa, Nov. 10.

Results of the Season.

I have kept bees two years, and have had very good success. I had six colonies last spring, and got about 500 pounds of comb honey, and now have 19 colonies safe in winter quarters. All have plenty of stores.

I noticed one colony early in the fall that answered to the description of pickled brood. Now I have just come from the cellar in which the bees are, and they have been throwing the dead brood (now black) out in great numbers. I shall keep close watch of them through the winter, and if there is anything of interest concerning the colony, I will report in the spring, as it might help some beginner like myself.

I would like to say a word in praise of the most valuable American Bee Journal. I cannot say too much in its favor. I have put into practice what I have found in its columns, and have always been well pleased with the results. I could not think of keeping bees without it.

JOS. EGGE.

Wadena Co., Minn., Nov. 13.

Discouragements of a Bee-Keeper.

I came here six years ago, from the Minnesota conference of the M. E. Church. After 31 years of hard work in the itinerancy, I broke down with "grip." In this mild climate my health is better. For many years I was much interested in bee-culture. On my arrival here I bought 10 colonies. We have no trouble to winter them here, but the trouble is in summering them. One time I had bees starve in midsummer. I have had two setbacks. First, a man went to making sorghum a mile away. There was no honey in the flowers, so the bees went to the cane-mill. He made a torch and burned the bees' wings

off; they were destroyed by the bushel. Out of 36 nice, heavy colonies I had but 18 left, and they were all weak. I tried to reason with that man, but to no purpose. He left his wife; then was in jail for burning a barn. The last I heard of him he claimed to be converted, and was trying to preach to the mountaineers!

The second drawback was that heavy freeze two years ago. It struck us the last of March. The bees commenced to bring in pollen on Feb. 18. When the cold wave struck us, the trees were hanging full of fruit. After the cold passed, the woods looked as if a fire had run through them. Our bees did not recover from that shock that year.

Last year the honey was very scarce, and of a poor quality. I extracted 250 pounds from 25 colonies. This year I have taken 600 pounds of extracted honey from 40 colonies, and they have increased from 40 to 61. They had 25 good honey days in October, and at present they are very heavy in honey and bees.

(REV.) JAMES G. TETER.

McMinn Co., Tenn., Nov. 12.

Queens and Queen-Rearing.—

If you want to know how to have queens fertilized in upper stories while the old queen is still laying below; how you may safely introduce any queen, at any time of the year when bees can fly; all about the different races of bees; all about shipping queens, queen-cages, candy for queen-cages, etc.; all about forming nuclei, multiplying or uniting bees, or weak colonies, etc.; or, in fact, everything about the queen-business which you may want to know—send for Doolittle's "Scientific Queen-Rearing"—a book of over 170 pages, which is as interesting as a story. Here are some good offers of this book:

Bound in cloth, postpaid, \$1.00; or clubbed with the BEE JOURNAL for one year—both for only \$1.75; or given free as a premium for sending us three new subscribers to the BEE JOURNAL for a year at \$1.00 each.

**PAID FOR
Cash Beeswax**

For all the **Good, Pure Yellow Beeswax** delivered to our office till further notice, we will pay 24 cents per pound, CASH; or 27 cents for whatever part is exchanged for the Bee Journal, Honey, Books or Seed, that we offer. If you want **cash, promptly**, for your Beeswax, send it on at once. Impure wax not taken at any price. Address as follows, very plainly,

GEO. W. YORK & CO.

118 Michigan st., CHICAGO, ILL.



For a knife that will cut a horn without crushing, because it cuts from four sides at once get
THE KEYSTONE DEHORNER
It is humane, rapid and durable. Fully warranted. HIGHEST AWARD AT WORLD'S FAIR. Descriptive circulars FREE. A. C. BROSIUS, Cochranville, Pa.

40E13t Mention the American Bee Journal.

THE "NOVELTY" POCKET-KNIFE!



Your Name on the Knife.—When ordering, be sure to say just what Name and Address you wish put on the Knife.

The NOVELTY KNIFE is indeed a novelty. The novelty lies in the handle. It is made beautifully of indestructible celluloid, which is as transparent as glass. Underneath the celluloid, on one side of the handle is placed an AMERICAN BEE JOURNAL reminder, and on the other side, name and residence of the Subscriber.

The material entering into this celebrated knife is of the very best quality; the blades are handforged out of the very finest English razor-steel, and we warrant every blade. The holsters are made of German silver, and will never rust or corrode. The rivets are hardened German silver wire; the linings are plate brass; the back springs of Sheffield spring steel, and the finish of handle as described above. It will last a lifetime, with proper usage.

Why purchase the Novelty Knife? In case a good knife is lost, the chances are, the owner will never recover it; but if the Novelty is lost, having name and address of owner, the finder will return it; otherwise to try to destroy the name and address, would destroy the knife. If traveling, and you meet with a serious accident, and are so fortunate as to have one of the Novelties, your pocket KNIFE will serve as an identifier; and in case of death, your relatives will at once be apprised of the accident.

How appropriate this knife is for a Christmas, New Year or birthday present! What more lasting memento could a mother give to a son, a wife to a husband, a sister to a brother, a lady to a gentleman, or vice versa, a son to a mother, a husband to a wife, a brother to a sister or a gentleman to a lady—the knife having the name of the recipient on one side?

The accompanying cut gives a faint idea, but cannot fully convey an exact representation of this beautiful knife, as the "Novelty" must be seen to be appreciated.

How to Get this Valuable Knife.—We send it postpaid, for \$1.00, or give it as a Premium to the one sending us three new Subscribers to the BEE JOURNAL (with \$3.00), and we will also send to each new name a copy of the Premium Edition of the book "Bees and Honey." We club the Novelty Knife with the BEE JOURNAL for one year, both for \$1.90.

Any Name and Address Put on the Knife.

GEORGE W. YORK & CO.,

CHICAGO, ILLS.

Allow about two weeks for your order to be filled.

California

If you care to know of its Fruits, Flowers, Climate or Resources, send for a Sample Copy of California's Favorite Paper—

The Pacific Rural Press

The leading Horticultural and Agricultural paper of the Pacific Coast. Published weekly, handsomely illustrated, \$2.00 per annum. Sample Copy Free.

PACIFIC RURAL PRESS,
220 Market St., - SAN FRANCISCO, CAL.

MUTH'S HONEY EXTRACTOR PERFECTION Cold-Blast Smokers,

Square Glass Honey Jars, Etc.

For Circulars, apply to CHAS. F. MUTH & SON, Cor. Freeman & Central Aves., Cincinnati, O. Send 10c for Practical Hints to Bee-Keepers. Mention the American Bee Journal.

COMB FOUNDATION

Wax always wanted for Cash or in Exchange for Fdn. or other Supplies. My trade is established on Low Prices and the merit of my Foundation. Orders filled promptly.

WORKING WAX INTO FDN. BY THE LB. A SPECIALTY. Wholesale prices to dealers and large consumers. Send for Prices and Samples to—GUS DITTMER, AUGUSTA, WIS.

Reference—Augusta Bank. 1Atf
Mention the American Bee Journal.



ONE MAN WITH THE UNION COMBINATION SAW

Can do the work of four men using hand tools, in Rippling, Cutting-off, Milling, Rabbeting, Grooving, Gaining, Dadoing, Edging-up, Jointing Stuff, etc. Full Line of Foot and Hand Power Machinery Sold on Trial. Catalogue Free.

SENECA FALLS MFG. CO.,
46 Water St., SENECA FALLS, N. Y.
1A1y Mention the American Bee Journal.

PROF. A. J. COOK'S BOOK FREE!

The Bee-Keeper's Guide

MANUAL OF THE APIARY.

Given For 2 New Subscribers.

The following offer is made to PRESENT subscribers only, and no premium is also given to the two new subscribers—simply the Bee Journal for one year:

Send us Two New Subscribers to the Bee Journal (with \$2.00), and we will mail you a copy of Prof. Cook's book FREE as a premium. Prof. Cook's book alone sent for \$1.25, or we club it with the Bee Journal for a year—both together for only \$1.75. But surely anybody can get only 2 new subscribers to the Bee Journal for a year, and thus get the book as a premium. Let everybody try for it. Will you have one?

This 15th and latest edition of Prof. Cook's magnificent book of 460 pages, in neat and substantial cloth binding, we propose to give away to our present subscribers, for the work of getting NEW subscribers for the American Bee Journal.

A description of the book here is quite unnecessary—it is simply the most complete scientific and practical bee-book published today. Fully illustrated, and all written in the most fascinating style. The author is also too well-known to the whole bee-world to require any introduction. No bee-keeper is fully equipped, or his library complete, without "THE BEE-KEEPER'S GUIDE."

GEORGE W. YORK & CO., 118 Michigan St., CHICAGO, ILL.

HONEY and BEESWAX

MARKET QUOTATIONS.

The following rules for grading honey were adopted by the North American Bee-Keepers' Association, and, so far as possible, quotations are made according to these rules:

FANCY.—All sections to be well filled; combs straight, of even thickness, and firmly attached to all four sides; both wood and comb unsoiled by travel-stain, or otherwise; all the cells sealed except the row of cells next the wood.

No. 1.—All sections well filled, but combs uneven or crooked, detached at the bottom, or with but few cells unsealed; both wood and comb unsoiled by travel-stain or otherwise.

In addition to this the honey is to be classified according to color, using the terms white, amber and dark. That is, there will be "fancy white," "No. 1 dark," etc.

Chicago, Ill., Nov. 18.—Fancy white, 12@13c.; No. 1, 10@11c.; fancy amber, 9@10c.; No. 1, 7@8c.; fancy dark, 9c.; No. 1, 7@8c. Extracted, white, 5@7c.; amber, 5@6c.; dark, 4½c. Beeswax, 26@27c.

Comb honey is selling very slowly.

Philadelphia, Pa., Nov. 7.—Fancy white comb, 13-14c.; No. 1 white, 11-12c.; fancy amber, 10-11c.; dark, 8-9c. Extracted, white, 6-8c.; amber, 4-5c.; dark, 3-4c. Beeswax, 26c.

Comb honey arriving freely and market overstocked at present.

Detroit, Mich., Nov. 7.—No. 1 white, 12-12½c.; fancy amber, 10-11c.; No. 1 amber, 9-10c.; fancy dark, 8-9c. Extracted, white, 5½-6c.; amber, 5-5½c.; dark, 4-5c. Beeswax, 24-25c.

Indianapolis, Ind., Nov. 7.—Fancy white, 14-15c.; No. 1 white, 12-13c. Extracted, white, 6-7c. Beeswax, 22-25c.

Demand is fair for grades quoted, but no demand for inferior grades.

New York, N. Y., Nov. 7.—Fancy white, 12c.; off grades, 10@11c.; buckwheat, 8@9c. No change in extracted. Beeswax firm at 26@27c.

The market is well supplied with comb honey of all grades and styles. Fancy white is in fair demand, while off grades white and buckwheat are moving off rather slowly.

Albany, N. Y., Nov. 7.—Fancy white, 12-13c.; No. 1, 11-12c.; fancy amber, 9-10c.; No. 1 dark, 8-9c. Extracted, white, 6-7c.; dark, 4-5c.

The receipts of both comb and extracted honey are very large, and prices are somewhat lower. We have an ample stock of all styles except paper cartons weighing less than a pound.

Cincinnati, Ohio, Nov. 7.—Comb honey, 10@14c., according to quality. Extracted, 3½@6c. Demand is slow for all kinds of honey, while the supply is good.

Beeswax is in good demand at 20@25c. for good to choice yellow.

Cleveland, Ohio, Nov. 7.—Fancy white, 14½@15c.; No. 1 white, 12½@13c. Extracted, white, 6@7c.; amber, 4½@5½c. Beeswax, 22@25c.

There is not very much honey in our market. Selling rather slow. Demand beginning to be a little better. Think trade will be fair in this line this fall.

St. Louis, Mo., Nov. 9.—Fancy white, 14c.; No. 1 white, 12@13c.; fancy amber, 11@12c.; No. 1 amber, 10@10½c.; fancy dark, 9@9½c.; No. 1 dark, 7@8c. Extracted, white, in cans, 6@7c.; in barrels, 5@5½c.; amber, 4½@4¾c.; dark, 3½@4c. Beeswax, 26½@27c.

Baker stock of extracted honey, 4@5c.; stock very scarce. Fair receipts of comb. Beeswax in good demand.

San Francisco, Calif., Nov. 7.—White comb, 10c.; amber, 7½-9c. Extracted, white, 5-5½c.; light amber, 4½-5c.; amber colored and candied, 3¾-4¾c.; dark tulle, 2¾-3c. Beeswax, fair to choice, 25-27½c.

Milwaukee, Wis., Nov. 7.—Fancy white, 14-15c.; No. 1, 12-13c.; No. 1 amber, 8-10c. Extracted, white, 6-7c.; amber, 5-6c.; dark, 4-5c. Beeswax, 22-24c.

New crop of honey begins to come forward. The demand is very poor and quotations almost nominal. Weather is very warm and the consumption of honey is very small. Plenty of fruit, and hence the appetite is satisfied with same in preference. Later on we expect an improved demand for honey of all kinds.

Minneapolis, Minn., Nov. 7.—Fancy white, 12½c.; No. 1 white, 10@11c.; fancy amber, 9@10c.; No. 1 amber, 8@9c.; fancy dark, 7@8c.; No. 1 dark, 6-8c. Extracted, white, 5½@6½c.; amber, 5@5½c.; dark, 4@5c. Beeswax, 23@26c.

The demand for both comb and extracted is very quiet, and for the latter, nominal. The hot weather of the past week or so has checked demand for comb honey.

Kansas City, Mo., Nov. 7.—Fancy white comb, 15c.; No. 1 white, 13@14c.; fancy amber, 12-13c.; No. 1 amber, 11-12c.; fancy dark, 10-11c.; No. 1, 8-10c. Extracted, white, 6-6½c.; amber, 5 5/8c.; dark, 4-4½c. Beeswax, 22-25c.

Buffalo, N. Y., Nov. 7.—Strictly fancy comb, 1-pound, 12-13c.; fair to good, 9-10c.; dark, 7-8c.

Demand is much better for fancy, but common stock is very dull at any price.

Boston, Mass., Nov. 6.—Fancy white, 13-14c.; No. 1, 11-12c. Extracted, white, 6-7c.; amber, 5-6c. Beeswax, 25c.

List of Honey and Beeswax Dealers.

Most of whom Quote in this Journal.

Chicago, Ills.

R. A. BURNETT & Co., 163 South Water Street.

New York, N. Y.

HILDRETH BROS. & SEGELKEN.

Kansas City, Mo.

C. C. CLEMOMS & Co., 423 Walnut St.

Buffalo, N. Y.

BATTERSON & Co., 167 & 169 Scott St.

Hamilton, Ills.

CHAS. DADANT & SON.

Philadelphia, Pa.

WM. A. SELSER, 10 Vine St.

Cleveland, Ohio.

WILLIAMS BROS., 80 & 82 Broadway.

St. Louis, Mo.

WESTCOTT COM. CO., 213 Market St.

Minneapolis, Minn.

S. H. HALL & Co.

Milwaukee, Wis.

A. V. BISHOP & Co.

Boston, Mass.

E. E. BLAKE & Co., 57 Chatham Street.

Detroit, Mich.

M. H. HUNT, Bell Branch, Wayne Co., Mich.

Indianapolis, Ind.

WALTER S. POWDER, 162 Massachusetts Ave.

Albany, N. Y.

CHAS. McCULLOCH & Co., 380 Broadway.

Cincinnati, Ohio.

C. F. MUTH & SON, cor. Freeman & Central avs.

Convention Notices.

MINNESOTA—The annual meeting of the Minnesota Bee-Keepers' Association will convene at the court house in Minneapolis on December 3, and continue in session two days. Crystal, Minn. E. K. JACQUES, Sec.

Wanted

—To buy quantity lots of Fancy and No. 1 White Honey at prices to suit the times. B. WALKER, 45A Ewart, Mich.

WHEN ANSWERING THIS ADVERTISEMENT, MENTION THIS JOURNAL.

INFORMATION GOLD!
Worth Its Weight in
For your name and address on a postal card, we will tell you how to make the best wire fence on earth, horse-high, bull-strong and pig-tight, at the actual wholesale cost of wire. Kitzelman Bros., Box B, Ridgeville, Ind.

48 Etf mention the American Bee Journal.

THROAT AND LUNG DISEASES,
DR. PEIRO, Specialist
Offices: 1019, 100 State St., CHICAGO. Hours 9 to 4.
Mention the American Bee Journal

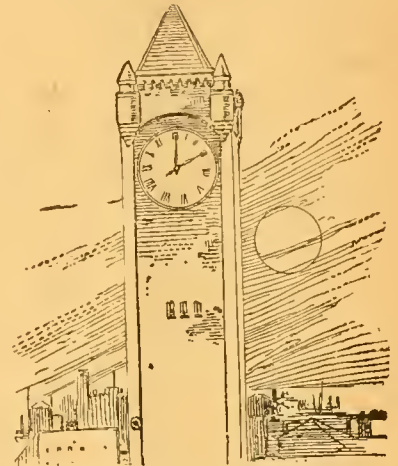

It's High Time YOUR BEESWAX!

—TO SEND US—

If you want a good price for it.

UNTIL FURTHER NOTICE, we will allow 27 cents per pound for Good Yellow Beeswax, delivered at our office—in exchange for subscription to the BEE JOURNAL, for Books, or anything that we offer for sale in the BEE JOURNAL. Or, 24 cts. cash.

GEORGE W. YORK & CO.,
CHICAGO, ILLS

A GOLD DOLLAR
is about the actual worth of our new book on Incubation and Poultry. Contains a full and complete description of the Reliable Incubator & the Brooder of same name, together with cuts and instructions for building poultry houses and much of interest and great value to the poultryman. Sent on receipt of 30c. RELIABLE INCUBATOR & BROODER CO.—QUINCY, ILLS
36E17t Please mention the Bee Journal.

WANTED TO EXCHANGE—Some Pug Pups and two fine St. Bernard Dogs, for shotgun or honey, or anything you have to trade. W. S. BRILLHART, Millwood, Ohio.
Mention the American Bee Journal.

HATCH Chickens BY STEAM—With the MODEL EXCELSIOR Incubator
Simple, Perfect, Self-Regulating. Thousands in successful operation. Lowest priced first-class Hatcher made. G. ED. H. STALL, 114 to 122 S. 6th St. Quincy, Ill.
Circulars free. Send fee for this Catalogue.

44A26t Mention the American Bee Journal

HATCH CHICKENS
with a machine that will hatch every egg that can be hatched.
The New Saunenig Hatcher.
Send 2 stamps for catalogue No. 59 INVINCIBLE HATCHER CO., Springfield, O.

Bottom Prices

**BRING US BIG TRADE.
GOOD GOODS KEEP IT.**

If you want the best supplies that can be made at a little less cost than you can buy the same goods for elsewhere, write to us for low prices. 1896 Catalogue now ready—ask for it and a free copy of **The American Bee-Keeper** (36 pages).

Address,
THE W. T. FALCONER MFG. CO.,
JAMESTOWN, N. Y.
Mention the American Bee Journal.

Honey-Clovers & Buckwheat SEED FOR SALE.

We have made arrangements so that we can furnish seed of several of the Clovers and Japanese Buckwheat, by freight or express, at the following prices, cash with order:

	5lb	10lb	25lb	50lb
Alsike Clover.....	\$.70	\$1.25	\$3.00	\$ 5.75
Sweet Clover.....	.65	1.20	2.75	5.00
White Clover.....	1.25	2.00	4.50	8.00
Alfalfa Clover.....	.65	1.10	2.70	5.00
Crimson Clover....	.55	.90	2.00	3.50
Jap. Buckwheat....	.20	.35	.90	1.25

Prices subject to market changes.
Add 25 cents to your order, for cartage, if wanted by freight.
Your orders are solicited.

GEORGE W. YORK & CO.,
CHICAGO, ILLS.

BEGINNERS.

Beginners should have a copy of the **Amateur Bee-Keeper**, a 70-page book by Prof. J. W. Rouse. Price 25 cents; if sent by mail, 28c. The little book and the **Progressive Bee-Keeper** (a live, progressive 28-page monthly journal) one year, 65c. Address any first-class dealer, or

LEAHY MFG. CO., Higginsville, Mo.
WHEN ANSWERING THIS ADVERTISEMENT, MENTION THIS JOURNAL.

A Liberal Discount,

On **SUPPLIES** until Jan. 1, 1897. Write to us for prices on what you need, before placing your order.

Clover Ex. Honey, in Kegs, 7c per lb.

I. J. STRINGHAM,
105 Park Place. NEW YORK, N. Y.
APLARY—Glen Cove, L. I.
Mention the American Bee Journal.

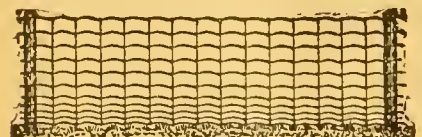

Our Fair Exhibits.

With five car loads of wild animals, we have given free shows at the leading State and District Fairs. We thus furnish instruction, amusement, and proof that the **Page** is the best. Several applications are in for next year's exhibit.

PAGE WOVEN WIRE FENCE CO., Adrian, Mich.
Mention the American Bee Journal.

READERS Of this Journal who write to any of our advertisers, either in ordering, or asking about the Goods offered, will please state that they saw the Advertisement in this paper.

BEESWAX WANTED

—FOR—

Foundation Making.

Send For OUR CATALOGUE,

SAMPLES OF FOUNDATION,

ADVICE TO BEGINNERS, Etc.

Address,

CHAS. DADANT & SON,

HAMILTON, ILL.

WHEN ANSWERING THIS ADVERTISEMENT, MENTION THIS JOURNAL.

Ask Your Friends to Take This Journal.

* Extracted Honey *



Finest Quality. Basswood and Clover.

2 60-lb. cans in case, 7c. per pound. 1 60-lb. can in case, 8c. per pound. A sample by mail, 10 cts. **POUDER'S Honey-Jars and Complete Line of Supplies.** Catalogue Free.

WALTER S. POWDER,
162 Mass. Avenue. INDIANAPOLIS, IND.

PATENT WIRED COMB FOUNDATION



Has No Sag in Brood-Frames

Thin Flat-Bottom Foundation

Has No Fishbone in the Surplus Honey.

Being the cleanest is usually worked the quickest of any Foundation made

J. VAN DEUSEN & SONS,
Sole Manufacturers,
Sprout Brook Montgomery Co., N. Y.

A LARGE BOOK FREE.

To every new subscriber who sends us \$1.00, we will send him our journal—

Gleanings in Bee-Culture,

one year, and the book by A. I. Root, containing 190 pages, size 6½x9½, entitled:

What to Do, and How to be Happy while Doing It,

postpaid. The regular price of this work is 50 cents alone.

If you prefer, the journal may be sent to a friend, and you can keep the book for yourself.

THE A. I. ROOT COMPANY,
MEDINA, OHIO.

AMERICAN BEE JOURNAL

DEVOTED EXCLUSIVELY TO THE INTERESTS OF HONEY-PRODUCERS

ESTABLISHED IN 1861
THE OLDEST BEE-PAPER IN AMERICA

Published Weekly, at \$1.00 per annum.

Sample Copy sent on Application.

36th Year.

CHICAGO, ILL., DECEMBER 3, 1896.

No. 49.



Work of Worker-Bees—California Notes.

BY PROF. A. J. COOK.

Years ago, while working with bees preparing to issue my "Bee-Keepers' Guide," I introduced on several occasions Italian queens into colonies of black bees for the purpose of studying the function of the worker-bees at different ages. As stated in my "Manual," I found that the age of beginning field-work varied much with circumstances. In case there are no old bees in the hive, the young bees will go to work in

the field at the end of a week after coming forth from the brood-cells. On the other hand, if there are old bees in the hive, the workers will frequently wait two or three weeks before they engage actively in field-work. There can be no doubt but that the younger worker-bees are better fitted to do nurse-work, and the other labor in the interior of the hive, while the more mature workers are better fitted for out-door work. Yet it is no doubt true that in case there are few or no young bees, the old bees will do the inside work of the hive, and, as intimated above, if there are no old bees, the young bees will repair to the field in quest of honey and pollen much sooner than they otherwise would.

There is but very little doubt that the function of the upper-head and thoracic glands are to furnish the ferment which will digest the nectar of the flowers, while the lower-head glands secrete a digestive liquid which acts to digest the pollen. The fact that these lower-head glands are better developed in the young workers, and that the other glands attain their maximum development in the older bees accords with what has been said above.

It has been stated by some of the authors of our bee-literature that the food given to the larvæ, and probably to the



Majority of the Members of the North American Bee-Keepers' Association at Lincoln, Nebr., Oct. 7 and 8, 1896.

- | | | | | |
|-----------------------|------------------------|----------------------------|------------------------|----------------------------|
| 3. Charles White. | 27. J. C. Masters. | 34. J. C. Knoll. | 43. Ernest R. Root. | 50. Hon. Eugene Secor. |
| 4. M. A. Enslow. | 28. E. Kretschmer. | 36. Prof. Lawrence Bruner. | 44. George W. York. | 51. Mrs. J. N. Heater. |
| 8. L. M. Brown. | 29. H. E. Heath. | 37. L. D. Stillson. | 45. A. Laing. | 52. Mrs. Jennie Itzer. |
| 16. J. C. Stewart. | 30. Mrs. E. T. Abbott. | 39. Mrs. Compton. | 46. Dr. C. C. Miller. | 53. Mrs. V. Collins. |
| 18. Mrs. E. Whitcomb. | 31. S. H. Herrick. | 40. Mrs. A. L. Amos. | 47. Dr. A. B. Mason. | 55. Chancellor MacLean. |
| 21. W. C. Frazier. | 32. R. C. Alkla. | 41. Mrs. R. C. Alkla. | 48. Rev. F. T. Abbott. | 56. A. I. Root. |
| 22. Rev. Clay C. Cox. | 33. T. R. DeLong. | 42. E. B. Glalish. | 49. Mrs. Eugene Secor. | 57. Mrs. A. L. Hallenbeck. |

queen and drones as well, is a secretion from the lower-head glands. Experiments which I tried some years ago prove conclusively that this food of the larvæ, etc., is digested pollen, and it is most reasonable to conclude that the lower-head glands furnish the digestive ferment that acts upon this pollen, converting it into the royal jelly and nitrogenous food which is fed to the larvæ, and no doubt to the queen and drones.

I took a colony composed almost wholly of nurse-bees, removed all honey from the hive, and fed them syrup mixed with finely-pulverized charcoal. I removed the queen and gave them frames of eggs. In two or three days it was easy to find this charcoal in the royal jelly in the food fed to the larvæ. We all know that charcoal is not capable of being absorbed—it is entirely insoluble in the body liquid. This proves conclusively that were the royal jelly, etc., a secretion, instead of digested material, the charcoal could not be found in the food of the larval bees.

POISONOUS HONEY.—In a recent number of one of the bee-papers I find that I am spoken of as dogmatic because I wrote something like the following: It is well known that in many regions where the mountain laurel grows abundantly, and where the flowers are visited freely by the bees, there is never any complaint of poisoned honey. (I quote from memory.) I did not mean in writing this to say that there were no cases of poisoning by such honey; I simply meant that there was no report in those localities. I got my information not only from frequent communications in the bee-papers, but also from quite an extended correspondence from people in such regions. I do not say that such honey is never poisonous. I simply gave reasons which seemed to me to leave the matter in doubt, and left for others to decide in view of the facts.

GOOD HONEY COUNTY.—It is probable that San Diego, the southernmost county of California, is one of the most wonderful honey regions of the world. It is reported that 58 carloads of honey were shipped from that county in 1895.

RAINFALL IN CALIFORNIA.—As is well known, Southern California has produced almost no honey during the season of 1896. It seems a pretty well settled fact that unless the rainfall equals 15 inches, there will be a very slight honey crop. The rainfall in 1895 and 1896 at Claremont was hardly more than 10 inches. During the past week we have had an astonishing rainfall, which is the more of a surprise as it has come before the rainy season usually sets in at all. The Government rain-gate at Claremont registered over five inches, or half the entire amount of last year. "Old Baldy," a high mountain, which is plainly in sight, and only a few miles from our place, is capped with snow. This makes the prospect of a large rainfall this season very flattering. Thus it is that the farmers, no less the bee-keepers, are feeling very happy.

HONEY CROP OF 1897.—The prospects for a good honey crop in 1897 make it all the more desirable that all our California bee-keepers make frequent and thorough examination of their bees to see that all have plenty of honey. The fact of the present honey-drouth makes it almost certain that many bees will starve unless special pains are taken to give them additional stores.

A SENSELESS ATTACK.—I have been specially pained of late to notice a bitter attack upon one of California's honorable and most honored apiarists. The victim in this case is Mr. George W. Brodbeck, of Los Angeles. It is well known to all California bee-keepers that Mr. Brodbeck is not only a man of most thorough integrity, but that he is also very unselfish, and devoted to the interests of California apiculture. It is doubtful if any California bee-keeper has done more for our bee-keepers than has Mr. Brodbeck. He is not only a Christian gentleman, but he is always courteous and interested in every good word and work. Any such attack would make no impression at all where Mr. Brodbeck is at all known.

AMIALE BEES.—The fact of the large and numerous orchards of Southern California, together with the fact that pollination by bees is often essential to a full crop of fruit, makes it almost certain that very soon fruit-growers will very generally be bee-keepers as well. This makes it very desirable that the bees of California should be very amiable—those not likely to sting. Would it not be well then for our enterprising breeders of queens to introduce into Southern California the very quiet Carniolan bees? At present the bees of Southern California are very largely blacks or hybrids. Such

bees are proverbially cross. Only last week we read in the papers of a horse being killed by being stung by bees. I believe our bee-keepers should consider the matter of the introduction into our State of the most amiable races.

Claremont, Calif.



A Paradise for the Honey-Bee.

DAN H. HILLMAN.

The bee-papers contain an occasional article from Utah, but as yet I have failed to see Ashley Valley mentioned. Perhaps but few if any of the readers of the American Bee Journal ever heard of this valley, and, even if they have, they did not know that it was a paradise for the little honey-bee and the apiarist.

Ashley Valley proper is about 20 miles long by 10 wide, is situated in the northeastern part of Utah, 120 miles north of the nearest station on the Rio Grande Western railroad, and 100 miles south of the Union Pacific, with but few ranches between, and has a population of about 4,000.

Stock-raising being the main industry of the country, of course hay is the principal crop, and thousands of acres are seeded to alfalfa, or lucern, which yields two and three crops of hay each season, besides affording good pasture during the forepart of the winter. In the Rocky Mountains alfalfa is allowed to bloom profusely before each cutting, and as it is a valued honey-plant, bee-keepers can readily see why Ashley Valley is a paradise for the honey-bee and the apiarist.

Besides alfalfa, we have an abundance of sweet clover growing along the irrigating ditches and roadsides, but the bees do not work on it as they are reported in other parts of the country, and it is but seldom that stock feed on it here.

We also have the Rocky Mountain bee-plant, which, in my estimation, is equal to alfalfa as a honey-plant where it grows in abundance. The bees gather nectar from various other plants and shrubs of smaller note.

According to the bee-inspector's report for 1895, there were over 2,400 colonies of bees in the valley—principally hybrids—and up to date there has never been a case of foul brood. The one drawback to the honey-industry here is a market. Being cut off from the outside world by mountains and bad lands, our market is not as extensive as it might be, and our surplus is hauled by team over rough mountain roads to the mining camps of Colorado, from 100 to 300 miles distant, where it brings the small price of from 10 to 15 cents per pound. Honey is a staple article in this valley, and a large quantity is used yearly in canning and preserving fruit—more than it would be, I fancy, were it not for the fact that sugar sells at 10 pounds for a dollar. However, with the opening of the Uncompahgre and Uinta reservations—located in this county and adjoining the valley on the south and west, on which there are homes for as many people as there are in the State of Utah to-day—there will be a good market for more honey than this valley will produce. It is true there are several hundred Indians and two regiments of colored soldiers on the reservation, but as a rule the Indians do not use a great deal of honey. One beggar, when given a "hunk" of bread with two "hunks" of honey on it, said: "Make heap sick. Ute likeun little much honey."

We have had a fair crop of honey this season, although not up to the standard on account of the heavy rain-storms. This seems to be a favored clime for the apiarist on account of the extensive bee-foliage and the mild winters. Bees winter on the summer stands without any extra protection whatever, and with but little or no loss. Those bee-keepers who are seeking "greener fields and pastures new" would do well to cast their optics in this direction as soon as the reservations are opened for settlement, and we get a railroad, all of which we look for within the next two years.

Uinta Co., Utah.



A Reply to Mr. Newman's Criticism on the New Constitution.

BY DR. A. B. MASON.

FRIEND YORK:—Our friend, Mr. Thomas G. Newman, has kindly sent me a copy of what he calls "Criticism on the Constitution;" and in a letter with which it was enclosed he says he has mailed copies "to all the bee-papers, and a lively discussion should be the result if they publish it." I have no doubt they will publish it, and perhaps a lively discussion of his criticism "will be the result."—[We published it on page 742.—EDITOR.]

His criticism is addressed, "To the Officers and Members of

the North American Bee-Keepers' Association;" but as there is no such association, I presume he means the "United States Bee-Keepers' Union;" and as an officer of the Union I should like to have a hand in helping to making the discussion on his "criticism" a little bit "lively," and try to correct some of his misrepresentations.

After the Constitution was adopted at Lincoln, it became my duty, as Secretary of the United States Bee-Keepers' Union, to notify the Advisory Board of the National Bee-Keepers' Union of the action taken; and in order to hasten matters I asked the editor of the American Bee Journal, who was to publish the proceedings of the Lincoln convention, to put the Constitution and the motion ("that we request the Advisory Board of the National Bee-Keepers' Union to put this constitution to a vote of the members of that Union at their next annual election, for their adoption or rejection") in type as soon as possible, and send me at once enough proofs for each of the Advisory Board, which he very kindly did.

I at once sent them to the Secretary of the Advisory Board, Mr. Newman, and wrote him in substance that, "I sincerely hope the measure will pass, and I hope you will hurry the matter up as rapidly as possible, and get it in the bee-journals so that we can have time to discuss it before the annual election in January." It is more than probable that I asked him to make such suggestions as he might think best; but it was not sent him for the purpose of criticism; and as I had before sent him a copy with a similar request, and as in reply he made but one suggestion, I had no thought of his taking upon himself the responsibility of refusing to present the matter to the Advisory Board, and "refer it back to the next convention at Buffalo;" so in all kindness and candor, and with the best of intentions, as with Mr. Newman, I will try to point out what, to me, seem to be some of the "incongruities" of his "criticism."

The Constitution of the National Bee-Keepers' Union, in Arts. III. and V., provides who shall be members, and what officers it shall have, what their duties shall be, how they shall be chosen, and how long they shall hold their position; but it makes no provision as to when the officers are to be chosen. Now, if the National Bee-Keepers' Union can make such a grand success with such provisions in its constitution, what can possibly be the harm in putting similar but more complete provisions in the Constitution of the United States Bee-Keepers' Union? and if it, as Mr. Newman says, shows "incongruities" and lack of "completeness," what shall be said of the lack of "completeness" of the constitution of the National Bee-Keepers' Union, in the framing of which, I believe (but don't know), he took a leading part?

The aim in formulating the New Constitution was to in no way cripple or hinder, but, rather, to increase the scope and efficiency of the work of the old Union; and its constitution was studied, and its provisions incorporated in the new wherever it seemed advisable, never dreaming that the constitution of the National Bee-Keepers' Union was so "incongruous" and so lacking in "consistency and completeness."

He says that "Article V. creates an Executive Committee, but nowhere are the duties and powers of that committee defined." Well, well! did you ever? I wonder if he read the Constitution before writing his "criticism." If he did, he could hardly fail to notice that Sec. 2, Art. V., very distinctly defines one of the duties of that committee, and that half of Art. III. and all of Art. IX. are devoted to the same subject; and Secs. 1, 2, and 3 of Art. VI. are wholly devoted to the duties of the individual members of that Committee; and in no way, in the discharge of their duties, singly or collectively, do they, as Mr. Newman says, "interfere with the duties of the Board of Directors," and no "conflict of authority would ensue."

He asks, "If the Board of Directors be not the Executive Committee, what is the Board created for? What are its duties?" If he will read the last half of Sec. 4, Art. VI., and Sec. 6 and 7 of the same article, all of Art. VII. and the last half of Art. VIII., he will find what the Board of Directors is for, and what its duties are, quite fully set forth.

In criticising Sec. 3, Art. VI., he says, "Here is a big loop-hole, because it provides that the Secretary of the Union shall pay to the Treasurer of the Union all moneys left in his hands after paying the expense of the annual meeting." It has been customary for the Secretary to pay the usual expenses of the Association out of the moneys he received for membership fees, and pay the remainder to the Treasurer; and I am not aware that any one has ever before thought of there being even a small "loop-hole," to say nothing of a big one. If Mr. Newman considers this "a big loop-hole," how would he, if he were outside of the position of Secretary, Treasurer, and General Manager, fitly characterize the method of handling the hundreds—yes, thousands—of dollars of funds

that have been in his hands as Treasurer (General Manager) without a single provision in the constitution for its safety? I have not the means at hand for knowing all about the past condition of the treasury of the National Bee-keepers' Union; but, if my memory serves me correctly, during the years '86, '87, '90, '91, '93, '94, and '95, the General Manager handled about \$5,500 of the funds of the Union, and no one said anything about a "loop-hole;" and last year there was very nearly one hundred times as much of the money of the Union in the hands of the General Manager as was in the hands of the Secretary of the North American Bee-Keepers' Association. "Those living in glass houses should not throw stones."

In referring to the meetings of the Board of Directors he asks, "How are the expenses to be paid? If mileage and per diem are to be paid, it should be so stated." Well, for once I can agree with his "criticism;" and as no such provision is made, the very natural inference would be that "mileage and per diem" are not to be paid them, as is the case with the Advisory Board of the National Bee-Keepers' Union.

He speaks of a "compulsory meeting" of the Board of Directors, and "that the expense of such a compulsory meeting would be no mean item." The "compulsory" part is the last sentence of Sec. 6, Art. VI., and is no more "compulsory" than is the provision in Art. f. of the present National Bee-Keepers' Union, which says that it "shall meet annually," etc. Now, in the eleven years of its existence has the Union, which "shall meet annually," ever met? and if it has, who paid the "mileage and per diem?" Has the Secretary-Treasurer-General-Manager been paying "the mileage and per diem?"

"In referring to Art. X. he asks, "Why such tautology?" I believe I can answer that question quite readily. It is probable that those engaged in formulating the Constitution (among whom were Prof. Cook, Hon. Eugene Secor, Rev. E. T. Abbott, Hon. E. Whitcomb, R. F. Holtermann, J. T. Calvert, L. D. Stilson, Thos. G. Newman, Dr. C. C. Miller, A. I. Root, Bro. Ben, Geo. W. Brodbeck, E. R. Root, F. A. Gemmill, W. F. Marks, Geo. W. York, Hon. Geo. E. Hilton, M. B. Holmes, E. S. Lovesy, H. F. Moore, E. Kretchmer, with myself and more than a score of others) did not represent all of the wisdom there is among bee-keepers. Pages 737 and 738 of the American Bee Journal for Nov. 19, 1896, might be interesting reading for Mr. Newman.

It seems to me that his "criticism" on Sec. 7, Art. VI., is one of fault-finding rather than an effort to aid in so revising it as to make it better. I see nothing in it that would necessitate a "complete revision" of it, but I think it would be well to alter it by erasing the words "extra but" in the sentence where it says, "and cause such extra but equal assessments to be made," etc.

In replying to the last two paragraphs of Mr. Newman's article, I will say that the Constitution does not provide for "expensive annual meetings," and I can't understand why he so frequently refers to matters that are not even hinted at in the Constitution, and have nothing to do with it, unless it be to prejudice members of the National Bee-Keepers' Union against the measure. Here is an example: "If it is attempted to make it representative, it will fail," etc. Now, there is not the shadow of a shade of reference in the Constitution to any such attempt.

It seems to me that, in the last two paragraphs of his "criticism" he directly insults the intelligence of the nearly threescore bee-keepers who "had a hand" in preparing and adopting the Constitution, and shows his lack of consideration for the rights and opinions of others (who may be just as able as he, to say what is the best course to pursue) in assuming that he has a right to "refer back to the next convention at Buffalo for revision," etc. Since when has it been the prerogative of the General Manager "to refer back." Unasked, a matter that the United States Bee-Keepers' Union has requested the Advisory Board of the National Bee-Keepers' Union to submit to a vote of its members, quite a number of whom are members of both organizations? and since when, and by whom, has it been decided that the General Manager has the power to say that a body of bee-keepers—some of whom rank as the peers of any other bee-keepers—has not the right of petition? If he has this power, the sooner we know it the better; and if he has not this power, and he insists on exercising it, the sooner his successor is chosen the better.

The closing sentence of his article is the summing-up of the whole matter. Here it is: "There is therefore, nothing left for its advocates to do but to await the action of the convention next year; at least, so it seems to,

"Yours for every progressive step."

Shades of democracy! "Where are we at?" Mr. Editor, wouldn't that sentence look a little more complete if put in

Italics, or in large caps? "Nothing left for its advocates to do" but to wait till "next year!" Well, I think Mr. Newman will find that its advocates think there is something for them to do besides waiting, if that is the course he proposes to take; and it seems to me that about the first thing to be done is to nominate the General Manager's successor, unless he at once proceeds to pull in his bellicose horns and show a little consideration for the wishes of others who have a right to ask that they be heard.

I believe I fully appreciate the splendid work and achievements of General Manager Newman in pushing with all his energy, often hoping against hope, till he, with the aid of the Advisory Board, has established the Union on a firm foundation, and achieved for it victory wherever called to battle; but notwithstanding his great achievements, it seems to me that he has now planted himself squarely in the way of any "progressive step" being taken; and unless he "stands from under" he will be very apt, sooner or later, to ask, "Where am I at?" for the wheels of progress, although they may be blocked for a time, will finally roll on, despite all obstacles.

I know of no one having claimed that the Constitution is perfect; but it takes nothing from the funds now in the treasury of the National Bee-Keepers' Union, but adds to the funds; and instead of in any way weakening the efficiency of the work of the Advisory Board, its aim is to enlarge its field of labor and add to its efficiency; and I can see no reason why the members of the Union should not take a "progressive step" by adopting the Constitution adopted by the United States Bee-Keepers' Union at Lincoln.

If the Constitution is so adopted, the officers elected at the next annual election of the Union will be the Board of Directors of the new Union, until their successors are elected at the annual election in December, 1897.

Yours for the New Constitution and "every progressive step."
Station B, Toledo, Ohio.



Mountain Laurel Honey—A Short Report.

BY S. B. SMITH.

On page 626, is a communication from Dr. W. M. Stell, on poisonous mountain laurel honey. The Doctor is convinced by his experiment that the honey obtained from mountain laurel is poisonous, but I am not convinced; neither do I see anything in the Doctor's experiment to convince any one that laurel honey is poisonous. If the Doctor had taken the flowers alone, and obtained a poisonous sweet fluid, then his experiment would have been proof positive; but instead of taking the flowers alone, he used equal quantities of leaves and flowers. Now the leaves of the mountain laurel have always been known to be poisonous, so his experiment is not a true test. I was born and always lived in a laurel country until I came to Minnesota, therefore I know whereof I write.

In closing, the Doctor cautions bee-keepers to be more studious about poisonous plants. I have had some of those poisonous plants in my flower-garden almost every year for many years, and my bees have gathered honey from them, and I have never felt any injurious effects from eating the honey. The root of what is known as "wild parsnip" is a deadly poison to man or beast. Large quantities of this plant are found in nearly all meadows here, and I have never known of any cattle dying from eating the leaves of this plant. There were hundreds of acres of it the past season, and it was in bloom four or five weeks, and my bees worked on it the same as on sweet or Alsike clover—in fact, it was alive with honey-bees, and we have been eating the honey for weeks, and feel no bad effects from it. Try again, Doctor, and discard the leaves, and see what the effect will be.

THE SEASON OF 1896.

Bees did well here the past season. Some bee-keepers have been blessed with more new swarms than with a surplus of honey; others have had new swarms and a good quantity of surplus honey. I have six colonies, and they have not cast any swarms this year. They are now very strong, the hives full of honey, and all in good condition for winter. I have taken off 412 pounds of honey in one-pound sections, and I have 30 sections partly filled that I have laid aside to be finished another season.

I have a local market for all of my honey at 15 cents per pound, but bee-keepers are on the increase here, and the local market will be inadequate for the supply, so we will soon be obliged to look elsewhere for a market.

This is a very windy country, with no timber to protect the bees on windy days, so I have a field of Alsike clover and another of sweet clover only a few rods from my bees. Having so short a distance to fly, I find that they can work on windy

days as well as other days. There will be a field of 20 acres of Alsike clover near my bees another season, and I shall expect a great honey-yield.

Unless there is a great change in the weather I shall not put my bees into the cellar for some weeks, as I think it better for them to be out as long as the weather is such as to allow them to have a flight every few days.

Keeville, Minn., Oct. 30.



"Swarming—Its Cause and Prevention."

BY GEO. F. ROBBINS.

[We received the following enquiry, which we forwarded to Mr. Robbins for reply:—EDITOR.]

I have read in the British Bee Journal an article copied from the American Bee Journal, by Geo. F. Robbins, entitled "Swarming—Its Cause and Prevention." In this, Mr. Robbins advises "removing the brood." Now will Mr. Robbins tell a beginner a little more still? Where does he put the brood when he removes it?
F. M. G.

The remark in that article, to which the correspondent refers, is this:

"3rd. Remove the brood a short time before the swarm is likely to issue—perhaps a week, more or less."

Notice, I said that is one of "four methods" for prevention of swarming, for each of which some success is claimed. Removing the brood and replacing with empty combs, or with frames empty of comb, will usually prevent swarming, there is no doubt about that. But I want to say here that I do not practice it very much, nor recommend it very strongly. It is laborious, especially if the combs are replaced with empty frames, as in that case every frame of brood and honey should be taken out. If combs are used, and the honey-flow is of long continuance—three weeks or more—the process must be repeated, as the combs soon become filled with brood and honey, and we again have all the conditions that promote swarming. Another drawback is, if we are running for comb honey these combs serve as ready-made receptacles for storing honey, and make the bees slower to go into surplus cases. Still, the system is worth a trial. You might like it better than I do.

I believe I like best to use empty frames with an inch or so strip of foundation fastened to the top for a starter. In that case I always contract the brood apartment to five or six frames, put on a queen-excluding honey-board, and then a case of sections, in which I insert two or three sections of drawn comb for bait, if I have them. When I use combs I generally fill the brood-chamber to its full capacity.

I never find it difficult to dispose of the brood. I have practiced the following four methods:

1st. I always have a few weak colonies in the spring. These I confine to some three to five combs until they are strong enough to cover more, which is generally about the time I want to prevent swarming. This is about the beginning of the clover honey-flow, usually early in June. I simply take frames of brood enough to fill up these hives. I am not particular to shake off all the bees. Except early in the morning there are always cells of thin, freshly-gathered honey, which will shake out and daub the comb and bees so as to set the bees to cleaning things up, and effectually prevent fighting. If the weak colony contains one or two combs having little or no brood or honey, I take them out and put them into a hive from which I am removing brood, if I am filling it up with combs. If the colony is very short of bees, I carry more bees with the frames of brood.

2nd. I rear nearly all my queens from one or two that I have selected for that purpose, and at this time in the year I am wanting nuclei in which to insert queen-cells from those chosen breeders. To form them I take two or three frames of brood and bees from a colony likely to swarm, put them into an empty hive—aiming, of course, not to carry away the queen—and insert it all between two combs. If I am pushed for room for these combs, I put more in a hive than the number above given. I prefer not to have very many bees in a nucleus until after the young queen has mated, as the bees are more apt to swarm out with the queen when she goes out on her wedding flight, if there are very many of them.

3rd. If I have neither of the above uses for brood-combs, I simply form new colonies by shaking about two-thirds of the bees off the combs and putting them into an empty hive. I have sometimes allowed them to rear their own queen, sometimes giving them a cell. I have, however, done very little of this at all.

4th. While I work in the main for comb honey, I always

aim to produce some extracted honey. I usually have a few colonies, including nuclei, in which the young queen has gone to laying, that cannot conveniently be made strong enough to go into empty supers by simply filling up the brood-chamber with brood and the few adhering bees. So I add an upper story, generally putting a queen-excluder between, and fill it up with these combs. As the bees in this upper story hatch out, the combs are filed with honey, and in time I have a whole set of frames full of honey to extract. I am not always particular when practicing this system to take bees enough along to care for the eggs and unsealed larvæ. Bees hatching from such brood are of little or no use usually during the early honey harvest, and only become consumers during the long dearth of summer.

I said that I did not practice removing the brood to prevent swarming very much. In fact, I have usually allowed my bees to swarm, and disposed of the brood and remaining bees in the ways I have described above. For the last three years I have had almost no swarming on account of the poor honey seasons. I expect to try to prevent swarming when a season comes that bees will swarm, but I aim to practice chiefly the shifting device, as described in my article in the *American Bee Journal* for April 9, 1896.

Sangamon Co., Ill.



Queen Fertilization in Confinement.

BY JOHN ATKINSON.

During the year 1878, there appeared in the *American Bee Journal* seven different articles on "Fertilization in Confinement," as it was called, some claiming to have succeeded in having queens fertilized by selected drones, and others describing experiments or accidents which seemed to convince them that this much-desired object could be accomplished.

I quit keeping bees and subscribing for bee-periodicals soon after that time, and have not taken any bee-paper since, until recently, when I again subscribed for the "Old Reliable." I supposed that this object had been accomplished by some of our progressive apiarists long ago, but when I got Doolittle's book on "Scientific Queen-Rearing"—which I see was published in 1889—I find that it had not only not been accomplished at that time, but that Mr. Doolittle did not believe that those who claimed to have been successful were really so, but had been mistaken. And Mr. Doolittle shows his appreciation of the great benefits to be derived from it, and also his belief that it can't be done, by saying, "I would willingly give \$500 for a plan by which I could mate the queens I rear to selected drones as I wish, and do this with the same ease and assurance that our other work about the apiary is carried on." (Page 105, "Scientific Queen-Rearing.")

Also, Mr. R. M. Argo says (page 62, *American Bee Journal* for February, 1879): "But if the thing is possible, the man who discovers a safe and reliable method of controlling the impregnation of queens with select drones will confer as great a benefit to bee-keepers as Langstroth did in the invention of movable frames, and should have a gold medal awarded him, also one dollar by every bee-keeper in the United States, even if there are 50,000 of them."

Now, it seems to me that the different races of bees can never be kept absolutely pure, nor judicious crosses made, unless the apiarist can have absolute control of the selection of the male, as well as the female, progenitors of the "coming bee."

If in any back numbers of the *Bee Journal* of a later date than March, 1879, there has been any information on this question, I should like to know it; also, I wish to know if any more experiments have been made, on what lines they were conducted, whether they were successful, partially so, or unsuccessful, as I propose to make some experiments in this direction during the season of 1897.

I should like to have this question ventilated in the *American Bee Journal* during the coming winter months, to see what the "old timers," such as Doolittle, Prof. Cook, Dr. Miller, the Dadants, etc., think of it.

Crow Wing Co., Minn.



Something About the Rearing of Queens.

BY DR. E. GALLUP.

On page 662, Dr. Miller is puzzled and "dout know." It may be that I don't know. In olden times, when we used to rear queens haphazard, and from larvæ several days old, lots and slathers of them would come up missing just in that manner. The second season that I was in this State, I received in

the spring two queens imported late the fall previous. I introduced them successfully, and in some 16 or 18 days I went to get eggs for queen-rearing, and found both queens missing. Some six days previous I had taken eggs from both colonies, for queen-rearing purposes. The queens cost \$10 each. Both queens were what I call "stubbails;" that is, queens reared from larvæ too far advanced, do not have long, pointed, and tapering abdomens as they ought. Some of my queens received this season were of that class, and I never expect such queens to be long-lived. If they last until spring I shall supersede them early, as they almost invariably peter out suddenly, similar to the correspondent's queens.

Years ago, when Mr. Wagner edited the *American Bee Journal*, I had quite a confab with one correspondent on that subject. W. L. does not mention how or under what conditions his three queens were reared, but I strongly suspect they were what I call "forced queens," or reared under unnatural conditions.

When I first began rearing queens, and not understanding the above-mentioned kink, I succeeded in losing over one-half of my queens. They die suddenly, the same as a worker with old age, as it were, and in many cases the bees make no preparations for supersedure.

The correspondent says they seemed in a natural condition in early spring, but he does not even seem to know whether they were or not. Now, providing they died in early spring, before there were drones, it would leave the colonies in the condition he mentions, either with unimpregnated queens or laying workers.

And now, while on the subject of queens, a correspondent asks why 50-cent queens are not as good as higher-priced ones. I can see no earthly reason "why," if a breeder sees fit to rear queens for 50 cents, they should not be just as good, providing they are reared under the proper conditions.

Another correspondent wants to know what proportion of untested queens will prove satisfactory. Now, if a queen-breeder is thoroughly established in the business, and keeps all impure drones out of his apiary, by far the largest proportion will be purely mated. In one dozen received the past season, only one proved impurely impregnated; that is, judging by their worker progeny. Of course, queen-breeders themselves can afford to pay fancy prices for a superior queen. Yet I cannot see the necessity of us understrappers going to the extra expense, unless to gratify our own fancy.

Orange Co., Calif., Oct. 19.



Purity vs. Good Workers in Bees.

BY G. M. DOOLITTLE.

QUESTION.—Is not purity of stock the greatest essential in bees?

ANSWER.—Much has been said in the years that are past about a standard of purity for our bees; and some of us have often been led to ask ourselves the question, "Can we adopt a standard of purity that will always secure to us the best working qualities in our bees?" We can see that it would be easy for those who follow nothing but queen-breeding as a business to adopt a standard of purity, or secure something which would be called "thoroughbred," at least; but for the rank and file of honey-producers to adopt the same standard would be quite another thing. The workers from different queens of the same color and general appearance show a vast difference as to working qualities—at least, such is my experience.

In the spring of 1877, while changing a colony from one hive to another, I noticed a fine-looking orange-colored queen, with the workers all well marked. A neighbor, who kept several colonies of bees, was present, and remarked that he would prefer a darker-colored queen for business, and I agreed with his decision. No further notice was taken of the colony than of others till about June 25, when the bees were nearly through swarming. This one had not swarmed, but had 60 pounds of section honey nearly ready to come off. July 3 they gave a fine swarm which was hived. Although the parent colony had none of its queen-cells cut, it never offered to swarm again; and the result, at the end of the season, was 195 pounds of section honey from the parent, and 114 pounds from the swarm, or 309 pounds from the old colony in the spring. The queen reared in the old hive was very much like her mother, and both colonies wintered with the loss of but very few bees, and consumed comparatively little honey, according to many others.

The next season they showed the same disposition not to swarm till late; and from the colony with the old queen I obtained 151 pounds of section honey, while there were but few

other colonies that gave over 100 pounds. I then reared nearly all of my queens from this old one, as long as she lived, and found the majority of them very prolific layers, and their workers great honey-gatherers. After she died I began getting queens from other parties who reported good honey-yields through our bee-papers, to cross with mine, as in-and-in breeding is generally considered injurious to bees. Many of these queens did not prove to be equal to my own, and were soon superseded. Some proved to be good, and were used in connection with the above strain, which I have kept largely in the majority every since.

By this mode of crossing I have bred up a strain of bees which pleases me; and after years of trial I believe them to be second to none as honey-gatherers, although for their purity I can give no guarantee, neither do I think it necessary to guarantee any positive purity of any stock, except that it be good in every spot and place where you wish goodness. I am still striving to advance further along the honey-gathering line, so each year finds me securing queens from the most approved sources, although it is seldom I find one I care to use as a breeder; but as this "seldom one" is of great value, I consider myself well paid for all my trouble.

There is nothing in all the realm of bee-keeping that gives me more pleasure than does this work of improvement of stock for its honey-gathering qualities; and as we have several of our most prominent apiarists at work along this line, if perfection can be attained with bees I doubt not that America will stand at the head one of these days. But I doubt about that standing "at the head" being for *purity of stock*.—Gleanings.

CONVENTION PROCEEDINGS

Southwestern Wisconsin Convention Report.

BY F. L. MURRAY.

The southwestern Wisconsin bee-keepers held their annual convention at Wauzeka, Oct. 7 and 8, 1896. There was not a very large attendance, but one good feature about it was, there were no drones there—they were all "workers."

The convention was called to order by Pres. N. E. France, of Platteville. Prayer was offered by Rev. J. C. Hoffman, and H. Lathrop was then appointed Assistant Secretary.

"What is the best method of obtaining comb honey," was asked.

Mr. Evans said the question was too long to answer there. He did not think he would be in Wauzeka long enough to tell what he knew about it. He advised the questioner to procure some standard works and study them.

Mr. Lathrop said it was better to work for both comb and extracted honey.

Mr. Evans uses the comb leveler, and got much more honey from sections containing leveled combs than he did from those containing full sheets of foundation.

Mr. Lathrop advised not to put on sections until the bees are very strong, and the harvest has opened, or they will tear down the foundation.

Mr. France—A foundation mill adapted to making one kind of foundation will not make a good foundation of another kind.

WIDTH OF SECTIONS—SUPER BEST.

"What width of sections sell best on the city market?"

Mr. Evans—7-to-the-foot.

Mr. Murray—1½, with separators.

"What is best, wide frame or super for comb honey?"

The majority answered in favor of the super.

PRICE OF HONEY—MARKETING.

"What should be the price of prime white comb honey when prime white extracted sells at 7 cts. a pound wholesale?" The general opinion was that it ought to be double.

The Association discussed the advisability of organizing some kind of a honey exchange. Mr. Van Allen asked why all the members of the Association couldn't ship their honey to one member, who is well informed, and let him handle it on 5 per cent. commission? It came out in the remarks of differ-

ent members that commission houses charged some members 5 per cent. commission and others 10 per cent.

Mr. France related an experience of one bee keeper who shipped several barrels of prime extracted honey. The honey was reported in a leaky condition, and would have to be transferred into other barrels. The bee-keeper knowing that the honey was shipped in good condition took the train for the city, called at the commission house, made enquiry for extracted honey, as though he were wishing to buy. He was shown his own honey in the original barrels, and all in good order. He made himself known, and the result was that the commission house paid him for his honey, and also paid his railroad fare both ways.

One member said he thought it would be a good thing to have one of the members to handle the honey, but he feared the members might all want their money at the same time, and would not be willing to wait.

Mr. France spoke of an association of fruit men who sent a salesman out to take orders, and he sold more than the association produced.

AFTERNOON SESSION, OCT. 7.

First was the following

President's Annual Address.

With much pleasure we meet once more for the better acquaintance of our brother bee-keepers, that we may in mutual exchange of thought and methods in bee-culture all be able to take home with us something well worth our efforts to attend.

We gladly welcome these strange faces to our ranks, and invite you to become a prominent cog of this convention wheel, that has done so much good for its members in the past years of its turning.

We are all banded workers—without any lazy drones. Our society is, however, in mourning, for the broken ranks of its first great leaders—E. Pike, as President, and B. Rice, as Secretary. Their example to us, by earnest, honest, living, together with that of our bees, so industrious and saving in times of prosperity, should be valued. Are we, dear brother and sister bee-keepers, so living in the age of wisdom that we may sweeten the way of our future?

By their fruits we shall know them. The past dry seasons have not allowed our faithful workers to show the fruits of their labor. Did we get discouraged when last fall our 600 colonies had only stores enough for half that number, and a prospect well established of a very little harvest the next season? By no means. We carefully studied our situation, decided better seasons were sure to come; so swept 180 of our weakest colonies from their homes into their grave, and fed their stores, together with 12 barrels of the best sugar, to the rest. Let our failures teach us a lesson, even if at a great cost—why these failures, and how to overcome them in our locations and management.

The time of this convention is yours, and I hope you will so use it, that time to adjourn will find us warmed up in our work to a white heat. Besides the topics assigned on the program I ask you to be free to keep the question-box in constant use.

A report for July, 1896, showed 30,000 colonies of bees in Wisconsin; 1,500,000 pounds of honey for the 1896 harvest; which at 8 cents per pound, makes \$120,000; and \$5,000 worth of beeswax. A total of \$125,000, which by a later report made was increased to \$150,000. There was foul brood in nine counties.

I feel that our industry in this State is of enough importance that we owe a duty to our brother bee-keepers, and that we in union should command legislative respect, and have sweet clover stricken from the noxious weed roll, and a law to protect our bees from the dangers of the dreaded disease—foul brood.

N. E. FRANCE.

REARING QUEENS.

Mr. Van Allen, on the best method of queen-rearing, said he rears queens from cells built under the swarming impulse in natural cells. He has had queens live five years and do good service. He takes the cells out at about the 8th day. One cell is placed in a nucleus, or if more are put in they are protected by putting them in cages. He claimed that he could winter queens in nuclei if the bees could cover three frames.

REARING OR BUYING QUEENS—WHICH?

"Which is the best method, to rear queens or buy them?" A Member—Rear your own queens, and only buy when you want to infuse new blood into your bee-yard.

Pres. France—We ought to rear our own queens from our best honey-gatherers

PACKAGES FOR EXTRACTED HONEY.

Mr. Dexter—Put your honey up in small packages so that it will go direct to the consumer. If sold in barrels it goes to dealers who mix it with glucose before it goes to the consumer. Honey in pails would have to be boxed or have the balls removed, or the freight rate would be higher.

Mr. Van Allen—We have found a package that has proved very satisfactory. It is a basswood keg holding 180 pounds.

Pres. France—I use white-oak barrels with iron hoops. I have the barrels very dry and well seasoned, and drive hoops well and test each barrel by blowing into them to see if they are air-tight. Some people advocate waxing the barrels to keep them from leaking, but my father says to wax the cooper until he can make a barrel that won't leak. Our barrels hold 360 pounds.

LARGE OR SMALL HIVES.

Mr. Arms—I use a hive that measures $13\frac{3}{4} \times 12\frac{1}{2} \times 12$ inches, inside, which I have always had good success with in getting a honey crop. I think the hive question depends more upon locality and the size of hive a bee-keeper has been used to than anything else.

Mr. Evans (of Iowa) likes the Heddon hive. He winters his bees in the cellar, but thinks they would be all right to winter out-doors, if two sets of frames are used.

CORN HONEY—SHADE FOR HIVES.

“Do bees get honey from corn?”

Mr. Murray—I have watched the bees very closely, but never could find them gathering any, and never could find any honey in their honey-sacs when working on corn.

Pres. France—I have found by experiment that at times the bees did gather a little honey from corn, but I found that they gathered honey only in one instance.

Mr. Van Allen—At one time I think my bees gathered honey from sweet corn.

“Is it necessary to have shade for hives?”

Mr. Wilson—I have thought that my bees did better on hot days when in the shade of trees than those that had no shade, but I think if hives are painted white they do not need shade so much.

Pres. France—Too much shade is not good. Scattering trees well trimmed up are the best.

Mr. Evans—I use and prefer shade-boards.

SUPERSEDING QUEENS—FALL UNITING.

“If a young queen is dropped into a colony containing an old, worn-out queen, in how many cases will the old queen be superseded?”

Mr. Evans—I should think once in about nine times.

Mr. Van Allen—I have often succeeded by running a queen just hatched into the entrance of such hives.

“How can I most successfully unite colonies in the fall?”

Mr. Murray—Take the cover off the hive you wish to unite to, put on a piece of newspaper, and after tearing a few small holes in it lay it over the frames, and then place the other colony over the hive after removing the bottom-board. By the time they get the paper pulled to pieces they will be well acquainted, and there will be no fighting.

Messrs. Evans and Van Allen—Smoke the bees well until they get well filled with honey, then unite by placing the frames in one of the hives alternately, thus mixing the bees up so that they will not know which from tother.

“What is the greatest enemy to the honey industry?” Some said too much fruit; others, bad seasons; and others, foul brood.

MORNING SESSION, OCT. 8.

Pres. France showed the convention a specimen of the Rocky Mountain bee-plant, which he recommended as a good plant to be propagated by bee-keepers, and offered each member a small package of the seed if they wished to try it. Then followed the reading of a draft of the proposed Foul Brood Bill, which we hope will become a law at the next session of the legislature. This Bill is one that has been decided on after carefully considering and comparing the Canada, Colorado and California foul brood laws. Here is a copy of the prepared Bill:

Foul Brood Bill—Recommended by McEvoy.

AN ACT FOR THE SUPPRESSION OF FOUL BROOD AMONG BEES IN WISCONSIN.

SEC. I. APPOINTMENT.—Upon the recommendation of a majority vote of the members of the bee-keepers' societies of Wisconsin, the Governor shall appoint for two years a State Inspector of apiaries, who shall, if required, produce a certificate from the Governor that he has been appointed.

SEC. II. DUTIES.—The Inspector shall, when notified, examine such reported apiaries, and all others in the same locality not reported, and ascertain whether or not the disease known as foul brood exists in such apiaries; and if satisfied of the existence of foul brood, he shall give the owners or caretakers of the diseased apiaries full instructions how to treat said cases, as in the Inspector's judgment seems best.

SEC. III. DESTRUCTION OF BEES.—The Inspector, who shall be the sole judge, shall visit all diseased apiaries a second time, and, if need be, burn all colonies of bees and combs that he may find not cured of foul brood.

SEC. IV. CONSTABLE TO HELP.—A Justice of the Peace shall, on the complaint of an Inspector of apiaries, send a constable to help the Inspector to burn diseased colonies of bees.

SEC. V. VIOLATIONS.—If the owner of a diseased apiary, honey or appliances sell, barter, or give away, any bees, honey, or appliance, or expose said disease to the danger of other bees, or refuse to allow said Inspector to inspect, shall, on conviction before a Justice of Peace, be liable to a fine of not less than \$50 nor more than \$100, or less than one month's imprisonment in the county jail, nor more than two months' imprisonment.

SEC. VI. ANNUAL REPORT.—The Inspector of apiaries shall issue an annual report to the Governor of Wisconsin, giving the number of apiaries visited, the number of diseased apiaries found, the number of colonies treated; also the number of colonies destroyed by fire; and his expenses.

SEC. VII. EXPENSES.—Said Inspector shall receive \$4.00 per day and traveling expenses for actual time served, which shall not exceed \$500 per year, to be drawn from the State Treasury, the same as other State officers.

Mr. Evans—As foul brood may be transmitted in foundation, it is advisable for bee-keepers to purchase from those whom they know are careful in the preparation of wax.

USING OLD FOUNDATION.

“How long will foundation remain good in frames or in sections?”

Mr. Evans—I have used it five years' old.

Mr. Murray—I had foundation in sections two years old not drawn out. The bees would not accept it at all, but foundation that had been kept the same length of time in a box, when put into sections, was readily accepted by the bees.

Pres. France advised dipping old sheets of foundation in warm water to revive it.

BEES ON SHARES—WINTERING.

A question was asked about bees on shares. Only a few had any experience. In some cases the plan was satisfactory, and in others it was not. It is always best to have a contract in writing.

Upward ventilation in the cellar was considered. Mr. Van Allen uses a 6-inch pipe in the cellar, and considers it very necessary that there should be good ventilation in the bee-cellar. He does not let the cold air in direct. His cellar stands at about 42° to 44° . He can tell from the sound of the bees what the temperature is. His cellar has no pipe nor special opening to the outer air. He has wintered 170 colonies in his cellar without any loss.

Some winter their bees with sealed hive-covers and loose bottoms; others use quilts and the bottoms nailed on.

The question arose, “Why do bees seal up the top if it should not be that way?”

Pres. France—Bees prepare themselves to winter out-doors where they should be. I do not advise putting bees out too early, as it often results in more or less dead brood which may develop into foul brood.

AFTERNOON SESSION, OCT. 8.

The election of officers resulted as follows: President, N. E. France, of Platteville; Vice-President, Thos. Evans, of Lansing, Iowa; Secretary, F. L. Murray, of Calamine; and Treasurer, J. W. Van Allen, of Ilaney.

Then came a long discussion on foul brood, which ended by appointing Pres. France as a committee to put the Foul Brood Bill before the House at the next session of the Legislature. He was also recommended as foul brood Inspector for Wisconsin, providing the Bill passed.

The question came up before the meeting again as to some plan to have the honey produced by the members of this Association sold by some one of the members as an agent to handle the same on commission, by taking samples of each bee-keeper's honey. After much discussion it was voted that Pres. France act as salesman for the Association.

F. L. MURRAY, Sec.

OLDEST BEE PAPER IN AMERICA ESTABLISHED IN 1861

THE AMERICAN BEE JOURNAL

GEORGE W. YORK, Editor.

PUBLISHED WEEKLY BY

GEORGE W. YORK & COMPANY,

118 Michigan St., CHICAGO, ILL.

\$1.00 a Year—Sample Copy Sent Free.

(Entered at the Post-Office at Chicago as Second-Class Mail-Matter.)

Vol. XXXVI. CHICAGO, ILL., DEC. 3, 1896. No. 49.

EDITORIAL COMMENTS.

Our Convention Picture on the first page we think will be appreciated by all. We regret that we were not sure just "who is who" in many of the faces shown, and so were compelled to omit their names below the picture. We would consider it a favor if those whose names are thus unavoidably omitted will please write us which numbers belong to them, so that we can have all correctly named in the pamphlet report, soon to be issued and mailed to the members.

Amalgamation.—Hon. Eugene Secor, of Forest City, Iowa, writes us as follows on this subject:

I don't believe Mr. Newman will stand in the way of adopting the New Constitution if the Managers of the National Bee-Keepers' Union advise calling an election.

The only object in proceeding in the manner outlined at Lincoln—according to my judgment—was to consolidate all our interests in one organization, and provide for a transfer of the funds on hand. If no funds had been in the Union treasury, a new society could easily have been organized, articles adopted on the spot, and its officers named until the next election.

Of course, the members of the old Union can refuse to unite with the new, but what bee-keeper's interest will be subserved thereby? Would we be stronger with three separate societies, all more or less national, than with one?

The work contemplated by the new organization is the same as under the old Bee-Keepers' Union, with some additional powers.

It was made national for the better working out of problems which present themselves to the fraternity in the United States, where at least nine-tenths of the members reside.

It is to be hoped that everybody will cease his fault-finding, withhold his petty criticisms, and unite in building up one strong, influential society, which shall be respected by the Government and hated by evil-doers.

Probably time, and the good judgment of its members, will suggest changes in the Constitution. Well and good. Even the Constitution of the United States was not so wisely framed as to need no amendments. People should not expect the Lincoln convention to have been wiser than the Fathers of the Constitution.

I hope we may get together in a fraternal spirit, and work for the common good.

EUGENE SECOR.

We earnestly commend Mr. Secor's wise words to all who would even think of opposing the uniting of the North American Bee-Keepers' Association and the National Bee-Keepers' Union into one grand society. That is the very proper thing to do, and the sooner the better.

Next week we will give a very strong article on this subject, from Mr. W. Z. Hutchinson, who, we believe, first suggested the idea of amalgamation. Of course he favors the New Constitution as adopted at Lincoln, just as we believe nine-tenths of the bee-keepers of the United States will, when they once see how it is intended to protect and promote their in-

terests. The Old Union has done most royal service, but the New Union contemplates advancement and progress all along the line. May it move onward in its mission of defense for the right and overthrow of the wrong!

"**Bees in Horticulture**" is to be the subject of a paper that Dr. Miller has been requested to write for the Northern Illinois Horticultural Society, of which the Doctor is a leading member. This is a good omen. It shows that at least some horticulturists are awaking to the fact that bees are really their friends, instead of enemies, as some of them, we fear, had erroneously supposed. Speed the day when the honey-bees will be rightly valued by all who are dependent upon their varied and useful labors.

Sending Money by Mail.—As the time for renewing subscriptions is now at hand, we would like to give a word of caution about mailing money, and feel that perhaps we can do no better than to quote the following:

"Money never should be enclosed in letters for transmission through the mails," remarked an old post-office inspector recently.

"In the first place, it is unnecessary to do so, because money orders are so cheap; and in the second place, money in a letter offers a constant temptation to those who handle mail.

"It is practically impossible to place money in a letter so that the postal clerk into whose hands the letter falls will not instantly detect it. Paper money has a peculiar odor, unlike anything else on earth, and the clerk who is dishonest uses his sense of smell in spotting valuable letters rather than the sense of touch."

Another thing: *Please don't* send us personal checks on local banks, for such are subject to a big discount. Send post-office money order, express money order, bank draft on Chicago or New York, or register the letter containing money.

An Educated Honey-Taste is not an uncommon thing. Mr. James Bennett—a contributor to the excellent Australian Bee-Bulletin—wrote: "When a person has acquired a taste for one variety of honey he prefers that variety to any other." Dr. Miller, in commenting upon the statement, said this in Gleanings:

"Australians think eucalyptus the finest honey in the world; but England will none of it, notwithstanding the earnest efforts made to establish a market for it. A point in favor of home markets is the preference for home honey."

While there may be a good deal in the educated taste for honey, we think that it applies principally to honeys of peculiar flavor. Who ever heard of any one not liking the taste of white clover honey, or alfalfa honey, or even a mild-flavored basswood honey? True, one must learn to like honey from heart's-ease, buckwheat, and other somewhat dark honeys. If it is a possible thing to educate the home trade to the use of all the darker grades of honey, so much the better for most city markets. The light-colored, or white, honeys are the ones demanded in the Chicago market, and likely in nearly every other large city.

The Ontario Association.—A periodical called Farming, contained the following historical paragraphs in reference to the Ontario Bee-Keepers' Association, which is to hold its next meeting at Toronto, Dec. 8, 9, and 10, 1896:

The Ontario Bee-Keepers' Association was organized in 1880. Its objects are to promote the interests of bee-keepers in every possible direction, by means of discussions, papers, reports, etc., and it has also accomplished a great deal of good in procuring legislation, both at Ottawa and Toronto, favorable to the bee-keeping interests. In 1890, the Foul Brood Act was passed by the legislature of Ontario, under which Act an inspector of foul brood—Mr. William McEvoy, of Woodburn—was appointed, who has labored ever since most effectively in combating the disease. Under his labors thousands

of colonies have been cured of the disease, while numerous other colonies, too far diseased to be cured, have been destroyed. By means of this effort the disease is speedily disappearing from our Province. An Act of the legislature has also been secured, preventing the spraying of fruit trees while in full bloom, resulting in a great protection to bee-keepers, without any loss to fruit-growers.

The Association has always been active at exhibitions, and delegates are always appointed to attend all the leading shows to look after the interests of bee-keepers. The splendid display made by the Association at the Colonial Exhibition in 1886 did much for the industry in Canada, while at the World's Columbian Exhibition, in 1893, the Association's exhibit was so strong that it secured a larger number of awards and prizes than were given to any other State or Province.

The weakness of the Association's work, so far, has been in the want of attention given to the apicultural education of the general public. This has, to some extent, been a serious loss to the industry, for where people are not informed they will not take interest; and where they are not interested they will not spend money. But an improvement is now taking place in this respect. Experienced bee-keepers are attending our farmers' institute meetings, and are doing their best to excite a bee-keeping interest among general farmers, and to spread abroad the best information obtainable relating to the bee-keeping industry. The result will, do doubt, be a great extension of the industry among the farmers of the province.

The officers of the Association for 1896 are: R. F. Holtermann, of Brantford, President; J. K. Darling, of Almonte, and W. J. Brown, of Chard, Vice-Presidents; William Couse, of Streetsville, Secretary; and Martin Emigh, of Holbrook, Treasurer. Mr. F. A. Gemmill, of Stratford, is sub-inspector of foul brood. Prominent members are Col. Pettit, of Belmont; J. B. Hall, of Woodstock; Rev. Wm. F. Clarke, of Guelph; R. McKnight, of Owen Sound; and A. E. Sherrington, of Walkerton. The late Allen Pringle, of Selby, was also a prominent member of the Association.

The California Exchange—or its exemplary Secretary, Mr. J. H. Martin—has been greatly humiliated through a slight error which we printed lately. Our "copy" was entirely correct, but the proof-reader must have been a little "off." The following will explain:

LOS ANGELES, Calif., Nov. 16, 1896.

MR. EDITOR:—Will you listen hard to what I have to say? You have done me a gross injustice, and if that injustice which appears on page 728 is not set right at once, I will be discredited and dishonored by every bee-keeper in California that can walk a bee-line.

In your comments upon a clipping from the Rural Californian you tell bee-keepers to send their address to me at No. 213 North Main Street. Now, Mr. Editor, it makes me shiver to think that such a downright fabrication should be blazoned forth on the pages of the old American Bee Journal. Mr. Editor, the number is 218 instead of 213, and how could you have the gall to make such a stupendous falsification?

And, Mr. Editor, listen to the grave consequences which follow. As soon as I saw those misleading figures staring me in the face, I hastened to find No. 213, to avert, if possible, the flood of letters and callers that would flow in upon an innocent and unsuspecting individual. "Yes," said I, as I ambled along, "here's No. 211, and here's a blank, then 215. Yes, I must try the blank." I couldn't see in through the elegant ground-glass doors, so I pushed boldly in, and found several men in the room. Says I to the man that was in his shirt sleeves, and looked like the proprietor, "Is this No. 213?"

"You bet," said he; and he set out two big bottles and some tumblers on the bar, and says he, "What'll ye take?"

"Jewhiskers," says I; "this is a saloon!" and I hastened right out and shook the dust off my shoes on the doorstep.

Now, Mr. Editor, I am a confirmed Prohibitionist, had on a relic of the late campaign—a Levering button. I looked down to the good man's picture—how sad the expression; he knew he couldn't be elected. But my face had a more intense sadness, when I realized that scores of honest, well-meaning bee-men would tramp up that street and poke themselves into that vile saloon, and inquire for Martin!

And worse than that, I could endure such things for a season, but it wrings my two kidneys to think that some of our California bee-men will not only inquire for me, but they'll take the bottle? The thought of it is almost beyond my en-

durance. And, Mr. Editor, under the circumstances, I want to kick, and I will kick.

Now, sir, see if you cannot say in your next No. 218; or, better still, P. O. Box 152. Then I'll stop kicking.

J. H. MARTIN.

If we were given to enthusiastic or emotional writing, we would say that it was accompanied with a mixture of smiles and tears that we read Mr. Martin's kick. It was an unpardonable crime on our part, we know, and we don't know what to do to atone for it. Perhaps by presenting Mr. Martin's sad, long-drawn-out and tear-stained foot-print in the shape of a "kick," it will result in a grand reponse from all California bee-keepers—an elbowing mass endeavoring to be among the first to jump into the exchange hand-wagon. If such shall be the final result of our error, we think Mr. Martin will feel more inclined to forgive us.

In concluding this harrowing tale, permit us to call your attention to the fact that Sec. J. H. Martin's address is 218 N. Main St., or P. O. Box 152, Los Angeles, Calif. His office is exactly like ours—no saloon attachment; simply press the Levering button—and all your wants will be promptly attended to.

PERSONAL MENTION.

DR. A. B. MASON—the energetic Secretary of the North American Bee-Keepers' Association—celebrated the anniversary of his 63rd birthday and 38th wedding day, Nov. 7. In the evening some of his friends gave him a surprise, and he writes that they "acted as though they owned the 'ranch.'" We join with his hosts of friends in wishing the Doctor many returns of the happy day on which occurred two events of so much importance to himself.

MR. CHAS. GRIESBACH, of Clay county, Ind., began last spring with two colonies of bees in 8-frame hives, which he bought for \$7.00. During the season he increased them to six colonies, and took 375 pounds of comb honey. All of which is a splendid report, especially so when it is known that Mr. G. is a beginner. He set out 114 linden trees a year ago, 106 of them having grown all right; the 8 were re-set. Some of them were 25 feet high when set out.

MR. L. L. SKAGGS, of Llano Co., Tex., says this in a letter of recent date:

"The American Bee Journal has been a great help to me. You are so good about looking out for swindlers. When I see a swindler's advertisement in a paper, and I know that the publisher knows what he is, I stop taking that paper, for it shows that the publisher doesn't care who gets beaten, just so he gets a little money out of it. So long as you hold on like you have been doing, I want the American Bee Journal."

MR. H. D. CUTTING, of Tecumseh, Mich.—one of our valued corps of "Question-Box" contributors—is threatened with blindness, we regret very much to hear. In a letter dated Nov. 21, he says he can write but little, and read less. He can do neither by artificial light. It is a case of "glaucoma." He expects soon to have an operation performed on one eye, in order to save it, but the other is thought to be too far gone. We are sure Mr. Cutting's many friends will be pained to learn of his misfortune, and hope with us that he may be able to save at least one of his eyes.

MR. WM. RUSSELL, of Minnesota, wrote us as follows, on Nov. 16:

"Keep up the war against swindlers, honey-adulterators, and all kindred humbugs. I am sure you have the sympathy and approbation of all honest men, whether bee-keepers or not."

We wish to thank Mr. Russell for his kind expression, as well as for the \$1.00 for the renewal of his subscription, with which he "backed up" his appreciated words. We would like ten thousand more subscribers just like Mr. R. If each present subscriber to the Bee Journal would send only one new subscriber, we would have a good many over the desired ten thousand.

Questions AND Answers

CONDUCTED BY

DR. C. C. MILLER, MARENGO, ILL.

[Questions may be mailed to the Bee Journal, or to Dr. Miller direct.]

Feeding Bees for Winter.

I am much troubled to know what to do with a colony that I have been feeding honey for some time, which they ate all right; but a week or more ago I began feeding sugar syrup, but they would not eat it. After a few days I gave them honey again in the comb as before, but they will not touch it now, and are only eating what little honey they have stored. What can I do to make them eat what I give them? I am very anxious to save them. They are Italians. T.

ANSWER.—When bees will not take syrup or honey under favorable conditions, it hardly seems they can be suffering much for want of stores. Possibly, however, the low temperature may have something to do with it. If the weather is very cold they are unwilling to leave the cluster, and if sufficiently cold they will starve rather than break cluster. Possibly they reason, if we may suppose bees ever reason, "It's so cold that we'll be sure to freeze to death if we leave the cluster, and we may just as well stay here and starve in a kind of sociable way as to get away and freeze without any friends with us. Besides, if we can stick it out just a little longer, perhaps the weather may become warmer." If you can put near the cluster combs containing honey or syrup that has been sprinkled into the combs, then the first day that it is warm enough they will be likely to take the food provided. Or, you may make some candy as described in the last Bee Journal, put it over the brood nest, and cover up warm, and the bees will find their way up. Better not disturb them, however, when they are very cold.

Hands Poisoned by Propolis.

Does the propolis we clean off the sections poison one's skin? My niece, who assists me in cleaning the sections, seems to get poisoned with the propolis much as I have seen people with poison ivy.

I am pleased to know, through the Bee Journal, that you have so much fine honey this year. I, too, have very white honey this year, and lots of it. I have now 100 colonies. They do not swarm in my locality, that is, if they have room enough to work in. R. K.

ANSWER.—I never before heard of one's skin being poisoned with propolis. I think most persons experience no inconvenience from it, unless it be the same inconvenience they would experience from any dust, for at times when scraping sections on which the propolis is very dry, there will be a good deal of fine dust from it. One member of my family, however, cannot do very much scraping without suffering therefrom. The eyes and nose smart, and it seems to bring on a kind of influenza. But I never heard before of any one's hands being affected by it. It seems, however, that there may be exceptional cases in which the skin is so exceedingly sensitive that propolis acts as a poison upon it. Fortunately, such cases are probably very rare.

Spring Stimulation—Section Foundation Starters.

I winter my bees on the summer stands with outside case, the sides packed with leaves, super cover on top of the hive, a $\frac{3}{4}$ inch hole in the center, over which is a feeder covered with wire-cloth. Over all I put a cork mat tucked tight and nice.

1. I find that to let the bees alone they do not get strong enough for the crimson clover that blossoms May 15. Now, when shall I commence to stimulate them for brood-rearing, and how much and how often to feed?

2. How near the bottom of the section should full foundation sheets come?

I have 48 colonies, and got \$100 from them this season. There was no spring flow for surplus; the fruit and all the

plants blossomed the same day, and the hot days used up the flowers. J. C. S.

ANSWERS.—1. It's a problem whether you can do very much to make the bees get ahead any faster than they would of their own accord, all the time providing that the colony is strong and supplied not only with plenty of honey and pollen, but a great abundance thereof, and providing the weather is favorable all through. But it may be worth the trial. There may be a time when the weather is favorable for daily flights, but nothing for the bees to do outside. Certainly, at such times it seems feeding might have a stimulating effect. Some German bee-keepers speak very highly of stimulative feeding. Don't commence till bees fly nearly every day. The amount to be given depends somewhat upon what the bees will take and what they already have on hand. If plenty of stores are already in the hive, perhaps a half pound every other day, well diluted. If stores are somewhat lacking, the amount fed may be increased in proportion to the lack. If you don't care for the trouble you can feed every day.

2. About $\frac{1}{4}$ inch, if only one piece is put in each section. If two starters are used, there may be a space something less than $\frac{1}{4}$ inch between the upper and the lower starter, the lower starter being from $\frac{1}{8}$ to $\frac{3}{8}$ inch deep, and preferably of foundation a trifle heavier than the upper starter, as a bottom starter of very thin foundation sometimes lops over.

Wood or Tin Separators.

Can I use either wood or tin separators in the Langstroth hive? My supers have pattern-slats. J. E.

ANSWER.—The general principle to be considered is that when separators are loose they should be of wood, and when nailed they should be of tin. Put in a tin separator without nailing it fast, and it will be wavy. You see it must be stretched, and stretched pretty tight, then it will be straight, and it can't be kept stretched without nailing. On the other hand, there is no danger of wood taking a wavy shape, considered lengthwise, for the stiff grain of the wood will not permit that. But if the wood is nailed on tight, and swells a little with moisture, then it will curl up if held in place with nails, whereas, if not nailed, it will have room to swell and still remain flat, being held flat by the sections squeezing together. So on a Langstroth hive you can use either tin or wood, if the tin is nailed on and the wood left without nailing.

Late Swarming.

I am a beginner in bee-culture, but it appears to me something new, so I write about it. My bees swarmed yesterday (Oct. 19). I had noticed many drones flying around the hive for a week or two, but did not think it meant that they intended to swarm. To my utter astonishment I saw the air full of bees yesterday. I hived them, and they appear to be working all right. There are plenty of bees left in the old hive. San Antonio, Fla. J. W. C.

ANSWER.—It is something unusual for bees to swarm in the North after the middle of August, although this year there were more or less of them, but after the middle of October is quite another thing, and I suspect it is exceptional even in your sunny land of flowers. It must be that the season was such that honey was gathered unusually late, at least in any great quantity.

Remedy for Moths and Wax-Worms.

Please give a remedy to prevent moths and wax-worms from getting into hives and combs. I have lost dozens of colonies by these enemies. SUBSCRIBER.

ANSWER.—A moth can get into any place a bee can. So you can't shut out moths without shutting out bees. A good, strong colony of bees is a good preventive against moths. Even a moderately strong or a weak colony will keep out the moths if the bees are of good Italian stock. So the evident remedy is to keep Italian bees, and if for a time it seems necessary to keep blacks, let the colonies be strong, even if some uniting must be done. If hives in which bees die through the winter are left till warm weather without any bees in them, such hives will be a perfect hot-bed for worms. Look out for them, either by sulphuring them when you find worms making their appearance, or by putting the combs in a story under a hive containing a strong colony. A strong colony of Italians can take care of three or four stories of combs.

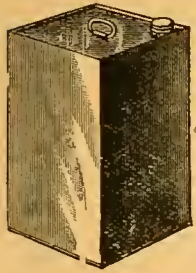

Finest Alfalfa Honey!

IT SELLS ON TASTING.

The Honey that Suits All Who Buy It.

We can furnish **White Alfalfa** Extracted Honey, in 60-pound tin cans, on board cars in Chicago, at these prices: 1 can, in a case, 8 cents per pound; 2 cans in one case, 7½ cents; 4 cans (2 cases) or more, 7¼ cents. The Cash must accompany each order.

A sample of the honey will be mailed to an intending purchaser, for 8 cents, to cover postage, packing, etc. We guarantee purity, and what we ship will be equal to sample.

Now it seems to us here is a splendid chance for any bee-keeper to supply his home demand after his own crop is all sold. Or, why not begin now to create a local honey-trade? Order one 60-pound can first, and start out among your neighbors and friends, and see what you can do. You ought to get at least 15 cents per pound in 5-pound lots, or 50 cents for 3 pounds. Some may be able to do even better than that, though we think that enough ought to be sold at these prices to make a fairly paying business out of it. Give it a good trial. Push it. It may grow into a nice winter's work for you.

GEORGE W. YORK & CO., 118 Michigan Street, CHICAGO, ILL.

✦ MONEY SAVED IS MONEY GAINED. ✦

THE ROYAL UNION Life Insurance Company DES MOINES, IOWA.

The Iowa Policy

Is one that definitely promises to keep an accurate account with you; credit your premiums and interest, charge the actual expense and mortuary cost, and hold the remaining funds subject to your order.

Agents Wanted.

JOHN B. KING, GENERAL AGENT,
Suite 513 First Nat'l Bank Bld'g,
20 Atf **CHICAGO, ILL.**

Mention the American Bee Journal.

DUQUESNE COLLEGE!

PENN AVE. AND EIGHTH ST.

PITTSBURG, PA.

Thorough Courses — Classical, Scientific, Normal, English, Commercial, Preparatory, and Ladies Literary. Efficient and experienced instructors. Day and Night sessions.

Send for Catalog.

Mention the American Bee Journal.

THROAT AND LUNG DISEASES, DR. PEIRO, Specialist Offices: 1019, 100 State St., CHICAGO. Hours 9 to 4.

General Items.

Experience with Bees.

My work with bees dates back only six years. I began with one colony of hybrids, caught on an oak bush near my father's barn. Later I decided to try bee-keeping for a livelihood. I subscribed for the American Bee Journal, and have been a constant reader ever since. I always try to make a colony pay expenses the first year. I purchase them, and have succeeded so far. My average yield per colony has been 60 pounds. In 1894 the yield was 113 pounds per colony; in 1895, 45 colonies, spring count, produced 5,000 pounds, mostly comb honey. In 1896, 3,000 pounds of comb honey and 2,000 of extracted, from 90 colonies, spring count. This year has been the poorest of the six.

I make my own hives, 8-frame Langstroth, which I think, after repeated trials, are best suited to this locality. I hive swarms on full sheets of foundation, and use full sheets in the sections. I have had returns from but one shipment this season, and that netted me 10 cents for dark comb honey. I sell most of my extracted in the home market.

I winter my bees in an out-door cellar, keeping the temperature at 40° to 45°, and have not lost any to speak of. My 130 colonies are all in the cellar now.

JAS LIGHTFOOT.

Eau Claire Co., Wis., Nov. 16.

A Bee-Experience—Mailing Queens.

In the fall of 1895 I bought two colonies of bees from a neighbor. I put them into a store-box, and packed straw around them, and they came out in good condition last spring. I increased to six colonies, and sold one, which leaves five. I saved all the swarms, while my neighbors let half of their bees go to the tall timber. One man told me he let 34 swarms fly off; another lost all he had. One farmer caught five swarms, and I transferred three of them, and they are doing well.

This is a good bee-country, as we have acres and acres and acres of white clover. It grows in fence-corners, along the roadside, and everywhere else. About six miles north sweet clover is making its appearance, and we will have it here, too. We have lots of catnip, some wild flowers, and flowers of all kinds. Mustard grows wild here, but I don't see any bees on the smartweed here.

My bees are hybrids and blacks, but I will Italianize them, as I want nothing but Italians. I bought three Italian queens this fall, introduced them, and they are doing finely.

I want to say that I agree with H. Galloway, on the queen-shipment question. I sent to Ohio for my first queen, and she arrived dead; she had only about half a dozen bees in the cage. I sent her back, and the dealer sent me another one; this time the cage was so full of bees that I could hardly see the queen at all. I put the cage in the colony, and the bees ate the queen out in good condition. I sent for one more, and it, too, came in bad condition, with only a few bees. I put the cage in a colony that had been queenless for two weeks, and the queen died; the bees did

The "Premium": A Good Watch Mailed Free!

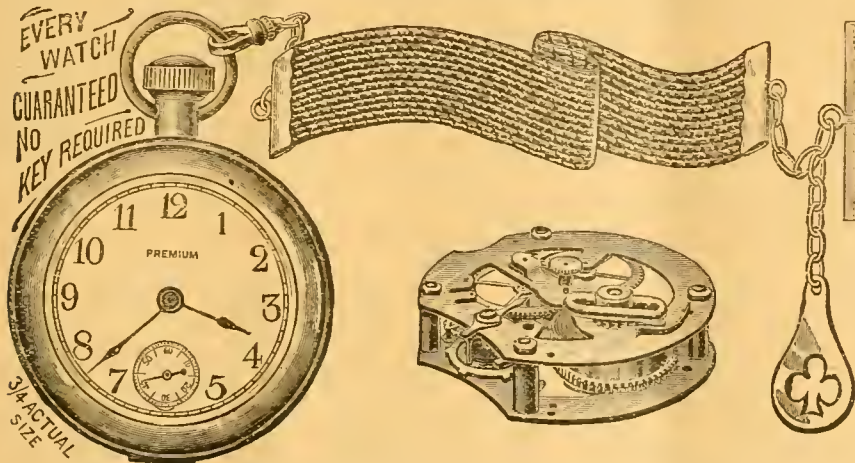

The movement of this Watch is regular American lever, lantern pinion, quick train, 240 beats per minute, three-quarter plate, short wind; runs 30 hours to one winding; dust cap over movement; every movement fully timed; regulated and guaranteed for one year, the same as a Waltham or Elgin; nickel finish, heavy bevel crystal, and back pinion wind and set.

OUR OFFERS:—We will mail the above Watch for \$1.25; or club it with the Bee Journal for a year—both together for \$2.10; or we will send it free as a premium for getting Three New yearly Subscribers to the Bee Journal at \$1.00 each. The Watch is mailed from New York City, so please allow a few days before expecting your order to be filled.

GEORGE W. YORK & CO., 118 Michigan St., Chicago, Ill.

not eat her out. Then they had to go without a queen another week. I said nothing to the dealer this time, but sent to Illinois for one, and that dealer sent me a fine queen, with lots of bees, and she came out all right. I had one more colony to Italianize, and of course I sent to Illinois again, and she came just the same as my Ohio queens. I honestly believe that there were not five bees in the cage, and one of them was dead. If that queen would have had to come a long distance, she no doubt would have been dead before she could have been introduced, but it was only chance that I got her safely. She was as fine a queen as I ever saw.

I don't want to cause any argument about queen-shiping, but I do want to say right here, that if the dealers would put more young bees with the queen, that there would be less dissatisfaction on the part of those buying queens, be money in the dealers' pockets, and save lots of vexation. When we have a queenless colony, we don't want to wait a month or six weeks to get a queen. I would rather pay a little more and get my queens introduced at the first attempt.

M. W. BEIGHTS.

Buena Vista Co., Iowa.

Not a Flattering Report.

My report for 1896 is decidedly poor. I had 6 colonies, spring count, which I increased by natural swarming to 12, and reduced by doubling up to 8. I took off 25 pounds of comb honey and fed 75 pounds of sugar for wintering.

Forest Co., Pa.

J. W. HENRY.

A Poor Year for Bees.

This has been a poor year for beekeepers in this locality. We had 18 colonies, spring count, only increased one, and took only 400 pounds of comb and 200 pounds of extracted honey. It was too dry and cold in the first of the season.

Watrous, N. Mex.

T. R. JONES.

Dr. Gallup's Medical Views.

That article on "Doctoring," from Dr. E. Gallup, in your esteemed Bee Journal of Oct. 8, having quite interested me, I corresponded with the Doctor regarding it, and will give some of his views.

In reply to the question, "What kind of diet would you commend?" Dr. G. writes:

"I have eaten no meat of any description for years. I am a Hindoo in that respect, and they are as healthy as any people in the world. They believe it to be a great sin for man to eat, or live on, anything wherein you have to destroy life, whether fish, flesh or fowl, and I know that I am as healthy, and more so than the majority of people at my age. I am strong and robust, have not an ache or pain about me, am as limber and active as a young man, have none of the stiffness or soreness of the joints complained of by almost every one."

Of the "Salisbury treatment," which is so highly recommended by the editors of Gleanings, Dr. G. has this to say:

"That Salisbury treatment is reasoning from a false standpoint; in fact, A. I. Root reasons from false premises entirely. There are certain conditions of the stomach when I recommend rinsing



is much better than going for the doctor, and is quite as effective and costs less money. You need always at hand a safe, sure remedy like



which will bring instant relief from sudden illness and work out a permanent cure.

A POSITIVE CURE FOR
BRIGHTS DISEASE
URINARY TROUBLES
FEMALE COMPLAINTS
GENERAL DEBILITY
AND MALARIA.

Cures also, all those diseases arising from disordered Kidneys or Liver—Large sized bottle or new style smaller bottle at your nearest store. Try it and know the satisfaction of such a remedy.

Mention the American Bee Journal.

CARLOADS



Of Bee-Hives, Sections, Shipping-Cases, Comb Foundation, and Everything used in the Bee-Industry.

I want the name and address of every Bee-Keeper in America. No reason why you cannot do business with me. I have Cheap Lumber and Experienced Workmen; a good Water-Power Factory and know how to run it. I am supplying Dealers as well as consumers. Why not you? Send for Catalogues, Quotations, etc. W. H. PUTNAM, 1E RIVER FALLS, Pierce Co., Wis.

Mention the American Bee Journal.

DO NOT ORDER UNTIL YOU HAVE WRITTEN US FOR PRICES ON

The "Boss" One-Piece Section



Also D. T. Hives, Shipping-Crates and Other Supplies.

We have completed a large addition to our Factory, which doubles our floor room; we are therefore in better shape than ever to fill orders on short notice. Send for Price-List

J. FORNCROOK,

WATERTOWN, Jeff. Co., WIS., Jan. 1st, 1896.



NEW MAMMOTH

Poultry Guide for 1897.

Something entirely new—almost 100 pages; contains lithograph plate of Fowls in natural colors; plans for poultry houses, remedies and recipes for all diseases; how to make Poultry and Gardening pay; only 15 cents. John Bauscher, Jr., Box 94 Freeport, Ill.

49A13t Mention the American Bee Journal.

out the stomach with as hot water as one can conveniently use, but not to be continued, by any means. So also, under certain contingencies, I rinse out the colon with hot water, but for piles I use cold water. It is a great relief, but that is only for temporary purposes."

Asked to which "school" he belonged, Dr. G. remarks:

"I do not belong to any medical school. Mine is a method that I have practiced with success for years. Scientific 'massage' comes the nearest to it of almost any treatment known, yet in many respects I have made advancement. I also make use of the Swedish movement cure, also mix hydropathic treatment in fevers; have made advancement on that also. Dr. E. H. Dewey, of Meadville, Pa., has published a book—in fact, two books—that are right in line with my treatment. He is a reformed allopath, condemns medicine as strongly as I do, only he thinks he must use morphine yet, which I do not approve, for various reasons; one is, that the cause of pain can usually be removed just as soon as it can be benumbed or deadened by the use of morphine; another reason is, it lessens the vitality, which I know is not right. My belief is to rouse or strengthen the vital principle and help Nature to throw off the morbid or disease-producing cause. Send \$3.00 to the Henry Bill Publishing Co., 56 Shetucket St., Norwich, Conn., and get Dr. Dewey's two books. The one is entitled, 'The True Science of Living, or The New Gospel of Health.' The other is, 'A New Era for Women, or Health Without Medicine.' If one lives on the plan laid down by Dr. Dewey, one cannot become sick. All sickness is certainly avoidable, as I positively know by actual demonstration. Then there is a new school started up, called 'Osteopathy,' that is right in my line of treatment. There is a college at Kirksville, Mo., by a Dr. Still; he is performing wonderful cures without medicine." TRUTH-SEEKER.

A Tennessee Report.

I had 14 colonies last fall, and 14 in the spring. I had 10 swarms, and doubled them so I now have 17 strong colonies for winter. I got about 250 sections of honey the past season—more than all of my neighbors got. Honey is slow sale here. If times do not get better we will have to give up the bees.

J. W. HOLDER.

Hebbertsburg, Tenn.

"Old Woman's Bustle" Plant.

I noticed on page 741, under "Planting for Honey," the question arose as to what plant would furnish the bees nectar in August and September. I have a shrub that grows from five to eight feet high, that fills the bill in northern Pennsylvania. It blossoms in large clusters from August till the frost comes, and it would surprise any one to see the bees working on its flowers. One who was born in Scotland, who resides in one of the villages in our anthracite coal region, made a visit to his native land, and being struck with the great fragrance and beauty of the flower he saw growing on a shrub, he concluded to bring a few to his adopted home in America. The writer being a lover of bees and keeping a small apiary at this place, was in a

friend's garden and saw one of these shrubs in bloom, and seeing the bees working so zealously on it, I at once started in with a few shrubs. I have them growing in the pasture, and cattle will not disturb them when one year old. They grow rapidly, and will bloom when a year old. I cannot give you the botanical name, but we call it the "Old Woman's Bustle." It has wonderful roots, and I think it would withstand drouth well, and will grow almost anywhere.

LUTHER BRYANT.

Wayne Co., Pa.

Waiting for a Honey-Crop.

I don't see how the people in the East can have the heart to wait two or three years for a honey crop, like the Dadants and Dr. Miller. In this neighborhood we have had a good season alternating with a bad one for several seasons, and we get awfully "blue" before the good seasons come again. I don't know what would become of the bees if we should have two bad seasons together. I wish that an exchange or something would make prices better. Papa thinks if there was a national exchange that would be better.

We could not do without the American Bee Journal; it gets here every Monday without fail.

AMATEUR.

San Diego Co., Calif.

Two Seasons' Experience.

I commenced bee-keeping with one colony of Italians in the spring of 1895, increased to five the same year, and got 130 pounds of surplus honey. I wintered them on the summer stands. To pack for winter I drive six stakes, two on each side and two at the back of the hive eight inches from the hive, then take sod three feet long and 14 inches wide, set up edgewise two sods high, and pack between the sod and the hive with chaff. I put an armful of coarse hay over all, with hangers to keep it on.

I commenced last spring with five colonies, increased to nine by dividing, and had three natural swarms. I got 900 pounds of extracted and 200 completed sections. I have packed the 12 colonies the same as last winter, and leave the packing around the hive until settled warm weather in the spring, as I think that keeping the sun from the hive is a great advantage in spring, and for the same purpose on sunny days in winter.

I don't want any Apis dorsata, but I want to keep informed by having the valuable American Bee Journal.

THOS. S. PRATT.

Wheeler Co., Nebr.

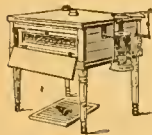

SAUMENIG! HATCHERS are made on best lines and of best material known to incubator art. They cannot fail. **HEATS WITH HOT WATER!** Hatches every egg that can be hatched. Send 2 stamps for catalogue No. 59 INVINCIBLE HATCHER COMPANY, SPRINGFIELD, OHIO.

Mention the American Bee Journal.

WANT TO SUCCEED?

Then use the **NEW STYLE SUCCESSFUL INCUBATORS.** They succeed where others fail. This due to their new system of ventilation; new method of generating moisture; and the positive action of the new self regulator. Bold under positive guaranty. All about these and other things for poultrymen in our new catalogue and Book on Poultry. Sent for 6cts in stamps. Address, **DES MOINES INC. CO.** Box 78 **DES MOINES, IA.**

49E8t Mention the American Bee Journal.

40,000.

THE Nebraska Farmer

Has made a contract with the Nebraska Club, to print for them **40,000** copies over and above the regular weekly issue, each month for six months, of reliable information about Nebraska.

If interested, send for free copy, to
MR. CHAS. E. WILLIAMSON,
 Secretary Nebraska Club,
 OMAHA, NEBR., or

Nebraska Farmer Co.
 Lincoln, Nebr.

44A13 Mention the American Bee Journal.

Cash PAID FOR Beeswax

For all the **Good, Pure Yellow Beeswax** delivered to our office till further notice, we will pay 24 cents per pound, **CASH**; or 27 cents for whatever part is exchanged for the Bee Journal, Honey, Books or Seed, that we offer. If you want **cash, promptly**, for your Beeswax, send it on at once. Impure wax not taken at any price. Address as follows, very plainly,

GEO. W. YORK & CO.
 118 Michigan st., CHICAGO, ILL.

YOUR BEESWAX!

UNTIL FURTHER NOTICE, we will allow 27 cents per pound for Good Yellow Beeswax, delivered at our office—in exchange for Subscription to the BEE JOURNAL, for Books, or anything that we offer for sale in the BEE JOURNAL. **Or, 24 cts. cash.**

GEORGE W. YORK & CO.,
 CHICAGO, ILLS

IF YOU WANT THE BEE-BOOK

That covers the whole Apicultural Field more completely than any other published, send \$1.25 to Prof. A. J. Cook, Claremont, Calif., for his

Bee-Keeper's Guide.

Liberal Discounts to the Trade.

Mention the American Bee Journal.

The RURAL CALIFORNIAN

Tells all about Bees in California.

The Yields and Price of Honey; the Pasturage and Nectar-Producing Plants; the Bee-Ranches and how they are conducted. In fact the entire field is fully covered by and expert bee-man. Besides this, the paper also tells you all about California Agriculture and Horticulture. \$1.50 per Year; Six Months, 75 cents. Sample Free.

THE RURAL CALIFORNIAN,
 218 N. Main St., - LOS ANGELES, CALIF.
 Mention the American Bee Journal

THROAT AND LUNG DISEASES,
DR. PEIRO, Specialist
 Offices: 1019, 1021 State St.,
 CHICAGO. Hours 9 to 4.

LIGHT YOUR HOME with one of these elegant lamps with club orders for our **STANDARD TEAS, COFFEES, SPICES, ETC.** If you don't need a lamp you may want a **SET OF DISHES, EASY CHAIR, CLOCK, WATCH, SILVERWARE, ONYX TOP TABLE, BICYCLE, ALBUM, Etc.** These can be had from any one of our 93 stores. Quality of all goods unsurpassed, prices lower than your home store. Write for our plan and catalogue.

206 WEST STATE ST.,
GRAND UNION TEA CO., ROCKFORD, ILL.

Mention the American Bee Journal

40E13t

California

If you care to know of its Fruits, Flowers Climate or Resources, send for a Sample Copy of California's Favorite Paper—

The Pacific Rural Press

The leading Horticultural and Agricultural paper of the Pacific Coast. Published weekly, handsomely illustrated, \$2.00 per annum. Sample Copy Free.

PACIFIC RURAL PRESS,
 220 Market St., - SAN FRANCISCO, CAL.

MUTH'S HONEY EXTRACTOR PERFECTION Cold-Blast Smokers,

Square Glass Honey Jars, Etc.

For Circulars, apply to **CHAS. F. MUTH & SON,** Cor. Freeman & Central Aves., Cincinnati, O. Send 10c for Practical Hints to Bee-Keepers.

Mention the American Bee Journal.

COMB FOUNDATION

Wax always wanted for Cash or in Exchange for Fdn. or other Supplies. My trade is established on **Low Prices** and the merit of my **Foundation.** Orders filled promptly.

WORKING WAX INTO FDN. BY THE LB. A SPECIALTY. Wholesale prices to dealers and large consumers. Send for Prices and Samples to—**GUS DITTMER, AUGUSTA, WIS.**

Reference—Augusta Bank, 1Atf

Mention the American Bee Journal.

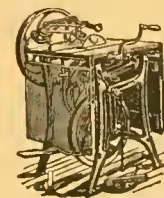

ONE MAN WITH THE UNION COMBINATION SAW

Can do the work of four men using hand tools, in Ripping, Cutting-off, Mitring, Rabbering, Grooving, Gaining, Dadoing, Edging-up, Jointing Stuff, etc. Full Line of Foot and Hand Power Machinery Sold on Trial. Catalogue Free.

SENECA FALLS MFG. CO.,
 46 Water St., SENECA FALLS, N. Y.
 1A1y Mention the American Bee Journal.

Convention Notices

CANADA.—You are particularly requested to attend the annual meeting of the Ontario Bee-Keepers' Association, which will be held in the Toronto City Council Chamber, Dec. 8, 9 and 10, 1896, the first session being held on the 8th, at 2 p.m. There will be a number of good papers prepared by prominent bee-keepers, but there will be more time given to answering and discussing questions than usual. Arrangements have been made with the Grand Trunk and Canadian Pacific Railway for the usual reduced rates to members and delegates attending the convention. The arrangements are as follows: At your starting point you will get a delegate's certificate from the agent. You purchase a full-fare single ticket, which the agent certifies to on the certificate, and if there are 50 or more persons attend the convention, holding certificates, the return fare will be one-third, but if less than 50, the return will be two-thirds single fare. By attending certificates, it may mean quite a saving to private parties, as well as the Association. There has also been an extra liberal rate given at the Palmer House of \$1.25 per day, or by doubling, \$1.00 per day. The regular rate is \$2.00 and upwards. This hotel is very convenient to the hall, as well as railways and street cars, and is very central to all parts of the city. It is expected that the Dominion and Provincial Ministers of Agriculture will be present some time during the convention. All persons interested in bee-culture are cordially invited to attend.

W. COUSE, Sec
Streetsville, Ont.

Poultry and Flowers.—Those of our readers who wish a handsomely illustrated book telling all about how to raise poultry on either a large or small scale, for profit or pleasure, and which contains formulas for building poultry houses, together with tested remedies for all poultry diseases, should send 15 cents to John Bauscher, Jr., of Freeport, Ill., who will mail it to them, postage paid. This book also tells all about the kitchen and flower garden, and is illustrated with lithographic cuts of fowls in their natural coloring. Mr. Bauscher's advertisement will be found on another page of this paper.

Barnes' Foot-Power Machinery.



Read what J. I. PARENT, of CHARLTON, N. Y., says:—"I cut with one of your Combined Machines, last winter 100 chaff hives with 7-in. cap 100 honey-racks, 500 broad frames, 2,000 honey-boxes and a great deal of other work. This winter we have double the amount of beehives, etc., to make and we expect to do it with this saw. It will do all you say it will." Catalogue and Price-List

Free, 45c. Address, W. F. & JOHN BARNES, No. 985 Ruby St. Rockford, Ill.

Our Prices ARE WORTH LOOKING AT!

— IN THE —
NEW CHAMPION CHAFF HIVE
especially. All other Supplies accordingly. Send for Catalogue and Price-List. Address,
R. H. SCHMIDT & CO.,
48 Atf Box 187, SHEBOYGAN, WIS.
Mention the American Bee Journal.

—WRITE—

Without **Cost**—enclosing a list of Supplies want and get our prices on them, before placing your order.

5 to 10 per ct. Discount till Jan. 1st.
I. J. STRINGHAM,
105 Park Place. NEW YORK, N. Y.
APIARY—Glen Cove, L. I.
Mention the American Bee Journal.

HATCH Chickens BY STEAM—
with the **MUEHL**
EXCELSIOR Incubator
Simple, Perfect, Self-Regulating. Thousands in successful operation. **Lowest priced Best-class Hatcher made.**
Send 5c. for **FREE** CATALOGUE.
114 to 122 S. 6th St. Quincy, Ill.

44A26t Mention the American Bee Journal

BEE-BOOKS

SENT POSTPAID BY

George W. York & Co.,
Chicago, Ills.

Bees and Honey, or Management of an Apiary for Pleasure and Profit, by Thomas G. Newman.—This edition has been largely re-written, thoroughly revised, and is "fully up with the times" in all the improvements and inventions in this rapidly-developing pursuit, and presents to the apiarist with everything that can aid in the successful management of an apiary, and at the same time produce the most honey in an attractive condition. It contains 250 pages, and 245 illustrations—is beautifully printed in the highest style of the art, and bound in cloth, gold-lettered. Price, \$1.00.

Langstroth on the Honey-Bee, revised by Dadant.—This classic in bee-culture has been entirely re-written, and is fully illustrated. It treats of everything relating to bees and bee-keeping. No apiarist's library is complete without this standard work by Rev. L. L. Langstroth—the Father of American Bee-Culture. It has 520 pages; bound in cloth.

Price, postpaid, \$1.25.

Bee-Keepers' Guide, or Manual of the Apiary, by Prof. A. J. Cook, of the Michigan Agricultural College.—This book is not only instructive and helpful as a guide in bee-keeping, but is interesting and thoroughly practical and scientific. It contains a full delineation of the anatomy and physiology of bees. 460 pages; bound in cloth and fully illustrated.

Price, postpaid, \$1.25.

Scientific Queen-Rearing, as Practically Applied, by G. M. Doolittle.—A method by which the very best of Queen-Bees are reared in perfect accord with Nature's way. 176 pages, bound in cloth, and illustrated. Price, \$1.00.

A B C of Bee-Culture, by A. I. Root.—A cyclopaedia of 400 pages, describing everything pertaining to the care of the honey-bees. It contains 300 engravings. It was written especially for beginners. Bound in cloth. Price, \$1.25.

Advanced Bee-Culture, Its Methods and Management, by W. Z. Hutcheson.—The author of this work is too well known to need further description of his book. He is a practical and entertaining writer. You should read his book. 90 pages, bound in paper, and illustrated. Price, 50 cts.

National Bee-Keeping, by Dr. John Dzierzon.—This is a translation of his latest German book on bee-culture. It has 350 pages; bound in cloth, \$1.25; in paper covers, \$1.00.

Bienen-Kultur, by Thomas G. Newman.—This is a German translation of the principle portion of the book called **BEES OF HONEY**. 10 page pamphlet. Price, 40 cents.

Convention Hand-Book, for Bee-Keepers. Thomas G. Newman.—It contains the parliamentary law and rules of order for Bee-Conventions—also Constitution and By-Laws, with subjects for discussion, etc. Cloth, gold-lettered. Price, 25 cts.

Thirty Years Among the Bees, by Henry Alley.—Gives the results of over a quarter-century's experience in rearing queen-bees. Very latest work of the kind. Nearly 100 pages. Price, 50c.

Why Eat Honey?—This Leaflet is intended for FREE distribution, to create a Local Market. 100 copies, by mail, 30 cts.; 500 for \$1.25; 1000, \$2.00.

How to Keep Honey and preserve its richness and flavor. Price same as Why Eat Honey.

Alsike Clover Leaflet.—Full directions for growing. 50 for 25 cts.; 100 for 40 cts.; 200, 70c.

Apiary Register, by Thos. G. Newman.—Devotes two pages to a colony. Leather binding. Price, for 50 colonies, \$1.00; for 100 colonies, \$1.25.

Preparation of Honey for the Market, including the production and care of comb and extracted honey. A chapter from **BEES AND HONEY**. Price, 10 cents.

Bee-Pasturage a Necessity.—This book suggests what and how to plant. It is a chapter from **BEES AND HONEY**. Price, 10 cents.

The Hive and Use, by G. M. Doolittle. It details his management of bees, and methods of producing comb honey. Price, 5 cents.

Dr. Howard's Book on Foul Brood.—Gives the McEvoy Treatment and reviews the experiments of others. Price, 25 cts.

Dictionary of Apiculture, by Prof. John Phil. Gives the correct meaning of nearly 500 apicultural terms. Price, 50 cts.

Winter Problem in Bee-Keeping, by G. R. Pierce. Result of 25 years' experience. 50 cts.

Handling Bees, by Chas. Dadant & Son.—A Chapter from Langstroth Revised. Price, 8 cts.

Foul Brood Treatment, by Prof. F. R. Cheshire.—Its Cause and Prevention. Price, 10 cts.

Foul Brood, by A. R. Kohnke.—Origin, Development and Cure. Price, 25 cts.

History of Bee-Associations, and Brief Reports of the first 20 conventions. Price, 15 cts.

Honey as Food and Medicine, by T. G. Newman.—A 32-page pamphlet: just the thing to create a demand for honey at home. Should be scattered freely. Contains recipes for Honey-Cakes, Cookies, Puddings, Foam, Wines, and uses of honey for medicine.

Prices, prepaid—Single copy, 5 cts.; 10 copies, 35 cts.; 50 for \$1.50; 100 for \$2.50; 250 for \$5.50; 500 for \$10.00; or 1000 for \$15.00.

When 250 or more are ordered, we will print the bee-keeper's card (free of cost) on the front cover page.

Bee-Keeping for Profit, by Dr. G. L. Tinker.—Revised and enlarged. It details the author's "new system, or how to get the largest yields of comb or extracted honey." 80 p.; illustrated, 25c.

Emerson Hinders, made especially for the BEE JOURNAL, are convenient for preserving each number as fast as received. Not mailable to Canada. Price, 75 cts.

Commercial Calculator, by C. Ropp.—A ready Calculator, Business Arithmetic and Account-Book combined in one. Every farmer and business man should have it. No. 1, bound in water proof leather, calf finish. Price, 40 cts. No. 2, in fine artificial leather, with pocket, alliciate slate, and account-book. Price, 60 cts.

Green's Four Books, by Chas. A. Green.—Devoted to, 1st, How We Made the Old Farm Pay; 2nd, Peach Culture; 3rd, How to Propagate Fruit-Plants, Vines and Trees; 4th, General Fruit Instructer. Nearly 120 pages. Fully illustrated. 25 cts.

Green's Six Books on Fruit-Culture, by Chas. A. Green.—Devoted 1st, to Apple and Pear Culture; 2nd, Plum and Cherry Culture; 3rd, Raspberry and Blackberry Culture; 4th, Grape Culture; 5th, Strawberry Culture. 129 pp.; illustrated. 25 cts.

Garden and Orchard, by Chas. A. Green.—Gives full instructions in Thinning and Marketing Fruits; Pruning, Planting and Cultivating; Spraying, Evaporation, Cold Storage, Etc. 94 pages, illustrated. Price, 25 cts.

Kendall's Horse-Book.—35 pictures, showing positions of sick horses, and treats on all their diseases. English or German. Price, 25 cts.

Silo and Silage, by Prof. A. J. Cook.—It gives the method in operation at the Michigan Agricultural College. Price, 25 cts.

Lumber and Log-Book.—Gives measurements of lumber, logs, planks; wages, etc. 25c.

Maple Sugar and the Sugar Bush, by Prof. A. J. Cook.—Full instructions. Price, 35 cts.

Grain Tables, for casting up the price of grain, produce, hay, etc. Price, 25 cts.

Capons and Caponizing, by Dr. Sawyer, Fanny Field, and others.—Illustrated. All about caponizing fowls, and thus how to make the most money in poultry-raising. 64 pages. Price, 30 cts.

Our Poultry Doctor, or Health in the Poultry Yard and How to Cure Sick Fowls, by Fanny Field.—Everything about Poultry Diseases and their Cure. 64 pages. Price, 30 cts.

Poultry for Market and Poultry for Profit, by Fanny Field.—Tells everything about the Poultry Business. 64 pages. Price, 25 cts.

Turkeys for Market and Turkeys for Profit, by Fanny Field.—All about Turkey-Raising. 64 pages. Price, 25 cts.

Rural Life.—Bees, Poultry, Fruits, Vegetables, and Household Matters. 100 pages. 25 cts.

Potato Culture, by T. B. Terry.—It tells how to grow them profitably. Price, 40 cts.

Hand-Book of Health, by Dr. Foote.—Hints about eating, drinking, etc. Price, 25 cts.

Bee-Keepers' Directory, by H. Alley.—Latest methods in Queen-Rearing, etc. Price, 50c.

Book Clubbing Offers.

(Read Carefully.)

The following clubbing prices include the American Bee Journal one year with each book named. Remember, that only one book can be taken in each case with the Bee Journal a year at the prices named. If more books are wanted, see postpaid prices given with

the description of the books on this page following is the clubbing-list:

1. Langstroth on the Honey-Bee.....	\$2.00
2. A B C of Bee-Culture.....	2.00
3. Bee-Keeper's Guide.....	1.75
4. Bees and Honey [Cloth bound].....	1.65
5. Scientific Queen-Rearing.....	1.75
6. Dr. Howard's Fowl Brood Book.....	1.10
7. Advanced Bee-Culture.....	1.30
9. Blenen-Kultur [German].....	1.25
10. Rational Bee-Keeping [Cloth bound].....	2.00
11. Rational Bee-Keeping [Paper bound].....	1.75
12. Thirty Years Among the Bees.....	1.30
13. Bee-Keeping for Profit.....	1.15
14. Convention Hand Book.....	1.15
15. Poultry for Market and Profit.....	1.10
16. Turkeys for Market and Profit.....	1.10
17. Capons and Caponizing.....	1.10
18. Our Poultry Doctor.....	1.10
19. Green's Four Books.....	1.15
20. Garden and Orchard.....	1.15
21. Rural Life.....	1.10
24. Emerson Binder for the Bee Journal.....	1.60
25. Commercial Calculator, No. 1.....	1.25
26. Commercial Calculator, No. 2.....	1.40
27. Kendall's Horse-Book.....	1.10
30. Potato Culture.....	1.20
32. Hand-Book of Health.....	1.10
33. Dictionary of Apiculture.....	1.35
34. Maple Sugar and the Sugar Bush.....	1.20
35. Silo and Silage.....	1.10
36. Winter Problem in Bee-Keeping.....	1.30
37. Apary Register (for 50 colonies).....	1.75
38. Apary Register (for 100 colonies).....	2.00
39. Bee-Keeper's Directory.....	1.30

Question-Box.

In the multitude of counsellors there is safety.—Prov. 11-14.

Using Unfinished Sections Again.

Query 36.—Will unfinished sections of full depth, when filled with honey the second time, and capped over, make first-class comb honey?—OHIO.

- J. A. Green—No.
- R. L. Taylor—No.
- Eugene Secor—Yes.
- H. D. Cutting—Yes.
- Prof. A. J. Cook—Yes.
- Mrs. L. Harrison—No.
- Rev. E. T. Abbott—No.
- W. G. Larrabee—Yes, if the comb is cut down.
- Chas. Dadant & Son—Not so good as the freshly built.
- J. M. Hambaugh—The comb, I believe, is never so crisp and tender.
- A. F. Brown—No, not unless you reduce the depth of cells to ¼ or ⅓ inch.
- J. E. Pond—No, not in my apiary. It will make a fair class of honey, though, as a rule.
- Dr. A. B. Mason—Not if they are kept over till the next season, before being filled the second time.
- E. France—No. They may look well, but when you come to use them you will find they are not first-class.
- Dr. C. C. Miller—That depends. If cleaned out in the summer or fall, and by the bees, they're all right; otherwise not.
- G. M. Doolittle—I prefer to reduce the depth of cells by shaving down, or with a comb leveler, when such sections will give first-class honey in every respect.
- C. H. Dibbern—No. Honey filled in such combs is never so white as when newly built. Another peculiarity is that the honey is apt to sour and bulge out the cappings, causing it to leak.
- Dr. J. P. H. Brown—According to my observation, the comb will not be first-class, but they are of great help when alternated with unfilled sections, to get the bees to start work in the supers.
- G. W. Demaree—It depends upon the honey-flow and state of the weather as

to whether they will or will not. If the nectar is gathered rapidly the full-depth combs will be filled and sealed before the nectar has time to evaporate to standard thickness, and the surface of the combs will have a watery appearance. I use a hot plate of tin to reduce the depth of the cells.

Rev. M. Mahin—If the cells are full depth the comb honey will not be strictly first-class in appearance. If the cells are shortened a little, and the combs have been kept perfectly clean, the honey will pass as first-class.

HONEY and BEESWAX

MARKET QUOTATIONS.

The following rules for grading honey were adopted by the North American Bee-Keeper's Association, and, so far as possible, quotations are made according to these rules:

FANCY.—All sections to be well filled; combs straight, of even thickness, and firmly attached to all four sides; both wood and comb unsoiled by travel-stain, or otherwise; all the cells sealed except the row of cells next the wood.

No. 1.—All sections well filled, but combs uneven or crooked, detached at the bottom, or with but few cells unsealed; both wood and comb unsoiled by travel-stain or otherwise.

In addition to this the honey is to be classified according to color, using the terms white, amber and dark. That is, there will be "fancy white," "No. 1 dark," etc.

Chicago, Ill., Nov. 18.—Fancy white, 12@13c.; No. 1, 10@11c.; fancy amber, 9@10c.; No. 1, 7@8c.; fancy dark, 9c.; No. 1, 7@8c. Extracted, white, 5@7c.; amber, 5@6c.; dark, 4½c. Beeswax, 26@27c.

Comb honey is selling very slowly.

Philadelphia, Pa., Nov. 7.—Fancy white comb, 13-14c.; No. 1 white, 11-12c.; fancy amber, 10-11c.; dark, 8-9c. Extracted, white, 6-8c.; amber, 4-5c.; dark, 3-4c. Beeswax, 26c.

Comb honey arriving freely and market overstocked at present.

Detroit, Mich., Nov. 7.—No. 1 white, 12-12½c.; fancy amber, 10-11c.; No. 1 amber, 9-10c.; fancy dark, 8-9c. Extracted, white, 5½-6c.; amber, 5-5½c.; dark, 4-5c. Beeswax, 24-25c.

Indianapolis, Ind., Nov. 7.—Fancy white, 11-15c.; No. 1 white, 12-13c. Extracted, white, 6-7c. Beeswax, 22-25c.

Demand is fair for grades quoted, but no demand for inferior grades.

New York, N. Y., Nov. 7.—Fancy white, 12c.; off grades, 10@11c.; buckwheat, 8@9c. No change in extracted. Beeswax firm at 26@27c.

The market is well supplied with comb honey of all grades and styles. Fancy white is in fair demand, white off grades white and buckwheat are moving off rather slowly.

Albany, N. Y., Nov. 7.—Fancy white, 12-13c.; No. 1, 11-12c.; fancy amber, 9-10c.; No. 1 dark, 8-9c. Extracted, white, 6-7c.; dark, 4-5c.

The receipts of both comb and extracted honey are very large, and prices are somewhat lower. We have an ample stock of all styles except paper cartons weighing less than a pound.

Cincinnati, Ohio, Nov. 7.—Comb honey, 10@14c., according to quality. Extracted, 3½@6c. Demand is slow for all kinds of honey, while the supply is good.

Beeswax is in good demand at 20@25c. for good to choice yellow.

Milwaukee, Wis., Nov. 7.—Fancy white, 14-15c.; No. 1, 12-13c.; No. 1 amber, 8-10c. Extracted, white, 6-7c.; amber, 5-6c.; dark, 4-5c. Beeswax, 22-24c.

New crop of honey begins to come forward. The demand is very poor and quotations almost nominal. Weather is very warm and the consumption of honey is very small. Plenty of fruit, and hence the appetite is satisfied with same in preference. Later on we expect an improved demand for honey of all kinds.

Cleveland, Ohio, Nov. 7.—Fancy white, 14½@15c.; No. 1 white, 12½@13c. Extracted, white, 6@7c.; amber, 4½@5½c. Beeswax, 22@25c.

There is not very much honey in our market. Selling rather slow. Demand beginning to be a little better. Think trade will be fair in this line this fall.

St. Louis, Mo., Nov. 9.—Fancy white, 14c.; No. 1 white, 12@13c.; fancy amber, 11@13c.; No. 1 amber, 10@10½c.; fancy dark, 9@9½c.; No. 1 dark, 7@8c. Extracted, white, in cans, 6@7c.; in barrels, 5@5½c.; amber, 4½@4¾c.; dark, 3½@4c. Beeswax, 26½@27c.

Baker stock of extracted honey, 4@5c.; stock very scarce. Fair receipts of comb. Beeswax in good demand.

San Francisco, Calif., Nov. 7.—White comb, 10c.; amber, 7½-9c. Extracted, white, 5-5½c.; light amber, 4½-5c.; amber colored and candied, 3½-4½c.; dark tulle, 2½-3c. Beeswax, fair to choice, 25-27½c.

Minneapolis, Minn., Nov. 7.—Fancy white, 12½c.; No. 1 white, 10@11c.; fancy amber, 9@10c.; No. 1 amber, 8@9c.; fancy dark, 7@8c.; No. 1 dark, 6-8c. Extracted, white, 5½@6½c.; amber, 5@5½c.; dark, 4@5c. Beeswax, 23@26c.

The demand for both comb and extracted is very quiet, and for the latter, nominal. The hot weather of the past week or so has checked demand for comb honey.

Kansas City, Mo., Nov. 7.—Fancy white comb, 15c.; No. 1 white, 13@14c.; fancy amber, 12-13c.; No. 1 amber, 11-12c.; fancy dark, 10-11c.; No. 1, 8-10c. Extracted, white, 6-6½c.; amber, 5-5½c.; dark, 4-4½c. Beeswax, 22-25c.

Buffalo, N. Y., Nov. 7.—Strictly fancy comb, 1-pound, 12-13c.; fair to good, 9-10c.; dark, 7-8c.

Demand is much better for fancy, but common stock is very dull at any price.

Boston, Mass., Nov. 6.—Fancy white, 13-14c.; No. 1, 11-12c. Extracted, white, 6-7c.; amber, 5-6c. Beeswax, 25c.

List of Honey and Beeswax Dealers.

Most of whom Quote in this Journal.

- Chicago, Ills.**
R. A. BURNETT & Co., 163 South Water Street.
- New York, N. Y.**
HILDRETH BROS. & SEIGELKEN.
- Kansas City, Mo.**
C. C. CLEMOMS & Co., 423 Walnut St.
- Buffalo, N. Y.**
BATTERSON & Co., 167 & 169 Scott St.
- Hamilton, Ills.**
CHAS. DADANT & SON.
- Philadelphia, Pa.**
WM. A. SELSER, 10 Vine St.
- Cleveland, Ohio.**
WILLIAMS BROS., 80 & 82 Broadway.
- St. Louis, Mo.**
WESTCOTT COM. CO., 213 Market St.
- Minneapolis, Minn.**
S. H. HALL & Co.
- Milwaukee, Wis.**
A. V. BISHOP & Co.
- Boston, Mass.**
E. E. BLAKE & Co., 57 Chatham Street.
- Detroit, Mich.**
M. H. HUNT, Bell Branch, Wayne Co., Mich.
- Indianapolis, Ind.**
WALTER S. POWDER, 162 Massachusetts Ave.
- Albany, N. Y.**
CHAS. McCULLOCH & Co., 380 Broadway.
- Cincinnati, Ohio.**
C. F. MUTH & SON, cor. Freeman & Central avs.

Wanted

—To buy quantity lots of Fancy and No. 1 White Honey at prices to suit the times. B. WALKER, 45A Evert, Mich.

WHEN ANSWERING THIS ADVERTISEMENT, MENTION THIS JOURNAL.

Bottom Prices

**BRING US BIG TRADE.
GOOD GOODS KEEP IT.**

If you want the best supplies that can be made at a little less cost than you can buy the same goods for elsewhere, write to us for low prices. 1896 Catalogue now ready—ask for it and a free copy of *The American Bee-Keeper* (36 pages).

Address,
**THE W. T. FALCONER MFG. CO.,
JAMESTOWN, N. Y.**

Mention the American Bee Journal.

Honey-Clovers & Buckwheat SEED FOR SALE.

We have made arrangements so that we can furnish seed of several of the Clovers and Japanese Buckwheat, by freight or express, at the following prices, cash with order:

	5lb	10lb	25lb	50lb
Alsike Clover.....	\$.70	\$1.25	\$3.00	\$ 5.75
Sweet Clover.....	.65	1.20	2.75	5.00
White Clover.....	1.25	2.00	4.50	8.00
Alfalfa Clover.....	.65	1.10	2.70	5.00
Crimson Clover.....	.55	.90	2.00	3.50
Jap. Buckwheat....	.20	.35	.90	1.25

Prices subject to market changes.

Add 25 cents to your order, for cartage, if wanted by freight.

Your orders are solicited.

**GEORGE W. YORK & CO.,
CHICAGO, ILLS.**

BEGINNERS.

Beginners should have a copy of the *Amateur Bee-Keeper*, a 70-page book by Prof. J. W. Rouse. Price 25 cents; if sent by mail, 28c. The little book and the *Progressive Bee-Keeper* (a live, progressive 28-page monthly journal) one year, 65c. Address any first-class dealer, or

LEAHY MFG. CO., Higginsville, Mo.

When answering this advertisement, mention this journal.

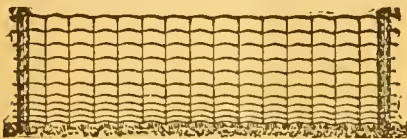

How About That Line Fence?

Would it not be well to get together and adjust the matter, and then put up a permanent Page fence. If John Bull and Venezuela had done that years ago it would have saved Uncle Sam lots of trouble. If "Schomberg" had put 19 bar Page on his line, there would have been no trespassing.

PAGE WOVEN WIRE FENCE CO., Adrian, Mich.

Mention the American Bee Journal.

Special Renewal Offers!

Prompt renewals are so desirable that I am going to make some special offers. For \$1.00 I will send the *Bee-Keepers' Review* for 1897 and the 50c. book, "Advanced Bee-Culture," or, in place of the book, 12 back Nos. of the *Review*. For \$1.50 I will send the *Review* and a fine tested Italian Queen—Queen to be sent early in the season of 1897. For \$1.75, the *Review* and a \$1.10 Bingham (Conqueror) smoker, postpaid. For \$2.50, the *Review* and 1000 No. 1, first-class, one-piece Sections. But REMEMBER, that these offers will be withdrawn Jan. 1st, as the sole object in making them is to induce the sending in of subscriptions before that date. New subscribers will get the Dec. No. free. If not acquainted with the *Review*, send for samples.

W. Z. HUTCHINSON, FLINT, MICH.

Mention the American Bee Journal.

BEESWAX WANTED

—FOR—

Foundation Making.

Send For OUR CATALOGUE,

SAMPLES OF FOUNDATION,

ADVICE TO BEGINNERS, Etc.

Address,

CHAS. DADANT & SON,

HAMILTON, ILL.

When answering this advertisement, mention this journal.

Ask Your Friends to Take This Journal.

* Extracted Honey *



Finest Quality. Basswood and Clover.
2 60-lb. cans in case, 7c. per pound. 1 60-lb. can in case, 8c. per pound. A sample by mail, 10 cts. **POUDER'S Honey-Jars and Complete Line of Supplies.** Catalogue Free.

WALTER S. POUDER,
162 Mass. Avenue. INDIANAPOLIS, IND.

PATENT WIRED COMB FOUNDATION

Has No Sag in Brood-Frames

Thin Flat-Bottom Foundation

Has No Fishbone in the Surplus Honey.

Being the cleanest is usually worked the quickest of any Foundation made

J. VAN DEUSEN & SONS,
Sole Manufacturers,
Sprout Brook Montgomery Co., N. Y.



A LARGE BOOK FREE.

To every new subscriber who sends us \$1.00, we will send him our journal—

Gleanings in Bee-Culture,

one year, and the book by A. I. Root, containing 190 pages, size 6¼x9¼, entitled

What to Do, and How to be Happy while Doing It,

postpaid. The regular price of this work is 50 cents alone.

If you prefer, the journal may be sent to a friend, and you can keep the book for yourself.

**THE A. I. ROOT COMPANY,
MEDINA, OHIO.**

AMERICAN BEE JOURNAL

DEVOTED EXCLUSIVELY TO THE INTERESTS OF HONEY-PRODUCERS

ESTABLISHED IN 1861
THE OLDEST BEE-PAPER IN AMERICA

Published Weekly, at \$1.00 per annum.

Sample Copy sent on Application.

36th Year.

CHICAGO, ILL., DECEMBER 10, 1896.

No. 50.

CONVENTION PROCEEDINGS

Proceedings of the Illinois State Bee-Keepers' Convention Held in Chicago, Nov. 18 and 19, 1896.

BY A SPECIAL REPORTER.

The Chicago meeting of the Illinois State Bee-Keepers' Association was held Nov. 18 and 19, in the pleasant club-room of the Briggs House, northeast corner of Randolph Street and Fifth Avenue. The first session began at 11 a. m., on the 18th, with Pres. Dr. C. C. Miller in the chair, and was opened with prayer by George W. York.

Pres. Dr. Miller—I am not sure whether we can do anything better for the start than to have just a short report from each one. I have been greatly surprised to find the difference in short distances. For instance, within about 20 miles, the season is quite different from what it has been with me, and we may learn something from that; at any rate, we will be interested in knowing about the results. So let one after another give a short report of the number of colonies he has, what he started with in the spring, and what the crop of honey has been. Like all the other bee-keepers' meetings we have had in Chicago, we have no program. You have slips on which to write questions for discussion, and the members are a "committee of the whole" on program, and I doubt whether there is any better way. We have always found good work come from that. We will now begin in order.

Mr. Chapman—Living in Chicago in a stone and brick locality, mainly, I think I have done very well. I had one colony which swarmed once and produced 52 pounds of white clover comb honey, but where they got it is a mystery to me. A few vacant lots near us have a little white clover, but my bees went away for a short period, about 3½ miles from our house.

Mr. Baldrige—I had 14 colonies, I think, in the spring, and 18 now; and my average was only about 60 pounds of extracted honey per colony—about half a crop. No white clover to speak of; nothing but sweet clover, and no basswood to speak of.

Dr. Miller—How is the outlook for white clover?

Mr. Baldrige—it is grand for both white and sweet clover. I never saw it better.

Mr. Kennedy—I had 25 colonies in the spring, and 40 this fall, and about 25 pounds of comb honey per colony, spring count. Part of it is white clover, perhaps some basswood, or perhaps some sweet clover. There is some basswood in my locality (Winnebago county). The outlook for white clover is good—better than it has been for a good many years with me.

Mr. McKenzie—I am from Hammond, Ind. I had 44 colonies last spring, and I increased to 80, not including deserters—five in number. Our locality is not very good. We have very little white clover. We had considerable fruit

growing, and we depend upon a crop from the fall flowers. The crop was about half what I expected it should have been. I got five times more surplus from fall flowers than from clover. I got about 1,500 pounds of honey, most of it comb, a little extracted.

Mr. West—Well, I have not as good a report to make as the others, but I suppose it is necessary to make it just the same. I have been in the bee-keeping business for some time. I think I got my first colonies in '69, although I got a few a little previous to that, but then I commenced and have had bees ever since, more or less. Last spring I had about 60 colonies, and at the present time I think I count 40, so you can see my bee-business is going down. In '91 I had 120, but since that the seasons have been very poor with us, and in the early part of the season, especially near the time of swarming, which occurred, we got very little honey. We have taken very little honey since '89. Last spring the honey was cut off. During the season I lost about 20 colonies. I thought in the first place that they had foul brood, but afterwards I concluded it must be the new disease—"pickled brood." I commenced to treat them as I would foul brood. I nearly doubled them up. I took the old frames from them, put them into new hives and new frames. I left them on the old frames one or two days (I thought that was long enough to get rid of all the old honey that was in them), and then I gave them new frames with starters. The first lot I cleaned up that way gave me good honey, and then I dropped it; and the latter part of August I cleaned up a few more, but they were too late, and one or two I lost altogether, and I had one or two that got weak, and the robbers cleaned them out. That is the



The Briggs House, Chicago, Ill.

way I lost them. I put four colonies into one, but I don't think that it was foul brood. Some of them gave off no odor at all, but not being a good judge, I took the frames to the house and had my wife and niece smell them, and they could not smell anything, so I concluded there was no smell there. I have marketed about 800 pounds of honey, making about 20 pounds to the colony.

Mr. Schrier—I took 17 colonies out last spring, sold one, and two of the 16 swarmed, and from these two I got about 24 pounds of honey. Neither of the young ones gave any honey, but are full enough for winter. The 14 averaged 75 pounds of comb honey to the colony, and the bulk of that I got in September, mostly Alsike clover. They filled the cases full

on the first crop, and then they worked on sweet clover to feed them up good until the second crop of Alsike came on, which was in bloom until frost.

Dr. Miller—What is the difference in appearance between Alsike clover honey and white clover honey?

Mr. Schrier—There is a little difference; you hold it to the light and you see a little pink in the honey, and with the sweet clover you look through it and you see a little yellow. I watched it closely, and when the bees had no Alsike clover to work on, but worked on sweet clover, then you could tell the honey looked a little yellowish. The prospect for white clover honey next year never was any better than it is now. It is growing on the roadsides as well as in the pasture. My bees are in good condition for winter, the hives full of honey and bees.

Mr. Schaper, of Indiana—I have at present 60 colonies, having had 30 in the spring, and I lost that many swarms. I got 500 pounds of extracted fall honey—no comb honey. The clover for next year looks favorable—I think better than ever before. There was none this year. The previous seasons have been so dry that the clover did not do well.

Miss Candler, of Wisconsin—I started in the spring with 52 colonies, and increased to about 86, and then I reduced back and have united until I have now just 60 colonies. I got an average of about 60 pounds of honey per colony, most of it being white clover and basswood. There wasn't very much white clover this year, though there was some. It looks very good. It has come up thick, and the plants look fine.

Dr. Miller—It seems to be the general result—the prospects seem to be good for next year.

Mr. York—You all know that I am a publisher of a weekly bee-paper, and have not very much time to devote to bees, but I can give you the result of at least one colony that I increased to four during the season, and took 150 pounds of comb honey from it and two of the increase. The honey was gathered from sweet clover almost mainly. Mr. Schrier speaks of sweet clover giving the honey a yellowish tinge. Mine is greenish instead of yellow, and I think that is the general report in this part of the country. You hold it to the light and it has quite a greenish tinge to it. My bees are very strong in numbers, and have plenty of honey for winter. I expect them to go through to spring all right.

Dr. Miller—I should like to ask Miss Candler why she increased and then doubled up?

Miss Candler—I did it because I couldn't help it. I had more than I could attend to, and so I doubled up until I had as many as I can use.

Dr. Miller—Some of the folks have questions written, will you kindly gather them up, Mr. York?

SHADE TO PREVENT SWARMING.

Ques. 1.—Will shade prevent bees from swarming?

Dr. Miller—How many of you know that you can prevent swarming by means of shade? Let me see the hands.

Not one hand was raised.

Dr. Miller—How many of you think that shade will help to prevent swarming?

Two—Mr. Baldrige and Mr. Kennedy.

Dr. Miller—Some one tell me what shade will do in the matter of swarming?

Mr. Schrier—My bees are under trees. They have sun perhaps half the time during the day, more so during the spring than summer, and I am never bothered with swarms. I had only two swarms this year. I sold one colony to a neighbor, and that colony swarmed three times. He set them right out in the sun. I had only two swarms this year, and one last year.

Dr. Miller—What is the size of your hives?

Mr. Schrier—10-frame.

Dr. Miller—So you think the main difference was the shade?

Mr. Schrier—I don't know if that was the case.

Mr. Baldrige—I don't keep my bees in the shade at all. I don't want any shade about the premises. When I want shade I make it. When I handle my bees I have a tent that I put over a hive, which furnishes me with shade, and yet I have had but four swarms out of the 14 colonies this season in the hot sun—100° in the shade, sometimes.

Dr. Miller—No covering whatever?

Mr. Baldrige—None whatever. I don't want it. I don't want a tree within five rods of my bees, of any description, except to cluster on. When I am handling my bees and have the tent, I have all the shade I want.

Dr. Miller—You want the shade for yourself, not the bees?

Mr. Baldrige—Yes.

Dr. Miller—How much is there between the top of the sections and the sun? That is, what is there over them?

Mr. Baldrige—A flat cover.

Dr. Miller—What are the sections in—is there anything between the sections and the cover?

Mr. Baldrige—I produce extracted honey, you know. I have not had my bees under shade for 10 years, I think.

Mr. West—Have you had any combs melt down in the sun? It occurred with me several times, and that is the reason I want the shade.

Mr. Baldrige—When it is extremely hot weather I cut grass and put it on top the cover to keep the sun off, but I want my bees in the sun.

Dr. Miller—I suspect that that is one of the things that we don't know about yet—the matter of shade. The general statement is made, that shade will help to prevent swarming. Now, I believe that is true just this far, that shade makes it cooler, and I believe that heat is one of the elements that helps to promote swarming. I have had combs melt down in a shade so dense that from morn until dewy eve the sun never touched the hive. Corn grew back of the apiary, the air could not get through, and the hives were in the dense shade, and it was hot in there. I think there are times when the shade would be very beneficial. Mr. Baldrige puts on grass sometimes, and I want to endorse that as a cover for bees. On a hot day when you think there is danger, go and cut some coarse grass and put it on top of the hives, and put a piece of fire wood on it, and you can have that stay there then during the season. It will dry there, and I don't know of any better covering than grass, or hay, as it would be at the last, and that protects it, and I think that is beneficial. I believe in the shade of a tree, and yet Mr. Baldrige may be right. I suppose where you have the shade of a tree, where the air can pass through, that would be a benefit to the bees. It is certainly a benefit to me when I am working at them. That is one of the things I would like to know about.

Mr. Schrier—My bees are standing right near two rows of maple trees, and I trim them up as high as possible. I have got circulation of air going there, no wind-break, and it is nice and cool where my bees stand. No melting down there.

Dr. Miller—There certainly would be less melting in the shade than in the sun. The only point is, it is heat that make them melt, no matter how you get it.

Mr. West—I would say that I have combs melt down in the sun in the old Simplicity hive, and afterwards I got the Dovetail hive. There seems to be more space above the sections and the top in the Simplicity, but with a Dovetail hive the cover comes almost on the sections, and it was these I had melt down.

Dr. Miller—The entrance is about the same in each, and the same chance for air.

Mr. West—There is more in the Simplicity.

Dr. Miller—Don't you see, it may be not only the top, but there is a chance for more at the entrance.

Mr. West—I looked at it more in the top than at the entrance, and lately I put two covers on, so as to have one protect from the sun and the other between that. In that case I have had no melting.

Dr. Miller—I suspect we have gone in the wrong direction a little bit. We used, in the old times—some of you kept bees long enough ago—to set the hives on blocks, and the opening all around, and nowadays the tendency is to have a very small entrance, so that they can get very little air. That tends to keep them hot. You shut them up tight and the combs will melt down, but if there is entrance enough, they can keep cool by ventilating. I suppose we are making a mistake in keeping our hives as close as they are. Do any of you make a practice of raising the hives in the old-fashioned way, on blocks, in the summer time?

Two hands were raised.

Dr. Miller—I have done it somewhat, and I am not sure but what I will do it more. I don't see any harm, and I can see good. It gives the bees a good chance.

Mr. West—It makes it a little more difficult for the bees to climb up on the combs.

Miss Candler—I just raise the hive in front and the sides.

Dr. Miller—Well, then, in general, the answer to the question—"Will shade prevent bees from swarming?"—I think, will likely be, that so far as it helps to keep cooler, it does help some, but shade, if it is close, won't do it.

(To be continued.)



The Utah Bee-Keepers' Convention.

BY JOHN B. FAGG.

The Utah State Bee-Keepers' Association, at their semi-annual convention recently, discussed principally methods of

securing much-needed legislation for protection against foul brood. From 30 to 40 bee-keepers from different parts of the State were present, all taking an active part in the discussions.

After hearing the Secretary's report, and the reports of the committees, Pres. Lovesy opened the discussion by pointing out that honey was being sold too cheap. Some counties were shipping honey to Salt Lake City and selling it for less than wholesale prices. Continuing, he said that a closer union of interests upon all matters pertaining to the bee-industry was one of the main things needed among our bee-keepers.

Relative to marketing our products, he said that after much agitation the railroads were more liberal than they had been, and if this policy is continued we may be able to ship our honey and compete with all parts of the country. But in spite of all other advantages, he found that some of the bee-keepers take a course that injures themselves and the bee-industry at large, by rushing their honey and wax on the market at any price, actually peddling it for less money than they could sell it for at their homes to wholesalers. There can't be any wisdom in a course of this kind.

A FOUL BROOD LAW NEEDED.

The bee-industry in Utah is sadly in need of a good foul brood law for the protection of our bee-industry, which is a growing one, and it is bringing considerable money into the State; it is all the time on the increase, and for this and other reasons it should be encouraged by our legislature, to the extent at least of protecting the bees against contagious diseases. We believe that the bee-keepers present should frame or pass upon some good measure that can be made effective, and have it presented in proper form to our next legislature.

THE FOUL BROOD LAW.

At the conclusion of the President's address, the discussion of a Bill to be introduced at the next session of the legislature was taken up. The Bill is the result of the efforts of the committee appointed on a foul brood law, and who were ably assisted by County Attorney Whittemore, of Salt Lake county. The proposed Act reads as follows:

SEC. 1.—It shall be the duty of the county commissioners of each county to appoint, from among the bee-keepers in the county, one or more suitable persons as inspector of bees, and they shall report annually every item of interest to their respective county commissioners.

SEC. 2.—The inspector shall annually report to the President or Secretary of the Utah State Bee-Keepers' Association the names of all bee-keepers and number of colonies of bees owned by each in their respective districts at the time of their inspection.

SEC. 3.—These inspectors shall be appointed biennially, viz.: 'On the first Monday in March of each alternate year, or at the first regular sitting of the court thereafter, and shall perform the duties of bee inspector for two years, and until their successors are appointed and qualified. Said inspectors shall qualify by taking and subscribing to an official oath, and giving bonds with sureties to be approved by their respective county courts.

SEC. 4.—In determining the fitness of a person to fill the position of inspector, the court shall consider the wishes of the County Bee-Keepers' Association, or, providing there is no association in the county, the petition of ten or more bee-keepers of said county endorsed by the State Bee-Keepers' Association shall be considered for such appointments.

SEC. 5.—It shall be the duty of the inspector to visit all the hives of bees in his county or district at least once a year, and at any time, upon the complaint of any bee-owner, that the disease known as "foul brood" exists among the bees of any person, whether owner or custodian; it shall be the duty of the inspector to whom the complaint is made, to immediately inspect the bees said to be thus infected; and if such inspector finds that "foul brood" does exist among such bees, said inspector shall immediately take charge and control of them and give them proper treatment for the cure of the disease, or he may destroy such portions of the bees and brood and of the hives as may be necessary.

Provided, in case the owner has any doubt about his bees being affected and objects to their being destroyed, as in this Act provided, then such fact shall be determined by arbitration, the said inspector choosing one arbitrator, the owner of the bees another, and they two a third, who shall immediately inspect such bees and determine whether or not the bees so inspected are diseased. Any bee-keeper may require the inspector to thoroughly clean his tools, or he may furnish the tools necessary, and assist the inspector in the inspection of his bees.

SEC. 6.—If any person shall, in any way, obstruct by threats of violence or in any other manner, or prohibit or prevent a duly appointed bee-inspector from inspecting, taking charge of, treating or destroying bees, as provided in this Act, the person so doing shall be guilty of a misdemeanor.

SEC. 7.—To provide for the prosecution of the duties of bee inspector under this Act, the county courts are hereby authorized to and shall appropriate out of the funds of the county the sum of three dollars (\$3.00) per day for the time the inspector is actually employed in the performance of his duties; provided, that in no case shall the compensation of the inspector exceed in any year the sum of one hundred and fifty dollars (\$150), and no extra charge shall be allowed for traveling or other expenses.

SEC. 8.—A tax of not to exceed five cents (5 cents) per colony is hereby levied each year upon every colony of bees in each of the counties of this State, and the assessor of each county is hereby required to assess to the owner thereof every colony of bees in his county in the same manner as other assessments are made. Said tax shall be collected in the same manner as is now provided by law for the collection and payment of other county taxes, and when so collected shall become a part of the funds of the county.

SEC. 9.—This Act shall take effect upon approval.

Thos. Johnson thought, as a whole, it was a good law, and should be passed.

Levi S. Heywood said a measure of this kind was extremely necessary for the benefit of the bee-industry.

Sec. Fagg said if all our bee-keepers were educated in the matter we might possibly get along, but unfortunately they are not, hence the necessity of the law.

F. Schach said the Bill was all right; it would help to unite the bee-keepers, and assist in building up the industry.

Mr. Brown wanted to know if such a law would not be class legislation; he believed bees should be assessed the same as other property.

T. B. Clark said our bees were already taxed in some counties; there was both a general and special, and yet there was little or no protection against foul brood.

S. Peterson thought it should be apparent to all that a measure of this kind is absolutely necessary, hence we should pass on the law as it is, or amend it if necessary.

Vice-Pres. Howe said as far as he was personally concerned he would prefer no inspector and no law. No inspector had been to see his bees for some time. He had 300 colonies in good condition, and would prefer to attend to them himself.

Henry Bullock thought differently; he said a bee-inspector and a good foul brood law are needed. He said if all were practical bee-keepers it might be all right, but the trouble was with the many that kept one or more colonies for their own use, and they never look at them except when they wanted honey. He said if the disease got in them with no inspector, they would injure the industry a great deal.

Pres. Lovesy defended the proposed Act. He said if he consulted his personal feelings he would not desire a law, but while it is a burden on our prominent bee-keepers, it will protect them from loss by the many that know nothing about the disease. He said that he had found bee-keepers, the present season, actually dividing foul-broody colonies, thus spreading the disease. He asked if this law, with effective protection, would not be preferable to the present tax which gave little or no protection.

After a talk by William Cornwall on the curing of foul brood, the Bill as proposed, with a few slight amendments which are embodied in the above copy, was adopted, and the meeting adjourned until 5 a.m.

At the evening session there was a long and interesting debate on the necessity of organizing a bee-keepers' exchange. Every bee-keeper present recognized the necessity and desirability of something of this kind. It was finally referred to the executive committee, to report at the spring meeting.

JOHN B. FAGG, Assistant Secretary.

Honey as Food and Medicine.—A new and revised edition of this 32-page pamphlet is now issued. It has 5 blank pages on which to write or paste recipes taken from other sources. It is just what its name indicates, and should be liberally distributed among the people everywhere to create a demand for honey. It contains a number of recipes on the use of honey as food and as medicine, besides much other interesting and valuable information. Prices, postpaid, are: Single copy, 5 cts.; 25 copies 75 cts.; 50 for \$1.10; 100 for \$1.50. Better give them a trial. Send all orders to the Bee Journal office.

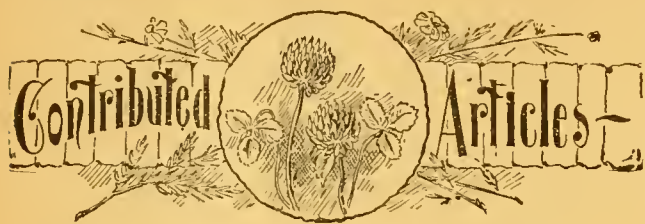

The National Bee-Keepers' Union—Adulteration—Amalgamation.

BY W. Z. HUTCHINSON.

The National Bee-Keepers' Union was created for a specific purpose—that of defending its members from unjust prosecutions by law. It fulfilled its purpose well, and has established so many precedents—some in high courts—that but few suits of this kind are now brought, or, if brought, are dropped when the record of past similar suits are laid before the interested parties. Practically, the Union's hard work in this direction is finished—was finished several years ago. It has made a record. And when that record is laid before some would-be antagonist, and he is still further informed that the Union is yet in existence, with a good sum of money in its treasury ready to be used in the defense of its members, all further thoughts of a suit are at an end. About all that the Union now has to do in this line is to furnish these records and "show its hand." So little money has been used in conducting suits for the last few years that it has been accumulating, and now amounts to several hundreds of dollars—seven hundred, I believe.

These persecutors of bee-keepers have been put under foot, so to speak; but, in the meantime, another and ten-fold greater evil has been growing, that of the adulteration of honey. So great did this become that there was strong talk of forming another Union, or society, for the specific purpose of fighting adulterators. But it was urged, and with reason, that it was foolish to start a new society for each purpose that required united action—better strengthen the Union that already existed and so change its constitution that its funds could be used for *any* purpose in the interest of bee-keeping. This was done, but, for some reason, or reasons, nothing has ever been done in the way of prosecuting adulterators. I think that the General Manager would have acted if some definite case with good proof had been brought before him, but this prosecution of adulterators is a case of "what is everybody's business is nobody's business." There is a lack of definite, personal interest in the matter. When a man is sued because some one considers his bees a nuisance, he takes some interest in the case. If some one should sneak into this man's honey-house and adulterate his honey, he would then feel like hunting up the transgressor and securing his punishment. But this same man sells his honey to a dealer, and thinks or cares very little what the dealer will do with it. There must be an intense, selfish, personal motive to induce men to act. I think it is this point that explains, or partly explains, why nothing has been done by the Union in prosecuting the adulterators of honey.

But the adulteration of honey is an injury to the bee-keeping interests. It works injury in three ways. As a rule, it impairs the quality of the honey. It increases the amount of "honey" put upon the market. It prejudices consumers against buying it; and there is no subject connected with apiculture upon which there is now so much need of united action as that of checking the adulteration of honey. In order to have the Union do anything in the line of checking adulteration, there must be some changes made either in its constitution or its management, or both. It must be made the business of *some one* to ferret out and prosecute adulterators. The bee-keepers of this country could well afford to keep a trained detective busy the year round in hunting out adulterators of honey and securing proof against them, and then in bringing them to justice. But this would be expensive, much more than the Union, as now managed, could pay. And this brings up the subject of amalgamation.

The North American Bee-Keepers' Society was organized many years ago, for the purpose of bringing together bee-keepers from different parts of the country that they might discuss subjects pertaining to the bee-keeping industry, exchanging views and experiences, and enjoying the good that comes from the friction of mind against mind; but the dissemination of knowledge through the medium of books and journals has now largely stripped these meetings of their

value. Now here are two societies that have, in a measure, outlived their usefulness. The Union has won all its suits until no one now dares to sue its members, and when the North American meets it finds but little now to talk about, as it has already been told in the journals. At the same time the honey markets are being damaged because of adulteration, and bee-keepers are doing nothing to put a stop to the practice—simply making matters worse by continually talking, but doing nothing. Since these societies were organized there has been a change of conditions, and these changes should be met by a change in the societies. There is no necessity whatever for two societies. It would seem as though this point did not require argument—that it would be patent to the simplest mind. That amalgamation, with a change of constitution to suit the times, should be proposed is one of the most logical things that ever happenad. We cannot afford to waste our time, talents and money in sustaining two societies when only one is needed. In union there is strength.

When the North American made overtures for an amalgamation, they were rejected. Of course, no vote has been taken, but the published expression of some of the members of the Union showed that they were proud, independent and scornful. Not only this, but the whole matter seemed to be misunderstood. There seemed to be a feeling that in some way the North American was planning to reap what the Union had sown—to in some manner get hold of the money that the Union had raised, and squander it. Nothing could be farther from the truth. All of the objections brought against the uniting of these two bodies have been born of prejudice or ignorance. Not a single objection has been brought that has not been answered or overcome.

Two different proposed constitutions have been gotten up by the North American to be submitted by vote to the members of the Union. The first one is my personal preference, but the second one has now been adopted by the North American, and it may be that it is better than the first one. The General Manager has criticised it quite sharply, and some of his criticisms are well taken, while others are a little far-fetched or hypercritical. If we wait until a constitution is formulated in which no flaws can be found, amalgamation will *never take place*. It will only be by actual experience that we will learn exactly what kind of a constitution is needed. Without experience it is doubtful if we get up a better one than the North American has now adopted—at least, not enough better to recompense us for the delay. *We need to get to work.*

Another feature is now coming up that needs united action, and that is the prompt exposure of dishonest and unreliable commission-men and dealers. See what bee-keepers have lost through Horrie & Co. and Wheadon & Co. Not only have the men lost who sent them honey, but this honey has been sold at almost any price in order to move it off quickly, and this has weakened prices and demoralized the market. References and mercantile reports are an aid, but they are not an absolute safeguard. Bradstreet reported Wheadon & Co. as worth from \$10,000 to \$20,000. Rogues can put money in a bank and get a rating, and then take it out again. The Union should send a man, or employ some responsible, capable man living near, to thoroughly investigate every new firm that begins bidding for the bee-keepers' honey. Before a man ships honey to a new firm, let him consult the Union, and let it be the business of the Union to *know*—as near as it is possible to know—if the firm is reliable. If a firm does not deal in an honorable manner let it be reported at once to the Union, and if the report is a true one, let the facts be published.

For instance, I have lately received from Sanford & Co., of New York City, an order for a list of names of bee-keepers. The order was on a nice letter sheet with a fine lithographic heading (that point is never neglected), and Bradstreet and Dun, as well as two banks, given as reference. Upon reference to Bradstreet and Dun it was found that the firm's name was not even *mentioned*. The banks replied that the firm had a small balance in the bank, but it was so small, and their acquaintance with the firm was so slight and short, that they did not care to say anything about their responsibility. Sanford & Co. were informed that cash in advance must be sent for the names, and that ended the matter. It is possible that this firm will do an honorable business, but the chances are that they will prove a third Horrie & Co. The Union could have a man in each of the large cities whose business it should be to look up all such cases as this, and report them.

What we need is one good, strong, enthusiastic Union or Association of bee-keepers—it matters little as to its name—with a capable, energetic manager whose heart is in the business. If bee-keepers could be assured of such, how they would rally! They would come by the thousands. I doubt if there is a reader of these lines who would not gladly send in

his dollar each year. We must stop this haggling over minor differences and go to work upon the main question. With the old societies amalgamated upon a new and desirable basis, and the right kind of a manager right on the spot ready for business, success will be assured. The journals will take up the matter and do all in their power to make it a success. As the rank and file see that the leaders mean business, they will be eager to join, and everything will go with a *go* to it.

And now comes a phase that is not exactly pleasant. Gleanings suggests that it may be necessary to elect a new Manager, as Mr. Newman is now so far from the base of operations. With the old constitution, and headquarters in Chicago, there is no question but what Mr. Newman was most decidedly the right man in the right place. It is doubtful if there is another man in the United States that could have done so well as he did. Let us not forget that. But with Mr. Newman in California it is a case of the right man in the wrong place. The great center of bee-keeping and honey dealing is in Chicago, and it is in or near Chicago that the Manager should live. He should certainly be near enough to reach Chicago quickly and cheaply.

But I have said enough. If any one thinks that the course that I have mapped out is not desirable, let him give his reasons fairly and courteously, but fearlessly, and they will be considered in the same manner. Gencsee Co., Mich.



Introducing Queens with Tobacco Smoke.

BY DR. E. GALLUP.

I have received five letters requesting me to be more comprehensive in my plan of introducing queens with tobacco smoke, etc.

I received a queen Oct. 20, just at night, too late to hunt up the queen where I was to introduce her, and I had to be away the following afternoon, and robber-bees would be on hand if I introduced in the forenoon. I am pestered constantly with black bees from somewhere, either in a tree or some building. They are evidently in a starving condition, judging by their actions. When I go out with the smoke they are on a watch for a chance for mischief, and when I open a hive they are ready to pounce in. So I cut out a strip of board the length of the width of the hive, and 2 inches wide, then cut out $\frac{3}{4}$ of an inch from one side the length of the entrance; tack on a strip of wire-netting, so that when this ventilating strip was placed over the entrance the wire would come down tight on the bottom-board, so that bees could neither get in nor out of the hive.

With a gimlet I bored a hole in each end of the strip for the nails, so I could quickly fasten it over the entrance. I cut out this notch in the strip $\frac{3}{4}$, so it would be larger and deeper, and then the bees could not choke up the entrance and smother. A wider ventilating strip for a powerful colony, so that one could cut out one or two inches to cover with the wire screen, might be advisable. But the colony that I was operating on was only in medium strength.

I went to town for tobacco stems in the evening, but the cigar-factory was closed. But in front of the hatch I picked up a pocketful of cigar-stubs. Now I was ready for business.

Early in the morning I picked the old queen out of the hive without disturbing the bees but a mere trifle; closed the hive, and tacked on the ventilator, and only had three bees on the outside. Previous to this, and before daylight, I had taken the queen out of the shipping-cage and placed her in a little round wire-cage. I cut up some of the cigar-stubs quite fine, and rolled them in a piece of cotton-cloth ready for lighting. I had my teacup of honey and a spoon on hand ready to drop the queen in when wanted.

I placed the old queen in the shipping-cage, with five or six of the workers that came with the new queen (as I was to give her to a neighbor); lighted the tobacco, placed it in the smoker, and when I had it well going I puffed about four good puffs in through the screen at the entrance in four different places, so as to have the smoke thoroughly penetrate between each comb. I waited about one minute, took the queen out of my pocket, dropped her into the teacup of honey, by holding the mouth of the cage close to the honey, then suddenly jarring with the other hand so as to have her drop into the honey without a chance to fly. I rolled her over, removed the cover of the hive, and dropped the queen and spoonful of honey into the center of the hive, replaced the cover, and placed a large blanket over the hive so as to make all dark, and so the robbers could not congregate on the outside of the ventilator.

The whole performance from the time I opened the hive to find the queen and introduce the new one, did not occupy

over 15 minutes. You must remember that cigar-stubs are very strong, therefore we must use only in proportion to the strength of the tobacco. I usually use tobacco stems. Then we have to smoke a little longer. All the bees must be stupefied. It is not necessary to smoke the queen. I roll her in the honey to prevent her from flying.

Before I left home in the afternoon I removed the blanket and the ventilator at the entrance of the hive, and the bees went to work as though nothing had happened. And I am inclined to think that the bees do not even discover that their queen has been changed, while they were on their drunk, for the fumigation makes them act very much like a drunken man, and the change is made so quickly that they have had no chance to discover the loss of their former queen. But this I do know, that I never have lost a queen by introducing with tobacco smoke, and by this last performance I have solved the problem, so that I can beat the robbers every time.

In extremely hot weather it might be advisable to place screening over a part or all of the top of the hive. Always use a little common sense, and then you are all right.

I think I have made the above so plain that the merest novice can comprehend it. It might be well enough for a novice to roll the queen in the honey inside of some room.

Orange Co., Calif.



The Importation of Apis Dorsata Encouraged.

BY PROF. A. J. COOK.

It was with much surprise that I noted the discussion at the Lincoln convention, the resolution there adopted, and the replies in a late number of the American Bee Journal as to the advisability of the importation by the United States Government of *Apis dorsata* into our country. It seems to me that there is a lack of enterprise shown in this matter by a large number who have recently spoken. I have wondered whether a prejudice against one of the employees of the Agricultural Department at Washington might not be at the foundation of this prejudice. I believe that every bee-keeper of our country would say that the early action of our Government in securing the Italian bee was a piece of undoubted wisdom. The officials of California, in conjunction with the Department of Agriculture at Washington, went to Australia and imported some little beetles, and thus secured untold benefit to our State. Such enterprises are very little likely to be undertaken by private individuals; and it seems to me that if Government is ever warranted in coming to the assistance of the people it is in just such projects as these. I have always been of the opinion that it would be excellent policy for the Government to introduce *Apis dorsata*. I have read very carefully all the comments I have seen upon this enterprise, and as yet I have seen nothing that changes my mind regarding the matter.

The late Dr. C. V. Riley came to me some years ago, at Lausing, Mich., where I was then residing, and asked me what I thought the Government could best do to further the interest of bee-keepers. The first thing I stated in answer to his question was regarding the importation of *Apis dorsata*. I told him that a good many of our people believed that we might secure valuable results if this bee were brought to our country; that the enterprise was too gigantic for individual effort; and that it seemed to me that this was just the work that the Government ought to undertake.

He next questioned me as to the method to be pursued in its accomplishment. I suggested that Frank Benton had already made an effort to secure these bees, and had almost succeeded; that he was now in Europe engaged in bee-culture, especially the rearing and shipping of queen-bees; that he had invented the most successful shipping-cage; and that if there was anything in experience and long study, he certainly must be admirably fitted for just such work. Mr. Benton was very soon employed by the Agricultural Department, where he has been working ever since. I understood from Dr. Riley that through some technical ruling, this project of the introduction of these bees was held in obedience.

In an article which I wrote on this subject for the bee-periodicals some time ago, I considered this matter very much in the same light as that presented to Dr. Riley in the conversation mentioned above. I again said that it seemed to me that Mr. Benton should be the proper man to send if any such quest was attempted. I think no one will doubt that Mr. Benton's experience should be very valuable in case any such attempt was made.

It is greatly to be regretted that since the St. Joseph North American Bee-Keepers' convention there has been a serious rupture between Mr. Benton and the leading bee-keepers of our country, which has led many of the latter to

consider him as not the proper man to be sent to India or Ceylon in case the attempt to introduce these bees should be made. I have no bias in favor of Mr. Benton that would make me feel that he was the only man to do this work. If from his temperament, or individual peculiarities, he is unfitted to carry out this enterprise, then certainly some other person should be secured. I think there are others who would do the work well; and the very work that Mr. Benton did would be a great help to any one else who might undertake the enterprise.

I feel very certain that if the bee-keepers of the country were united, and should ask the United States Department of Agriculture to introduce this bee among us, all technical difficulties would be removed, and the work would be done. I believe the Department of Agriculture wishes to do the utmost possible to benefit agriculture in all its lines, and I believe that any such large work as this would especially appeal to the broad-minded men at the head of that Department. Therefore it is that I wish further to comment upon this matter.

The objection has been raised that we might introduce another "English sparrow." I feel, myself, that there is no peril in this direction. None of the honey-gathering bees are ever in the least degree mischievous. They are always and everywhere friends. Their honey-gathering habit, and their great numbers, especially early in the season, make them par excellence the most valuable agents in cross-pollinating the flowers of our fruits and vegetables. This work has an importance that few even of bee-keepers sufficiently appreciate. If bees anywhere had any evil traits we might look askance at this enterprise, fearing that its consummation might be another of the list so disastrous to America in the importation of the English sparrow and to Australia in the importation of the rabbit. As it is, I am sure we need have no fear in this direction. This, and the possibility, very likely—we may say probability—that these bees may be of no value if brought among us, are the only objections to this enterprise that I have heard mentioned.

I wish now to present what seemed to me advantages. There are among us many enterprising men like D. A. Jones, who will constantly feel a desire that these large bees of India might be at work among us. They will constantly be feeling about for some method of doing the work. They have not, nor can they have, the facilities which the Department of Agriculture possesses. Therefore, any action that they may take will be attended with very large expense, even if it succeed at all. Therefore, in quieting this very unrest, it seems to me this undertaking on the part of the Government is most desirable. If any work should not be left to the individual, surely this work should not be.

Again, without any doubt, these bees have longer tongues than our ordinary bees, and might very likely be able, like our bumble-bees, to gather honey which is entirely inaccessible to our common honey-bee. It would certainly be a great acquisition to secure a bee, for instance, that could secure the nectar at the bottom of the deep flower-tubes of red clover. It is more than probable that many other flowers secrete nectar that cannot be reached by our common bees.

Again, these bees are not only a different variety from all our domesticated bees, but they are also a distinct species. It certainly is not up to our nineteenth century civilization to let bees of such marked characteristics pass year after year without a trial. Every great enterprise has more or less risk back of it. This is no exception to the others. While we may, perhaps, say that the probability is of no signal advantage, yet, on the other hand, there is more than possibility that its introduction among us may be attended with great advantage. The Government is all the time introducing new seeds, new plants, new domesticated animals, and I see no possible reason why we should make an exception of *Apis dorsata*, or any possible reason why bee-keepers should not benefit by Government enterprise with those engaged in other manual pursuits. Without doubt the Government could accomplish this at very slight expense, as they did the introduction of *Novius (vedalia) cardinalis* from Australia. In that enterprise, the State of California received a benefit which is almost beyond computation.

It seems to me the broad view of any such matter as this is for the Government to introduce any species or race that might offer even a slight hope of improvement. Is not this a sort of "making two blades of grass grow where only one grew before?" And I have no objection to the Government becoming just such a philanthropist. It passes understanding, to me, why any one should object to the Government undertaking such an enterprise. If the objection comes from the fact that some obnoxious individual is likely to be selected to carry it out, then I say make objections to the individual,

and not try to balk the enterprise. While I am not in favor of the Government giving money for conventions or anything else that benefits the few, I would hold up both hands to have it undertake any such project which offers even small hope of advantage, and which is beyond the means of individual effort. Especially would this be true where all the people of any great industry would certainly profit were the enterprise successful and the results valuable.

I, therefore, wish to put myself on record as commending the action of the bee-keeping society of New York State, which has been so active in trying to accomplish this object.

Claremont, Calif.



Another Reply to Mr. Newman's "Criticism" on the New Constitution.

BY "UNION."

MR. EDITOR:—Can any one in "kindness and candor" talk as Mr. Newman does on page 742? If one can, it would be a relief to me to get rid of some of my present surplus of those articles, and "with the best of intentions;" and I want to suggest to the Secretary of the United States Bee-Keepers' Union, Dr. Mason, that he make a note, or keep track of all the criticisms and suggestions that he hears of or sees in regard to the New Constitution, and have them ready at the next meeting at Buffalo, to be considered by the Union.

Perhaps I am wrong, but it looks to me as if the North American Bee-Keepers' Association has been done away with, and that the United States Bee-Keepers' Union has taken its place, so that Mr. Newman's "criticism" is not properly headed. Am I right in thinking if the National Bee-Keepers' Union does not see fit to adopt the same Constitution that the United States Bee-Keepers' Union has, that the United States Bee-Keepers' Union will go on and work under the New Constitution? and as its scope is larger, will it not gradually take the place of the old Union? As I look at it, the New Constitution provides for doing the same work as has been done (and by the same men), and more, too; and if adopted, the work will go right on without a break, or even a jar; for I can't find anything in it that will admit of any interference with the duties of the Board, as Mr. Newman states it will. I am a member of the National Bee-Keepers' Union, and have been nearly ever since it was organized, and shall vote for the adoption of the New Constitution if the General Manager condescends to get down off his "high heels" and gives us a chance to vote.

I can see nothing in the New Constitution that calls for such scathing denunciation as Mr. Newman sends forth, and of which he ought to be ashamed. Perhaps he had better move back to the "Windy City." He certainly must have overlooked some of the provisions of the Constitution, or else Dr. Mason failed to send him a complete copy, or he would not have made any of the criticisms he does in regard to Art. V., for he certainly has not made a single point, unless it be in regard to returning the ballots to "two members," but until that can be corrected it will be perfectly safe to leave its management to the Executive Committee.

Mr. Newman's criticism of Sec. 7, Art. VI. is a *very* small affair to make so much fuss about; and if the little piece of "tautology" that he finds in Art. X. offends his sense of order, it can be very easily changed; but if never changed, it wouldn't cause the expenditure of a single cent of the funds of the Union, even if it found a "loop-hole;" and all "incongruities as well as its lack of consistency and completeness," if any such exist, can be fixed up if he will just put his mind to the matter and have all in "apple pie order" for the Buffalo meeting.

If it should be submitted to a vote by the Advisory Board (and our only hope is in the Board, for the General Manager is "out of sight"), and it be adopted, I have no doubt that all its "incongruities," etc., will also soon be "out of sight." If those engaged in framing the New Constitution had not relied on, and copied so much from, the constitution of the National Bee-Keepers' Union, they certainly would not have copied its defects; but "with all its faults," it has proven a perfect success.

The simple fact that such men as Messrs. Kretschmer, Whitcomb, Secor, Stilson, A. I. and E. R. Root, Rev. Abbott, York, Drs. Miller and Mason, and more than a score of others, who, according to the report in the Bee Journal, were at Lincoln, and helped to put the Constitution in shape, and passed it unanimously, would make me think more than twice before opposing it, and I am *very* glad that I can so heartily endorse their work. Three of the Vice-Presidents of the National Bee-Keepers' Union, and also members of the Advisory Board,

were also present and helped in the good work. What a pity the General Manager wasn't there to smooth out the wrinkles of the youngster; and although I have always admired him for his disinterested and abundantly successful labors for the good of our pursuit, I am not in sympathy with him in the unwarranted and unwise course he has taken in putting his foot down and virtually telling the members of the United States Bee-Keepers Union that they don't know enough to get up a Constitution that is fit to be submitted to a vote of the old Union; and I shall not be at all surprised to see them resent his meddlesome interference. In an almost insulting manner he tells them that there is nothing left for them, and such as favor the measure, to do but to wait until all "incongruities," etc., have been so eliminated as not to grind on the sensitive General Manager; and I am wondering who will do the kind of thing for the demented (?) bee-keepers, who, at Lincoln, proved themselves to be such ninnyes at expressing their minds. Do you suppose the General Manager will attempt to perform the task?

The tone as well as the matter of Mr. Newman's "criticism" indicates to me that he proposes to stop all further proceedings towards amalgamation, and considers himself of much more importance than those who favor the measure, and while only a servant, and handling our money, usurps authority; and I believe that just the moment any official puts himself in such a position, the sooner he is made to "step down and out" the better; and with that end in view, I take the liberty of nominating Dr. C. C. Miller for General Manager for the coming year, and for that matter, for just as long as he proves himself efficient, and behaves himself; and while I am at it, I want to renominate that faithful and safe counsellor, the Hon. R. L. Taylor, for President. I would like to nominate him for General Manager, but we can't spare him from the position he now occupies. And then let's keep G. M. Doolittle, Prof. Cook, A. I. Root, and Hon. Eugene Secor in the harness; and if the rest see as I do, we will put C. P. Dadant in the grand team; then if the New Constitution should be submitted and adopted, in spite of Mr. Newman's opposition, we shall have a Board of Directors that has had years of experience, excepting Hon. Eugene Secor and Mr. Dadant, and they don't know so much but what they can learn from the other members of the Board!

Perhaps I have done mischief enough, but I feel like saying that if the Constitution is not submitted to a vote by the Advisory Board, according to the request of the United States Bee-Keepers' Union; or if the members of the Board attempt to defeat its adoption, I have paid my last dollar into the treasury of the National Bee-Keepers' Union, but shall pay in the future into the treasury of the United States Bee-Keepers' Union, and I know of several who feel the same way.

No longer ago than yesterday, I heard of a large honey-producer, and a contributor to our bee-literature, and a member of the National Bee-Keepers' Union, who is so displeased with Mr. Newman's course and stand taken in his "criticism," that he is in favor of electing some one to take his place as General Manager; and less than an hour ago I received a letter saying that one of our most influential bee-keepers, who is a member of both the National Bee-Keepers' Union and the United States Bee-Keepers' Union, "is very much determined that we shall not give up to Newman;" and as both these gentlemen are very careful in expressing their views, their opinions have all the more weight.

I want to suggest to the Advisory Board that they in some way provide for the counting of the ballots at the coming election of the National Bee-Keepers' Union, without their having to pass through the hands of the General Manager; not but what I believe him to be honest, but that no one might have reason to complain.

I wish, Mr. Editor, most emphatically to endorse all of your editorial on pages 744 and 745 of the Bee Journal, but *more especially* to commend your truthful and most sensible words in the last three paragraphs.

"Yours for every progressive step," UNION.

[As Dr. Mason is really the "father" of the New Constitution, as well as Secretary of the New Union, we take pleasure in referring to him any questions in the foregoing that may require replies.—EDITOR.]

The Names and Addresses of all your bee-friends, who are not now taking the Bee Journal, are wanted at this office. Send them in, please, when sample copies will be mailed to them. Then you can secure their subscriptions, and earn some of the premiums we have offered. The next few months will be just the time to easily get new subscribers. Try it earnestly, at least.

Questions AND Answers

CONDUCTED BY

DR. C. C. MILLER, MARENGO, ILL.

[Questions may be mailed to the Bee Journal, or to Dr. Miller direct.]

Where Did the Queen Come From?

On May 25, 1896, I found a nucleus with two frames of brood and a clipped black queen; they were examined about every two weeks until Aug. 1, when they were found to be without eggs or brood, and I could find no queen or queen-cells. I examined them a few days later, and the same result, so I gave them a frame of eggs and brood from a pure Italian colony. I examined several times up to Aug. 24, and still neither eggs nor queen. When looking through again on Sept. 11, to my surprise I found one frame partly filled with eggs less than three days old, and on looking further I found a young unclipped black queen. (By the way, I clip all my queens.)

Now, where did that queen come from? There were black colonies about two feet away on each side of the nucleus—could it have been possible they got the egg from one of these?
E. W. H.

ANSWER.—No chance to be certain about the matter, but it would be nothing strange for a virgin queen to have entered the hive, for a young virgin queen will sometimes be received where a laying queen would be rejected. As to eggs or larvæ being carried from an adjoining hive, it would require very strong proof to have such a thing accepted as fact. Quite a controversy has taken place as to the possibility of workers carrying eggs or larvæ from one part of a hive to another, but that would be a much easier thing to believe than to believe that a worker had entered an adjoining hive and carried therefrom the material from which to rear a queen.

Feeding Maple Syrup and Rye-Flour—Bee-Veil Wire—Chaff Hives.

1. Is maple syrup good to feed bees?
2. How many pounds of sugar are used to one quart of water, before being melted?
3. Why do bees die in their cells?
4. How do you feed rye-flour to the bees?
5. Is black wire-screen in a bee-veil hurtful to the eyes?
6. I am using the Laugstroth chaff hive. What kind of an out-door winter hive would you prefer for latitude 42°?

I. D. H., Worden, Mich.

ANSWERS.—1. Almost anything that bees will take is good for them, provided it is given at a time when bees can fly daily, or at least every few days. I don't know that maple syrup will injure them at any time, but I doubt if it is as good for winter food as honey or cane sugar.

2. That depends. If given as early as it ought to be given, so the bees will have plenty of time to ripen it, equal parts of sugar and water may be given, but if given in a rush late in the season, then it is better to have it the consistency of good honey, or about 5 pounds of granulated sugar to a quart of water.

3. I don't know. Generally they don't. Most of them die outside the hive, as you can easily decide by watching a strong colony during harvest. At that time, and previously for some time, the queen has been laying daily at the rate of 2,000 or more, and about six weeks after the daily laying has reached 2,000 the daily deaths should equal that figure. Supposing the bees fly during 14 hours of the day, that will make 140 an hour, or more than two a minute that the bees would be carrying out, providing all the bees took it into their heads to die in their cells. On the contrary, it is not likely you will find one dead bee on an average carried out of the hive. Likely, however, you mean why is it that in exceptional cases bees die in the cell? In winter bees pack closely together to keep warm, and they can pack more closely when all the cells in the cluster are filled. If at this time they are starved or

(Continued on page 793.)

OLDEST BEE PAPER IN AMERICA ESTABLISHED IN 1861

THE AMERICAN BEE JOURNAL

GEORGE W. YORK, Editor.

PUBLISHED WEEKLY BY

GEORGE W. YORK & COMPANY,

118 Michigan St., CHICAGO, ILL.

\$1.00 a Year—Sample Copy Sent Free.

[Entered at the Post-Office at Chicago as Second-Class Mail-Matter.]

Vol. XXXVI. CHICAGO, ILL., DEC. 10, 1896. No. 50.

EDITORIAL COMMENTS.

Union Officers for 1897 are nominated on page 791, by a correspondent signing himself "Union." Among them Dr. Miller is named for General Manager to succeed Mr. Newman. We think this will meet with the approval of the great majority of the members of the National Bee-Keepers' Union—not because Mr. Newman has not done good and faithful service (for he has done that), but because he is located so far from the "seat of war," as it were, and by reason of all his interests now being in a line entirely outside of bee-keeping. No one will ever disparage the splendid work that Mr. Newman has done while General Manager of the Union for over 10 years, but having done his duty, and practically without pay, it is no more than fair that he should be relieved of the burden.

Of course, Dr. Miller's ability for the place, and deep interest in everything relating to bee-keeping, cannot be questioned. He should be able to carry on the good work with continued success. We believe he will, if given an opportunity. And we think that all who have a vote in the matter will be pleased to support him, and at the same time feel that they are giving Mr. Newman a well-earned rest.

As to the other men nominated, we need say nothing. They are all successful, experienced business men, as every bee-keeper knows, and will do their part well, if elected.

Hurrah for all the nominees made by "Union."

Amalgamation—Eucalyptus—Rainfall.—In a letter dated at Claremont, Calif., Nov. 26, 1896, Prof. Cook has these paragraphic notes:

I read with very much interest the action taken at Lincoln, regarding the amalgamation of the National Bee-Keepers' Union and the North American Bee-Keepers' Association. I shall hope to comment upon this action soon in the American Bee Journal.

The eucalyptus trees of California are many of them now in full bloom, and the bees are exceedingly active among the blossoms. These trees must be of no slight value in way of stimulation.

We are just at the end of our fourth rainfall. We have now had about seven inches in all. Last year, at this time, we had not had a drop, and we had only 10 inches the entire season. No wonder that the bee-keepers and all others of California are joyous with hope.

A. J. COOK.

End of Wheadon & Co.—Last week an Iowa bee-keeper wrote us saying he had shipped Geo. T. Wheadon & Co., of this city, about 150 pounds of comb honey last September, and had written but received no reply. He wanted to know whom he could get to collect the amount due him for the honey.

Upon receipt of the foregoing, we called at the store where

Wheadon & Co. did business, and found that Wheadon's sign had been removed, that they had gone out of business a month ago; and were told that Terrill (who was doubtless W.'s chief backer) had fled to Canada. We were told that Wheadon received lots of honey during the two or three months he was fleecing many unsuspecting bee-keepers. He probably made his "pile" (of money), and then when it got "too warm" for him he simply "melted away," leaving many bee-keepers to wait for their returns—which failed to return.

We hope the experience gained by those who have lost through Wheadon & Co. will be valuable, and serve to impress upon them the fact that it is somewhat unsafe to trust strangers, or to ship goods to new and untried commission firms. We don't believe a single reader of the American Bee Journal was caught by Wheadon & Co., for we promptly published them as frauds, and thus doubtless we were able to save our subscribers thousands of dollars' worth of honey. It seems to us that no bee-keeper could afford to be without the Bee Journal hereafter, especially as it is published exclusively for his benefit. Our list should soon be doubled, in view of the fact that we are constantly on the lookout for honey-dealing frauds, as well as *always* against honey-adulteration, etc.

Importation of Apis Dorsata.—In this number of the Bee Journal Prof. Cook has an able article concerning *Apis dorsata* and its importation into this country. We have not opposed the scheme because we feared the big bees would not be of any advantage to our bee-keepers, but we believe that there are other lines in which the Government can spend money that would be incalculably more beneficial to the pursuit of bee-keeping than to attempt to introduce the bee in question.

And as for Mr. Benton being selected to go after *Apis dorsata*—we will withdraw all our objection to that, whenever he shows a willingness to keep his past promises and obligations that were made in good faith. Until then, we cannot conscientiously use whatever influence we may have in his behalf.

That Proposed Constitution.—We have received from Mr. Newman the following reply to our editorial referring to his criticisms of the New Constitution:

SAN DIEGO, Calif., Nov. 23, 1896.

Having read the "editorial comments" on page 744, in reply to my "criticisms" on the Constitution of the United States Bee-Keepers' Union, adopted at the Lincoln convention, I am surprised that the inconsistencies I carefully pointed out are to be disregarded, and ascribed to my "vivid imagination," traceable to the "exhilarating climate" of California. If that is all they amount to, bee-keepers of ability and intelligence should easily discover it; but if they find that I am watching their interests and defending their rights (as I always have done) by trying to prevent the serious mistake of "too hasty" and premature action—then will they thankfully avoid the embarrassment which would naturally result therefrom.

There are many other "incongruities" besides those enumerated in my "criticisms" on page 742, but perhaps others may mention them, and so I will forbear at present, and give them the chance.

My argument on Sec. 2, Art. V., favored "sealed ballots" to be sent with the Dues, which were to be opened and counted by the committee, etc. As postal cards are already open, they were not referred to by me in that connection. When accompanied by the dollar, they will of course be inserted in *sealed envelopes* by all those having ordinary intelligence.

I feel sure that to *unbiased minds* my "criticisms" are mainly incontrovertible.

On Nov. 3, I submitted the whole matter to the Advisory Board of the National Bee-Keepers' Union to decide what action shall be taken in the premises. Its decision will be final.

THOMAS G. NEWMAN.

As so far, only Mr. Newman has seemingly been able to point out what he calls "incongruities" in the New Constitu-

tion, it would appear that perhaps his own is not one of the "unbiased minds" he refers to. At least, we think "bee-keepers of ability and intelligence" will view it in that light, for we can see no good reason why he should for any cause oppose the New Constitution.

Again, we believe that "those having ordinary intelligence," will easily be able to mail their Dues in a sealed envelope to the General Manager, and the postal card ballot to the committee or counting, especially when both the return envelope and the card have the addresses printed on them.

Is it possible that among all the bee-keepers there is no one, aside from Mr. Newman, who is "watching their interests and defending their rights," etc.? It may be all of us need to have a guardian appointed—or several of them—"to prevent the serious mistake of 'too hasty' and premature action" in this and all other of our important matters. But we believe the Advisory Board will not thus discount the "ability and intelligence" of real bee-keepers to look out for themselves and their own best interests.

Honey Tea-Cake.—Miss Mathilda Candler, of Wisconsin, sends us the following recipe for making honey tea-cake:

One cup of honey, half a cup of sour cream, two eggs, half a cup of butter, two of flour, scant half teaspoonful of soda, one teaspoonful of cream-of-tartar. Bake 30 minutes in a moderate oven.

We wish that others would send in recipes in which honey is used. Let us all try to get people to use more honey and less sugar. It would help the demand for honey.

How Dost Thou Read?—Mr. S. E. Miller, of Missouri, in the *Progressive Bee-Keeper*, has the following helpful suggestions along the line of making our reading more valuable:

The evenings are becoming long, and the bee-keeper finds a little more time to read up; at least, as a rule, he will find more time for reading in the winter than during the busy summer months.

But there is one disadvantage about reading in the winter. We are not able to put into practice or test the many hints and new devices that we find given in the journals, and before the time comes around when we might put them to a test we are likely to have forgotten them.

Have you not, at times, read something that made you feel like going into the apiary and putting it into practice, but as the proper season was not at hand you were obliged to postpone it, and probably by the time the proper season arrived you had forgotten it?

Now, would it not be well to keep a memorandum in which to write down these things, so that we could recall them to mind when the proper time arrives, say, something like this: "Progressive, Dec. 1, page 360—How to start bees to work in sections—June 15." This would mean that the article was seasonable June 15.

I would give the title of the article and tell the name of the journal, the number and the page where it could be found. Thus, an article that we consider valuable could be noted down, and it would be very little trouble to find it when the proper time arrived for us to post ourselves on any particular subject.

Mr. Miller has given a good hint in the above. It would be an easy matter to keep a vest-pocket note-book in which to jot down important things in the manner suggested. Try it the coming winter, and see what a help it will be when the time comes to put into practice the many kinks that will be published between now and the next honey season. (Of course you'll need a big note-book to keep track of all the good things in six months of the old American Bee Journal!)

Paste for Labeling on tin, when other things fail, is made simply of water and flour not boiled. So an exchange says. It can be proven by trial.

QUESTIONS AND ANSWERS.

(Continued from page 791.)

frozen to death, all the cells in the cluster will be found filled with bees, probably. Sometimes when the cluster moves from one part of the hive to another, some bees will be left to perish in the cells, being perhaps too sleepy or too cold to go with the crowd.

4. I'm not certain I ever tried it but once, and then didn't succeed very well. I think the bees will work better on ground corn and oats. Rye-flour doesn't give a very good foothold. But if you prefer to use rye-flour, put it in any kind of a shallow dish or box—and I should prefer to have some bran mixed with it—and if the bees don't take to it with sufficient readiness, use a little honey to bait them to the place. If they can get natural pollen it isn't likely you can get them to fool with the substitute.

5. M. M. Baldrige, and perhaps others, have reported injury to the eyes from such veils. Probably wire is just as good as threads of cotton or silk, only it is too coarse and obstructs the vision too much.

6. Perhaps there is nothing better.

Sowing Sweet Clover in an Orchard.

I have an apple orchard that I do not want to plow any more. I had intended to sow it to red clover, let it grow and remain on the ground for the benefit of the trees. How would it do to sow sweet clover instead, or sweet clover and Alsike mixed? If so, how much seed to the acre? If I could benefit my trees and bees at the same time, I should be pleased.

S., Mansfield, Mo.

ANSWER.—I'm afraid I don't know enough about the case to give a very satisfactory answer, but I'll answer as well as I can, and if I get far out of the way perhaps some one will correct me. I have some doubts whether Alsike would do much mixed with sweet clover, but I don't know anything about it from experience. If the sweet clover should make its usual growth it wouldn't give the Alsike much chance to see daylight. I believe I would as soon risk sweet clover as red in an orchard. In some respects it would be better. The roots run deep, and when they rot, as they do every two years, they will leave a lot of holes in the ground where they were that will have somewhat the effect of tiling. If white clover prevails to some extent in the neighborhood, it would be well to cut the sweet clover just as it begins to bud for bloom, or at least before it blooms, leaving the hay on the ground to enrich the trees, then the plants will bloom a little later, after white clover is over. One trouble with sweet clover, at least in some places, is that it blooms with white clover, but early cutting will secure at least some of its bloom after white clover is gone.

If any one has had experience with sweet clover in an orchard, I wish he would rise and speak.

A New Binder for holding a year's numbers of the *American Bee Journal*, we propose to mail, postpaid, to every subscriber who sends us 20 cents. It is called "The Wood Binder," is patented, and is an entirely new and very simple arrangement. Full printed directions accompany each Binder. Every reader should get it, and preserve the copies of the *Bee Journal* as fast as they are received. They are invaluable for reference, and at the low price of the Binder you can afford to get it yearly.

The Alsike Clover Leaflet consists of 2 pages, with illustrations, showing the value of Alsike clover, and telling how to grow it. This Leaflet is just the thing to hand to every farmer in your neighborhood. Send to the *Bee Journal* office for a quantity of them, and see that they are distributed where they will do the most good. Prices, postpaid, are as follows: 50 for 25 cents; 100 for 40 cents; or 200 for 70 cents.

The McEvoy Foul Brood Treatment is given in Dr. Howard's pamphlet on "Foul Brood; Its Natural History and Rational Treatment." It is the latest publication on the subject, and should be in the hands of every bee-keeper. Price, 25 cents; or clubbed with the *Bee Journal* for one year—both for \$1.10.

General Items.

Bees Did Well.

My bees did very well this season. We had a fine fall crop of comb honey.
Sangamon Co., Ill. C. V. MANN.

Perhaps Caused by Lack of Stores.

There is nothing in bee-keeping like actual practice and experiments, and it would be interesting to some if A. G. A., of Waring, Tex., would build up the colony containing the "drone-laying queen," mentioned on page 762, by giving combs of brood and honey, and then report the result. Such cases almost invariably prove to be caused by the lack of stores.
W. H. PRIDGEN.

Warren Co., N. C.

A Poor Year Clear Through.

The past season has proved a poor one in this locality. There was plenty of white clover, but owing to unfavorable weather it yielded very little honey. The yield of fall honey was less than half of what we term a fair crop. Bees are generally in good condition for winter here.
W. J. CULLINAN.

Quincy, Ill., Nov. 2.

Waiting for Amalgamation.

I have my name and dollar ready and waiting for the Bee-Keepers' Union, as quick as it shall unite with the North American, and undertake to down honey adulteration, or, for that matter, aim to down all food adulteration. Why should it be difficult to have a law passed requiring all goods used for food to be correctly labeled, stating the true nature of contents, whether pure or adulterated, and with what, and what per cent.? I do not object to certain goods being adulterated, or mixed, with something that may be as good, but cheaper; but I want to *know* it. Let not the question rest.
ALFRED MOTTAZ.

La Salle Co., Ill.

Notes from Northern Indiana.

The season just past might be classed as a poor one. There was no honey from white clover to speak of in this locality, owing to the severe drouth we have had for the past two or three years, which seemed to kill out the white clover, which, fortunately, the rains of August have started to grow nicely. Now that we may expect a crop of white clover honey next season, the bee-keeper will lay his plans accordingly.

The basswood bloom opened nicely the past season, about 10 days earlier than usual, and there was a good flow from this source for a very few days, then the flow of nectar was poor until it ceased to bloom.

The bees worked well on common red clover this season (or they do almost every year), but did not get much honey from that source, but kept up brood-rearing nicely until fall flowers began to bloom. Is this not a point worthy of note, to keep a strain or breed of bees that will hustle about and get enough honey to keep breeding going on until a good flow of nectar presents itself?

We got a fair crop of honey this season, and I give the Italian bees the

THE GIANT MANUAL.

Twelve Books Combined in One!

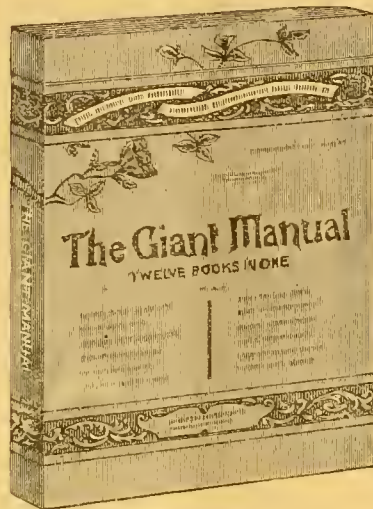

We will send **The Giant Manual**, containing everything enumerated above, by mail post-paid, upon receipt of only **Twenty-five Cents**.

THE GIANT MANUAL is the largest, the most comprehensive and the most extraordinary book ever sold for twenty-five cents. It is in reality twelve separate and distinct books combined in one. It contains precisely the same amount of material as is ordinarily published in twelve distinct 25 cent books, and it may therefore be claimed, with perfect truth and candor, that it is a *three dollar book for twenty-five cents*. In shape it is a mammoth quarto of 192 large three-column pages, with many appropriate illustrations, and is handsomely bound in attractive colored covers. Instruction, amusement, entertainment—all are combined herein, and the book cannot but be of the utmost practical use and value to every man, woman and child. The following are the contents of THE GIANT MANUAL:

1. **The Standard Letter Writer** for Ladies and Gentlemen, a complete guide to correspondence.
2. **Manual of Etiquette** for Ladies and Gentlemen, a guide to politeness and good breeding.
3. **Winter Evening Recreations**, a large collection of Acting Charades, Tableaux, Games, Puzzles, etc.
4. **Parlor Magic and Chemical Experiments**. Tells how to perform hundreds of amusing tricks.
5. **Selections for Autograph Albums**, Valentines, Wedding Anniversaries, Birthday Greetings, etc.
6. **Low Life in New York**. A series of vivid pen pictures showing the dark side of life in the great city.
7. **The Road to Wealth**. A practical work, telling how all may make money easily and rapidly.
8. **One Hundred Popular Songs**, sentimental, pathetic and comic, including most of the favorites, new and old.
9. **Popular Recitations and Dialogues**, humorous, dramatic and pathetic, including the most popular.
10. **How to Make and Save Money on the Farm**. A valuable compilation of useful facts and suggestions.
11. **The History and Mystery of Common Things**. Describes the manufacture of familiar things.
12. **Useful Knowledge for the Million**, a handy compilation of useful information for all.

The Bonanza Book for Boys and Girls.

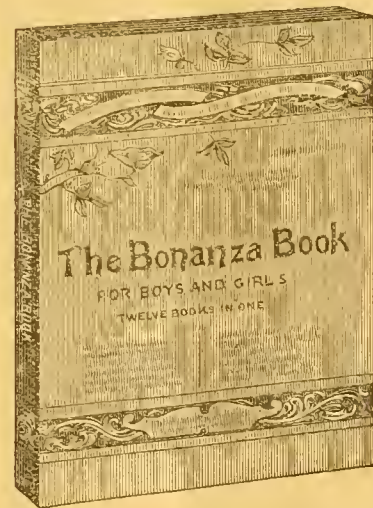

We will send **The Bonanza Book for Boys and Girls**, containing everything named above, by mail post-paid, upon receipt of only **Twenty-five Cents**.

TWELVE BOOKS COMBINED IN ONE!

This great book contains the largest amount and greatest variety of amusing and instructive reading matter for boys and girls ever gathered together and published in a single volume. It is in reality twelve separate and distinct books combined in one. It contains precisely the same amount of material as is ordinarily published in twelve distinct 25 cent books, and it may therefore be claimed, with perfect truth and candor, that it is a *three dollar book for twenty-five cents*. In shape it is a mammoth quarto of 192 large three-column pages, with many appropriate illustrations, and is handsomely bound in attractive colored covers. The following are the contents of The Bonanza Book for Boys and Girls:

1. **Modern Recitations**, in prose and verse, embracing many old and new favorites.
2. **Gulliver's Travels**. Adventures among the Lilliputians and Gnats.
3. **Dialogues, Recitations and Readings**. A large and choice collection.
4. **Round the Evening Lamp**. Stories, pictures, puzzles and games for the little folks.
5. **Parlor Amusements**. Acting Charades, Parlor Dramas, Shadow Pantomimes, Games, Puzzles, etc.
6. **Grimm's Fairy Tales**. The most popular of all fairy stories.
7. **The Self-Made Men of Modern Times**. Portraits and biographies of famous Americans.
8. **Wonders of the World**. Descriptions and illustrations of natural and other wonders.
9. **Wonders of the Sea**. Descriptions of the wonders of the deep, profusely illustrated.
10. **Distinguished People**. Biographical sketches of famous men and women.
11. **Manners and Customs in Far-Away Lands**. Life and habits of peculiar people and tribes.
12. **The People's Natural History**. Interesting information regarding beasts, birds, fishes, reptiles and insects.

As a Premium You can have either book FREE for sending us 1 NEW SUBSCRIBER to the Bee Journal for a year; or we will club it with the Journal—both for \$1.10.

GEORGE W. YORK & CO., 118 Michigan St., CHICAGO, ILL.

California

If you care to know of its Fruits, Flowers Climate or Resources, send for a Sample Copy of California's Favorite Paper—

The Pacific Rural Press

The leading Horticultural and Agricultural paper of the Pacific Coast. Published weekly, handsomely illustrated, \$2.00 per annum. Sample Copy Free.

PACIFIC RURAL PRESS,
220 Market St., - SAN FRANCISCO, CAL.



NEW MAMMOTH Poultry Guide for 1897.

Something entirely new; almost 100 pages; contains lithograph plate of Poultry in natural colors; plans for poultry houses, remedies and recipes for all diseases, how to make Poultry and Gardening pay; only 15 cents.

John Bauscher, Jr., Box 94 Freeport, Ill.

49A13t Mention the American Bee Journal.

MUTH'S HONEY EXTRACTOR PERFECTION Cold-Blast Smokers,

Square Glass Honey Jars, Etc.

For Circulars, apply to CHAS. F. MUTH & SON, Cor. Freeman & Central Aves., Cincinnati, O. Send 10c for Practical Hints to Bee-Keepers.

credit for the same, as I happen to know how the dark ones did in this locality this season at honey-gathering. It is a well-known fact that many bee-keepers who keep black bees think the Italians are no better than blacks, only that queen-breeders want to keep up the boom to sell queens. Experience teaches me to keep the Italian bees first, last, and all the time for profit, and I have no queens to sell, either.

Fall flowers came into bloom earlier the past season than usual, and the bees seemed to work pretty well on them, but they did not furnish nectar like they do some seasons, and only strong colonies furnished any surplus.

I began the season with 74 colonies, and increased them to 87, which are in fair condition for wintering, and all will be kept on the summer stands except 15 colonies. My crop of honey was 2,255 pounds, about two-thirds extracted and one-third comb, and all sold but a small amount.

In the near future I will tell how I sell my honey, as we want a market for our honey as well as to get the crop itself.

C. A. BUNCH.

Marshall Co., Ind.

An Extra Good Year.

This has been an extra-good year for bees here. I have 43 colonies in good condition for wintering on the summer stands. I am in southwest Missouri, 30 miles from Ft. Scott, Kans. I sell most of my honey in our county seat at 15 cents. I work for comb honey.

Some commission men on South Water Street, Chicago, tried hard to get me to ship to them, but I am a reader of the "Old Reliable" American Bee Journal, and did not get caught. I want the Bee Journal to come, as it is worth more than the subscription to me.

Vernon Co., Mo. J. H. HIGHTOWER.

Short Honey Crop.

My honey crop was short this year—not more than 1/2 of an average crop. The word "average" means about 30 pounds per colony. I get no basswood honey here, what little there is finishes out with the white clover, about July 15, and that finishes the surplus crop for the year; and if the late flow fails, then I must feed for winter. The latter was the case this fall. I have 60 colonies of bees on the summer stands, and six others in my care. I pay ground rent for my apiary, fully half a mile from my residence, on account of its being too thickly settled on all sides of me.

JOHN BERKEY.

Easton, Pa., Nov. 2.

Hunting Wild Bees—Reasoning.

In giving my experience in hunting wild bees, I will say the worst bother that I have ever experienced in locating them was in finding them where I least expected—in a log or stump, or even some bush, where they had settled and continued to stay. In my first experience of hunting wild bees, I have been fooled many a time by cutting a tree too soon, that is, before the swarm had really taken possession of the tree, as they will often work very strongly in a tree for several days before the swarm to suit it. They will never go in until they have the hollow thoroughly cleaned

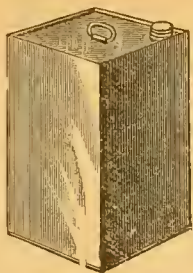

Finest Alfalfa Honey!

IT SELLS ON TASTING.

The Honey that Suits All Who Buy It.

We can furnish **White Alfalfa** Extracted Honey, in 60-pound tin cans, on board cars in Chicago, at these prices: 1 can, in a case, 8 cents per pound; 2 cans in one case, 7 1/2 cents; 4 cans (2 cases) or more, 7 1/4 cents. The Cash must accompany each order. **Fine Basswood** Honey at 1/2 cent more per pound.

A sample of the honey will be mailed to an intending purchaser, for 8 cents, to cover postage, packing, etc. We guarantee purity, and what we ship will be equal to sample.

Now it seems to us here is a splendid chance for any bee-keeper to supply his home demand after his own crop is all sold. Or, why not begin now to create a local honey-trade? Order one 60-pound can first, and start out among your neighbors and friends, and see what you can do. You ought to get at least 15 cents per pound in 5-pound lots, or 50 cents for 3 pounds. Some may be able to do even better than that, though we think that enough ought to be sold at these prices to make a fairly paying business out of it. Give it a good trial. Push it. It may grow into a nice winter's work for you.

GEORGE W. YORK & CO., 118 Michigan Street, CHICAGO, ILL.

✦ MONEY SAVED IS MONEY GAINED. ✦

THE ROYAL UNION Life Insurance Company DES MOINES, IOWA.

The Iowa Policy

Is one that definitely promises to keep an accurate account with you; credit your premiums and interest, charge the actual expense and mortuary cost, and hold the remaining funds subject to your order.

Agents Wanted.

JOHN B. KING, GENERAL AGENT,
Suite 513 First Nat'l Bank Bld'g,
20A1f CHICAGO, ILL.

Mention the American Bee Journal.

DUQUESNE COLLEGE!

PENN AVE. AND EIGHTH ST.

PITTSBURG, PA.

Thorough Courses—Classical, Scientific, Normal, English, Commercial, Preparatory, and Ladies Literary. Efficient and experienced instructors. Day and Night sessions.

Send for Catalog.

Mention the American Bee Journal.

THROAT AND LUNG DISEASES,
DR. PEIRO, Specialist
Offices: 1019, 100 State St.,
CHICAGO. Hours 9 to 4.

The "Premium": A Good Watch Mailed Free!

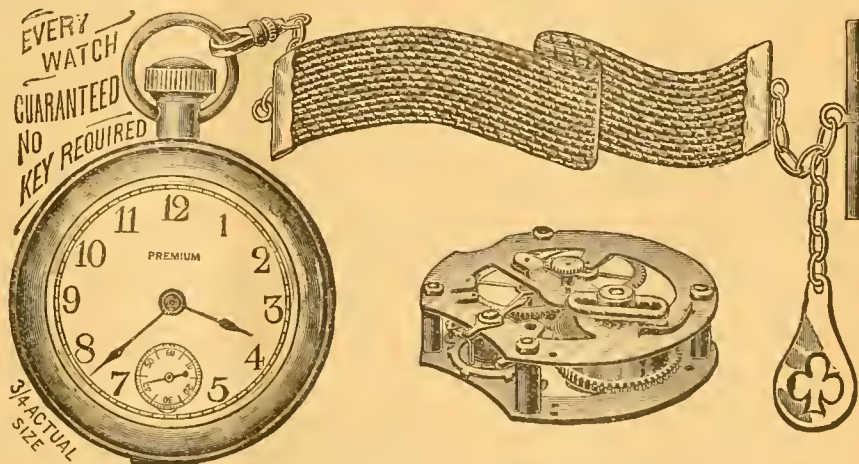

The movement of this Watch is regular American lever, lantern pinion, quick train, 240 beats per minute, three-quarter plate, short wind; runs 30 hours to one winding; dust cap over movement; every movement fully timed; regulated and guaranteed for one year, the same as a Waltham or Elgin; nickel finish, heavy bevel crystal, and back pinion wind and set.

OUR OFFERS:—We will mail the above Watch for \$1.25; or club it with the Bee Journal for a year—both together for \$2.10; or we will send it free as a premium for getting Three New yearly Subscribers to the Bee Journal at \$1.00 each. The Watch is mailed from New York City, so please allow a few days before expecting your order to be filled.

GEORGE W. YORK & CO., 118 Michigan St., Chicago, Ill.

out. A green hand at this may lose lots of good trees by being a day or two too soon, and for the benefit of any one who may be interested, I will tell how you can easily know whether the swarm is in the tree or whether the bees are merely preparing it.

When bees are cleaning out to go into a tree, you will always find a few bees flying up and down the body of the tree, as if they were looking for a hole, which proceeding stops as soon as a swarm go in. Another way to tell is by the actions of the bees at work. The nearer they get to the completion of their work, the more bees seem to be at work; and it is easy, when once learned, to tell by their actions whether they are carrying in honey or not. They act much like bees playing when they are cleaning out a tree, instead of shooting straight in and out of the hole when carrying in honey.

Although my experience has been a wide one, in hunting wild bees, it has never been my good fortune to get a barrel of honey out of any one tree I ever found.

Now I want to say a word about bees reasoning. One thing I have noticed closely for several years, and I wish others to notice the same thing, is, that when bees in swarming-time are bad to abscond, and hard to keep, look out for a poor honey season in that locality. When your bees are easily controlled and hived, and contented when hived, look out for honey that season. When you hear of lots of swarms passing in every direction, look out for honey in that locality that season. But when you see and hear of swarms all going in one direction, there is a good honey-flow the way they are headed. This has been my experience from long watching, and is worth your attention.

Pollock, Mo.

ANDREW COTTON.

Not All Had Failures.

Although the Secretary of our Connecticut bee-association reports this year as one of failure, on page 734, I am able to say I obtained 340 pounds of comb honey from 10 colonies. I was able to do so only by keeping all colonies strong in bees, and by returning the swarms to the old stands. I practice the method of requeening at the swarming season, by killing all old queens, and tearing down queen-cells, if I wish to keep any particular queen. I have been able to secure a fair surplus—even for the last three years, with their drouth and excess of moisture, by this method.

I sell nearly all my honey in the home market for 15 cents per pound, and always run short before the new crop comes in.

I intend to increase my colonies next year, as I take great pleasure in them, and believe as Mr. Doolittle says, that individuality is the keynote of success.

C. H. CHITTENDEN.

Middlesex Co., Conn.

Eating Honey—Being "On Time."

Would it not be kind in Dr. Gallup to explain in the Bee Journal how to avoid the sickness experienced by some after eating honey? I cannot eat strawberries from the vine without having an experience with the colic. What must I do, Doctor, to avoid this result?

I have kept bees for about 15 years, with varied success. This year has been



You can get a SAFE and SURE remedy for all the ordinary ills of life as well as a SURE CURE for

**BRIGHT'S DISEASE,
URINARY DISEASES,
FEMALE COMPLAINTS
GENERAL DEBILITY,
MALARIA**

and all diseases caused by disordered *kidneys* and *liver* at the *Country Store*. . . .



a PURELY VEGETABLE PREPARATION that has cured thousands and will cure you. Large bottle or new style smaller bottle at your nearest store.

Mention the American Bee Journal.

COMB FOUNDATION

Wax always wanted for Cash or in Exchange for Fdn. or other Supplies. My trade is established on **Low Prices** and the **merit of my Foundation. Orders filled promptly.**

WORKING WAX INTO FDN. BY THE LB. A SPECIALTY. Wholesale prices to **dealers and large consumers.** Send for Prices and Samples to—**GUS DITTMER, AUGUSTA, WIS.**

Reference—Augusta Bank. 1 Atf

Mention the American Bee Journal.

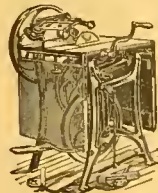

ONE MAN WITH THE UNION COMBINATION SAW

Can do the work of four men using hand tools, in Rippling, Cutting-off, Mitring, Rabbeting, Grooving, Gaining, Dadoling, Edging-up, Jointing Stuff, etc. Full Line of Foot and Hand Power Machinery Sold on Trial. Catalogue Free.

SENECA FALLS MFG. CO.,

46 Water St., SENECA FALLS, N. Y.

1 A1y Mention the American Bee Journal.



44A26t Mention the American Bee Journal.

READERS Of this Journal who write to any of our advertisers, either in ordering, or asking about the Goods offered, will please state that they saw the Advertisement in this paper.

a good one, both in swarms and surplus honey. The first swarm that I saved this spring issued on May 6. A neighbor had a rousing swarm May 3. How is that for central Iowa?

Bees have plenty of good stores for winter, and the prospect is good for next year; but most of the bees in this part died in 1893 and 1895, when I had to feed to keep mine, and then lost a good many by not feeding early enough, and heavy enough.

One may know all about the bee-business, and then fail by letting go till tomorrow the duties of to-day—as I did with part of my bees that I intended to put into the cellar. We have had four or five days real cold and windy; the bees were outside, and I sat inside with a big boil on my neck. It is always best to be "on time;" the train is not apt to wait.

T. S. HURLEY.

Tama Co., Iowa, Nov. 30.

Did Better than for Years.

I had five colonies in box-hives last spring, and have now gotten rid of those hives. My advice to every one is to let box-hives alone. Bees did better last summer than for many years; the last part of the season was poor, but the bees have plenty to eat, and so have I. People prefer to buy flour rather than honey.

I now have 13 colonies in the cellar, with about one-half bushel of bees in each hive, and plenty of honey to winter on.

I have had the Bee Journal nearly two years, and have read it all, which I cannot say of any other paper I have ever taken. It is worth more to me than any story book I ever saw.

J. V. B. HERRICK

Hennepin Co., Minn., Nov. 28.

Best Year in Four for Bees.

I can't get along without the American Bee Journal. I have several neighbors who keep bees, but I cannot get them to take a bee-paper—they think they know it all, but I notice that I scoop them all when it comes to getting honey. They all say that this has been the worst year here since bees have been in this part of the country. Now I have been keeping bees for four years, and this has been the best year for me, and I give the American Bee Journal the credit for it, as I got the information out of it, which I used at the right time and in the right way, so that I had my bees ready for the honey-flow when it came, instead of having them ready after the flow was over—like most of my neighbors. I got about 50 pounds of honey per colony, spring count. I think that is first-rate for an off year. All hail, the old American Bee Journal!

J. W. SEFTON.

Whatcom Co., Wash.

Bees Almost a Failure.

The bee-business is almost a failure here on the prairie. We have had two years of no honey. Two years ago I had about 150 colonies of bees, and last spring I had 57 colonies with queens. By watching them very closely I did not lose a swarm. I fed them 200 pounds of sugar, and moved them 12 miles to the timber, so as to get to the basswood. I got 2,400 pounds of basswood honey, and 600 pounds of buckwheat, all ex-

tracted. I get 8 cents for basswood, and 7 for buckwheat, and could sell more if I had it. The bees are in splendid condition this fall.

I could get all the bees I wanted this fall by taking them out of the hives. I took bees out of nine hives; a 10-frame hive averaging a little better than six pounds of bees.

I see in the Bee Journal that salt and water cures the "nameless" bee-disease. A number of years ago I tried that remedy, and it was a "sure cure" for me. They got out of the hive as soon as they could, and it killed them!

There is a good prospect for honey another year; the white clover has come up strong.

CHAS. BLACKBURN.

Buchanan Co., Iowa, Nov. 23.

THE "NOVELTY" POCKET-KNIFE!

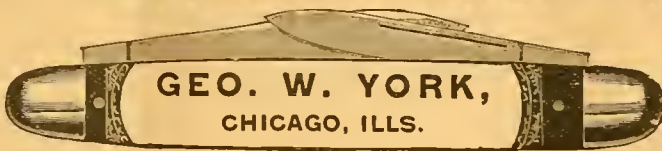

Your Name on the Knife.—When ordering, be sure to say just what Name and Address you wish put on the Knife.

The NOVELTY KNIFE is indeed a novelty. The novelty lies in the handle. It is made beautifully of indestructible celluloid, which is as transparent as glass. Underneath the celluloid, on one side of the handle is placed an AMERICAN BEE JOURNAL reminder, and on the other side, name and residence of the Subscriber.

The material entering into this celebrated knife is of the very best quality; the blades are handforged out of the very finest English razor-steel, and we warrant every blade. The holsters are made of German silver, and will never rust or corrode. The rivets are hardened German silver wire; the linings are plate brass; the back springs of Sheffield spring steel, and the finish of handle as described above. It will last a lifetime, with proper usage.

Why purchase the Novelty Knife? In case a good knife is lost, the chances are, the owner will never recover it; but if the Novelty is lost, having name and address of owner, the finder will return it; otherwise to try to destroy the name and address, would destroy the knife. If traveling, and you meet with a serious accident, and are so fortunate as to have one of the Novelties, your pocket KNIFE will serve as an identifier; and in case of death, your relatives will at once be apprised of the accident.

How appropriate this knife is for a Christmas, New Year or birthday present! What more lasting memento could a mother give to a son, a wife to a husband, a sister to a brother, a lady to a gentleman, or vice versa, a son to a mother, a husband to a wife, a brother to a sister or a gentleman to a lady—the knife having the name of the recipient on one side?

The accompanying cut gives a faint idea, but cannot fully convey an exact representation of this beautiful knife, as the "Novelty" must be seen to be appreciated.

How to Get this Valuable Knife.—We send it postpaid, for \$1.00, or give it as a premium to the one sending us three new Subscribers to the BEE JOURNAL (with \$3.00), and we will also send to each new name a copy of the Premium Edition of the book "Bees and Honey." We club the Novelty Knife with the BEE JOURNAL for one year, both for \$1.90.

Any Name and Address Put on the Knife.

GEORGE W. YORK & CO.,

CHICAGO, ILLS.

Allow about two weeks for your order to be filled.

NOW WE HAVE IT!

GLEASON'S HORSE-BOOK!

The Only Complete and Authorized Work
by America's King of Horse-Trainers,

PROF. OSCAR R. GLEASON,

Renowned throughout America and recognized by the United States Government as the most expert and successful horseman of the age. The whole work comprises History, Breeding, Training, Breaking, Buying, Feeding, Grooming, Shoeing, Doctoring, Telling Age, and General Care of the Horse.

416 Octavo Pages—173 Striking Illustrations.

Produced under the direction of the U. S. Government Veterinary Surgeon.

In this book Prof. Gleason has given to the world for the first time his most wonderful methods of training and treating horses

100,000 SOLD AT \$3.00 EACH.

But we have arranged to supply a limited number of copies to our subscribers absolutely free. First come, first served.

Here are Our Offers of this Great Book.

Regardless of the fact that thousands upon thousands of these books in cloth binding have been sold at \$3.00 each, we are enabled to, and will for a limited period, send a heavy-paper-bound copy FREE as a premium to our present regular subscribers for sending us ONE NEW Subscriber to the Bee Journal for a year at \$1.00; or we will mail the book and the Bee Journal for a year to any one sending us \$1.60. Address,

GEORGE W. YORK & CO.,

118 Michigan Street, CHICAGO, ILL.

40,000.

THE Nebraska Farmer

Has made a contract with the Nebraska Club, to print for them 40,000 copies over and above the regular weekly issue, each month for six months, of reliable information about Nebraska.

If interested, send for free copy, to

MR. CHAS. E. WILLIAMSON,
Secretary Nebraska Club,
OMAHA, NEBR., or

Nebraska Farmer Co.

Lincoln, Nebr.

44A13 Mention the American Bee Journal.

PAID FOR Cash Beeswax

For all the Good, Pure Yellow Beeswax delivered to our office till further notice, we will pay 25 cents per pound, CASH; or 28 cents for whatever part is exchanged for the Bee Journal, Honey, Books or Seed, that we offer. If you want cash, promptly, for your Beeswax, send it on at once. Impure wax not taken at any price. Address as follows, very plainly,

GEO. W. YORK & CO.

118 Michigan st., CHICAGO, ILL.

IF YOU WANT THE

BEE-BOOK

That covers the whole Apicultural Field more completely than any other published, send \$1.25 to Prof. A. J. Cook, Claremont, Calif., for his

Bee-Keeper's Guide.

Liberal Discounts to the Trade.



For a knife that will cut a horn without crushing, because it cuts from four sides at once get

THE KEYSTONE DEHORNER

It is humane, rapid and durable. Fully warranted, HIGHEST AWARD at WORLD'S FAIR. Descriptive circulars FREE. A. C. BROSIUS, Cochranville, Pa.

40E13t Mention the American Bee Journal.

THROAT AND LUNG DISEASES,
DR. PEIRO, Specialist
Offices: 1019, 100 State St.,
CHICAGO. Hours 9 to 4.

USEFUL AND POPULAR BOOKS.

WORKS OF INTEREST AND VALUE TO PEOPLE
OF ALL CLASSES AND TASTES.

Each Book Consists of a Handsome Octavo Volume of 64 Large Double-Column Pages, Neatly Bound in an Attractive Paper Cover.

Brief descriptions of a select list of useful and popular books will be found below. These books cover a wide range of subjects, the object being to please all tastes and requirements. Each is a complete text-book upon the special theme of which it treats, and they are offered upon such terms as to place them within the reach of all. No man or woman can fail to be profited by the possession of these books; no home should be without them. Each book consists of a handsome octavo volume of 64 large double-column pages, nicely printed and bound in attractive paper covers. Many of them are handsomely illustrated:

No. 423. **How to Train Animals.** This book, written by an experienced animal trainer, tells how, to teach horses, dogs, cats, mules, goats, hogs and other animals, also birds, to perform the most remarkable tricks and feats of intelligence.

No. 432. **Every Boy His Own Toy-Maker.** A great book for boys, telling how to make a Steam Engine, Photographic Camera, Wudmill, Microscope, Electrical Machine, Galvanic Battery, Electric Telegraph, Telephone, Magic Lantern, Boats, Kites, Balloons, and many other things.

No. 429. **The Practical Guide to Floriculture,** a complete practical guide to the culture of flowers and plants, by Eben E. Rexford, one of the leading authorities upon all matters pertaining to floriculture.

No. 425. **Home Amusements,** a splendid collection of Games, Puzzles, Tricks, Diversions, Pastimes, Experiments, Tableaux Vivants, Shadow Pantomimes, Acting Charades and Proverbs, for social gatherings, public and private entertainments and evenings at home.

No. 430. **Modern Etiquette for all Occasions.** An excellent work upon this subject, containing the rules of deportment for all occasions, both for ladies and gentlemen, as observed by the best society.

No. 431. **The Ready Reference Manual of Facts, Figures and Statistics.** A collection of useful facts, figures, statistics and dates—a compendium of valuable information for the use of every man, woman and child, conveniently arranged for ready reference.

No. 417. **The Practical Poultry Keeper.** An entirely new book on poultry keeping, just published, involving the experience of successful poultry keepers, and embracing all the latest ideas on the subject.

No. 416. **The Practical Horse and Cattle Doctor.** This valuable book describes the symptoms of every disease with which horses and cattle are afflicted, gives the causes of such diseases, together with plain and explicit directions for their treatment.

No. 41. **The Handy Cyclopaedia of Every Day Wants,** a compendium of useful and valuable information, filled with practical receipts, hints, helps and suggestions, of the greatest use to every housekeeper.

No. 43. **The Family Doctor Book,** containing plain and simple directions for the treatment of every known disease or ailment of the human frame, and suggesting simple home remedies which usually effect a cure without the necessity of employing a physician.

No. 42. **The National Handy Dictionary,** a complete pocket dictionary of the English language, containing 39,000 words, with their orthography, definition and pronunciation, and 127 illustrations.

No. 45. **The Ladies' Model Fancy-Work Manual.** An entirely new book embodying all the latest ideas in needlework, crochet, knitting and embroidery. It contains many new lace and crochet patterns, and directions for making many articles of wearing apparel and for decorative purposes.

No. 45. **The American Family Cook Book.** A complete cook book, compiled by an experienced housekeeper, and containing more than seven hundred of the choicest recipes, classified for ready reference.

No. 435. **The Ladies' Guide to Beauty.** This book contains minute and practical instructions, accompanied by many valuable recipes, for securing a handsome form, a clear and smooth skin, a beautiful complexion, beautiful hair, etc., etc.

No. 41. **Mrs. Partington's Grab-Bag,** the contents of which are very, very funny. The last and best book written by B. F. Shillaber, the original Mrs. Partington.

No. 445. **Everybody's Law Book.** The object of this volume is to impart, in a simple, concise manner, the fullest information regarding legal matters. In all ordinary emergencies it will save employing a lawyer.

No. 437. **Phrenology Made Easy.** This book tells you how to read a person's character by the simple act of passing the fingers over the head, and the accuracy of these revelations will be a surprise to you and all your friends.

No. 443. **Lessons in Shorthand,** on Gurney's System. A complete instruction book in the art of phonography or shorthand writing, showing how any one may acquire and become proficient in this valuable art.

The above books in other editions are usually sold at 25 cents each, but

Read Our Liberal Offer: We will send any one of the above books by mail post-paid upon receipt of only **Ten Cents**; any four for **Twenty-five Cents**; any ten for **Fifty Cents**. By buying ten books at a time you get them at half price. Please order by the numbers as given.

Read these Premium Offers: We will send any 5 (50 cents' worth) of the above-named books by mail post-paid, also the American Bee Journal for one year, upon receipt of only \$1.25; or we will send any 10 books (one dollar's worth) also the American Bee Journal for one year, upon receipt of only \$1.50. Send us **One New Subscriber** to the Bee Journal for one year (at \$1.00), and we will mail you free, as a premium, your choice of 10 of the above books. Address,

GEORGE W. YORK & CO., 118 Mich. St., CHICAGO, ILL.

Question-Box.

In the multitude of counsellors there is safety.—Prov. 11-14.

Swapping Supers vs. Bait Sections.

Query 37.—I see it recommended to practice swapping supers of one colony for those of another, while bees are at work in the sections.

1. Do you think this advisable?
2. Is it better than giving bait sections?—MINNESOTA.

Mrs. J. N. Heater—1 and 2. I think not.

Prof. A. J. Cook—1. I doubt if it will pay. 2. I think not.

Rev. E. T. Abbott—1 and 2. I have not had much experience along this line.

J. M. Hambaugh—1 and 2. I have never practiced this method, hence I am no authority.

H. D. Cutting—1. You don't say for what purpose. 2. I prefer bait sections to "swapping."

Mrs. L. Harrison—1. I do not. 2. When honey comes in freely, no bait sections are needed.

W. G. Larrabee—1. Not unless it is to get them finished up at the end of the honey-flow. 2. No.

G. M. Doolittle—1 and 2. I do not practice this, only in extreme cases, preferring the bait sections.

Rev. M. Mahin—1. I do not think it advisable; I see no advantage in it. 2. I would rather give bait sections.

Dr. A. B. Mason—1. If done to get the bees to work in the sections it is advisable and—2—is better than giving bait sections.

Eugene Secor—I have never tried this to any extent, but I am inclined to think it may be a good thing to start some balky colonies.

R. L. Taylor—1. No, unless time hangs heavy on your hands. 2. Nor with a good strain of bees are bait sections necessary.

E. France—1. It would stimulate the weak one some, but would likely discourage the other. I don't think I would do it. 2. Not much, if any.

C. H. Dibern—1. I do not think this plan advisable, and yet it is a good plan to equalize colonies. 2. I think a few bait sections of ½-depth cells are preferable.

J. E. Pond—1 and 2. It depends entirely upon circumstance; sometimes it is, in my own experience, and sometimes not. Experience is the only guide in the matter.

Dr. J. P. H. Brown—1. This is often advisable in order to get sections filled to remove them to a stronger colony for completion. 2. In some cases it may be better.

Dr. C. C. Miller—1. I can hardly think it was meant as an indiscriminate practice, and doubt its advisability only in cases where bees were slow to work in supers. 2. Hardly.

A. F. Brown—1. Under certain conditions, yes. 2. Yes, when and where you have such supers' to spare from other colonies. What I find equally as



good as a partly-filled super, is a single section-holder with its four sections well filled out, taking adhering bees and all, and putting in the center of the super.

J. A. Green—1. This is a very good way to get a backward colony started at work in the sections when all the conditions seem right except inclination. 2. Bait sections are less trouble when they do the business, but sometimes they do not.

Chas. Dadant & Son—1. Yes, if you wish to equalize and have everything filled. We have often given a light colony a good super to finish while we gave its nearly empty super to the other, and had both well filled; but this method is not always successful.

G. W. Demaree—1. No. 2. No. In my system of bee-keeping, one single partly-drawn comb is sure to start the bees; in fact, my bees always enter the sections without delay, if there is a good honey-flow, and nothing but foundation starters are really necessary.

HONEY and BEESWAX MARKET QUOTATIONS.

The following rules for grading honey were adopted by the North American Bee-Keepers' Association, and, so far as possible, quotations are made according to these rules:

FANCY.—All sections to be well filled; combs straight, of even thickness, and firmly attached to all four sides; both wood and comb unsoiled by travel-stain, or otherwise; all the cells sealed except the row of cells next the wood.

No. 1.—All sections well filled, but combs uneven or crooked, detached at the bottom, or with but few cells unsealed; both wood and comb unsoiled by travel-stain or otherwise.

In addition to this the honey is to be classified according to color, using the terms white, amber and dark. That is, there will be "fancy white," "No. 1 dark," etc.

Chicago, Ill., Nov. 18.—Fancy white, 12@13c.; No. 1, 10@11c.; fancy amber, 9@10c.; No. 1, 7@8c.; fancy dark, 9c.; No. 1, 7@8c. Extracted, white, 5@7c.; amber, 5@6c.; dark, 4½c. Beeswax, 26@27c.

Comb honey is selling very slowly.

Philadelphia, Pa., Nov. 7.—Fancy white comb, 13-14c.; No. 1 white, 11-12c.; fancy amber, 10-11c.; dark, 8-9c. Extracted, white, 6-8c.; amber, 4-5c.; dark, 3-4c. Beeswax, 26c.

Comb honey arriving freely and market overstocked at present.

Detroit, Mich., Nov. 7.—No. 1 white, 12-12½c.; fancy amber, 10-11c.; No. 1 amber, 9-10c.; fancy dark, 8-9c. Extracted, white, 5½-6c.; amber, 5-5½c.; dark, 4-5c. Beeswax, 24-25c.

Indianapolis, Ind., Nov. 7.—Fancy white, 14-15c.; No. 1 white, 12-13c. Extracted, white, 6-7c. Beeswax, 22-25c.

Demand is fair for grades quoted, but no demand for inferior grades.

New York, N. Y., Nov. 7.—Fancy white, 12c.; off grades, 10@11c.; buckwheat, 8@9c. No change in extracted. Beeswax firm at 26@27c.

The market is well supplied with comb honey of all grades and styles. Fancy white is in fair demand, while off grades white and buckwheat are moving off rather slowly.

Albany, N. Y., Nov. 7.—Fancy white, 12-13c.; No. 1, 11-12c.; fancy amber, 9-10c.; No. 1 dark, 8-9c. Extracted, white, 6-7c.; dark, 4-5c.

The receipts of both comb and extracted honey are very large, and prices are somewhat lower. We have an ample stock of all styles except paper cartons weighing less than a pound.

Boston, Mass., Nov. 6.—Fancy white, 13-14c.; No. 1, 11-12c. Extracted, white, 6-7c.; amber, 5-6c. Beeswax, 25c.

Cincinnati, Ohio, Nov. 7.—Comb honey, 10@14c., according to quality. Extracted, 3½@6c. Demand is slow for all kinds of honey, while the supply is good. Beeswax is in good demand at 20@25c. for good to choice yellow.

Milwaukee, Wis., Nov. 7.—Fancy white, 14-15c.; No. 1, 12-13c.; No. 1 amber, 8-10c. Extracted, white, 6-7c.; amber, 5-6c.; dark, 4-5c. Beeswax, 22-24c.

New crop of honey begins to come forward. The demand is very poor and quotations almost nominal. Weather is very warm and the consumption of honey is very small. Plenty of fruit, and hence the appetite is satisfied with same in preference. Later on we expect an improved demand for honey of all kinds.

Cleveland, Ohio, Nov. 7.—Fancy white, 14½@15c.; No. 1 white, 12½@13c. Extracted, white, 6@7c.; amber, 4½@5½c. Beeswax, 22@25c.

There is not very much honey in our market. Selling rather slow. Demand beginning to be a little better. Think trade will be fair in this line this fall.

St. Louis, Mo., Nov. 9.—Fancy white, 14c.; No. 1 white, 12@13c.; fancy amber, 11@12c.; No. 1 amber, 10@10½c.; fancy dark, 9@9½c.; No. 1 dark, 7@8c. Extracted, white, in cans, 6@7c.; in barrels, 5@5½c.; amber, 4½@4¾c.; dark, 3½@4c. Beeswax, 26½@27c.

Baker stock of extracted honey, 4@5c.; stock very scarce. Fair receipts of comb. Beeswax in good demand.

San Francisco, Calif., Nov. 7.—White comb, 10c.; amber, 7½-9c. Extracted, white, 5-5½c.; light amber, 4½-5c.; amber colored and candied, 3½-4½c.; dark tulle, 2½-3c. Beeswax, fair to choice, 25-27½c.

Minneapolis, Minn., Nov. 7.—Fancy white, 12½c.; No. 1 white, 10@11c.; fancy amber, 9@10c.; No. 1 amber, 8@9c.; fancy dark, 7@8c.; No. 1 dark, 6-8c. Extracted, white, 5½@6½c.; amber, 5@5½c.; dark, 4@5c. Beeswax, 23@26c.

The demand for both comb and extracted is very quiet, and for the latter, nominal. The hot weather of the past week or so has checked demand for comb honey.

Kansas City, Mo., Nov. 7.—Fancy white comb, 15c.; No. 1 white, 13@14c.; fancy amber, 12-13c.; No. 1 amber, 11-12c.; fancy dark, 10-11c.; No. 1, 8-10c. Extracted, white, 6-6½c.; amber, 5-5½c.; dark, 4-4½c. Beeswax, 22-25c.

Buffalo, N. Y., Nov. 7.—Strictly fancy comb, 1-pound, 12-13c.; fair to good, 9-10c.; dark, 7-8c.

Demand is much better for fancy, but common stock is very dull at any price.

Our Prices ARE WORTH LOOKING AT!

—IN THE— NEW CHAMPION CHAFF HIVE

especially. All other Supplies accordingly. Send for Catalog and Price-List. Address.

R. H. SCHMIDT & CO.,
48 Atf Box 187, SHEBOYGAN, WIS.

Mention the American Bee Journal.

Payne's Business Letter Writer



and Manual of Commercial Forms.

Containing specimen Letters on all possible business topics, with appropriate answers. Containing general information with regard to business matters, the rules for punctuation, the abbreviations most used in the mercantile world, a dictionary of mercantile terms, a table of synonyms, and other information which may be of value to the business man. New edition, revised and enlarged. 216 pages, Extra Cloth, 75 cts.

Special Offer: We will mail this book free sending us two New Subscribers to the Bee Journal for one year (with \$2.00), and also send a copy of the premium book "Bees and Honey" to each of the new subscribers; or we will club the book with the Bee Journal for a year—both for \$1.60.

List of Honey and Beeswax Dealers.

Most of whom Quote in this Journal.

Chicago, Ills.

R. A. BURNETT & Co., 163 South Water Street.

New York, N. Y.

HILDRETH BROS. & SEGELKEN,

Kansas City, Mo.

O. C. CLEMOMS & Co., 423 Walnut St.

Buffalo, N. Y.

BATTERSON & Co., 167 & 169 Scott St.

Hamilton, Ills.

CHAS. DADANT & SON.

Philadelphia, Pa.

WM. A. SELSER, 10 Vine St.

Cleveland, Ohio.

WILLIAMS BROS., 80 & 82 Broadway.

St. Louis, Mo.

WESTCOTT COM. CO., 213 Market St.

Minneapolis, Minn.

S. H. HALL & Co.

Milwaukee, Wis.

A. V. BISHOP & Co.

Boston, Mass.

E. E. BLAKE & Co., 57 Chatham Street.

Detroit, Mich.

M. H. HUNT, Bell Branch, Wayne Co., Mich.

Indianapolis, Ind.

WALTER S. POWDER, 162 Massachusetts Ave.

Albany, N. Y.

CHAS. MCCULLOCH & Co., 380 Broadway.

Cincinnati, Ohio.

C. F. MUTH & SON, cor. Freeman & Central avs.

Wanted

—To buy quantity lots of Fancy and No. 1 White Honey at prices to suit the times. B. WALKER, 45A Ewart, Mich.

WHEN ANSWERING THIS ADVERTISEMENT, MENTION THIS JOURNAL.

INFORMATION GOLD!

Worth Its Weight in

For your name and address on a postal card, we will tell you how to make the best wire fence on earth, horse-high, bull-strong and pig-tight, at the actual wholesale cost of wire. Kitzelman Bros., Box B, Ridgeville, Ind.

48 Etf Mention the American Bee Journal.

—WRITE—

Without Fail—enclosing a list of Supplies wanted, and get our prices on them, before placing your order.

5 to 10 per ct. Discount till Jan. 1st.

I. J. STRINGHAM,

105 Park Place. NEW YORK, N. Y.

APIARY—Glen Cove, L. I.

INCUBATION

is the first step in the poultry business and much of future success depends upon its completeness. There is no failure where RELIABLE INCUBATOR is used. It is fully warranted and is the product of twelve years of experience. It has never been beaten in a Show. It is not like its competitors—it is better. We tell why in new book on poultry. Send for it. RELIABLE INCUBATOR AND BROODER CO. QUINCY, ILLS.

36E17t Please mention the Bee Journal.

WANTED—To correspond with a lady who is interested in bees or poultry, with a view to a partnership. Address, Box 456, Greenwich, Washington Co., N. Y.

READERS Of this Journal who write to any of our advertisers, either in ordering, or asking about the Goods offered, will please state that they saw the Advertisement in this paper.

Bottom Prices

**BRING US BIG TRADE.
GOOD GOODS KEEP IT.**

If you want the best supplies that can be made at a little less cost than you can buy the same goods for elsewhere, write to us for low prices. 1896 Catalogue now ready—ask for it and a free copy of *The American Bee-Keeper* (36 pages).

Address,

**THE W. T. FALCONER MFG. CO.,
JAMESTOWN, N. Y.**

Mention the American Bee Journal.

Honey-Clovers & Buckwheat SEED FOR SALE.

We have made arrangements so that we can furnish seed of several of the Clovers and Japanese Buckwheat, by freight or express, at the following prices, cash with order:

	5lb	10lb	25lb	50lb
Alsike Clover.....	\$.70	\$1.25	\$3.00	\$ 5.75
Sweet Clover.....	.65	1.20	2.75	5.00
White Clover.....	1.25	2.00	4.50	8.00
Alfalfa Clover.....	.65	1.10	2.70	5.00
Crimson Clover....	.55	.90	2.00	3.50
Jap. Buckwheat...	.20	.35	.90	1.25

Prices subject to market changes.

Add 25 cents to your order, for cartage, if wanted by freight.

Your orders are solicited.

**GEORGE W. YORK & CO.,
CHICAGO, ILLS.**

BEGINNERS.

Beginners should have a copy of the *Amateur Bee-Keeper*, a 70-page book by Prof. J. W. Rouse. Price 25 cents; if sent by mail, 28c. The little book and the *Progressive Bee-Keeper* (a live, progressive 28-page monthly journal) one year, 65c. Address any first-class dealer, or

LEAHY MFG. CO., Higginsville, Mo.
WHEN ANSWERING THIS ADVERTISEMENT, MENTION THIS JOURNAL.

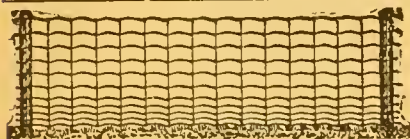

Behold, What a Fire a Little Spark Kindleth.

One little runty pig crawled through a rail fence from the highway, meandered up around the barn, sneaked through the gate and introduced **Hog Cholera** to the fattening herd. The resulting loss would have covered the cost of **pig-tight Page** fence for that whole farm. Are you protected?

PAGE WOVEN WIRE FENCE CO., Adrian, Mich.
Mention the American Bee Journal.

Special Renewal Offers!

Prompt renewals are so desirable that I am going to make some special offers. For \$1.00 I will send the *Bee-Keepers' Review* for 1897 and the 50c. book, "Advanced Bee-Culture," or, in place of the book, 12 back Nos. of the *Review*. For \$1.50 I will send the *Review* and a fine tested Italian Queen—Queen to be sent early in the season of 1897. For \$1.75, the *Review* and a \$1.10 Bingham (Conqueror) smoker, postpaid. For \$2.50, the *Review* and 1000 No. 1, first-class, one-piece Sections. But REMEMBER, that these offers will be withdrawn Jan. 1st, as the sole object in making them is to induce the sending in of subscriptions before that date. New subscribers will get the Dec. No. free. If not acquainted with the *Review*, send for samples.

W. Z. HUTCHINSON, FLINT, MICH.

Mention the American Bee Journal.

BEE SWAX WANTED

—FOR—

Foundation Making.

Send For OUR CATALOGUE,

SAMPLES OF FOUNDATION,

ADVICE TO BEGINNERS, Etc.

Address,

CHAS. DADANT & SON,

WHEN ANSWERING THIS ADVERTISEMENT, MENTION THIS JOURNAL.

HAMILTON, ILL.

Ask Your Friends to Take This Journal.

* Extracted Honey *



Finest Quality. Basswood and Clover.

2 60-lb. cans in case, 7c. per pound. 1 60-lb. can in case, 8c. per pound. A sample by mail, 10 cts. **POUDER'S Honey-Jars and Complete Line of Supplies.** Catalogue Free.

WALTER S. POUDER,
162 Mass. Avenue. INDIANAPOLIS, IND.

PATENT WIRED COMB FOUNDATION



Has No Sag in Brood-Frames

Thin Flat-Bottom Foundation

Has No Fishbone in the Surplus Honey.

Being the cleanest is usually worked the quickest of any Foundation made

J. VAN DEUSEN & SONS,
Sole Manufacturers,
Sprout Brook Montgomery Co., N. Y.

A LARGE BOOK FREE.

To every new subscriber who sends us \$1.00, we will send him our journal—

Gleanings in Bee-Culture,

one year, and the book by A. I. Root, containing 190 pages, size 6¼x9½, entitled

What to Do, and How to be Happy while Doing It,

postpaid. The regular price of this work is 50 cents alone.

If you prefer, the journal may be sent to a friend, and you can keep the book for yourself.

**THE A. I. ROOT COMPANY,
MEDINA, OHIO.**

AMERICAN BEE JOURNAL

DEVOTED EXCLUSIVELY TO THE INTERESTS OF HONEY-PRODUCERS

ESTABLISHED 1861
THE OLDEST BEE-PAPER IN AMERICA

Published Weekly, at \$1.00 per annum.

Sample Copy sent on Application.

36th Year.

CHICAGO, ILL., DECEMBER 17, 1896.

No. 51.

BIOGRAPHICAL

REV. M. MAHIN, D. D.

The subject of this sketch was born in Greene county, Ohio, Oct. 22, 1824. In the fall of 1828 his parents left Ohio and settled in the northern edge of Tippecanoe county, Ind., on the border of the Grand Prairie. At that time the land had not been surveyed, and was not in market.

In that new country Mr. Mahin spent the next 13 years of his life, with only such facilities for education as so new a country afforded. His parents were members of the Methodist Episcopal church, and in 1839 he became a member of the same church; and on Aug. 20, 1841, when he lacked two months of being 17 years old, he was given a license to preach, and recommended to the annual conference "as a suitable person to be admitted on trial in the traveling connection." On Oct. 12, following, he was admitted and appointed to a circuit—the youngest man, so far as he knows, ever admitted into an annual conference of the Methodist Episcopal church. Two years afterward, on his 19th birthday, he was ordained a deacon—the youngest man on whose head a Methodist bishop ever laid his hands, officially.

Dr. M.'s education was obtained almost exclusively without teachers, and by private study. He has filled the office of Presiding Elder nearly 11 years, and occupied some of the best pulpits in his conference. After delivering a lecture, or thesis, before the faculty and students of Indiana Asbury University (now De Pauw), in 1876, that institution conferred upon him the degree of Doctor of Divinity.

For eight consecutive years Dr. Mahin was Secretary of his conference, and would have been longer if he had not been put into the presiding eldership. In 1868, he was a member of the General Conference of his church.

After 54 years of active official duty in the ministry, he has retired from the pastorate, and sustains what is called the "superannuated relation." But as a superannuate, he continues to preach about as much as ever.

Dr. Mahin became interested in bees in his early boyhood, but never kept them, except for a very short time, until 1870, when a friend gave him a colony in a box-hive. These he transferred to a movable-comb hive of his own make, which, with modifications, is the style of hive he has used ever since.

He thinks 51 is the largest number of colonies he has ever had at one time, and now has only 12.

For nine years up to one year ago last spring, he was away from his own home where his bees were kept, and could not attend to them, and the apiary nearly run out. The last two seasons have been so very poor that he has had no increase, and had to feed his bees to winter them.

In 1843 he married Miss Eliza Dorsey, of Dearborn county, Ind., and they have now lived together 53 years.

Dr. Mahin is well known to our readers, as one of the corps who reply to questions in our "Question-Box" department. In 1893, we endeavored to picture all of them, and we believe, with one exception, we succeeded in doing so. Dr. Mahin was the only one we did not get at that time.



Rev. M. Mahin, D. D., Newcastle, Ind.

We express only the sincere wish of all our readers when we say that we trust that Dr. Mahin and his good wife may be spared yet many years to bless the world, and at last have an abundant entrance into that eternal Home not made with hands.

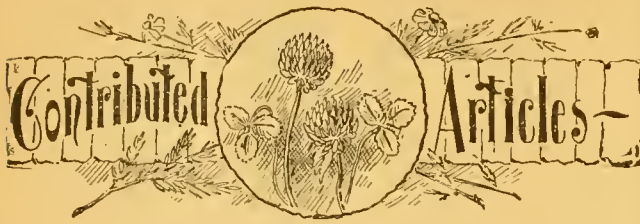

COMB HONEY IN THE SOUTH.

To Southern Bee-Keepers—Especially Those of Florida.

BY A. F. BROWN.

Why not produce more comb honey instead of so much cheap extracted honey? Nine-tenths, if not ninety-nine one-hundredths, of all the surplus marketable honey from the South is "liquid" or "extracted honey." This, for the past three years or more, has been selling at not far from 45 to 55 cents per gallon (of 11½ to 12 pounds weight) in the Northern markets—New York, Boston, Albany, and other places. From this price must come commission, freight, drayage and leakage, also the first cost of the cans or barrels, and the producer gets not far from "three cents" per pound, or even less. When we come to sum it down to this, the question arises, Are we as producers handling the products of our apiaries to the best advantage to get the most money out of them? Can we not secure more money out of our gross crop if harvested in comb honey instead of in the liquid shape?

During the past three years good quality comb honey has brought 12 to 16 cents per pound gross. The same quality of honey I sold in the extracted shape at 4½ and 5 cents, brought 14 cents in the comb, by the same house, and during the same time.

I have produced quite a few tons of choice extracted honey, and have also bought and sold a good deal for my neighbors. I have also produced several tons of comb honey—about 18,000 pounds—and from my experience I am led to believe that we (those among us who have any size apiaries, and profess to give the business the attention it requires) are losing money in not producing more comb honey and less cheap extracted honey.

My comb honey was sold principally in New York, Boston and Albany—all Northern cities—and it brought the price of Northern clover and basswood honey selling there at that time. The comb honey was from orange, palmetto, and mangrove, grading light amber to white. The ratio of yield compared to colonies run for extracted honey averaged 70 to 80 per cent. in number of pounds.

My sections hold 12 to 14 ounces gross, a portion being 4¼x4¼x7-to-the-foot, and a portion 3⅝x5x1½ inches; this latter size—"New Prize"—I like the best, as about 25 per cent. more can be arranged over a given size brood-nest. Most of my comb honey was produced over an 8-frame (comb space) size brood-nest, colonies occupying two stories until the honey-flow, when the queens were confined to the lower story, the upper one removed, and sections given.

I used full sheets of comb foundation with a bottom starter ½ inch wide, there being about ¼ inch space between the large starter above and small one below, to allow for stretching. Thin wood separators were used between all sections, and the cases were tiered as fast as an individual colony required, the first being raised when half or two-thirds filled, the second not until the first was filled, and second half-full or more. I found more erring in giving room too fast than not fast enough. The grade of foundation used in sections was 10 square feet to the pound.

I removed most of my comb honey by means of the Porter escape, which saves a vast amount of work in brushing and smoking, and the gnawing open of many cells of honey, when the honey is sealed solid out to the wood.

I crated my honey in 24 and 30 section single-tier shipping-cases; also some in the 6 box "D" cases. Eight large crates, or 32 of the 6 box ones, were crated in a large carrier, having 2 inches of straw in the bottom, and handles projecting 6 inches at each end near the top. This insured practically no loss from breakage and leakage; also the disfigurement by dirt of the small cases. My loss in the way of breakage and leakage in transit was less than one-half of one per cent. A portion of my crop was put in the single-comb paste-board cartons, but I found no advantage in their use. Nice, clean, 24-pound shipping-cases, glass on one side, these crated 8 to the carrier, give the best results.

In 1893 my bees swarmed a great deal; in 1894 quite to the contrary, when I produced 10,000 pounds of comb honey and 42,000 pounds of extracted—26 tons in all. In 1895 my apiaries were entirely annihilated by the ravages of foul brood, or, more properly, I should say, I annihilated them. The big freeze and blizzard of February, 1895, destroyed a vast amount of brood, sealed and unsealed, in many apiaries through Florida. Until the following few months after that time we knew nothing of foul brood in my section—east and middle Florida. I did not discover the disease in my apiary until August, being sick in bed four months with billious fever during the summer. My remedy was severe but sure—I burned everything, and commenced anew, with new hives, fixtures, and everything in a new location. Other apiaries in this State are badly infested, and in some cases were totally destroyed the same year, others this year.

In putting in a couple of extensive new apiaries the past year, I have profited by my past experience with comb honey, and am putting in a large number of hives carrying a frame the same depth as the standard Simplicity, but a few inches shorter; in size it is 9⅝x14¼, top-bar 16 inches, 10 of these frames in a case, which gives a little more comb space than the regular 8-frame hive, and in much better shape for comb-honey production. This frame also fits the standard make of extractors scattered throughout the country—an item worthy of consideration.

The size of section used on this hive is the "New Prize"—3⅝x5x1½ inches, open top and bottom full width, and it is the best size and shape section made to-day, in my estimation. I made my new hive in length of frame to accommodate this size section. The sections are adjusted in cases, in section-holders, 8 in number, giving 32 sections in a case over a 10-frame brood-nest.

I have tested these "short-cut" hives alongside of regular 8 and 10 frame (Simplicity frame) Dovetail hives during an average season, and in my locality, and with my management, the "short cut" hives are far ahead in the production of comb honey. If one is to produce nothing but extracted honey, I know of no better hive than the standard 10-frame Dovetail, tiered two or three stories, as occasion and colonies require. But for comb honey they do not afford the requisite comb space for breeding in the best shape for the adjustment of sections. Reduce the length of frames two or three inches, and one has an "ideal" comb-honey hive.

But this is not the point I wished discussed. What I want you all to consider is, Are you, or are you not, working to the best advantage in producing extracted instead of comb honey? I have given you a chapter from my experience, and told you what I have done, and am doing, in putting in my new apiaries.

I have made honey-production my exclusive business for eight years—previous to then a side-issue for two or three years, and in the production, handling and selling of tons of honey in this State I have acquired some of the first principles and requisitions that come from long experience. I do not profess to advise you what is best for your case, but I tell what I have found best for my needs, in my locality.

Putnam Co., Fla.



The Importation of Apis Dorsata Discouraged.

BY J. A. GREEN.

The idea of inducing our Government to send an expedition to India to bring to our shores the "giant bee"—*Apis dorsata*—is a very attractive one to many bee-keepers. They argue, with much reason, that it is the province of the Government to search out, import and make available whatever of the fauna and flora of other countries may prove valuable additions to our own. There are others who say that as long as the Government is wasting money in various other directions, we might as well have our share, with a chance of getting some benefit from it.

That the first view of the case is largely correct can hardly be denied. Various instances may be given where governmental aid in these directions has been productive of much good. True, there are some instances, such as the introduction of the English sparrow, which have resulted disastrously, and the amount of money that has been squandered in abortive attempts of the kind will probably never be known.

The "free seed distribution" of the Agricultural Department is one of the most gigantic farces ever perpetrated upon a suffering public, though in the abstract the principles on which it is based are all right and proper.

Our own experience with the "Chapman honey-plant" has inclined me to be a little chary about asking the Govern-

ment for doubtful though expensive favors. I do not now remember what the Agricultural Department paid for the stock of this seed, but, with the expense of distributing, it amounted to a considerable sum, which, I believe, to have been wholly wasted. Who is there, now, that raises the Chapman plant for honey? Yet a committee of our own selection investigated this and supposed it to be valuable.

What do we know about *Apis dorsata* that should make us anxious to have it brought to this country? The sole thing in its favor seems to be that it is a larger bee. It is hoped that because of this it would be able to get the honey from red clover. This one point—and that a problematical one—is really the only thing in its favor. Of course, there might be some other flowers from which it could get honey not accessible to the ordinary hive-bee, but it is improbable that such exist in sufficient quantity to amount to anything. Any such advantage would doubtless be counterbalanced by a failure to work on flowers that are made use of by the smaller bee.

We are told in many localities the culture of red clover is being given up, owing to insect enemies. In some other places Alsike and crimson clover are being found more profitable, while, wherever it will thrive, alfalfa seems to yield much better returns. All these yield their honey freely to the hive-bee, so that the amount of honey going to waste in red clover need not cause any great regret.

We may dismiss with a word any supposed advantage from greater strength and increased power of flight. There is no analogy throughout Nature for supposing that there could be any ultimate gain through these qualities. It is more than probable that any gain in these respects would be more than counterbalanced by the greater consumption of stores.

One of the things most to be dreaded lies in their increased size. It is probable that, as in the case of some of the hornets, an increase of size means an increase of stinging power. If this should happen to be joined to a choleric disposition, we might have great reason to regret the day that brought this savage to our shores. Travelers tell some terrific stories of the temper and stinging powers of some of the tropical bees.

Apis dorsata builds a single comb, in the open air. It has never been domesticated, and I believe there is no evidence to show that it has ever been found in hollow trees or rocks. It is migratory in its habits, deserting its habitation entirely at certain seasons and going elsewhere. Manifestly it is improbable that such an insect is fit for domestication, or can be made of any value in a property sense. It might possibly maintain an existence in a wild state in some parts of the South, but it would seem that the benefit arising from this, under the most favorable circumstances, would hardly pay the cost.

In my opinion, there are other varieties of bees in India and China more deserving of investigation and importation than *Apis dorsata*. It also seems to me that the most practical way to investigate the subject, and learn if any of these bees would be likely to be of any value, would be to enlist the services of some of the missionaries of those countries. Doubtless among them could be found those who would take an interest in the subject, and, being on the ground, would be capable of determining at comparatively small expense whether these bees would be worth introducing into our country.

We could much better afford to subsidize to any necessary extent than to send an expedition there for that purpose. A special expedition would be expensive, and until I can see more definite results to be gained, I shall not ask the Government to send one—unless I could be sure that I would be the one selected to go!

La Salle Co., Ill.



Spreading the Wonderful Sweet Clover.

MRS. A. L. AMOS.

I do not write of this wonderful honey-plant just to be "in the swim," as they say, but because I was impressed, while at the Lincoln convention, with the thought that there was no other subject in which more interest was manifested. It seems to me then that two classes included most of us, namely, those who had sweet clover and recognized in it a honey-plant without a peer—at least for the West—and those who had not, but were awaking to its importance, and were eager to know how to get a start in growing it. It is to this latter class that I would like to be permitted to say a few words, for I have been spreading sweet clover very successfully, and at no great outlay in cash—that article being rather scarce, I gave as a substitute *time and energy*.

My attention was first directed to sweet clover as it grew in my father-in-law's garden, the first summer I kept bees—four years ago. The bees revelled in it, and I greatly ad-

mired its magnificent growth and thrifty appearance, but I was far from realizing its full value or the possibilities it opened up to me. It had been brought there originally as a sweet-smelling garden-flower, by one of the daughters of the house some years before, and, as is the way with sweet clover, it had over-stepped the bounds allotted to it. On that account the folks had been fighting it for several years, but, fortunately for me, without a knowledge of its nature or how best to cope with it. It is still there, and they no longer talk of extermination, but actually think of planting a field or two since it has established its merit as a forage plant.

Three years ago I bought a few pounds of seed from an Illinois bee-keeper. It bloomed this summer for the first time, but I believe Mr. Amos has nearly ruined it. There were some sunflowers in the field, and he cut it to kill them just as the earliest of the seed was beginning to ripen. He cut so low that it *never branched again*. I will scatter more seed there to make sure of a stand next year.

The *woody stalk* that people complain of when it is cut for hay, is the plant's only protection. While our cattle eat it greedily wherever they get a chance, they seldom take it so close as to prevent its branching out again. Its woody stalk saves it from utter destruction. They crop it repeatedly, and as often it comes again. Cut close, and it is gone. So much for my field of sweet clover.

What I have started in nooks and corners, being left in Nature's hands, has not suffered save where the stock had access to it. There it has benefitted the cattle and horses at the expense of the bees. For bee-forage there is no use of putting it on land to be used for *early pasturage*. The beautiful, vivid green in sharp contrast with surroundings entices stock, and, from rabbits to horses, the animals find in it toothsome bites at a time when such are scarce.

But I was going to tell the fraternity how I spread it, for, unfortunately, we don't all have "graveled beds" patronized for the public highways!

I have seen nothing in regard to transplanting sweet clover, but I have done considerable of that for two seasons now, and with excellent results. I regard it as a surer and quicker way of starting the clover in little out-of-the-way spots, than simply scattering the seed. Of course, for a field it would be too large a job.

I take the plants in the spring, as soon as the ground is thawed enough to spade them out. I get them where they are growing altogether too thickly for the best development of which they are capable, and put them where they have room to grow. Starting out with my basket of plants, along a chosen route, I keep sticking one in here and there as I go. I find that they never disappoint me, but bloom and scatter their seeds. The plants left behind also do better than if none had been taken, as they have more room.

I have also a way of my own of gathering seed in the spring. Of course, what was not secured in the fall is down on the ground around the old plants, and may be scooped up with spade or shovel and scattered elsewhere.

These methods grew originally out of hard times and slender resources, but the transplanting, at least, I would practice in any case, because of the excellent results obtained from a few hours' work.

I was looking, the other day, where some of my spring-set plants had bloomed, and I see they have self-appointed successors. I can usually find two or three plants where the seed that was first to fall has sprouted, though the great mass of it will not start until it has had the winter frost and snow, and the spring sunshine.

I feel very hopeful of this as a honey region since I have made acquaintance with "sweet clover." Like the "Star-spangled banner"—"Long may it wave!"

Custer Co., Nebr., Oct. 29.



Rearing Drones with No Drone-Comb.

BY E. R. JONES.

"Without drone-comb no drones can be reared."—Dr. Miller, on page 713.

As I seldom write an article for publication, I feel a timidity in bringing in question the truthfulness of the above statement, as it is likely to make me appear before the bee-keeping fraternity as a worthless dog baying at a lofty mastiff. But Judge E. Y. Terrell said at the meeting of the Central Texas Bee-keepers' Association, "Bee-keepers are the worst critics on earth, and the bee-keeper who puts himself on record as saying thus or so had better *know* that he is not mistaken, or some one will 'take him up' as soon as he 'shoots off his mouth.'"

I read several of the bee-papers in order to learn from others all I can of the facts and true theories connected with practical bee-keeping, and I think that most bee-keepers read the papers for the same purpose. This fact has a tendency to overcome my timidity with a sense of duty. Theories that will not stand the test of the practical apiarist will not do to depend upon. I will submit a few facts as they have presented themselves to me in eight years' experience with bees.

Four years ago, on opening a colony of bees about swarming-time, I noticed some very small, inferior-looking drones. At first I wondered at it, for I was very sure that that colony had no drone-comb in it; yet the presence of drones aroused my curiosity, and I examined the combs to see if I was mistaken. But no; there was not even a drone-cell that I could find. I concluded that they must have come from some other colony, but I did not understand why they were no larger than workers.

Again, last year I filled several hives with full sheets of foundation, wired in, and transferred colonies from box-hives into them, *a la* Heddon. There was a moderate honey-flow at the time. In about a week I put on the supers, and about a week after that I looked through the brood-chamber, and two of the colonies had appropriated a piece of foundation about three inches square in the corner of one frame upon which to build drone-cells. They did not change the size of the cells at the base, but inclined them from the center so as to make the cells larger at the outer end. Every impression on the foundation had a cell erected from it, except possibly a few where the inclined flared cells met the perfect worker-cells. These inclined and flared cells had larvæ in them that hatched out drones. I feared that they might spoil more of my intended nice worker-combs, so I gave them a full frame each of drone-comb; they accepted it, and as soon as the brood hatched from the inclined and flared cells they worked them over into worker-cells.

Once more: About the middle of September we had a series of rains which revived the fall flowers, and set the bees to storing honey, and also to brood-rearing. Many of the colonies would have swarmed had I not prevented it. One colony in particular outstripped all the others in storing honey and rearing brood. This colony was occupying eight frames of well-drawn comb, built on full sheets of foundation, wired in.

While looking through the colony I discovered small patches and scattering cells of brood with highly-raised caps, or "buck-shot caps," as some would call it. I was satisfied that it was drone-brood, but through curiosity and inquisitiveness I sat down with the frame in my hands and watched it for some minutes; presently I observed that the cap from one of these buck-shot capped cells was being cut off by its inmate; I watched it with interest until the cap was cut off, and the prisoner emerged, and he was a drone, a trifle longer than a newly-hatched worker. While I was watching his awkward motions, I discovered the cap being cut from another of these high-topped cells, and when he came out he was a drone.

To stop any swarming, I took one frame and gave to a weak colony, and another which had, I guess, about 100 high-topped cells on it, and put it into an observatory hive. The next day I noticed the cap being cut from one of these high-topped cells, and a drone hatched from it. The other cells hatched in course of time, and in a week there was quite a number of these dwarf drones in my observatory hive.

The colony from which these were taken has lots of these dwarfs in it now, if they have not been killed off within the last week. We have had a cold snap, and they have likely disposed of their drones. The cells from which these dwarfs hatched were in no way enlarged except the caps were raised. This colony is the progeny of a queen whose mother was a cross-mated Carniolan, and I will put them against anything in the county to fight.

Had the Doctor admitted in the least degree the possibility of bees rearing drones without drone-comb, I would never have taken issue with him.

Milan Co., Tex.

Honey as Food and Medicine.—A new and revised edition of this 32-page pamphlet is now issued. It has 5 blank pages on which to write or paste recipes taken from other sources. It is just what its name indicates, and should be liberally distributed among the people everywhere to create a demand for honey. It contains a number of recipes on the use of honey as food and as medicine, besides much other interesting and valuable information. Prices, postpaid, are: Single copy, 5 cts.; 25 copies 75 cts.; 50 for \$1.10; 100 for \$1.50. Better give them a trial. Send all orders to the Bee Journal office.

CONVENTION PROCEEDINGS

Proceedings of the Illinois State Bee-Keepers' Convention Held in Chicago, Nov. 18 and 19, 1896.

BY A SPECIAL BEE JOURNAL REPORTER.

[Continued from page 786.]

PROSPECT FOR FUTURE SEASONS.

Ques. 2.—What is the general prospect for future seasons?

Dr. Miller—Now, I suppose that means to bring up the question that has been more or less discussed within, perhaps, the last year or two. You know a good many say we are never to expect good seasons any more—that is all past—and there is some reason for it, we may not know why, but we know that is the rule, and we are not to expect as good years as the past. Are conditions so changed that we can expect no good season any more, or may we expect them to come back again? Now, what is your answer to that? The one who knows all about it rise and tell us first.

Mr. York—What about the present season? Here it has been very good. We don't care for any better.

Dr. Miller—The main point is this, as to seasons in general for the future. For instance, say the next 10 years. Have we a right to expect that the next 10 years will be as good as the last 10 years, or not?

Mr. York—Here is Mr. Schrier, who has had good seasons for the last 10 years and expects them to continue. I don't see how we can answer that question. We cannot tell what the seasons were somewhere else this year. They may have been good or bad. I don't see how we can independently answer the question except for our own individual locality.

Dr. Miller—Tell us what the prospect is in your locality?

Mr. York—First rate. Good this year, and good last year.

Dr. Miller—I think, as a rule, the seasons of the last 10 years, take it all over the country, have not been as good as those of the preceding 10 years. Are we to expect the next 10 years to average as poor as the past 10 years, commencing with 1886? or may we expect them as good as they were from 1876 to 1886? or what are we to expect?

Mr. Chapman—That might be a good question to ask the weather man. I have been in the habit of going to the Kankakee river bottoms for the last 10 years. For 10 years they have had scarcely any water, but this year the river overflowed, and the honey-producers got very much honey. I think if we have plenty of moisture, we will have as much honey as we had 10 years ago. It is a question of moisture, in my mind.

Mr. West—Largely so; and still there is little credit due to basswood.

Mr. Chapman—Isn't there anything to take the place of the basswood?

Mr. West—White clover has been our main stay. I think the sweet clover is taking the place of the basswood, so I see no reason why it should not be as good, with the exception of the water.

Dr. Miller—Are the sources from which we formerly had honey cut off? In places where basswood has been the principal supply, if basswood was cut down, we know chances are poorer; and one of the things that is brought up a good deal is that cultivation has taken away the source. Now, has cultivation taken away the source in your locality? That is the question. How many of you think that cultivation—I will put a pretty long range—how many of you think that cultivation has made the resources less at the present than they were 15 years ago? Let me see the hands. By having the plants cut off?

Two hands up.

Dr. Miller—Tell us what has been cut off, Mr. Schaper?

Mr. Schaper—We used to have more basswood timber around our neighborhood than we have to-day. We had a broom-handle factory there, some 15 or 20 years ago, and they used to buy the basswood to saw up and make broom-handles. That took quite a lot of it.

Dr. Miller—Now here is Mr. Schaper and Mr. West that say the basswood is cut off. That makes it a clear case. Now, has cultivation cut off anything else besides basswood?

Mr. West—I don't think it has.

Dr. Miller—I think too much is made of that. I think cultivation and civilization is bringing in about as many new things as it is cutting off old ones. I don't see, in my place, why I cannot see as many things growing for the bees to-day.

Mr. McKenzie—25 years ago we didn't have any Alsike clover.

Dr. Miller—Shall we take that, then, as pretty safe ground? None of you know exactly what the prospect will be in the future, but that, excepting where basswood has been cut off, in this region we may count about as safely on good crops in the future as in the past. It may be that next year will be a very poor year. We don't know, and we didn't know in the past. It seems to me that from the reports this morning, so far as white clover is concerned, the prospects for next year are good. In my place there is a mat of white clover on the ground as thick as I ever saw it before. I noticed only yesterday, out in the pasture where it is eaten down very short, it is just a thick mat. I cannot tell where the white clover came from this year; it was poor last year, and when it came time for blooming this year, there was plenty of it.

Mr. Baldrige—There is another point to be considered. Where the Doctor lives dairying has been on the increase for several years, and there is more pasturage than there used to be 10 years ago. I think that will be a good offset for any loss of the basswood being cut off where we live. Let me add, a great many of the farmers have discovered that Alsike is a wonderful plant, not only for bees, but pasture, and they have taken to sowing it without being coaxed to do so. One farmer near me has nearly 200 acres sowed to Alsike. He was induced to commence with Alsike by a seed firm here in Chicago. They had a mixture of timothy seed and Alsike, and wanted to try it, and he has been so pleased that he seeds every acre of ground now with Alsike, in part. He mixes it.

Dr. Miller—That suggests that one thing that we need to do is not so much to talk about the value of Alsike and sweet clover as honey-plants, as it is to talk about their value as forage-plants.

Mr. Schrier—The Alsike is the best clover to feed, because the cattle know where it is, and they go right for it.

HOFFMAN FRAME TONGUE VS. SAW-KERF.

Ques. 3.—What are the merits of the narrow tongue on the underside of the Hoffman frame, over the saw-kerf?

Dr. Miller—The underside comes down like a tongue, and the foundation is pressed on, or it comes perhaps to a point, and the foundation is pressed hard against the side, and fastened upon it, and now, the question, as I understand, is, what are the merits of this system over the plan of having the bottom of the top-bar flat with a saw-kerf in, for pushing the foundation into it? If some of you have had experience with both of them, perhaps you will tell us about that. How many have used the saw-kerf to thrust in the foundation.

Five hands.

Dr. Miller—And how many have had experience with the tongue?

Four hands.

Dr. Miller—Now, then, all those that have used both. There are only a few who have used both. Briefly state to us your preference and why.

Mr. Baldrige—Yes, I have used both, and I won't use either.

Dr. Miller—Before you go to that, tell us which you would prefer if you had to use either.

Mr. Baldrige—I wouldn't have any objection to the tongue, that I know of. It takes up room that is unnecessary. I would rather have a flat top-bar.

Mr. McKenzie—My objection to the tongue is, you cannot make the wax stick on good without having a warm room to put it in, or the warm time of the year or day. Now, all bee-keepers are not multi-millionaires who can have a warm house. I fix mine in the winter time, and I cannot manipulate the wax in a cold room.

Mr. Schrier—I find in the saw-kerf I can get it more satisfactorily than in any other. If you don't work carefully you have your points all one-sided.

Dr. Miller—There are three points of advantage for the saw-kerf. It saves room, it can be used in the cold as well as in the heat, and the saw-kerf leaves the foundation exactly in the middle.

Mr. Baldrige—If you are going to use the saw-kerf you are going to dispense with wires.

Mr. McKenzie—No, sir; I don't use wires.

Dr. Miller—Your plan would be to use the wire, and

simply have the flat top-bar? You have to have a little more foundation to use the saw-kerf. I think Mr. Baldrige's plan is the way they recommend at Medina—simply have the wires, and let the bees fasten to the top-bar.

Mr. Baldrige—They use horizontal wire, but I wouldn't use that. I use perpendicular wires. I don't fasten my foundation at the top. It is not necessary if the wires are perpendicular wires and cut true. The bees will fasten the top first. I don't see why anybody, especially for brood-combs, should advocate having them built without wires. A little girl 12 years old can put in the foundation for 15 to 25 cents a hundred, and they are there for years and years, no matter what you want to do with them. No matter how hot it is in the sun the combs don't melt down.

Dr. Miller—I can give you a little objection to wires, and that is, that when you have allowed a comb to be badly used, when it gets old, and perhaps a piece taken out, there will be a wire sticking out. Of course, you good bee-keepers would not do that (!), but there are these wires sprawling around, running into the next comb, and then there will sometimes be a queen-cell that I will want to save, and that wire is in my way. Of course I can cut through it, but I spoil my knife.

Mr. Baldrige—With regard to the wire breaking loose at the bottom, my combs are built as firmly to the bottom as to the top, and I secure them by having them built "up-stairs."

Dr. Miller—Still, if the mice gnaw them away at the bottom sometimes they will be loose.

The convention then adjourned to meet at 2 p.m.

AFTERNOON SESSION—Nov. 18.

The first question read by Pres. Miller was the following:

REARING QUEENS IN UPPER STORIES.

Ques. 4.—Is it a general practice among bee-keepers to rear queens in supers, as Doolittle teaches? What objections are there?

Dr. Miller—I suppose you understand that the practice spoken of is rearing bees in upper stories, the idea being that when bees are more distant, the distance itself from the brood-nest will make bees incline to rear queens, and the question is, Is it a general practice among bee-keepers?

For instance, here in the lower story is a queen laying, and then you rear a queen in the upper story (either by a queen-excluder or any other means), while the queen is still laying in the lower story. Let me see the hands of those who have practiced this? Three who have practiced it. Then the first answer (I take this to be a representative gathering of bee-keepers) would be that it is not the general practice. Only three I think out of the number here. The next question, What objections are there to it? Those who have practiced it, what are the objections? Miss Candler, will you tell us?

Miss Candler—I did it only one summer, as an experiment.

Dr. Miller—Did you find any objection to it then?

Miss Candler—No, I did not.

Mr. Green—My experience would come under the "more or less," because I have reared only queen-cells. I reared quite a number of queen-cells that way, and they are good ones, but I consider it more trouble than other methods, so I didn't practice it to any extent.

Dr. Miller—I had a queen (I don't remember whether in an 8 or 10 frame hive), and I had a number of combs that I wanted taken care of to keep the worms out of them, and I piled them up four or five stories high, so that the bees would have a chance to take care of those combs above them. To go back a little—in fact, back a good many years—two years that I lived in Chicago and kept bees 65 miles away. One time when I was leaving home for about two weeks I piled up a number of combs over the hives in that way to be taken care of by the bees. When I got home most of these were a solid mass of worms. I had only a small hole for the bees to go up, and the bees just kept it comfortable for the moths. I thought I would have the bees take care of the combs this time, whether they would or not, so I put a frame of brood in the upper story. I knew that the bees would not fail to go back and forth and look over the whole ground then, and I left them standing in that way, and if they wanted to put any honey in there for extracting, all right; and possibly two months later I looked in the upper story and I was surprised to find that there were several frames of brood there; there was a leak in the upper story, and they had reared a young queen, and there was a separate colony up there, no queen-excluder or anything. I left it there until late in the season, and I had my two colonies. Well, that is the beginning, so far as I know, of any record made of that plan of rearing queens. Then, afterward, I accidentally found queens rear-

ing when I had put a story of frames over a story of empty frames with one of brood and a cloth between. Now, with a queen-excluder they will sometimes rear as well as above and sometimes they won't. I lately read of a man who found they wouldn't rear queens with one excluder, but they did if he used two. Sometimes they rear cells all right, and sometimes they won't. When one is working for extracted honey, I am not sure but what it is a good plan.

Mr. Green—You cannot be sure that you are getting a batch of cells.

Dr. Miller—If you have a pile of combs there, and don't care very much whether they increase or not, it is a nice thing to put a frame of brood there. It is that much better than starting a new place. These bees are here in the upper stories—they are working and doing just as much as if you hadn't made them start cells, so, under certain circumstances, I think it is a pretty good plan. I suppose that is the main objection, you don't know what result you are going to have of it. If you want to rear queens and be sure, you had better take some other way.

(To be continued.)



Los Angeles County, Calif., Convention.

BY GEO. W. BRODBECK.

The third annual session of the Los Angeles County Bee-Keepers' Association was held in Los Angeles, Nov. 14, 1896. The annual election of officers resulted in the unanimous selection of the following:

President, James Jaynes, of Fernando; 1st and 2nd Vice-Presidents, G. S. Stubblefield and N. S. Levering, both of Los Angeles; Treasurer, Chas. Bergk, of Santa Monica; and Secretary, Geo. W. Brodbeck, of Los Angeles. The elective members of the Executive Board were, Elon Hart, of Pasadena, and J. H. Martin, of Los Angeles.

COMB HONEY.—The subject of comb honey, as presented by Mr. Stubblefield, advocated the use of separators, zinc honey-boards, scraping of sections, proper grading before packing, $1\frac{1}{2} \times 4\frac{1}{4} \times 4\frac{1}{4}$ sections, 8-frame Langstroth hives; and the best time to sell is just as soon as you can get your honey in shape to do so.

MOVING BEES.—The Secretary gave a talk on moving bees, advising proper packing of frames, plenty of surplus room for the bees, wire screen on top and at the entrance, moving at any time, day or night, during the fall and winter; in the spring and summer, when there is much brood he prefers to moving at night, and if necessary to move during the day, he suggested protection from the sun, and a supply of water by sprinkling; the use of a wagon with springs, and that would hold from 50 to 100 hives. After two years' trial, he prefers the Hoffman frame.

SMALL PACKAGES.—Mr. J. H. Martin gave the various improvements, beginning at the 12-pound boxes, next the 5 and 3 pound, with tin corners and glass sides, then the Harbinson 2-pound, resulting in such a furor for California honey that it reigned supreme for many years, selling at 20 to 25 cents per pound. He believes the extractor has been of more benefit to the glucose manufacturer than to the bee-keepers, for in the absence of the extractor there would be no glucosed honey; production would also have been limited, and as a result prices would have been better. The way out of our present trouble is by legislation, co-operation and improvements in packages. He said that the bees will store more honey in two-pound sections than in the one-pound, is merely an opinion or prejudice; but this we do know, that it will not do to use a much smaller section, and as a result we have reached perfection in the comb honey package. We have no uniform or special package for extracted honey, but he regards the Muth jar as the nearest, and that we need popular packages in connection with this product as much as for comb honey.

PLANTING FOR BEE-FORAGE.—Mr. N. Levering urged the importance of paying more attention to planting for bee-forage, and to this end presented a resolution calling the attention of our State Association to this subject.

Mr. Myers—one of the early pioneers in the bee-industry of this State, and co-worker with Mr. Harbinson—gave an interesting talk on the early experiences and methods of bee-keepers, which closed one of the most interesting sessions ever held by this Association.

GEO. W. BRODBECK, Sec.



Now is the Time to work for new subscribers. Why not take advantage of the offer made on page 810?

Questions AND Answers

CONDUCTED BY

DR. C. C. MILLER, MARENGO, ILL.

[Questions may be mailed to the Bee Journal, or to Dr. Miller direct.]

Are Wild Parsnips Poisonous? — Partly-Filled Sections.

1. S. B. Smith says on page 772, "The root of what is known as 'wild parsnip' is a deadly poison to man or beast." Now, how long will tame parsnips have to run before they become poisonous? Will it be safe to let hogs dig up the roots where tame parsnips were four years ago?

2. Do you approve his plan of laying aside partly-filled sections to be finished another season? P. N.

ANSWERS.—1. The wild parsnip is probably no more poisonous than the tame. I read lately of a physician who had eaten a full meal of wild parsnips with no bad results. The probability is that if any poisonous effects have come in Mr. Smith's neighborhood, from eating the roots of "what is known" as wild parsnip, there was no wild parsnip in the case, but another plant that resembles in appearance the wild parsnip.

2. The answers on page 783 will show you that most bee-keepers do not make a success of using partly-finished sections the next year, even after the honey is emptied out. To keep them with the honey in would result in a very poor lot of sections when filled out another year.

Starting a City Man in Bee-Keeping.

I have lived in the city all my life, but have a little 10-acre patch over in Jersey, which I will get possession of May 1, 1897. I want to keep a few bees as an experiment. The country is simply suburban, and I am afraid there is not enough natural forage to support any considerable number of colonies, and it will take time to plant forage. There are a number of small patches of woods within a mile or two of my place, but I have no idea what trees or plants they are composed of. I have read the Bee Journal for a year, but as I have never seen the inside of a hive, and wouldn't know a queen from a worker if I were to see one, a good many of its teachings have been the same as Greek to me. I wish you would advise me how to make a start, with as little cash outlay as possible. What style and how many hives shall I buy? How many colonies, and what kind—I suppose Italians or hybrids? What appliances? I want to start in such a way that if they can be made profitable I can keep on increasing without any change in the outfit; but if they cannot be, then I want to drop it without the experiment having cost me too much, as my dollars are very scarce. Please bear in mind that I will come to town to work nearly every day.

Brooklyn, N. Y.

L. R. D.

ANSWER.—One of the first questions to settle is whether there is bee-pasture in reach, and the surest way to find out that is from the bees themselves. It is possible that a colony couldn't get enough to live on, but the probability is greater that 50 colonies would give you some surplus. I very much doubt whether you could profitably plant anything for bee-forage on valuable suburban land.

You are wise in planning to start with such appliances as you will be likely to continue, providing you increase in numbers. The main thing is the size of the frame. More frames $17\frac{1}{2}$ by $9\frac{1}{2}$, outside measure, are in use to-day than any other. As that comes nearest a standard size you are less likely to change from it than from any other. It doesn't matter so much as to the exact style of the frame or the hive, just so it conforms to the standard $17\frac{1}{2}$, for if your hive takes that size of frame you can change to another kind of hive or to another style of frame, but frames of different sizes cannot well be used interchangeably. Just now the Dovetail hive is the popular one, and you may safely start with that.

If there are bees all around you, it isn't a matter of the greatest importance what kind of bees you start with, for

within a year your bees will most likely be mixed with those around. If you know of no other bees near, or very few, then make a good deal of effort to have the best Italians. Of course, it's better to start with the best in any case, but you can see that if they are likely to be mixed with surrounding bees, you can at any time introduce new blood, whereas if you are alone and want to keep pure Italian stock it will be much easier to have nothing else in the first place.

Probably two colonies will be enough to start with, and spring the best time to get them. Instead of trusting your own judgment in selecting, better get from some one in whom you have implicit confidence, and with his riper experience he can tell which are the best colonies. Generally those dealers who have been in business some time will be careful enough of their reputations to treat you fairly.

Instead of advising you further just now as to any purchases, I advise you to get one or more catalogs of bee-keepers' supplies and go to studying them. You'll find it lots of fun, and after you've spent some time at it you'll be so mixed up you'll not know so much as when you started, but afterward the mists will clear away to some extent and you'll begin to have some idea as to what you want, and then you'll likely have some very pointed questions to ask, which I shall take pleasure in answering, providing your confidence in my judgment has not entirely evaporated by that time.

Sowing White Clover Seed.

1. When should white clover be sown ?
 2. How many pounds to the acre ?
- H. C.
Denison, Tex.

ANSWERS.—1. Probably at the time farmers in your locality sow other clovers. Although white clover grows by the acre where I live, I have some doubt whether as much as a quarter of an acre at a time was ever sown, only as it drops its seed and sows itself.

2. Because white clover is generally self-sown, it may not be easy to find out how much seed should cover an acre. I'm sure I don't know. At a guess I should say 40 pounds to the acre would do no harm, but half that much would make a pretty fair catch, and five pounds would give a start that would thicken up in two or three years. Now I've committed myself by that latitudinous guess, and some one who knows something about it can pick me up.

What Ailed the Bees ?

What ails my bees ? Just after a warm day, after having had a day's flight, there were found dead next morning a pint or more of bees, and they continued to crawl out and die all the day following. On opening the hive I found them to be in a sluggish, stupor state, slow of movement, and unable to guard the entrance. They would come out and open their wings to right angle with their bodies, and stretch out their bills to full extent and die. The end of the bill looked red and moist as if they were exuding something. Could they have found something on the day of their flight that poisoned them ?

I thought since the brood-chamber and super were both full to cover of honey, they might want more air, or at least it might help the case, so I put an empty super on top so as to give air space above the honey, and in 15 minutes they seemed to revive, and were able to guard the entrance. They did not spot the places where they sat, nor did they appear to be swollen—the fact is, they seemed to be too lifeless and stupid to fly.

I can't think that giving them more air cured them, notwithstanding they seemed to revive, for they were occupying the same hive that they had occupied all summer, and if this was the cause of their ailment, why was this effect not produced sooner ?

A. B. B., Lone Dell, Mo., Nov. 20.

ANSWER.—All I can do is to guess, and I don't believe I can make any better guess than yours—poison. If any one knows any more about the case, or has any more probable guess, let him please take the floor.

An Experience with the Porter Escape.

I have been reading four bee-papers, and have looked in vain for some intimation through them that others have had the same experience with the Porter bee-escape that I have had. I related my experience to Dr. Miller, but got no information.

In the fall of 1895 I used a Porter escape on a colony of

bees that had four supers of comb honey, three of which were complete; the incomplete super being next to the brood-chamber. The escape was placed under the three. The bees did not leave the supers readily, and on the second day the sections were taken off, and the queen found above the escape and returned to the brood-chamber.

Two or three hours later, on passing the hive, I saw what I thought would amount to three or four thousand bees in front of the hive, dead and dying. I opened the hive, but found nothing to show why those bees were killed. The queen was all right, and did good work this year.

What I want to know is, what was my mistake in the use of the escape ? The loss of bees was so great that the colony did no further work that season. I have had the same mishap with two colonies this year. I do not like to give up the use of the escape.

J. B. D.
DeWitt, Nebr.

ANSWER.—I don't remember to have seen this question before, and I always mean to answer in the paper designated, all questions sent. I have some doubt whether your management of the escape had anything to do with the matter. It is just possible—providing that the escape was put back after putting down the queen—that the escape was clogged so as to smother the bees in the supers, but in that case it seems not likely they would have made their way out, but would have remained jammed in the super. It seems a little more reasonable to suppose that a stray swarm tried to force its way in, and the bees were killed.

Demorest's Christmas Number opens with a most interesting article called "The Cradle of Christianity," being a series of sketches of the Holy Land, written by the Rev. Thomas P. Hughes, who has traveled all over that part of the world. It is copiously illustrated with several full-page and many other smaller pictures. Other interesting contents are the following: The good old-time Southern darkey with his queer customs and superstitions is admirably set forth by Mary Annable Penton. Howard Helmick contributes six full-page drawings, and the smaller illustrations are characteristic and delightful. The Fiction is furnished by Kate Erskine and Margaret Sutton Briscoe, and is particularly attractive and cheerful, as it should be for a Christmas number. There is a very appreciative and interesting little sketch of Eugene Field, written by Edwin C. Martin. It has both exterior and interior view of the poet's home, together with one of his comic sketches and other pictures. "Christmas in Several Lands" is the attractive title of a delightful symposium, wherein the Christmas customs and the Christmas spirit in various countries are pleasantly described by persons who have had some part in them. In "Smelt-Fishing in Northern Waters," J. Herbert Welch gives a spirited description of winter fishing through the ice, accompanied by a number of illustrations of the fishermen and their life there in their lonely shanties. Ernest Jerrold has a charming little story of a boy's love for a bird, entitled "The Fatal Knot-Hole." Better send for a copy—only 20 cents. Address, Demorest Magazine, 110 Fifth Ave., New York City.

A New Binder for holding a year's numbers of the American Bee Journal, we propose to mail, postpaid, to every subscriber who sends us 20 cents. It is called "The Wood Binder," is patented, and is an entirely new and very simple arrangement. Full printed directions accompany each Binder. Every reader should get it, and preserve the copies of the Bee Journal as fast as they are received. They are invaluable for reference, and at the low price of the Binder you can afford to get it yearly.

The Alsike Clover Leaflet consists of 2 pages, with illustrations, showing the value of Alsike clover, and telling how to grow it. This Leaflet is just the thing to hand to every farmer in your neighborhood. Send to the Bee Journal office for a quantity of them, and see that they are distributed where they will do the most good. Prices, postpaid, are as follows: 50 for 25 cents; 100 for 40 cents; or 200 for 70 cents.

The McEvoy Foul Brood Treatment is given in Dr. Howard's pamphlet on "Foul Brood; Its Natural History and Rational Treatment." It is the latest publication on the subject, and should be in the hands of every bee-keeper. Price, 25 cents; or clubbed with the Bee Journal for one year—both for \$1.10.

OLDEST BEE PAPER IN AMERICA

THE AMERICAN BEE JOURNAL

ESTABLISHED IN 1861

GEORGE W. YORK, Editor.

PUBLISHED WEEKLY BY

GEORGE W. YORK & COMPANY,

118 Michigan St., CHICAGO, ILL.

\$1.00 a Year—Sample Copy Sent Free.

[Entered at the Post-Office at Chicago as Second-Class Mail-Matter.]

Vol. XXXVI. CHICAGO, ILL., DEC. 17, 1896. No. 51.

EDITORIAL COMMENTS.

Subscription Renewals are coming in quite well now, but there is room for more. Don't be afraid that you'll overwork us in that part of our business. It's always a real pleasure to get lots of letters from our readers—especially if each one contains a dollar or more! We hope that no one will forget that Christmas is almost here, and if you want to make the Holiday season a real merry and happy one for us, just send on three or four thousand renewals for 1897 (including back subscription, if there be any in your case), and we'll promise you that "ye editor" and wife will not only have a thankful Merry Christmas and a Happy New Year, but the American Bee Journal will "arise and shine" in its old age, and become still better in its next volume.

The Bee Journal for 1897.—It is the custom of many periodicals to give a list of its attractions in advance of the New Year. They seem to think that is necessary in order to "hold their own" and also to gain new readers. We might tell you now what we expect to do next year, but we prefer to let all come along naturally, or, if possible, throw in a few surprises as the months pass on.

We have in store some excellent things for our readers, and can faithfully promise to give you *full value* in return for your dollar. No one expects more than that, for no bee-keeper wants something for nothing. We think we need only to say that the past few volumes of the old American Bee Journal shall be its recommendation for the future. We expect to keep it up to its present standard, and, if possible, make some advance during the year 1897.

We want *all* our present readers to go on with us. Let none fall by the wayside.

Stop and Think.—One of our subscribers wrote us as follows a week or two ago:

"Having to take gold standard prices for our produce, we are compelled to cut expenses until we get free silver and better prices. You may stop my paper at the end of the year."

Now just stop and think what it would mean if several thousand of our readers would take the same view as does the subscriber in question. What would become of the American Bee Journal? Shall we stop publishing it "until we get free silver and better prices?"

The trouble is, most people who begin to "cut expenses," cut at the wrong place. For instance, at least one bee-keeper who used to take the Bee Journal, and stopped it (perhaps thought he must "cut expenses"), shipped 500 pounds of honey to Wheadon & Co., and never got a cent for it! Had he continued to take the Bee Journal, he wouldn't have been

caught by that robber firm. Just think how many years' subscription that 500 pounds of honey would have paid, even at "gold standard prices!"

Permit a word of advice: If you must "cut expenses," be sure you don't cut off your *best friends*.

Save the Beeswax.—Much of success depends upon the practice of careful economy these days. In many lines of business what once was considered as waste is now saved and utilized in some way resulting in a profit. So it is in bee-keeping. It will especially pay to save the beeswax, for it is worth the cash at all times.

Here are a couple paragraphs on this very subject, taken from the Iowa Homestead of recent date:

If care is taken to look out for all scraps of wax, cappings and pieces of combs that for any reason are rejected, it will make a pretty piece of wax in the course of the year. If a solar wax extractor is used, of course it can only be used when the sun is shining and the weather warm, making it impossible to render any wax except in hot weather. But there may be more leisure for it now, and on one account cold weather is desirable. In melting up old, black combs, the cocoons in them absorb a large amount of wax which is lost. To prevent such absorption, soak the combs thoroughly in water, so that the cocoons already filled with water can take up no wax. But you'll find a hard matter to soak the combs full of water unless they are broken up fine, and if the combs are not made brittle with cold, it will be impossible to break them up. So it will be seen that cold weather is to an extent needed if you want to melt up old combs. After the combs are broken up fine, they may be saved till hot weather for the solar extractor, or they may be melted up at once, of course after soaking.

One good way to melt combs in winter is easily accomplished with only the ordinary appliances to hand in every household. Take an old dripping-pan—of course, an entirely new one will do as well—split open one corner clear to the bottom, and you have one of the best wax extractors. Lay in the material from which the wax is to be extracted, and put the pan in the oven of the cook-stove, with the door left open, and the split corner of the pan projecting out. Put something under the inside of the pan, so as to raise it up, then as the wax melts it will run out of the split corner of the pan. To catch the dropping wax set any vessel convenient, and it may be well to have in this vessel a little water so the wax will not stick to the bottom.

Michigan State Convention.—The Michigan State Bee-Keepers' Association will meet at the Donavan House, in Mt. Pleasant, on Jan. 1 and 2, 1897; the first session on the evening of the 1st. The rates at the hotel will be \$1.00 per day. There will probably be half-fare on the railroads. The program will be announced later. Every Michigan bee-keeper should attend this meeting.

Honey Jumbles and Gems.—At Watertown, Wis., there is a firm operating a biscuit and confectionery works, and using about 10 tons of honey a year. Two of their products are honey-jumbles and honey-gems. Recipes for them were given to Mr. Edw. H. Taylor—the young Englishman who was recently visiting in this country—and he sent them to the British Bee Journal, where they were published. They are as follows:

HONEY-JUMBLES.—Flour, 196 pounds; lard, 10 pounds; honey, 12 gallons; molasses, 3 gallons; carbonate soda, 4 ounces; salt, 1 pound; water, 3 gallons; vanilla extract, 1 pint.

HONEY-GEMS.—Flour, 196 pounds; lard, 10 pounds; honey, 7 gallons; molasses, 7 gallons; brown sugar, 15 pounds; carbonate of soda, 3½ pounds; salt, 1 pound; water, 4 gallons; vanilla extract, 1 pint.

Of course these recipes are for large manufacturers, but those wishing to make the jumbles and gems on a small scale can use smaller quantities of the various ingredients in proportionate amounts.

It should be the aim of every bee-keeper to strive to popularize the use of honey more and more, and thus create a

larger demand to keep up with the increased annual production of honey.

Mr. Taylor reported that one of the proprietors of the firm referred to in the first part of this item, told him "that nearly all bakers and confectioners in America use honey, and that the United States could not produce enough honey, but had to import from Jamaica and Cuba." This will be news to most bee-keepers. Why, the great trouble is to find a market for all the honey now produced in the United States. We would be glad to take the contract to supply all the confectioners and bakers with United States honey. No need of importing it at all. If that has been done, it is high time that our bee-keepers are arising and doing all in their power to induce such manufacturers to use only honey produced in this country. The idea of the necessity of *importing* honey into the United States! We produce plenty to *export*, if only a profitable foreign market could be found for our surplus.

The Apis Dorsata Resolution, as passed at the Lincoln convention in October, seems to have grated a good deal on the nerves of our brother editor, Mr. Merrill, of the American Bee-Keeper, for in the November issue of that paper he lets himself loose in a style that surely is not very creditable, to say the least. Commenting upon this matter in Gleanings for Dec. 1, Editor E. R. Root says:

Mr. Merrill, of the American Bee-Keeper, says that "no doubt" the resolution passed by the Lincoln convention, condemning the action of the Ontario County, N. Y., Bee-Keepers' Association, recommending the general Government to send an expedition to India to secure *Apis dorsata*, was "by the dictation of the half-dozen wise men—Messrs. Root, York, Miller, Dr. Mason, etc.;" that "this convention of war-horses usually run things pretty much their own way when they get together." Mr. Merrill, if I am correct, never attended more than one of the North American conventions, and that, unfortunately, was one where some discord was apparent—much more so than in any dozen preceding conventions. All conventions of this association should not be judged by this one. The action at Lincoln condemning the Ontario County recommendation was *not* "at the dictation" of any of the gentlemen named; neither had they anything to do with it beforehand. The resolution was introduced by Mr. Stilson, of the Nebraska Bee-Keeper, and upon mature deliberation was passed without a dissenting vote. The main argument used was that there were other things much more needed than the importation of a new race of bees.

All of which goes to show that it is much easier to stay at home, and then throw stones, than it is to attend a bee-convention and share in the responsibilities. So far as we know, Mr. Merrill has never been a member of the North American, though he did *attend* the Toronto meeting, which was held so near his home he could hardly help being there. We are glad Mr. Root replied to his unkind criticism.

Honey-Production in the South.—Mr. A. F. Brown, of Florida, has an article on page 502 that will be of interest to our Southern readers, as well as to others. We have arranged with Mr. Brown to write a few very practical articles especially for the benefit of honey-producers in the South. He is a bee-keeper of large experience, his honey crops running from 10 to 25 tons per year, and he has probably moved more individual colonies of bees from one range to another than any other one man in the South, making 19 moves with from 150 to 300 colonies, covering a distance of 18 to 300 miles, by water, by railroad, and by hauling.

Mr. Brown has now about 200 colonies in fine condition, in new hives, on a new range 50 miles from his old location where he lost some 300 colonies last year through the ravages of foul brood. He is arranging to double his present number of colonies for next season, and will work principally for comb honey. Heretofore his crops have been extracted honey, with the exception of 18,000 pounds of comb honey the two seasons previous to last year.

Bee Journal Complete for 1896.—We have a few complete sets of the American Bee Journal for 1896 (or will have by Jan. 1) which we will be pleased to mail to any one for 75 cents each, so long as they last. A "Wood Binder" to hold the year's numbers will be sent for 15 cents extra. Think of it—only 90 cents for this year's volume of the Bee Journal and a binder—848 pages!

PERSONAL MENTION.

MRS. L. HARRISON, of Peoria, Ill., left for her winter residence in the South on Dec. 2. Her address is St. Andrew's Bay, Fla.

MR. J. T. CALVERT, the hustling business manager of The A. I. Root Co., was in Chicago on Friday and Saturday of week before last, looking after the interests of their Chicago Bee-Supply Branch, among other matters. We had a pleasant visit with Mr. Calvert.

MR. W. J. MORRISON, of Missouri, wrote as follows when renewing his subscription for 1897:

"We have become deeply interested in bee-keeping. We think more of the American Bee Journal than of any other paper we take."

MR. S. J. BALDWIN, a bee-supply dealer of England, who has been spending a few months in the United States, returned Dec. 16. He writes us that he has had a most enjoyable time here, and feels greatly benefited in health from the change, besides making many very agreeable friends.

MR. GEO. W. HUFSTEDLER, of Texas, wrote us, Dec. 2, that he had removed to Bee county with a carload of bees, for the purpose of continuing to rear fine queens. He says:

"I don't see how I can get along without the Bee Journal. We are experiencing a very cold spell here—the coldest for two winters, so 'tis said. I wish you and the 'Old Reliable' all the success possible."

DR. W. B. HOUSE, of Detour, Mich., has a remedy which he calls "Yellowzones," an advertisement of which appears in this issue. We are not in the habit of giving a personal recommendation of the value of any medicine, but in this case we make an exception. We believe Dr. House sends out a "yellow" remedy that will make *Housefuls* of happy people, whether in the torrid or frigid "zones." He says if they do not do the business, he will refund your money. That's surely fair. But so far it seems not one customer has asked to have his money back. Hence the "Yellowzones" must be all that is claimed for them.

MR. J. T. HAIRSTON, of Indian Territory, wrote thus on Nov. 2:

"I am better pleased with the American Bee Journal every issue. It is saving the honey-producers money by exposing such frauds as Wheadon and others."

The above is a sample of what our readers are thinking and saying. Well, we are willing to keep up the good work, and trust that every subscriber will at least give us the encouragement of his or her renewal subscription.

MRS. A. L. HALLENBECK, of Millard, Nebr., was thrown from a wagon and instantly killed, Nov. 21—only a little over one month after the Lincoln convention, where we had the pleasure of meeting her. Her husband died a year or so ago, we believe, and now she is gone, leaving a family of eight children, the youngest being three years old, to mourn the loss that can never be made good. We were particularly pleased with Mrs. Hallenbeck, when we met her at Lincoln, for we felt that in her we had a true friend—one that had had a varied experience—a woman whose character was indeed beautiful. Hence we were greatly pained to learn of her sudden death, and our tenderest sympathies went out to her bereaved children. We hope they have good friends to care for them. Mrs. Hallenbeck was an occasional contributor to our columns, her writings always bearing the imprint of a generous, loving heart.

General Items.

Results of the Past Season.

From 20 colonies, spring count, I took nearly 600 pounds of comb honey, and increased to 35 colonies this year. I did not have the time to care for my bees properly, hence the results were not as large as they should have been. I find that in order to make bee-keeping a success one needs command of his whole time, so I think another season I shall increase the number of my colonies to a sufficient size to enable me to give my entire attention to that work, as I am convinced that it is a profitable as well as a pleasant occupation. I shall rely upon the Bee Journal as one of my most valued assistants, as I find every week it brings some article that is sure to be "just what I wanted to know." Long life and success to it! and here's a "shining dollar" for another year's subscription.

I am wintering my bees in double-walled hives, on the summer stands.

CHAS. E. CRAWFORD.
Oscoda Co., Mich., Dec. 7.

Two Years' Report.

My 11 colonies of bees this season gave me 1705 one-pound sections of honey, nearly all from white clover. Basswood did not yield any honey this season. My increase of bees was from 11 to 23 colonies, by natural swarming. I returned all after-swarms but one. I have also 23 supers half and two-thirds full of honey. My honey is clean, without a stain. Last year my six colonies gave me 100 pounds of basswood honey each, and six supers of sections partly full of comb and honey from buckwheat. The American Bee Journal—well, I can't begin to tell how much I like it.

T. P. EVANS.
Mitchell Co., Iowa, Dec. 1.

The Season—Dealer's Rights, Etc.

The honey season just closed was the poorest in my experience of 10 or 12 years. I never saw so profuse a bloom of all kinds that yielded so little honey. All the surplus I got was from basswood, which bloomed heavily, but yielded but little honey, and was soon gone. Durearly fall we had acres of heart's-ease and an abundance of white, Alsike, and red clover bloom, and the hives overflowing with bees, yet they stored no surplus, and many did not store enough for winter.

Last winter I wintered 75 colonies, but four or five were queenless and were united with others. I got only about 600 pounds of surplus comb honey, and increased my colonies to 100 by natural swarming; but that does not represent the number of swarms, as some absconded, and some were double swarms. At one time I had four out at once, but for some reason they did not stay out, but entered the hives nearest to where they clustered, one of which had not swarmed. I have now reduced my number to 82, by doubling up, and have them packed for winter on the summer stands.

So far as I have talked with bee-keepers, none have done any better than I did, and some not as well. But I am

THE GIANT MANUAL.

Twelve Books Combined in One!

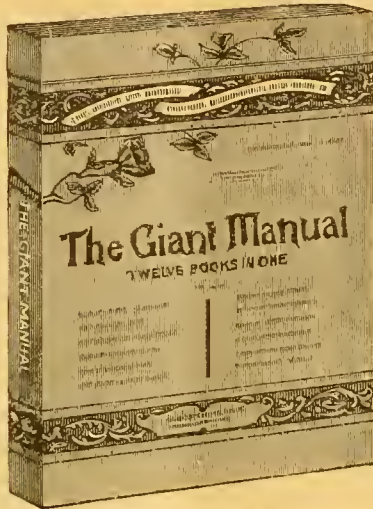

We will send **The Giant Manual**, containing everything enumerated above, by mail post-paid, upon receipt of only **Twenty-five Cents**.

THE GIANT MANUAL is the largest, the most comprehensive and the most extraordinary book ever sold for twenty-five cents. It is in reality twelve separate and distinct books combined in one. It contains precisely the same amount of material as is ordinarily published in twelve distinct 25 cent books, and it may therefore be claimed, with perfect truth and candor, that it is a *three dollar book for twenty-five cents*. In shape it is a mammoth quarto of 192 large three-column pages, with many appropriate illustrations, and is handsomely bound in attractive colored covers. Instruction, amusement, entertainment—all are combined bereof, and the book cannot but be of the utmost practical use and value to every man, woman and child. The following are the contents of THE GIANT MANUAL:

1. **The Standard Letter Writer** for Ladies and Gentlemen, a complete guide to correspondence.
2. **Manual of Etiquette** for Ladies and Gentlemen, a guide to politeness and good breeding.
3. **Winter Evening Recreations**, a large collection of Acting Charades, Fables, Games, Puzzles, etc.
4. **Parlor Magic and Chemical Experiments**. Tells how to perform hundreds of amusing tricks.
5. **Selections for Autograph Albums**, Valentines, Wedding Anniversaries, Birthday Greetings, etc.
6. **Low Life in New York**. A series of vivid pen pictures showing the dark side of life in the great city.
7. **The Road to Wealth**. A practical work, telling how all may make money easily and rapidly.
8. **One Hundred Popular Songs**, sentimental, pathetic and comic, including most of the favorites, with and without music.
9. **Popular Recitations and Dialogues**, humorous, dramatic and pathetic, including the most popular.
10. **How to Make and Save Money on the Farm**. A valuable compilation of useful facts and suggestions.
11. **The History and Mystery of Common Things**. Describes the manufacture of familiar things.
12. **Useful Knowledge for the Million**, a handy compilation of useful information for all.

The Bonanza Book for Boys and Girls.

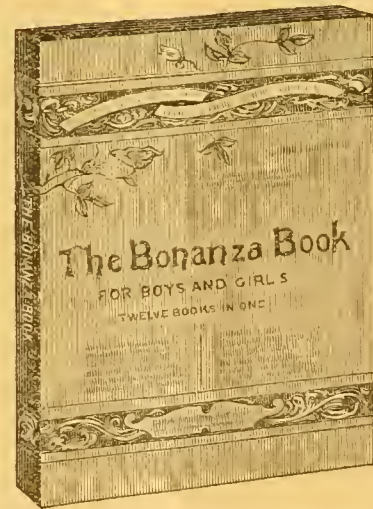

We will send **The Bonanza Book for Boys and Girls**, containing everything named above, by mail post-paid, upon receipt of only **Twenty-five Cents**.

TWELVE BOOKS COMBINED IN ONE!

This great book contains the largest amount and greatest variety of amusing and instructive reading matter for boys and girls ever gathered together and published in a single volume. It is in reality twelve separate and distinct books combined in one. It contains precisely the same amount of material as is ordinarily published in twelve distinct 25 cent books, and it may therefore be claimed, with perfect truth and candor, that it is a *three dollar book for twenty-five cents*. In shape it is a mammoth quarto of 192 large three-column pages, with many appropriate illustrations, and is handsomely bound in attractive colored covers. The following are the contents of The Bonanza Book for Boys and Girls:

1. **Modern Recitations**, in prose and verse, embracing many old and new favorites.
2. **Gulliver's Travels**. Adventures among the Lilliputians and Giants.
3. **Dialogues, Recitations and Readings**. A large and choice collection.
4. **Round the Evening Lamp**. Stories, pictures, puzzles and games for the little folks.
5. **Parlor Amusements**. Acting Charades, Parlor Dramas, Shadow Pantomimes, Games, Puzzles, etc.
6. **Grimm's Fairy Tales**. The most popular of all fairy stories.
7. **The Self-Made Men of Modern Times**. Portraits and biographies of famous Americans.
8. **Wonders of the World**. Descriptions and illustrations of natural and other wonders.
9. **Wonders of the Sea**. Descriptions of the wonders of the deep, profusely illustrated.
10. **Distinguished People**. Biographical sketches of famous men and women.
11. **Manners and Customs in Far-Away Lands**. Life and habits of peculiar people and tribes.
12. **The People's Natural History**. Interesting information regarding birds, fishes, reptiles and insects.

As a Premium You can have either book FREE for sending us 1 NEW SUBSCRIBER to the Bee Journal for a year; or we will club it with the Journal—both for \$1.10.

GEORGE W. YORK & CO., 118 Michigan St., CHICAGO, ILL.

California

If you care to know of its Fruits, Flowers Climate or Resources, send for a Sample Copy of California's Favorite Paper—

The Pacific Rural Press

The leading Horticultural and Agricultural paper of the Pacific Coast. Published weekly, handsomely illustrated, \$2.00 per annum. Sample Copy Free.

PACIFIC RURAL PRESS,
20 Market St., - SAN FRANCISCO, CAL.

Muth's HONEY-EXTRACTOR

Square Glass Jars.

Root's Goods at Root's Prices.

BEE-KEEPERS' SUPPLIES in general, etc., etc. Send for our new catalog. "Practical Hints" will be mailed for 10c. In stamps. Apply to—
Chas. F. Muth & Son, Cincinnati, Ohio.

READERS Of this Journal who write to any of our advertisers, either in ordering, or asking about the Goods offered, will please state that they saw the Advertisement in this paper.

not yet discouraged. I am still in possession of the bee-keepers' anchor—hope. There is an abundance of Alsike clover sown in my neighborhood, and white clover, which was burnt out during our drouth, has again come to the front during our past wet summer, and the ground along the roadsides in many places is literally carpeted with it, so that the prospect from clover for next season could not be better at this time. How the yield will be, time must tell.

Rev. E. T. Abbott hits the nail squarely on the head in his paper on page 693, under the head, "The Dealer's Rights." Some small dealers who had worked up a little trade among their neighbors who keep a few colonies, and had ordered their supplies early, in order to get a little reduction, and had paid out their money, or were paying interest on the bill, were confronted later, when those neighbors wanted to buy, with circulars from the manufacturers from whom they bought, offering to sell to them the same goods at prices so much below catalogue prices that the small dealer could not compete with them, and he either had to keep his goods or sell at a dead loss. This is especially true of last spring, and is unfair to the dealers who in former years had introduced the goods, and made it possible for them to be sold at all; and I am glad that so prominent a man as Mr. Abbott had the courage to "speak out in meetin'" against the practice.

I am glad of the Bee Journal's bold stand against frauds, and I hope the editor will not relax one iota. I sell most of my honey in the city of Huntington, and I find many who are suspicious of adulteration; it takes a little talk, sometimes, to get them to buy; yet, as a rule, if I sell to a family once, I can sell to them again, if they want honey, or have the means to buy it.

A. F. SNOWBERGER.

Huntington Co., Ind., Nov. 30.

An Old Bee-Keeper.

Two years ago last spring I had 8 colonies, last spring 46 living, and I now have piled up in the cellar 104, after selling 4 and taking up several.

H. P. WILLSON.

Pembina Co., N. D. Dec. 5.

The Past Season with Bees.

We are having delightful fall and winter weather, but I expect zero atmosphere soon; in fact, any time now-days. The fall in general has been quite cool, and in consequence everything is short in growth. White clover and Alsike look very promising, the white especially; being everywhere in abundance, a crop of honey is assured from this source the coming season.

I was not so successful this season in reaping a harvest. I obtained 200 pounds of fine comb honey, which I wholesaled for 13 cents per section, and 100 unfinished ones for home consumption—with numerous ones fed back, which I will level down and use next season. My spring count of colonies was 12; fall count, 9 prepared for outdoor wintering, and eight for the cellar, making 17 in all.

An experiment is being tested on those for out-doors, which I will report later on with illustrations if I am only successful in a degree on this venture.

My bees are stronger in numbers, as

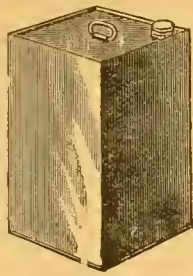

Finest Alfalfa Honey!

IT SELLS ON TASTING.

The Honey that Suits All Who Buy It.

We can furnish **White Alfalfa** Extracted Honey, in 60-pound tin cans, on board cars in Chicago, at these prices: 1 can, in a case, 8 cents per pound; 2 cans in one case, 7½ cents; 4 cans (2 cases) or more, 7 cents. The Cash must accompany each order. **Fine Basswood** Honey at ¼ cent more per pound.

A sample of the honey will be mailed to an intending purchaser, for 8 cents, to cover postage, packing, etc. We guarantee purity, and what we ship will be equal to sample.

Now it seems to us here is a splendid chance for any bee-keeper to supply his home demand after his own crop is all sold. Or, why not begin now to create a local honey-trade? Order one 60-pound can first, and start out among your neighbors and friends, and see what you can do. You ought to get at least 15 cents per pound in 5-pound lots, or 50 cents for 3 pounds. Some may be able to do even better than that, though we think that enough ought to be sold at these prices to make a fairly paying business out of it. Give it a good trial. Push it. It may grow into a nice winter's work for you.

GEORGE W. YORK & CO., 118 Michigan Street, CHICAGO, ILL.

✦ MONEY SAVED IS MONEY GAINED. ✦

THE ROYAL UNION Life Insurance Company DES MOINES, IOWA.

The Iowa Policy

Is one that definitely promises to keep an accurate account with you; credit your premiums and interest, charge the actual expense and mortuary cost, and hold the remaining funds subject to your order.

Agents Wanted.

JOHN B. KING, GENERAL AGENT,
Suite 513 First Nat'l Bank Bld'g,
20 Atf CHICAGO, ILL.

Mention the American Bee Journal.

DUQUESNE COLLEGE!

PENN AVE. AND EIGHTH ST.

PITTSBURG, PA.

Thorough Courses — Classical, Scientific, Normal, English, Commercial, Preparatory, and Ladies Literary. Efficient and experienced instructors. Day and Night sessions.

Send for Catalog.

Mention the American Bee Journal.

THROAT AND LUNG DISEASES,
DR. PEIRO, Specialist
Offices: 1019, 100 State St.,
CHICAGO. Hours 9 to 4.

The "Premium": A Good Watch Mailed Free!

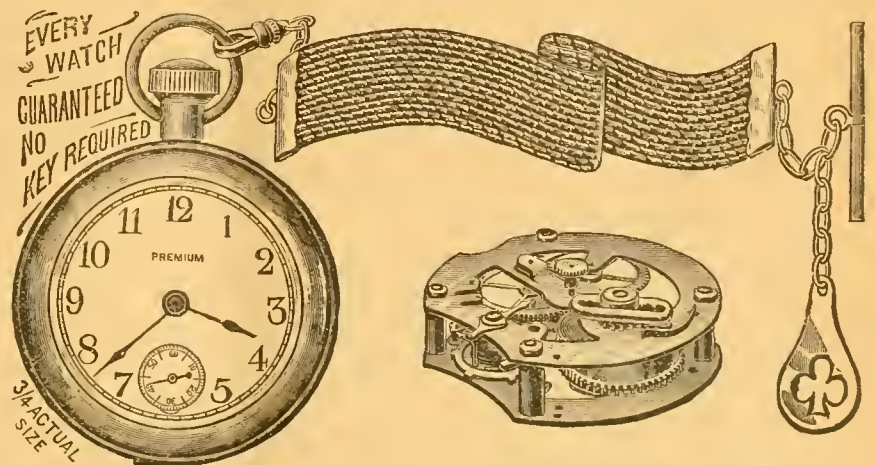

The movement of this Watch is regular American lever, lantern pinion, quick train, 240 beats per minute, three-quarter plate, short wind; runs 30 hours to one winding; dust cap over movement; every movement fully timed; regulated and guaranteed for one year, the same as a Waltham or Elgin; nickel finish, heavy bevel crystal, and back pinion wind and set.

OUR OFFERS:—We will mail the above Watch for \$1.25; or club it with the Bee Journal for a year—both together for \$2.10; or we will send it free as a premium for getting Three New yearly Subscribers to the Bee Journal at \$1.00 each. The Watch is mailed from New York City, so please allow a few days before expecting your order to be filled.

GEORGE W. YORK & CO., 118 Michigan St., Chicago, Ill.

well as in stores, than I ever knew them before.

A bee-keeper who has 20 colonies three miles north, and one with several one mile south, have no surplus, and their colonies are destitute of sufficient stores to carry them successfully through the season. No honey is the general report, but I get honey, and they would, too, if given proper care at the proper time. Owners of such property do not keep them, but the bees keep themselves or perish in the attempt.

Peppermint was a sad failure by the flood, and in consequence not 20 blossoms could be found in this whole territory. No white or other clover honey, and with a small yield from wild red raspberry. A short flow from coreopsis, and last spring's seeding of Alsike, which blossomed in profusion this fall, made the bulk of my honey crop. Basswood (American linden) bloom was in such profusion that the limbs drooped with their burden, but "nary a bit" of honey from this source.

CARSON VAN BLARICUM,
Calhoun Co., Mich.

A Report.

We have 52 colonies of bees. We commenced three years ago with two colonies; this year we had 2,500 pounds of honey. I covered up 22 colonies out-of-doors last year, and all came out in fine condition last spring. We extracted 1,100 pounds of honey this fall.

GARNER & HARKER,
Plymouth Co., Iowa.

Hiving a Swarm—Carniolan Bees.

On July 2, 1896, a friend living about two miles away came to me and said: "There is a swarm of bees down there on a tree, and if you hive them you can have them. I would not hive them for a ten dollar bill."

I told him that they were worth hiving, and I would go with him. So I fixed up an 8-frame dovetail hive, put in a few combs and filled up with empty frames. Then we started for the bees. When we got there I found them on a limb of a wild-cherry tree, about 20 feet from the ground, so we started for a ladder, saw, and some other things to be used in getting them down. On our return we raised the ladder and sprinkled some water on the bees, which made them crawl in a bunch, and we could see the combs which they had built on the limb they were hanging on. We sawed the limb off and lowered the bees, shaking them in front of the hive, and saw the queen march in with the bees, and all was lovely—not a single sting was administered in the whole affair.

This swarm had built five combs on the lower side of that limb—the center one being about 9x14 inches, and the rest rounding off; the two outside ones being about the size of a hand. The center combs had a lot of capped brood, and every cell was worker-comb, and not over two ounces of honey. By the brood, I think that swarm was there all of two weeks. I took them home and they filled their hive, built nearly all worker-comb, and were common black bees.

Some people call the Carniolans black bees, and even go so far as to say that at first sight one would call them so, and possibly at last sight, also. Now, I do not agree with that, but I do agree with

COMB FOUNDATION

Wax always wanted for Cash or in Exchange for Fdn. or other Supplies. My trade is established on Low Prices and the merit of my Foundation. Orders filled promptly.

WORKING WAX INTO FDN. BY THE LB. A SPECIALTY. Wholesale prices to dealers and large consumers. Send for Prices and Samples to—GUS DITTMER, AUGUSTA, WIS. Reference—Augusta Bank. 1A1f

Mention the American Bee Journal.

HATCH Chickens BY STEAM—
With the **MODEL EXCELSIOR Incubator**
Simple, Perfect, Self-Regulating, Thruout in successful operation. Lowest priced First-class Hatcher made. **Geo. H. STALL.**
111 to 122 S. 6th St. Quincy, Ill.

44A26t Mention the American Bee Journal.

SICK BEE-KEEPERS—

Perhaps not very sick, but many of you suffer more or less, and that isn't pleasant. So I'd like to talk to the A. B. J. readers a moment about **Yellowzones**, an honest, efficient, general-service remedy that is used by the Editors of this paper and Hundreds of Bee-keepers and others all over the country.

They Cure Pain and Fever. Especially useful in all Fevers, Headaches, Colds, Grip, Rheumatism and Neuralgia. Cures serious as well as common ailments, and very quickly. No narcotics; perfectly safe; easy to take; delightful in effect, and every box guaranteed to please you or money refunded; but no customer ever yet asked for return of money, and

They Talk This Way:—

"IT'S A RARE PLEASURE to find such a remedy."
"No one could believe their wonderful healing power, and so quickly, too, without trying them."

"I have used **YELLOWZONES** for a bilious and nervous headache that has been the bane of my existence for 20 years, and **THEY KNOCK IT CLEAR TO THE HORIZON!**"

"Been laid up 6 months with Rheumatism. Got more relief in 12 hours after taking your **YELLOWZONES** than from all else, though I am a skeptic, and did not believe they could do it."

Your Editor, Geo. W. York, after having Yz. in use among his force since April, writes Nov. 14th:

"Yes, sir; fine reports have come to us about your medicine. Mr. Root spoke very highly of you when on our way to Lincoln, Neb., lately. Have also seen the testimonials you have published in your ad. in *Gleanings*. I shouldn't hesitate to advertise your **Yellowzones** in the *Bee Journal*—in fact, I should feel that I was helping along a good thing."

YOU will need **YELLOWZONES** in your home frequently, and the better you know them the more you will like them. Better send right away.

1 Box of 18 Tablets by mail 25 cts.; 6 Boxes, \$1.00. Most orders are for 6 boxes. Let me at least send every one of you an interesting circular.

W. B. House, M.D., Drawer 1,
DETROIT, MICH.
Mention the American Bee Journal.

NEW MAMMOTH
Poultry Guide for 1897. Something entirely new; almost 100 pages; contains lithograph plate of Fowls in natural colors; plans for poultry houses, remedies and recipes for all diseases; how to make Poultry and Gardening pay; only 15 cents. John Bauscher, Jr., Box 94 Freeport, Ill.

49A13t Mention the American Bee Journal.



ONE MAN WITH THE UNION COMBINATION SAW

Can do the work of four men using hand tools, in Rippling, Cutting-off, Milling, Rabbeting, Grooving, Gaining, Dadoing, Edging-up, Jointing Stuff, etc. Full Line of Foot and Hand Power Machinery Sold on Trial. Catalogue Free.

SENECA FALLS MFG. CO.,
46 Water St., SENECA FALLS, N. Y.
1A1f Mention the American Bee Journal.

Mr. Abbott, when he said that it is just as easy to tell a Carniolan from a black bee as it is to tell a horse from a mule. I am talking of pure Carniolans now. I simply say "pure," for the reason that I was deceived myself in purchasing Carniolan queens. One breeder sent me a Carniolan queen, and she looked (to me) like a black. The bees with her in the cage looked black, and when her bees showed up they were about half black and half Italian. Another breeder sent me a Carniolan. The queen herself looked like a Carniolan, also the bees with her in the cage, but she was mated to a black drone, and her bees were half black and half Carniolan.

But I have some pure Caruiolan colonies, and they are regular zebras in color, having their abdomens covered with rings of gray hair, and look very pretty. They are rousing big colonies, flying when the Italians are idle. They are good comb-builders, gentle, and cap their honey very white. I have my Carniolan and some Italians on frames 11½ inches deep, the same length as the Langstroth, using bottom cover and super of the 8-frame Dovetail hive. All I change is the end-bar on the frame, and place a rim 2¼ inches under the hives, which gives a deeper hive to winter my bees in on the summer stand, and enlarges the 8-frame hive to the same amount of room as a 10-frame Langstroth. I like them better than the 10-frame Langstroth, and not a comb has broken down for me yet.

PAUL WHITEBREAD,
Luzerne Co., Pa., Nov. 28.

A Wonderful 3-Frame Nucleus.

I wish to make a report of a 3-frame nucleus which I received of an Illinois breeder on May 8, 1896. I was sick when they came, and not being able to take care of them they had to stay in the shipping-case until Sunday. Not wanting them to stay any longer, with father's help we put them into a 9-frame hive, with two frames of comb and the rest comb foundation. About every other day I opened the hive and spread the frames, and dropped one of the outside ones in the center, so as to keep the brood-rearing going on as fast as possible. The plums, apples, and locusts were in full bloom, so the bees had a fine field to work in. The queen was the best I ever had, for from May 29 until July 6 she kept the nine frames full of brood. I took off two cases of 27 pounds each, making 54 pounds in all.

As it was my first season of Italian bees, I thought I should like some increase, so at the same time (July 6) I took out the queen and the two frames containing the least brood, and put them into another hive, leaving the old hive on the old stand with seven frames of brood. I concluded to let them swarm.

On July 25 I found one dead queen in front of the old hive, and on the 26th I found two more. Then on July 28 they came forth in good earnest, with a very large swarm. Just as they got nicely settled I undertook to hive them, just the same as I did my hybrids years ago, and instead of going into the hive they went into the air and off for the woods, and it was impossible to stop them, so they were gone. But July 29 another swarm came out, which father and I hived with success. The next morning I found three queens at the

THE JOY OF SUCCESS

is sure to follow the use of the **New Successful Incubator** Its just like making any other sure and good investment. Regulates its heating to a nicety; needs no watching; generates its own moisture. Hatches every egg that can be hatched. Sold under a positive guaranty. All about it in Book on Incubation and Poultry. Sent free in stamps. Address **DES MOINES INCUBATOR CO.,** Box 78, DES MOINES, IA. 49D6t *Mention the American Bee Journal.*

Yell, O Yell, O'YELLOWZONES YELLOWZONES for **PAIN** and **FEVER.**

40,000.

THE Nebraska Farmer

Has made a contract with the Nebraska Club, to print for them **40,000** copies over and above the regular weekly issue, each month for six months, of reliable information about Nebraska.

If interested, send for free copy, to
MR. CHAS. E. WILLIAMSON,
 Secretary Nebraska Club,
 OMAHA, NEBR., or
Nebraska Farmer Co.
 Lincoln, Nebr.

44A13 *Mention the American Bee Journal.*

SAUMENIG!

Made on the best lines, of the best material known to the art. **HEATS WITH HOT WATER** Entirely automatic, will hatch every egg that can be hatched. Simple, durable, effective. Send 2 stamps for illustrated catalog No. 59.

THE INVINCIBLE HATCHER CO.,
 SPRINGFIELD, OHIO.

Mention the American Bee Journal.

Our Prices ARE WORTH LOOKING AT!

—IN THE—
NEW CHAMPION CHAFF HIVE

especially. All other Supplies accordingly. Send for Catalog and Price-List. Address,
R. H. SCHMIDT & CO.,
 48Atf Box 187, SHEBOYGAN, WIS.
Mention the American Bee Journal.

Cash PAID FOR Beeswax

For all the **Good, Pure Yellow Beeswax** delivered to our office till further notice, we will pay 25 cents per pound, **CASH**; or 23 cents for whatever part is exchanged for the Bee Journal, Honey, Books or Seed, that we offer. If you want **cash, promptly**, for your Beeswax, send it on at once. Impure wax not taken at any price. Address as follows, very plainly,
GEO. W. YORK & CO.
 118 Michigan st., CHICAGO, ILL.

IF YOU WANT THE BEE-BOOK

That covers the whole Apicultural Field more completely than any other published, send \$1.25 to Prof. A. J. Cook, Claremont, Calif., for his
Bee-Keeper's Guide.
 Liberal Discounts to the Trade.

front of the hive, seemingly all right. July 30 another swarm—about four quarts—issued, which we hived the same as the other. The next morning I found one dead queen in front of the last hive, and three in front of the old hive, making in all 13 queens that I saw, not knowing how many went away with the first swarm.

Now for the old colony: After dividing, they filled the two frames in the brood-nest and about 15 pounds in the super. The one with the old queen filled their brood-nest and drew out some of the foundation in the super, but put no honey in the super at all. The other two new swarms are in good condition for winter, with about 30 pounds of honey each.

If there is any one that can give any better report of a 3-frame nucleus let us hear from him.

There is only one fault I have to find with the Bee Journal—I wish it was \$4.00 a year, and twice as large. Success to it. H. W. SAVAGE.
 Sauk Co., Wis.

Question-Box.

In the multitude of counsellors there is safety.—Prov. 11-14.

Square or Oblong Sections of Honey.

Query 38.—Which do you think would be more generally liked to place on the table before guests, a 4¼ square section of honey or an oblong one 5¼x3½?—Mo.

- A. J. Cook—The former.
- A. J. Green—4¼ square.
- Jas. A. Stone—4¼ square.
- W. G. Larrabee—4¼x4¼.
- E. France—The square one.
- Eugene Secor—The 4¼x4¼.
- Rev. M. Mahin—The 4¼-inch square.
- Chas. Dadent & Son—Either, if the honey is good.
- J. M. Hambaugh—Whichever the plate will suit.
- G. M. Doolittle—I prefer and use the latter, considering it a more appreciable shape.
- Dr. A. B. Mason—A 4¼ square for some people, and an oblong one for others.
- R. L. Taylor—It probably would depend simply on the shape of the plate to be used.
- Mrs. L. Harrison—I would prefer the square section; it would lie on a small plate better.
- Dr. J. P. H. Brown—This is altogether a matter of taste. "The oblong might best fit the majority of "honey-dishes."
- Dr. C. C. Miller—I think that depends on the dish. For most dishes the square section, but for a long dish the oblong.

H. D. Cutting—I used for several years a section 4¼x6¾, and they made a finer appearance on the table than the 4¼x4¼.

J. E. Pond—Really, I can't see that it would make any difference, other things being the same. It is wholly a matter of fancy and taste. I think any one would like the taste of the honey if



IN THE COUNTRY HOME

you need constantly on hand a **safe, sure and effectual** remedy for the ordinary ills of life; one which will meet the requirements of all emergency cases and work a permanent cure.

Worm's Safe Cure

has done this for many years on four continents.

CURES....
 Bright's Disease,
 Urinary Troubles,
 Female Complaints,
 General Debility,
 Malaria,
 and all diseases arising from disordered Kidneys and Liver.
 Ever ready to hand.
 Large bottle or new style smaller bottle at your nearest store. Be honest with yourself and try a bottle.

Mention the American Bee Journal.

—WRITE—

Without Fail—enclosing a list of Supplies wanted, and get our prices on them, before placing your order.

5 to 10 per ct. Discount till Jan. 1st.
I. J. STRINGHAM,
 105 Park Place. NEW YORK, N. Y.
 APIARY—Glen Cove, L. I.
Mention the American Bee Journal.

Payne's Business Letter Writer and Manual of Commercial Forms.—Containing specimen Letters on all possible business topics, with appropriate answers. Containing general information with regard to business matters, the rules for punctuation, the abbreviations most used in the mercantile world, a dictionary of mercantile terms, a table of synonyms, and other information which may be of value to the business man. New edition, revised and enlarged. 216 pages, Extra Cloth, 75 cts.



Special Offer: We will mail this book free sending us **two** New Subscribers to the Bee Journal for one year (with \$2.00), and also send a copy of the premium book "Bees and Honey" to each of the new subscribers; or we will club the book with the Bee Journal for a year—both for \$1.60.

GEORGE W. YORK & CO.,
 CHICAGO, ILL.
Mention the American Bee Journal.

first-class, no matter as to the shape of the same, whether square, oblong or round.

C. H. Dibbern—Really, I cannot see much difference. For a nice appearing cake of honey I have never seen anything better than the old 5¼x6¼ section.

Rev. E. T. Abbott—I do not think it would make any difference to the guests. The worst trouble with me is to get any kind of honey when I am away from home.

G. W. Demaree—I can't see why there should be any difference. I prefer the 4¼ sections because they are standard in size and shape, and can be had without extra trouble.

Mrs. J. N. Heater—I can see no advantage whatever to be gained by making such a change; and doubt if there ever was a person who, as a "guest," would have the least preference as to the shape of the section.

A. F. Brown—The oblong section makes a much better appearance. I have 20,000 such sections for next season's crop. My sections known as "New Prize" are 3¾ inches, by 5 inches tall, and 1½ in width; 32 go in a super on the hive.

Convention Notices.

INDIANA.—The State Bee-Keepers' Association will meet January 7 and 8, 1897, in the State House, at which time a full attendance of all bee-keepers of our State, as well as many prominent bee-keepers from adjoining States, is desired. We expect some interesting discussions on matters of importance to all lovers of the honey-bee. Come one, come all. Bring your wives, daughters and sons, that they, too, may become interested in the practical management of bees for profit.
Indianapolis, Ind. J. M. HICKS, Pres.
E. S. POPE, Sec.

Keystone Dehorning Instrument.—In the selection of an instrument for dehorning, that one which will remove the horns quickest, cutting clean and not crushing the horn, must occasion the least pain and therefore be the most humane and the best. These are among the claims made for the "Keystone Dehorning Clipper" by its inventor and maker, Mr. A. C. Brosius, of Cochranville, Pa. Write to the gentleman, who will send you circulars, testimonials, etc., which will help you to reason the matter of dehorning out to your entire satisfaction and profit.

The Grand Union Tea Company, whose advertisement appears in our paper, is an old house established in 1872; they have nearly 100 branch stores in the United States, from which they run hundreds of wagons. They are reliable in every way and their mercantile rating is of the highest standard. They will send you their catalogue free upon request. Kindly mention this paper. Address, The Grand Union Tea Co., 206 W. State St., Rockford, Ill.

Bee-Keepers' Photograph.—We have now on hand a limited number of excellent photographs of prominent bee-keepers—a number of pictures on one card. The likeness of 49 of them are shown on one of the photographs, and 121 on the other. We will send them, postpaid, for 30 cents each, mailing from the 121 kind first; then after they are all gone, we will send the 49 kind. So those who order first will get the most "faces" for their money. Send orders to the Bee Journal office.

National Bee-Keepers' Union.

PRESIDENT—Hon. R. L. Taylor...Lapeer, Mich.
GEN'L MOR.—T. G. Newman...San Diego, Cal.

BEE-BOOKS

SENT POSTPAID BY

George W. York & Co.,
Chicago, Ills.

Bees and Honey, or Management of an Apiary for Pleasure and Profit, by Thomas G. Newman.—This edition has been largely re-written, thoroughly revised, and is "fully up with the times" in all the improvements and inventions in this rapidly-developing pursuit, and presents the apiculturist with everything that can aid in the successful management of an apiary, and at the same time produce the most honey in an attractive condition. It contains 250 pages, and 245 illustrations—is beautifully printed in the highest style of the art, and bound in cloth, gold-lettered. Price, \$1.00.

Langstroth on the Honey-Bee, revised by Dadant—This classic in bee-culture, has been entirely re-written, and is fully illustrated. It treats of everything relating to bees and bee-keeping. No apiarian library is complete without this standard work by Rev. L. L. Langstroth—the Father of American Bee-Culture. It has 530 pages; bound in cloth. Price, \$1.25.

Bee-Keepers' Guide, or Manual of the Apiary, by Prof. A. J. Cook, of the Michigan Agricultural College.—This book is not only instructive and helpful as a guide in bee-keeping, but is interesting and thoroughly practical and scientific. It contains a full delineation of the anatomy and physiology of bees. 460 pages; bound in cloth and fully illustrated. Price, postpaid, \$1.25.

Scientific Queen-Rearing, as Practically Applied, by G. M. Doolittle.—A method by which the very best of Queen-Bees are reared in perfect accord with Nature's way. 176 pages, bound in cloth, and illustrated. Price, \$1.00.

A B C of Bee-Culture, by A. I. Root.—A cyclopaedia of 400 pages, describing everything pertaining to the care of the honey-bees. It contains 309 engravings. It was written especially for beginners. Bound in cloth. Price, \$1.25.

Advanced Bee-Culture, Its Methods and Management, by W. Z. Hutchinson.—The author of this work is too well known to need further description of his book. He is a practical and entertaining writer. You should read his book. 90 pages, bound in paper, and illustrated. Price, 50 cts.

Rational Bee-Keeping, by Dr. John Dzierzon.—This is a translation of his latest German book on bee-culture. It has 350 pages; bound in cloth, \$1.25; in paper covers, \$1.00.

Bienen-Kultur, by Thomas G. Newman.—This is a German translation of the principal portion of the book called BEES OF HONEY. 10 page pamphlet. Price, 40 cents.

Convention Hand-Book, for Bee-Keepers. Thomas G. Newman.—It contains the parliamentary law and rules of order for Bee-Conventions—also Constitution and By-Laws, with subjects for discussion, etc. Cloth, gold-lettered. Price, 25 cts.

Thirty Years Among the Bees, by Henry Alley.—Gives the results of over a quarter-century's experience in rearing queen-bees. Very interesting work of the kind. Nearly 100 pages. Price, 50c.

Why Eat Honey?—This leaflet is intended for FREE distribution, to create a Local Market. 100 copies, by mail, 30 cts.; 500 for \$1.25; 1000, \$2.00.

How to Keep Honey and preserve its richness and flavor. Price same as Why Eat Honey.

Alsike Clover Leaflet.—Full directions for growing. 50 for 25 cts.; 100 for 40 cts.; 200, 70c.

Apiary Register, by Thos. G. Newman.—Devotes two pages to a colony. Leather binding. Price, for 50 colonies, \$1.00; for 100 colonies, \$1.25.

Preparation of Honey for the Market, including the production and care of comb and extracted honey. A chapter from BEES AND HONEY. Price, 10 cents.

Bee-Pasturage a Necessity.—This book suggests what and how to plan. It is a chapter from BEES AND HONEY. Price, 10 cents.

The Hive I Use, by G. M. Doolittle. It details his management of bees, and methods of producing comb honey. Price, 5 cents.

Dr. Howard's Book on Foul Brood.—Gives the McEvoy Treatment and reviews the experiments of others. Price, 25 cts.

Dictionary of Apiculture, by Prof. John Phin. Gives the correct meaning of nearly 500 apicultural terms. Price, 50 cts.

Winter Problem in Bee-Keeping, by G. R. Pierce. Result of 25 years' experience. 50 cts.

Handling Bees, by Chas. Dadant & Son.—A Chapter from Langstroth Revised. Price, 8 cts.

Foul Brood Treatment, by Prof. F. R. Cheshire.—Its Cause and Prevention. Price, 10 cts.

Foul Brood, by A. R. Kohnke.—Origin, Development and Cure. Price, 25 cts.

History of Bee-Associations, and Brief Reports of the first 20 conventions. Price, 15 cts.

Honey as Food and Medicine, by T. G. Newman.—A 32-page pamphlet: just the thing to create a demand for honey at home. Should be scattered freely. Contains recipes for Honey-Cake, Cookies, Puddings, Foam, Wines, and uses of honey for medicine.

Prices, prepaid—Single copy, 5 cts.; 10 copies, 35 cts.; 50 for \$1.50; 100 for \$2.50; 250 for \$5.50; 500 for \$10.00; or 1000 for \$15.00.

When 250 or more are ordered, we will print the bee-keeper's card (free of cost) on the front cover page.

Bee-Keeping for Profit, by Dr. G. L. Tinker.—Revised and enlarged. It details the author's "new system, or how to get the largest yields of comb or extracted honey." 80 p.; illustrated. 25c.

Emerson Binders, made especially for the BEE JOURNAL, are convenient for preserving each number as fast as received. Not available to Canada. Price, 75 cts.

Commercial Calculator, by C. Ropp.—A ready Calculator, Business Arithmetic and Account-Book combined in one. Every farmer and business man should have it. No. 1, bound in water proof leatherette, calf finish. Price, 40 cts. No. 2, in the artificial leather, with pocket, silicate slate, and account-book. Price, 60 cts.

Green's Four Books, by Chas. A. Green.—Devoted to, 1st, How We Made the Old Farm Pay; 2nd, Peach Culture; 3rd, How to Propagate Fruit-Plants, Vines and Trees; 4th, General Fruit Instructor. Nearly 120 pages. Fully illustrated. 25 cts.

Green's Six Books on Fruit-Culture, by Chas. A. Green.—Devoted 1st, to Apple and Pear Culture; 2nd, Plum and Cherry Culture; 3rd, Raspberry and Blackberry Culture; 4th, Grape Culture; 5th, Strawberry Culture. 129 pp.; illustrated. 25 cts.

Garden and Orchard, by Chas. A. Green.—Gives full instructions in Thinning and Marketing Fruits; Pruning, Planting and Cultivating; Spraying, Evaporation, Cold Storage, Etc. 94 pages, illustrated. Price, 25 cts.

Kendall's Horse-Book.—35 pictures, showing positions of sick horses, and treats on all their diseases. English or German. Price, 25 cts.

Silo and Silage, by Prof. A. J. Cook.—It gives the method in operation at the Michigan Agricultural College. Price, 25 cts.

Lumber and Log-Book.—Gives measurements of lumber, logs, planks; wages, etc. 25c.

Maple Sugar and the Sugar Bush, by Prof. A. J. Cook.—Full instructions. Price, 35 cts.

Grain Tables, for casting up the price of grain, produce, hay, etc. Price, 25 cts.

Capon and Caponizing, by Dr. Sawyer, Fanny Field, and others.—Illustrated. All about caponizing fowls, and thus how to make the most money in poultry-raising. 64 pages. Price, 30 cts.

Our Poultry Doctor, or Health in the Poultry Yard and How to Cure Sick Fowls, by Fanny Field.—Everything about Poultry Diseases and their Cure. 64 pages. Price, 30 cts.

Poultry for Market and Poultry for Profit, by Fanny Field.—Tells everything about the Poultry Business. 64 pages. Price, 25 cts.

Turkeys for Market and Turkeys for Profit, by Fanny Field.—All about Turkey-Raising. 64 pages. Price, 25 cts.

Rural Life.—Bees, Poultry, Fruits, Vegetables, and Household Matters. 100 pages. 25 cts.

Potato Culture, by T. B. Terry.—It tells how to grow them profitably. Price, 40 cts.

Hand-Book of Health, by Dr. Foote.—Hints about eating, drinking, etc. Price, 25 cts.

Bee-Keepers' Directory, by H. Alley.—Latest methods in Queen-Rearing, etc. Price, 50c.

Book Clubbing Offers.

(Read Carefully.)

The following clubbing prices include the American Bee Journal one year with each book named. Remember, that only ONE book can be taken in each case with the Bee Journal a year at the prices named. If more books are wanted, see postpaid prices given with

the description of the books on this page. Following is the clubbing-list:

1. Langstroth on the Honey-Bec.....	\$2.00
2. A B C of Bee-Culture.....	2.00
3. Bee-Keeper's Guide.....	1.75
4. Bees and Honey [Cloth bound].....	1.65
5. Scientific Queen-Rearing.....	1.75
6. Dr. Howard's Foul Brood Book.....	1.10
7. Advanced Bee-Culture.....	1.30
9. Bienen-Kultur [German].....	1.25
10. Rational Bee-Keeping [Cloth bound].....	2.00
11. Rational Bee-Keeping [Paper bound].....	1.75
12. Thirty Years Among the Bees.....	1.30
13. Bee-Keeping for Profit.....	1.15
14. Convention Hand-Book.....	1.15
15. Poultry for Market and Profit.....	1.10
16. Turkeys for Market and Profit.....	1.10
17. Capons and Caponizing.....	1.10
18. Our Poultry Doctor.....	1.10
19. Green's Four Books.....	1.15
21. Gardeu and Orchard.....	1.15
23. Rural Life.....	1.10
24. Emerson Binder for the Bee Journal.....	1.60
25. Commercial Calculat r. No. 1.....	1.25
26. Commercial Calculator, No. 2.....	1.40
27. Kendall's Horse-Book.....	1.10
30. Potato Culture.....	1.20
32. Hand-Book of Health.....	1.10
33. Dictionary of Apiculture.....	1.35
34. Maple Sugar and the Sugar Bush.....	1.20
35. Silo and Silage.....	1.10
36. Winter Problem in Bee-Keeping.....	1.30
37. Apary Register (for 50 colonies).....	1.75
38. Apary Register (for 100 colonies).....	2.00
39. Bee-Keeper's Directory.....	1.30

HONEY and BEESWAX MARKET QUOTATIONS.

The following rules for grading honey were adopted by the North American Bee-Keepers' Association, and, so far as possible, quotations are made according to these rules:

FANCY.—All sections to be well filled; combs straight, of even thickness, and firmly attached to all four sides; both wood and comb unsoiled by travel-stain, or otherwise; all the cells sealed except the row of cells next the wood.

No. 1.—All sections well filled, but combs uneven or crooked, detached at the bottom, or with but few cells unsealed; both wood and comb unsoiled by travel-stain or otherwise.

In addition to this the honey is to be classified according to color, using the terms white, amber and dark. That is, there will be "fancy white," "No. 1 dark," etc.

Chicago, Ill., Dec. 8.—Fancy white, 12@13c.; No. 1, 11c.; fancy amber, 10c.; No. 1, 8@9c.; fancy dark, 8@9c.; No. 1, 7@8c. Extracted, white, 5@7c.; amber, 5@6c.; dark, 4@5c. Beeswax, 26@27c.

The offerings are large and sales drag more than usual at this time of year.

Philadelphia, Pa., Dec. 12.—Fancy white comb, 13-14c.; No. 1 white, 11-12c.; fancy amber, 10-11c.; dark, 8-9c. Extracted, white, 6-8c.; amber, 4-5c.; dark, 3-4c. Beeswax, 26c.

Comb honey arriving freely and market overstocked at present.

New York, N. Y., Dec. 12.—Fancy white, 12c.; off grades, 10@11c.; buckwheat, 8@9c. No change in extracted. Beeswax firm at 26@27c.

The market is well supplied with comb honey of all grades and styles. Fancy white is in fair demand, while off grades white and buckwheat are moving off rather slowly.

Albany, N. Y., Dec. 12.—Fancy white, 12-13c.; No. 1, 11-12c.; fancy amber, 9-10c.; No. 1 dark, 8-9c. Extracted, white, 6-7c.; dark, 4-5c.

The receipts of both comb and extracted honey are very large, and prices are somewhat lower. We have an ample stock of all styles except paper cartons weighing less than a pound.

Indianapolis, Ind., Dec. 7.—Fancy white, 14-15c.; No. 1 white, 12-13c. Extracted, white, 6-7c. Beeswax, 22-25c.

Demand is fair for grades quoted, but no demand for inferior grades.

Kansas City, Mo., Dec. 12.—Fancy white comb, 13c.; No. 1 white, 13@14c.; fancy amber, 12-13c.; No. 1 amber, 11-12c.; fancy dark, 10-11c.; No. 1, 8-10c. Extracted, white, 6-6½c.; amber, 5 ½c.; dark, 4-4½c. Beeswax, 22-25c.

Boston, Mass., Dec. 12.—Fancy white, 13-14c.; No. 1, 11-12c. Extracted, white, 6-7c.; amber, 5-6c. Beeswax, 25c.

Cincinnati, Ohio, Dec. 8.—Comb honey, 10@14c. Extracted, 4@7c. The honey market is slow in all its branches. Demand is about equal to the arrivals.

Beeswax is in good demand at 20@25c. for good to choice yellow.

San Francisco, Calif., Dec. 2.—White comb, 10c.; amber, 7½-9c. Extracted, white, 5½-6c.; light amber, 4½-4¾c.; amber colored and candied, 3¾-4¼c.; dark tulle, 2¾-3c. Beeswax, fair to choice, 25-27½c.

Milwaukee, Wis., Dec. 12.—Fancy white' 14-15c.; No. 1, 12-13c.; No. 1 amber, 8-10c. Extracted, white, 6-7c.; amber, 5-6c.; dark, 4-5c. Beeswax, 22-24c.

New crop of honey begins to come forward. The demand is very poor and quotations almost nominal. Weather is very warm and the consumption of honey is very small. Plenty of fruit, and hence the appetite is satisfied with same in preference. Later on we expect an improved demand for honey of all kinds.

Cleveland, Ohio, Dec. 12.—Fancy white, 14½@15c.; No. 1 white, 12½@13c. Extracted, white, 6@7c.; amber, 4½@5½c. Beeswax, 22@25c.

There is not very much honey in our market. Selling rather slow. Demand beginning to be a little better. Think trade will be fair in this line this fall.

St. Louis, Mo., Dec. 9.—Fancy white, 14c.; No. 1 white, 12@13c.; fancy amber, 11@12c.; No. 1 amber, 10@10½c.; fancy dark, 9@9½c.; No. 1 dark, 7@8c. Extracted, white, in cans, 6@7c.; in barrels, 5@5½c.; amber, 4½@4¾c.; dark, 3½@4c. Beeswax, 26½@27c.

Baker stock of extracted honey, 4@5c; stock very scarce. Fair receipts of comb. Beeswax in good demand.

Detroit, Mich., Dec. 12.—No. 1 white, 12-12½c.; fancy amber, 10-11c.; No. 1 amber, 9-10c.; fancy dark, 8-9c. Extracted, white, 5½-6c.; amber, 5-5½c.; dark, 4-5c. Beeswax, 24-25c.

Minneapolis, Minn., Dec. 12.—Fancy white, 12½c.; No. 1 white, 10@11c.; fancy amber, 9@10c.; No. 1 amber, 8@9c.; fancy dark, 7@8c.; No. 1 dark, 6-8c. Extracted, white, 5½@6½c.; amber, 5@5½c.; dark, 4@5c. Beeswax, 23@26c.

The demand for both comb and extracted is very quiet, and for the latter, nominal. The hot weather of the past week or so has checked demand for comb honey.

Buffalo, N. Y., Dec. 11.—Fancy 1-pound comb is quiet at 11@12c.; No. 1, 10@11c.; dark and poor require hard pushing at 9@4c.

Queens and Queen-Rearing.

If you want to know how to have queens fertilized in upper stories while the old queen is still laying below; how you may safely introduce any queen, at any time of the year when bees can fly; all about the different races of bees; all about shipping queens, queen-cages, candy for queen-cages, etc.; all about forming nuclei, multiplying or uniting bees, or weak colonies, etc.; or, in fact, everything about the queen-business which you may want to know—send for Doolittle's "Scientific Queen-Rearing"—a book of over 170 pages, which is as interesting as a story. Here are some good offers of this book:

Bound in cloth, postpaid, \$1.00; or clubbed with the BEE JOURNAL for one year—both for only \$1.75; or given free as a premium for sending us three new subscribers to the BEE JOURNAL for a year at \$1.00 each.

Please Send Us the Names of your neighbors who keep bees, and we will send them sample copies of the BEE JOURNAL. Then please call upon them and get them to subscribe with you, and secure some of the premiums we offer.

List of Honey and Beeswax Dealers.

Most of whom Quote in this Journal.

Chicago, Ills.

R. A. BURNETT & Co., 163 South Water Street.

New York, N. Y.

HILDRETH BROS. & SEGELKEN,

Kansas City, Mo.

O. C. CLEMONS & Co., 423 Walnut St.

Buffalo, N. Y.

BATTERSON & Co., 167 & 169 Scott St.

Hamilton, Ills.

CHAS. DADANT & SON.

Philadelphia, Pa.

WM. A. SELSER, 10 Vine St.

Cleveland, Ohio.

WILLIAMS BROS., 80 & 82 Broadway.

St. Louis, Mo.

WESTCOTT COM. Co., 213 Market St

Minneapolis, Minn.

S. H. HALL & Co.

Milwaukee, Wis.

A. V. BISHOP & Co.

Boston, Mass.

E. E. BLAKE & Co., 57 Chatham Street.

Detroit, Mich.

M. H. HUNT, Bell Branch, Wayne Co., Mich.

Indianapolis, Ind.

WALTER S. POWDER, 162 Massachusetts Ave.

Albany, N. Y.

CHAS. MCCULLOCH & Co., 380 Broadway.

Cincinnati, Ohio.

C. F. MUTH & SON, cor. Freeman & Central avs.

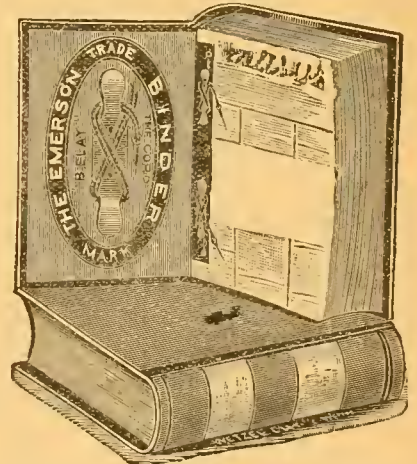

We have a few of these Emerson stiff cloth-board binders for the American Bee Journal. They make a splendid permanent binding, and hold a full year's numbers. The old price was 75 cents, postpaid, but will mail you one for only 60 cts., or with the Bee Journal for one year—both together for \$1.50.

GEORGE W. YORK & CO., CHICAGO, ILLS.

THROAT AND LUNG DISEASES, DR. PEIRO, Specialist
Offices: 1019, 100 State St., CHICAGO. Hours 9 to 4.

Mention the American Bee Journal.
READERS Of this Journal who write to any of our advertisers, either in ordering, or asking about the Goods offered, will please state that they saw the Advertisement in this paper.

Bottom Prices

**BRING US BIG TRADE.
GOOD GOODS KEEP IT.**

If you want the best supplies that can be made at a little less cost than you can buy the same goods for elsewhere, write to us for low prices. 1896 Catalogue now ready—ask for it and a free copy of *The American Bee-Keeper* (36 pages).

Address,
THE W. T. FALCONER MFG. CO.,
JAMESTOWN, N. Y.
Mention the American Bee Journal.

Honey-Clovers & Buckwheat SEED FOR SALE.

We have made arrangements so that we can furnish seed of several of the Clovers and Japanese Buckwheat, by freight or express, at the following prices, cash with order:

	5lb	10lb	25lb	50lb
Alsike Clover	\$.70	\$1.25	\$3.00	\$ 5.75
Sweet Clover	.65	1.20	2.75	5.00
White Clover	1.25	2.00	4.50	8.00
Alfalfa Clover	.65	1.10	2.70	5.00
Crimson Clover	.55	.90	2.00	3.50
Jap. Buckwheat	.20	.35	.90	1.25

Prices subject to market changes.

Add 25 cents to your order, for cartage, if wanted by freight.

Your orders are solicited.

GEORGE W. YORK & CO.,
CHICAGO, ILLS.

BEGINNERS.

Beginners should have a copy of the *Amateur Bee-Keeper*, a 70-page book by Prof. J. W. Rouse. Price 25 cents; if sent by mail, 28c. The little book and the *Progressive Bee-Keeper* (a live, progressive 28-page monthly journal) one year, 65c. Address any first-class dealer, or

LEAHY MFG. CO., Higginsville, Mo.

WHEN ANSWERING THIS ADVERTISEMENT, MENTION THIS JOURNAL.

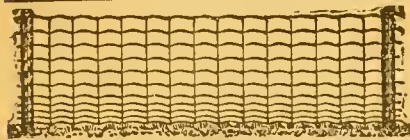

Mixed Farming Best.

With favorable weather, wise management and a good market, the specialty farmer sometimes makes a grand showing. However, mixed husbandry is safer, and in the long run will usually give best results. Where a variety of domestic animals are kept, **Page** fence will be found not only a luxury, but almost a necessity. See catalogue.

PAGE WOVEN WIRE FENCE CO., Adrian, Mich.

Mention the American Bee Journal.

Special Renewal Offers!

Prompt renewals are so desirable that I am going to make some special offers. For \$1.00 I will send the *Bee-Keepers' Review* for 1897 and the 50c. book, "Advanced Bee-Culture," or, in place of the book, 12 back Nos. of the *Review*. For \$1.50 I will send the *Review* and a fine tested Italian Queen—Queen to be sent early in the season of 1897. For \$1.75, the *Review* and a \$1.10 Bingham (Conqueror) smoker, postpaid. For \$2.50, the *Review* and 1000 No. 1, first-class, one-piece Sections. But REMEMBER, that these offers will be withdrawn Jan. 1st, as the sole object in making them is to induce the sending in of subscriptions before that date. New subscribers will get the Dec. No. free. If not acquainted with the *Review*, send for samples.

W. Z. HUTCHINSON, FLINT, MICH.
Mention the American Bee Journal.

BEE SWAX WANTED

—FOR—

Foundation Making.

Send For OUR CATALOGUE,

SAMPLES OF FOUNDATION,

ADVICE TO BEGINNERS, Etc.

Address,

CHAS. DADANT & SON,

HAMILTON, ILL.

WHEN ANSWERING THIS ADVERTISEMENT, MENTION THIS JOURNAL.

Ask Your Friends to Take This Journal.

* Extracted Honey *



Finest Quality. Basswood and Clover.

2 60-lb. cans in case, 7c. per pound. 1 60-lb. can in case, 8c. per pound. A sample by mail, 10 cts. **POUDER'S Honey-Jars and Complete Line of Supplies.** Catalogue Free.

WALTER S. POUDER,
162 Mass. Avenue. INDIANAPOLIS, IND.

PATENT WIRED COMB FOUNDATION



Has No Sag in Brood-Frames

Thin Flat-Bottom Foundation

Has No Fishbone in the Surplus Honey.

Being the cleanest is usually worked the quickest of any Foundation made

J. VAN DEUSEN & SONS,
Sole Manufacturers,
Sprout Brook Montgomery Co., N. Y.

Cut Prices to Move Stock !!

There are a few items of desirable stock left of the goods secured of Thomas G. Newman when we took charge of his supply business here. In order to close these out and make room for fresh, new goods, we have decided to offer these at prices which will make them go.

The following is the list, which will be corrected as the stock is sold; if you see what you want here, order AT ONCE, or you may be too late:

- V-Top Langstroth Frames, 75c per 100; 250 for \$1.25; 500 for \$2.
- All-Wood Frames, pierced for wire, same price while they last.
- Hoffman Frames, with 3/8-inch square bottom-bar, \$1.25 per hundred.
- 15 No. 1E 8-fr. Dov. Hives, with bevel cover, 5 for \$3.50; the lot, \$10.
- 45 " " " " , with flat " " , 5 for 3.50; " 30.
- 20 " " " " " " , 5 for 4.00; " 15.
- 5 No. 9 " L. Hives, 2-story, with Heddon supers, \$2.50 for the lot.
- 4 1 1/2-story, 8-fr. Hives, nailed, complete, \$1.00 each; \$3.00 for the lot.
- 50 Comb Honey Racks, to hold sections on the hive, flat, \$1.00 for the lot.
- No. 3 VanDeusen Thin Flat-Bottom Fdn., in 25-lb. boxes, \$10.50 a box.
- Wakeman & Crocker Section-Press, 50c each (old price, \$1.25).
- Townsend Section-Press, 50c. (old price, \$1.)
- Hastings' Feeders, 10c each (old price, 25c.)
- 18 Shuck Feeders, 8c each, \$1.00 for the lot (old price, 20c.)
- Hill Feeders, quart size, 8c each, 75c per doz. (less than half old prices).
- Hill Smokers, 40c each; by mail, 60c.
- Quincy Smokers at 50c, 70c, and \$1.00 each—20c extra by mail.
- Jones' Frame-Pliers, 10c each; by mail, 10c extra (old price, 25c and postage).

If wanted by Freight, add 25c for cartage on orders for less than \$5

THE A. I. ROOT COMPANY,

Geo. W. York, Manager.

118 Michigan Street, CHICAGO, ILL.

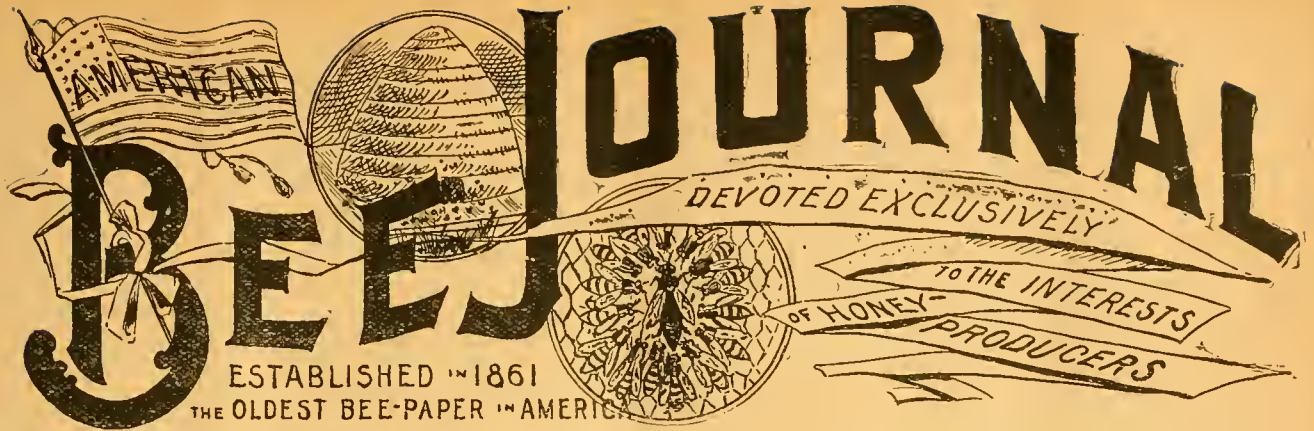

AMERICAN BEE JOURNAL

DEVOTED EXCLUSIVELY TO THE INTERESTS OF HONEY-PRODUCERS

ESTABLISHED 1861
THE OLDEST BEE-PAPER IN AMERICA

Published Weekly, at \$1.00 per annum.

Sample Copy sent on Application.

36th Year.

CHICAGO, ILL., DECEMBER 24, 1896.

No. 52.

CONVENTION PROCEEDINGS

Proceedings of the Illinois State Bee-Keepers' Convention Held in Chicago, Nov. 18 and 19, 1896.

BY A SPECIAL BEE JOURNAL REPORTER.

[Continued from page 806.]

WINTERING OUT-DOORS WITH TOP PACKING ONLY.

Ques. 5.—Has any one here had experience in wintering bees out-doors with top packing only?

Mr. West—I winter my bees altogether that way. I just put a cushion on top of the frames. I take off the supers, put on the cushion, and with the old Simplicity hive the cover is large enough to go on top.

Dr. Miller—How long have you done that?

Mr. West—Altogether ever since I used the Simplicity hives in the spring of 1877. I used just a few then, and I went on and increased until I had over 100 at a time.

Dr. Miller—Will you tell us what was the result in the worst winter you had?

Mr. West—I don't think I ever lost more than 4 or 5 per cent.

Dr. Miller—What is your best result?

Mr. West—I have come through with all.

Dr. Miller—What is the largest number you ever had when you came through with all?

Mr. West—100. For a few seasons I had a trifle over 100. I have got a good place, and don't count on losing any at all.

Dr. Miller—Tell us about the hive-entrance.

Mr. West—It is just the same in the winter as in the summer. In the Simplicity there is room made by setting the hive forward, and I set over $1\frac{1}{2}$ inches, and it is that way all the year around; but with the Dovetail hive there is just a $\frac{3}{8}$ strip under the hives. I have a few Dovetail, but the Simplicity are all 10-frame.

Mr. Green—I have used that plan more or less for a number of years, but two years ago I tried it comparatively with a few to ascertain the difference, and I will never do it again unless as an experiment. I pack most of my bees in large outside boxes, pack them all around, and in these that year the loss was less than 10 per cent., and in those with only packing overhead, the loss was at least 75 per cent.

Mr. West—I have my bees on the west side of a tight-board fence, and also on the north, but the south is all open, and on the southeast is a wood-shed and honey-house.

Dr. Miller—I wonder if that board fence doesn't make a very big difference on the north and west side?

Mr. West—It is possible; I thought it did.

Mr. Baldwin—I adopted that with one hive. I put on half supers instead of whole ones. I use the half supers and

fill them with leaves, with a heavy cushion and T tins on top of the frames. It is merely an experiment, but I am going to try 17 that way.

Mr. West—Some years ago I used leaves instead of chaff, and filled the supers.

Dr. Miller—I tried one colony last winter in that way, and it came through all right (I saved 100 per cent. of it), so this year I have 10 out. I don't know how they will come through. It may be a very severe winter, and I may lose 100 per cent. Mine are packed a little differently from what has been mentioned. The first story has frames with more or less honey in, then the second story contains the colony and brood-nest, and then there is a third story in which I put a piece of burlap and then dry leaves. The entrance is, if anything, larger than the summer entrance, for the entrance is 12x2 inches; but that entrance being down 10 inches below the brood-nest, I think there is not much danger that there would be too much cold. There would be too heavy a current of air if the brood-nest were in the lower story. Although there might be a larger amount of air as it is, there can be no direct draft on them.

FEEDING TO PROMOTE QUEEN-LAYING.

Ques. 6.—When should feeding begin in the spring to promote queen-laying? How much should be fed? How often?

Miss Candler—I used to do so some years ago, but I have not done it of late years. I commenced as soon as the evenings were warm—as soon as I could feed at the front.

Dr. Miller—Please tell us the result of it.

Miss Candler—Why, I didn't notice very much difference. I think they do just as well, if not better, if one gives them plenty of honey and does not feed them at all.

Dr. Miller—Mr. Green, tell us your time of beginning.

Mr. Green—I say it should not be begun at all. I think the best plan is, to let them have plenty of honey and not feed them. I can remember feeding very early and feeding until late—that was with candy over the brood-frames, and it might have been that they would have done just as well, if not better, without, but the results were very good at that time.

Dr. Miller—I notice some of the German writers speak very highly of what they call "speculative feeding." They talk as if they got very good results from it. There may be a difference in the two countries in that respect. I think I have noticed this, that pretty generally a healthy colony of bees with an abundant supply of stores—remember I am saying more than a plenty—I think I generally find that in that hive there will be all the brood that the bees can cover and take care of. Now, if they have, what more can you do with stimulative feeding? You may get a queen to lay, but you cannot have any more brood than they can take care of. It is possible there may be cases in which it would do good, especially where they have not enough stores.

Mr. Baldwin—I have tried it, but with no success, from the fact that perhaps they next day it would be so cold, and I thought it wasn't a success in any way, and I think so yet. If you could give them the fresh feed it makes them fly. I examine my hives as soon as I can, and give to the weak colonies from the strong. I take from them brood but leave their honey, so they have confidence that they have plenty. I think this preferable to any other plan I have adopted.

Dr. Miller—Now, the next question—How much should be fed? Suppose you do think it advisable to feed, how much would you think advisable? Suppose feeding is done every day, then how much would you feed if you were feeding for stimulating?

Mr. Green—I have fed considerable in the spring when I was obliged to. I think the best plan is to let them have enough in the fall so you are sure, and then don't disturb them until the honey season comes, and I prefer, all things considered, to feed out-doors, and to feed so they get all they can well take care of. There is occasionally a great deal of loss. I remember one time when a rainy day came, and a great many thousand bees were drowned, and that is the greatest objection I know to that style of feeding. Aside from that I should prefer it to any style of feeding I know of. Of course, sometimes the neighbors' bees will get a share of your feed, but if your bees are very much in the majority there is so much of a saving. I would risk that.

Dr. Miller—What amount would you feed per day, if you fed every day?

Mr. Green—All I could afford to.

Dr. Miller—I suppose it would depend very much upon the needs of the bees.

Mr. Green—I should want to see that they got in a thrifty condition. Two years ago I had to feed in the spring, and I fed two barrels of sugar in about two weeks.

Dr. Miller—Here are two cases, one is, the bees have a fair plenty, and you are feeding only for the purpose of stimulating.

Mr. Green—In that case I should guess about half a pound a day.

Mr. Baldwin—Not to exceed a pound.

Dr. Miller—On the other hand, suppose you have the two things to do. They are going to be short of stores and you want them provided for, and you want the advantage of the stimulating, if there is an advantage.

Mr. Green—In that case it is simply a question how much they need. You might feed from one to three pounds a day.

Mr. Baldwin—In case of bare necessity it makes a vast difference to the question asked, "How much would you feed to stimulate laying?"

Dr. Miller—The remaining question in connection with that is, How often would you feed for stimulating purposes?

Mr. Green—Every day.

Dr. Miller—A question that comes to me in very close connection with that suggests itself just now. Here is a colony of bees that has enough, you think, to last it through until nearly the time of fruit-blooming, but you want it to have more, will you feed it in the fall or in the spring?

Mr. Baldwin—I would feed it in the fall, every time—September.

Dr. Miller—How many think it is better to feed in the fall? [Six.] How many think it is better to feed in the spring?

Mr. Green—If I was sure they had enough for winter, I would wait until spring; if I wasn't, I would feed them.

Dr. Miller—Tell us why you would feed in the spring rather than the fall?

Mr. Green—You might save some honey on colonies that would die during the winter; that is about the only advantage. If I wasn't counting the loss in winter, I should much prefer to feed in the fall.

Dr. Miller—I think Mr. Doolittle takes the ground that it is much better to feed in the spring. May be I am wrong about that, but some one not very long ago said that there was an advantage in feeding in the spring. It does seem to me, however, that there is an advantage in having the stores through the winter. Here is a hive with a certain amount of space, your bees to be wintered in that, and you fill up part of that space with honey, and I believe they are better off than having air there. When they have a big lot of stores inside it seems to encourage them in some way.

Mr. Baldwin—If the queen has enough to have "confidence" to lay, she will go on. I will give my queen "confidence," by giving her plenty.

GETTING THE PUBLIC TO USE HONEY.

Ques. 7.—What can bee-keepers do to induce the public to use honey more generally as food?

Mr. Green—Sell it to them.

Dr. Miller—Do you know of any one thing, for instance, that any one of us ought to do more than we are doing to help in that direction?

Mr. York—Mr. Baldrige could help us out on that.

Mr. Baldrige—I dispose of it by giving it away. One family where I live used in the last year 20 or 25 pounds in the way of exchange, and they would not have used five pounds, if I had asked them to buy it.

Dr. Miller—Then it is really not given to them, it is a trade.

Mr. Baldrige—They gave me papers in exchange for it.

Mr. Chapman—I believe if we could remove the taint that

South Water street lends to the honey on the score of adulteration, a great many more families would want to eat honey than now do. Take, for instance, the California Honey Exchange principle; if that was applied to the market here, and the Exchange could guarantee that the extracted honey was a good article, you would find a great many people would eat it, whereas, now they don't know whether it is pure or not. I have followed the Elgin Butter Exchange and their methods. At the time that Exchange was formed in Elgin, on South Water street were adulterators of butter—sold oleomargarine, and it affected the price of butter seriously, so that they didn't get nearly the results they got after the Exchange was established, which raised their profits, or made it a profitable business, or took the butter market away from South Water street, so they always get a profit out of their goods. It took away the taint from the market here of adulterated goods.

Dr. Miller—Cannot these men, who had been adulterating, continue?

Mr. Chapman—Yes, sir, they did continue, and the result was that Elgin butter sold for so much more than the adulterated, and the whole people rose up and we got a law to stop them. Now you can go there and buy butter as well as you can in Elgin. If you could establish a honey exchange in this market, and people knew what they were buying, they would buy it. I know from my own experience that the majority of retail dealers never know that they are buying a good article of honey there. They cannot guarantee it to their customers.

Mr. Grabbe—May I ask Mr. Chapman of what place he is speaking?

Mr. Chapman—I am speaking of South Water street. I have seen the workings as applied to that particular product—butter. As long as there was a pound here it hurt our market so that the Eastern people refused to use our goods because of adulteration. Then they took the market in their own hands and controlled it. The people sent there for the pure article, and then when they found out it was all over this country that it was hurting them, and they were not in the Exchange, they rose up and got the "oleo" law, and, of course, that put Chicago back in the butter market. If you can get a similar Exchange here, so that the people could know when they bought that brand of goods it was not adulterated, I am satisfied it would increase the demand.

Mr. Grabbe—I have had a little experience here in the city selling to grocers. I have a gentleman out soliciting orders for me. He carries a sample of honey that he claims there is no honey in it at all. Mine costs \$1.80 a dozen jars, and the other is put up by a firm here in the city for 60 cents. He tells them here is the pure honey, and this other has no honey in it at all, and he sells as much of that in which there is no honey in it at all; they have a trade for it, and possibly buy it two to one because they get it cheap. Go on Milwaukee avenue, and every dealer is stocked with honey, and the grocery men will tell you that there is no honey in it at all, and the people buy it because it is cheap. I have gone into one of the largest stores in Chicago, and found them retailing it for five cents, and it goes like hot cakes, and there is no honey in it at all. How are going to educate the people to eat pure honey? I went into a store on 22nd street, yesterday; I showed them some honey, and they said it sells slowly. There was some they were selling for 12 cents, which goes fast. The people buy that and like it. They don't sell it for honey. What are you going to do with them in that case?

Mr. Chapman—The principle is almost identically the same. Selling butter has not affected the "oleo," and won't, because it is cheap, and for no other reason; but there are people who will only have the pure goods. The effect of that law has been that the prices of the good article have risen, and the cheap has declined. The men who want the pure honey would be willing to pay the better price for it. It would reduce the price of glucose to the proper level. There are a great many people who want that.

Mr. Grabbe—There are a great many dealers who will not keep it.

Dr. Miller—Do you think the commission men, or those who keep that, all know there is no honey in it?

Mr. Grabbe—The grocer men tell me they tell them?

Dr. Miller—If they know what they are buying, and the thing is before them—

Mr. Grabbe—Sometimes it is labeled "pure honey."

Dr. Miller—That is the trouble.

Mr. Grabbe—Thousands of the families in the city who cannot read or write, buy that for honey, and they believe it is pure honey, and you give some of them a pure sample of honey and they will send it back and say it is not pure. They take the glucose—they prefer that to pure basswood honey.

Mr. Green—That is one of the difficulties that we have to

contend with. The mixer of honey can make a compound that is better appreciated than many varieties of pure honey.

Mr. Baldwin—If they make that compound and sell it as that compound I see no trouble about it. If it is sold as that, I think it is all right, and I think we have no law against it, either.

Mr. Grabbe—It should not be branded as "pure honey."

Dr. Miller—Is there any law against branding it "pure honey," and selling it for adulterated honey?

Mr. Chapman—There is a law that applies to manufactured goods—it applies to splices. A man cannot sell these goods that they adulterate without making the statement of the fact.

Dr. Miller—Can he sell glucose labeled "pure honey?"

Mr. Chapman—I don't know.

Dr. Miller—I think we are getting down to the bottom of it now.

THE ADULTERATION OF HONEY.

Mr. York—I don't believe that the people would buy glucose if they *knew* that it was glucose, in most cases. I had an experience lately with one of the largest Chicago department stores. I went there to investigate the kind of honey they were selling. I took my card, and also a copy of the American Bee Journal, and told them I should like to look at their honey. The clerk said: "We have some very fine honey here, guaranteed pure, absolutely." It was in a three-cornered glass, and it had probably half a dozen pieces of comb, perhaps 3x2 inches in size, and then filled in with a liquid. I told him I would like to taste it. I wanted to take only a little on the end of my knife-blade, when I assured him it was wholly glucose. He asked me to sample another, and I did so, and told him it was nearly all glucose—not quite all. The taste of the villainous stuff I sampled was in my mouth for an hour afterwards. Now, to prove that the people don't want to buy glucose, I would say: I met a gentleman in the city here who said his wife had purchased a glass jar of "honey" at the same large store, and they couldn't eat it—had to throw it away. I also asked him if he had noticed any honey in the local groceries near where he lived, and he said he had, but was afraid of it. I asked him what name was on the jar, and when he told me, I assured him it was all right, for I had put it up myself for the man who sold it to the grocer. I am sure that if that family began to use pure honey they would use a lot of it. But now they are prejudiced against honey—they are afraid of being swindled again. They think they cannot get the pure article, and they take the other, and then don't want any more of it. The only way to meet this question is to get an *anti-adulteration law*, and then let the bee-keepers *back it up*. I might say further in regard to that department store: The clerk wished me to meet the buyer, whom I found to be a very pleasant gentleman, something of a chemist, too. He hadn't sampled the "honey" that they were selling, so he told the clerk to bring him both samples. He sampled them, and at once ordered the clerk to remove the three-cornered jars from the counter. He said: "Of course that is not honey; you can tell that without any chemical analysis. It costs enough to be pure goods. It was bought of a St. Louis firm." The other he sampled, and said: "That is not up to grade. We will not use any more of that honey." I thought I had won somewhat of a victory that time. Since then I have had Mr. Grabbe go there, and he has made a sale. I think after this, when they get their customers to using *pure* goods, they will sell any amount of it. I don't doubt it. To work on the adulterators who use anything but the pure goods I think we should have a good anti-adulteration law. I believe we could get after them in a way that would make them stop pretty quick. They come into my office, and I lead them on until they tell the whole thing—just how much glucose they put in, etc. I can get the whole thing, but what is the good of it until we get a law? If we get that I will help to get plenty of evidence to convict the adulterators of honey. As I explained at the Lincoln convention, the adulterators buy glucose here for \$1.10 per 100 pounds, that has not the least taste to it; then they mix it with basswood or other strong-flavored honey, and simply multiply the pure product ten times by the use of glucose. I wish we could take some action that would lead towards putting a stop to honey-adulteration. We might have a committee appointed to present the matter to our State legislature, or to work in connection with the dairymen. I move that the Executive Committee of the Association be requested to take action in regard to securing an anti-adulteration law; to work in connection with the dairymen and others who are equally interested in a like law. I might say further, that I think it is useless to try to get a law against the adulteration of honey alone. The only way we can accomplish anything is to co-operate with other interests that are just as anxious to have anti-adulteration laws.

Mr. York's motion was carried unanimously.

Dr. Miller—I believe that is a move in the right direction. Let me suggest one thing that I think can be done towards establishing a better market for honey, and that is the matter of the quality of the honey that is put on the market. I speak particularly of extracted honey. I know a bee-keeper who put upon the market some extracted honey that was mainly honey-dew. It was black stuff, a vile concoction not fit for any market or stomach. He was told that was manufactured stuff. He had German blood in him, and he said he knew better. He insisted that the bees had collected it, and kept it on the market. The result was, either people thought it wasn't honest or they didn't like honey, and it hurt the market very much. I won't give you the man's name, but that was the result of it. It was a good many years ago, and I am older now—I wouldn't do it now. You can see how the thing would work. There are all grades of honey, and if you put a good thing on the market you are helping it along, and if you put on something that is off-flavor or sour, you create a prejudice against the good honey. I think I can recall the time when I thought there was no difference in honey. Honey was honey, and that was all there was of it. If you have control of your own home market, keep nothing but the very best there. If you get a bad article you had better throw it in the fire and burn it up; but you don't need to do that—you can use it for feeding the bees; but put the best article on the market and keep it there, and you are doing a great deal toward creating the demand for a good article.

Mr. York—It has been suggested by some to send the "off grades" to the city bakers. It could also be used for honey-vinegar, and some who make this vinegar have a demand for all they can make, and the vinegar is most excellent. There was some on exhibition at the State Fair at Springfield this fall. I sampled some, with Mr. Grabbe the judge, and it was the finest vinegar I ever tasted.

Dr. Miller—What do you mean by it being the finest?

Mr. Grabbe—The flavor and strength.

Mr. York—It could be diluted one-half before using, and still be excellent.

Mr. Grabbe—The Hutchinson brothers exhibited it; they had several grades.

Mr. Baldrige—I have been in the retail honey market enough to know that it is very necessary to keep the flavor and color of honey the same, that is what the retail grocers want. Don't put any off grades on the market to be used for table purposes.

Mr. Grabbe—I coincide with the gentleman on the quality and grade. Most of mine is a fine quality of Missouri honey, and a peculiar flavor from what honey they have here, and I have not tried to sell that here, but in St. Louis. There the honey that is known as Spanish-needle sells for 7 cents at wholesale, and I have been getting white honey here for less than that. Not white clover, but sweet clover, alfalfa and basswood honey, for considerably less than 7 cents. Here consumers don't want any dark color—it must be light. Spanish-needle honey is a golden yellow, and groceryman object to it on that account. The whiter the better; buckwheat honey you could not sell at all. I have one customer who gets buckwheat honey, but honey should be white—all white—for this city.

[To be continued.]

A New Binder for holding a year's numbers of the American Bee Journal, we propose to mail, postpaid, to every subscriber who sends us 20 cents. It is called "The Wood Binder," is patented, and is an entirely new and very simple arrangement. Full printed directions accompany each Binder. Every reader should get it, and preserve the copies of the Bee Journal as fast as they are received. They are invaluable for reference, and at the low price of the Binder you can afford to get it yearly.

The Names and Addresses of all your bee-friends, who are not now taking the Bee Journal, are wanted at this office. Send them in, please, when sample copies will be mailed to them. Then you can secure their subscriptions, and earn some of the premiums we have offered. The next few months will be just the time to easily get new subscribers. Try it earnestly, at least.

The McEvoy Foul Brood Treatment is given in Dr. Howard's pamphlet on "Foul Brood; Its Natural History and Rational Treatment." It is the latest publication on the subject, and should be in the hands of every bee-keeper. Price, 25 cents; or clubbed with the Bee Journal for one year—both for \$1.10.

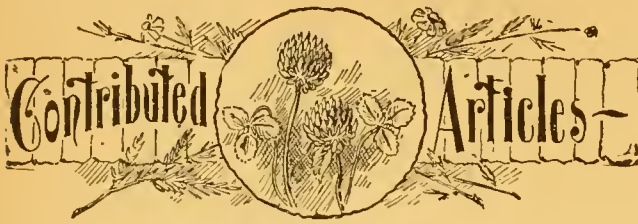

Something About Bee-Cellars—A Talk.

BY G. M. DOOLITTLE.

A correspondent wishes me to give the readers of the American Bee Journal something about bee-cellars—how they should be ventilated, where they should be situated, what the temperature inside should be, etc., saying, "More and more bees are being wintered in cellars hereabouts, and as more attention is being paid to this matter, undoubtedly many would be interested in an article from your pen on this subject." I have often written on this subject in the past, and had supposed I had written about all that was necessary, but perhaps a few general remarks on the subject may not be amiss, so, with the editor's permission, I will give a sort of rambling talk on the matter.

To my mind, it matters very little how a cellar is built, providing it accomplishes the purpose for which it is intended, that is, keeping a uniform temperature inside, no matter what are the changes outside, as this is the one desideratum for the perfect wintering of bees in cellars. Of course, you will want the cellar large enough to accommodate all the bees you will ever expect to put into it, if you are contemplating building for that purpose. If it can be built in a sidehill it will better accomplish the keeping of an even temperature than a cellar under a house can be made to do, and this is the reason why I prefer the outside cellar or cave.

If the cellar under your house can be partitioned off so that the apartment for the bees need not be disturbed by the constant going after vegetables, etc., and so that an even temperature can be maintained, such a cellar is equally as good as an outside cellar. The trouble with the cellar under the house lies in the fact that the cold and warm air produced by the varying temperature of winter passes through the floor of the rooms above, so that no even temperature can be kept below. If the space under the floor, between the sleepers, can be filled with chaff or sawdust, it will help much to obviate this trouble.

If the cellar is dug in a sidehill I would have it long and narrow. Mine is 24 feet long, 7 wide, 6 high, and is large enough to accommodate about 100 colonies with plenty of room for an alley way between the hives, which are set next the wall on either side. From this you can get at about the size you may need. The cellar in the sidehill has another advantage, in the fact that the path into it will be on a level with the ground outside, so that the hives can be set on a spring wheelbarrow and wheeled right where you wish them into the cellar. This one item alone would almost, or quite, pay for the outside cellar in the course of 20 years.

Some seem to think that it is very important that the cellar should be dry, so that no moisture nor drops of water ever collect on the walls or hives; but all of my experience goes to prove that, if the temperature can be kept between 43° and 48°, all the moisture that will naturally accumulate in any cellar will do no harm. My cellar is so moist that drops of water stand all about overhead and on the side-walls of the room, yet the bees do not seem to be affected in the least by it.

I am coming to think more and more that the matter of ventilation is not so important as we used to think, as my bees winter in splendid condition with no special provision being made for ventilation. Let me explain a little:

When I built my cellar I constructed a sub-earth ventilator 100 or more feet long, in connection with a direct upward ventilator of the same size. Either of these could be controlled at will, and every change of weather found me changing these ventilators. This made so much work that after a little I began to leave the upper one closed for a time; and at times of much cold the sub-earth ventilator was closed also. By close watching I could not see that it made any difference with the bees, so I soon came to a point where I left the ventilators closed all the time. As this keeping all ventilators closed gave a more even temperature the upper ventilator was dispensed with altogether a few years ago, when I had to renew the roof to the cellar, while the sub-earth ventilator has not been in use for three years.

If I had a cellar in which the temperature falls lower than 40°, I would put a slow fire in it, so that, when there is much severe weather the temperature might be kept up at 43° to 48° if possible. A change of 10° to 15° in temperature is liable to make the bees uneasy, cause them to go to breeding, get the diarrhea and spring dwindle.

If the cellar is under a house some seem to think that a small pipe from the chimney above the fire, running down to within a few inches of the cellar-bottom, to be used in a warm time, is a good thing in that it causes a change of air during a warm spell, which results in keeping the bees quiet with a much higher temperature than they would without this change of air. I am not so sure on this point; but if I had a cellar that would insist on going to 50° and above, every warm spell during the winter, I would try it. With me I consider a temperature of from 43° to 45° to be the best for a cellar; but I would say that the temperature which is *best* is the one in which the bees are the most quiet. That may not be the same with others that it is with me; therefore I would advise all to keep watch closely, and when they find where the bees are the most quiet, control the temperature *just* there as nearly as may be ever afterward.

Bees will be quiet in a much higher temperature the forepart of winter than during the latter part; therefore the cellar which will cool off a little as the winter advances is much the best, providing it will not rise when the weather begins to warm up in the spring.

Onondaga Co., N. Y.



That Discussion on Sections and Separators.

BY EDWIN BEVINS.

In the report of the proceedings of the Lincoln meeting of bee-keepers I see what purports to be a discussion of the question, "Are one-pound sections scalloped out enough to allow bees to pass through with ease when we use separators?" Some things were said, following the introducing of the question, but not much that had any particular bearing on the question itself.

Mr. Kretchmer made an ineffectual attempt to bring the discussion to bear on the point in controversy, and then the discussion (?) was cut off by the President before much of anything was elicited that could in any way be helpful or satisfactory to bee-keepers.

Mr. Westcott did say that the section should be cut out 1/6 of an inch, but when Mr. Stilson asked him what kind of separators he used, he replied that he used scalloped sections. Then Mr. A. I. Root says: "I should hardly think that there is any trouble about these being made shallow enough. They have been made deeper and shallower." Now, will somebody be so kind as to lift the veil of mystery which shrouds the meaning of this remark of Mr. Root's? What sense it has when applied to sections I have not yet been able to comprehend.

In reply to the question of J. E., on page 746, Dr. Miller tells him that, "The kind called section-holders have tin sep-

arators attached to the holders, and T supers have loose wooden separators." Now, have I been following an unorthodox practice in the use of separators, or is Dr. Miller away behind the times? I have been using section-holders and loose wooden separators, such as they send out from Medina to be used together, and supposed I was doing the proper thing. Whether it is the proper thing or not, I shall keep on using them. Nobody can run fast enough to give me tin separators, or T tins, either.

With regard to separators, I will say that I use some that are scalloped on both edges, and some that are scalloped on only one edge. These separators are just as wide as the section is deep. Most of the sections I have used have had openings, when two scalloped edges were placed together, of $\frac{3}{8}$ of an inch. Some of the sections I used last summer had openings when two scalloped edges were placed together, of only $\frac{1}{4}$ inch. When I used separators with these last-mentioned, having but one scalloped edge, I found that the bees had great difficulty in getting on to the top of the section, and I believe the separators interfered much with the filling and capping of the upper portion of the sections. When I used separators with both edges scalloped, the bees seemed to have no difficulty with any kind of section.

I have used a few narrow wooden separators with two straight edges, but long ago discarded them. They are somewhat difficult to adjust, and if a rather wide space is left at the top, the bees are very likely to bulge the honey above the separators.

While on the subject of sections, I will further say that I have used some with openings on all four sides, but I am not very favorably disposed towards them. My bees made a desperate attempt last summer to fill the opening in the sides with propolis, and came very nearly succeeding.

Decatur Co., Iowa.

[Mr. Bevins, we fear you will never know just what was said at Lincoln, on the question you have copied from the Report. The shorthand reporters were somewhat inexperienced, were unfamiliar with bee-terms, and so did not get a very clear report of what was said, in several instances. And you have struck one of the hazy places. Take it all in all, however, we think the Report is fairly creditable.—EDITOR.]



Clipping Queens' Wings—Increase by Dividing.

BY DR. E. GALLUP.

I am asked by several if I clip my queens' wings, and whether I practice artificial or natural swarming. My reason for not clipping queens is that I have lost more swarms by clipping, by all odds, than I ever did by not clipping, for I consider that the loss of a good queen at such time is equivalent to the loss of a full swarm, and then I have to raise the hives from the ground on four stakes to prevent the small ants from entering the hive and annoying, for, if not kept out, they ruin the colony entirely. Bees can do nothing with the little rascals. I tried smearing the stakes with kerosene, crude petroleum, tar, etc., but now I use a liquid preparation called "Lee's lice and mite killer for fowls."

My hive bottom-boards project well in front of the hive, but if a bee or queen should drop among the ants, they are gone up, for the ants pile onto them like a flash. Uncultivated or hard ground seems to be literally alive with them here. But I do not like clipping queens, anyhow, though that need not prevent others from doing as they like.

One should be on hand to watch for clipped queens, just as much as you do to watch for swarms. In all my experience of years with natural swarming, I never had but two swarms leave without clustering first, and in both of those cases they were kept in the hive long after they would have swarmed, on account of bad weather.

I practice artificial swarming, or dividing, and like it. I

rear my queens in advance, then take the old queen out of a strong, populous colony, together with two frames of sealed and hatching brood, and place them in an empty hive, adjust a division-board, and set the hive on a new stand. Now the old bees will go back, but we have young bees and hatching brood that will stop with the old queen; all bees less than six or eight days old stay where they are placed, and under such forced conditions young bees will commence gathering honey, pollen and water at six or eight days old. The queen is kept busy filling the cells where the young hatch, and in two, three, or four days, depending upon the weather and honey-yield, I move those two combs apart and place in a frame of comb foundation between the two full combs. As soon (or a little before) as this is well drawn out and filled with eggs, I place in two more frames of foundation, always alternating between two full combs, and in that method of procedure, if the weather is right, it takes but a short time to build up a strong colony.

I have supposed that there is sealed honey in the upper part of each comb that I started with; if not, and I have not a spare comb of honey to place in with the two frames of brood, then I must feed, especially if the weather turns bad.

Now in the old colony I place two frames of foundation in the place of the two combs taken out, and never both together, always one full comb between the two or more foundation combs. My reasons for this is, the bees cannot cluster on the foundation heavy enough to make it stretch, sag, or draw any of the cells out of shape, and I never have to use wired foundation.

Now introduce a laying queen to the old colony, and they are all right. I have not weakened that perceptibly, but what it can go right on with storing honey, and with a young queen and right management swarming is at an end for that colony for the season.

Our young queens must be reared on right and natural principles. I have been corresponding with some Southern queen-breeders to see how early they can furnish queens. Providing I can get them early enough from a reliable breeder—one that makes a business of queen-breeding—I should prefer to purchase instead of rearing them myself. One reason is on account of not having the time to properly attend to it, and another is on account of being surrounded with wild bees. And right here I will answer another question: I do not propose to rear queens for sale, for both the above reasons.

The plan recommended by some to make artificial increase is to make an equal division of the combs, set the half containing the old queen on a new stand, and allow those on the old stand to rear a queen, fill out both hives with foundation at once, etc. Any one that practices that plan, if he is a close observer, will find he is all wrong. He is almost sure to get unprolific and short-lived queens on account of the bees being in a hurry to replace their queen. They start from a larvæ too far advanced as a worker. Then, again, filling up with foundation outside of the main cluster of bees is wrong. I would on no condition fill a hive with foundation to have a natural swarm on. Insert a frame of brood consisting of unsealed larvæ and eggs, and one frame of foundation on each side or not. Let them partly fill the hive with comb, and then alternate with foundation. The queen does not go outside of the cluster to deposit her eggs. See?

Orange Co., Calif.



Improving Bees by Selection in Breeding.

BY W. J. DAVIS.

Those who keep bees (with possibly a few exceptions) keep them for the profit they may yield, and it is safe to say, when they cease to yield a profit for their owner for several

years in succession they would cease to have owners, and if they existed at all, it would be in a wild state.

That there is a vast difference in the profits of different colonies in the same apiary, I think no bee-keeper of experience and observation will deny. One colony, or a majority of the colonies, of an apiary may yield satisfactory returns while others just as favorably situated and in equally as good condition in the spring will give no profit. The only legitimate conclusion that I can arrive at is that there is a great difference in the bees even of the same variety. (Viz.: Itallans, German, Carniolan, etc.) Neither is it surprising that such should be the case. We find the same condition of things among other domestic animals. There are cows kept which are an absolute bill of expense to their owners.

Most dairymen realize that there are cows in their dairy that are *not* for sale, while others are.

I will not lengthen this article by particularizing, but simply say that the same degree of merit and demerit obtains among horses, cattle, sheep, swine and poultry, and an effort is being constantly made to propagate the good qualities and eliminate the bad.

That is just what we should do with the honey-bee, but we should start with the *best*.

The 3-banded Italians I take as the best domesticated honey-bee yet brought to public notice, and I understand such to be the verdict of the world's best apiarists to-day. By way of practical experience I will say that I kept black bees for about 20 years, and would have given up bee-keeping in disgust had not new hope dawned on the pursuit by the introduction of the Italian bee. When the seasons were *just right* results were satisfactory, but it took about three years of favorable conditions (rainfall, etc.) to produce one good honey-year, and the blacks couldn't stand grief. The wax-moth was troublesome with the blacks. They were much disposed to rob. Like some people, they must do a big business or nothing. And then in the spring they were prone to desert their hives, leaving brood, honey, and all the conditions one would think favorable to contentment, viz.: clean combs, clean hive, and sometimes 10 to 12 pounds of honey, and after flying like a natural swarm would try to force an entrance into some other hive already occupied, and if they succeeded in gaining an entrance they were sure to be killed to the last bee.

In July, 1866, I procured two Italian queens which were safely introduced, and the work of Italianizing an apiary of 60 colonies of blacks begun, which was accomplished in 1867, and the apiary increased to 120 colonies.

I found the Italians proof against the wax-moth. They would *never* desert their hives in early spring, and whenever a small amount of honey was obtainable, they would secure that, and gain in stores, while the blacks would require feeding.

But when the black blood was eliminated, I found that the Italians were not all alike profitable. I supposed that the queen that would lay the most eggs must be the best. That I *know* was a mistake. Some queens producing one-half the number of eggs that the others did, gave much better results in surplus honey. The solons of bee-culture told us to introduce new and fresh blood to avoid the evil effects of in-and-in breeding. For 15 or 20 years I secured by purchase and exchange queens from the North, South, East and West, but cross as I might, the same fact presented itself, that some colonies were not worth keeping, and some queens were worth their "weight in gold." I said, "Why cannot all be as good as the best?" We can rear queens from only the best colonies, but we cannot be sure of the young queens being fertilized by drones from colonies we might desire.

When the Italian bees brought \$15 per colony, every colony was saved, the bees having a commercial value. But for several years past the bees themselves had no value in the fall of the year, from the fact that bees in the spring were

worth no more per colony than the hives, comb and honey in the fall.

So it has been my practice for a number of years to reduce my stock by killing the colonies that did not come up to my ideal of what a colony ought to be.

But some men will say: "What is your standard of excellence?" First, I would prune out every colony that shows any signs of black blood. 2nd, I would kill all the vicious bees; I would no more keep a vicious colony of bees than I would a vicious cow or horse. Any of them would endanger a human life. 3rd, another class of colonies are those that fail to give satisfactory results, though in appearance and temper they may be faultless. Such colonies also must vanish. This great difference in productiveness is probably more observable in large apiaries. I cannot account for the great difference in colonies only in this way: 1st, the shorter proboscis of the workers of some colonies whereby they are unable to reach the nectar of certain flowers which are obtainable by others. 2nd, shorter, or weakness of wing; or, 3rd, greater vitality and longevity of queen and workers. I incline to the opinion that in this the secret lies.

We do *know* that it is not the most prolific queens that have the strongest colonies in the early spring, or give the most substantial results for the season. These facts being known, it remains for bee-keepers to solve the reason *why*. If we cannot account for the fact of one colony collecting two or three times as much as another in the same yard, we can take the short cut and abolish the less productive ones, and thus secure the "survival of the fittest."

This has been my practice for several years, and results show the correctness of the theory. When the maximum number of colonies desired by the bee-keeper is not yet reached, the same results may be obtained by killing undesirable queens and supplying the colonies with better ones. Abundant "new blood" is secured by bringing home colonies from two out-apiaries. If this plan followed persistently for a term of years will not develop "Apis Americana," what will? —American Bee-Keeper.

Questions AND Answers

CONDUCTED BY

DR. C. C. MILLER, MARENGO, ILL.

(Questions may be mailed to the Bee Journal, or to Dr. Miller direct.)

Proper Weight of Colonies for Wintering.

How much should an 8-frame colony weigh in order to have enough honey for winter? They can get no honey here from September to the middle of April. The empty hives weigh 20 pounds each.

T. L., Elgin, Iowa.

ANSWER.—The proper weight depends somewhat on circumstances. If the hives are new and the frames occupied this year for the first time, less weight need be counted, and if the bees are to be wintered in the cellar the weight need not be so heavy as for wintering out-doors. For cellar-wintering, five or ten pounds less will do. Less may do, but if the bees have more honey than they need it will not be wasted.

Questions on Management and Transferring.

1. A man has about 200 colonies of bees in box-hives, and some few in movable-frame hives. They are in all sorts of conditions from good to bad (I mean the bees, not the hives). All of these hives have been so arranged that a regu-

lar 8-frame extracting super, or T-super, will fit them, of which said bee-keeper has about 400. The point I wish to set forth by saying this is that things are in working order (after a fashion). Now to the question:

How would you proceed, if you were to step in and take charge, in order to get the greatest yield possible? At the present time snow is falling, and of course all work in the apiary is done until next spring. So if it doesn't take up too much time and space, briefly state your mode of procedure from spring until the time of the honey-flow.

2. Wishing to get the above apiary in "shape," I am figuring on getting 8-frame dovetail hives. Although there is much talk here about large hives, I find from actual experience that my small hives give me as good returns as the large ones. For various reasons I have decided on the 8-frame. Now, when would you undertake the work of transferring? Here the honey-flow lasts until the last of September, and when it's over you don't want to work with the bees very much, I can tell you. It would mean sure destruction to any but the best colonies. The rub comes in that if I transfer early I injure my honey-crop, and if I wait I fear the consequences. Can you help me out? COLORADO.

ANSWERS.—1. I am not so sure I'd do anything up to the time of the honey-flow with any colonies that were strong and in good condition, and that had at the same time abundant stores. If some were very weak I think I'd unite, for if you have a colony that you count 80 per cent. of a strong colony and another that you count 20 per cent. of a strong colony, I think you'll get more from the two united than from the two left separate. And I think I'd rather unite a weakling with a colony of at least medium strength than to unite enough of the weakest together to make one of sufficient strength. Sometimes a very weak colony may have one of the best queens, but oftener you will find your poorest queens in your weakest colonies. So the few bees that are in a weakling will count for more in the honey crop if they are put with a colony in pretty good heart. So you see I've no patent arrangement to get colonies into the best condition for the harvest, but just depend upon their doing their best themselves if they are strong and have plenty of stores. With those that are in frame hives a little more may be done. Indeed a good deal more may be done, although it may not take much time or trouble to do it. I refer to giving them room. When a colony has filled all its room with brood and can utilize more room, it should have that room promptly given, and in your case, with 8-frame hives, I would give the room by adding another story under, filled with combs if possible, and possibly it might be well to put one of the frames of brood in the lower story. But I wouldn't make the mistake of putting a frame below so long as any room remained for brood above. It will do no harm, however, to give the lower story some time in advance of its being needed, but it wouldn't do to give an empty story above to waste the heat of the colony. Just possibly you might accomplish something in the same direction with the box-hives by taking any empty ones from which weaklings have been taken and giving them to the strongest as lower stories. The whole thing to seek for is to get colonies as strong as possible before the time of the honey-flow.

2. As the great majority allow natural swarming, I take it for granted that such is your practice. In that case I think I should leave the bees in the box-hives till they swarm, give the swarms in the frame hives, put the frame hives on the old stand, set the old hive close by; in about a week remove the old hive to a new location close by some colony that I should want strengthened a week later, then at the end of that week set the hive back where you put it at the time of swarming. Let it stand there a week, at the end of which time all the young bees will have hatched out and you can drum out all and add them to the swarm. If a colony refuses to swarm, you could drum out a swarm and then proceed just as if it had swarmed naturally. Of course, there may be circumstances that would make some other course advisable.

Keeping Bees in House-Apiaries.

I found an article written in some magazine (Harpers', I think), by W. Z. Hutchinson, on "House-Apiaries," which interested me very much. He speaks with authority that it can be a success, and says that bees are not as easily robbed as when kept out-of-doors. Now, there is an old bee-keeper here who sells his honey by the tons, who assures me that bees will not thrive kept in a house, and called me crazy to think of it. All right, if he can prove it.

Why can bees be packed in sawdust over their ears, and yet be too close put in a lath and plastered house, with tight

floors and a good entrance for each? If I raise the windows in summer for plenty of air, why cannot I keep them right there, summer and winter, and do well for comb honey?

If I keep them in the house, to what extent, in your opinion, will it prevent their being robbed? This is very important to me, for my neighbor, "big bee-man," has large hives, and doubles up his colonies till they are a horde of bandits, and I was obliged to move my hives a mile away on that account. If I understand rightly, this robbing is begun by putting out honey in the spring, when there is no honey nor pollen in the fields—at least that is what is done.

I shall have to move my bees back this winter, if I keep them in the house, and I should like to be assured of a fair chance of success, if I undertake to act on the defensive. It is very difficult for me to go so far to care for my bees. Being on other people's ground, I cannot build to cover supplies, and the cold wind sweeps down the creek on the single-wall hives.

If I could keep all under cover, it would place my colonies back upon my own grounds again, and give me the much-desired opportunity of saving my bees and my fruit from thieves. E. B. R., Nunda, N. Y.

ANSWER.—Years ago there was a good deal of talk about house-apiaries, although actual experience with them was limited to a very few. Possibly a patent may have had a little to do with it. At any rate, it seemed to be pretty well settled among practical bee-keepers that it was a safe thing to let house-apiaries entirely alone. This view was strengthened by, if not based upon, the fact that house-apiaries had proved a failure generally in the hands of those who had tried them. Within late years, however, some among the ranks of reliable and successful bee-keepers, after some experience in the matter, say that house-apiaries are a success with them. Whether you would make a success with a house-apiary could perhaps be told only after trial.

I have not seen the article you mention by Mr. Hutchinson, but he is a very reliable man, and I hardly think he meant to convey the idea that your words would convey, "that bees are not as easily robbed as when kept out-of-doors." With the entrance to the hive the same—and the entrance can be just as small out-doors as in a house-apiary—there is no reason why robbers cannot enter one hive as easily as the other. What he meant to teach was probably that there was less likelihood of robbing with the house-apiary, because in that case the exposure of the combs when being handled by the bee-keeper does not occur. What he does is in the house where the robbers cannot enter. That's probably all the house-apiary could do in the way of preventing robbing. If you have one colony in a house-apiary and another out-doors, and they are alike in other respects, nothing being done in either case to excite robbers—if in that case a lot of robber-bees should make an incursion, one colony would be just as safe as the other.

It is a safe rule to lay down that when A's bees are robbed by C's, C is the man that's to blame. No matter what C may do with his bees, and no matter as to the number of colonies each one has, if A's bees are properly taken care of and his colonies strong, there is little danger of their being robbed. But if A has colonies that are weak or queenless, or if he exposes combs or honey to attract robbers, there is danger his bees may be robbed, no matter how weak C's colonies may be.

Another thing: If a colony is in condition to be robbed, the robbers are just as likely to come from the same apiary as to come from a separate apiary.

To Whiten an Undressed-Lumber Shed.

Now for a question a little out of your line perhaps: I am going to build a bee-shed, and since lumber is cheap in the rough, but high-priced in the dressed condition, here, I am going to put it up rough. Paint costs like "get out," and if I had to paint unplanned lumber I'd have a costly job on hand. Still I would like to get that shed looking white. Now, do you know whether ordinary whitewash will do the wood harm or good, or either? Or have you any better plan to suggest? H. D.

ANSWER—I don't feel sure about it, but I think there is a special whitewash that you can use on undressed lumber out-doors that will give good satisfaction. I think I have seen it used by some railroads. Possibly some of our readers can help us out.

OLDEST BEE PAPER IN AMERICA

THE AMERICAN BEE JOURNAL

ESTABLISHED IN 1861

GEORGE W. YORK, Editor.

PUBLISHED WEEKLY BY

GEORGE W. YORK & COMPANY,

118 Michigan St., CHICAGO, ILL.

\$1.00 a Year—Sample Copy Sent Free.

(Entered at the Post-Office at Chicago as Second-Class Mail-Matter.)

Vol. XXXVI. CHICAGO, ILL., DEC. 24, 1896. No. 52.

EDITORIAL COMMENTS.

A Very Merry Christmas is our heartiest wish to each and every reader of the American Bee Journal at this happiest season of the whole year. We trust it may indeed be to all of you the merriest Christmas you have yet been permitted to enjoy. Try to make some one else happy, too, and see how much more joyful it will then be for yourself. How true, "'Tis more blessed to give than to receive."

Again we wish you all—

A MERRY, MERRY CHRISTMAS!

The Amalgamation Project.—Mr. Newman, the General Manager of the National Bee-Keepers' Union, sent us the following in reply to Dr. Mason's answer to his criticism of the New Constitution:

In reply to Dr. Mason's article in the American Bee Journal, pages 770-2, I desire to say that being invited to "make suggestions" or criticize the Constitution offered as a basis of amalgamation, I candidly pointed out some of its imperfections, without allusion to any person, supposing that was what was being desired—but by the rejoinder of Dr. Mason, it seems that an unpleasant personal controversy is invited. As I have no relish for such, and shall not indulge in it, I silently pass all that has been said—"Measures, not Men," is my motto.

While I have no desire to dictate anything, I certainly have the right to *criticise* such an important matter as submitting an imperfect Constitution to vote. The members of the Union have the right to expect this of me, and I shall not disappoint them.

In my criticism I have nothing to change, though I might add more to it—the points I made are mainly incontrovertible. It is nonsense to state that I made any "*decision*" in the matter of submitting amalgamation to vote; that was the duty of the Advisory Board, to which I immediately submitted the question—Dr. Mason's assertion to the contrary notwithstanding.

It is a fact that I gave an "*opinion*" publicly, that such an incomplete and imperfect document should be amended before being adopted by the Union, because of the difficulty and delay in amending it afterwards. Have I no right to express an *opinion*? If not, since when?

The unkind personal remarks threatening my defeat at the next election, are ungenerous and unwarranted. I never was a candidate for election or re-election. The members voted for me because they wanted my services, and when they want some one else, I shall retire with the satisfaction of having done my duty to the best of my ability.

There are seven members in the Advisory Board—three favor submitting amalgamation to vote; three vote against it, and one, after adding many more criticisms than I made, adds: "Many will want to have it put to vote. I should say, submit the criticisms to each voter, and put it to vote." That decides the matter. Amalgamation will be put to vote at the next election.

—If the inconsistencies I have carefully pointed out are to be disregarded, and ascribed to my "vivid imagination"—

then the consequences must not be charged to me. I have carefully watched the interests of the members of the National Bee-Keepers' Union for a dozen years, and successfully defended their rights in the courts of the land—from the police court to the very highest tribunal of the country. My aim is the same to-day, by trying to prevent the serious mistake of too hasty and premature action, and thereby avoid the embarrassment which would naturally result therefrom.

THOMAS G. NEWMAN.

We think Mr. Newman does well not to enter into a discussion of unpleasant personalities—such is always an unprofitable thing. We are of the opinion that where Mr. N. made his mistake, was in not sending his criticism *in advance* of the adoption of the New Constitution by the North American at the Lincoln convention. Ample opportunity was given him to have done so. But to bring forward a quantity of unimportant objections *after* its adoption—and in the vigorous way in which he did it—well, we simply think it was a mistake on Mr. Newman's part. And we do not say this with anything but the pleasantest personal feeling toward Mr. Newman.

Of course, the proper thing to do is to submit the New Constitution to a vote of the members of the National Bee-Keepers' Union, but we suggest that it would be unfair to accompany the voting blank with any criticisms of the New Constitution, unless there be also added a statement by some one competent to speak in its favor. We think that the only fair way to do is to simply submit the New Constitution to a vote upon its merits, with no criticism or suggestion for or against. Nearly all the members read the bee-papers, or if not they ought to.

Ready to Join the New Union.—We have received several letters from our readers saying they were ready to join the New Union just as soon as the proposed amalgamation shall be completed. Well, we fully expect that when the ballots are counted (Feb. 1, 1897), they will show that the great majority of the members of the Old Union favor the adoption of the New Constitution, and the matter will be settled then and there. So all who are contemplating joining the New Union may as well get their dollars ready to send in next February.

Some Wheadon Correspondence.—Mr. A. L. Kildow, of Sheffield, Ill., had some interesting correspondence about two months ago with the now extinct fraudulent Chicago commission firm of Geo. T. Wheadon & Co. Mr. K. sent us this letter along with four from Wheadon & Co.:

SHEFFIELD, Ill., Dec. 14, 1896.

MESSRS. GEO. W. YORK & Co., Chicago, Ill.—

Dear Sirs:—I had some correspondence with Geo. T. Wheadon this fall, and will send you his letters as they may be of interest.

No. 1 is the first I got after I received their circular letter. I replied to No. 1, stating *about* the amount of honey I would have.

No. 2 is Wheadon's reply, to which I stated the amount of honey, quality, and the price I would take for same on board cars at Sheffield.

I then received No. 3, and answered by telling them the honey was ready to be shipped when they sent a draft for the same to the bank at this place, which draft was to be turned over to me when Bill of Lading was turned over to them. And this brought No. 4, which closed our correspondence. (But Wheadon did not get the honey.) Thanks to the American Bee Journal for showing Wheadon as he is, as otherwise I might have been deceived by him.

Respectfully,

A. L. KILDOW.

The four Wheadon letters referred to by Mr. Kildow, read as follows:

WHEADON LETTER NO. 1.

CHICAGO, Sept. 16, 1896.

Dear Sir:—You will recollect our having written you some time ago regarding the honey business. We are buying quite extensively, and if you desire to sell now, we are in a

position to pay you as much as any one on this market. Will you kindly advise us by return mail what you have to offer for sale, and if there is very much in your neighborhood? If there is enough to pay us to send our man there, we will probably do so, and you might be able to lend him considerable assistance, for which we would expect to compensate you liberally. In your answer, please state lowest price for which you think honey could be bought in your locality, what quality it is, and the lowest price you will take for yours. If the amount is sufficiently large, and we cannot make a deal direct with you, we will probably send our representative there.

There is but little change in the price since we sent our Circular, but the market is a great deal more active. We being very extensive honey-dealers, control a great many heavy purchases, and if you desire to take advantage of selling to us, please let us hear from you at once. You have had ample time to look us up, and know that we are thoroughly responsible, and good for any contracts we make. If you prefer, we can send you references from parties we have dealt with in your own State, some of whom you may know. We often buy on sample, and if you desire, you might send us a small sample upon receipt of this, and we will then make you an offer upon whatever quantity you have. This will perhaps be the most satisfactory way to do.

Please let us hear from you by return mail, and kindly give us the names of others whom you may know that have honey to sell. If we are successful in doing business with you, we have no fear but what we will not only hold your trade, but secure that of your neighbors as well.

Do not fail to let us have your reply at once, for if you have none to sell, we will look elsewhere.

Yours respectfully, GEO. T. WHEADON & Co.

WHEADON LETTER NO. 2.

CHICAGO, Sept. 25, 1896.

A. L. KILDOW, Sheffield, Ill.—

Dear Sir:—Your favor of Sept 24 at hand and noted. We are much pleased to hear what a large amount of honey you have on hand, as, providing we purchase same, it will assist us in filling our orders, of which we have a good many. We have purchased several cars of late, but almost all from Utah and Colorado points.

When you get yours ready for shipment advise us your lowest price f. o. b. your station, quality, quantity, etc. If possible we will send a representative out through your section, or one of us will come. We can use all you have, or at least the greater portion of it.

Awaiting your early reply, we are,
Very truly yours,

E. Dictated by G. T. W. GEO. T. WHEADON & Co.

WHEADON LETTER NO. 3.

CHICAGO, Oct. 22, 1896.

A. L. KILDOW, Sheffield, Ill.—

Dear Sir:—Your esteemed favor under date of Oct. 21 at hand, and contents noted.

We are pleased to know that your honey is ready for shipment, as we have lately received several large orders which we want to fill, and are therefore in position to use your lot at 10 cents per pound, providing you can ship same at once. We mail you under separate cover a rubber stamp, the number of which we have recorded opposite your name. Please use this in marking shipment.

Be sure and send us invoice with goods, and state whether you wish our check, New York or Chicago draft, in payment of the same.

Thanking you in advance for favors asked, we are,
Very truly yours,

A. Dictated by G. T. W.

WHEADON LETTER NO. 4.

CHICAGO, Oct. 29, 1896.

A. L. KILDOW, Sheffield, Ill.—

Dear Sir:—Your esteemed favor under date of Oct. 24 received some days since, and we have refrained from answering same until now, as we were securing enough shipments of honey and did not know but what we might get overstocked. We having made disposition of all the lots we had received, we are now in position to use what you have if forwarded at once.

It is not customary for us to pay for goods in advance, but will pay for them upon delivery. Our A No. 1 standing in the commercial world does not warrant our being asked to make any such concessions to the shippers. We are purchasing honey in carload lots, and we are according to you the

same methods that we pursue with large shippers. In order for us to use what honey you have at price offered you, it will be necessary for you to forward same at once.

If you have any doubts in regard to our reliability, it might be a good plan for you to come to Chicago with the shipment, as it is not very far, and then we can very quickly convince you of our standing on this market. Please wire us when goods are shipped, so we will know what to depend on.

Very truly yours, GEO. T. WHEADON & Co.

A. Dictated by G. T. W.

What a beautiful series of letters those four are! One would hardly believe, after reading the last one, that the great firm of Wheadon & Co. is not now in existence in Chicago, and this, less than two months after that letter was written! But such is the case.

It is a great pity that all the honorable firms on South Water street, Chicago, don't unite and rise right up and everlastingly wipe out such swindling firms as Wheadon & Co. were, before such can even get a start. They ought to do it, and will have to do it pretty soon, or they will find that no business will come to even the reliable firms. Country producers are getting their eyes opened, and will soon ship only where they stand at least a little chance of getting something in return for their products.

PERSONAL MENTION.

MR. R. C. AIKIN, for several years located at Loveland, Colo., has now "settled" at Shambaugh, Iowa. He drove through from Colorado to Iowa, reaching Lincoln, Nebr., just in time for the North American convention, in October.

MR. H. K. BEECHAM, of Michigan, gave us a pleasant call week before last. He had been on a vacation trip of about a month in Chicago and Wisconsin. He has about 60 colonies of bees, and is an old bee-keeper and reader of the American Bee Journal.

MR. W. H. PUTNAM, a Wisconsin bee-supply dealer, is about to visit relatives in Los Angeles, Calif., and would like to meet as many California bee-keepers as he can during his travels. His Los Angeles address will be 1102 Santee Street. We trust he may have a pleasant trip.

MR. CHAS. BECKER, of Sangamon Co., Ill., dropped in to see us a week ago last Saturday. Mr. B. had the finest honey exhibit made by an Illinois bee-keeper at the State Fair in Springfield, Ill., last September. He won over \$50 in cash premiums. We shouldn't wonder if next year he would lead them all. He deserves all his success, for he has worked hard to win his way to the front in the production of honey.

MR. FRANK McNAY and wife, of Wisconsin, passed through Chicago last week on their way to Pensacola, Fla., where they will spend the winter months. Mr. McNay's bees produced about two carloads of honey the past season, and, besides that amount, he has bought and sold about 50 tons, making something like 150,000 pounds of honey that Mr. McNay has had to do with the past four months. No wonder that he feels that he can take a winter vacation in the "Sunny Southland."

MR. A. I. ROOT, of Gleanings, is on a month's visit among bee-keepers and others in Texas, Arizona, and a few other States. What a fine thing it is, to be able to roam over the country whenever one feels so inclined. We are glad Mr. Root has the time and the dollars to be able to do it. Even if we can't do likewise, we don't feel the least envious about it. It always does us good to see others having an enjoyable time. Maybe some day it will be ours to "go visiting" among those whom we have known only by correspondence, and whom we have come to esteem very highly. But until then we must be content to plod on and try to make the American Bee Journal the best we know how without the advantage gained by personal acquaintance with many bee-keepers and their methods.

Now is the Time to work for new subscribers. Why not take advantage of the offer made on page 830?

General Items.

More than the Usual Rain.

We have had more than the usual quantity of rain for this early in the year; everything is just looking lovely. I think with rain at the right time during the spring, the coming season should be a good one for the bee-keepers of this State.

W. A. PRYAL.

Oakland, Calif., Dec. 10.

Too Dry for Bee-Keeping.

It has been so dry this year that bee-keeping has run very low here. I have been keeping bees four years, and now have 25 colonies. My surplus this year is one pound per colony, and no swarming. My average per colony each year was 10 pounds.

N. L. WEBB.

Fannin Co., Tex.

Good Prospects for Next Year.

My bees that are wintered out-doors had a good, clean flight to-day, and those in the cellar are doing well. The prospects are good for a good honey crop next season. Bees did very poorly here the past season—about one-third of a crop. I put my bees into the cellar Nov. 29. Success to the Bee Journal.

L. E. EVANS.

Lenawee Co., Mich., Dec. 12.

Currant and Manzanita in Bloom.

It is almost too early here to make any guess as to what the season for honey will be. As you know, there was but little in this county, or State, the past season, and a great many colonies came through in a weak condition, though I hear of but few dying for lack of stores. At the present time wild currant and manzanita are in full bloom. They are the shrubs from which we get our first honey, and it is all used in rearing workers for the harvest in June and July. Sage, wild buckwheat and sumac furnish honey for the sections.

ROBERT CAMPBELL.

San Diego Co., Calif., Dec. 9.

Hardly "Manufactured" Comb Honey

There are a great many bee-keepers in this locality (Logan Co., Ill.), but, generally speaking, they do not show much interest in it. Most of them let their bees build their surplus in the hive "caps," and one old gentleman still uses the old box-hive, and when he wants any honey brimstouces the bees and takes their honey. He has kept bees for many years, and has always used this plan.

I take great pleasure in reading the American Bee Journal; it has been a great help to me.

Speaking of adulteration of honey, I do not think there is a grocer in this place but what has handled an imitation of extracted honey. But I would like to ask if any one ever knew of comb honey being adulterated. We have had comb honey shipped in here that was put up in one-pound sections, as nice looking as any one ever saw, but there is not a particle of honey taste about it; the sections are as clean and white inside and out as they were when they left the factory—no signs of bee-glue about

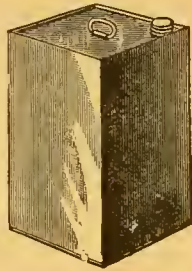

Finest Alfalfa Honey!

IT SELLS ON TASTING.

The Honey that Suits All Who Buy It.

We can furnish **White Alfalfa** Extracted Honey, in 60-pound tin cans, on board cars in Chicago, at these prices: 1 can, in a case, 8 cents per pound; 2 cans in one case, 7 1/4 cents; 4 cans (2 cases) or more, 7 cents. The Cash must accompany each order. **Fine Basswood** Honey at 1/4 cent more per pound.

A sample of the honey will be mailed to an intending purchaser, for 8 cents, to cover postage, packing, etc. We guarantee purity, and what we ship will be equal to sample.

Now it seems to us here is a splendid chance for any bee-keeper to supply his home demand after his own crop is all sold. Or, why not begin now to create a local honey-trade? Order one 60-pound can first, and start out among your neighbors and friends, and see what you can do. You ought to get at least 15 cents per pound in 5-pound lots, or 50 cents for 3 pounds. Some may be able to do even better than that, though we think that enough ought to be sold at these prices to make a fairly paying business out of it. Give it a good trial. Push it. It may grow into a nice winter's work for you.

GEORGE W. YORK & CO., 118 Michigan Street, CHICAGO, ILL.

✦ MONEY SAVED IS MONEY GAINED. ✦

THE ROYAL UNION
Life Insurance Company
DES MOINES, IOWA.

The Iowa Policy

Is one that definitely promises to keep an accurate account with you; credit your premiums and interest, charge the actual expense and mortuary cost, and hold the remaining funds subject to your order.

Agents Wanted.

JOHN B. KING, GENERAL AGENT,
Suite 513 First Nat'l Bank Bld'g,
20A1f CHICAGO, ILL.

Mention the American Bee Journal.

DUQUESNE COLLEGE!

PENN AVE. AND EIGHTH ST.

PITTSBURG, PA.

Thorough Courses—Classical, Scientific, Normal, English, Commercial, Preparatory, and Ladies Literary. Efficient and experienced instructors. Day and Night sessions.

Send for Catalog.

Members, The American Bee Journal.

THROAT AND LUNG DISEASES,
DR. PEIRO, Specialist
Offices: 1019, 100 State St.,
CHICAGO. Hours 9 to 4.

The "Premium": A Good Watch Mailed Free!

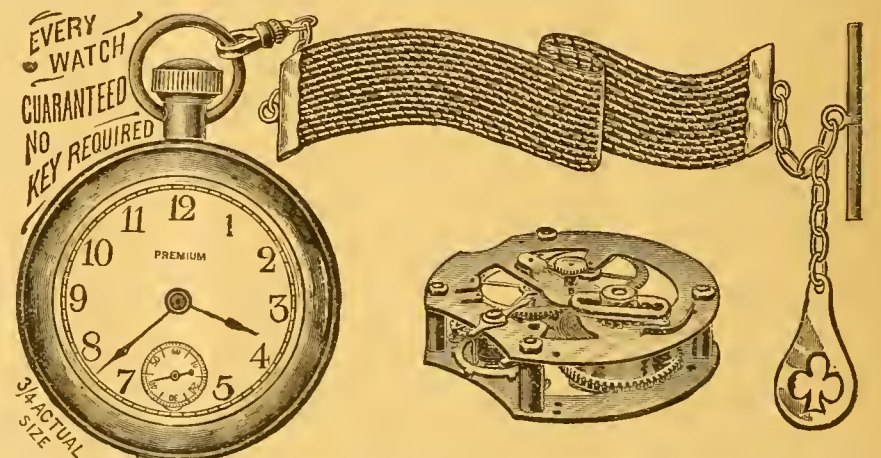

The movement of this Watch is regular American lever, lantern pinion, quick train, 240 beats per minute, three-quarter plate, short wind; runs 30 hours to one winding; dust cap over movement; every movement fully timed; regulated and guaranteed for one year, the same as a Waltham or Elgin; nickel finish, heavy bevel crystal, and back pinion wind and set.

OUR OFFERS:—We will mail the above Watch for \$1.25; or club it with the Bee Journal for a year—both together for \$2.10; or we will send it free as a premium for getting Three New yearly Subscribers to the Bee Journal at \$1.00 each. The Watch is mailed from New York City, so please allow a few days before expecting your order to be filled.

GEORGE W. YORK & CO., 118 Michigan St., Chicago, Ill.

them. I have never been able to educate my bees to do such nice work. I use the one-pound section with separators, and the paper cartons with my name and address neatly printed on one side. This is a very neat and attractive way of putting it on the market, and costs but little.

There are two grocers that have several crates of this "California honey," as they call it, that they bought last winter, but have not been able to sell a pound of it since my honey has been on the market. I do not believe that the manufactured honey has hurt the sale of mine in the least; in fact, it has driven the trade to me. People who have a chance to know what pure honey is are not easily fooled. On the adulteration question I am a little like the fellow said about a nest of polecats: "Just let them alone, and they will soon sink themselves out." C. W. CONKLIN.

Logan Co., Ill., Dec. 1.

[While it has often been rumored that comb honey was being manufactured, so far as we know, not one pound of it has been produced. The honey referred to by Mr. Conklin may be some mild-flavored variety that is too tasteless for most people. The producer may have used extraordinary care in scraping the sections. We should like to see a sample of this honey.—EDITOR.]

Prospects Never Better.

For this time of the year, the prospect for a crop of honey was never better. To secure the best results, we require early and late rains—a long season. The heavy rain of the latter part of October started all honey-plants to growing, and the manzanita—which is the first to respond—is now in full bloom, and our bees are just tumbling over each other to get the honey into their hives. This bush will yield honey all of this month and part of January; then, if rains come, other flowers will come out, and by March 10 swarming will begin.

G. F. MERRIAM.

San Diego Co., Calif., Dec. 3.

Dr. Howard's Foul Brood Book.

I have just received, and read with care, "Foul Brood," by Wm. R. Howard, M. D., and leaving out his quotation from Wm. McEvoy, I must confess that I do not know as much about foul brood now as I did before I read it.

Is there no bee-keeper who has studied the foul brood question that can write a treatise on it and frame his ideas in language that can be understood by the common or average bee-keeper? When one of these M. D.'s gets to writing, he thinks he is either writing for the benefit of other M. D.'s, or wishes to air his scientific knowledge by using such scientific terms that the average reader is lost as to his meaning, and his writings are of no use to the bee-fraternity at large. Here is an illustration, taken from page 14 of the book in question:

"For rotten brood to produce foul brood it would be necessary for putrefactive bacteria to become strictly pathogenic, those forms of fission-fungi, non-spore-producing bacteria and micrococci to change into spore-producing bacilli, and there would be a time in



This little picture will come home with telling force to many a tired and overworked farmer's wife, who has often felt that she could not longer stand the strain and who finally succumbed to disease. Poor woman! Do you not know that there is within your easy reach a remedy that will quickly restore you to health and happiness? A remedy that will positively cure

**FEMALE COMPLAINTS
BRIGHT'S DISEASE
URINARY TROUBLES
GENERAL DEBILITY
AND MALARIA**

and all diseases caused by disordered Kidneys and Liver. It is a purely vegetable compound which has cured thousands and will cure you. Its name is



Large sized bottle or new style smaller one at your nearest store

Mention the American Bee Journal.

CARLOADS



Of Bee-Hives, Sections, Shipping-Cases, Comb Foundation, and **Everything** used in the Bee-Industry.

I want the name and address of every Bee-keeper in America. I supply Dealers as well as consumers. Send for catalogs, quotations, etc. **W. H. PUTNAM,** RIVER FALLS, Pierce Co., Wis.

Mention the American Bee Journal.

**The Place to Live
'Mid Sun and Flowers**

Possibly you have stood the Intense Cold, the blizzards and the Killing Heat of the East and the West until you are sick of them—perhaps your health has been about ruined by such climate. Don't you think it is about time to seek a place where you can enjoy life? Of course you do. California is the place for a man to live who wishes to be good to himself and his family—there's a genial sun—flowers and fruits every day in the year—Pure air—Pure water—every thing that's good. Now is the time to possess such a home—they are cheaper now than they ever will be again. Don't wait—write to us telling what kind of a place you want—in city or country—what part of the State—how much you expect to pay, etc., and we will give you the desired information.

PRYAL REALTY CO.

966 BROADWAY,

OAKLAND, CALIF.

Please mention this Journal.

their organism that they would possess all of these characteristics at once."

Oh, dear! what a string of scientific words. But where is the bee-keeper who is not an M. D. that can get any more meaning out of it than to hear geese "squawking"? An M. D., or any other D., using such Latin terms, expecting the average bee-keeper to understand it, should have a viscid sinapism applied to his spinal column until the epidermis or integument became rubic and almost epispassic or ephemerical, or until fornication was produced, and until he became so hypochondriacal that he would need no hypnotics. And that neurasthenia would be so great that while in this comatose he would be cleansed from all ascariodes without having to deglutite an anthelmintic; and that it may effect the cerebellum and cause asthenia or cachexy that he would be incapacitated from masticating or deglutiting any electuary without a deobstruent.

Yes, by all means, let us have a work on foul brood that is not full of goose language to us that are not M. D.'s

GEO. W. WILLIAMS.

Polk Co., Mo.

[We presume, Mr. Williams, in giving the natural history of such a disease as foul brood, technical terms cannot well be avoided. But whether or not anybody has comprehended Dr. Howard's book, it is true that it has received many flattering testimonials in its favor. Of course, yours isn't one of them, Mr. W.—EDITOR.]

New or Old Comb for Section Honey.

I notice the answers regarding comb refilled being first-class comb honey. Don't you accept before testing the same. As for myself, I have failed to find it such, and there is one Doubting Joseph (not Thomas). If when a section of comb is leveled, say half down, have it rebuilt and filled with honey; let it be a little cold, take a knife, and after the comb is out of the section, with the blade press on one edge of the comb about as deep to where the new comb was built from, and it will separate almost as nicely as if a piece of paper had been laid between the new and the old, showing the soft and hard or old comb. Morgan Co., Ohio. J. A. GOLDEN.

Yellow Jackets—Oregon Plants.

Does any one know of any sure way to get rid of yellow jackets? They destroyed 5 colonies for me in spite of all I could do.

The honey crop was almost a failure here this year. I increased from 11 to 25 colonies, but took only 100 pounds of comb honey, but I am hoping for a better season next year.

I will give a list of the honey-plants in the order they bloom through the season: First, the bees get a fine start in early spring from the gray willow—in fact, almost before the first sunshiny days it is in blossom. This plant yields nothing but pollen. The next is a curious kind of maple called "vine maple;" it generally comes as early as the last of April, or the first of May, and lasts about a month, and as near as I can understand, it is almost, if not quite, as

good as the basswood flow of the East. This plant is well named, for it takes root wherever it bends down to the ground. The next is wild fireweed, which is very abundant. It is a tall weed, with a cone of flowers at the top; they start to blossom at the base, and continue to blossom toward the top until all the buds are gone. There are about 50 of these blossoms on a single stalk. These latter two plants are both fine honey-yielders. In early morning one can see large drops of nectar in each blossom. We also have here white clover in abundance, buckwheat, motherwort and smartweed. These are the principal honey-plants.

RAY SULLIVAN.

Columbia Co., Oreg.

A Three-Score-and-Ten Bee-Keeper.

I have had fair success this year, for one of 70 years and only limited experience with bees. I have used the Langstroth hive since 1893, made some mistakes, but I think I have learned some things of use to me in the future. I lost five colonies last winter, mostly for want of food. I started with 15 last spring, two of them rather weak, and took about 125 sections of honey and about 500 pounds of extracted, quite a nice part of it being white clover honey; and later I took some very fair honey from asters, golden-rod, smartweed, and other fall flowers. I have sold about \$33.00 worth of honey—comb at 12½ (in crates of 24 sections each), and extracted at 10 cents, in packages of from 2 to 12 pounds each, selling in the neighborhood and nearest towns—no commission to pay. I have some 150 pounds of extracted to sell yet, and plenty left for our own family (only three of us).

I bought three colonies recently at \$3.00 each. I had five swarms the past summer, and all are now in fair condition—23 colonies.

I could not get along without the American Bee Journal. I usually read it twice over, and always take it before any other paper. It comes very regular on Friday mornings, and I am pleased to see the good improvements in it, for the benefit of its readers. Long may it wave!

GEO. McCULLOUGH.

Page Co., Iowa, Dec. 10.

Honey from a Tree.

I have put into winter quarters 77 colonies. They swarmed well the past summer, but stored very little honey. I sell all my honey in the home market, receiving 20 cents per pound.

I will endeavor to give the experience of a friend of mine when he was initiated into bee-keeping. Chambers Hooks was the lucky man to come into possession, near his residence, of a great amount of sweetness by the labor of thousands of industrious inhabitants of a tree. After a fierce battle of several hours, and great destruction by brimstone and fire, he became the owner of the great wealth. Mr. Hooks is a large man, but he was somewhat larger after the battle, especially about the face.

He went to the tree with two vessels which were not sufficient to hold the honey, so he made another trip. After some thoughts of making a third trip, he finally gave it up, and with great difficulty packed the honey in the vessels

THE GIANT MANUAL.

Twelve Books Combined in One!

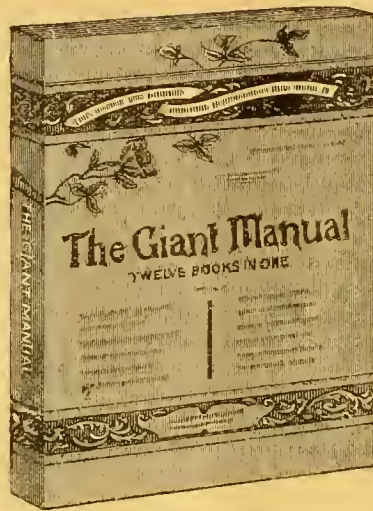

THE GIANT MANUAL is the largest, the most comprehensive and the most extraordinary book ever sold for twenty-five cents. It is in reality twelve separate and distinct books combined in one. It contains precisely the same amount of material as is ordinarily published in twelve distinct 25 cent books, and it may therefore be claimed, with perfect truth and candor, that it is a *three dollar book for twenty-five cents*. In shape it is a mammoth quarto of 192 large three-column pages, with many appropriate illustrations, and is handsomely bound in attractive colored covers. Instruction, amusement, entertainment—all are combined herein, and the book cannot but be of the utmost practical use and value to every man, woman and child. The following are the contents of THE GIANT MANUAL:

1. **The Standard Letter Writer** for Ladies and Gentlemen, a complete guide to correspondence.
2. **Manual of Etiquette** for Ladies and Gentlemen, a guide to politeness and good breeding.
3. **Winter Evening Recreations**, a large collection of Acting Charades, Tableaux, Games, Puzzles, etc.
4. **Parlor Magic and Chemical Experiments**. Tells how to perform hundreds of amusing tricks.
5. **Selections for Autograph Albums, Valentines, Wedd. n. Anniversaries, Birthday Greetings, etc.**
6. **Low Life in New York**. A series of vivid pen pictures showing the dark side of life in the great city.
7. **The Road to Wealth**. A practical work, telling how all may make money easily and rapidly.
8. **One Hundred Popular Songs**, sentimental, pathetic and comic including most of the favorites, new and old.
9. **Popular Recitations and Dialogues**, humorous, dramatic and pathetic, including the most popular.
10. **How to Make and Save Money on the Farm**. A valuable compilation of useful facts and suggestions.
11. **The History and Mystery of Common Things**. Describes the manufacture of familiar things.
12. **Useful Knowledge for the Million**, a handy compilation of useful information for all.

We will send **The Giant Manual**, containing everything enumerated above, by mail post-paid, upon receipt of only **Twenty-five Cents**.

The Bonanza Book for Boys and Girls.

TWELVE BOOKS COMBINED IN ONE!

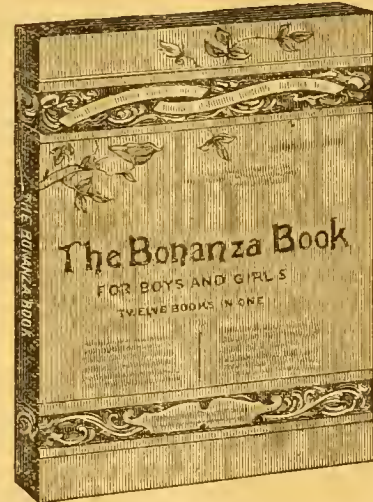

This great book contains the largest amount and greatest variety of amusing and instructive reading matter for boys and girls ever gathered together and published in a single volume. It is in reality twelve separate and distinct books combined in one. It contains precisely the same amount of material as is ordinarily published in twelve distinct 25 cent books, and it may therefore be claimed, with perfect truth and candor, that it is a *three dollar book for twenty-five cents*. In shape it is a mammoth quarto of 192 large three-column pages, with many appropriate illustrations, and is handsomely bound in attractive colored covers. The following are the contents of The Bonanza Book for Boys and Girls:

1. **Modern Recitations**, in prose and verse, embracing many old and new favorites.
2. **Gulliver's Travels**. Adventures among the Lilliputians and Giants.
3. **Dialogues, Recitations and Readings**. A large and choice collection.
4. **Round the Evening Lamp**. Stories, pictures, puzzles and games for the little folks.
5. **Parlor Amusements**. Acting Charades, Parlor Dramas, Shadow Pantomimes, Games, Puzzles, etc.
6. **Grims's Fairy Tales**. The most popular of all fairy stories.
7. **The Self-Made Men of Modern Times**. Portraits and biographies of famous Americans.
8. **Wonders of the World**. Descriptions and illustrations of natural and other wonders.
9. **Wonders of the Sea**. Descriptions of the wonders of the deep, profusely illustrated.
10. **Distinguished People**. Biographical sketches of famous men and women.
11. **Manners and Customs in Far-Away Lands**. Life and habits of peculiar people and tribes.
12. **The People's Natural History**. Interesting information regarding beasts, birds, fishes, reptiles and insects.

We will send **The Bonanza Book for Boys and Girls**, containing everything named above, by mail post-paid, upon receipt of only **Twenty-five Cents**.

As a Premium You can have either book FREE for sending us 1 New SUBSCRIBER to the Bee Journal for a year; or we will club it with the Journal—both for \$1.10.

GEORGE W. YORK & CO., 118 Michigan St., CHICAGO, ILL.

California

If you care to know of its Fruits, Flowers Climate or Resources, send for a Sample Copy of California's Favorite Paper—

The Pacific Rural Press

The leading Horticultural and Agricultural paper of the Pacific Coast. Published weekly, handsomely illustrated, \$2.00 per annum. Sample Copy Free.

PACIFIC RURAL PRESS,
220 Market St. - SAN FRANCISCO, CAL.

Muth's HONEY-EXTRACTOR Square Glass Jars.

Root's Goods at Root's Prices.

BEE-KEEPERS' SUPPLIES in general, etc., etc. Send for our new catalog. "Practical Hints" will be mailed for 10c. in stamps. Apply to—
Chas. F. Muth & Son, Cincinnati, Ohio.

READERS Of this Journal who write to any of our advertisers, either in ordering, or asking about the Goods offered, will please state that they saw the Advertisement in this paper.

at hand, and, with some help, managed to get home through the dense woods with his great wealth. The trunk of the tree, being hollow, was filled seven feet with the honey, and Mr. Hooks says if he had spared the inhabitants another year they would have filled it 10 feet more. The honey was stored in two places in the tree—one at the base and the other 30 feet from the ground.

J. E. SEYBERT.

Armstrong Co., Pa., Dec. 9.

Not Discouraged—A Bee-Escape.

I went to the bank and borrowed the dollar for my subscription, as I don't propose to do business without the old American Bee Journal, and I presume Mr. York cannot run it unless we pay up.

I have taken this season about 1,300 pounds of honey from 30 colonies. I was obliged to trade all of that honey off at 9 cents per pound, and take groceries at that. In order to have fall bloom, I sowed a patch of buckwheat; I got some 1,500 pounds of flour, and was obliged to take that all in groceries. I have sugar, tea, coffee, pepper, and allspice in every corner of the house; my pocket-book is empty, but with my supplies of groceries and 50 colonies of bees in the cellar, what care I for silver or gold? It is true I will have to pay that note off at the bank. Oh, well, York won't call on me for a year, hence what is the cause of my having to sell my crop at such ruinous prices? It is not foul brood; I guess it is paralysis. You may think that I am scared, or discouraged. Not by any means; I am going to run about 50 colonies of bees regardless, and hope for better times.

Now as long as honey is so cheap, and my heart goes out for the poor bee-keepers, I will make an offer, and do something for them to cut down their expenses. I am using a little bee-escape of my own invention that I wish to give to bee-keepers. Why not? I can't do anything with it. Every bee-keeper can make his own escapes at a cost of a penny apiece. I have worked it right by the side of the best escapes that are on the market. It is inferior to none of them. If you want this let me hear, and I will explain it through the American Bee Journal. E. J. CRONKLETON.

Harrison Co., Iowa, Dec. 7.

[Of course, we all want to know about that new escape, Mr. Cronkleton. Let's edit it before another season is here.—EDITOR.]

Well Pleased with the Business.

Bees have done very little for their owners this last season, but as a rule I think they will go into winter quarters in good condition, and we then hope for better results next season. I had 21 colonies, increased to 28 by natural swarming, lost one by neglect, and so now I have 27. My surplus honey this season amounted to 650 pounds. I am well pleased with the business, and cannot afford to be without the Bee Journal.

M. T. FOUTS.

Polk Co., Tenn., Dec. 11.

National Bee-Keepers' Union.

PRESIDENT—Hon. R. L. Taylor...Lapeer, Mich.
GEN'L MOR.—T. G. Newman...San Diego, Cal.

See the premium offer on page 749!

COMB FOUNDATION

Wax always wanted for Cash or in Exchange for Fdn. or other Supplies. My trade is established on **Low Prices** and the merit of my **Foundation. Orders filled promptly.**

WORKING WAX INTO FDN. BY THE LB. A SPECIALTY. Wholesale prices to dealers and large consumers. Send for Prices and Samples to—GUS DITTMER, AUGUSTA, WIS. Reference—Angusta Bank. 1Atf

Mention the American Bee Journal.

HATCH Chickens BY STEAM—
With the **MODEL EXCELSIOR Incubator**
Simple, Perfect, Self-Regulating. Thousands in successful operation. Lowest priced first-class Hatcher made. **GEO. H. STAHL, 114 to 122 S. 6th St. Quincy, Ill.**



44A26t Mention the American Bee Journal.

Yell. O Yell. O'YELLOWZONES YELLOWZONES for PAIN and FEVER.

40,000.
The Nebraska Farmer
Has made a contract with the Nebraska Club, to print for them **40,000** copies over and above the regular weekly issue, each month for six months, of reliable information about Nebraska. If interested, send for free copy, to **MR. CHAS. E. WILLIAMSON, Secretary Nebraska Club, OMAHA, NEBR., or Nebraska Farmer Co. Lincoln, Nebr.**

44A13 Mention the American Bee Journal.

Our Prices ARE WORTH LOOKING AT!

—IN THE—
NEW CHAMPION CHAFF HIVE
especially. All other Supplies accordingly. Send for Catalog and Price-List. Address, **R. H. SCHMIDT & CO., 48Atf Box 187, SHEBOYGAN, WIS. Mention the American Bee Journal.**

Cash PAID FOR Beeswax

For all the **Good, Pure Yellow Beeswax** delivered to our office till further notice, we will pay 25 cents per pound, **CASH**; or 28 cents for whatever part is exchanged for the Bee Journal, Honey, Books or Seed, that we offer. If you want **cash, promptly**, for your Beeswax, send it on at once. Impure wax not taken at any price. Address as follows, very plainly,

GEO. W. YORK & CO. 118 Michigan st., CHICAGO, ILL.

IF YOU WANT THE BEE-BOOK

That covers the whole Apicultural Field more completely than any other published, send \$1.25 to Prof. A. J. Cook, Claremont, Calif., for his

Bee-Keeper's Guide.

Liberal Discounts to the Trade.

Question-Box.

In the multitude of counsellors there is safety.—Prov. 11-14.

What About Having Good Honey Crops Again?

Query 39.—What do you think of the prospects for good honey crops in the coming years as compared with 15 or 20 years ago? In other words, are we likely to have again as good crops as we had then?—PENN.

H. D. Cutting—I think not.
Prof. A. J. Cook—I think not.
W. G. Larrabee—I do not think we are.

Mrs. J. N. Heater—We expect to, in Nebraska.

G. M. Doolittle—Not as an average, on account of decreasing flora.

Eugene Secor—"The thing that hath been, it is that which shall be."

Chas. Dadant & Son—Yes, the clover prospect has never been better, here.

A. F. Brown—I see nothing to prevent it. History often repeats itself, as the sun rises and sets.

Jas. A. Green—No, for most localities. In some places more honey can be gathered now than then.

R. L. Taylor—Yes, except where some of the honey-yielding growths, as basswood, have been destroyed.

Dr. A. B. Mason—In some localities the honey-yield will improve; in others it will be more and more a failure.

Rev. E. T. Abbott—They are very good in my locality, but I do not know anything about the outlook in Pennsylvania.

Jas. A. Stone—Yes, for the reason that bee-keepers are waking up to the fact that bees must have pasturage as well as our farm animals.

Dr. J. P. H. Brown—Question too hard for me. If the conditions prove the same, I do not see why the crop should not be as good.

E. France—It depends upon the amount of rain, and no man can tell what that will be. We had plenty of rain this year, and we have a good show of clover for next year.

C. H. Dibbern—Yes, I think the prospects for good honey-yields in the coming years are just as good as those that have passed. It all depends upon summer drouths, and cold, snowless winters.

Dr. C. C. Miller—I don't know. But I don't know any reason why they may not be as good as ever, if the honey-sources remain the same. Just now the prospect here looks as good as I ever knew.

P. H. Elwood—Yes, in some sections of the country. In places where the forage either from natural or artificial causes has largely disappeared, we cannot expect good crops. Also where the country is overstocked.

Mrs. L. Harrison—Solomon says, "What has been, will be again;" and he was a wise man. I do not expect as good crops in my locality as there were 20 years ago, for where flowers bloomed then, is now covered with houses and brick pavements. Wherever white clover has a rest for her foot, it is now very

luxuriant, more than there has been for five years.

J. E. Pond—This question depends wholly upon locality. In my own section I can't see why there should be any great difference in the yield from past years. Perhaps in some localities bee-foreage will grow scarcer, as building increases.

Rev. M. Mahin—Much depends upon locality. In this locality I am quite sure that we will not again have such honey crops as we had 20 years ago. By the draining and cultivation of wet lands the honey crop has been cut off at both ends—in the spring and in the late summer and fall.

J. M. Hambaugh—Unless more attention is paid to protecting the sources of honey as well as growing honey-producing plants east of the Rocky Mountains, I believe honey will never be as plentiful as in years past. Here in California the situation is different; the principal honey-producing plants defy the plowshare.

G. W. Demaree—In some localities there are no reasons why the good honey crops should not be repeated in years to come. In my own locality the past three dry, hot summers destroyed the white clover. The past summer has been seasonable in rainfall, and there is a fine prospect for white clover next year; and that means a honey crop.

Convention Notices.

INDIANA.—The State Bee-Keepers' Association will meet January 7 and 8, 1897, in the State House, at which time a full attendance of all bee-keepers of our State, as well as many prominent bee-keepers from adjoining States, is desired. We expect some interesting discussions on matters of importance to all lovers of the honey-bee. Come one, come all. Bring your wives, daughters and sons, that they, too, may become interested in the practical management of bees for profit.

J. M. HICKS, Pres.
E. S. POPE, Sec.



For a knife that will cut a horn without crushing, because it cuts from four sides at once get

THE KEYSTONE DEHORNER

It is humane, rapid and durable. Fully warranted. HIGHEST AWARD AT WORLD'S FAIR. Descriptive circulars FREE. A. C. BROSIUS, Cochranville, Pa.

40E13t Mention the American Bee Journal.

—WRITE—

Without Fail—enclosing a list of Supplies wanted, and get our prices on them, before placing your order.

5 to 10 per cent. Discount till Jan. 1st.

I. J. STRINGHAM,

105 Park Place. NEW YORK, N. Y.

APIARY—Glen Cove, L. I.

Mention the American Bee Journal.



ONE MAN WITH THE UNION COMBINATION SAW

Can do the work of four men using hand tools, in Rippling, Cutting-off, Mitring, Rabbiting, Grooving, Gaining, Dadoing, Edging-up, Jointing Stuff, etc. Full Line of Foot and Hand Power Machinery Sold on Trial. Catalogue Free.

SENECA FALLS MFG. CO.,

46 Water St SENECA FALLS, N. Y.

1A1y Mention the American Bee Journal.

THE "NOVELTY" POCKET-KNIFE!

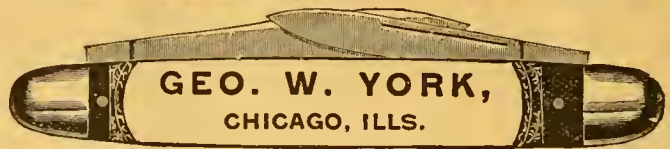

Your Name on the Knife.—When ordering, be sure to say just what Name and Address you wish put on the Knife.

The NOVELTY KNIFE is indeed a novelty. The novelty lies in the handle. It is made beautifully of indestructible celluloid, which is as transparent as glass. Underneath the celluloid, on one side of the handle is placed an AMERICAN BEE JOURNAL reminder, and on the other side, name and residence of the Subscriber.

The material entering into this celebrated knife is of the very best quality; the blades are hand-forged out of the very finest English razor-steel, and we warrant every blade. The bolsters are made of German silver, and will never rust or corrode. The rivets are hardened German silver wire; the linings are plate brass; the back springs of Sheffield spring steel, and the finish of handle as described above. It will last a lifetime, with proper usage.

Why purchase the Novelty Knife? In case a good knife is lost, the chances are, the owner will never recover it; but if the Novelty is lost, having name and address of owner, the finder will return it; otherwise to try to destroy the name and address, would destroy the knife. If traveling, and you meet with a serious accident, and are so fortunate as to have one of the Novelties, your pocket KNIFE will serve as an identifier; and in case of death, your relatives will at once be apprised of the accident.

How appropriate this knife is for a Christmas, New Year or birthday present! What more lasting memento could a mother give to a son, a wife to a husband, a sister to a brother, a lady to a gentleman, or vice versa, a son to a mother, a husband to a wife, a brother to a sister or a gentleman to a lady—the knife having the name of the recipient on one side?

The accompanying cut gives a faint idea, but cannot fully convey an exact representation of this beautiful knife, as the "Novelty" must be seen to be appreciated.

How to Get this Valuable Knife.—We send it postpaid, for \$1.00, or give it as a Premium to the one sending us three new Subscribers to the BEE JOURNAL (with \$3.00), and we will also send to each new name a copy of the Premium Edition of the book "Bees and Honey." We club the Novelty Knife with the BEE JOURNAL for one year, both for \$1.90.

Any Name and Address Put on the Knife.

GEORGE W. YORK & CO.,

CHICAGO, ILLS.

Allow about two weeks for your order to be filled.

OUR NEW CATALOGUE

WILL BE ISSUED SOON.

Send us your Name and Address,

And we will take pleasure in mailing you a copy

FREE!

IT ILLUSTRATES AND DESCRIBES ALL THE

Latest and Best Apiarian Supplies

G. B. LEWIS CO., WATERTOWN, WIS.

THROAT

AND LUNG DISEASES.
DR. PEIRO, Specialist
Offices: 1019, 100 State St.,
CHICAGO. Hours 9 to 4.

Mention the American Bee Journal.

READERS

Of this Journal who write to any of our advertisers, either in ordering, or asking about the Goods offered, will please state that they saw the Advertisement in this paper.

PROF. A. J. COOK'S BOOK FREE!

The Bee-Keeper's Guide

OR
MANUAL OF THE APIARY.

Given For 2 New Subscribers.

This 15th and latest edition of Prof. Cook's magnificent book of 460 pages, in neat and substantial cloth binding, we propose to give away to our present subscribers, for the work of getting NEW subscribers for the American Bee Journal.

A description of the book here is quite unnecessary—it is simply the most complete scientific and practical bee-book published today. Fully illustrated, and all written in the most fascinating style. The author is also too well-known to the whole bee-world to require any introduction. No bee-keeper is fully equipped, or his library complete, without "THE BEE-KEEPER'S GUIDE."

The following offer is made to PRESENT subscribers only, and no premium is also given to the two new subscribers—simply the Bee Journal for one year:

Send us Two New Subscribers to the Bee Journal (with \$2.00), and we will mail you a copy of Prof. Cook's book FREE as a premium. Prof. Cook's book alone sent for \$1.25, or we club it with the Bee Journal for a year—both together for only \$1.75. But surely anybody can get only 2 new subscribers to the Bee Journal for a year, and thus get the book as a premium. Let everybody try for it. Will you have one?

GEORGE W. YORK & CO., 118 Michigan St., CHICAGO, ILL.

HONEY and BEESWAX

MARKET QUOTATIONS.

The following rules for grading honey were adopted by the North American Bee-Keepers' Association, and, so far as possible, quotations are made according to these rules:

FANCY.—All sections to be well filled; combs straight, of even thickness, and firmly attached to all four sides; both wood and comb unsoiled by travel-stain, or otherwise; all the cells sealed except the row of cells next the wood.

No. 1.—All sections well filled, but combs uneven or crooked, detached at the bottom, or with but few cells unsealed; both wood and comb unsoiled by travel-stain or otherwise.

In addition to this the honey is to be classified according to color, using the terms white, amber and dark. That is, there will be "fancy white," "No. 1 dark," etc.

Chicago, Ill., Dec. 15.—Fancy white, 12@3c.; No. 1, 11@12c.; fancy amber, 10c.; No. 1, 7@9c.; fancy dark, 8c.; No. 1, 7@8c. Extracted, white, 5@7c.; amber, 5@6c.; dark, 4½@5c. Beeswax, 26@27c.

There has been a little more trade in honey this month, but the sales are below average for this season of the year.

Philadelphia, Pa., Dec. 12.—Fancy white comb, 13-14c.; No. 1 white, 11-12c.; fancy amber, 10-11c.; dark, 8-9c. Extracted, white, 6-8c.; amber, 4-5c.; dark, 3-4c. Beeswax, 26c.

Comb honey arriving freely and market overstocked at present.

New York, N. Y., Dec. 12.—Fancy white, 12c.; off grades, 10@11c.; buckwheat, 8@9c. No change in extracted. Beeswax firm at 26@27c.

The market is well supplied with comb honey of all grades and styles. Fancy white is in fair demand, while off grades white and buckwheat are moving off rather slowly.

Albany, N. Y., Dec. 12.—Fancy white, 12-13c.; No. 1, 11-12c.; fancy amber, 9-10c.; No. 1 dark, 8-9c. Extracted, white, 6-7c.; dark, 4-5c.

The receipts of both comb and extracted honey are very large, and prices are somewhat lower. We have an ample stock of all styles except paper cartons weighing less than a pound.

Indianapolis, Ind., Dec. 7.—Fancy white, 14-15c.; No. 1 white, 12-13c. Extracted, white, 6-7c. Beeswax, 22-25c.

Demand is fair for grades quoted, but no demand for inferior grades.

Kansas City, Mo., Dec. 12.—Fancy white comb, 15c.; No. 1 white, 13@14c.; fancy amber, 12-13c.; No. 1 amber, 11-12c.; fancy dark, 10-11c.; No. 1, 8-10c. Extracted, white, 6-6½c.; amber, 5-5½c.; dark, 4-4½c. Beeswax, 22-25c.

Boston, Mass., Dec. 12.—Fancy white, 13-14c.; No. 1, 11-12c. Extracted, white, 6-7c.; amber, 5-6c. Beeswax, 25c.

Cincinnati, Ohio, Dec. 8.—Comb honey, 10@14c. Extracted, 4@7c. The honey market is slow in all its branches. Demand is about equal to the arrivals.

Beeswax is in good demand at 20@25c. for good to choice yellow.

Milwaukee, Wis., Dec. 12.—Fancy white, 14-15c.; No. 1, 12-13c.; No. 1 amber, 8-10c. Extracted, white, 6-7c.; amber, 5-6c.; dark, 4-5c. Beeswax, 22-24c.

New crop of honey begins to come forward. The demand is very poor and quotations almost nominal. Weather is very warm and the consumption of honey is very small. Plenty of fruit, and hence the appetite is satisfied with same in preference. Later on we expect an improved demand for honey of all kinds.

Cleveland, Ohio, Dec. 12.—Fancy white, 14½@15c.; No. 1 white, 12½@13c. Extracted, white, 6@7c.; amber, 4½@5½c. Beeswax, 22@25c.

There is not very much honey in our market. Selling rather slow. Demand beginning to be a little better. Think trade will be fair in this line this fall.

Buffalo, N. Y., Dec. 11.—Fancy 1-pound comb is quiet at 11@12c.; No. 1, 10@11c.; dark and poor require hard pushing at 9@10c.

St. Louis, Mo., Dec. 9.—Fancy white, 14c.; No. 1 white, 12@13c.; fancy amber, 11@12c.; No. 1 amber, 10@10½c.; fancy dark, 9@9½c.; No. 1 dark, 7@8c. Extracted, white, in cans, 6@7c.; in barrels, 5@5½c.; amber, 4½@4¾c.; dark, 3½@4c. Beeswax, 26½@27c.

Baker stock of extracted honey, 4@5c.; stock very scarce. Fair receipts of comb. Beeswax in good demand.

Detroit, Mich., Dec. 12.—No. 1 white, 12-12½c.; fancy amber, 10-11c.; No. 1 amber, 9-10c.; fancy dark, 8-9c. Extracted, white, 5½-6c.; amber, 5-5½c.; dark, 4-5c. Beeswax, 24-25c.

Minneapolis, Minn., Dec. 19.—Fancy white, 11@12c.; No. 1 white, 10@11c.; fancy amber, 9@10c.; No. 1 amber, 8@9c.; fancy dark, 7@8c.; No. 1 dark, 6-7c. Extracted, white, 6@7c.; amber, 5@5½c.; dark, 4@5c. Utah white extracted, 5@5½c. Beeswax, 23@26c. Market fairly steady for comb and better for extracted than for some time.

San Francisco, Calif., Dec. 9.—White comb, 10-11c.; amber, 7½-9c. Extracted, white, 5½-6c.; light amber, 4½-4¾c.; amber colored and candied, 3½-4½c.; dark tulle, 2½-3c. Beeswax, fair to choice, 24-27c.

List of Honey and Beeswax Dealers.

Most of whom Quote in this Journal.

Chicago, Ills.

R. A. BURNETT & Co., 163 South Water Street.

New York, N. Y.

HILDRETH BROS. & SEIGELKEN.

Kansas City, Mo.

C. C. CLEMOMS & Co., 423 Walnut St.

Buffalo, N. Y.

BATTERSON & Co., 167 & 169 Scott St.

Hamilton, Ills.

CHAS. DADANT & SON.

Philadelphia, Pa.

WM. A. SELSER, 10 Vine St.

Cleveland, Ohio.

WILLIAMS BROS., 80 & 82 Broadway.

St. Louis, Mo.

WESTCOTT COM. CO., 213 Market St.

Minneapolis, Minn.

S. H. HALL & Co.

Milwaukee, Wis.

A. V. BISHOP & Co.

Boston, Mass.

E. E. BLAKE & Co., 57 Chatham Street.

Detroit, Mich.

M. H. HUNT, Bell Branch, Wayne Co., Mich.

Indianapolis, Ind.

WALTER S. POWDER, 162 Massachusetts Ave.

Albany, N. Y.

CHAS. McCULLOCH & Co., 380 Broadway.

Cincinnati, Ohio.

C. F. MUTH & SON, cor. Freeman & Central ave.

Queens and Queen-Rearing.—If you want to know how to have queens fertilized in upper stories while the old queen is still laying below; how you may safely introduce any queen, at any time of the year when bees can fly; all about the different races of bees; all about shipping queens, queen-cages, candy for queen-cages, etc.; all about forming nuclei, multiplying or uniting bees, or weak colonies, etc.; or, in fact, everything about the queen-business which you may want to know—send for Doolittle's "Scientific Queen-Rearing"—a book of over 170 pages, which is as interesting as a story. Here are some good offers of this book:

Bound in cloth, postpaid, \$1.00; or clubbed with the BEE JOURNAL for one year—both for only \$1.75; or given free as a premium for sending us two new subscribers to the BEE JOURNAL for a year at \$1.00 each.

WOVEN WIRE FENCE

Best on Earth. Horse-high, Bull-strong, Pig and Chicken-tight. With our DUPLEX AUTOMATIC Machine you can make 60 rods a day for 12 to 20 cts. a Rod. Over 50 styles. Catalogue Free.

KITSELMAN BROS.,
Box 137, Ridgeville, Ind.

48 Etf Mention the American Bee Journal.

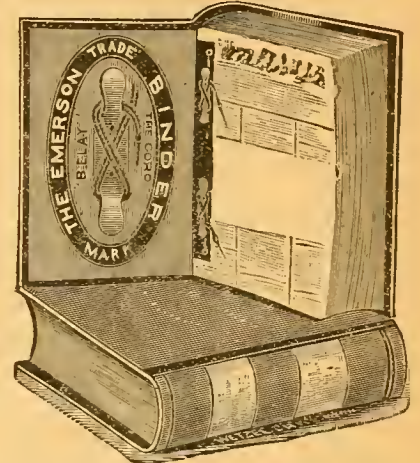

We have a few of these Emerson stiff cloth-board binders for the American Bee Journal. They make a splendid permanent binding, and hold a full year's numbers. The old price was 75 cents, postpaid, but will mail you one for only 60 cts., or with the Bee Journal for one year—both together for \$1.50.

GEORGE W. YORK & CO.,
CHICAGO, ILLS.

NEVER BEATEN

in all the many shows in which it has participated, there must be something in the superiority claims of the RELIABLE INCUBATOR self-regulating, entirely automatic, you put in the eggs. The Reliably does the rest. All about this and many things of value to the poultry man in our new book. Send 10 cts. for it.

RELIABLE INCUBATOR & BROODER CO., QUINCY, ILLS.

36E17t Please mention the Bee Journal.

NEW MAMMOTH

Poultry Guide for 1897. Something entirely new; almost 100 pages; contains lithograph plate of Fowls in natural colors; plans for poultry houses, remedies and recipes for all diseases, how to make Poultry and Gardening pay; only 15 cents.

John Bauscher, Jr., Box 94 Freeport, Ill.

49.A.13t Mention the American Bee Journal.

Payne's Business Letter Writer

and Manual of Commercial Forms.—Containing specimen Letters on all possible business topics, with appropriate answers. Containing general information with regard to business matters, the rules for punctuation, the abbreviations most used in the mercantile world, a dictionary of mercantile terms, a table of synonyms, and other information which may be of value to the business man. New edition, revised and enlarged. 216 pages, Extra Cloth, 75 cts.

Special Offer: We will mail this book free as a premium to any one sending us two New Subscribers to the Bee Journal for one year (with \$2.00), and also send a copy of the premium book "Bees and Honey" to each of the new subscribers; or we will club the book with the Bee Journal for a year—both for \$1.60.

Bottom Prices

**BRING US BIG TRADE.
GOOD GOODS KEEP IT.**

If you want the best supplies that can be made at a little less cost than you can buy the same goods for elsewhere, write to us for low prices. 1896 Catalogue now ready—ask for it and a free copy of *The American Bee-Keeper* (36 pages).

Address,
THE W. T. FALCONER MFG. CO.,
JAMESTOWN, N. Y.
Mention the American Bee Journal.

Honey-Clovers & Buckwheat SEED FOR SALE.

We have made arrangements so that we can furnish seed of several of the Clovers and Japanese Buckwheat, by freight or express, at the following prices, cash with order:

	5lb	10lb	25lb	50lb
Alsike Clover.....	\$.70	\$1.25	\$3.00	\$ 5.75
Sweet Clover.....	.65	1.20	2.75	5.00
White Clover.....	1.25	2.00	4.50	8.00
Alfalfa Clover.....	.65	1.10	2.70	5.00
Crimson Clover.....	.55	.90	2.00	3.50
Jap. Buckwheat....	.20	.35	.90	1.25

Prices subject to market changes.

Add 25 cents to your order, for cartage, if wanted by freight.

Your orders are solicited.

GEORGE W. YORK & CO.,
CHICAGO, ILLS.

BEGINNERS.

Beginners should have a copy of the *Amateur Bee-Keeper*, a 70-page book by Prof. J. W. Rouse. Price 25 cents; if sent by mail, 28c. The little book and the *Progressive Bee-Keeper* (a live, progressive 28-page monthly journal) one year, 65c. Address any first-class dealer, or

LEAHY MFG. CO., Higginsville, Mo.

WHEN ANSWERING THIS ADVERTISEMENT, MENTION THIS JOURNAL.

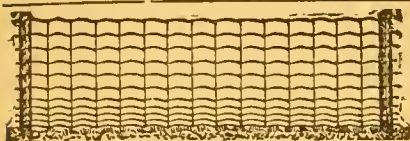

Are You Insured?

Strange that a man will insure his buildings against fire and lightning, which come so seldom and yet take chances on destruction of crops and other losses arising from inefficient fences. **Page fence is a permanent investment and the interest on that is the cost for absolute safety.** Write for proofs.

PAGE WOVEN WIRE FENCE CO., Adrian, Mich.
Mention the American Bee Journal.

Special Renewal Offers!

Prompt renewals are so desirable that I am going to make some special offers. For \$1.00 I will send the *Bee-Keepers' Review* for 1897 and the 50c. book, "Advanced Bee-Culture," or, in place of the book, 12 back Nos. of the *Review*. For \$1.50 I will send the *Review* and a fine tested Italian Queen—Queen to be sent early in the season of 1897. For \$1.75, the *Review* and a \$1.10 Bingham (Conqueror) smoker, postpaid. For \$2.50, the *Review* and 1000 No. 1, first-class, one-piece Sections. But **REMEMBER**, that these offers will be withdrawn Jan. 1st, as the sole object in making them is to induce the sending in of subscriptions before that date. New subscribers will get the Dec. No. free. If not acquainted with the *Review*, send for samples.

W. Z. HUTCHINSON, FLINT, MICH.
Mention the American Bee Journal.

BEE SWAX WANTED

—FOR—

Foundation Making.

Send For OUR CATALOGUE,

SAMPLES OF FOUNDATION,

ADVICE TO BEGINNERS, Etc.

Address,

CHAS. DADANT & SON,

HAMILTON, ILL.

WHEN ANSWERING THIS ADVERTISEMENT, MENTION THIS JOURNAL.

Ask Your Friends to Take This Journal.

* Extracted Honey *



Finest Quality. Basswood and Clover.

2 60-lb. cans in case, 7c. per pound. 1 60-lb. can in case, 8c. per pound. A sample by mail, 10 cts. **POUDER'S Honey-Jars and Complete Line of Supplies.** Catalogue Free.

WALTER S. POUDER,
162 Mass. Avenue. INDIANAPOLIS, IND.

PATENT WIRED COMB FOUNDATION

Has No Sag in Brood-Frames

Thin Flat-Bottom Foundation

Has No Fishbone in the Surplus Honey.

Being the cleanest is usually worked the quickest of any Foundation made

J. VAN DEUSEN & SONS,
Sole Manufacturers,
Sprout Brook Montgomery Co., N. Y.



Cut Prices to Move Stock!!

There are a few items of desirable stock left of the goods secured of Thomas G. Newman when we took charge of his supply business here. In order to close these out and make room for fresh, new goods, we have decided to offer these at prices which will make them go.

The following is the list, which will be corrected as the stock is sold; if you see what you want here, order **AT ONCE**, or you may be too late:

V-Top Langstroth Frames, 75c per 100; 250 for \$1.25; 500 for \$2.

All-Wood Frames, pierced for wire, same price while they last.

Hoffman Frames, with 3/8-inch square bottom-bar, \$1.25 per hundred.

45 No. 1E 8-fr. Dov. Hives, with flat cover, 5 for \$3.50; the lot, \$30.

20 " 10-fr. " " " 5 for 4.00; " 15.

5 No. 9 " L. Hives, 2-story, with Heddon supers, \$2.50 for the lot.

4 1 1/2-story, 8-fr. Hives, nailed, complete, \$1.00 each; \$3.00 for the lot.

50 Comb Honey Racks, to hold sections on the hive, flat, \$1.00 for the lot.

No. 3 VanDusen Thin Flat-Bottom Fdn., in 25-lb. boxes, \$10.50 a box.

Wakeman & Crocker Section-Press, 50c each (old price, \$1.25).

Townsend Section-Press, 50c. (old price, \$1.)

Hastings' Feeders, 10c each (old price, 25c.)

18 Shuck Feeders, 8c each, \$1.00 for the lot (old price, 20c.)

Hill Feeders, quart size, 8c each, 75c per doz. (less than half old prices).

Hill Smokers, 40c each; by mail, 60c.

Quincy Smokers at 50c, 70c, and \$1.00 each—20c extra by mail.

Jones' Frame-Pliers, 10c each; by mail, 10c extra (old price, 25c and postage).

If wanted by Freight, add 25c for cartage on orders for less than \$5

THE A. I. ROOT COMPANY,

Geo. W. York, Manager.

118 Michigan Street, CHICAGO, ILL.

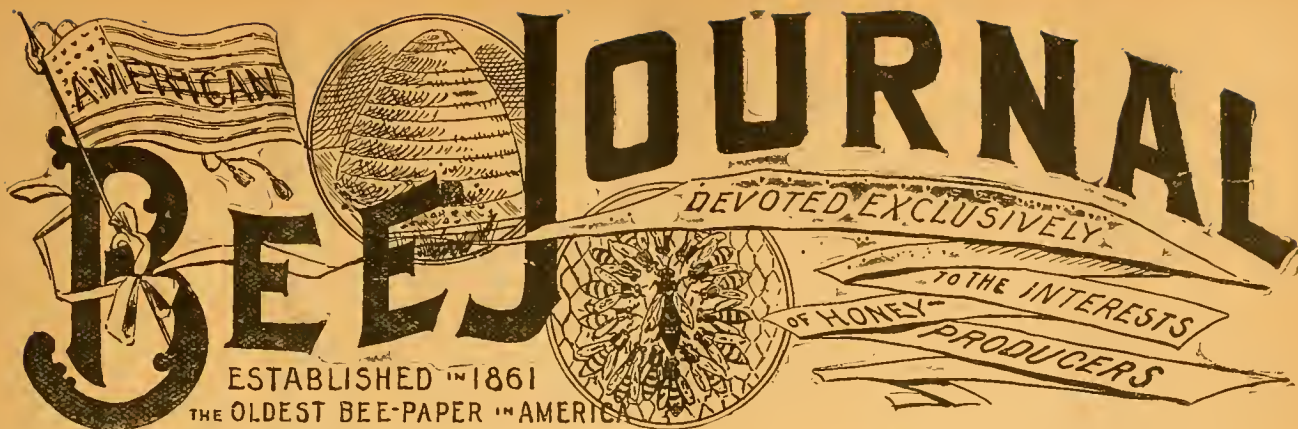

AMERICAN BEE JOURNAL

DEVOTED EXCLUSIVELY TO THE INTERESTS OF HONEY PRODUCERS

ESTABLISHED 1861
THE OLDEST BEE-PAPER IN AMERICA

Published Weekly, at \$1.00 per annum.

Sample Copy sent on Application.

36th Year.

CHICAGO, ILL., DECEMBER 31, 1896.

No. 53.

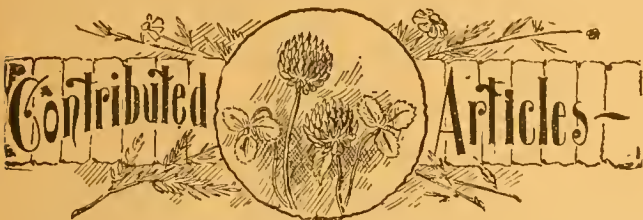

The United States Bee-Keepers' Union.

BY DR. A. B. MASON.

On page 791, in a note under an article signed by "Union," the editor says:

"As Dr. Mason is really the 'father' of the New Constitution, as well as Secretary of the New Union, we take pleasure in referring to him any questions in the foregoing that may require replies."

Were it not that I have been receiving names, each accompanied by the fee for membership in the United States Bee-Keepers' Union, I believe I should not have replied to the queries by "Union," for, from the way he writes he evidently knows what he is talking about.

I believe it was the understanding with those who adopted the New Constitution at Lincoln, that it was the start for a new organization, and the feeling was that the National Bee-Keepers' Union would adopt it; but in the event the National Union did not adopt it, that the new organization would go on and work under the New Constitution; because it would do the same work the old Union has been doing, and the added work of prosecuting dishonest honey commission-men, and those engaged in adulterating honey and selling it.

I recently received a dollar from a bee-keeper for membership in the "Union," and not knowing whether he meant the National Union or the United States Union, and being desirous of carrying out his wish, I wrote him, to learn his wishes, and his reply was such that his membership is with the United States Union; and this morning I received seven names, accompanied by \$7.00. The names and money had been sent to another party, and upon his asking which Union they wanted to join, the reply was, "The one that is going to prosecute dishonest commission-men," etc. I understand that the New Constitution is to be submitted to a vote of the National Bee-Keepers' Union next month (January), and if it is adopted, this money, and more that I have received for the same purpose, will be handed to the treasurer of the new organization. If it is not adopted, the money will be held and used by the United States Bee-Keepers' Union.

I imagine it is not a common occurrence for seven bee-keepers to get together and talk over the matter of prosecuting fraudulent honey commission-men and honey adulterators,

and forward their money for that purpose; and I feel quite confident that if the amalgamation is not accomplished, that, as soon as practicable, measures will be taken to put the United States Bee-Keepers' Union in such shape that it can look after the work that it was organized to accomplish.

We have such a good food law in Ohio, and such efficient officials to enforce it, that it is not at all probable that any of the New Union's money will be needed to induce honey-dealers to handle only the pure article in Ohio.

Sta. B, Toledo, Ohio, Dec. 22.



Season of 1896—Production of Comb Honey.

BY J. A. GOLDEN.

I expected at the opening of the honey season of 1896 to have a pleasing report for the American Bee Journal, but, alas, alas, it turns out a sad disappointment, and my creditors will be compelled to favor my delinquency another year.

The season for a good honey-flow in this locality opened with bright prospects, and some two weeks in advance of former years; bees built up very rapidly, and were in tiptop condition for the supers, which were about two-thirds completed when all were raised and supplied with the second super, having but one swarm which had been hived in a double snper, which completed 58 pounds of section honey out of 72 sections placed on the hive (there being 14 unfinished sections when the heavy rains set in, and completely cut off the flow). And all the newly-supplied supers were removed, and the partly-filled snpers replaced, and instead of completing the already two-thirds filled sections, all the honey was carried below, and I had to feed some of the colonies before the fall flow came to their rescue.

Had I not taken the 58 sections from the double super on the colony that cast the swarm, and hived back as per my method, I would not have gotten one pound of honey this year. The remaining unfinished sections fared the same fate as all the rest, leaving me several hundred beautiful drawn combs for the wonderful white clover honey-flow we expect to get next year! But I want to say right here, that there is quite a difference between section comb drawn last year and refilled with honey this year, and comb drawn and filled this year, when it comes to eating them, and I would not put such comb honey on the market as fancy, no difference from what source the honey was gathered. In fact, I am astonished to see such recommended so highly by some of our bee-fraternity. Why, it does not take an expert to readily perceive a vast difference—the refilled comb remains hard and brittle, while the new drawn comb is soft and pliable when taken into the mouth and chewed. I have not decided whether I shall cut out the combs and render into wax, or use them and extract; doubtless I would secure a large per cent. more

honey by extracting. Were I purchasing a fancy No. 1 comb honey, I certainly would ascertain whether the honey was in new or old combs before paying the top price, for when combs are leveled down and the remaining portion worked over and completed, no experienced eye can tell the difference between the old and the new, but a true test is to take a cube and sample by chewing it, and if the comb is harsh and brittle it is old comb; if soft and tender, it is new. Thus the dealer in comb honey may readily detect and determine the class to which such honey belongs, thereby dealing to the consumer just the class of honey called for.

Mr. Frank Benton said in his work on "The Honey-Bee," Chapter VIII., page 75: "To secure a yield of surplus honey, the part remaining to be done, if all goes well, is merely to put the surplus receptacles in place, admit the bees," etc. Further on he says: "But if swarming complications arise, the whole of the bee-keeper's skill and ingenuity may again be called into requisition to keep the forces together and storing in surplus receptacles. . . . Thus the skill lies in having the colonies ready for whatever may come, and a force sufficient to store the whole season's surplus in a few days."

Now this has been one of the uppermost questions in the minds of the bee-keeping fraternity, namely, What can we, as bee-keepers, do to increase the production of honey, and at the same time curtail the expenses. I believe the theory that Mr. Benton has so well outlined has proven to be the most successful of any practiced generally, but I will go one step further and say that 25 (or any number) colonies of bees can be so manipulated as to produce twice the amount of surplus honey that has usually been produced by any of the methods that I know of (providing the colonies can be induced to swarm), and at the same time curtailing the expenses one-half. Mr. Benton gives the secret in full when he says, "Keep the forces together and storing in the surplus receptacles," etc. To illustrate how I control the forces, I will here give a full and complete statement of the only colony I had to cast a swarm this year, which swarm was hived in one of my double supers containing 47 sections filled with full sheets of comb foundation, and without separators:

The queen was caged and occupied one of the section spaces in the upper middle tier, which super was placed on the parent stand, and the parent colony placed on top, and the former super partly filled placed on top of the parent hive the fifth day. Every queen-cell was cut out, and the queen-cage removed and a section inserted, the parent colony replaced on its stand, and a double super two-thirds full of beautiful comb and honey placed on top of the parent hive, and the former super placed on top of the double super, the queen returned to her former home by one or two puffs of smoke.

In five days I noticed bees clustering at the entrance, and on examination I found to my surprise every section in the double super capped over, which was removed, and as the flow was being washed away by the drenching rains, I added a single super with the former super, resulting at the close in a lot of beautiful partly-drawn combs; besides two outside combs nearly full of honey were taken from the brood-chamber, and dummies placed in their stead, it being a 10-frame hive contracted to 8 during the surplus season. After its close the dummies removed and two outside brood-combs put in, and when the fall flow came they were filled, and on Oct. 15 the hive contained about 35 pounds of honey, as nearly as I could weigh it, counting out comb, brood and bees. All my colonies corresponded in winter stores, but not a pound of surplus or brood-comb honey was taken from any other colony, although all seemed as strong as the one that swarmed.

Now if the reader will figure he will find that the surplus honey I got (48 sections) was just what the swarm would have had in the brood-combs and honey had I hived them in a

separate hive. Therefore, I would say to any that desire to test this method in the production of honey, don't do so without preparing the hive and supers according to the specifications given in my article in the American Bee Journal of July 30, 1896, from the fact that without side entrances to and from, the bees could not pass readily between the brood-combs, and thus cause delay, and a disposition to repeat swarming as well.

In conclusion I predict still better and now unknown methods for the apiarist as the years pass by, notwithstanding some seem to think apiculture has reached its highest attainments.

I want to say for Dr. Miller's benefit, in regard to W. L.'s riddle on page 662, that six or seven years ago I had a nucleus colony containing the largest queen that has ever been my privilege to see, and any one would guess her to be a fertilized queen to have seen her; but all her progeny were drones. The queen was driven from the hive. She was too heavy for her wings, she could not fly, although her wings were perfect in form. I would guess that the Doctor's suggestion is correct. Morgan Co., Ohio.



Should Apicultural Inventions be Encouraged?

BY "INVENTOR."

In the bee-papers I find the idea prevalent that the present Langstroth hive is perfect, and no one should undertake to improve hives further than to accept the Dovetailed hive as a standard. Now when the time comes that there is no progression, then we retrograde—go back and start in another direction. There is no standstill in Nature, and should not be when we are trying to assist Nature. Let the idea once become established that a thing is perfect, and a person not acquainted with the principles of its intent and construction, will see things differently from an expert, and, not understanding the whys and wherefores, will leave it.

Inventors can be just as honest as Mr. Langstroth was with his invention, and I do not believe the time has come when all should say, "It is perfect; let the monopoly go on." The same was said 20 years ago, that there was no room or need of improvement in apiarian fixtures, but that there has been, no one will deny, notwithstanding the warnings and advice against inventions of apiarian fixtures. Some of those who were so much opposed to inventions are using patented features to-day. We ought not to admit, in this age of improvement, that the apiculturist is at a standstill in any feature.

Is there a standard in any line of improvement only as the manufacturer calls it so? Is there a standard vessel on the ocean, or a locomotive on the railroad, or, in fact, a perfect standard machine or implement in the mechanical world, or animal in the animal world, or vegetable in the vegetable kingdom, and so on ad infinitum?

I saw a statement in a recent number of the American Bee Journal, of the number of apicultural patents granted in the United States, and it was intimated as money thrown away, or as much as to say that the inventions as a whole did not pay for the cost of the patents; and the Langstroth patent is included in the number. I think the patentee has the worst of it if he patents a thing that does not pay. But on the whole, the world is benefited thereby.

How often we are told that bee-keepers should not try to invent a hive. Who should, then? Who is better fitted than the user to overcome difficulties in his business? As our minds are different, so we see things differently, and many a simple thing has been brought into use that we have wondered why we couldn't have seen it before!

So long as bee-hives are used, there will be improvements thereon, and I think that manufacturers make a mistake in

crying down improvements, that they may control the sale of certain fixtures, because every real improvement opens the way for others, and increases the wants of the bee-keeper. If we were using the box-hive we would not have the extractor, comb foundation, bee-escapes, and many other devices that came with the frame hive.



Adulterated Honey—Some Experiences.

BY MRS. L. HARRISON.

In the early part of November I saw a man carrying a large tin pail, going in the direction of the front gate. It was raining, and I went out on the porch. He said: "I've honey to sell; but I see [that you have bees, and will not want any." I requested him to let me see his honey. He came to the side of the porch, and I looked down into his pail. It was light colored, and had finely-mashed honey-comb floating in it. When I enquired about his apiary, he gave an evasive answer, and hurriedly departed.

One of the neighbors purchased some. He carried it in a large tin pail, with a long-handled dipper to dip it out, selling two pounds for a quarter. I think from the appearance and taste that it is a syrup of white sugar, with a small quantity of white comb honey mixed with it. I'm not familiar with glucose—it may be glucose, white sugar syrup, and mashed honey. A lady told me that white sugar settled in the bottom.

This man has been doing a good business, selling continually, canvassing the city thoroughly. We have lately been receiving postal cards, enquiring about white comb honey, wanting to have it cut out of the sections, and shipped in a covered tin pail holding three or four gallons. "Send by express," and he "will remit." We have not sent any.

Persons who buy this mixture will not be likely to buy again, but he will sell a large amount in a city of 60,000 inhabitants. I hear that he has been lowering his price lately, and offering it for 10 cents per pound. Glucose put up in an attractive package, with a small piece of comb honey floating in it, had a big sale one season; but died so dead that it never resurrected.

The adulteration of extracted honey has grown to such large proportions that buyers are suspicious of the pure article. And many believe that comb honey is manufactured by feeding bees glucose. A buyer once came to our apiary, saying, "I want to buy some honey; there is plenty of that 'darned' white stuff in the stores, but I want bees' honey." He was furnished it, pure and unadulterated.

A woman called to get honey for a sick baby. I showed her extracted honey. She shook her head, saying, "The doctor said I must get comb honey and render it out, for loose honey is no good."

The adulteration of honey benefits small bee-keepers, for those who desire pure honey will go where they know bees are kept, to purchase it, and are willing to pay a big price for it.

Peoria, Ill.



Sweet Clover—Comb Honey Production, Etc.

BY O. P. MILLER.

Bees in this locality did fairly well the past season. All the surplus was gathered from white, sweet, and red clover. Linden or basswood lasted only a few days. Sweet clover did well. This year was my first experience with it. It grew seven feet high on rich land, bloomed continually for three months, and the bees worked on it all the time. People that have eaten of my honey say it is the best they have had this year.

I notice that Mr. Root does not know whether sweet clover will grow on rich land as well as on poor. In this part of the country it grows wherever it gets a chance—the richer

the ground the ranker the growth, but everybody fights it as a "noxious weed," and fit for nothing. And I had no little fun made of me for the patch I raised, but when it began to bloom, and people went along the road and scented the fragrance, and stopped to see from where it came—when they heard the roar of the thousands of bees gathering honey—some of them "changed their tune," and began to inquire for some of the seed. There is only two drawbacks to the plant that I know of: the first is, that it blooms only in alternate years, and the second is the large dead stalks left standing on the ground that has been occupied by the plant. The first probably can be remedied, for I know of a section of public highway where the white clover blooms every year, and has for 10 or more years, without missing a single year.

This is the first year that I have worked for comb honey. I have studied the question considerable, and as extracted honey has been slow sale during the last few years, I concluded to try what I could do in the comb honey line, so I run my apiary exclusively for it, and with the exception of a few colonies that wouldn't work, I got along all right, and to my entire satisfaction. My bees had plenty of stores for winter, and I have as fine a quality of comb honey as any one need ask for; and I am better prepared for another year's work than I was last. Further than that I know now that the theory formed by reading in the American Bee Journal and other bee-papers, is correct, speaking on general principles—some bees, you know, like some men, are as stubborn as mules, and won't work to suit you. If I had time and space I'd tell how I had to punish one colony before it would do anything.

During the past summer we captured 12 swarms and set them to work for us and themselves, and we cut only one beetrue—the others all came to us, entered into our hives and went to work. One of them filled 40 sections, besides 10 or 12 not sealed over, and also a 10-frame Langstroth hive.

I read, three or four years ago, about a plan to rear queens that I tried then, and it proved a success. I wished to try it this year, but could find it nowhere, neither in Doolittle's book nor in the American Bee Journal, although I have all the volumes for years back. Somebody that knows would confer a great favor on me by giving a description in the American Bee Journal before another year. I'd like to rear a few queens so that I can put Italian queens in the stray swarms that come to me. The plan was like this, except that I have forgotten some of the essential points:

Remove the queen, and in a given time all the cells started and unsealed brood, then in a short time give them a frame of unsealed brood and eggs. I had splendid success with this plan once, but missed it slick and clean this year.

Guthrie Co., Iowa.

A New Binder for holding a year's numbers of the American Bee Journal, we propose to mail, postpaid, to every subscriber who sends us 20 cents. It is called "The Wood Binder," is patented, and is an entirely new and very simple arrangement. Full printed directions accompany each Binder. Every reader should get it, and preserve the copies of the Bee Journal as fast as they are received. They are invaluable for reference, and at the low price of the Binder you can afford to get it yearly.

The Names and Addresses of all your bee-friends, who are not now taking the Bee Journal, are wanted at this office. Send them in, please, when sample copies will be mailed to them. Then you can secure their subscriptions, and earn some of the premiums we have offered. The next few months will be just the time to easily get new subscribers. Try it earnestly, at least.

Every Present Subscriber of the Bee Journal should be an agent for it, and get all others possible to subscribe for it. See offer on page 845.

CONVENTION PROCEEDINGS

Proceedings of the Illinois State Bee-Keepers' Convention Held in Chicago, Nov. 18 and 19, 1896.

BY A SPECIAL BEE JOURNAL REPORTER.

[Continued from page 819.]

MAKING HONEY-VINEGAR—IS IT PROFITABLE?

Dr. Miller—How many here have ever tried anything in the way of making honey-vinegar? [Five.] How many of these five have ever made anything of profit out of it? [Four.] I wanted to see whether we were losing time talking about this, but from the few who answer in that way, we are not losing time in talking about honey-vinegar.

Mr. Ellis—My grandmother, in my early days, started me to making honey-vinegar, and it was the finest vinegar we had. It is over 30 years ago, and I have seen others, away back East there, connected with those old families where the grandmother's knew almost everything that was to be known, and they did the same.

Mr. Grabbe—How many gallons of vinegar will one gallon of honey make?

Mr. Ellis—I never got that down to a fine point, but I should think it would make more than 15 gallons—I was going to say 20.

Mr. Cooley—How long does it take?

Mr. Ellis—Five or six weeks.

Dr. Miller—I think I learned more yesterday than I ever did about vinegar before. I spent two hours in the company of a man who uses a great many hundred barrels of vinegar. He uses vinegar enough to put up all the cucumbers that can be raised on a thousand acres of ground. His name is Stafford. He said: "I can buy as good vinegar as can be made, and it will do as good work—it will keep pickles—for 2 cts. a gallon." My first thought was, "If that is the case, there is no use to talk about honey-vinegar." Not very long after that, I think he told me there was some vinegar they cannot get for less than 60 cts. a gallon. That is from across the ocean; but that is on account of its flavor. There are two things—one the keeping quality, and the other the flavor. People talk about vinegar being strong and eating the pickles; but the stronger the vinegar the better it keeps the pickles. People will pay a good, big price for flavor. Mr. Cowan speaks in British Bee Journal about a market for his honey-vinegar, and if people are willing to pay for flavor, there is an outlet for it there. With regard to the amount, I think you are putting it pretty high if you say 15 gallons from one. It depends upon the kind of vinegar you want. Mr. France says you must have about three pounds of honey to a gallon of water. I think Mr. Cowan puts 1½ pounds to a gallon of water. I am not talking from experience. All my experience is in a jug, and it has been going for more than five weeks now. There is another thing, if you put three pounds to the gallon, it will take a long while to make it. For table vinegar, you want a milder article than you do for pickling vinegar. You must not have the very strongest kind for table.

Mr. Cooley—Does poor honey, or honey-dew, make good vinegar?

Dr. Miller—No, sir. I have read a good deal and have been trying to inform myself. My impression from that is, that the best quality of honey is none too good for making vinegar. The point that has been made is, that you can have the best quality of honey in a shape that could not be sold—the rinsing of cappings—but as it is not salable, it would simply be thrown out, but it will make the very best vinegar, because what little honey there is in it, will be the very best kind; so I think it will pay everyone of us to make the experiment.

Mr. York—I think the Dadants got 30 cts. a gallon for their honey-vinegar. Dr. Mason said he had nine barrels of honey-vinegar. He gets 20 cts. a gallon for it, and probably the reason he doesn't get more is because he doesn't ask it! There is no question about its quality. If the Dadants get 30

cts. a gallon, it is very cheap, because theirs will stand diluting 50 per cent.

Dr. Miller—Just let me read a few words from the last number of the British Bee Journal on this subject:

"Mr. Cowan said that when bee-keepers obtained honey of very dark color and inferior quality, such as would not have any chance of securing a market, the next best thing to do was to turn it into vinegar. He had tried some experiments in making vinegar from Mr. Bancks' recipe, and found little or no difficulty in producing a very excellent vinegar—better, as the grocers told him, than their white wine vinegar. He had received 1s. 10d. per gallon, a price that paid very well; and when they knew that vinegar could be made from honey which in the ordinary course would not fetch more than 2d. to 3d. per lb.—to say nothing of fermenting honey, which would hardly realize anything at all—they would agree that when 1½ lbs. of honey made a gallon of vinegar, it must pay well for the making. In making vinegar the first step was to mix honey with water in the proportion he had mentioned. The liquid was then placed in a cask; after which some ferment must be added, prepared vinous ferment being the best, but ordinary yeast might be used. In his own case the cask of liquor was put into a warm cupboard in the kitchen, where it remained a couple of months, until it began to sour, and, once acidification began, it went on very rapidly, until in two months and three weeks from first mixing, the vinegar was ready to be clarified with isinglass. This was done, and a fortnight later it was ready for market. He thought if that plan were carried out there would not be much difficulty in disposing of honey for which there was no sale otherwise."

Mr. Lyman—I have had some experience in honey-vinegar, and also in cider-vinegar. I wish there was as good a demand for honey as there is for good vinegar—it would not take long to sell all that is raised, but making the vinegar from honey-dew, won't do. I tried it as an experiment, and the peculiar flavor or odor of honey-dew will last for two or three years.

Dr. Miller—Years ago, I did try to make some vinegar out of honey-dew, but it was not a good thing.

Mr. Baldrige—I have from 10 to 15 gallons of honey-vinegar nearly all the time. When you speak about putting it in a jug to make, I don't think that is advisable. I make all of mine in an open cask, and keep it open, exposed to the air. I don't have a bit of trouble in making the very choicest of vinegar. I have never sold a great deal of vinegar, but what I have sold, I have always got 25 cts. a gallon for it, and those who have used it prefer it to anything they can get.

Mr. York—I think if you asked more, you could get it! (Laughter.)

Mr. Baldrige—I think I could.

SELLING GRANULATED EXTRACTED HONEY.

Ques. 9.—Should we put extracted honey on the market in a candied condition?

Mr. Schrier—No.

Dr. Miller—How many say we should put honey on the market in a candied form? [None.] How many say we should not put extracted honey on the market in a candied state? [Five.] Some one give me a reason in either direction.

Mr. Ellis—I watched Mr. Walker (of Michigan) last year, and I think he makes a pretty good standard when he handles tons of honey. He melted it all. He was in a place where they had these old-fashioned steam pipes, and he had the honey in five-gallon cans on top of the pipes; then he had two men canning that. Now he sold it at wholesale for six cents—wasn't it?

Mr. York—Unless he sold it in large quantities, I think he charged eight cents, when in 60-pound cans.

Mr. Ellis—He melted it all. What he would have done in large lots I do not know. It was all melted and put into cans. Then my own experience, more than 20 years ago, I found I could not have sold it all without melting it. When I sold it I would either have it labeled, or if disposing of it to anyone in a retail business, I would have a label stating that it would caudy, that it had been melted or warmed, and that they could expect, if it was kept long enough, it would all get back into the candy form, because otherwise it will be a great disappointment.

Mr. York—I think it is a great mistake to put honey on the market in groceries, that is candied. In talking with the buyer that I referred to, he said that some customers would bring back honey that granulated, thinking it was sugar. I think Mr. Grabbe, also Mr. Walker, exchange honey that is granulated. When they call on a grocer to see if he is entirely out, they take back the candied and leave the liquid honey. I have sold honey to one grocer whom I educated in that line, and he simply liquefied it himself. I think it is very impor-

tant to have on the label at least a few words, but not very many, for they won't read it. It might read thus: "If this honey granulates, rellequify by heating slowly; don't boil or overheat."

Dr. Miller—If I lived in Cincinnati, I think I would put granulated honey on the market.

Mr. Green—The only time I have ever tried to sell extracted honey to the consumer, it was all candied, and I had very little trouble in disposing of it. When you sell to a grocery store it ought to be liquefied. The difficulty of keeping it liquefied is the objection to melting candied honey, and if it gets to the consumer it may produce a worse effect than if they bought it candied.

Mr. Lyman—Those who buy candied honey never find any fault with it afterwards, but I find that groceries have lots of trouble, and unless it is exchanged, and kept in a liquid state, there is a great deal of trouble in disposing of extracted honey through grocers.

Mr. Chapman—You will find in France, Switzerland, Germany and Italy, it is sold in a candied state, but they are educated. Where you can sell candied honey in this country, it will be to those people; but the Americans have not that education.

Dr. Miller—That is just exactly the point. They are educated here. Mr. Muth has for years been educating the people in Cincinnati. They will buy the candied honey and won't buy the other. It took him some time to teach them. He has his customers trained to that, and they understand it. However, suppose that it is possible for me, in my locality, to train them to expect the candied honey, if it is heated over again by the ordinary customer, the chances are nine out of ten they will spoil it in the melting of it. It must be very carefully done, and if overheated it is hurt by it; so, even if you have it on your labels that they must melt it up, you can take it back and exchange it. The only point is, you can exchange, and keep the nice article on the market all the time.

Mr. Green—If honey has been melted several times it will often candy so as to be half liquid and half solid.

Dr. Miller—That suggests a point that possibly might be worth while mentioning. How many of you ever tried draining off honey? For instance, here is a large crock of honey; sometimes it will candy all solid, and leave a little liquid part above it; how many have tried pouring that off? [Three.] What was the result?

Mr. Lyman—I had a pretty good quality of honey-sugar left.

Dr. Miller—If you want something for your own use, to put on the table, let it candy and pour off that liquid and melt the remainder, and you'll make quite an improvement.

Mr. Ellis—Then what is the liquid?

Dr. Miller—I don't know. The liquid part is inclined to sour.

Mr. Chapman—Chemically, honey is composed of two sweets, one less sweet than the other, and the liquid contains the least sweet part and the acid.

Mr. Green—I always supposed this liquid part contained more glucose than any part.

Mr. Ellis—Isn't it just about along the line with rock candy—the part of the liquid that will crystallize? All the rest will not, and has to be used for cheaper grades. That's what I learned down on Michigan Avenue, where they handle such goods.

Dr. Miller—Whatever the theory may be, you try it, and you will have a very nice article of honey. Now, do you know any objection to that? There is one objection. It will candy back again. You have to keep melting it.

Mr. Ellis—How soon? A week I presume.

Dr. Miller—I guess if it is freezing, it will commence to candy in a week. Suppose you want to send honey away. Here is a friend that is visiting you from 500 or a 1000 miles away, and you would like very much to have him take some honey home. Take that, and have him take it home, and he can carry it exactly as he would sugar. Suppose you have taken a crock and drained it for a number of days, until thoroughly drained out, there will be nothing but what can be taken in a trunk among clothes.

PREVENTING OR DELAYING HONEY GRANULATION.

Ques. 10.—What can be done to prevent or delay granulation of honey put upon the retail market?

Dr. Miller—I should say, nothing that we want to do. If you want to modify that answer, you can do so.

Mr. York—Hasn't it been suggested that honey be heated, and then sealed, to delay the granulation?

Dr. Miller—Even with that in view, I should keep my answer the same, because I don't believe you can heat honey and put up enough without running so great a risk in spoiling the

honey, that it would not pay. You must heat it to about what degree of heat?

Mr. York—160, I believe.

Dr. Miller—I am not sure that 160° would keep it from granulating.

Mr. Lyman—Where honey is put up in bottles, would putting sealing-wax on top keep it from granulating?

Dr. Miller—I think it would help a very little, because that would keep it away from the air that much. It certainly would help some, but I don't think it would help such a great deal. I don't know.

Mr. York—Doesn't light have something to do with honey granulation?

Dr. Miller—I suppose it does. There might be something in keeping dark paper around it, if that would not be objectionable.

Mr. Ellis—You often see on labels, "Keep in a cool, dark place."

Mr. York—It isn't necessary to keep it in a cool place.

Mr. Ellis—I don't know.

Mr. York—I know one grocer who had some comb honey that he kept in an ice-box; he said if he didn't, it would leak and run all over everything! My wife tried to teach him differently, but he wouldn't listen to her.

Dr. Miller—Here is a point that comes in, the point of temperature. At what temperature will honey keep best from granulating?

Mr. Green—I don't know. I should think it would have to be over 80°.

Dr. Miller—What is the best temperature at which to keep extracted honey, or any honey?

Mr. Ellis—According to that, it is keeping it where it would be melting all the time. That is pretty near the temperature that would liquefy it.

Mr. Green—I have known it to granulate when the average temperature was not below 80°.

Mr. York—Of course, it is a well known fact that nearly all honey will granulate, but willow herb-honey will remain liquid for several months. I have had alfalfa honey to granulate solid in two weeks, in bottles.

Mr. Ellis—I didn't see any granulated honey in the month of May in New Mexico, and I had honey almost every day. The man I stayed with, bought it in five gallon cans from the man who produced it. He had his 200 colonies of bees, and said he never had seen any granulated honey. The alfalfa I had, came from Colorado, and it is very different. I think that Arizona and New Mexico honey is mixed more with cleome.

Dr. Miller—What is the best temperature at which to keep comb honey? I suppose what applies to extracted, would also apply to comb.

Mr. Baldwin—For what object?

Mr. Miller—For any object.

Mr. Green—I should prefer to keep comb honey at 100°.

Mr. Baldwin—The hotter it is, if not too hot to melt it, the better; you cannot keep the temperature even.

Dr. Miller—For instance, in my house, here is one room warmer than the other.

Mr. Baldwin—I should prefer the warm room.

Mr. Ellis—I ought to have added that the temperature was from 65° to 95° to 105° all the time I was in the southwest.

Dr. Miller—That might have something to do with it. The British Bee Journal very lately said the best temperature was in the neighborhood of 70° or 75°, not higher nor lower than that.

Mr. Green—When I was making more of a business of comb honey, I had such a room a very little larger than would hold the honey, and I put in a large lamp or oil-stove, and it kept that room up to 100° at least. I consider it very much of an improvement on the quality of the honey.

Dr. Miller—In that connection there is a point that I believe we should not lose sight of. If we have our honey exposed for a sufficient length of heat, that produces something I might call a permanent effect on honey. Years ago, I was in the habit of sending every year to my good old mother—who is now in Heaven—a package of honey, to Johnstown, Pa. One time when I was home, she said to me, "You n eedn't send me any honey this year. I have enough of that you sent me last year, and it is nice now." I was interested then to know whether she knew nice honey, and I asked her where she kept it, and she said up in the garret. I went up to see it, and it was next to the roof. Some of you know what the close garrets are, where there is no outlet, and in the winter time it is as cold as Greenland; but it had gone through that intense heat, and it was thick and rosy, and it got hard, it did not know enough to candy. I saw afterwards, and Mr. Kennedy saw at a meeting of a bee-association of which he is Secre-

tary, a sample of honey which was kept over in the same way.

Mr. Kennedy—I remember the honey, but I cannot call to mind the man's name.

Dr. Miller—It had been up in the garret. You know very well when you take honey that has been under ordinary care, taken off the hives, and it will be cracked by this time, even with the temperature this year, but that was not cracked, it was perfectly sound, everything about it, and it seems to me there was a permanent ripening up that comes in that way. That was comb honey. We might prevent granulation of honey by heating to a certain point. Is there anything else that can be done to prevent granulation of honey on the retail market?

Mr. Ellis—What would that be worth, Mr. Chairman, to put up honey prepared in that way?

Dr. Miller—How much more would the honey be worth?

Mr. Ellis—At least 2 cts. per lb. more.

Dr. Miller—Take ordinary honey and let it go through freezing weather, and it will be cracked and spoiled—it is worth 3 cts. below the market, and the other way it ought to be above the market.

Mr. Ellis—Not only that, but they must keep it over a year in order to keep it as your mother kept it, and let it be exposed in that way to that degree of heat.

Mr. Green—It isn't necessary to keep it over a year. It can be kept in an ordinary heated room, and the quality improved in that way in a shorter time. I kept my room heated for two months, and then sold the honey.

Dr. Miller—What do you mean by keeping it heated?

Mr. Green—A large lamp or oil-stove was kept burning there night and day.

Dr. Miller—At what temperature did you keep it?

Mr. Green—Much of the time over 100°. It didn't cost me over an average of perhaps 5 to 8 cts. a day to keep the room warm with 1500 to 2000 lbs. of honey in it. I know it paid me well in the improved quality of the honey.

Mr. Ellis—Was it rosy, like that?

Mr. Green—Yes, sir; not so much so, though.

Mr. Kennedy—Was that in the winter time?

Mr. Green—In the fall, from the time it was taken off the hives until I sold it, or the greater part of it.

Dr. Miller—If I am correct in that theory—that heating it up to a certain point for a certain length of time makes a permanent change—then that time should be during the warm weather, when a very little artificial heat would cost us much less than it would in the winter time.

Mr. Ellis—What is the heat of a colony of bees?

Dr. Miller—I think about 90°.

The convention then adjourned until 9:30 o'clock the next forenoon.

(To be continued.)



Lincoln Convention Report—Some Corrections.

BY R. C. AIKIN.

In reading the Convention Report I find I have been quite unfortunate in my statements, have said things I never intended to say, or have been misunderstood or misquoted. Whatever has been the trouble, I want to correct some of the statements, for if they go uncorrected I would not blame some of the fraternity for hopping onto me "rough shod."

On page 705 (Nov. 5th issue), first column, occurs this paragraph:

"When I lived in eastern Iowa we produced heart's-ease honey. In going from there to Colorado I met a man who had heart's-ease honey. I recognized the old honey we produced in Page Co., Iowa. This man gave me a couple of sections, and when I took it and let it run into the alfalfa honey it became very dark. Alfalfa honey is white. Now, if I remember correctly, Mr. Wallenmeyer, of Indiana, mixes heart's-ease and alfalfa honey together, and then sells it. Heart's-ease honey is lighter-colored in Iowa than in Kansas."

Now, what I tried to tell the convention was that I had previously lived in southwestern Iowa, and there produced heart's-ease honey; that on my way from Colorado to the convention I came through Washington Co., Kans., and there called on Mr. Weakley who gave me a sample of his heart's-ease honey; that in comparison with alfalfa which I had with me it was *very dark*, much darker than any heart's-ease honey I had ever seen.

The report makes me say that "Mr. Wallenmeyer, of Indiana, mixes heart's-ease and alfalfa and then sells it;" but I stated that Mr. Wallenmeyer says that with him heart's-ease honey is whiter than alfalfa.

On page 706, near the top of the first column, comes the following:

"I had almost a failure. There has been bloom all over, and it has been a good year, but I have taken very little honey. I live north of Denver, in Colorado. In 1889 my average from 165 colonies was 150 pounds; the next year from the same number of colonies, 100 pounds average; the next year about 50 or 60; the next year 10 pounds, and this year almost nothing. In Iowa I have taken 227 pounds per colony from 11 colonies. A man can get double the amount of extracted honey from a colony that he can of comb honey. I can make more money by producing extracted than by producing comb honey."

In the second line where it says "has been a good year," etc., it should say "has not been," etc. Near the end of the paragraph where it says "a man cau," etc., it should read "a man cannot," etc. The last sentence of the quotation should begin "I cannot," instead of "I can."

Again, in the same column occurs this:

"I came from Loveland, Colo., through Pueblo, and through Kansas, to get here, and I consider alfalfa to be an excellent and reliable honey-plant. In the irrigated country where I live, we are less liable to have a failure than where they have a small amount of rain. In Iowa, since I have been there, they had only about one complete failure in fifteen years."

This last sentence should read, "In Colorado, where I live, there has been but one complete failure in fifteen years."

Continuing, the same paragraph reads: "At Greeley, Colo., they had a complete failure this year, and nearly so at Loveland. North of Loveland they have done better. At Denver, just before the honey-flow the bees vanished and no one could tell where they went to. One man said he had 225 colonies, and could only find 25 colonies afterward. Mr. W. L. Porter, a bee-keeper near Denver, said that after the bees had gone he did not have enough bees left to cover his hand."

The next to the last sentence in the quotation where it reads, "and could only find 25 colonies afterward," it should read, "had not enough bees left to make 25 good colonies." In the last sentence after the word "gone" drop the word "he," and insert "many colonies."

Again, on page 724, first column, near the bottom we find this:

"There is a firm in our State (Colorado) to whom I have sold considerable extracted honey. I have been in their establishment often. They openly charge all bee-keepers in and about Denver with adulterating."

The last sentence should read "the beekeepers charge the firm," not the firm the beekeepers.

In the next column, and about the middle, is a paragraph that speaks of myself having eaten mixed honey in a hotel. The major part of that statement belongs to some other man, for I was not in a hotel while in the city.

In regard to the bee-keepers about Denver adulterating, I want to say that I believe them to be free from such practices.

There are some other errors, but they are such that there is no reflection on any one, and no material difference, so I will not mention them. Page Co., Iowa.

Bee Journal Complete for 1896.—We have a few complete sets of the American Bee Journal for 1896 (or will have by Jan. 1) which we will be pleased to mail to any one for 75 cents each, so long as they last. A "Wood Binder" to hold the year's numbers will be sent for 15 cents extra. Think of it—only 90 cents for this year's volume of the Bee Journal and a binder—848 pages!

Now is the Time to work for new subscribers. Why not take advantage of the offer made on page 845?

PERSONAL MENTION.

MR. J. M. HARDING, of Maine, writes: "I find the American Bee Journal very valuable—more than the year's price in some single numbers."

MR. J. MESSINOER—another Wisconsin bee-keeper—left for Florida last week, where he will spend a few months. If a few more Northern bee-keepers go down there, we'll feel like going, too. There are Mrs. L. Harrison, Frank McNay, O. O. Poppleton, and J. Messinger, now in Florida. Yes, and possibly many more we haven't heard of. All right; let them have a good time. It may be our turn some time.

MR. L. E. EVANS, of Michigan, gives this estimate of the Bee Journal when renewing his subscription for 1897:

"The good 'old reliable' American Bee Journal, that comes every Thursday, is a welcome friend. I have had several years' experience in bee-keeping, and think I am quite expert in handling bees, but I quite often find a single article in the Bee Journal that is worth more than twice its subscription price. I hope the good work of Editor York will never grow less."

MR. C. THEILMANN, of Minnesota, has been spending a few days in Chicago looking after the marketing of his crop of honey. He had some 13 thousand pounds of fine honey, some 600 pounds being extracted, taken from about 200 colonies, spring count. He has 250 colonies now, wintering in two cellars. Mr. Theilmann is one of the unfortunates that fell into the trap of a crooked Chicago commission house. He will have an interesting experience to tell a little later on.

MR. E. E. HASTY, the Review's "inimitable" "viewer of current bee-writings," in the November number makes a few comparisons of the Bee Journal of the fall of 1894 with the Bee Journal of to-day. He sees some points of improvement, and among them mentions this:

"Two years ago the American Bee Journal was half-sized, and had twice as many pages as now—and wore an air of trying to make matter cover as much space as possible. It does not look that way at present—rather wears the look of trying to crowd as much matter as possible into the available space."

MR. WM. A. PRYAL, of Oakland, Calif., an old contributor to the American Bee Journal, lost his beloved mother by death on Dec. 4, after an illness of four months. Mr. Pryal writes: "A more devoted mother never lived; I could write pages about our good mother." Of course he could. How blessed are our dear mothers; and how sacred their memories after they have passed over to the other shore. And what a rejoicing there will be some day when all their children and loved ones meet again. Blessed mothers; happy meeting.

MR. CHALON FOWLS, of Ohio, writes us as follows:

"The American Bee Journal is doing a good work in showing up the dishonest commission men, and pushing the war against adulterators. I hope the United States Bee-Keepers' Union will be a 'go.' I will be ready to join as soon as the new organization is ready for business."

That's just what a good many are saying about the New Union. It will be a "go" all right, don't fear that. It *must* "go," for it is right that it should—it is just what bee-keepers need at this very time. Let all get ready to join in the good work.

DR. C. C. MILLER was recently pictured in the local newspaper published at Marengo, Ill., by our esteemed friend, Mr. J. B. Babcock, who copied the Doctor's address to the students at Lincoln, Nebr., and also the words of the song he sang for them. That our readers may know just what Dr. Miller's neighbors and intimate acquaintances think of him, we extract the following, with which Editor Babcock closes the two-column article:

"Of Dr. Miller, we may say that we esteem him highly as a personal friend, and have for more than 40 years, and he is so esteemed by everybody in our community. He is a very useful man, a member of the Presbyterian church, but jumps over sectarian division fences very easily, and, seen in a Meth-

odist meeting, he is as zealous and enthusiastic as the most pronounced follower of Wesley. He is serving his third term as President of the McHenry County Sunday School Association, and of the District Association; is President of the State Bee-Keepers' Association; is a musical author and a book author. More might be said, but enough for the present. There is no fulsome praise in what has been said—it is the truth, but not the whole truth, for the whole truth would only be more of the same kind.

"Dr. Miller is worthy of all the good things that may be said of him, and it will not make him giddy either, but possibly be a stimulus in his life-work."

MR. JOHN H. HODGKINS, of Winnebago Co., Ill., wrote thus when sending his renewal for 1897:

"We have had three years of failure in the honey-crop here, but I do not see how I can get along without the American Bee Journal."

Feeding to Rear Bees for the Harvest.

From a given date (say Aug. 1), how many weeks back should I begin feeding for the purpose of rearing the population of the hive, in order to have young bees old enough to work in the field on that date? E. M.

Stamford, Conn.

ANSWER.—At any time when bees are flying and getting nothing, so that the queen has slacked up in laying, if you commence feeding you may probably expect the queen to commence laying within two days. Then in 21 days the young workers will emerge and be ready in about 16 days more for field-work. Adding 2, 21, and 16 together, gives 39 days. So according to those figures you should commence feeding about 39 days before the time you want the bees to *begin* on the harvest. Another element comes in that may not be so easy to figure on. That is, as to the *number* of workers you want to have ready. For if you want a large number on hand you must commence before the 39 days. On the other hand, it is probable that an increase in the number of nurse-bees will make a difference as to field-work, and the increase in nurse-bees ought to be 16 days sooner, or in about 18 days. Taking all things into consideration, perhaps it may not be out of the way to suggest feeding six weeks before the time you expect the storing to begin.

Michigan State Convention.—The Michigan State bee-keepers will hold their annual convention Jan. 1 and 2, at the Donovan House, in Mt. Pleasant. The first session will be held on the evening of the 1st. There will be papers and speeches from such men as the Hon. R. L. Taylor, of Lapeer, who has charge of the Michigan State Experiment Apiary; M. H. Hunt, of Bell Branch; L. A. Aspinwall, of Jackson; T. F. Bingham, of Farwell; and W. Z. Hutchinson, of Flint. All are cordially invited to attend and give their experience, and to ask questions. Rates will be low on all the railroads.

Honey as Food and Medicine.—A new and revised edition of this 32-page pamphlet is now issued. It has 5 blank pages on which to write or paste recipes taken from other sources. It is just what its name indicates, and should be liberally distributed among the people everywhere to create a demand for honey. It contains a number of recipes on the use of honey as food and as medicine, besides much other interesting and valuable information. Prices, postpaid, are: Single copy, 5 cts.; 25 copies 75 cts.; 50 for \$1.10; 100 for \$1.50. Better give them a trial. Send all orders to the Bee Journal office.

A New Clubbing Rate has been arranged for Gleanings in Bee-Culture and the Bee-Keepers' Review with the American Bee Journal. Hereafter either of the two papers named will be clubbed with the Bee Journal for one year, for \$1.90. Heretofore the rate was \$1.75.

OLDEST BEE PAPER IN AMERICA

THE AMERICAN BEE JOURNAL

ESTABLISHED IN 1861

GEORGE W. YORK, Editor.

PUBLISHED WEEKLY BY

GEORGE W. YORK & COMPANY,

118 Michigan St., CHICAGO, ILL.

\$1.00 a Year—Sample Copy Sent Free.

[Entered at the Post-Office at Chicago as Second-Class Mail-Matter.]

Vol. XXXVI. CHICAGO, ILL., DEC. 31, 1896. No. 53.

EDITORIAL COMMENTS.

A Happy New Year to all our friends! To-day another year ends—to-morrow the New Year begins. May the next be a happy and prosperous year to you all. And may all the best of your new-made resolutions be faithfully kept. Each year we all should advance—should be better prepared to do more telling work. Let us all strive to live better, to labor more earnestly, and seek only to do our best in all things. Then no doubt the bright New Year will indeed be a happy and satisfactory one.

Once more, and to each and every one—

A HAPPY NEW YEAR.

A Complete Index to Volume 36 will be found in this number of the Bee Journal. We believe it is fairly correct, and doubtless will prove of great value to all who preserve their copies from week to week. We think that any pride we may feel in our annual index is quite pardonable. It indicates a wonderful amount of information on the subject of bees, and is arranged in such a way as to be very helpful, in that almost any or every important topic brought up during this year may easily and quickly be found and re-read, if desired.

This is the 53rd Number of the American Bee Journal for 1896—a sort of New Year's present to you. Ordinarily 52 numbers are all that could be expected in one year, but this is one of the years that calls for an extra number. We have no doubt it will be duly appreciated, but we almost felt that the great majority of our readers would have been entirely satisfied had we omitted this number, and closed the volume with the 52nd issue, last week. No other bee-paper in America is ever called upon to publish more than its usual 12 or 24 numbers in any one year. But this year our readers get 53 copies for \$1.00, instead of the usual 52. Nothing like good measure, you know.

Volume XXXVI Completed.—This number of the American Bee Journal finishes the 36th volume. Getting along in years somewhat. But so long as it "improves with age," perhaps no one will entertain serious objections. Volume 37 begins next week. We wish that *all* who are now getting the Bee Journal could continue right along, but, as usual, there will doubtless be quite a number who will feel that they must part company with it. Well, our best wishes are herewith extended to all such, and we trust that some day they may again be found among our readers. Our latch-string ever hangs outward; pull it, and come in at any time the spirit moves you to do so.

Members for the New Union.—At the late meeting of the Minnesota State Bee-Keepers' Association, held at Minneapolis, the subject of the new United States Bee-Keepers' Union was fully discussed, and seven of the members paid in their dues of \$1.00 each, saying that if more was needed it would be forthcoming. They liked the idea of prosecuting dishonest commission-men and adulterators of honey, and were glad to help on such a

good work in the interest of bee-keepers. The names of the seven members (with the \$7.00 for dues) were forwarded to the Secretary, Dr. Mason, who no doubt was pleased to enroll them in the list of members of the New Union. There is nothing to hinder others from joining now, if they wish, and we will receive their dues, if it is more convenient to send to us. Then when the two societies are united (which we presume will be about Feb. 1, 1897) the money in both treasuries can be put into one, and all go toward carrying out the work proposed to be done under the New Constitution.

The above only shows that bee-keepers are ready to join an association where all will be benefitted alike. While the old Union has done most excellent work along its one line of defense of the right to keep bees, that work has been confined almost wholly to the few who have gotten into trouble with their neighbors; and, besides, the question is now pretty well settled by strong court decisions. What is needed now is to get after the honey-dealing frauds and swindlers, as well as securing the enactment of good anti-adulteration laws applying to all food products. Along these two lines the New Union would find plenty of opportunity to do some good work. And when bee-keepers once see that there is a prospect of something being done toward putting an end to fraudulent honey commission firms and adulteration of honey, we have no doubt there will be a great rush to join the New Union.

Help Correct Postal Abuses.—In the House of Representatives Bill 4566—the Loud Bill—will be up for consideration Jan. 5 and 6; the final vote will be taken on Jan. 6. The object of this Bill is to correct many of the flagrant postal abuses on the part of certain publications that should not be entitled to the low second-class or newspaper rate of one cent per pound, but which now are causing a big annual expense to the Post-Office Department. The Department would be entirely self-sustaining if all publications were compelled to pay the proper postage rate. The Loud Bill will help correct the matter. Write *at once* to your Representatives at Washington, urging them to *be sure* to vote for the Loud Bill. It ought to pass, as it is the right kind of legislation, entirely in the interest of every taxpayer and legitimate publication.

Resolutions of Endorsement.—It seems that at the recent meeting of the Minnesota State Bee-Keepers' Association those present discussed pretty thoroughly the honey commission business in all its phases. One of the results was the passage of a resolution or two, which we received with the following letter from the Secretary:

CRYSTAL, Minn., Dec. 8, 1896.

MR. GEO. W. YORK, Chicago, Ill.

My Dear Sir:—Enclosed find a copy of the resolution passed at the annual meeting of our State Bee-Keepers' Association, held in Minneapolis, Dec. 2 and 3. I assure you that the Association feels very kindly to you for the work you have been doing for them and others by your manly exposition of commission-house frauds. Mr. C. Theilmann, who has suffered so much from these dishonest people, speaks in the highest terms of the aid you gave him. That the American Bee Journal and its Editor may be prospered, is the wish of all Minnesota bee-keepers. E. K. JAQUES, Sec.

The resolutions referred to by Mr. Jaques in the foregoing read as follows:

Resolved. That the Minnesota Bee-Keepers' Association tender their thanks to Mr. York for the bold manner in which he has exposed the rascals and sharks among the commission-men in Chicago, and for the position he has taken in regard to the adulteration of honey.

It was moved, seconded, and unanimously carried, that the resolution passed, endorsing the New Constitution adopted by the North American Bee-Keepers' Association, and advising all beemen in Minnesota to join the New Union, be sent to the American Bee Journal for publication, or whatever action it may see fit to take.

We wish to sincerely thank the Minnesota bee-keepers for their kind expression in our behalf. We feel that we have done only what is right in exposing frauds and opposing honey-adulteration, and we believe that if we can have the continued support of bee-keepers, short work can be made of all who start out to swindle honey-producers; and also that with the help of the proposed United States Bee-Keepers' Union a great deal can be done toward stopping the adulteration of honey.

Index to Vol. XXXV

SUBJECTS.

Abbott's (E. T.) address 708
 Adela vs. italians 746
 Adulteration of honey 103, 117, 140, 267, 309, 323, 509, 723, 756, 788, 819 835
 After-swarms 84, 482
 Age of bees 6, 121
 Alfalfa 6, 169, 173, 186, 215, 396, 435
 Alfalfa honey candy 152
 All honey in the sections 172
 Alsike clover 7, 65, 91
 Amalgamation 3, 90, 108, 149, 152, 162, 178, 195, 211, 221, 237, 247, 253, 339, 282, 322, 328, 490, 691, 736, 770, 776, 788, 790, 792, 794 824
 Anonias and Sapphira stories 411
 Apicultural nomenclature 138
 Apicultural patents and inventions 713, 834
 Apis dorsata 217, 280, 344, 403, 617, 715, 789, 802, 809
 Arbot-day for bee-keepers 168
 Artificial bee-pasture 55

Balling queens 7, 359
 Bareheaded brood 629
 Basswood 150, 423, 456, 534, 682
 Basswood growing 169, 181
 Bee-cellers 4, 39, 90, 125, 820
 Bee-conventiona 341
 Bee-culture 23, 100
 "Bee-day" 472
 Bee-escapes 89, 105, 385, 637, 829
 Bee-farms in Serbia 41
 Bee-ferage 177
 Bee-keepers' societies 322
 Bee-keepers' Union 242, 250, 291, 328, 354
 Bee-keeping a profitable industry 42
 Bee-keeping for women 57, 341

BEE-KEEPING IN—
 Arizona 504
 Arkansas 204
 California 2, 34, 67, 146, 147, 344, 398, 526, 536, 616
 Colorado 219, 299
 England 55
 Florida 223
 Germany 216
 Illinois 216
 Indian Territory 731
 Maryland 220, 412
 Mexico 427
 Nebraska 6, 304, 616, 675, 732
 Northern Indiana 794
 Oregon 315
 South 415
 South Dakota 716
 United States 72
 Utah 374
 Virginia 171, 283
 West Virginia 204

Bee-martin or king-bird 290
 Bee-paralysis 73, 133, 311, 420, 424, 470, 533, 626
 Bee-pasturage 102
 Bee-quilts 122
 Bees and agriculture 456
 Bees and apricots 434
 Bees and Italy 92, 100, 184, 291, 345, 418, 466, 492
 Bees and grapes 59, 184, 236, 397, 625, 710
 Bees and pollen 757
 Bees are animals 235
 Bees by the pound 698
 Bees cutting leaves 67
 Bees eating in winter quarters 33, 190, 282
 Bees for Alaska 138
 Bees in a green-house 428
 Bee-smokers 122
 Bees moving eggs 465
 Bees near a railroad 24, 29, 63
 Bees not a nuisance 280
 Bee-space 335
 Bees throwing out their young 54
 Bee-sting 299, 428
 Bee-sting remedies 280
 Bees uneasy in the cellar 149
 Beeswax—tests of, etc. 18, 86, 135, 153, 169, 215, 231, 244, 266, 370, 405, 517 898
 Bee-cells 334
 Bee-zinc 73, 74, 390
 Beginners and bee-books 552
 Beginning of the bee-year 12
 Beginning the season 193

BIOGRAPHICAL—
 Bevins, Edwin 101
 Candler, Miss Mathilda 290
 Dabbs, J. 68
 Getaz, Adrian 41
 Hill, H. E. 495
 Howard, Dr. W. R. 711
 Mabin, Rev. M. 801
 Marvin, J. M. 277
 Pond, C. H. 158
 Raby, W. H. 137
 Swan, A. W. 137
 Thompson, F. L. 9

Blue pollen 393
 Bonnet 523, 698
 Borax 534
 Botanist among the bees 725
 Box-bives 66
 Breeding off wings 98
 Brood-combs 186, 231
 Brood-frame euda 535
 Bubby haia hay (poem) 237
 Buckhorn 390
 Buckwheat 102, 124
 Building comb when fed on sugar syrup 37
 Building for wintering bees 35
 Building up colonies in spring 86
 Building worker-comb vs. foundation 113
 Bumble-bee experience 604
 Burr-combs 3
 Burr-comb and brace-combs 616
 Bush clover 618
 Buying bees 119

Cage for hatching queens 506
 Caring queens during the honey-flow 423
 California Honey or Bee-Keepers' Exchange 81, 128, 130, 136, 168, 184, 216, 232, 289, 422, 610, 728, 780 777
 California "strained" honey 344
 Canadian pure-honey bill 104
 Canded comb honey 343
 Candy for bees in winter 374
 Care of comb honey 274
 Carniolan bees 386, 410
 Carniolan vs. Italians 150, 812
 Carrying bees out of the hive 581
 Carrying up the syrup 391
 Catnip honey 53, 130
 Cedar hives 471, 572, 573, 635
 Cellar for bees 564
 Cellar wintering of be. s. 258, 746
 Cell-cups 650
 Chaff cushions 389, 535
 Chaff hives 791
 Change of depth of cells 551
 Change of hive name 87
 Charming tune of swarming-time 366
 Cleaning sections of bee-ghee 535
 Cleome 435
 Clipping queens' wings 50, 71, 236, 284, 390, 506, 821
 Closed-end frame 266, 596
 Closed-end frame in winter 276
 Cochin China bees 599
 Colony banging out 119
 Color and solar heat 326
 Color of brood-comba 405
 Colors of hives 630
 Comb building 262, 361, 679
 Comb foundation without side walls 62
 Comb-guides and starters 566
 Comb honey in the South 802
 Comb honey production 178, 211, 241, 257, 276, 292, 324, 327, 340, 369, 449, 481, 580, 636, 658, 802, 833 835
 Comb-layer 345, 518
 Combs of canded hives 294, 10
 Comb space 198
 Combs with old dead brood 167
 Comb vs. extracted honey 38, 84, 116, 275, 298, 388
 Commission men 38, 45, 88, 98, 108, 120, 130, 133, 228, 264, 648 723
 Constitutions 633

CONVENTION REPORTS—
 Colorado 181, 196, 213, 229
 Connecticut 734
 Cortland Co., N. Y. 517
 Illinois 10, 21, 40, 69, 116, 132, 148, 264, 475, 653, 785, 804, 817 836
 International Bee-Keepers' Congress 23, 42, 57 102
 Kankakee, Ill. 165
 Los Angeles Co., Calif. 806
 Mesa Co., Colo. 166
 Michigan 341, 356
 North American 216, 223, 232, 248, 633, 673, 689, 689, 705, 712, 720, 737, 738, 742, 744, 753, 838
 Northern Illinois 587
 Ontario, Canada 164, 179, 776
 Ontario Co., N. Y. 166
 Oxford, Ontario 103
 Seneca Co., N. Y. 165
 Southeastern Minnesota 660
 Southern Bee-Keepers' 774
 Southwestern Wisconsin 774
 Utah 313, 786
 Vermont 380

Corn honey 551, 556, 603, 775
 Cost of producing a pound of honey 132
 Covering over frames 746
 Crimmon clover 91, 98, 102, 205, 296, 423, 520
 Crooked combs 714
 Cubical hive 650
 Currants preserved in extracted honey 153
 Cutting foundation for sections 357
 Cyprian bees 730
 Cypro-Italian bees 650

Dark and bright side 170
 Dark honey and home market 521
 Dark pollen 375
 Day flower 478

DEATH NOTICES—
 Hallenbeck, Mrs. A. L. 809
 Pringle, Allen 521, 529
 Root, Mrs. Lyman C. 88
 Taylor, Barnett 537, 561
 Tuttle, Ernest II 764

De honey am comin' in de doah (poem) 388
 Difference in colonies 170
 Distinguishing Italians from hybrids 180
 Dividing for increase 145, 162, 214, 375, 594
 Divisible brood-chamber hives 34
 Do bees freeze or starve? 21
 Doctoring 644
 Does fond affectio va wurket of bees? 153
 Do field-bees play? 34
 "Don'ts" for beginners 121
 "Don'ts" for honey-buyers 458
 Doolittle's beginning 71
 Double hives for wintering 698
 Double or single walls for wintering 166
 Doves vs. single walls 105
 Doubling up colonies or swarms 87, 95, 110
 "Dovetailed" corner 189
 Dragging out drone-larvae 470
 Drawn combs for surplus honey and controlling swarming 515, 572, 642, 681
 Drone comb 146, 611
 Drone foundation vs. worker of bees? 183
 Drone-laying queen 762
 Drones 85, 388, 643, 803
 Drones from impurely-mated queens 465
 Drones mating with worker-bees 493
 Drone-trap 390
 Drops of sweat over the bees 762
 Dry weather vine and honey 12, 89

Economic value of bees and their products 753
 Editors of bee-papers 729
 Effect of bee-stings on the human system 306
 Empty combs 112, 191, 234, 244, 260
 Enamel cloth covers 198
 Enemies of bees 117, 218, 278
 English bee and honey show 599

Enlarging hives and frames 669
 Extracts made 470
 Brysipelas cured with honey 312
 Encalyptus and honey 473, 610, 792
 Evaporating thin honey 471
 Evolution of associations 84
 Exhibiting bees, honey, etc., at fairs 531, 629, 650
 Experience in bee-keeping 417, 434, 451, 468, 762, 816, 832, 547 563
 Exporting honey 313
 Exports of beeswax and honey 440
 Extracted honey 58, 134, 636, 755
 Extracting frames 234
 Extracting honey 74, 86, 167, 182

Farmer bee-keeping 299
 Farming 96
 Fastening foundation 46, 85, 239, 460
 Fat bees 172
 Feeding back 90, 436
 Feeding bees 21, 31, 73, 74, 87, 122, 180, 185, 201, 205, 265, 360, 713, 762 778
 Feeding bees sugar 531
 Feeding honey to water 662
 Feeding for winter 629
 Feeding to promote queen-laying 817
 Feeding to rear bees for the harvest 839
 Fertilization of queens 251, 518
 Figwort 467, 540, 618
 Finding queens 118, 151, 294, 326
 Fungus on combs and honey 39, 185
 Five-banded Italiana bees 363
 Flour for pollen 745
 Flowery month of June (poem) 405
 Flax honey 149
 Following the wild flowers 358
 Food for larval bees 106, 119, 133, 141, 144
 Food for bees 163, 164, 181, 212, 252, 254, 290, 294, 314, 319, 354, 382, 408, 450, 488, 506, 509, 539, 665, 714, 775, 787 827
 Foundation in sections 164
 Foxglove honey 215
 Frame cross-bar instead of wiring 326
 Frame size and measurements 198
 Frame spacers 199
 Freight rates on extracted honey 569
 Full sheets of foundation in brood-frames 118
 Full sheets of foundation in sections 613
 Full weight sections of honey 614
 Fungus on combs and honey 134, 326
 Fungus on combs and honey 274, 365
 Fun of bee-keeping 34
 Future of bee-keeping 153

Gallip's medical views 780
 Galvanized iron tanks for honey 598
 Getting all honey in the sections 135
 Getting honey out of a colony 87, 347, 409 566
 Getting others into bee-keeping 153
 Getting the public to use honey 818
 Gnawing of the cappings 139
 Going into hives 636
 Golden colony honey system 514
 Golden Italians 387, 514
 Good honey crops again 829
 Grading honey 217, 233
 Granulated extracted honey—selling it 836
 Granulation or candying of honey 248, 266, 616, 665 837

"Handy" shipping-crate 199
 Hearts's ease 49
 Heating honey 36, 293, 392
 Hive-carrier 84
 Hive contraction and management 68, 211
 Hive entrance in winter 35
 Hives for the general farmer 83
 Hives from foul-broody colonies 83
 Hives—large and small, etc. 3, 34, 35, 46, 54, 62, 63, 73, 76, 94, 106, 131, 139, 157, 179, 194, 195, 215, 234, 252, 261, 277, 278, 316, 327, 339, 388, 391, 421, 416, 509, 566, 609, 660 670
 Hives on posts 662
 Hives on platform 87, 423, 443, 450
 Hoffman frames—tongue vs. saw-kerf 805
 Holy Land bees 133, 158
 Home market for honey 641, 649, 763, 798, 818
 Honey as a food 601
 Honey at a wedding 600
 Honey-boards 89, 390
 Honey-cans 139
 Honey competition 179, 255, 291
 Honey crop of 1896 408, 456, 520, 569, 632, 680
 Honey—diabetic value 247
 Honey education 312
 Honey exchange 117, 325
 Honey fermentation 598
 Honey-flows—something about them 435
 Honey for wintering 485
 Honey-guide 134
 Honey-house 138
 Honey in the market 808
 Honey jumbles and genus 418
 Honey loast 597
 Honey market of the United States for 1896 293
 Honey or sugar for spring feeding 285
 Honey-plants 474
 Honey-plants that have disappeared or are on the increase 273, 324, 332 453
 Honey-producers helping themselves 617, 649, 793
 Honey recipes 594
 Honey selling in Belgium 523
 Honey-suckle 896
 Honey-vinegar 40, 54, 84
 Horrie & Co. 184, 291
 Horticultural fable 106, 161, 195, 206, 232, 275, 698, 730 823
 Honey-aparies 106, 161, 195, 206, 232, 275, 698, 730 823
 Hunting bees 278, 403, 454, 493, 684, 794
 Hunting wild bees 278, 403, 454, 493, 684, 794

Illinois State fair and exhibits 472, 601, 664
 Improvements in bees and bee-culture 536, 739, 821
 Increase by dividing or by natural swarming 821
 Introducing queens 247, 250, 311, 603, 658, 728, 745 789
 Inverting sections to fasten comb 471
 Italianizing 151, 780

Judging honey..... 152
Juniper-wood hives..... 599

Keep cool with bees..... 280
Keeping bee-eggs and royal jelly..... 442, 555
Keeping bees in a house in a city..... 526
Keeping bees in a shed..... 310
Keeping bees on shares..... 643
Keeping bees pure..... 119
Keeping combs over winter..... 729
Keeping colonies to increase..... 150, 375
Kegs for honey..... 37
Killing a colony of bees..... 550
Killing off drones..... 466
Kind of hive to use..... 762
"Knows" and "don't knows"..... 77

Ladybird beetles as related to bee-culture..... 627
Largest field of honey..... 3, 26, 164, 200
Late drone-rearing..... 40, 43, 124, 168, 171, 262, 713
Late-reared bees for strong colonies for wintering..... 554
Late-reared queens..... 617
Laws of breeding—application to bees..... 759
Laying workers..... 85, 122, 499
Leather-colored bees..... 119, 204
Leaving the hive..... 390
Leaving the surplus arrangement on in winter..... 650
Liquefying honey..... 55, 131
Locality and the bees..... 572
Locating an apiary..... 204
Longevity of bees and queens..... 91, 138, 196, 274, 296
Long tongue—advantage of..... 544
Losing queens by doubling..... 130
Loss of queens..... 660
Lotus..... 619
Low prices of honey..... 295, 503
Lyaol and foul brood..... 498, 506, 582

Maclean's (Chancellor) address..... 757
Magic section press..... 207
Making a feed syrup for bees..... 122
Making a swarm stay..... 506
Making bees drunk..... 84
Mailing queens..... 376, 499, 555, 779
Management for best results..... 85, 114, 195, 822
Managing swarms..... 117
Manipulating frames..... 826
Manufactured honey—hardly..... 791
Maple syrup for feeding..... 791
Marketing honey..... 20, 24, 29, 39, 45, 55, 56, 76, 82, 93, 97, 107, 120, 121, 130, 132, 133, 136, 141, 180, 181, 187, 191, 200, 213, 230, 236, 295, 308, 399, 411, 316, 337, 391, 413, 440, 489, 531, 548, 563, 568, 574, 595, 620, 643, 659, 681, 693, 732, 758, 774
Marking hive-entrances..... 186
Mating of queens..... 232, 345
McCartney section press and foundation fastener..... 646
Mesquite..... 281
Mice destroy honey..... 540
Midbar in Langstroth frames..... 424
Milk and honey..... 635
Milkweed pollen-masses..... 359, 629, 639
Miller's (Dr.) address to students..... 725
Minnesota fair and exhibit..... 537
Mint..... 668
Model home..... 294
Moonlight bees..... 605
Moore's (Gov.) address..... 706
Motherwort..... 390
Moth-worms and moths..... 373, 506, 643, 778
Mountain Laurel honey..... 92, 220, 245
Moving bees..... 20, 53, 63, 106, 124, 133, 184, 150, 158, 265
Moving eggs..... 139, 140
Mustard honey..... 506

Nailing Hoffman frames..... 298
Narrow sections and slotted separators..... 614
National bee-keepers' exchange..... 630
National Bee-keepers' Union..... 249
National Bee-keepers' Union report for 1895..... 59, 110, 788
Natural stores..... 345
Natural vs. artificial swarming..... 614
Nebraska irrigation fair..... 610
Nectar and its secretion..... 115, 484, 526
Neocleid as a secretary..... 25, 504
New bee-papers..... 25, 504
New constitutions..... 612
New or old comb for section honey..... 827
New union and honey exchange..... 601
Non-swarming bees..... 39, 39, 49, 66, 82, 107, 261, 486
Non-swarming in large hives..... 501
North Carolina experiment station..... 290, 295
Notes from Virgil..... 533, 546, 565
Not storing surplus honey..... 486
Nucleus-box method of making nuclei..... 167
Nucleus—story of..... 812
Numbering hives..... 91, 92, 93, 130, 137, 140, 259
Number of bees as a queen's escort..... 637
Number of bees in a quart..... 278
Number of brood-frames during the harvest..... 134
Number of colonies to begin with..... 132
Number of eggs in a queen-bee..... 349
Number of pounds gathered in a day..... 438
Number of seeds to the pound..... 312
Number of supers to the colony..... 185

Observations and reflections..... 546
Observing bee-hive as an educator..... 562
Odd-size frame..... 166
Odor of honey cans and kegs..... 598, 731
Old can frames..... 121, 295
Old combs..... 278
Old elm..... 174
Old sections filled with comb..... 117
Old-time honey seasons—will they return?..... 279
"Old woman's bustle" plant..... 780
One-frame nucleus..... 90
Only a cold..... 191
Open letter to Dr. Miller..... 255
Orange-bloom..... 290
Our darling baby Hugh (poem)..... 749
Out-Apiaries..... 116, 714
Out vs. indoor wintering..... 130

Paradise for the honey-bee..... 770
Partly-filled sections..... 806
Partidge brood..... 478, 618
Past and future of bee-keeping..... 722
Past and present of bee-keeping..... 163, 376
Pattens slats..... 87
Peppermint..... 227
Pepper-tree honey..... 569
Phenomenal colony of bees..... 261
Picked brood, or white fungus..... 577, 584, 612
Placing hives..... 46, 92, 369
Planofog for next season..... 24
Planofog for honey..... 69, 371, 741
Plant trees..... 249
Plums frosted..... 174
Poisonous honey..... 146, 215, 239, 245, 262, 372, 441, 465, 466, 477, 482, 505, 726, 695, 770..... 772
Pollen ferment in cells..... 773
Pollenized brood-combs—cleansing..... 678
Position of apiculture..... 329
Position of supers..... 506
Postal abuses..... 840
Poultry with bees..... 170, 311
Preparation of bees for winter..... 453, 636
Prevention of bee-diarthra..... 294
Prevention of increase and swarming..... 103, 234
Price of honey..... 305
Production of honey..... 308
Producing colony of bees..... 451, 596
Propolis poisoning..... 204
Prospect for future seasons..... 309
Purchasing bee-supplies..... 231
Pure-blooded bees..... 629
Pure honey bill..... 164, 472
Purity vs. good workers in bees..... 773
Putting bees out early..... 317
Queen fertilization in confinement..... 103, 617
Putting in foundation..... 86
Putting on a super..... 340
Putting on sections..... 440
Putting swarms back..... 483

Queen-bee experience..... 380
Queen business..... 403, 408
Queen-cells..... 276
Queen-cells for swarming and for superseding..... 566
Queen-clipping implement..... 130, 195, 215
Queen disappearing..... 598
Queen-excluders..... 215
Queen excluder vs. plain honey-boards..... 614
Queen fertilization in confinement..... 773
Queenless colony..... 582
Queen-rearing..... 229, 259, 375, 390, 455, 530, 566, 596, 637, 650, 667, 743, 773..... 805
Queen's arrival..... 713
Queens carrying foul brood..... 54
Queen that left hive in winter out-doors..... 54
Queen traps..... 50, 353
Queen—unusual actions..... 150
Quite a spell (poem)..... 491, 524
Quoting honey too high..... 121

Rats..... 202, 255, 268
Rattlesnake root..... 668
Reading..... 793
Reared colonies or up to brood comb..... 39
Removing honey..... 678
Rendering beeswax..... 517
Requisites for success in bee-keeping..... 356
Re-olutions of endorsement..... 840
Rietche foundation press..... 518
Rival bee-keepers and their policy..... 72
Robber bees robbing..... 105, 233, 330, 4, 342, 518
Rye flour for feeding..... 246, 791

Sacaline..... 407
Saving bees from brimstoning..... 506
Sawdust and shavings in honey..... 712
Sawdust packing in the spring..... 135
Sealed covers or upward ventilation..... 361
Secor's (Eugene) response to addresser of week..... 707
Section comb foundation..... 132, 151
Section folding and foundation fastening to one machine..... 410
Sections..... 270, 294, 820
Sectioning..... 85, 778
Self-living arrangements..... 50
Separators..... \$4, 135, 167, 199, 234, 270, 355, 714, 720, 746, 778..... 820
Several eggs in a cell..... 54
Shade for hives..... 122, 775
Shade for present swarming..... 786
Shed places for bees..... 644
Shipping-cases..... 648
Shipping comb honey..... 165
Shipping foundation in winter..... 598
Shipping honey..... 118, 135, 209, 578, 696
Short of stores..... 105
Showing bees and honey at fairs..... 599
Silver alate trees..... 610
Single or double brood-chamber for 12 frames..... 143
Smartweed..... 149
Smoker fuel..... 38, 293, 390
Smoking fact..... 237
Sow thistle..... 523
Spacing frames..... 335, 419, 510, 561, 713
Specialty vs. mixed bee-keeping..... 1, 438
Sporting bees..... 34, 293
Sports of character in bees..... 274
Spraying fruit blossoms..... 214, 389, 402
Spring dwindling..... 198
Spring work in the apiary..... 210, 229, 289
Square or oblong sections of honey..... 813
Starters in wired frames..... 247
Starters vs. full sheets in sections..... 439
Starting in bee-keeping..... 53, 199, 259, 283, 644, 709, 806
Starved colony..... 233
Starting with plain foundation..... 364
State appropriations for bee-keeping..... 364
Stimulative feeding in spring..... 778
Stingless queens..... 650
Stores for winter..... 150
Straight combs from starters in wired frames..... 745
Straight worker-comb without foundation..... 307
Straw queen..... 73
Stray straws from Gleanings..... 6, 170, 442, 505, 658
Strong colonies..... 170
Sugar candy for feeding..... 106
Sugar vs. honey..... 600
Superseding queens..... 39, 571, 630, 637, 775
Supers for sections..... 219, 273
Supers on all winter..... 629
Supply-dealer and honey-producer..... 692
Surplus arrangements—the best..... 111

Surplus honey room above brood-chamber..... 709
Sutherland's (Henry) apiary..... 56
Swan's (A. W.) apiary..... 137
Swapping supers vs. bare sections..... 793
Swarming..... 23, 30, 103, 106, 117, 145, 182, 189, 210, 225, 228, 294, 246, 249, 277, 306, 309, 369, 375, 432, 440, 466, 500, 519, 541, 551, 556, 588, 611, 614, 630, 651, 654, 662, 683, 694, 772..... 778
Swarming bees ahead..... 45
Swarming habit—breeding it out..... 29, 66, 110, 306
Swarming with a queen..... 82
Swarms leaving..... 471, 565
Swarms settling on an evergreen-tree..... 37
Sweet clover..... 3, 7, 17, 24, 46, 62, 65, 67, 70, 83, 84, 91, 108, 119, 124, 134, 141, 150, 151, 166, 173, 198, 199, 203, 207, 215, 227, 228, 242, 247, 259, 300, 323, 324, 351, 386, 419, 435, 459, 474, 484, 488, 492, 534, 688, 692, 644, 684, 685, 710, 746, 749, 754, 793, 803..... 835
Sweet clover honey..... 104
Syrup for feeding..... 183, 588

Taking off section honey..... 589
Tare on honey-packages..... 392
Tarsus..... 730
Temperature of bee-cells..... 198
Terrill Bros..... 648
Theory in apiculture..... 66
Thieves in the apiary..... 29, 124
Throw-out brood..... 185
Thumb-screws in place of wedges..... 614
Timor chest for packing..... 732
Tinker hive and management..... 252
Tobacco poison..... 764
Top-bars—non-burr-combs..... 89
Toronto apiarian exhibit..... 681
Tops..... 296, 324, 323, 343, 356, 613..... 822
T suits..... 130
Tucker's (J. B.) apiary..... 840
Two colonies in one hive..... 746
Two-frame nuclei..... 150
Two grubs in a queen-cell..... 391
Two queens in one hive..... 19, 67, 76, 150
Two starters in one section..... 680
Two swarms together..... 630

Unbusinesslike methods..... 696
Under-consumption not over-production of honey..... 338, 379
Unfinished sections..... 83, 116, 138, 199, 678, 729, 783, 806
United States bee-association..... 290
United States Bee-keepers' Union..... 840
Uniting colonies..... 174, 190, 239, 247, 621, 743, 746, 747, 775
Uniting to spot a good queen..... 71
Unpainted and painted hives..... 243
Unqueening and requeening..... 18, 75, 458, 616, 736
Unsealed stores for winter..... 790
Upward ventilation not needed..... 183, 196
Use of foundation..... 183, 196
Using foundation..... 55

Vaccination..... 253
Ventilation of hives in winter..... 169
Vicious bees..... 480, 565
Virgo queens..... 806
Virtues of honey..... 84
Visit among Utah bee-keepers..... 517
Visit to an out-apiary..... 52
Visit to Mr. Everett's apiary..... 545
Visit to Mrs. Stow's apiary..... 513

Water horsehood..... 618
Water hyacinth for bees..... 350
Watering bees..... 483, 673
Water soaking wax..... 106
Wax extractors..... 243, 364
Wax..... 71, 283
" Weed " process foundation..... 55, 183
Weight of bees and bee-loads..... 77
Weight of colonies for winter..... 822
Weight of natural swarms..... 487, 551, 634
What all the bees?..... 326, 477
What caused the queen's death?..... 157
What the bees worked on..... 431
Wheat and Clover..... 681, 697, 760, 824
Where bees tend most in store honey..... 431
Where did the queen come from?..... 791
Where did the eggs come from?..... 534, 598
White clover..... 714, 823
Whitening and dressing lumber shed..... 823
Why do I keep bees?..... 493
Wide frames and sections..... 694
Width of one-pound sections..... 133
Wild bees..... 359
Wild bees of Nebraska..... 678
Wild paraisols..... 688
Wind-blown or dry-wood..... 478, 618, 668
Windbreaks..... 201
Winter food and packing..... 90
Winter honey production..... 279
Wintering bees..... 3, 35, 63, 71, 84, 116, 130, 149, 165, 173, 191, 203, 252, 258, 275, 316, 331, 339, 341, 455, 534, 566, 594, 714..... 817
Wintering on Langstroth frames on end..... 453
Wintering queens..... 698
Winter stores..... 7, 574, 579, 745
Wiring frames..... 393
Wiring sections..... 194, 243
Women and conventions..... 148
Work at bee-conventions..... 148
Wood saw..... 523
Wood veneer or base foundation..... 167, 184
Working only in the morning..... 359
Work of bees..... 728, 769

Yellow jackets..... 827
Yielding honey..... 37
Young bees dying in the spring..... 247
Young queens breed late..... 71
Young's (J. W.) apiary..... 88

Please Send Us the Names of your neighbors who keep bees, and we will send them sample copies of the BEE JOURNAL. Then please call upon them and get them to subscribe with you, and secure some of the premiums we offer.

CORRESPONDENTS.

Abbott, Emerson T. 97, 216, 238, 273, 280, 298, 323, 386, 432, 533, 543, 565, 642, 693, 708, 728
Abbott, L. F. 69
Abbott, P. G. 412
Abram, W. 106
Adams, J. B. 588
Adams, Ira, 350
Adelbert, Frank X. 76
Aden, J. R. 749
Ablers, H. C. 493
Aikin, R. C. 18, 39, 57, 171, 198, 229, 250, 370, 435, 838
Alexander, Leslie, 221
Alford, N. C. 239
Allen, Chas. B. 29
Allen, G. H. 466
Allen, L. 257, 493
Alley, H. 446
Amateur, 781
Ames, Mrs. A. L. 803
Anderson, G. 669
Anderson, Rev. Wm. 35
Andes, M. D. 379
Andre, J. H. 29, 141
Archer, Dr. J. 526, 635
Armora, B. A. 315
Aschoa, C. G. 654
Ash, Thos. 632
Asplund, D. J. H. 170
Aspynwall, L. A. 183, 357
Atkinson, John, 773
Auringer, Geo. H. 141
Averill, B. F. 393
Axtell, Mrs. L. C. 44, 71, 238, 321, 594
Bachmann, Aug. 397, 588
Backensto, Wm. L. 222
Baird, A. B. 299
Baker, H. F. 110
Balch, C. 205
Balducci, George, Ph. J. 39
Baldridge, M. M. 17, 152, 277, 318, 323, 572
Baldwin, L. W. 44
Ball, A. T. 202
Banker, Miss Emma, 156
Barber, Mrs. A. J. 204
Barlow, Wm. S. 210, 293, 451, 596
Bargher, Jos. 236
Barrette, Mrs. Paul, 603
Baxter, Albert, 716
Beals, Geo. C. 141
Bearden, J. A. 46
Beatty, John W. 207
Bechtle, John N. 748
Beckwith, I. W. 307, 462, 695
Bee-Master, 83
Beers, C. C. 699
Beights, M. W. 780
Belding, Chester, 384, 670
Bell, Frank, 700
Bell, G. W. 685
Berkey, J. H. 735
Berkey, Mrs. Frank, 316
Bertrand, Edward, 27
Bessey, Prof. Chas. E. 726
Bettridge, J. T. 556
Bevins, Edwin, 102, 125, 178, 298, 309, 380, 387, 450, 546, 748, 820
Bingham, T. F. 358, 380
Birchett, J. G. 467
Bitenbender, J. W. 44, 55
Blackburn, Chas. 797
Blair, F. O. 181
Bland, Ellen C. 76, 462
Blunier, Peter, 283
Boerdman, H. R. 90, 201
Boedensatz, John, 301
Bohlmann, Henry, 477
Bolton, Jos. H. 600
Bouham, A. J. 77
Bradford, M. A. 77
Braley, H. C. 555
Brantigan, Sigel, 222, 374, 411
Bro. Bea, 156, 283
Brodbeck, Geo. W. 78, 195, 248, 696, 806
Brokaw, Harvey, 207
Brown, A. F. 802
Brown, Henry W. 412
Brown, J. Few, 748
Brown, Mary, 697
Brown, W. J. 108
Broyles, S. M. 78
Bruner, Lawrence, 677
Bryan, W. E. 393
Bryant, Luther, 781
Buchheim, Frank S. 477
Buey, W. W. 139, 732
Bunch, C. A. 63, 795
Burnett, R. A. 599
Burnett, W. E. 716
Burns, T. J. 11
Burrows, J. C. 169
Bussler, F. 423
Calvert, J. T. 489
Campbell, F. W. 269
Campbell, Robt. 826
Candler, Mathilda, 378
Card, Fred C. 238, 573
Carter, A. 365, 381
Carlsen, S. M. 78, 143, 181
Cash, L. G. 259
Champagne, Frank, 174
Chapman, W. B. 105
Chesley, Dana, 77
Chittenden, C. H. 796
Churcher, D. L. 349
Clark, L. J. 477
Clark, O. E. 76
Clark, O. H. 379

Gallup Dr. E. 146, 255, 398, 434, 483, 528, 539, 604, 644, 649, 658, 670, 709, 743, 764, 773, 789, 821
Gaady, J. L. 173, 492, 732
Garner & Harker, 812
Gemmill, F. A. 55, 678
Gerrish, C. W. 282
Getaz, Adrian, 59, 210, 255, 575, 626, 731
Gibson, J. R. 158
Gilmore, E. B. 126
Gilstrap, W. A. H. 536
Ginner, A. B. 492, 524
Givens, J. D. 203, 492, 555
Golden, J. A. 67, 110, 243, 356, 477, 481, 507, 636, 827, 833
Goodrich, Ed. 413
Goulding, E. 232
Graham, W. R. 207
Green, A. P. 635
Green, J. A. 802
Greener, T. R. 77
Greening, C. F. 490
Gresh, H. K. 108
Griffin, J. B. 282
Grimsley, J. O. 476
Grover, Irvin, 78, 421
Haight, J. H. 315
Haines, C. A. 30
Hains, J. B. 207
Hairston, J. T. 637
Hall, J. B. 179
Hall, R. Warren, 556
Hallenbeck, Mrs. A. L. 138, 365
Halsted, Ernest W. 269
Hart, E. P. 269
Hambaugh, J. M. 162
Hammond, D. D. 43
Hammond, L. A. 221, 414, 620
Hansen, E. 331
Harding, J. M. 525
Harper, W. 238
Harper, L. T. 477
Harris, C. W. 525
Harris, James U. 92
Harrison, Mrs. L. 44, 58, 110, 223, 305, 366, 412, 556, 693, 835
Hart, W. S. 569, 700
Hartog, Louis, 110
Hartman, Sanford, 600
Harvey, W. H. 593
Hasty, E. E. 71, 121, 122, 440, 637
Hawk, G. D. 653
Hayck, B. 424
Hayden, J. W. 236, 525
Heater, Mrs. J. N. 289, 722
Heddon, James, 44
Heim, Alvin, L. 330
Heise, D. W. 33, 282
Heiss, A. G. 637
Henry, P. E. 620, 660
Henry, J. W. 780
Henrich, Jos. 318
Herrick, J. V. B. 378, 796
Herrick, S. H. 646
Hightower, J. H. 795
Hill, H. E. 99, 239
Hillman, Dan H. 770
Hilton, Geo. E. 24, 200, 490, 531, 563, 658, 678
Hoagland, I. N. 255, 284
Hoffman, John, 108
Hogg, J. A. 379
Holder, E. L. 253
Holder, J. W. 39, 780
Holcman, D. A. 140
Holtermann, R. F. 360, 376
Horrie & Co. C. R. 584
Howard, C. B. 166
Howard, Dr. Wm. R. 477, 577
Howe, Harry S. 518
Howe, N. A. W. 316
Howell, R. 45
Hubbard, G. K. 155
Hubbard, J. L. 374
Huddleston, Mary F. 716
Huff, C. A. 124, 343
Huffman, E. B. 63, 184, 654, 717
Hunt, M. H. 341
Hurley, Geo. B. 263
Harley, T. S. 796
Hutchinson, W. Z. 211, 241, 247, 276, 285, 324, 341, 356, 578, 661, 760, 788
Hyde, Ira. 412
" Inventor," 834
Jacques, E. K. 840
Jardine, Jas. 91
Jeters, Willard G. 13
Jimson, 374
Johnson, D. D. 142
Johnson, R. P. 350
Jolley, Ed. 122, 262, 323, 366
Jones, E. R. 803
Jones, J. E. 172
Jones, L. 765
Jones, T. K. 780
Judd, J. B. 189
Kehler, Prof. Lyman F. 495
Kelly, John M. 747
Kennedy, B. 597
Keyes, Frank D. 701
Keyser, Leander S. 610
Kildow, A. L. 824
Kill, John, 524
Kirby, Levi, 109

Kistler, M. J. 378
Klein, P. J. 283
Kloer, T. H. 459
Kloth, H. 398
Knoll, J. C. 398, 555
Knuppel, Mrs. J. 13
Kouns, A. O. 218
Krueger, Aug. F. 507
Krum, Ellinger, 237
Lambrieger, Mrs. L. E. R. 644
LaMont, S. 78, 206
Lang, C. F. 540
Langdale, R. H. 748
Larch, D. C. 157
Learned, C. W. 394
Leebrick, J. P. 13
Leonard, L. D. 325
Leveling, H. E. 205
Levering, N. 168
Lewis, Jesse H. 92
Lichtfoot, Chas. 759
Little, F. M. 508, 573
Little, Wm. 435
Littow, G. D. 78, 204, 247
Livingston, Mrs. B. J. 337, 557, 604
Lohf, Theo. 196
Loverd, W. F. 53, 202, 228, 261, 314, 5, 9, 540
Lowrey, O. J. 388
Luther, S. K. 267, 380
Macey, R. L. 429
MacLean, Chancellor
Macy, E. 707
Mallory, C. H. 250
Mann, C. V. 740
Mann, English B. 282
Marks, W. F. 216, 290
Marsh, C. A. 158
Martin, J. H. 39, 129, 759, 422, 777
Mason, Dr. A. B. 377, 489, 612, 673, 689, 705, 721, 737, 753, 770, 833
May, C. H. 78, 508
McArthur, Jno., 174, 242
McBride, A. J. 603
McCartney, G. R. 748, 749
McClure, H. Rev. W. F. 27
McClung, Geo. 13, 828
McEvoy, Wm. 13, 91, 104, 212
McKenzie, R. 602
McKnight, R. 311
McKown, C. W. 109, 124
McLean, D. C. 239
McLeod, D. C. 716
Mead, C. E. 339
Mendelson, M. H. 731
Merriam, G. F. 827
Miles, E. S. 125, 364, 434, 763
Miller, Miss M. I. 269
Millard, Dr. G. A. 140, 254, 491
Miller, Dr. C. C. 3, 30, 39, 44, 55, 57, 66, 82, 90, 98, 120, 130, 195, 211, 247, 259, 281, 291, 333, 433, 591, 567, 581, 724
Miller, H. S. 428
Miller, L. D. 668
Miller, M. M. 63
Miller, O. P. 92, 174, 835
Miller, S. E. 71, 138
Millikan, L. V. 331
Mills, Chas. F. 11
Minton, Dr. H. 428
Moore, Hon. R. E. 707
Moore, Jacob, 206, 245, 395
Moore, Maud, 667
Morgan, E. A. 29, 477
Morrison, W. K. 311
Morse, W. H. 115
" Morton's Brother-in-law," 275
Mottaz, A. 94, 107, 268, 794
Mount, W. W. 408
Munson, E. 411
Murray, F. L. 308, 774
Nail, John L. 430
Nall, W. H. 540
Nash, J. A. 386
Nelson, G. E. 78, 461, 526, 701
Newman, Thos. G. 27, 61, 110, 178, 242, 334, 472
569, 691, 698, 742, 792, 824
Newton, H. F. 541, 588, 654
Nickel, Bruno, 381
Niemi, Dr. C. 220, 525
Norman, Chas. 153, 249
Northcut, W. G. 541
Norton, A. 108, 514
Novice, 146, 373, 441
Nussle, Dr. E. E. 621
Nutt, W. C. 158
O'Donnell, Timothy, 141
Onderdonk, B. F. 29, 419
Osborn, Merritt, 283
Osburn, S. F. 349
P & B. 636
Park, H. L. 92
Parsons, C. C. 87, 122, 172, 373, 526
Pearson, H. 283
Pearson, James, 385
Peck, B. W. 110
Pedersen, A. J. 429
Peto, Dr. H. 139, 153, 191, 237, 253
Pepon, Dr. R. S. 424
Perry, Geo. S. 731
Pettit, S. T. 27
Philps, N. T. 469
Phillip, H. D. 94
Poindexter, Geo. 413
Poland, F. M. 539
Pond, Willett, 158
Poppleton, O. O. 764
Porter, A. C. 747
Porter, Geo. H. 761
Porter, R. & E. C. 89
Porter, W. L. 213
Pratt, Thos. S. 781
Prichard, J. E. 191
Pridgen, W. H. 92, 462, 794
Pringle, Allen, 50, 203, 249
Pringle, Grace, 521
Przal, W. A. 588, 826
Puderbaugh, D. 587
Purvis, L. G. 299
Pusey, W. W. 6
Quick, R. E. 509
Quirin, H. G. 311, 429, 557
Rambler, G. 90, 147
Rasmussen, Frank, 446
Rauchfus, Frank, 53, 197
Reed, L. G. 765
Reeves, Vincent, 268
Renne, Wm. 526
Ressey, R. A. 515
Reynolds, Chauncey, 330
Rhoades, L. E. 12
Rhodes, J. Z. & Sons, 12, 364
Richardson, N. 298, 413
Richard, M. M. 12
Riley, Wm. E. 734
Risher, Howard, 285
Robbins, Geo. F. 225, 772
Roberts, Dr. C. S. 734
Robertson, S. M. 13, 110
Roby, Geo. 685
Rood, S. E. 206
Root, A. I. 296, 407, 690
Rout, E. R. 69, 102, 116, 132, 148, 201, 265, 488, 515, 740
Rouse, J. W. 27
Ruddip, P. 507
Rupp, John H. 268, 700
Russell, R. S. 238, 371
Sadler, J. W. 734
Sample, Jas. G. 540
Sanders, J. W. 222
Sanford, A. C. 316
Saul, W. A. 507
Savage, H. W. 813
Scharitz, Peter J. 227, 418, 710
Schrier, S. 124
Secor, Hon. Eugene, 120, 153, 306, 708, 776
Seeley, Wm. W. 171, 207
Seegold, Mrs. Rose, 405
Seiton, J. W. 790
Seton, John, 219
Sexton, J. L. 350
Seybert, J. E. 829
Sabin, Fannie, 236
Shaw, Jos. 686
Shannon, Mrs. Sallie E. 502, 516, 532, 547, 563
Shupe, Frank, 116
Simpton, Mrs. A. A. 12, 763
Siple, J. H. 239
Smith, H. B. 689
Snyklark, 170, 503, 601
Sloose, J. R. 148
Sleeth, J. S. 717
Slingerland, E. E. 106
Smethurst, Daniel, 63, 748
Smith, Alfred E. 732
Smith, A. H. 223
Smith, Catharine R. 525
Smith, Dr. Ezra, 269
Smith, Edw. 430
Smith, J. P. 301, 411
Smith, M. P. 253
Smith, N. H. 461
Smith, N. 572
Smith, O. M. 285
Smith, S. B. 174, 338, 772
Smith, Thaddeus, 27
Snell, F. A. 548, 595, 678, 758
Snow, M. S. 107, 202
Snowberger, A. H. 315, 811
Snyder, F. A. 94
Spitler, Geo. 92
Stackhouse, Wm. Y. 76
Stafford, S. M. 93
Stahmann, W. J. 612
Starker, Miss M. J. 12
Stark, Henry, 158
Steinbach, Peter, 403
Stell, Dr. W. M. 626
Stephens, G. 318
Stevens, A. H. 76
Stevenson, W. J. 238, 490
Stewart, John, 70
Stickney, L. A. 93
Stilson, L. D. 248, 676
Stokesberry, R. H. 76
Stolley, Wm. 207, 332, 755
Stone, Jss. A. 11, 22, 476, 653
Stordock, C. H. 684
Stout, W. H. 124
Stow, Mrs. N. L. 194
Sullivan, Ray, 829
Sutherland, Henry, 57
Swan, A. W. 137
Sylvester, L. 461
Syverud, L. A. 493, 716
Talmage, D. 729
Taylor, B. 20, 44, 99, 138, 161, 184, 208, 297, 327, 355, 440, 686
Taylor, Carl, 330
Taylor, Hon. R. L. 366, 132, 244, 260, 342, 436, 430, 500, 611, 679
Taylor, Howell, 615
Taylor, J. W. 204
Tedder, Louis, 700
Teter, Rev. J. G. 766
Theilmann, C. 203, 243
Thomas, E. B. 114
Thomas, Noah, 350
Thompson, Andrew M. 203
Thompson, F. L. 1, 2, 66, 181, 182, 197, 213, 229, 274, 300, 337, 397, 438, 482, 700
Thompson, W. A. 246
Thury, Jos. 195, 510
Thurlow, Thos. 46, 453
Tinslar, F. S. 165
Titus, Mrs. R. 620
Tomlinson, E. R. 395
Tompkins, Mrs. 555
Toombs, Jr., M. V. 316
Touche, R. 345
Tonraat, Geo. 239
Towle, Herbert C. 203
Tracy, D. L. 182
Truth-seeker, 794
Tubbs, G. F. 315, 684
Tucker, J. B. 8
Tuttle, Mrs. Sophia J. 764
Twining, Dana, 681
Tyrrell, E. B. 684
" Union," 790
Uphouse, John, 411
Urney, C. 620
Van Blaricum, Carson, 226, 253, 812
VandeVord, Geo. J. 257
Vinal, Geo. L. 237, 293, 595
Waalte, T. H. 764
Wallace, J. G. A. 91
Wallmeyer, C. J. 13, 124, 131, 427
Walton, W. S. 223
Warner, J. H. 429
Warner, Lawrence G. 761
Watson, A. D. 220
Webb, N. L. 826
Webb, Wm. 222, 263
Weed, E. B. 231, 243
Weed, Geo. H. 490
Weeks, G. W. 130
West, N. D. 429
Whedon & Co., Geo. T. 681, 825
Whitcomb, E. 232, 674
White, Dan, 391
White, Geo. K. 635
Whitebread, Paul, 45, 509, 812
Whiting, Dr. L. C. 358
Whitmore, John H. 686
Whittington, W. E. 299, 446
Wicherts, A. 446
Wiemann, Fred, 686
Wiggins, F. C. 206
Wilke, F. G. 381, 524
Williams, Geo. W. 19, 827
Williams, Jas. W. 204, 332
Williams, Mark G. 507
Williams, Mrs. M. L. 380
Williamson, J. C. 204
Williamson, Robt. 771
Willis, L. M. 35, 228, 477, 526
Wilson, H. P. 47, 811
Wilson, C. C. 76
Wilson, E. A. 222
Wilson, E. A. 142
Wilson, Emma, 138
Wilson, Geo. W. 108
Wing, Jas. H. 344
Wirth, Jacob, 205, 269, 446, 535
Woodley, Wm 55
Woods, Jas. W. 78
Wright, H. R. 574, 621
Wright, Jr., Wm. 150
Wynn, C. 46
Yandell, A. R. 430, 636
Yeagrin, John, 378
York, Geo. W. 513, 515, 721
Young, J. W. 88
Young, N. 392
Young, W. H. 137
Zigler, C. F. 454
Zinn, C. C. 526

ILLUSTRATIONS.

Abbott, Emerson T. 693
Ailske clover 65
Apiary of A. W. Swan 129
Apiary of Henry Sutherland 49

Aplary of J. B. Tucker.....	1
Aplary of J. D. Everett.....	545
Aplary of J. W. Young.....	81
Axtell, Mrs. L. C.....	321
Bee-Cellar—Doolittle's—Outside and Inside view.....	4, 5
Bee-escape—Jardine's.....	385
Bee-hunting outfit—Steinebach's.....	404
Bevins, Edwin.....	97
Briggs House, Chicago.....	785
Brown, Dr. J. P. H.....	23
Calvert, J. T.....	23
Candler, Miss Mathilda.....	193
Comb foundation experiments—Holtermann.....	361
Comb leveler—Taylor's "Handy".....	519
Cook, Prof. A. J.....	690
Crimson clover.....	63
Dadant, C. P.....	753
Darling, J. K.....	65
Double super for comb honey—Golden's.....	481
Entrance feeder—Boardman's.....	265
Everett, J. D.....	546
Foundation cutter—Rauchfuss Bros.....	337
France, N. E.....	756
Getaz, Adriano.....	33
Harrison, Mrs. L.....	305
Heater, Mrs. J. N.....	289, 722
Heddon hive.....	35
Hill, H. E.....	497
Hill, Lowell G.....	498
House-aplary—B. Taylor's.....	161
House-aplary—winter and summer views—Goulding's.....	225
Howard, Dr. Wm. R.....	711
Hutchinson, W. Z.....	644
Langstroth, Rev. L. L.....	26
MacLean, Chancellor Geo. E.....	673
Magic section-press—Cormac's.....	207
Mahin, Rev. M.....	801
Marvin, J. M.....	273
Mason, Dr. A. B.....	642
McCartney's foundation fastener and section press.....	646
McEvoy, Wm.....	643
Miller, Dr. C. C.....	721
Newman, Thos. G.....	689
North American Convention group at Lincoln, Nebr.....	769
Phelps basket-splint comb-honey package.....	469
Pickled brood or white fungus.....	577
Porter honey-house bee-escape.....	89
Pridgen, W. H.....	593
Pringle, Allen.....	529
Root, A. I.....	23, 641
Root, Ernest R.....	737
Secor, Hon. Eugene.....	705
Self-bling arrangements—Getaz.....	51
Sherman, Mrs. Sallie E.....	417
Stilson, L. D.....	675
Stolley, Wm.....	754
Stow, Mrs. N. L.....	513
Sweet clover.....	17, 219
Taylor, B.....	161, 561
Thompson, F. L.....	9
Wax extractor—Ferris.....	517
Whitcomb, Hon. E.....	674

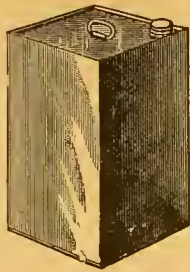

Finest Alfalfa Honey!

IT SELLS ON TASTING.
The Honey that Suits All Who Buy It.

We can furnish **White Alfalfa** Extracted Honey, in 60-pound tin cans, on board cars in Chicago, at these prices: 1 can, in a case, 8 cents per pound; 2 cans in one case, 7½ cents; 4 cans (2 cases) or more, 7 cents. The Cash must accompany each order. **Fine Basswood** Honey at ¼ cent more per pound.

A sample of the honey will be mailed to an intending purchaser, for 8 cents, to cover postage, packing, etc. We guarantee purity, and what we ship will be equal to sample.

Now it seems to us here is a splendid chance for any bee-keeper to supply his home demand after his own crop is all sold. Or, why not begin now to create a local honey-trade? Order one 60-pound can first, and start out among your neighbors and friends, and see what you can do. You ought to get at least 15 cents per pound in 5-pound lots, or 50 cents for 3 pounds. Some may be able to do even better than that, though we think that enough ought to be sold at these prices to make a fairly paying business out of it. Give it a good trial. Push it. It may grow into a nice winter's work for you.

GEORGE W. YORK & CO., 118 Michigan Street, CHICAGO, ILL.

✦ MONEY SAVED IS MONEY GAINED. ✦

THE ROYAL UNION Life Insurance Company

DES MOINES, IOWA.

The Iowa Policy

Is one that definitely promises to keep an accurate account with you; credit your premiums and interest, charge the actual expense and mortality cost, and hold the remaining funds subject to your order.

Agents Wanted.

JOHN B. KING, GENERAL AGENT,
Suite 513 First Nat'l Bank Bld'g,
20 Atf CHICAGO, ILL.
Mention the American Bee Journal.

DUQUESNE COLLEGE!

PENN AVE. AND EIGHTH ST.

PITTSBURG, PA.

Thorough Courses—Classical, Scientific, Normal, English, Commercial, Preparatory, and Ladies Literary. Efficient and experienced instructors. Day and Night sessions.

Send for Catalog.

Write for it, the American Bee Journal.

THROAT AND LUNG DISEASES.

DR. PEIRO, Specialist
Offices: 1019, 100 State St.,
CHICAGO. Hours 9 to 4.



SEE THAT WINK!

Bee - Supplies! ROOT'S Goods at Root's Prices.

Powder's Honey - Jars, and every thing used by bee-keepers. Prompt service, low freight rate. Catalog free. W. S. POWDER, 162 Mass. Ave., INDIANAPOLIS, INDIANA.

WHEN ANSWERING THIS ADVERTISEMENT, MENTION THIS JOURNAL.

—WRITE—

Without Fail—enclosing a list of Supplies wanted, and get our prices on them, before placing your order.

5 to 10 per ct. Discount till Jan. 1st.

I. J. STRINGHAM,

105 Park Place. NEW YORK, N. Y.

APIARY—Glen Cove, L. I.

Mention the American Bee Journal.



ONE MAN WITH THE UNION COMBINATION SAW

Can do the work of four men using hand tools, in Rippling, Cutting-off, Mitering, Rabbeting, Grooving, Gaining, Dadoing, Edging-up, Jointing Stuff, etc. Full Line of Foot and Hand Power Machinery Sold on Trial. Catalogue Free.

SENECA FALLS MFG. CO.,
46 Water St. SENECA FALLS, N. Y.
141y Mention the American Bee Journal.

The "Premium" : A Good Watch Mailed Free!

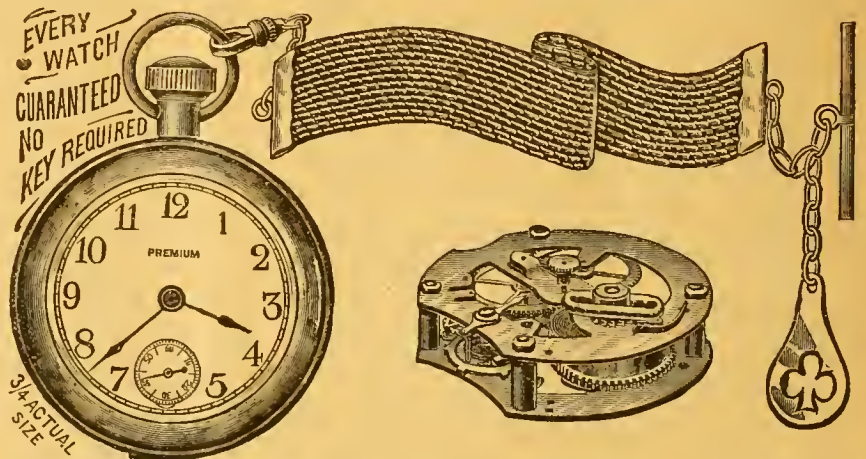

The movement of this Watch is regular American lever, lantern pinion, quick train, 240 beats per minute, three-quarter plate, short wind; runs 30 hours to one winding; dust cap over movement; every movement fully timed; regulated and guaranteed for one year, the same as a Waltham or Elgin; nickel finish, heavy bevel crystal, and back pinion wind and set.

OUR OFFERS:—We will mail the above Watch for \$1.25; or club it with the Bee Journal for a year—both together for \$2.10; or we will send it free as a premium for getting **Three New yearly Subscribers** to the Bee Journal at \$1.00 each. The Watch is mailed from New York City, so please allow a few days before expecting your order to be filled.

GEORGE W. YORK & CO., 118 Michigan St., Chicago, Ill.

The Place to Live 'Mid Sun and Flowers

Possibly you have stood the Intense Cold, the blizzards and the Killing Heat of the East and the West until you are sick of them—perhaps your health has been about ruined by such climate. Don't you think it is about time to seek a place where you can enjoy life? Of course you do. California is the place for a man to live who wishes to be good to himself and his family—there's a genial sun—flowers and fruits every day in the year—Pure air—Pure water—every thing that's good. Now is the time to possess such a home—they are cheaper now than they ever will be again. Don't wait—write to us telling what kind of a place you want—in city or country—what part of the State—how much you expect to pay, etc., and we will give you the desired information.

PRYAL REALTY CO.

966 BROADWAY,
OAKLAND, CALIF.
Please mention this Journal.

CARLOADS

Of Bee-Hives, Sections, Shipping-Cases, Comb Foundation, and Everything used in the Bee-Industry.
I want the name and address of every Bee-Keeper in America. I supply Dealers as well as consumers. Send for catalogs, quotations, etc.
W. H. PUTNAM,
RIVER FALLS, Pierce Co., WIS.
Mention the American Bee Journal.

 **NEW MAMMOTH**
Poultry Guide for 1897. Something entirely new; almost 100 pages; contains lithograph plates of Fowls in natural colors; plans for poultry houses, remedies and recipes for all diseases how to make Poultry and Gardening pay; only 15 cents.
John Bauscher, Jr., Box 94 Freeport, Ill.
49A13t *Mention the American Bee Journal.*

California

If you care to know of its Fruits, Flowers Climate or Resources, send for a Sample Copy of California's Favorite Paper—

The Pacific Rural Press

The leading Horticultural and Agricultural paper of the Pacific Coast. Published weekly, handsomely illustrated, \$2.00 per annum. Sample Copy Free.

PACIFIC RURAL PRESS,
220 Market St., - SAN FRANCISCO, CAL.

WANT TO SUCCEED?

Then use the NEW STYLE SUCCESSFUL INCUBATORS. They succeed where others fail. This due to their new system of ventilation; new method of generating moisture; and the positive action of the new self regulator. Sold under positive guaranty. All about these and other things for poultrymen in our new catalogue and Book on Poultry. Sent for 6cts. in stamps. Address,
DES MOINES INC. CO., Box 78, DES MOINES, IA.
49D6t, *Mention the American Bee Journal.*

YOUR BEESWAX!

UNTIL FURTHER NOTICE, we will allow 27 cents per pound for Good Yellow Beeswax, delivered at our office—in exchange for Subscription to the BEE JOURNAL, for Books, or anything that we offer for sale in the BEE JOURNAL. Or, 24 cts. cash.

GEORGE W. YORK & CO.,
CHICAGO, ILLS

THE "NOVELTY" POCKET-KNIFE!

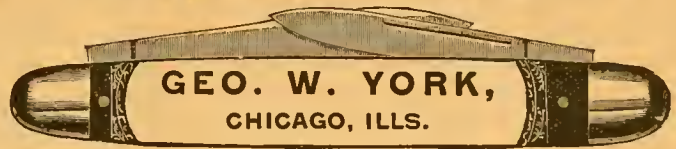

Your Name on the Knife.—When ordering, be sure to say just what Name and Address you wish put on the Knife.

The NOVELTY KNIFE is indeed a novelty. The novelty lies in the handle. It is made beautifully of indestructible celluloid, which is as transparent as glass. Underneath the celluloid, on one side of the handle is placed an AMERICAN BEE JOURNAL reminder, and on the other side, name and residence of the Subscriber.

The material entering into this celebrated knife is of the very best quality; the blades are handforged out of the very finest English razor-steel, and we warrant every blade. The bolsters are made of German silver, and will never rust or corrode. The rivets are hardened German silver wire; the linings are plate brass; the back springs of Sheffield spring steel, and the finish of handle as described above. It will last a lifetime, with proper usage.

Why purchase the Novelty Knife? In case a good knife is lost, the chances are, the owner will never recover it; but if the Novelty is lost, having name and address of owner, the finder will return it; otherwise to try to destroy the name and address, would destroy the knife. If traveling, and you meet with a serious accident, and are so fortunate as to have one of the Novelties, your pocket KNIFE will serve as an identifier; and in case of death, your relatives will at once be apprised of the accident.

How appropriate this knife is for a Christmas, New Year or birthday present! What more lasting memento could a mother give to a son, a wife to a husband, a sister to a brother, a lady to a gentleman, or vice versa, a son to a mother, a husband to a wife, a brother to a sister or a gentleman to a lady—the knife having the name of the recipient on one side?

The accompanying cut gives a faint idea, but cannot fully convey an exact representation of this beautiful knife, as the "Novelty" must be seen to be appreciated.

How to Get this Valuable Knife.—We send it postpaid, for \$1.00, or give it as a Premium to the one sending us three new Subscribers to the BEE JOURNAL (with \$3.00), and we will also send to each new name a copy of the Premium Edition of the book "Bees and Honey." We club the Novelty Knife with the BEE JOURNAL for one year, both for \$1.90.

Any Name and Address Put on the Knife. **GEORGE W. YORK & CO.,**
CHICAGO, ILLS.

Allow about two weeks for your order to be filled.

OUR NEW CATALOGUE

WILL BE ISSUED SOON.

Send us your Name and Address,

And we will take pleasure in mailing you a copy

FREE!

IT ILLUSTRATES AND DESCRIBES ALL THE

Latest and Best Apiarian Supplies

G. B. LEWIS CO., WATERTOWN, WIS.

THROAT AND LUNG DISEASES,

DR. PEIRO, Specialist
Offices: 1019, 100 State St.,
CHICAGO. Hours 9 to 4.

Mention the American Bee Journal.

READERS

Of this Journal who write to any of our advertisers, either in ordering, or asking about the Goods offered, will please state that they saw the Advertisement in this paper.

PROF. A. J. COOK'S BOOK FREE!

The Bee-Keeper's Guide

OR

MANUAL OF THE APIARY.

This 15th and latest edition of Prof. Cook's magnificent book of 460 pages, in neat and substantial cloth binding, we propose to give away to our present subscribers, for the work of getting new subscribers for the American Bee Journal.

Given For 2 New Subscribers.

The following offer is made to PRESENT subscribers only, and no premium is also given to the two new subscribers—simply the Bee Journal for one year:

A description of the book here is quite unnecessary—it is simply the most complete scientific and practical bee-book published today. Fully illustrated, and all written in the most fascinating style. The author is also too well-known to the whole bee-world to require any introduction. No bee-keeper is fully equipped, or his library complete, without "THE BEE-KEEPER'S GUIDE."

Send us Two New Subscribers to the Bee Journal (with \$2.00), and we will mail you a copy of Prof. Cook's book FREE as a premium. Prof. Cook's book alone sent for \$1.25, or we club it with the Bee Journal for a year—both together for only \$1.75. But surely anybody can get only 2 new subscribers to the Bee Journal for a year, and thus get the book as a premium. Let everybody try for it. Will you have one?

GEORGE W. YORK & CO., 118 Michigan St., CHICAGO, ILL.

COMB FOUNDATION

Wax always wanted for Cash or in Exchange for Fdn. or other Supplies. My trade is established on **Low Prices** and the merit of my **Foundation**. **Orders filled promptly.**

WORKING WAX INTO FDN. BY THE LB. A SPECIALTY. Wholesale prices to **dealers and large consumers.** Send for Prices and Samples to—**GUS DITTMER, AUGUSTA, WIS.**

Reference—Augusta Bank. 1ATI
Mention the American Bee Journal.

HATCH Chickens BY STEAM—
With the **MODEL EXCELSIOR Incubator**
Simple, Perfect, Self-Regulating. Thousands in successful operation. Lowest priced first-class Hatcher made.
GEO. H. STARR, 114 to 122 S. 6th St. Quincy, Ill.



44A26t Mention the American Bee Journal

Yell. O Yell. O'YELLOWZONES YELLOWZONES
for **PAIN and FEVER.**

40,000.
THE Nebraska Farmer
Has made a contract with the Nebraska Club, to print for them **40,000** copies over and above the regular weekly issue, each month for six months, of reliable information about Nebraska.
If interested, send for free copy, to
MR. CHAS. E. WILLIAMSON, Secretary Nebraska Club, OMAHA, NEBR., or Nebraska Farmer Co., Lincoln, Nebr.

44A13 Mention the American Bee Journal.

Our Prices ARE WORTH LOOKING AT!

— IN THE —
NEW CHAMPION CHAFF HIVE
especially. All other Supplies accordingly. Send for Catalog and Price-List. Address,

R. H. SCHMIDT & CO.,
48Atf Box 187, SHEBOYGAN, WIS.
Mention the American Bee Journal.

PAID FOR
Cash Beeswax

For all the **Good, Pure Yellow Beeswax** delivered to our office till further notice, we will pay **25 cents** per pound, **CASH**; or **28 cents** for whatever part is exchanged for the **Bee Journal**, **Honey**, **Books** or **Seed**, that we offer. If you want **cash, promptly**, for your **Beeswax**, send it on at once. Impure wax not taken at any price. Address as follows, very plainly,

GEO. W. YORK & CO.
118 Michigan st., CHICAGO, ILL.

IF YOU WANT THE BEE-BOOK

That covers the whole Apicultural Field more completely than any other published, send \$1.25 to Prof. A. J. Cook, Claremont, Calif., for his

Bee-Keeper's Guide.

Liberal Discounts to the Trade.

BEE-BOOKS

SENT POSTPAID BY

George W. York & Co.,
Chicago, Illa.

Bees and Honey, or Management of an Apiary for Pleasure and Profit, by Thomas G. Newman.—This edition has been largely re-written, thoroughly revised, and is "fully up with the times" in all the improvements and inventions in this rapidly-developing pursuit, and presents the apiarist with everything that can aid in the successful management of an apiary, and at the same time produce the most honey in an attractive condition. It contains 250 pages, and 245 illustrations—is beautifully printed in the highest style of the art, and bound in cloth, gold-lettered. Price, \$1.00.

Langstroth on the Honey-Bee, revised by Dadant—This classic in bee-culture, has been entirely re-written, and is fully illustrated. It treats of everything relating to bees and bee-keeping. No apiarist's library is complete without this standard work by Rev. L. L. Langstroth—the Father of American Bee-Culture. It has 520 pages; bound in cloth.

Price, postpaid, \$1.25.

Bee-Keepers' Guide, or Manual of the Apiary, by Prof. A. J. Cook, of the Michigan Agricultural College.—This book is not only instructive and helpful as a guide in bee-keeping, but is interesting and thoroughly practical and scientific. It contains a full delineation of the anatomy and physiology of bees. 400 pages; bound in cloth and fully illustrated.

Price, postpaid, \$1.25.

Scientific Queen-Rearing, as Practically Applied, by G. M. Doolittle.—A method by which the very best of Queen-Bees are reared in perfect accord with Nature's way. 175 pages, bound in cloth, and illustrated. Price, \$1.00.

A B C of Bee-Culture, by A. I. Root.—A cyclopedic of 400 pages, describing everything pertaining to the care of the honey-bees. It contains 300 engravings. It was written especially for beginners. Bound in cloth. Price, \$1.25.

Advanced Bee-Culture, Its Methods and Management, by W. Z. Hutchinson.—The author of this work is too well known to need further description of his book. He is a practical and entertaining writer. You should read his book. 90 pages, bound in paper, and illustrated. Price, 50 cts.

Rational Bee-Keeping, by Dr. John Dzierzon.—This is a translation of his latest German book on bee-culture. It has 350 pages; bound in cloth, \$1.25; in paper covers, \$1.00.

Bienen-Kultur, by Thomas G. Newman.—This is a German translation of the principal portion of the book called **BEES OF HONEY**. 10 page pamphlet. Price, 40 cents.

Convention Hand-Book, for Bee-Keepers, by Thomas G. Newman.—It contains the parliamentary law and rules of order for Bee-Conventions—also Constitution and By-Laws, with subjects for discussion, etc. Cloth, gold-lettered. Price, 25 cts.

Thirty Years among the Bees, by Henry Alley.—Gives the results of over a quarter-century's experience in rearing queen-bees. Very latest work of the kind. Nearly 100 pages. Price, 50c.

Why Eat Honey?—This Leaflet is intended for FREE distribution, to create a Local Market. 100 copies, by mail, 30 cts.; 500 for \$1.25; 1000, \$2.00.

How to Keep Honey and preserve its richness and flavor. Price same as Why Eat Honey.

Alsike Clover Leaflet.—Full directions for growing. 50 for 25 cts.; 100 for 40 cts.; 200, 70c.

Apiary Register, by Thos. G. Newman.—Devotes two pages to a colony. Leather binding. Price, for 50 colonies, \$1.00; for 100 colonies, \$1.25.

Preparation of Honey for the Market, including the production and care of comb and extracted honey. A chapter from **BEES AND HONEY**. Price, 10 cents.

Bee-Pasturage a Necessity.—This book suggests what and how to plan. It is a chapter from **BEES AND HONEY**. Price, 10 cents.

The Hive I Use, by G. M. Doolittle. It details his management of bees, and methods of producing comb honey. Price, 5 cents.

Dr. Howard's Treatment on Foul Brood.—Includes the McEvoy Treatment and reviews the experiments of others. Price, 25 cts.

Dictionary of Apiculture, by Prof. John Phil. Gives the correct meaning of nearly 500 apicultural terms. Price, 50 cts.

Winter Problem in Bee-Keeping, by G. R. Pierce. Result of 25 years' experience. 50 cts.

Handling Bees, by Chas. Dadant & Son.—A Chapter from Langstroth Revised. Price, 8 cts.

Foul Brood Treatment, by Prof. F. R. Cbeahire.—Its Cause and Prevention. Price, 10 cts.

Foul Brood, by A. R. Kohnke.—Origin, Development and Cure. Price, 25 cts.

History of Bee-Associations, and Brief Reports of the first 20 conventions. Price, 15 cts.

Honey as Food and Medicine, by T. G. Newman.—A 32-page pamphlet: just the thing to create a demand for honey at home. Should be scattered freely. Contains recipes for Honey-Cakes, Cookies, Puddings, Foam, Wines, and use of honey for medicine.

Prices, prepaid—Single copy, 5 cts.; 10 copies, 35 cts.; 50 for \$1.50; 100 for \$2.50; 250 for \$5.50; 500 for \$10.00; or 1000 for \$15.00.

When 250 or more are ordered, we will print the bee-keeper's card (free of cost) on the front cover page.

Bee-Keeping for Profit, by Dr. G. L. Tinker.—Revised and enlarged. It details the author's "new system, or how to get the largest yields of comb or extracted honey." 80 p.; illustrated, 25c.

Emerson Binders, made especially for the **BEE JOURNAL**, are convenient for preserving each number as fast as received. Not mailable to Canada. Price, 75 cts.

Commercial Calculator, by C. Ropp.—A ready Calculator, Business Arithmetic and Account-Book combined in one. Every farmer and business man should have it. No. 1, bound in water proof leather, calf finish. Price, 40 cts. No. 2, in fine artificial leather, with pocket, alicate alate, and account-book. Price, 60 cts.

Green's Four Books, by Chas. A. Green.—Devoted to, 1st, How We Made the Old Farm Pay; 2nd, Peach Culture; 3rd, How to Propagate Fruit-Plants, Vines and Trees; 4th, General Fruit In-structor. Nearly 120 pages. Fully illustrated. 25 cts.

Garden and Orchard, by Chas. A. Green.—Gives full instructions in thinning and Marketing Fruits; Pruning, Planting and Cultivating; Spraying, Evaporation, Cold Storage, Etc. 94 pages, illustrated. Price, 25 cts.

Kendall's Horse-Book.—35 pictures, showing positions of sick horses, and treats on all their diseases. English or German. Price, 25 cts.

Silo and Silage, by Prof. A. J. Cook.—It gives the method in operation at the Michigan Agricultural College. Price, 25 cts.

Lumber and Log-Book.—Gives measurements of lumber, logs, planks; wages, etc. 25c.

Maple Sugar and the Sugar Bush, by Prof. A. J. Cook.—Full instructions. Price, 35 cts.

Grain Tables, for casting up the price of grain, produce, hay, etc. Price, 25 cts.

Capons and Caponizing, by Dr. Sawyer, Fanny Field, and others.—Illustrated. All about caponizing fowls, and thus how to make the most money in poultry-raising. 64 pages. Price, 30 cts.

Our Poultry Doctor, or Health in the Poultry Yard and How to Cure Sick Fowls, by Fanny Field.—Everything about Poultry Diseases and their Cure. 64 pages. Price, 30 cts.

Poultry for Market and Poultry for Profit, by Fanny Field.—Tells everything about the Poultry Business. 64 pages. Price, 25 cts.

Turkeys for Market and Turkeys for Profit, by Fanny Field.—All about Turkey-Raising. 64 pages. Price, 25 cts.

Rural Life.—Bees, Poultry, Fruits, Vegetables, and Household Matters. 100 pages. 25 cts.

Potato Culture, by T. B. Terry.—It tells how to grow them profitably. Price, 40 cts.

Hand-Book of Health, by Dr. Foote.—Hints about eating, drinking, etc. Price, 25 cts.

Bee-Keepers' Directory, by H. Alley.—Latest methods in Queen-Rearing, etc. Price, 50c.

Book Clubbing Offers.

(Read Carefully.)

The following clubbing prices include the American Bee Journal one year with each book named. Remember, that only ONE book can be taken in each case with the Bee Journal a year at the prices named. If more books are wanted, see postpaid prices given with the description of the books on this page. Following is the clubbing-list:

1. Langstroth on the Honey-Bee.....\$2.00
2. A B C of Bee-Culture..... 2.00

3. Bee-Keeper's Guide.....	1.75
4. Bees and Honey [Cloth bound].....	1.65
5. Doolittle's Scientific Queen-Rearing.....	1.75
6. Dr. Howard's Foul Brood Book.....	1.10
7. Advanced Bee-Culture.....	1.30
8. Bielen-Kultur [German].....	1.25
9. Rational Bee-Keeping [Cloth bound].....	2.00
10. Rational Bee-Keeping [Paper bound].....	1.75
11. Thirty Years Among the Bees.....	1.30
12. Bee-Keeping for Profit.....	1.15
13. Couvention Hand-Book.....	1.15
14. Poultry for Market and Profit.....	1.10
15. Turkeys for Market and Profit.....	1.10
16. Capons and Caponizing.....	1.10
17. Our Poultry Doctor.....	1.10
18. Green's Four Books.....	1.15
19. Garden and Orchard.....	1.15
20. Rural Life.....	1.10
21. Emerson Binder for the Bee Journal.....	1.60
22. Commercial Calculator, No. 1.....	1.25
23. Kendall's Horse-Book.....	1.40
24. Potato Culture.....	1.10
25. Hoard-Book of Health.....	1.10
26. Dictionary of Apiculture.....	1.35
27. Maple Sugar and the Sugar Bush.....	1.20
28. Silo and Silage.....	1.10
29. Winter Problem in Bee-Keeping.....	1.30
30. Apilary Register (for 50 colonies).....	1.75
31. Apilary Register (for 100 colonies).....	2.00
32. Bee-Keeper's Directory.....	1.30

HONEY and BEESWAX

MARKET QUOTATIONS.

The following rules for grading honey were adopted by the North American Bee-Keepers' Association, and, so far as possible, quotations are made according to these rules:

FANCY.—All sections to be well filled; combs straight, of even thickness, and firmly attached to all four sides; both wood and comb unsoiled by travel-stain, or otherwise; all the cells sealed except the row of cells next the wood.

No. 1.—All sections well filled, but combs uneven or crooked, detached at the bottom, or with but few cells unsealed; both wood and comb unsoiled by travel-stain or otherwise.

In addition to this the honey is to be classified according to color, using the terms white, amber and dark. That is, there will be "fancy white," "No. 1 dark," etc.

Chicago, Ill., Dec. 18.—Fancy white, 12@3c.; No. 1, 11@12c.; fancy amber, 10c.; No. 1, 7@9c.; fancy dark, 8c.; No. 1, 7@8c. Extracted, white, 5@7c.; amber, 5@6c.; dark, 4@5c. Beeswax, 26@27c.

There has been a little more trade in honey this month, but the sales are below average for this season of the year.

Philadelphia, Pa., Dec. 12.—Fancy white comb, 13-14c.; No. 1 white, 11-12c.; fancy amber, 10-11c.; dark, 8-9c. Extracted, white, 6-8c.; amber, 4-5c.; dark, 3-4c. Beeswax, 26c.

Comb honey arriving freely and market overstocked at present.

Albany, N. Y., Dec. 12.—Fancy white, 12-13c.; No. 1, 11-12c.; fancy amber, 9-10c.; No. 1 dark, 8-9c. Extracted, white, 6-7c.; dark, 4-5c.

The receipts of both comb and extracted honey are very large, and prices are somewhat lower. We have an ample stock of all styles except paper cartons weighing less than a pound.

Indianapolis, Ind., Dec. 7.—Fancy white, 14-15c.; No. 1 white, 12-13c. Extracted, white, 6-7c. Beeswax, 22-25c.

Demand is fair for grades quoted, but no demand for inferior grades.

Kansas City, Mo., Dec. 12.—Fancy white comb, 15c.; No. 1 white, 13@14c.; fancy amber, 12-13c.; No. 1 amber, 11-12c.; fancy dark, 10-11c.; No. 1, 8-10c. Extracted, white, 6-6½c.; amber, 5 ½c.; dark, 4-4½c. Beeswax, 22-25c.

Boston, Mass., Dec. 12.—Fancy white, 13-14c.; No. 1, 11-12c. Extracted, white, 6-7c.; amber, 5-6c. Beeswax, 25c.

Milwaukee, Wis., Dec. 12.—Fancy white, 14-15c.; No. 1, 12-13c.; No. 1 amber, 8-10c. Extracted, white, 6-7c.; amber, 5-6c.; dark, 4-5c. Beeswax, 22-24c.

New crop of honey begins to come forward. The demand is very poor and quotations almost nominal. Weather is very warm and the consumption of honey is very small. Plenty of fruit, and hence the appetite is satisfied with same in preference. Later on we expect an improved demand for honey of all kinds.

Cleveland, Ohio, Dec. 12.—Fancy white, 14½@15c.; No. 1 white, 12½@13c. Extracted, white, 6@7c.; amber, 4½@5½c. Beeswax, 22@25c.

There is not very much honey in our market. Selling rather slow. Demand beginning to be a little better. Think trade will be fair in this line this fall.

New York, N. Y., Dec. 22.—Fancy white, 11@12c.; fair white, 9@10c.; buckwheat, 7@8c. Extracted, white clover and basswood, 5@5½c.; California, 6c.; Southern, 50c. per gallon. Beeswax in fair demand at 26@27c. The market is quiet and inactive. Demand light and plenty of stock on the market.

Cincinnati, Ohio, Dec. 22.—Comb honey, best white, 10@14c. Extracted, 4@6c. Demand is slow; supply is fair.

Beeswax is in fair demand at 22@25c. for good to choice yellow.

Buffalo, N. Y., Dec. 26.—Fancy and No. 1 white comb, sells well at 10 and 11c., but seldom 12c.; other grades, 8-6c., and require much urging. Extracted 4-5c.

St. Louis, Mo., Dec. 9.—Fancy white, 14c.; No. 1 white, 12@13c.; fancy amber, 11@12c.; No. 1 amber, 10@10½c.; fancy dark, 9@9½c.; No. 1 dark, 7@8c. Extracted, white, in cans, 6@7c.; in barrels, 5@5½c.; amber, 4½@4¾c.; dark, 3½@4c. Beeswax, 26½@27c.

Baker stock of extracted honey, 4@5c.; stock very scarce. Fair receipts of comb. Beeswax in good demand.

Detroit, Mich., Dec. 12.—No. 1 white, 12-12½c.; fancy amber, 10-11c.; No. 1 amber, 9-10c.; fancy dark, 8-9c. Extracted, white, 5½-6c.; amber, 5-5½c.; dark, 4-5c. Beeswax, 24-25c.

Minneapolis, Minn., Dec. 19.—Fancy white, 11@12c.; No. 1 white, 10@11c.; fancy amber, 9@10c.; No. 1 amber, 8@9c.; fancy dark, 7@8c.; No. 1 dark, 6-7c. Extracted, white, 6@7c.; amber, 5@5½c.; dark, 4@5c. Utah white extracted, 5@5½c. Beeswax, 23@26c. Market fairly steady for comb and better for extracted than for some time.

San Francisco, Calif., Dec. 9.—White comb, 10-11c.; amber, 7½-9c. Extracted, white, 5½-6c.; light amber, 4½-4¾c.; amber colored and candied, 3½-4¾c.; dark tulle, 2¾-3c.

Beeswax, fair to choice, 24-27c.

List of Honey and Beeswax Dealers.

Most of whom Quote in this Journal.

Chicago, Ills.

R. A. BURNETT & Co., 163 South Water Street.

New York, N. Y.

HILDRETH BROS. & SEGELKEN,

Kansas City, Mo.

C. C. CLEMOMS & Co., 423 Walnut St.

Buffalo, N. Y.

BATTERSON & Co., 167 & 169 Scott St.

Hamilton, Ills.

CHAS. DADANT & SON.

Philadelphia, Pa.

WM. A. SELSER, 10 Vine St.

Cleveland, Ohio.

WILLIAMS BROS., 80 & 82 Broadway.

St. Louis, Mo.

WESTCOTT COM. Co., 213 Market St

Minneapolis, Minn.

S. H. HALL & Co.

Milwaukee, Wis.

A. V. BISHOP & Co.

Boston, Mass.

E. E. BLAKE & Co., 57 Chatham Street.

Detroit, Mich.

M. H. HUNT, Bell Branch, Wayne Co., Mich.

Indianapolis, Ind.

WALTER S. POWDER, 162 Massachusetts Ave.

Albany, N. Y.

CHAS. McCULLOCH & Co., 380 Broadway.

Cincinnati, Ohio.

C. F. MUTH & SON, cor. Freeman & Central avs.

Queens and Queen-Rearing.

If you want to know how to have queens fertilized in upper stories while the old queen is still laying below; how you may safely introduce any queen, at any time of the year when bees can fly; all about the different races of bees; all about shipping queens, queen-cages, candy for queen-cages, etc.; all about forming nuclei, multiplying or uniting bees, or weak colonies, etc.; or, in fact, everything about the queen-business which you may want to know—send for Doolittle's "Scientific Queen-Rearing"—a book of over 170 pages, which is as interesting as a story. Here are some good offers of this book:

Bound in cloth, postpaid, \$1.00; or clubbed with the BEE JOURNAL for one year—both for only \$1.75; or given free as a premium for sending us two new subscribers to the BEE JOURNAL for a year at \$1.00 each.

PAYNE'S

Practical Penmanship and Typewriting.

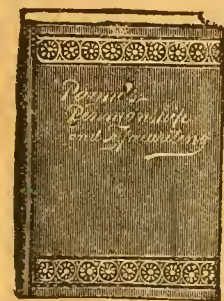

Containing Specimen Penmanship of various kinds, graded from the most elementary to the elaborately ornamental, in such a manner as to satisfy the needs of self-teaching students, with illustrated specimens of PEN LETTERING AND BRUSH MARKING; also practical lessons in Typewriting and a spelling list of 25,000 words; making in all a work of useful

and necessary information. Bound in extra cloth. Price 50 Cts., post-paid.

Special Offer: We will mail this book free as a premium to any one sending us one New Subscriber to the Bee Journal for one year (with \$2.00), and also send a copy of the premium book "Bees and Honey" to the new subscriber; or we will club the book with the Bee Journal for a year—both for \$1.35.

Payne's Business Letter Writer

and Manual of Commercial Forms.

Containing specimen Letters on all possible business topics, with appropriate answers. Containing general information with regard to the business matter, the rules for punctuation, the abbreviations most used in the mercantile world, a dictionary of mercantile terms, a table of synonyms, and other information which may be of value to the business man. New edition, revised and enlarged. 216 pages, Extra Cloth, 75 cts.

Special Offer: We will mail this book free as a premium to any one sending us two New Subscribers to the Bee Journal for one year (with \$2.00), and also send a copy of the premium book "Bees and Honey" to each of the new subscribers; or we will club the book with the Bee Journal for a year—both for \$1.60

GEORGE W. YORK & CO.,
CHICAGO, ILLS.

Indigestion is the ingratitude of a pampered stomach, and the consequences of it go beyond the stomach. They are found in torpidity and enlargement of the liver, in weakness and incompetency of the kidneys. You cannot hope to be well while your blood is thick with dead matter. Cleanse and invigorate yourself with Warner's Safe Cure.

Bottom Prices

**BRING US BIG TRADE.
GOOD GOODS KEEP IT.**

If you want the best supplies that can be made at a little less cost than you can buy the same goods for elsewhere, write to us for low prices. 1896 Catalogue now ready—ask for it and a free copy of *The American Bee-Keeper* (36 pages).

Address,
THE W. T. FALCONER MFG. CO.,
JAMESTOWN, N. Y.

Mention the American Bee Journal.

Honey-Clovers & Buckwheat SEED FOR SALE.

We have made arrangements so that we can furnish seed of several of the Clovers and Japanese Buckwheat, by freight or express, at the following prices, cash with order:

	5lb	10lb	25lb	50lb
Alsike Clover.....	\$.70	\$1.25	\$3.00	\$ 5.75
Sweet Clover.....	.65	1.20	2.75	5.00
White Clover.....	1.25	2.00	4.50	8.00
Alfalfa Clover.....	.65	1.10	2.70	5.00
Crimson Clover....	.55	.90	2.00	3.50
Jap. Buckwheat....	.20	.35	.90	1.25

Prices subject to market changes.

Add 25 cents to your order, for cartage, if wanted by freight.

Your orders are solicited.

GEORGE W. YORK & CO.,
CHICAGO, ILLS.

Mention the American Bee Journal.

BEGINNERS.

Beginners should have a copy of the *Amateur Bee-Keeper*, a 70-page book by Prof. J. W. Rouse. Price 25 cents; if sent by mail, 28c. The little book and the *Progressive Bee-Keeper* (a live, progressive 28-page monthly journal) one year, 65c. Address any first-class dealer,

or
LEAHY MFG. CO., Higginsville, Mo.

WHEN ANSWERING THIS ADVERTISEMENT, MENTION THIS JOURNAL.

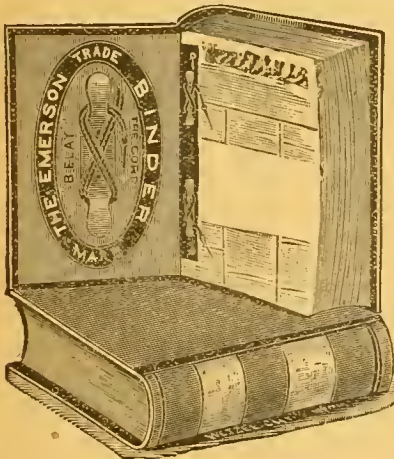

We have a few of these Emerson stiff cloth-board binders for the *American Bee Journal*. They make a splendid permanent binding, and hold a full year's numbers. The old price was 75 cents, postpaid, but will mail you one for only 60 cts., or with the *Bee Journal* for one year—both together for \$1.50.

GEORGE W. YORK & CO.,
CHICAGO, ILLS.

BEE SWAX WANTED

—FOR—

Foundation Making.

Send For OUR CATALOGUE,

SAMPLES OF FOUNDATION,

ADVICE TO BEGINNERS, Etc

Address,

CHAS. DADANT & SON,

WHEN ANSWERING THIS ADVERTISEMENT, MENTION THIS JOURNAL.

HAMILTON, ILL.

Ask Your Friends to Take This Journal.

PATENT WIRED COMB FOUNDATION

Has No Sng in Brood-Frames

Thin Flat-Bottom Foundation

Has No Fishbone in the Surplus Honey.

Being the cleanest is usually worked the quickest of any Foundation made

J. VAN DEUSEN & SONS,
Sole Manufacturers,
Sprout Brook Montgomery Co., N. Y.



Muth's HONEY-EXTRACTOR

Square Glass Jars.

Root's Goods at Root's Prices.

BEE-KEEPERS' SUPPLIES in general, etc., etc.

Send for our new catalog.

"Practical Hints" will be mailed for 10c

in stamps. Apply to—

Chas. F. Muth & Son, Cincinnati, Ohio.

Mention the American Bee Journal.

Cut Prices to Move Stock!!

There are a few items of desirable stock left of the goods secured of Thomas G. Newman when we took charge of his supply business here. In order to close these out and make room for fresh, new goods, we have decided to offer these at prices which will make them go.

The following is the list, which will be corrected as the stock is sold; if you see what you want here, order AT ONCE, or you may be too late:

V-Top Langstroth Frames, 75c per 100; 250 for \$1.25; 500 for \$2.

All-Wood Frames, pierced for wire, same price while they last.

Hoffman Frames, with 3/4-inch square bottom-bar, \$1.25 per hundred.

20 No. 1E 8-fr. Dov. Hives, with flat cover, 5 for \$3.50; the lot, \$13.

5 No. 9 " L. Hives, 2-story, with Heddon supers, \$2.50 for the lot.

4 1 1/2-story, 8-fr. Hives, nailed, complete, \$1.00 each; \$3.00 for the lot.

50 Comb Honey Racks, to hold sections on the hive, flat, \$1.00 for the lot.

No. 3 VanDeusen Thin Flat-Bottom Fdn., in 25-lb. boxes, \$10.50 a box.

Wakeman & Crocker Section-Press, 50c each (old price, \$1.25).

Townsend Section-Press, 50c. (old price, \$1.)

Hastings' Feeders, 10c each (old price, 25c.)

18 Shuck Feeders, 8c each, \$1.00 for the lot (old price, 20c.)

Hill Feeders, quart size, 8c each, 75c per doz. (less than half old prices).

Hill Smokers, 40c each; by mail, 60c.

Quinby Smokers at 50c, 70c, and \$1.00 each—20c extra by mail.

Jones' Frame-Pliers, 10c each; by mail, 10c extra (old price, 25c and postage).

It wanted by Freight, add 25c for cartage on orders for less than \$5

THE A. I. ROOT COMPANY,

Geo. W. York, Manager.

118 Michigan Street, CHICAGO, ILL.

