

TOTAL ECLIPSE OF THE SUN, Aug. 7th 1869
Showing the Corona and Prominences.

Collins' Elementary Science Series.

INTRODUCTION

TO

A S T R O N O M Y.

FOR THE USE OF SCIENCE CLASSES AND ELEMENTARY
AND MIDDLE CLASS SCHOOLS.

BY

JOHN ISAAC PLUMMER,

ASTRONOMICAL OBSERVER TO THE UNIVERSITY OF DURHAM



LONDON AND GLASGOW:
WILLIAM COLLINS, SONS, AND COMPANY.
1873.

184. g. 47.



PREFACE.

THE present Work is intended to supply a want which has been felt for a long time by those engaged in the scientific education of the young. Astronomy has not been generally cultivated in this country to nearly the extent that it has been, and still is, upon the Continent and in America; and it is believed that this is in some part owing to the want of elementary works on the subject. They must be sufficiently cheap to form class-books for middle-class schools, sufficiently scientific to imbue the youthful mind with a love for the science in its true aspect, and yet at the same time sufficiently easy and free from technicalities and mathematical reasoning to be read and understood with the imperfect knowledge of pure mathematics, possessed by this class of students. Such then has been the aim of this Work.

It has also been particularly prepared to meet the wants of students in Physical Geography, of whom some knowledge of Astronomy is very properly required by the Examiners of the Science and Art Department at South Kensington. It will therefore be found that all those branches which have an especial bearing upon the subject of terrestrial physics have been treated at greater length. The whole, however, forms an introduction to the study of Astronomy, which it is hoped may lead some to seek for deeper knowledge in other more advanced works, and in the standard text-books of the Universities.

As a means of enlarging the mind and of elevating the understanding, no one of the applied sciences can compare with Astronomy; and it is to be regretted that so much profound ignorance of its truths prevails among even well

educated persons. Yet it is beginning to be admitted, that no education can be considered perfect that does not include a knowledge of the simple facts of Astronomy, and along with other branches of science, it is now being gradually introduced into our schools.

All the dimensions of the Solar System, &c., that depend upon the value of the Solar Parallax, have been recomputed with the assumed value $8''\cdot94$, in favour of which the Author believes the mass of evidence at present to incline. A similar correction has been made in other recent works, but the new values to which it gives rise in several instances, have not been calculated with the precision, nor followed throughout all the terms which are affected by the alteration as carefully as desirable. Although the Solar Parallax is assumed provisionally, there is no reason why it should not be treated as an accurate value till one still more reliable is discovered. Occasionally these emendations having been made by unprofessional astronomers have given rise to strange mistakes. Though the Author cannot hope that the present work is entirely free from error, yet the calculations have been carefully made, and it is believed they will be found generally correct.

A more advanced text-book still seems to be a desideratum.

J. I. P.

THE OBSERVATORY, DURHAM,
December, 1872.

CONTENTS.

CHAPTER I.

	PAGE
I. FORM AND DIMENSIONS OF THE EARTH, . . .	9
II. ROTATION OF THE EARTH ON ITS AXIS, . . .	13
III. THE ATMOSPHERE—REFRACTION AND TWILIGHT,	19
QUESTIONS,	24

CHAPTER II.

I. OF THE VARIOUS MODES OF DEFINING THE POSITIONS OF CELESTIAL OBJECTS, . . .	27
II. OF THE INSTRUMENTS NECESSARY TO DETERMINE THE POSITION OF A HEAVENLY BODY, . . .	32
III. EXTRA MERIDIONAL INSTRUMENTS, . . .	38
IV. MEASUREMENT OF TIME—THE CALENDAR, . . .	40
QUESTIONS,	44

CHAPTER III.

I. LAWS OF PLANETARY MOTION,	46
II. OF THE UNIVERSAL LAW OF GRAVITATION, . . .	51
III. PARALLAX,	56
IV. THE ABERRATION OF LIGHT,	62
QUESTIONS,	64

CHAPTER IV.

	PAGE
I. THE SOLAR SYSTEM,	66
II. THE SUN,	70
INFERIOR PLANETS—	
III. MERCURY,	80
IV. VENUS,	83
QUESTIONS,	85

CHAPTER V.

I. THE EARTH,	88
II. DENSITY OF THE EARTH,	93
III. THE MOON,	97
IV. ECLIPSES,	105
QUESTIONS,	112

CHAPTER VI.

SUPERIOR PLANETS—	
I. MARS,	115
II. THE ASTEROIDS,	118
III. JUPITER,	120
IV. SATURN,	126
V. URANUS,	130
VI. NEPTUNE,	132
QUESTIONS,	134

CONTENTS.

vii

PAGE

CHAPTER VII.

I. COMETS,	137
QUESTIONS,	147

CHAPTER VIII.

PERTURBATIONS,	149
I. THE TIDES,	149
II. PRECESSION OF THE EQUINOXES—NUTATION,	151
III. LUNAR AND PLANETARY PERTURBATIONS,	154
QUESTIONS,	156

CHAPTER IX.

SIDEREAL ASTRONOMY—

I. OF THE FIXED STARS,	158
II. OF DOUBLE AND VARIABLE STARS,	162
III. CLUSTERS OF STARS—NEBULÆ,	167
QUESTIONS,	169



ASTRONOMY.

CHAPTER I.

I. FORM AND DIMENSIONS OF THE EARTH.

BEFORE we can learn anything of the motions, distances, or magnitudes of the heavenly bodies, it is necessary that we should have correct ideas of the size and form of the Earth itself. That its surface is curved, and its whole figure more or less spherical, appears from the following considerations :—(1.) When a ship is leaving port, the mariner sees the erections upon the shore gradually sink below the sea-offing or horizon, the foundations and lower stories disappearing first, until the whole is hid. Should he now climb to the mast-head, he will see the whole reappear in the opposite order. The simple effect of distance, however, is to diminish the size and the brightness of objects, in no way altering their forms. It is, therefore, only to be explained by the fact, that the surface of the ocean is curved, and rises up between the ship and the shore. From the height of the mast it is possible to look

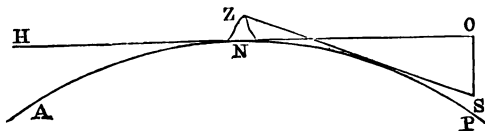

Fig 1.

over this curvature ; yet, as the distance becomes still greater, the buildings on the coast will sink below the visible horizon, notwithstanding the altitude of the spectator. While the view of an observer at the sea-level is

limited by a plane passing through the eye parallel to the surface of smooth water, one situated at a height, as on the deck or mast of a ship, is able to see somewhat below this. The depression of the sea-surface is known as the **Dip of the Horizon**, and forms a constant correction for all observations made at sea. Thus, if $A N P$ represent a portion of the earth, the view of an observer at N is bounded by the line $H N O$; while an observer on a mountain at Z would see all the first observer could, and in addition that portion of the heavens between O and S , —the arc $S O$, measured on the celestial sphere, being the dip of the horizon at the altitude $Z N$.

(2.) A similar proof of the earth's roundness is found in a phenomenon that has been sometimes observed by aëronauts, when ascending very soon after sunset. As they rise rapidly in the air, the sun comes again into view, rising gradually on their western horizon, while the earth below them is in profound shadow. If the earth were a flat plane, it is clear that even a slight depression of the sun below the horizon would cast in shadow the highest altitudes which the aëronaut could reach.

(3.) If the level of a surveyor be employed upon the surface of the still water of a canal, it will be found that at the distance of one mile the water is depressed below the level of the instrument about eight inches. This affords not only a proof of the earth's form, but some idea of its size. A globe will require to have a diameter of about 7,920 miles to have a curvature equal to that observed on the canal, and this may be taken as a very fair approximation to the diameter of the earth.

(4.) Beyond this there is the evidence of lunar eclipses, which phenomena are palpably caused by the shadow of the earth falling upon the full moon. The outline of the shadow is *always* circular, and no other figure than a sphere will cast a circular shadow in whatever direction the light may fall upon it.

(5.) There is the not unimportant fact of the circumnavigation of the globe in every direction which the configuration of the land will allow.

To obtain more *accurate* information of the earth's form and dimensions, it is necessary to determine the distance between two remote points on its surface which are upon the same meridian, or due north and south of each other, with the greatest possible care, and then by celestial observation to learn what fractional part of the earth's circumference has actually been measured—an operation of the greatest difficulty in practice, but achieved in the following manner. A portion of country is selected where the ground is very nearly level, and a base line is marked out. Bars of metal are prepared as measuring rods with every care, and these are placed end to end along the base line, accurately levelled. They are not allowed to touch, lest some accident or expansion of the bars should cause them to jolt one against another, but the intervals are measured by microscopes, and the temperature of the bars observed, in order that their expansion from heat may be calculable; they are also protected from the rays of the sun by tents, when being used. This process is repeated, again and again, along the line with the same rods, till a distance of a few miles is measured with great accuracy, the two extremities being rigorously marked. A third station is now taken into account, generally selected upon the summit of a conspicuous hill, and its bearing is found by means of theodolites stationed at either extremity of the base line. It will be seen that this line and the lines joining each extremity of it to the third station will form a triangle, of which the length of one side is known, and also the amplitude of two of the angles. It becomes then a very simple problem in trigonometry to calculate the lengths of the remaining sides.* Other stations are now chosen, and the newly-found distances of the third station are in their turn taken as the

* Those unacquainted with the principles of the mathematical solution of triangles will obtain some aid in understanding the above, by drawing triangles with the aid of compasses, &c., of which the base and two angles are given quantities. It will at once be seen that these data determine the magnitude of the triangles, and that the trigonometrical solution is nothing more than a reduction to calculation of a simple geometrical problem.

bases of other larger triangles to be treated in the same manner. A net-work of triangles is thus formed, spreading over the country in a northern and southern direction, till the exact distance between two remote stations upon the same meridian of longitude is ascertained. In Britain, trigonometrical surveys in this manner have been several times performed, the object being the distance in feet between a point on Shanklin Down, Isle of Wight, and one on the island of Balta, in Shetland. This is called the great meridional arc of England; and several base lines have been measured at different times for its verification—notably at Loch Foyle in Ireland—for it should be remarked that very large triangles are often chosen, and a considerable arm of the sea is passed over without difficulty. We have now to find what fractional part of the earth's circumference has been measured. The direction of the plumb-line is not parallel to itself at different places, but is always towards the earth's centre. It may therefore be considered as a prolongation of the earth's radius at any point. Suppose that at one extremity of the meridional arc, it points to a particular star, and at the other extremity it is found to point 10° to the south of that star, then the angle contained between the radii of the earth at these points is 10° , or $\frac{1}{36}$ -part of the earth's circumference. An instrument, called a zenith sector, is used to ascertain the direction of the plumb-line, in space or with reference to the stars, at the two stations. In this manner the length of 1° of latitude is found to be about 69.1 miles; and hence the whole circumference will equal 24,876 miles, and the diameter 7,918 miles, roughly.

The importance of the problem has led to similar measurements being made in various parts of the world. The most celebrated arcs are those of Russia, France, England, India, Peru, and the Cape of Good Hope—places differing greatly in latitude—which brings to light this important fact. The length of a degree of latitude in feet always decreases slightly as the equator is reached, showing that the curvature there is greatest, or, in other

words, that the earth is not a perfect sphere, but slightly flattened at the poles. Its figure is therefore that of an oblate spheroid. The numerous results have been thoroughly investigated by the accomplished mathematicians, Airy and Bessel. They agree in giving the following as the true dimensions of the earth :—

Polar diameter,	7899.1 miles.
Equatorial diameter,	7925.6 „
Difference or polar compression,	26.5 „
Proportion of diameters,	298 to 299

These results are further confirmed by similar trigonometrical surveys, carried in an east and west direction, the difference of longitude of the extreme stations being determined by methods to be afterwards explained. It is only necessary to state that similar dimensions and a like compression is found by these operations.

II. ROTATION OF THE EARTH ON ITS AXIS.

The first fact that attracts the attention of a person endeavouring to learn something of the heavens from actual inspection, rather than from books, is the diurnal motion of the stars. A few hours' observation of the heavens upon a starry night suffices to show a motion of all the stars from east to west. If any person will station himself so as to have a full view of the northern portion of the sky, he will soon find one star there that appears to be fixed. This is the pole star, which revolves in so small a circle that its motion is not easily detected by the unaided eye. He will see further that stars very near the pole star revolve slowly in small circles round it, or, more strictly, a point near it, as a centre, and that as he selects stars for observation further removed from the pole, their motion is faster, but always circular round the same point, and performed in the same time (24 hours). At length he will find the circles become so large that the stars are seen to set below the horizon and rise again, after an interval, in order to complete their paths. If he now

stations himself to watch the southern heavens, he will see the stars rising obliquely from the eastern horizon, climbing to a considerable height in the south, and then declining and setting in the west. They will describe large arcs of circles, and move more rapidly than in the north. Stars in the extreme south will be seen only a short time, by far the larger part of their circular paths being performed below the horizon. If aided by a telescope, he will also notice that the low southern stars move with less velocity, showing a return to the condition of the northern heavens. Everywhere the same relative positions of the stars among themselves is preserved, and they appear to revolve as if attached to the interior of a hollow sphere, the axis of that rotation lying between the north pole, which is high above the northern horizon in these latitudes, and the south pole, which is equally depressed below the southern. From this general movement of the stars, one of two conclusions must be drawn—either the heavens revolve as a whole around the earth in a day, from east to west, or the earth revolves on its own axis, in the opposite direction, west to east. From the consideration of the very great distances of the heavenly bodies, of which rude notions might be obtained from certain phenomena which occasionally take place, as eclipses, occultations of the fixed stars by the moon, &c., the first of these hypotheses might be shown to be extremely improbable, if not absurd; but some simple experiments are possible, which more certainly point out this rotatory motion of the stars to be produced by the revolution of the earth on its axis.

The first is known as Foucault's pendulum experiment. If a heavy ball of lead be suspended by a long wire from a fixed support, and be made to oscillate in the plane of the meridian above a table upon which the north and south points are marked, it will be noticed, after a short interval, to deviate from the direction of the meridian very sensibly, the oscillations on the southern side of the table turning towards the west. (The experiment is supposed to be made in the northern hemisphere.) Now,

by the principles of dynamics, the plane of oscillation of such a pendulum is invariable; and the cause of the deviation must be traced to the fact that the table has revolved to some extent, being carried round with the earth. Could this experiment be tried at either of the poles of the earth, the pendulum would follow the course of the stars exactly, as there the table would be at right angles to the axis of the earth's rotation, or would revolve on its own centre; on the contrary, at the equator the experiment would fail completely.

An instrument called a gyroscope was also devised by M. Foucault, which still more plainly demonstrates that the motion of the stars is only apparent, that of the earth real; but the construction of this instrument, and the conditions to be fulfilled in using it, are too complicated to be described here.

We have now to discuss an experiment which is at once a proof of the earth's rotation and of its deviation from a strictly spherical form. All are familiar with the influence of centrifugal force when a weight is made to revolve at the end of a cord. It tends to make the weight fly off from the centre of rotation. If the earth is really revolving, objects at the equator will be more subject to this force than in high latitudes. In other words, the weight of a body or the force of gravity will be less at the equator than at the poles. From the dimensions of the earth and the time of its rotation, it may be determined that the weight of a body will be reduced by $\frac{1}{289}$ in consequence of the centrifugal force acting at the equator. There are two methods by which the difference of gravity at two places may be ascertained experimentally:—1st, The length to which a metallic spiral spring is stretched may be noted at the two places—in which case a weight of 288 oz. near the poles would stretch it as much as 289 oz. at the equator, supposing the centrifugal force alone be taken into account. 2d, The vibrations of a pendulum at the two places in a given time may be counted. Since the velocity of the pendulum vibrations is directly dependent upon the force of gravity, this forms an admirable method

of determining its variation. Thus, when a pendulum that keeps true time at Melville Island (N. lat. $74^{\circ}22'$) is carried to the equator, it loses about 213 seconds in a day, its vibrations are slower to that extent, and hence gravity at the equator is less than at the poles.* Repeated observations of this kind have given $\frac{1}{194}$ as the difference in the force of gravity at the equator and poles; but we have seen that only $\frac{1}{289}$ is to be attributed to the effect of centrifugal force arising from the rotation of the earth. The difference, or $\frac{1}{590}$, is therefore to be ascribed to the greater distance of the surface of the earth from the centre at the equator, than at the poles.†

The reader will perceive, from what has been said of centrifugal force, that had the earth been a perfect sphere in rotation, it could not long have retained that form; the fluid portion at least would speedily have sought the equatorial regions, forming a protuberance there, and leaving two large polar continents. Newton has calculated the ellipticity or amount of flattening of the earth, supposing it to have consisted at one time of fluid matter of uniform density revolving at the speed with which it now moves. He found the proportions of the diameters would be as 229 to 230—which is not far removed from what its real ellipticity is. This is not put forward as an explanation of the cause of the earth's flattened form, but as exhibiting the accordance of theory with fact, and in proof that the oblate spheroid is the figure of equilibrium, by virtue of which the waters of the ocean have no deter-

* It is to be remarked that, in order to keep true time, the length of a pendulum beating seconds must vary in different latitudes, being shortest at the equator. Thus, at Melville Island the pendulum at the sea level must be 39.203 English inches. At Greenwich (N. lat. $51^{\circ}.29'$) 39.139 inches, and at the equator 39.020 inches.

† This statement may be made in the following form:—A weight of 194 pounds, carried from the vicinity of the poles to the equator, would be found to weigh 193 pounds— $\frac{1}{289}$ of its weight, or $10\frac{3}{4}$ oz., being lost in consequence of the centrifugal force acting there, and $\frac{1}{590}$, or $5\frac{1}{4}$ oz., in consequence of its greater distance from the centre of the earth.

mination to any particular portion of its surface. We shall see later, when we come to speak of other planets than the earth, that all of them revolve on their own axes, and, like it, are flattened more or less at their poles; so that analogy alone would lead us to conclude the same to be the case with the earth, had not more than sufficient proof already been adduced of the fact.

Amongst other phenomena which depend upon the earth's diurnal motion around its own axis, that of the Trade-Winds stands pre-eminently first in importance. On either side of the equator the wind, especially on the ocean, blows almost constantly in one direction, being N.E. in the northern hemisphere and S.E. in the southern. The sun, as we shall soon learn, is at all times of the year vertical over some point or other within a limited space on either side of the equator, known as the tropics; and in consequence of this, that portion of the globe and the incumbent atmosphere is considerably warmer than at other parts. This heated atmosphere, following the general law of heat, expands greatly, and becomes specifically lighter than before, which causes it to rise to a high altitude, and its place is occupied by colder and heavier air from more temperate climates. The hot air slowly floats away above the cold air, which has taken its place next the surface. Gradually it is cooled down in higher latitudes, and it then descends and takes the place of the air removed to the equatorial regions; and in this manner a constant circulation is kept up. A wind near the surface, blowing perpetually from the direction of the poles to the equator, and an upper current of heated air, flowing from the equator towards the poles, would be the inevitable result if the earth was stationary and the sun revolved around it in the course of a day; but the rotation of the earth on its axis from west to east materially modifies this. The atmosphere, everywhere taking part in this rotation, travels with the earth at a similar speed; but at the equator the distance from the axis of revolution being the greatest, the speed is likewise the greatest. Thus, the equatorial circumference of the

earth being 24,899 miles, the velocity of the atmosphere, when it appears stationary above the surface, must be equal to 1,040 miles per hour. At the latitude of 40° the circumference of the circle of latitude is only 19,060 miles, and the velocity there will scarcely equal 800 miles per hour. The polar wind, in its course to the equator, does not acquire the increased velocity immediately upon entering the tropics, but lags behind the earth in these parts; and thus an easterly tendency is produced, giving rise, as before stated, to a north-east trade-wind in this hemisphere, and a south-east trade-wind in the southern. As it proceeds onward, however, the velocity is increased from constant friction against the surface, and it thereby partially loses its easterly character. Now, near the equator, the circles of latitude increase in dimensions very slowly, the diurnal motion of these portions of the earth likewise increases but slowly, and hence the trade-wind still further approaches to the direction of a polar current. Finally it meets the trade-wind setting in from the other hemisphere, and loses all the appearance of a permanent wind at the equator, which is usually a region of calms.

It has further been remarked of late years that the direction of rotation of the cyclones and hurricanes which infest sub-tropical seas, is determined by the diurnal motion of the earth. These fearful tempests are produced by the unusual heating of some portion of land or water from local causes. The incumbent air being also greatly heated, rises, leaving a much reduced barometric pressure. Winds then set in from all parts to fill up the vacancy: that arriving from a polar direction, as in the case of the trade-winds, lagging behind somewhat, not having sufficient velocity; that from the equator, on the contrary, will have too great a velocity; while winds from the east or west have no effect upon the gyratory motion of the cyclone. If we confine ourselves to the northern hemisphere for the present, it is clear that the polar or north wind will become a north-east wind, and that the equatorial or south wind will become a south-west wind. Now, plainly, a wind blowing from the north-east will

have the tendency, upon entering the vortex, to carry it round in the direction N, W, S, E, N. The equatorial current will also have the same effect. This is then the direction of revolution for cyclones in this hemisphere, while in the southern the reverse direction, or N, E, S, W, N is taken. The latter conforms to the movement of the hands of a watch; the former is opposed to that movement. The explanation here given has been observed to agree with fact; and hence we have one more indication of the earth's daily revolution on its axis.

III. THE ATMOSPHERE.

There is one consideration more which it is necessary to examine before we attempt any observations upon celestial phenomena. The earth we all know to be enveloped by a thin film of very light gas, or more correctly, mixture of gases, called air. Through this every observation of the heavens must be made, and its influence in modifying phenomena must be understood, before we can be satisfied of the accuracy of scientific inquiry. Though light, the air has weight: a globe of glass, from which the air has been exhausted, weighs less than it does when the air is re-admitted. Like other gases, also, it is compressible; that is to say, two or more volumes of air may be forced into the same globe; and, finally, it is elastic, or will diffuse itself, if subject to no compression, in a space greater than it ordinarily occupies. The constitution of the atmosphere will therefore be, that at the sea-level, the air having to bear the whole weight of that above it, will be compressed, dense, and heavy. As we ascend, it will get lighter and lighter, and finally will become so rarified that no absolute limit can be fixed as its termination. The rate of diminution of the density, as determined by its pressure upon the surface of mercury in the barometer, is very rapid; so that at a height not exceeding that of many of our mountains (18,000 feet), one-half of the atmosphere would lie below and one half above the observer. At this height, the air being only half the

density at the sea-level, respiration is difficult, and at still higher altitudes no living creature could live. At forty or fifty miles above the surface of the earth the air would be so rarified that it would be impossible to determine its existence by any means at our command; and this altitude may practically be taken as the limit to which the atmosphere extends.

When a ray of light enters a fluid more or less dense than that from which it comes, obliquely, it is bent out of its course, agreeably to a well known law in optics. A

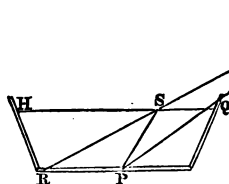

Fig. 2

very simple experiment will illustrate this, and is worth describing, from its close analogy with what takes place when the light from a star enters the atmosphere. Let H R P Q be a vessel, having a point on the bottom, P, clearly marked. The observer's eye must be placed at A, so that P shall just be discernible over the margin. If the vessel be filled with water, the point will be seen upon the bottom at R. The line of sight from A, after touching the surface of the water at S, is bent out of its course in such a manner as to be more perpendicular to the surface than before reaching it, and thus arrives at the point P. But the observer is only sensible of the direction in which the light comes to his eye, namely, S A, and the point therefore is seen to be in that direction, or at R. This effect upon light is called refraction.

We will now consider what is the effect of refraction upon the light of a star. The atmosphere is a fluid denser than that through which the light of the star comes to us. It may be regarded as consisting of a series of layers, becoming gradually denser as we approach the surface of the earth. If S B (fig. 3) represent a ray of light from a star, S, its course, after meeting the atmosphere at B, is bent more and more as it proceeds through the successive

atmospheric layers. The eye of the observer is only aware of the direction in which the light enters it; so that the star is seen at T, or higher in the heavens than its real place. The amount of the displacement is not great,

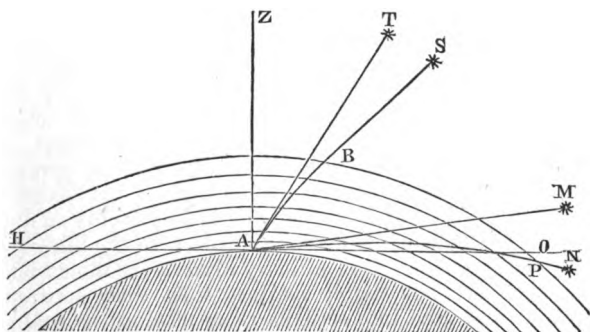

Fig. 3.

unless the light comes in a very oblique direction. At the zenith (Z) there is no refraction, and all objects there appear in their true places. A star situated half-way between the zenith and the horizon (H O) will appear too high by about $1'$, or the 30th part of the moon's diameter; but near the horizon, the light having to pass through a very thick as well as dense stratum of air, the amount of refraction is much greater, and its rate of increase very rapid.* At the horizon objects are raised by refraction about $33'$, from which it is clear that the sun or moon, whose diameters do not much exceed $30'$, are absolutely below the horizon at the time when they first appear to

* Refraction varies very nearly as the tangent of the zenith distance; and for all zenith distances less than 80° the following rule will give it pretty closely:—Refraction = $57''$ tangent zenith distance; but since the density of the air depends to some extent upon its temperature and other causes, this is only to be considered an average approximation. At greater zenith distances the rule fails.

graze it. Thus, when the sun is at N. (fig. 3), the light, having to pass through the atmosphere the whole distance from P to A, refraction is at its maximum, and the sun, to the observer at A, will be seen at M.

A further effect of refraction upon the sun, when it is near setting, is to distort its figure very sensibly into a somewhat irregular oval. This is caused by the unequal effect of refraction upon the upper and lower margins of the sun, consequent upon its rapid increase near the horizon; the lower margin being considerably more elevated than the upper, the sun appears compressed, or elliptical. It is to be remarked, also, that it appears larger when near setting than when high in the heavens. This is not caused by refraction, and indeed is only an illusion, as measures of its diameter made with the telescope will readily prove. Our ordinary ideas of the dimensions of objects are not simply obtained from their apparent size; we also take into account their distance, as well as we are able to judge of it. In judging the distance of the heavenly vault, that part near the horizon appears much more distant than near the zenith, partly because the dense stratum of atmosphere there subdues the brightness of its colour, producing the effect of distance, and partly because the eye is assisted in estimating by comparison with the features of the landscape. The want of objects for comparison deceives us in quite a similar manner, when we look across the sea at a distant ship, which, like the sky in the zenith, appears much nearer than it really is. We are thus doubly led by the imagination to fancy the sun more distant from us when setting than when high in the heavens, and hence attribute to it a greater size. The moon, although appreciably farther from us when on the horizon, and groups of stars, both in the same manner appear larger when nearly setting.

Twilight is a phenomenon which also depends upon the atmosphere enveloping the earth. Every spot that was not directly in the sun's rays in the daytime, and the earth also, the moment the sun had set below the horizon, would otherwise be in profound darkness. This is abso-

lutely the case upon the moon, where there is no atmosphere sufficiently dense to be appreciable to us, as will be explained hereafter, and all shadows there appear perfectly black and sharply defined. The explanation of the existence of twilight, and the scattering of daylight in all directions, is found in the fact, that the air carries in it a large quantity of finely-divided dust, which we see in the sunbeam, and these minute solid particles have the property of reflecting light and diffusing it everywhere. Clouds also reflect and diffuse the solar light, as do doubtless those minute particles of watery vapour which are always present in air in great quantity, and which sometimes become visible as fog.

The gradual fading away of this diffused solar light, which we call twilight, will readily be understood from the accompanying diagram.*

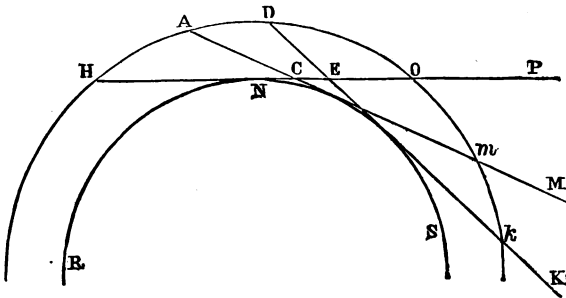

Fig. 4.

If an observer be stationed at N (fig. 4), R N S representing the earth, H O *k* the stratum of atmosphere beyond it, and H O the observer's horizon, the portion of atmosphere capable of diffusing light will be represented

* The reader must be warned that, in order to show the effects of refraction, twilight, &c., in a diagram, those effects have to be greatly exaggerated. Thus, in fig. 4, if the earth be represented by a circle of 2 inches diameter, that representing the atmosphere should only extend 1-80th of an inch beyond it.

by the segment $HNO D$, so long at least as the sun has not sunk below the horizon at P . When the sun is at M , the segment $A m D$ will be illuminated by its rays; but only that portion, $AC O D$, will be capable of giving reflected light to the observer at N .* Again, when the sun has reached K , the segment $D k O$ will be wholly illuminated; but a still smaller portion, $DO E$, will reflect light to N . The twilight gradually fades to the observer, until the sun is about 18° below his horizon, at which time it becomes imperceptible. The duration of twilight at any place, therefore, depends upon the obliquity of the sun's descent and the rapidity of his apparent diurnal movement. Within the tropics, where the daily course of the sun is never far from perpendicular to the horizon, twilight is always short; but it is a mistake to suppose that there is no twilight near the equator. On the contrary, in this country and in others still further north, there is no night during a less or greater portion of the summer months, the sun never sinking so much as 18° below the north horizon. It is to be noted that this limit is not invariable, but to some extent depends upon the meteorological state of the air; twilight has been perceptible in this country, under certain atmospheric conditions, when the sun was as much as 21° below the horizon. Within the arctic and antarctic circles, twilight will continue longer, and near the poles for days together. At the poles, the sun is above the horizon constantly for six months of the year; and only two twilights, each of about fifty days' duration, would be experienced there.

QUESTIONS.

1. What proof of the earth's form do we obtain from the disappearance of objects at sea? How do we know it is not the effect of distance only?

2. What is the Dip of the Horizon, and does it vary with the altitude of the spectator?

* In consequence of the refraction of the sun's rays passing through the atmosphere, this is not strictly true. The atmosphere will be illuminated for a short distance further than the line AC upon the side of H .

3. What is the amount of the earth's curvature in a mile, and where is this most readily seen ?

4. Give other proofs of the earth's spherical form ?

5. Explain the mode of measuring a base line in trigonometrical surveys.

6. Upon what base line does the triangulation of Great Britain and Ireland principally depend ? Give the extremities of the meridional arc of England ?

7. Where have the more important meridional arcs been measured, and what is discovered by a comparison of their results ?

8. Where is the earth's curvature the greatest, and what figure results from the difference of curvature at the equator and the poles ?

9. What are the exact dimensions of the earth ? By whom determined ?

10. Are these results confirmed by any other exact measurements ?

11. Round what point and in what figure are the diurnal motions of the stars performed ?

12. Describe the motions of southern stars ? What alternative results from the motions of the stars ? Is their motion real ?

13. Explain Foucault's pendulum experiment. What other instrument has M. Foucault devised to prove the earth's rotation ?

14. What is the influence of the earth's rotation upon the weight of bodies at the poles and the equator ?

15. How may this be determined experimentally ?

16. What difference in the weight of a body results from these experiments ? Is this difference to be attributed wholly to centrifugal force ?

17. What proportion of the difference depends upon the form of the earth ?

18. Give the lengths of a seconds' pendulum at Melville Island, Greenwich, and at the equator ?

19. If the earth had been a perfect sphere, what would have been the effect of centrifugal force upon the waters on its surface ?

20. What flattening would result from the earth's rotation, supposing it to have been a fluid mass of uniform density ?

21. State an argument in favour of the earth's rotation, derived from observation of other planets ?

22. What are trade-winds ? and give the direction in either hemisphere ?

23. How are trade-winds produced ?

24. Explain the cause of their easterly direction, and why this tendency is lost on approaching the equator ?

25. How are cyclones produced ?

26. What is their direction of rotation in either hemisphere, and how is this direction given to them ?

27. State the properties of atmospheric air that determine its distribution above the earth's surface?

28. Give the limit usually assigned as that of the atmosphere. Is its limit definite?

29. What instrument measures the weight of the atmosphere? At what elevation is the air only half the density at the sea-level?

30. What is refraction? What is the direction taken by a ray of light entering a denser from a rarer medium?

31. State the effect of atmospheric refraction upon the light of a star?

32. Where has atmospheric refraction no effect upon a ray of light, and where is it a maximum? Illustrate this by its effect upon the setting sun?

33. Why does the sun appear oval when setting?

34. Why larger? Give two reasons for this illusion.

35. What produces twilight? Explain its gradual fading.

36. How much is the sun below the horizon when twilight becomes imperceptible? Is the limit invariable?

37. Where is twilight shortest? Where longest?

38. Has refraction any effect upon the duration of twilight?

CHAPTER II.

I. OF THE VARIOUS MODES OF DEFINING THE POSITIONS OF
CELESTIAL OBJECTS.

IN order that the position of a heavenly body may be defined, two elements are necessary, precisely as two (latitude and longitude) are necessary in geography to fix the position of places upon the earth. We have the choice of several methods in astronomy; but the simplest is to measure with proper instruments the height of the object above the horizon, and also, measuring round from the north point through the east, ascertain what angle of the horizon is included between the north point and the point where a perpendicular arc, let fall upon the horizon from the object, cuts it. In this case the horizon is said to be taken as the **fundamental plane**, and the two angular measurements, which are called **co-ordinates**, clearly fix the position of the object in the sky. The horizon is a great circle of the heavens, having for its poles the **zenith** and the **nadir**. The first is the point vertically above our heads; the second that directly beneath our feet. The height of a star above the horizon is called its **altitude**, and the distance measured round upon the horizon from the north point is its **azimuth**. For some purposes this is a satisfactory way of fixing the place of a heavenly body; but there are two reasons why its use is very limited. *First*, The position of the star, with reference to the horizon, is continually changing, in consequence of the rotation of the earth, and therefore the instant of observation must be given also to fix the position. *Secondly*, The horizon itself changes with change of the place of observation, and this therefore requires to be given.

A second system of co-ordinates, free from these inconveniences, is obtained by taking the celestial equator, or

equinoctial, as the fundamental plane. The equinoctial is that great circle in the heavens midway between the poles, or it is very nearly the circle which the sun describes in its daily course upon the 20th of March; or, again, it may be explained to be that circle in the heavens, formed by the plane of the terrestrial equator, produced infinitely in all directions. If the angular distance of a star north or south of the celestial equator is found, and the distance of the perpendicular to the equator from some starting point in it generally agreed upon, it will follow that the place of the star is satisfactorily defined. The perpendicular distance north or south of the equator is called the **Declination**, and the angular distance measured from the starting point along the equinoctial is called the **Right Ascension**. The advantage of this method is that the place of a star found by these co-ordinates remains permanent, neither depending upon the position of the observer nor the rotation of the earth; but it is necessary to determine upon a desirable starting point. The bright star Altair, in the constellation of Aquila, was used at one time by some astronomers, in which case the reader will see a remarkable analogy between astronomical declination and right ascension, and geographical latitude and longitude; but in more modern times the point of intersection of two great circles (the equator and the ecliptic) has been universally taken as the origin of right ascensions. This point is called the **First Point of Aries**; but to explain the meaning of the term it is necessary that we should consider briefly the annual apparent motion of the sun.

If we carefully watch the position of the stars for a number of nights in succession, we shall soon find that they do not occupy the same position in their diurnal circles of revolution at the same hour each night. If, for instance, we look out upon March 20th, as soon as the sun has set, which it does at this period of the year very nearly at 6 P.M., the first star that is seen in the south is the bright star Sirius, the most conspicuous of all our stars. It will be first descried a little before 7 P.M., and will be very nearly due south. A week later it will be seen

decidedly to the westward at this hour of the evening, and a month later still it will be first descried not far from the western horizon. All the other stars will be seen to have the same westward motion, going always to meet the sun, and disappearing in his rays; while others rise from the eastern horizon to take their places, and to approach him in their turn. It amounts to the same thing to say that the sun has a motion from west to east, in opposition to the diurnal movement, and meets the stars. The rate of this motion is such that it makes an entire revolution round the earth in a year. (We are only speaking of apparent motions at present; it is of course the earth which revolves round the sun in the course of the year, but for the time we may assume the *apparent* motion to be *real*.) From March 20th, called the vernal equinox, because upon this day the sun is on the equator, making the day and night of equal length in all parts of the world, to June 21st, the sun performs a quarter of its annual course from west to east, and during this time it has also risen in the heavens to about $23\frac{1}{2}^{\circ}$ above the equator. Then it turns back again towards the south; and hence the circle over which it is vertical in its diurnal course upon this day is called the tropic ($\tau\rho\epsilon\pi\omega$, I turn) of Cancer, the sun being in the constellation of that name. The point in the heavens which the sun occupies when it attains its greatest height is called the summer solstice (*Sol*, the Sun; *Sto*, I stand). After the next quarter of its annual course it reaches the equator on September 23d, and there is a second or autumnal equinox. Continuing in the same direction, it reaches its most southerly declination ($23\frac{1}{2}^{\circ}$ south) on December 21st, called the winter solstice, the sun being in the constellation of Capricorn and vertical over the tropic of that name. After this it turns north, and arrives again at the vernal equinox on March 20th, completing its entire revolution.* The apparent

* This motion of the sun from south to north, and again from north to south, may be noted by the length of the noon-day shadow of a fixed object, from which the reader will obtain a much keener appreciation of the sun's movement than from mere

motion of the sun round the earth is therefore in a great circle, cutting the plane of the equator at two points (the equinoxes), and inclined to it at an angle of nearly $23\frac{1}{2}^{\circ}$.

This great circle is called the *ecliptic*, and the point of its intersection with the equator, which is taken as the origin or starting point of right ascensions, is called the *First Point of Aries*, because the sun enters that constellation at the vernal equinox, or on the 20th March. There is no star at this point of intersection to mark its place, but the frequent observation of the sun fixes the point with equal certainty; and we shall find further on that it is subject to a peculiar shifting along the ecliptic, which would make a fixed point in the heavens useless to mark its position for any length of time.

A third system of co-ordinates in frequent use is obtained by taking the ecliptic as the fundamental plane; and the angular distance of a body north or south of this circle, together with the distance of the perpendicular arc on it from the first point of Aries, similarly used as the starting point, will define the place of an object. The perpendicular distance of the object north or south of the ecliptic is called its *latitude*, and the angular distance, measured round the ecliptic from the First Point of Aries, is called its *longitude*. The student must be careful to distinguish astronomical latitude and longitude from the same terms used in geography, to which they have no resemblance but in name. It is much to be regretted that the same terms are used, but it is extremely difficult to alter an established custom.

This system of co-ordinates is of great service in the discussion of the planetary motions, though observations of the places of all objects are made and expressed originally in the terms of the previously-mentioned system of co-ordinates. It is, however, quite easy, by the use of proper mathematical formulæ, to convert the place of an object expressed in one set of terms to that in another.

reading. It is much to be desired that, wherever it is practicable, the student will test the truth of our assertions by actual examination of the heavens,

An example of the three sets of co-ordinates, with their respective planes of reference and the mode of reckoning the several elements, is given in figs. 5 and 6. The observer is stationed on the earth at A, which may be supposed a point by comparison with the sphere of the heavens. H and O are the north and south points of his horizon, H h O o. P is the north pole of the heavens, Z the observer's zenith; the circle, H P Z O, passing through these

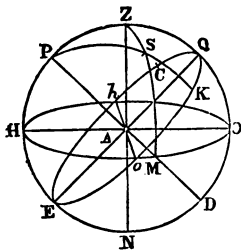

Fig. 5.

points is therefore the *meridian* of the place of observation. S being a star, its altitude is represented by S M, and its azimuth by the large arc, H h O M. The complement of the altitude (Z S) is called the *zenith distance*. P and D being the poles, E h Q o is the equator, the portion h Q o being above the horizon and visible to the observer. If C represent the first point of Aries, then the arc, C E o K, is the *right ascension* of the star S, and S K its *north declination*. The complement of the declination (S P) is called the *polar distance*. The spherical angle, S P Z, which represents the deviation of the star from the meridian, is called the *hour angle*.

To prevent confusion, the horizon is omitted in fig. 6; but the ecliptic, L R C F, is inserted, P' and D' being its north and south poles. The portion of the ecliptic, C R G L, is south of the equator; the remaining portion, C F L, is north. C is the first point of Aries, L the opposite point of intersection, sometimes called the *First Point of Libra*. The latitude of the star S is represented by S G, and the longitude

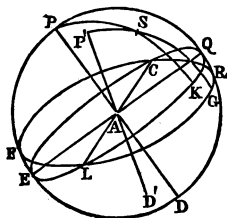

Fig. 6.

by the large arc, C F L G. The angle, Q C R, is the *obliquity* of the ecliptic, or its inclination to the equator ($23\frac{1}{2}^{\circ}$). The first point of Aries occupies the position represented in fig. 6, about midnight in the beginning of August; and the student will be able to judge of the position of the ecliptic, with reference to the horizon and equator, at that time of the year from the diagram. The north pole of the ecliptic, it may be remarked, is situated nearly midway between two bright stars, δ and ζ , in the constellation of Draco. The first pair of stars in the Great Bear, the well known pointers, indicate almost exactly the direction of the north pole of the equator, situated very near the pole star. The next pair of stars in the same constellation point with equal exactness to the north pole of the ecliptic; but the distance is rather greater. With this aid the position of the sun's annual path in the sky will be readily found. The great circle of the heavens that passes through both these poles and the solstices is called the *solstitial colure*; and another great circle at right angles to this, passing through the equinoxes, is called the *equinoctial colure*.

II. OF THE INSTRUMENTS NECESSARY TO DETERMINE THE POSITION OF A HEAVENLY BODY.

In speaking of the diurnal motions of the stars, we have said that they rise in the east, climb to a greater or less altitude, and then decline in the west. They all reach their greatest altitude, or *culminate*, when upon the meridian, a great circle of the heavens passing through the north and south points of the horizon and the zenith of the observer. When situated upon this circle, they are most favourably placed for observation, because least subject to displacement by refraction, which is always a doubtful element in the correction of astronomical observations. The *Transit Instrument* is designed to mark out this circle upon the sky, and to determine the right ascensions of objects as they culminate upon the meridian.* It consists of a

* Originally invented by Roemer, a Danish astronomer, about 1681, A.D.

telescope mounted firmly upon a horizontal axis, the extremities being well turned cylindrical pivots, resting in metallic sockets upon massive stone piers. The reader will conceive the astronomical telescope to be simply a

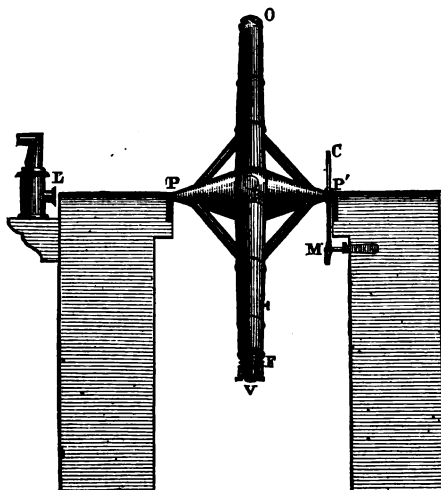

Fig 7.

large lens or object-glass at O (fig. 7), which, gathering all the parallel rays of light that fall upon it from any object, causes them to converge so as to form a small inverted image of the object near the point F, which is called the focus. This image may be seen as a real object at the ordinary distance of clear vision (about 10 inches); and the earlier telescopes consisted of nothing more than this, the tube even being in some cases advantageously dispensed with. A simple microscope or eye-piece (V) was, however, soon added, by which the image was viewed and magnified, and the telescope was then complete. In the transit telescope a set of fine wires (usually of spider lines or silk) is inserted in the focus of the object-glass, which

A.

C

may be perfectly well seen through the eye-piece along with the object. The wires are generally five or seven in number, arranged as in fig. 8, with one horizontal wire to mark the centre of the field.

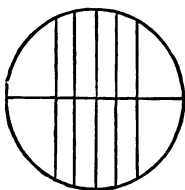

Fig. 8.

In order that these may be seen at night, the pivot and axis, P , is perforated, and the light of a lamp, L , is cast down the tube by an inclined annular reflector in the interior of the telescope at R . C is a graduated circle, and M a pointer or microscope, by the aid of which the telescope may be elevated to the meridian altitude of

any particular star.

In order that an instrument of this kind may truly sweep out the meridian by its revolution on the axis, $P P'$, three conditions are necessary:—1st. The telescope, or, more correctly, the centre ray of the cone of light formed by the object glass, which is called the line of collimation, or *optical axis* of the telescope, must be exactly at right angles to the axis of revolution, $P P'$, otherwise a circle to the east or west of the true meridian, and smaller than it will be marked out. 2nd. The axis must be perfectly level, or the line of collimation will not pass through the zenith, though it may pass through the north and south points. 3rd. The axis must be placed due east and west, or the telescope will point to the zenith, but not to the pole, and therefore not to the north or south points of the horizon. Three errors, namely, of *collimation*, *level*, and *azimuth*, arise from the non-fulfilment of these conditions; and it is the duty of the practical astronomer to find out these errors and make allowance for their effects; but it does not come within the province of the present work to explain the methods he employs in doing so. We may suppose the transit instrument perfect in its adjustments, the middle wire in its field coinciding with the line of collimation, and sweeping out accurately the meridian of the place of observation.

An indispensable adjunct to the transit is a clock

regulated so that it shall mark twenty-four hours in the time that a star performs its whole revolution from the meridian to its return to it upon the following day. This is rather less than an ordinary solar day—being only $23^{\text{h}} 56^{\text{m}} 4.09^{\text{s}}$ of our ordinary time, and is, in fact, the time taken by the earth in making a complete revolution on its axis. A clock so regulated is said to keep sidereal time, and requires to be so set that it shall mark $0^{\text{h}} 0^{\text{m}} 0^{\text{s}}$ at the moment when the first point of Aries is upon the meridian of the place of observation.

Suppose a clock so set and regulated, and the observer with his telescope is noting the passage of a star across the middle wire in the field,* it follows that the time occupied by the earth carrying the meridian of the observer from the first point of Aries to the star is shown by the clock; and since the earth's revolution is performed with perfect regularity, this is a true measure of the *right ascension* of the star expressed in time. If it is necessary to convert this to ordinary angular measurement in degrees, &c., we have but to multiply by 15, since the twenty-fourth part of the whole circumference, or 15° , is passed over in an hour. In this manner, then, one of the elements necessary to define the position of a heavenly body is found; the arc of the meridian between the star and the equinoctial is perpendicular to that circle, and the distance between the perpendicular and the first point of Aries has been measured by the time taken by the earth's revolution from the one point to the other. We have now only to measure the magnitude of this arc of the meridian to find the declination of the object, and its position upon the celestial sphere will then be known.

The instrument used for this purpose is called the **Mural Circle**.† It consists of a telescope, A A, attached to a brass circle, and moveable with it upon an axis, C, run-

* For greater accuracy, he notes the time of passage over each of the equidistant vertical wires, and takes an average or mean.

† The Mural Circle is an improvement or extension of the mural quadrant, which was invented by the celebrated Tycho Brahé.

ning through the middle of a stone pier. The circle is placed in the meridian, in which plane it revolves, and its rim is very finely divided into degrees and other smaller divisions. Attached to the pier are microscopes, *M M*, usually from two to six in number, which act as pointers to *ascertain* the precise position of the circle.

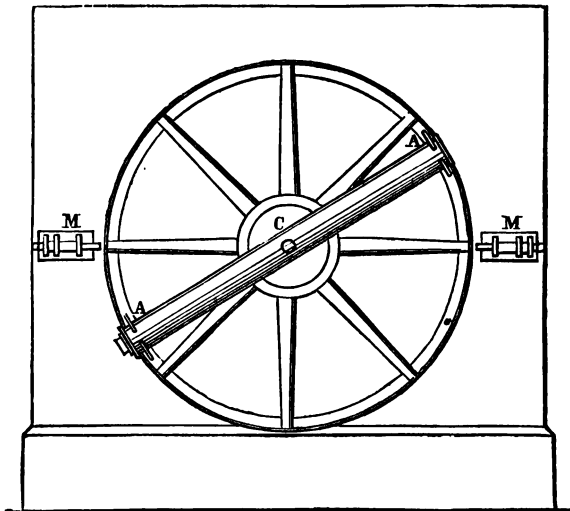

Fig. 9.

The telescope is furnished with a horizontal wire in its focus, along which the star is made to pass, and the reading of the graduated circumference is noted. We have now to find the reading for the equinoctial; and had any conspicuous star been there, permanently marking it, we should only require to treat it in the same way, and take the difference of the two readings, which would be the declination. Instead of this, however, we may take the reading for the pole-star when on the meridian, which, being one of those northern stars that never set, but performs the whole of its diurnal circle above the horizon,

happens, twice each day, once above the pole and once below. Half-way between these two readings will be that for the pole itself, and 90° more will be that for the equator. The difference between this and the reading for the star is the declination of the star.

Observations with the Mural Circle must be corrected for refraction; for which purpose elaborate tables are computed and published for every state of the atmosphere. In the case of planets and other bodies not far removed from the earth, a further correction is added, so that the results from all places upon the earth may be comparable. It is agreed to refer all observations of this kind to the centre of the earth, and to give the declinations as though observed there. The necessity for this will be seen from fig. 10. If S represent the place of a planet or other body, A and B two stations upon the earth, from which observations of it are made,

and M m the sphere of the heavens, the observers at A and B will refer the object to the points F and D respectively. The

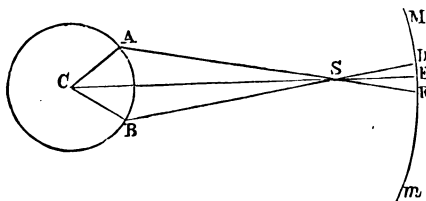

Fig. 10.

radius of the earth, A C, being known, both observers can determine the direction of the line C E, or the position of the object as it would be seen from the centre of the earth. The immense distance of the stars renders such a correction quite unnecessary in their case. This is known as the correction for parallax.

In modern observatories, it is not unusual to see a combination of the two instruments we have described, called a Transit Circle, which determines at once both elements. With either we have the means of measuring the positions of the heavenly bodies, and watching their motions from day to day; but before we refer to any such observations,

it will be advisable to notice briefly one or two other astronomical instruments.

III. EXTRA MERIDIONAL INSTRUMENTS—THE EQUATOREAL.

The principal axis of this instrument is an inverted cone of metal, elevated so that the central line shall be parallel to the axis of the earth, or pointing to the celestial pole, and mounted upon a firm pedestal in such a manner as to be capable of revolving round the central line.* Near the upper extremity it carries a graduated circle at right angles to its length, and therefore parallel to the earth's equator, and in the plane of the equinoctial. Above this it carries a hollow cylindrical axis, also at right angles to the principal or polar axis, and both move round with it. Within this secondary or declination axis, a strong rod revolves, carrying at one end the telescope fixed in a cradle, and at the other a graduated circle. Two motions, at right-angles to each other, may thus be given to the telescope. 1st, It may be revolved round the hollow axis, and be made to point successively to every degree of declination. 2nd, The polar axis may be made to revolve, carrying with it the whole instrument, and making the telescope point to each successive hour of Right Ascension. It may be turned, therefore, to any point in the sky; and if the declination axis is fixed, the simple motion of the polar axis will follow the course of any star throughout its diurnal circle, whether above or below the horizon. This motion being perfectly uniform, it is easy to communicate it to the axis by clockwork, and is generally done with the advantage of leaving the observer quite free to make his observations upon objects for any length of time. The equatoreal is not usually employed in determining right ascensions and declinations, though these may be read off its two graduated circles, but rather the magnitudes, positions, and distances of objects, capable of being seen in the

* Equatoreals are variously designed: that described in the text is known as the Fraunhofer or German Equatoreal.

field of the telescope at one time. Very large telescopes are nearly always mounted as equatorials.

The **Altazimuth**, as its name implies, is used to measure the altitude and azimuth of objects. It is very variously designed, but generally consists of a massive graduated horizontal circle, capable of revolving on its centre, and supporting two vertical pillars, on the summit of which is carried a telescope lightly mounted, in a manner similar to a transit circle. Upon the horizontal circle the azimuth is measured, while the upper vertical circle serves to measure altitudes. Like the equatorial, it turns to all points of the heavens, but is of greater steadiness than it. The results can rarely compete with those of the Transit Circle for accuracy, but in a portable form is of great service in determining the latitude of localities upon the earth's surface.

Reflecting Telescopes.—The telescopes we have hitherto considered are all known as refractors, because the image viewed by the eye-piece is formed by the rays of light being refracted or bent from their previous direction by passing through a lens of dense glass, in obedience to the law explained in Chapter I. As originally constructed of a single lens of glass, they were defective, because the rays of coloured light, which together form white light, are not equally bent in passing through a dense medium such as glass. The images were therefore coloured, and this effect is said to be produced by the *chromatic dispersion* of the lens. Many years afterwards (in 1747), Dollond, a London optician, corrected this fault, by uniting two glasses of different densities to form the object glass. Such telescopes are called **achromatic refracting telescopes**; but before this discovery the attention of Gregory, Newton, and others was turned to devise a telescope upon a totally different plan. The principle of the reflecting telescope depends upon the fact that a concave mirror will form a perfect image of an object, provided the concavity is of the particular form known as a *paraboloid of revolution*. This figure does not differ much from a small segment of a sphere; and the point where the image

is formed is called its focus. Various methods are in use for viewing the image formed there; and hence telescopes are named after the original designers, as the Gregorian, Newtonian, Herschelian, and Cassegrainian reflectors. Fig. 11 is a section of the Newtonian telescope showing, by dotted lines, the direction of the rays of light after leaving the object.

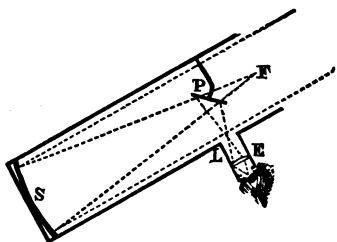

Fig. 11.

by the eye-glass at E. The speculum is of highly-polished metal, but does not reflect all the light that falls upon it, part is absorbed, but the image is free from colour, and in the hands of the elder Herschel almost superseded the refractor. The great telescopes of the Earl of Rosse are of this class; and, owing to the difficulty of polishing large glasses, more light can be collected with instruments of this class. After the discovery of the principle of achromatism by Dollond, refractors again came into favour, and, as instruments of precision, must continue to hold the first place. Quite recently, however, reflectors having glass speculums, upon the surface of which silver is deposited and polished, have come into use, and, from their cheapness and excellence, bid fair—being mounted as equatoreals—to take a high place as extra meridional instruments.

IV. MEASUREMENT OF TIME.

One of the most important uses of the Transit Instrument, apart from the determination of Right Ascensions, is the measurement of time. A day is always understood

to be the interval between the departure from and return to the meridian of any celestial body. Thus, a solar day means the interval taken by the sun; a lunar day, that taken by the moon; and a sidereal day, that taken by a star. The solar day is evidently the most important to mankind in general, because on it depends the regular return of light and darkness, and at once suggests itself as the most obvious and natural unit of duration. The sidereal day is the most invariable unit, because the stars, being fixed and infinitely distant, the interval taken by them is precisely that taken by the earth in revolving on her axis; and this she does with so remarkable a steadiness of motion, that, from the record of ancient eclipses, we are able to discover that the length of the sidereal day has not varied so much as $\frac{1}{100}$ of a second in more than two thousand years. As already stated, this interval is less than the ordinary mean solar day. The sun has an apparent motion in opposition to that of the diurnal revolution of the stars, amounting to very nearly 1° per day; and when the rotation of the earth has brought again upon the meridian the point which was occupied by the sun the day before, that body is nearly a degree to the eastward, and nearly four minutes must elapse before the sun itself comes upon the meridian, and the solar day is completed.

Secondly, the amount of the sun's apparent eastward motion is not the same each day. There are two causes for this:—*1st*, Its actual movement depends upon the earth's motion in her orbit, which is sometimes quicker, sometimes slower; and, *2nd*, It is not performed in the equator, but in the ecliptic, which is considerably inclined to it. The solar day, at different times of the year, is not then of equal length; and if it was used for the ordinary measurement of time, as it was in France before 1816, would lead to much confusion. A *mean* solar day is therefore used; an arbitrary unit obtained by taking the average of all the solar days in a year. The difference between the apparent and the mean solar day is not great—never more than half a minute; but this, accumulating day by day,

makes at times a great difference between the apparent and mean noon. Thus, upon September 1 the mean and apparent noon coincide; but the solar day being at this time shorter than the mean solar day by nearly half a minute, at the end of the month the sun passes the meridian ten minutes before the mean noon arrives. This difference is known as the equation of time, and attains its greatest magnitude about November 1, when the sun is more than sixteen minutes before the clock keeping mean time. On December 24, the sun having been moving faster in the heavens, the mean and apparent noon coincide again, and there is no equation of time on that day; but the sun's motion still continuing fast, on February 11 the sun does not pass the meridian till $14\frac{1}{2}$ minutes after the clock has indicated mean noon. On four days of the year the mean and apparent time agree, and there is no equation of time; twice the sun reaches a maximum in advance of the clock, and twice also behind the clock.

The expression mean sun is often found in astronomical books. By it must be understood an imaginary sun, that in a year shall be found to have moved at the same pace as the real sun, but uniformly day by day, and in the equator; a sun, in fact, that shall always agree with our mean time clocks.

Since the sun is only on the meridian of a given place at a given time, the noon of all places situated east or west of each other must vary, and with it the local mean time of all such places, since noon is its starting point. In Britain the time of Greenwich is *everywhere* kept; but before the introduction of railways the local time at each place was usually kept there. The City of Oxford was the last town of importance to adopt Greenwich in place of local time. In large towns on the continent it is usual to keep the time of the metropolis of the country, but this is not invariable. The difference of longitude of any two places expressed in time (*i.e.*, the ordinary longitude divided by 15) will give their difference of local time, the more eastern station being of course the later.

For a longer unit the duration of the earth's revolution

round the sun is employed. The time that elapses from the moment of the sun leaving a particular star to its return to it is called a **sidereal year**, and is equal in mean solar time to $365^{\text{days}} 6^{\text{h}} 9^{\text{m}} 9.35^{\text{s}}$; or, in sidereal time, to $366^{\text{days}} 6^{\text{h}} 9^{\text{m}} 9.35^{\text{s}}$. A more generally important measure of the length of the year, however, is determined by the time that elapses between the sun's departure from and arrival at the equinox. This is called the **tropical year**. We have already alluded to the fact that the equinox is not a fixed point in the heavens, like a star, and the slow movement of it occasions the year, which depends upon the sun's arrival at this point, to be less than the sidereal revolution of the earth by $20^{\text{m}} 23.2^{\text{s}}$, or to amount to $365^{\text{days}} 5^{\text{h}} 48^{\text{m}} 46.15^{\text{s}}$ of mean solar time. Upon this period depends the return of the seasons, since they commence with the arrival of the sun at the equinoxes and the solstices, and it is therefore the year which it is necessary to employ in framing the calendar. Obviously it is desirable that our seasons should commence upon the same day of the year as they did in the most remote times; and as only a slight error in the assumed length of the year would throw us out considerably after the lapse of some centuries, the arrangement by which an exact number of days are assigned to each year is a matter of much consequence. Previous to the time of Julius Cæsar (B.C. 44) much uncertainty prevailed in this respect; but, as arranged by him, the year was to consist of 365 days, and every fourth year was bissextile, or consisted of 366 days. This amounted to assuming the tropical year equal to $365\frac{1}{4}$ days; but since it is not so much as this by fully 11 minutes, the calendar is not sufficiently accurate. It was found that from the time of the Council of Nice (A.D. 325), when Easter was ordered to depend upon the vernal equinox, to the time of Pope Gregory XIII. (A.D. 1582), the Julian calendar had lost ten days, or the vernal equinox, and with it the seasons were ten days earlier in the year in A.D. 1582 than they were in A.D. 325. Pope Gregory corrected the error by advancing the date ten days, and decreed that

the first year of every century, unless divisible by 400, should be an ordinary year of 365 days, instead of a leap year. This arrangement so very nearly agrees with the length of the tropical year that the seasons now retreat only one day on the calendar in four thousand years, which is sufficiently near the truth for all practical purposes. Even this may be corrected, if it is deemed necessary, at the expiration of that interval.

The improved or Gregorian calendar was not introduced into England until the year 1752, at which time the seasons had advanced eleven days on the Julian calendar. Subsequently the reckoning is known as the New Style, in opposition to the Julian or Old Style; and to convert the Old into the New it is only necessary to add eleven days to the date. Thus, 1749, April 12, O.S., is equivalent to 1749, April 23, N.S. The beginning of the year was, however, at the same time altered from March 25 to January 1, so that to convert Old Style into New, when the date falls between these, it is necessary to add one year also; thus, 1748, February 5, O.S., is equivalent to 1749, February 16, N.S. In Russia the Julian calendar is still in use, the difference being now twelve days.

QUESTIONS.

1. What is meant by the term co-ordinates?
2. Explain the terms zenith, nadir, altitude, and azimuth.
3. Why are the co-ordinates having the horizon as a fundamental plane generally unsatisfactory?
4. What is the equinoctial? Explain the terms declination and right ascension.
5. What point is used as the origin of right ascensions, and of what great circles is it the intersection? Is it a fixed point?
6. Describe the apparent motion of the sun among the stars. What is the ecliptic?
7. Over what parts of the earth is the sun vertical at the solstices, at the equinoxes? Explain these terms.
8. What is meant by astronomical longitude and latitude, and for what are these co-ordinates principally used?
9. Explain the terms meridian, hour angle, first point of Libra, obliquity of the ecliptic, solstitial colure, equinoctial colure.
10. With what instrument are right ascensions determined? Describe it. By whom and when invented?

11. Explain the construction of the astronomical telescope.
12. What are the conditions under which a transit instrument will revolve accurately in the meridian?
13. To what errors is the transit instrument subject from improper adjustment?
14. Explain what is meant by sidereal time. When a sidereal clock marks noon, what point is on the meridian?
15. Describe the mural circle. For what purpose is it used?
16. How may the circle reading of the equinoctial be found?
17. What corrections have to be made to mural circle observations?
18. Describe the equatoreal. What are the directions of its two axes? What advantage is derived from the elevation of the polar axis?
19. Describe the altazimuth. What are its advantages over the equatoreal? For what purposes is it mostly used?
20. What is chromatic dispersion, and from whence does it arise? How is it overcome?
21. State the principle of reflecting telescopes. Describe the arrangement of mirrors in the Newtonian reflector.
22. What is meant by a day? What is a sidereal day? a solar day? Why is the solar day longer than the sidereal?
23. Why is the solar day an unsatisfactory unit of time? Explain the reasons of the variation in the length of the solar day.
24. What is a mean solar day, and how often in the year does mean solar time and apparent solar time coincide?
25. Give the greatest differences between mean and apparent solar time, with the days on which they occur.
26. What is the equation of time, and what is meant by the term mean sun?
27. Give the cause of difference of local mean time, and the rule for finding the local time at any place whose longitude is given.
28. What is meant by a sidereal year? What is its duration in mean time? in sidereal time?
29. What is meant by a tropical year? Give its duration. Why does it differ from the sidereal year?
30. Explain the Julian calendar, and give the reason of its inaccuracy. By whom, how, and when was it corrected?
31. Explain the new and old style, and the mode of converting the one to the other.

CHAPTER III.

I. LAWS OF PLANETARY MOTION.

A careful scrutiny of the heavens for a number of nights reveals the fact that there are other bodies than the sun having independent motions. The moon in only a few hours shows a very rapid and palpable movement, and a few bright objects, which we call planets (*πλανήτης*, a wanderer), are also detected to have very considerable motions of their own. If we confine our attention at present to the planets, we shall find their movements very various and intricate. Venus and Mercury will be found always near the sun, sometimes on the east, sometimes on the west of him. Ordinarily they are seen travelling in the same direction as the sun, or in opposition to the diurnal movement of the stars. This is called direct motion. At times they become stationary, and then turn back in the opposite direction, at which time their motion is called retrograde. Again, they will become stationary, and afterwards resume their previous direct motion. The other planets, Mars, Jupiter, and Saturn, which are conspicuous objects, will be seen to have similar motions, though they do not remain in attendance upon the sun. The five planets already mentioned were known to the ancients, who watched their motions with great interest, and formed numerous explanatory theories. In spite of all their ingenuity, and their intricate systems of epicycles and differentials, their theories would not agree with the observed planetary motions. They were entirely vitiated by one erroneous assumption. The magnitude and importance of the earth to themselves, led them always to fix upon it as the centre of the universe, around which moved the sun and planets with the most intolerably complicated movements. The system

which endeavours to explain these motions, on the supposition of the earth being fixed, and the centre of their revolutions, was invented by Hipparchus, but is generally known as the Ptolemaic system, after the celebrated astronomer who advocated it; and the difficulty of propagating any other, in the face of the popular ideas, caused the most profound darkness to prevail for many centuries. Pythagoras, it is true, and one or two others of the ancients, are known to have held more correct notions, but were unable to impress them upon their disciples. Early in the sixteenth century, Nicholas Copernicus, a monk of Thorn (Polish Prussia), revived the theory of Pythagoras by placing the sun in the centre of the universe, with the planets and the earth revolving round him; but though he thereby considerably simplified the theory, and had hit upon the true explanation of the complex planetary motions, he could not account for them accurately without some remnants of the old Ptolemaic theory. But very shortly after his time observational astronomy advanced rapidly, and the laborious life-long work of Tycho Brahé, together with his ingenious methods of observation, put it in the power of his successor, Kepler, to devise a theory which should rigorously account for the motions of the planets. Gifted with the most daring imagination and unwearied energy, this illustrious philosopher tried every possible assumption upon which to explain the positions of the planet Mars, as observed by Tycho and himself, upon the theory of a central sun with circularly revolving planets, but without success. For seventeen years he laboured, and finally found it possible to account for all the motions of the planets upon the supposition of their being governed by three simple laws, which we now know to be the true solution of this most troublesome problem. They are known as Kepler's laws, and are as follows:—

1st. *The planets revolve in ellipses around the sun, of which it occupies one of the foci.*

All the previous endeavours had aimed at the explanation of the phenomena upon the assumption of uniform motion in circular orbits. Next to the circle the ellipse is

the simplest geometrical figure. It is obtained by cutting a cone in a direction oblique to its base, and may be defined to be an oval figure, within which are two points, called foci, the sum of whose distances from any point in the curve is always the same and equal to the longer axis. From this will be understood the ordinary method of describing an ellipse—namely, to fasten the extremities of a loose thread to a board, and describe a curve with the string always stretched by the pencil.

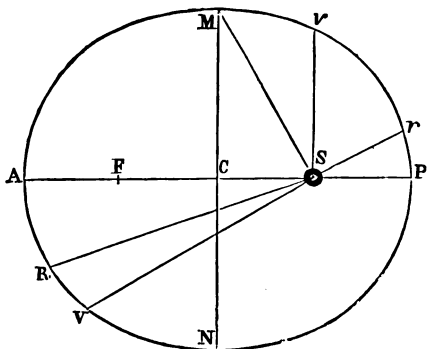

Fig. 12.

Fig. 12 represents the orbit of a planet. S, the sun situated in one of the foci. F is the other or unoccupied focus of the ellipse. A P is called the major, and M N the minor axis. P, the point at which the planet is nearest to the sun, is called the perihelion of the orbit. A, the point where it is most distant, is called the aphelion. Any line joining the sun to the planet, as S R, S V. is called the radius vector of the orbit. C is the centre of the ellipse, and C A the semi-axis major, or mean distance. The eccentricity of an ellipse is its deviation from a circle, and is expressed by the ratio of C S to C P. In the case of the planets, the eccentricity is very small, the orbits not differing much from circles. The angle, C M S,

called the **angle of eccentricity**, is likewise small.* The line A P, which is the major axis of the ellipse, is frequently called also the **line of apsides**. The angular distance of a planet from perihelion is called its **true anomaly**, and that of the point it would have reached with uniform motion its **mean anomaly**. The difference between them is the *Equation of the Centre*.

2nd. Kepler's second law, which is also known as the law of **conservation of areas**, is usually enunciated in the following terms:—*The radius vector in any orbit sweeps over equal areas in equal times*. If, then, the areas S R V (fig. 12), S v r, and M v S are equal to one another, it follows from this law that the planet will describe the arcs R V, v r, and v M in equal periods of time, and that hence its velocity is greater according as its distance from the sun is less. We have thus the means of tracing the position of a planet in its orbit; but it must be remembered that the areas swept over by the radius vector of one planet have no relation to those of another planet, which may be either greater or less.

The 3rd and most important law of Kepler, has reference to the periodic times and the distances of the planets from the sun. He discovered that the *squares of the times of revolution of any two planets have the same proportion to each other as the cubes of their mean distances have*; from which it follows that, having once found the distance of any one planet from the sun, a simple proportion will enable us to find the distance of any other. As enunciated above, this law is not strictly true, but very nearly so, owing to the mass or weight of the planets being almost inappreciable by comparison with that of the sun.

The same law regulates the times and distances of moons or secondary planets; but these are not always insignificant in comparison with their primaries, and their mass requires to be taken into account in the calculation. The first and third of these laws are consequences of the

* M S being equal to C P, the eccentricity $\frac{C S}{C P}$ is the natural sine of the angle of eccentricity, C M S.

universal law of gravitation, which we shall explain in the next section; the second has been proved by Newton to follow from the simple laws of motion, having no connection with the theory of gravitation further than proving the sun to be the centre of attraction for each of the planets.

To complete our view of planetary orbits, we have only to add that they lie very nearly in the plane of the ecliptic, yet a little inclined to it, and hence the planets are always found in a narrow zone of the heavens, known as the **Zodiac**. Fig. 13 is a perspective view of the orbits of the Earth and Venus, from which it will be seen that the

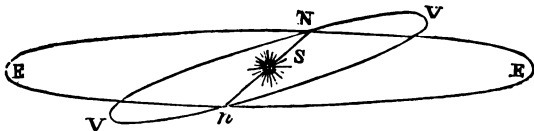

Fig. 13.

orbit of Venus cuts the plane of the earth's, or the ecliptic, at two points, N n . These are called the **nodes** of the orbit. At one of them Venus will rise from the south to the north side of the ecliptic—hence called the **ascending node**; at the opposite point the reverse will happen, and it is therefore called the **descending node**. The line joining the nodes, which necessarily passes through the sun, is called the **line of nodes**.

The various parts of an elliptic orbit having now been described, we are in a position to point out what it is necessary to know in order to follow the motions of a planet in her orbit, or in the heavens. *1st.* The form and magnitude of the ellipse must be known—that is to say, its eccentricity and the length of the semi-axis major. *2nd.* The position or longitude of the planet must be known at some particular time, and its mean daily orbital movement. *3rd.* The position of the plane in which the orbit lies must be known—that is, its inclination to the ecliptic, and the longitude of the ascending

node; and, 4th. The position of the ellipse in that plane must be known, or the longitude of the perihelion. These are called the elements of the orbit; and once found, the position of the planet can either be calculated in advance or carried back into the past.

II. OF THE UNIVERSAL LAW OF GRAVITATION.

Although it would be possible, by the aid of Kepler's laws alone, to follow the movements of the planets pretty closely, yet, being derived as they are from observation, they afford us no information as to the principle that gives them birth. They do not explain why the planets move in ellipses, nor why the distances and periodic times of the planets should bear such a relation to each other as they do. They are not, in fact, of that simple and ultimate character in which it is usual to find the laws of nature capable of being expressed. Newton was first led to conjecture whether the attractive force that keeps the moon in her orbit round the earth, might not be the same as that which causes all bodies on the earth's surface to tend towards her centre. This force, which we call **gravitation**, we know extends to the greatest altitudes which it is possible for us to reach; and since there is no reason why we should set a limit to its power at any definite distance from the surface of the earth, it is feasible to suppose that it may possibly extend as far as the moon. The revolving motion of the moon in her orbit must generate a centrifugal force; and there must always be in consequence a tendency in the moon to fly off in the direction in which she is at the moment travelling, or of the tangent to her orbit. This is in obedience to the first law of motion, which states that if a body be put in motion in any direction it will continue to move for ever in that direction, and with the same velocity, in a straight line, unless deflected from it by the action of some other force. Now, to measure the moon's distance is a very simple question, as we shall see shortly; and it was well known by Newton to be sixty times the

earth's radius. Its time of revolution was also known, so that the amount of centrifugal tendency was calculable. The moon, however, does not move in a straight line, a tangent to her orbit; and it is therefore clear that there must be some other force precisely equal in effect that continually draws her towards the earth; because if this attraction of the earth were less than the centrifugal tendency, the moon would increase her distance; and if greater, she would be drawn towards the earth. The amount of the attractive force that the earth is constantly exerting on the moon is expressed by the distance through which the moon is drawn from the straight line in any given time. This is agreeable to the second law of motion, which is to the effect that, when two forces are acting upon a body so as to produce motion, the body will be found, after a given interval, at that point which it would have occupied supposing each to have acted upon it separately. Thus, in

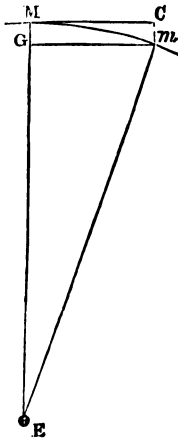

Fig. 14. of time. In this way Newton found that, supposing

figure 14, if MC represent the distance which the moon would travel in a given time, supposing gravity to have no effect, and MG the distance through which the moon would be drawn by the effect of gravity, supposing it to be acted upon by no force impelling it in any other direction, then the point it will actually reach in the given time, both forces acting upon it, will be the point m , after describing the arc Mm . Cm being equal to MG measures the amount of the attracting force of the earth, which may be found in feet, and compared with the force of gravity at the earth's surface—i. e., with the distance through which a stone would fall near the surface in an equal period

gravity to be the force that deflects the moon from C to m , and counteracts the centrifugal tendency of the moon, forcing it into a curvilinear orbit, it must be enfeebled by the distance of the moon to $\frac{1}{3600}$ part of what it is at the surface of the earth, or that it diminishes in the same proportion as the square of the distance ($3,600 = 60^2$) increases. Nor is this an extraordinary result, because both light and heat, which are natural emanations from a centre, do diminish with distance in this precise proportion; and analogy would lead to a similar supposition in the case of gravity.

Now, supposing this to be the rate of diminution of the force of gravity, it is necessary to show that Kepler's laws flow from it before we can assume that the actual force which retains the planets in their orbits is none other than gravity. This Newton has done by proving, first, that the motions of all bodies must, under the law, as he has enunciated it, be some one of the curves known as conic sections.* In other words, that bodies moving round the sun must either move in a circle or an ellipse, of any degree of eccentricity, or they may follow the curves known as the parabola and the hyperbola, in which last cases they do not return to the sun after having once passed round it. Of each of these curves we find examples in the Solar System. The planets revolve in ellipses of small but various eccentricities, while some comets have elliptic orbits of very great eccentricity. The satellites of Jupiter revolve in circles. The majority of comets move in parabolic orbits, while in some the hyperbola is the form assumed.

* The four curves—the circle, parabola, ellipse, and hyperbola—are called conic sections, for the reason that when a cone is cut by a plane surface, other than through the apex, the boundary of the intersection will be one or other of these curves. If the cone be cut parallel to the base, the section will be a circle; if cut obliquely parallel to the side of the cone, the section is a parabola. If the cone is cut across in any other direction than parallel to the base, the boundary will be an ellipse; and in every other section, as perpendicular to the base, for example, the form of the boundary will be a hyperbola.

He further proved that the law of the distances and the periodic times would be a consequence from the extension of gravitation under this form to the planets; while the second of Kepler's laws he proved to follow likewise, without the application of the particular ratio of diminution which gravity follows. He was therefore led to give the widest signification to this law, which we will now state in its fullest application :—

Every particle of matter in the universe attracts every other particle, with a force varying directly as the mass of the attracting particle, and inversely as the square of the distance between them. From which it will be seen that, should the earth from some cause be increased to twice its weight or mass, then the force of gravity which it exerts upon the moon would be increased twofold; or, further, should its mass remain the same, and the distance of the moon be reduced to one-half its present distance, then the force of gravity exerted by the earth on the moon would be *four* times what it now is.

That the true secret of the planetary motions was penetrated by Newton, and is expressed in the few simple terms above, does not rest alone upon the explanation which it affords of the origin of the Laws of Kepler, but in its wide application to the whole theory of the heavenly motions. Every slight deviation from a strictly defined ellipse must be explained as some effect of the general application of the Newtonian law; and should it fail in any single instance, it would at once fall to the ground. It has been found, however, perfectly sufficient to explain every movement and every minute variation, while some slight deviations have even been first detected by theory, and afterwards confirmed by observation. Newton was fully alive to the wide consequences of this extensive generalization. If the earth attracts the moon, it in its turn also attracts the earth; while the sun attracts both with an ever varying force, conforming to their ever changing distances. The planets also disturb the earth and her moon, which also disturb them in their movements. In this manner *very* many minute disturb-

ances arise affecting every member of the Solar System, called perturbations, and it often requires the highest powers of the mathematician to trace these to their sources and to calculate their amounts. Of some of the more important of these we shall treat in a later chapter.

There are one or two points to which we must call the student's attention before leaving this part of the subject. First, that the attraction of spheres—and the earth is very nearly, though not quite, a perfect sphere—is precisely the same as if all the matter composing it had been collected at the centre, and we are therefore situated at a distance of the earth's radius from the centre of attraction. This fact was likewise proved by Newton, and it explains why any altitude which we can reach makes no appreciable difference in the effect of gravity; for we can only add a very small fractional part of the earth's radius to our present distance from the centre of attraction. Secondly, that since the earth does deviate slightly from a strictly spherical form, the direction of the plumb-line, which is towards the centre of attraction, differs by a small amount from the direction of the earth's centre.

Thus, in fig. 15, we have the elliptic form of the meridian circle greatly exaggerated to show this difference. HO , the tangent at the point A , is the observer's horizon; Z is therefore his zenith; and AZ the direction of the plumb-line. AZ' is the prolongation of the radius of the

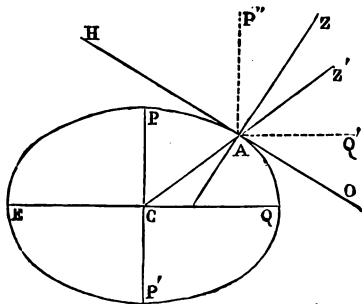

Fig. 15.

The small angle, $Z'AZ$ —the deviation of the plumb-line from the direction of the earth's centre—is called the angle of the vertical. At the

equator, or at the poles, there is no such angle, and it is always small, owing to the near approach of the meridian to a circle. In the latitude of Greenwich, it amounts to only $11\frac{1}{4}$ minutes of arc. AP'' being the direction of the celestial pole, and AQ' of the equinoctial, the angle ZAQ' is the apparent or geographical latitude; Z' being the geocentric zenith, the angle $Z'AQ'$ is the geocentric latitude; their difference being the angle of the vertical at the point A . Thirdly, that in an elliptic orbit, the motion being greatest when the planet is in perihelion, or nearest the sun, the centrifugal force is greatest also, and the greater attractive force of the sun is as much counterbalanced at that point as at any other; while the great velocity acquired after passing perihelion enables the planet to draw away from the sun—a fact which some people have difficulty in apprehending. This balancing of forces is the great element of stability in our system; for, should any accident increase the sun's gravity, it would merely force the earth and other planets into different orbits, and in no way tend to precipitate them upon the sun. Lastly, that treating the earth as we have already treated the moon, by computing its centrifugal force in its orbit round the sun, we have the means of weighing that body against ourselves; but in order to do this it is necessary that we should be acquainted with the distance of the sun from the earth—of which problem we shall treat in the ensuing section.

III. PARALLAX.

The term *parallax*, as used in astronomy, implies the difference in the direction of an object as seen from two different points, without defining what those two points are. We have seen that the correction for terrestrial parallax in mural circle observations is a quantity varying with the distance of the object and its altitude, subtracted from the zenith distances of all objects not infinitely remote, in order that the results may be such as would have been obtained at the centre of the earth, supposing it possible

to have a mural circle stationed there, the point to which all the observations of the various observatories are referred. The distance of the moon is found in a very simple manner. Two observatories, duly supplied with mural circles, are selected as nearly as possible in the same meridian, but differing greatly in latitude—as Greenwich and the Cape of Good Hope. If $G E C$ (fig. 16) represent the

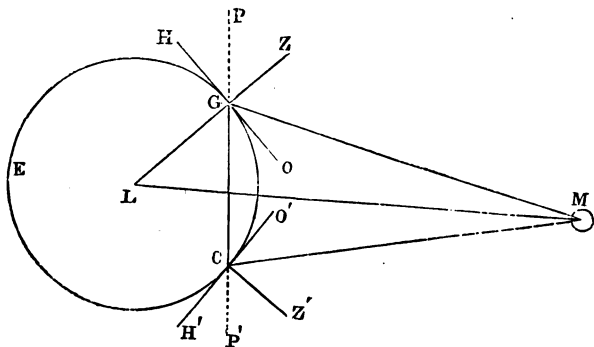

Fig 16.

earth, G and C being the selected stations, GP and CP' , the elevation of the north and south pole of the heavens at either station; then, if the moon, M , were infinitely remote, the sum of the angles, PGM and $P'CM$, the polar distances as measured at the two stations (cleared of refraction), would be two right angles, or 180° ; but the moon being comparatively near, their sum will exceed 180° by the angle GMC ,* which is the parallax of the moon at the station G (viz., LMG), together with the parallax at station C (viz., CLM). The proportion of the excess, or the parallax at each station, must then be assigned; and hence the value of GM , of LM (altitude of moon at $G + 90^\circ$), and the radius LG are known. The length of the side, LM , or the distance of

* If the stations are not on the same meridian, a correction must be made for the change of Polar Distance of the moon while passing from the one meridian to the other.

the centres of the earth and moon, will be found by the application of the principles for the solution of triangles.

It will be seen that parallax must be greatest when G M coincides with G O, or when the object is on the horizon; it will further be slightly larger if L G is an equatorial radius, so that the *equatorial horizontal parallax* is the maximum parallax. At the moon's mean distance this amounts to $57' \cdot 2'' \cdot 33$, corresponding to an average distance of $60\frac{1}{4}$ times the equatorial radius of the earth, or about 238,851 miles.

When the parallax of an object is mentioned apart from any particular place or altitude, the maximum or equatorial horizontal parallax is to be understood—that being, in fact, none other than the angle which an equatorial radius of the earth subtends at the distance of the object; and if it is found, the distance of the object in miles is obtained by the solution of a right-angled triangle, of which all the angles and one side (*viz.*, the earth's radius) are known. Indeed, astronomers rarely express distances in miles, the equatorial horizontal parallax being much more simple and easy to deal with, while the actual distance is so readily found from it, if wanted.

To obtain the parallax and distance of the sun is a problem of greater complexity, and for a long time baffled the earlier astronomers, so that even Kepler, who knew accurately the relative distances of all the planets from the sun, was quite ignorant of the actual distance of any one of them. It might have been obtained in a similar manner to that of the moon; but the solar parallax is so small an angle, and the heat of the sun has such a disturbing effect upon atmospheric refraction, that the result would be very far from reliable. Another method which was known to the ancients, and even attempted by Aristarchus of Samos, would have led to a fairly accurate result, had the moon's surface been less rugged than it is. It consists in measuring the angular distance between the centres of the sun and moon at the time when the latter is *dichotomized*—that is, when exactly one-half of it is illuminated by the sun. At this moment the line joining the earth and moon must

form, with that joining the moon and sun, an exact right angle (see fig. 17); and if the distance of the moon is known, and the angle between the sun and moon as seen from the earth (viz., MES), measured, we have all that is necessary to solve the right-angled triangle, MES , and to find the sun's distance, ES .



Fig. 17.

But since both these methods fail, we are obliged to take advantage of the phenomenon of a transit of the planet Venus across the sun's disc, which happens occasionally at rare intervals. It will be seen from fig. 13 that if the earth happens to be at the point n of her orbit, when Venus is at or near her node, the planet will be seen projected as a black spot upon the sun, the three bodies being in a straight line. The same may happen at the opposite node, but at no other position in the orbit of either. This occurred in 1761 and 1769, and will occur again in 1874 and 1882. The intervals being alternately 8 and $105\frac{1}{2}$ years, and 8 and $121\frac{1}{2}$ years, transits will not take place after 1882 till the years 2004 and 2012. The reason why there are two transits at a short interval is, that thirteen revolutions of Venus are very nearly equal to eight revolutions of the earth; and hence, after eight years, the planets occupy nearly, but *not quite*, the same positions with reference to the nodes as at first. Yet, after the lapse of eight years more, Venus will be too far from the node for a transit to take place, and a long interval elapses before the planets are similarly situated at the opposite node.

If a transit is viewed at two widely distant places on the earth, whose distance will be known from its dimensions, the planet will be seen to occupy different positions on the sun's disc. Let C and F (fig. 18) be the two stations, supposed, for the sake of simplicity, to be situated at opposite extremities of the earth's diameter, and V the planet Venus, the points at which Venus will be seen projected upon the sun are c and f respectively,

the transits taking place along the lines $c'c''$ and $f'f''$. The duration of the transits or other means may be employed to measure the breadth of the zone, $c'c''f'f''$, or the line cf . Now, from Kepler's third law, we know

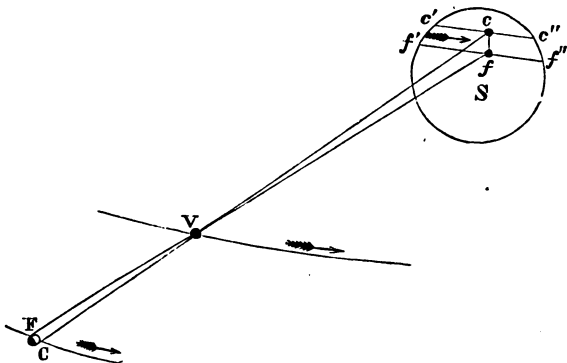

Fig. 18.

the ratio of the distances of Venus from the earth and sun to be that of 28 to 72; and since the ratio between CF and cf will be the same, the actual length of cf is found in this manner, being $\frac{72}{28}$, or nearly $2\frac{1}{2}$ times the earth's diameter, or five times its radius. The angular measure of the radius of the earth at the distance of the sun is the solar parallax, and the angular measure of cf is, therefore, five times the parallax. Hence the distance of the sun is at once found.

Observations were made for this purpose at the suggestion of Halley in 1761, and more successfully in 1769. From the latter observations a parallax of $8''.5776$ was determined, corresponding to a mean distance of 95,300,000 miles. Since that date this has been assumed, not only as the distance of the sun, but as the scale by means of which, and Kepler's third law, the whole of the dimensions of the solar system, the moon excepted, have been assigned. Great suspicion has been thrown upon this value, how-

ever, of late years, for various reasons; and it is now supposed that certain physical appearances that are seen at the transit of a planet have caused an error in the interpretation of the observations then made, so that the estimation is not so accurate as it was supposed to be. The observations in 1874 and 1882 will finally settle this point; but in the meantime observations have been made upon the planet Mars (in 1862), whereby its parallax has been determined similarly to that of the moon. Again, employing Kepler's law, we obtain a knowledge of the sun's parallax; and the result, $8''\cdot94$, agrees closely with that of the observations of 1769, interpreted as we now believe they should have been. The mean distance of the sun from this evaluation of its parallax is 91,430,230 miles; and this is to be held provisionally as the nearest approach to a solution of the question, until the observations of 1874 and 1882 have finally determined it.

As the earth's diameter was too small a base line with which to measure the sun's distance without the interposition of the planet Venus between them, so is it infinitely too small to aid us in obtaining a knowledge of the parallax of the fixed stars. We are therefore driven to seek a longer base line; and it is found in the diameter of the earth's orbit, the extremities of which the earth occupies after the lapse of half a year. Hence arises the term **annual parallax**, by which is meant the change of position of a star consequent upon the translation of the observer from one part of the earth's orbit to its opposite point, a distance of 183,000,000 miles. Notwithstanding this immense base, the annual parallax of the stars is excessively minute, and is hidden or masked by various other changes of position. Two of these, called precession and nutation, are caused by perturbation, and will be treated of in their proper place; the third is the aberration of light. It was first detected by Bradley, in 1727, while endeavouring to solve the problem of the annual stellar parallax. The results of modern researches on this point will be stated when we come to speak generally of the stars.

IV. THE ABERRATION OF LIGHT.

The discovery that light is not propagated instantaneously, but occupies a measurable time in passing from one point to another, was made by Roemer, a Danish astronomer, in 1675. Its velocity is very great; and though that of the earth in her orbit is only $\frac{1}{10,000}$ part as great, it is yet sufficiently rapid to be comparable with it. These two motions give rise to the phenomena of the aberration of light. If a hollow tube, open at either end, be carried along in a vertical position, and a drop of water is allowed to fall into it, the effect will evidently be that the water will strike the side of the tube. If we desire the water to pass through the tube while it is in motion, it is necessary that the tube be inclined more or less, according to the velocity of its motion, *in the same direction as it is travelling*. Though the direction in which the water falls is truly vertical, yet, if the eye of the observer should, insensibly to himself, be carried along with the tube, he would attribute to it the direction of the tube. Let us now apply this simple experiment to the light of a star, at or near the pole of the ecliptic, coming to the earth, and whose light therefore shines at right angles to the plane of the earth's orbit. The tube of the observer's telescope is being carried rapidly round in an ellipse along with the earth. It is so directed that the light of the star passes down it, and therefore it is inclined a little in the direction that the earth is travelling. It will not point to the true position of the star, but a little in advance towards the point to which the earth is tending. Yet our knowledge of the direction of the star is obtained from that of the telescope, and we are thus misled to an extent depending upon the relative velocities of the earth and of light. The star always appearing in advance of its place, in the course of the year it is seen to move in a minute ellipse, similar to that of the earth's orbit—its true place being in the centre of that figure. All the stars have a precisely similar movement; but as they are more and more removed from

the ecliptic poles—that is, as their latitudes are less—the ellipses they describe are more and more compressed, consequent upon perspective or foreshortening, while on the ecliptic they are found to oscillate along a line on either side of their true place. The length of this oscillation, and of the major axes of the minute ellipses is the same, and is equal to $40''\cdot89$. Corrections have therefore to be applied to the observed position of all stars depending upon the time of the year—that is, upon the direction in which the earth is travelling—in order to reduce them to their true places, or the position in which they would be seen if the earth were at rest. The existence of this phenomenon is almost the only *physical* proof we have that the earth is actually revolving round the sun, and not the sun around it.

An aberration precisely similar is produced by the rotation of the earth on its axis; but this motion is so slow, compared with the velocity of light, that the amount of the correction is very small. A little consideration will show that it can only affect right ascension observations. It is known as the correction for diurnal aberration.

Another fact is closely connected with this. The light of any object which reaches us must have been emitted from it some time earlier; and if the body is a member of the solar system, it will have moved sensibly in the time that the light was travelling to the eye. Thus the sun's light requires about $8^m\ 17\cdot83^s$ to reach the earth when at its mean distance, in which time the sun would move $20''\cdot445$, which is also the *semi-axis* major of the minute ellipses described by the stars. The time of light passing to the earth from any object is generally called the *aberration time*; but Sir J. Herschel calls it the *equation of light*, to distinguish it from aberration properly so called. The correction may be made either by adding the movement of the object in the time to the observed place, or by supposing the observation made earlier by the amount of the aberration time,

QUESTIONS.

1. What is meant by direct, and what by retrograde motion?
2. What is the Ptolemaic system, and in what does it differ from the Copernican?
3. How came the latter to be firmly established as the true theory?
4. State Kepler's first law. Define an ellipse, and state what is understood by the focus of an ellipse.
5. Define the terms perihelion, aphelion, radius vector, line of apsides, eccentricity, angle of eccentricity, mean anomaly.
6. Enunciate Kepler's law of the conservation of areas.
7. Explain the law relating to the periodic times and the distances of the planets.
8. Explain the terms zodiac, ascending node.
9. What is the first law of motion?
10. What balances the force of gravity acting on the moon, and what would happen if the earth's force was increased?
11. State the second law of motion.
12. State what measures the attractive force of the earth upon the moon. What on a stone near its surface? Compare the two.
13. To what curves are the motions of bodies confined by the law of gravitation? Give examples.
14. What is meant by perturbations? Whence do they arise?
15. State the law of gravitation as enunciated by Newton.
16. In what manner does the mass of particles composing a spherical body act?
17. What is meant by the angle of the vertical and geocentric latitude?
18. Define the term parallax.
19. Explain the method of measuring the lunar parallax.
20. What is meant by equatorial horizontal parallax? What is its mean amount in the case of the moon?
21. How is the distance of an object found from its equatorial horizontal parallax?
22. Why is not the sun's parallax found in the same way as the moon's?
23. Explain the method attempted by Aristarchus. What was the base line employed by him?
24. When may transits of Venus occur? Give the intervals of their occurrence. Why do they not happen every eight years?
25. Explain how the sun's parallax is determined from this phenomenon.
26. State the result of the observations at the last transit of Venus.
27. How have we determined the sun's distance since then? With what result?
28. What is meant by annual parallax of the fixed stars?

29. Explain the aberration of light, and trace its effect upon stars in different (celestial) latitudes.

30. What is the maximum displacement of a star from aberration?

31. What is diurnal aberration?

32. What is meant by the time of aberration, or the equation of light?

33. What time is occupied by light coming from the sun? How much will the sun have moved in the interval?

CHAPTER IV.

I. THE SOLAR SYSTEM.

By the term solar system is included the sun and all the bodies revolving round him ; planets with their attendant moons ; comets, whether revolving in elliptical or parabolic orbits, as well as meteoric streams. The primary planets are eight in number—Mercury, Venus, the Earth, Mars, Jupiter, Saturn, Uranus, and Neptune, together with the group of small planets or asteroids between Mars and Jupiter, which at present (1872) number 125 known members. Planets are divided into two classes—namely, *inferior* planets, which include Mercury and Venus, whose orbits are interior to that of the earth ; and *superior* planets which include all those whose orbits are exterior to the earth's. The inferior planets never depart from the sun more than a moderate distance, which is called their eastern and western elongations. Venus extends her excursions to 47° east or west of the sun, while Mercury is confined to 29° . They never come into *opposition*,* as the other planets do, but have two *conjunctions*, which are distinguished as the superior and inferior conjunctions. In the first case the planet is on the side of the sun removed from the earth, and in the latter between the earth and sun. To show this, suppose S to be the sun, P M C the orbit of an inferior planet, and E the earth. The points M and F are those of the inferior and superior conjunctions respectively, and P and C the positions of the planet at its eastern and western elongations.

* The term opposition implies the position of a planet when distant in longitude from the sun by 180° , or when it passes the meridian at midnight. A planet is in conjunction when it has the same longitude as the sun, or passes the meridian at the same time as it.

The interval of time that elapses between two successive similar conjunctions of an inferior planet differs considerably from its sidereal period, or the actual time taken in completing its orbit round the sun. If fig. 19 represents the orbit of Mercury, it is plain that when Mercury has passed round from M, through C, F, and P, the earth will

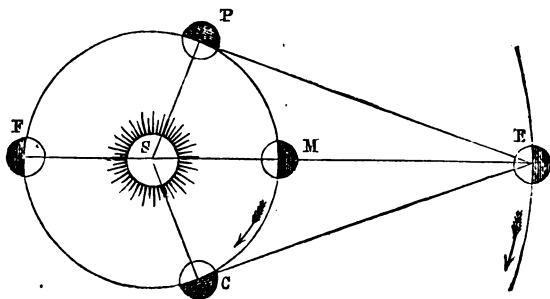

Fig. 19.

have moved in its orbit from E, and Mercury will not again come into conjunction until she arrives at some point between C and F, where the conjunction must take place—the earth having performed so much of her orbit as to be in the same direction at the time. This period is called the **synodical revolution** of the planet, and of course governs the elongations precisely as we have explained it to do the conjunctions.

A further peculiarity of inferior planets is, that they exhibit phases similar to those of the moon. The reason of this is sufficiently explained in fig. 19. At inferior conjunction, M, the unlightened part of the planet is wholly turned towards the earth; when at the greatest elongation, C, one-half of the enlightened part will be seen from the earth; while between these points the planet will be gradually increasing the breadth of its crescent form. Between C and F a still increasing amount of the

enlightened part is turned towards the earth, and the planet will be seen to be *gibbous*—*i.e.*, more than half moon—till at superior conjunction the whole will be seen. After this the form will decrease by similar degrees to the inferior conjunction. At the same time that it varies its form, it varies also its apparent size. Being most distant from us at superior conjunction, its diameter is then the smallest; and when near the earth at inferior conjunction, and a very thin crescent indeed, its apparent diameter will be much more considerable. In this manner, the diameter of Mercury varies from $4\frac{1}{2}''$ to $13''$, and of Venus from $10''$ to $66''$. Mars alone, of the superior planets presents any phase, but is never less than gibbous.

Another classification has been proposed, namely, to group together the four nearest planets, which have numerous features in common, and the four most distant, which likewise have distinctive characteristics. These two groups would be separated from each other by the asteroids, which, from their minuteness and number, form a group of themselves. The four interior planets are all of moderate size, and, as we shall see, of considerable density, averaging about five times that of water. They all revolve on their axes in periods nearly the same as the earth (24 hours), and are unaccompanied by satellites, with but one exception, the earth. The four exterior planets, on the contrary, are bodies of very great bulk, but of little density, scarcely averaging that of water. They revolve on their axes, with much greater rapidity, in about 10 hours, and they all have one or more satellites. In some respects, therefore, this classification appears preferable.

The distances of the planets from the sun has suggested a curious empirical law, which, until the discovery of Neptune, expressed those distances with some degree of accuracy. It was first published by Bode, and is known by his name. If the number 4 be taken and added to the products of 3, by each of the numbers of the series, 1, 2, 4, 8, 16, &c., the relative distances of each of the planets is approximately found. It will be noticed

that the distance between any two planets is generally double that of the preceding pair.

BODE'S LAW.

Planet.		Empirical Distance.	Differ- ence.	True Distance.
Mercury, . . .	$4+3 \times 0$	4	0	3.9
Venus, . . .	$4+3 \times 1$	7	3	7.2
The Earth, . . .	$4+3 \times 2$	10	3	10.0
Mars, . . .	$4+3 \times 4$	16	6	15.2
Ceres (Asteroid),	$4+3 \times 8$	28	12	27.7
Jupiter, . . .	$4+3 \times 16$	52	24	52.0
Saturn, . . .	$4+3 \times 32$	100	48	95.4
Uranus, . . .	$4+3 \times 64$	196	96	191.8
Neptune, . . .	$4+3 \times 128$	388	192	300.6

At the time of the publication of this law (1778), neither Uranus, nor Neptune, nor any asteroid had been discovered; and the great interval between Mars and Jupiter led to some speculations as to the existence of an unknown planet or planets to fill up the void. Uranus afterwards was found, and seemed to conform to Bode's law, and the discovery of the asteroids appeared almost to establish it. Nevertheless, Neptune violates it completely, and it can only be considered as a curious chance coincidence and as an aid to the memory.

For a general view of the magnitudes and distances of the members of the solar system, we borrow an illustration from Sir John Herschel. If upon a level field a globe 2 feet in diameter be placed to represent the sun, Mercury will be represented by a grain of mustard seed, on the circumference of a circle of 164 feet in diameter as its orbit; Venus, by a pea, on a circle of 284 feet diameter; the Earth also, a pea, on a circle of 430 feet diameter; Mars, by a large pin's head, on a circle of 654 feet; the Asteroids, by grains of sand, on circles varying from 1,000 to 1,200 feet diameter; Jupiter, by a moderate

sized orange, in an orbit of nearly half a mile diameter; Saturn, by a small orange, its orbit being $\frac{4}{5}$ of a mile across; Uranus by a full-sized cherry or small plum, in an orbit more than $1\frac{1}{2}$ miles across; and Neptune, by a good-sized plum, on a circle of $2\frac{1}{2}$ miles diameter. To this we will only add, to show the isolation of the solar system in space, that the distance of the nearest fixed star would on this scale be expressed by no less than 9,175 miles.

To pursue this illustration further, and give an idea of the relative velocities of the planets in their orbits, we shall state the time that each would take to describe one foot of their orbits upon the same scale. For Mercury, $4^h 3^m$; Venus, $5^h 32^m$; the Earth, $6^h 30^m$; Mars, $8^h 2^m$; Jupiter, $14^h 50^m$; Saturn, $20^h 5^m$; Uranus, $1^{\text{day}} 5^h 53^m$; and Neptune, $1^{\text{day}} 11^h 39^m$.

II. THE SUN.

We have explained in the previous chapter the method by which the Sun's mean distance has been determined: its actual dimensions, therefore, will present no difficulties. Its apparent diameter, as seen from the earth, varies slightly, in consequence of the varying distance of the earth from it, while moving in her elliptical orbit. When the latter is at perihelion, upon January 1, it measures $32' 36''\cdot 2$; when in aphelion, upon July 3, $31' 32''\cdot 0$ in diameter; at the mean distance, $32' 3''\cdot 6$. Now, to present so large an angle as this at the distance of 91,430,230 miles, a globe would require to be 852,680 miles in diameter,—a magnitude that at once places the sun as worthy of being the centre of a system of planets such as ours. If the earth was placed in the centre of a hollow globe of this size, the moon could perform her revolution within it, and a margin of nearly 200,000 miles would yet be left beyond her at every point of her orbit.

When we come to compute its bulk, we find it to exceed that of the earth, as 1,249,500 to 1, or that it is equal in size to $1\frac{1}{4}$ million of earths. But we have further to inquire, what is the density of the sun: is the

specific gravity of the materials of which it is composed as heavy or heavier than those of the earth? This is not, as it would seem, a very difficult problem. We must compare the effect of the gravity of the earth upon the moon with that of the sun upon the earth. The effect of the earth's gravitation upon the moon in a given time is measured by the line Cm (see fig. 14), the deviation of the moon from the direction of the tangent to her orbit; and, knowing the dimensions of that orbit, we can compute the length of Cm in feet.* To find what would be the effect, supposing the moon was at the same distance as the sun, is the next step. Gravity decreasing as the square of the distance increases, it follows that since the sun is 383 times more distant from us than the moon, the effect of gravity would be diminished to $\frac{1}{383^2}$ or $\frac{1}{146,478}$ part. From the dimensions of the earth's orbit we must next obtain the distance through which the sun pulls the earth in the same time—that is, its deviation from the direction of the tangent, and, comparing the two, we have the ratio of the attractive forces of the sun and earth. When these calculations are made, it is found that the sun's attractive power—that is, its mass or weight—is 315,115 times that of the earth; but its bulk being, as before stated, 1,249,500 times the earth's, it follows that the specific gravity of the matter composing it can only be $\frac{1}{4}$ as heavy as that composing our own globe. This fraction, therefore, represents its density, that of the earth being considered as unity. It has been conjectured, from the comparative lightness of the materials of the sun, that

* If we suppose the orbit to be a circle, and no appreciable error will arise from this supposition, this is very simple. Cm being equal to MG , we have only to solve the triangle mGE to obtain this. The angle mGE is a right angle; GE is known, being the mean orbital motion in the time taken, as an hour or a day; and Em is the radius of the moon's orbit, also known. MG may thus be found, and its difference from ME is the quantity required. The reader will bear in mind, that if three parts of a plane triangle are known, provided they are other than the three angles, any other parts of it may be found by the simplest application of trigonometry. The effect of the sun's attraction on the earth will be found in a precisely similar manner.

its centre is maintained at an intense heat, and that thus the pressure of its particles towards the centre, which would cause a great density, is overcome. We shall soon see from various experiments, that the average density of the materials of the earth is about 5.67 times that of water; from which it follows, that that of the sun is about 1.43 times the density of water. From this data it would be easy to compute the actual weight of the sun in tons, but the number expressing it extends to twenty-eight figures, and is perfectly incapable of giving any idea to the mind.

We can go yet another step. The gravity of a sphere, acting always as though its particles were collected at the centre, objects upon the surface of the sun, are removed from the centre of attraction by the length of its radius, or 426,340 miles; and its gravity being 315,115 times that of the earth, we can compare the weight of bodies upon the surfaces of the earth and sun. It will be found on making the calculation, in accordance with the law of gravitation, that a body weighing only 1 pound at the earth's surface would weigh at the surface of the sun $27\frac{1}{2}$ pounds. A man weighing 12 stones on the earth, if carried to the sun, would weigh more than 2 tons: muscular energy would be greatly overpowered, and he would be crushed by his own weight.

The most careful observations have failed to detect any ellipticity in the figure of the sun, and we must therefore assume it to be a perfect sphere. That it revolves upon its axis in $25^{\text{days}} 7^{\text{h}} 48^{\text{m}}$, and that its equator is inclined to the ecliptic by about $7^{\circ} 20'$ is determined by the observation of the spots on its surface, which, from their importance, deserve a somewhat detailed description.

With the ancients, and during the middle ages, the purity of the sun was held almost as an article of faith, notwithstanding that spots large enough to be visible to the naked eye had occasionally been seen upon it. It was one of the first triumphs of the telescope, in the hands of Galileo and others, to reveal the fact that the sun was rarely without a greater or less number of such blemishes.

The general appearance of the spots is an intensely dark central space of tolerably regular form, surrounded by a more irregular belt of semi-luminous matter. The interior space is termed the **nucleus** of the spot, and the exterior the **penumbra**. The forms assumed and the general appearances are very various: sometimes nuclei are seen without any accompanying penumbrae, and more often penumbrae without any accompanying nucleus, while very frequently one penumbra will embrace several nuclei. Not unfrequently a large spot will be crossed by a bright patch, presenting the appearance of a luminous bridge—a name which is sometimes applied to it (see fig. 20). Spots

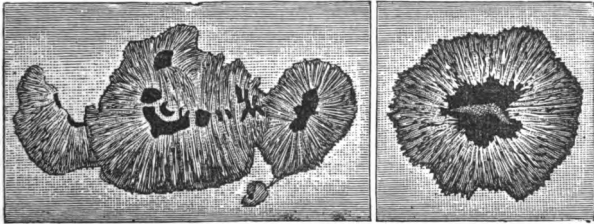

Fig. 20. Solar Spots.

are often of great extent, and appear to have a tendency to group themselves together; neighbouring groups have been observed likewise to tend away from each other. Chains of spots of various size and form are often seen extending 100,000 miles or upwards from end to end, generally parallel to the sun's equator; and one or two members of such a group will occasionally measure 10,000 miles across. Sometimes single spots much larger than this are seen, and many are on record varying from 30,000 to 45,000 miles in diameter. These may generally be seen with the naked eye, if the sun be obscured by haze or fog. Careful photometric observations made by Sir W. Herschel shew that the penumbra emits scarcely half the light which is given by the pure surface of the sun, while the nucleus he considered to emit only 7-thousandths as much

light as the bright parts: its intense blackness is therefore to a considerable extent produced by contrast.

Another remarkable peculiarity is the frequent change of form, the sudden bursting out and as rapid disappearance of the spots. Their duration is very various; many last only a few days and some only a few hours, and perhaps the majority do not exist long enough to be brought a second time into view by the sun's rotation; while cases are on record of spots disappearing suddenly under the eye of the observer. On the contrary, others remain so long as to be visible during several revolutions of the sun. Schwabe has followed a group for sixteen months; and many observers speak to their existence for periods varying from three to six months. It will be understood that, though not absolutely fixed to the sun's surface, they are yet attached to it, and are not of the nature of floating clouds.

The physical cause of the solar spots has long been a subject of speculation. That they are depressions in the surface of the sun is certain, since, when approaching the margin or limb of the sun, it is always observed that the penumbra on the side nearest the margin is broad and well seen, while that upon the other side becomes narrower and narrower, until it disappears entirely from the effect of perspective. Upon one or two occasions, when a large spot has been upon the margin, a notch has been observed in the limb of the sun. That the nucleus is the opaque body of the sun itself is also generally held, while above this two atmospheres are supposed to exist. The upper one, self-luminous, and called the **photosphere**, is that from which we derive light and heat; the interior one is non-luminous, but capable of reflecting the light of the superposed cloudy atmosphere. The disruption of both atmospheres is supposed to be caused by the upheaval of a body of highly heated elastic gas produced below them, or by the down-rush of cooled gas from above—both theories having their supporters. Upon no other hypothesis can the sharply-marked upper and lower outlines of the penumbra be explained.

To find the period of the sun's rotation and the inclination of his axis to the ecliptic is by no means an easy problem. The changing forms and want of perfect fixity in the spots is a great source of error in the results. A well defined spot which promises to be permanent for a few revolutions must be selected, and its position on the solar disc must be carefully measured from day to day. It will ordinarily be found to pursue a curved path, in consequence of one or other pole of the sun being turned a little towards us, and it is more rapidly performed near the centre of the disc, owing to the convexity of the surface. Upon two days of the year the earth will pass through the plane of the sun's equator, and the paths of the spots across the sun will then appear to be in straight lines. Midway between these dates the curvature will be greatest, the pole of the sun being duly turned towards the earth, the position most favourable for these observations. The amount of the curvature at this time affords the means of finding how much towards us the pole is tilted. From numerous observations of this kind, the inclination of the sun's equator to the ecliptic has been found to be about $7^{\circ} 20'$; but, for the reasons stated, the amount is doubtful to perhaps $\frac{1}{2}$ a degree. Similar observations made upon a spot which shall have existed during several revolutions will give with more accuracy the period of his rotation, which has been found to be about $25^{\text{days}} 8^{\text{h}}$; but this may be in error as much as $\frac{1}{4}$ hour, from the same cause. It is not this period, however, that governs the reappearance of the spots; for it must be remembered that the earth is revolving round the sun in the same direction as his rotation, and that the spot will not arrive at the same position on the apparent disc till the lapse of $27^{\text{days}} 7^{\text{h}}$. This is quite analogous to the synodical revolution of a planet. The length of time that a spot is visible is therefore nearly fourteen days.

In the neighbourhood of the spots, or near where one has disappeared or may be expected to appear shortly, are generally seen long branching streaks of light, fully as intense as the brightest parts of the sun, and when near

the margin these are very conspicuous. That they are closely connected with the spots is certain, and they are believed to be elevations or heaped-up ridges of the photosphere, produced by the same convulsions as the spots are. They are termed *Faculæ*. The whole surface of the sun, when carefully examined, is found to present a generally mottled appearance, not unlike the lighter parts of a mezzotint engraving. Very great attention has been paid to this lately; and with high magnifying powers it has been found to be produced by the dark interstices between the luminous masses of the outer atmosphere, which from their form have been called willow leaves, rice grains, &c. These overlie each other in every conceivable direction, but not as thickly but that they leave small interstices of considerable blackness, from the grouping of which the mottled appearance of the sun arises. Curiously enough, this is more noticeable within the region where spots are usually found, and hence cannot be entirely unconnected with them.

Certain zones of the sun's surface are remarkable for the magnitude and frequency of spots. They are rarely seen, for instance, on the solar equator, nor yet at a distance very remote from it. The northern hemisphere is more prolific of spots than the southern, and from about 8° to 28° of solar latitude, both north and south, are the regions of especial fecundity. Spots are occasionally seen beyond these limits, but the polar regions of the sun are always quite free from them.

That the solar activity produces an effect on terrestrial phenomena is most clearly shown by an observation which was made by two observers in 1859. A bright mass of the photosphere was seen projected over the black nucleus of a spot, and, after moving with extreme rapidity, disappeared. Simultaneously there was a great disturbance in the direction of the magnetic needle, and a magnetic storm of great violence prevailed for some time afterwards, accompanied by a vivid display of aurora borealis. That a connection exists between all these phenomena is fully admitted, but of what nature the bond of union may be, is not at present known.

The last fact that we shall have to mention in connection with this subject is the recent discovery, that there exists a definite periodicity in the frequency of the spots. Schwabe, whose long-continued observations are invaluable on this point, has succeeded in showing that in periods of rather more than eleven years there occurs a maximum and a minimum frequency of spots, and that this period of solar activity, though not before recognized, is confirmed by the observations of more than two centuries. A precisely similar period is known to exist in the variation of the magnetic declination, of which the maxima and minima agree precisely with those of the spots. There are exactly nine such periods in each century; and the first year of each being one of minimum frequency, it is easy to calculate the degree of activity to be expected in any year. Carrington, who has also paid much attention to the sun's spots, says, that as the time of minimum frequency approaches, the spots seem to have a tendency to occur near the equator, and gradually die out there. Afterwards they are seen to commence again, remote from the equator, and slowly progress towards it as a second minimum draws near. Attempts not altogether successful have been made to show that there is a similar period to be observed in meteorological phenomena, years of great solar activity being warmer, drier, and more fruitful than others. Supposing such to exist, it is certain that it is not very prominently marked.

For further information relative to the physical constitution of the sun, we have to examine the phenomena which are witnessed during the totality of a solar eclipse. The theory of eclipses will be discussed in the following chapter; at present it is only necessary to know that at times the opaque body of the moon places itself between the earth and sun, and that acting as a screen to hide the overpowering light of the photosphere, we are able to examine some of the fainter details, which are quite invisible at other times. That the sun possesses an exterior gaseous envelope of great extent, more nearly approaching our ideas of an atmosphere, is rendered

probable by an appearance readily noticed. The amount of light received from the borders of the solar disc is palpably less than from the central parts, giving in the telescope unmistakable indication of convexity; and the most natural way of accounting for this, is, that the light from the borders, in consequence of its obliquity, has to pass through a dense stratum of atmosphere, sufficiently transparent to allow the greater part of it to pass, but yet, like our own, capable of absorbing a part also. The observations of the eclipsed sun have rendered this a certainty.

The principal features observable on these occasions are portrayed in the frontispiece. The surrounding corona or "glory" that bursts forth with startling suddenness the moment that the last remnant of the photosphere is hidden by the dark moon, must be regarded as a reflection of the sun's light by his atmosphere. The latest observations point to a division of this corona into two parts, a narrow belt, near the sun, faintly self-luminous as well as reflective, and an exterior and broader part, gradually fading away in intensity, reflective only. Below these, and abutting upon the photosphere, is the region known as the **chromosphere**, occupied by a greatly heated gas of extreme tenuity surrounding the sun completely, but, being subject to the disturbances of the photosphere, is here and there thrown together in enormous masses, in the form of red flames or prominences. These are continually undergoing changes of form, and move with great rapidity. A height of 100,000 miles above the photosphere is often reached by them. We have some evidence, revealed by the newly founded science of spectrum analysis, of yet another layer of gas so highly heated that metals such as iron continue there in a state of vapour.

There are thus no less than six successive strata of atmospheres covering the solid body of the sun:—*1st.* The dense non-luminous but strongly reflecting cloudy atmosphere of the penumbra. *2nd.* The highly luminous photosphere. *3rd.* The highly heated region of luminous

metallic gases. *4th.* The more light and mobile chromosphere. *5th.* The self-luminous and reflective corona; and, *6th.* The non-luminous outer corona or halo. The last two are believed to be something of the nature of a perpetual solar aurora, the hypothesis that their luminosity is produced by electric currents being very probable.

We shall conclude this notice of the sun by attempting to give some idea of the amount of light and heat given forth by it. The earth, as seen from the sun, being only a minute disc of 18" diameter, and the intensity of heat diminishing as the square of the distance increases, it follows that a most insignificant fraction of the solar heat reaches the earth. It has been calculated that the annual expenditure of heat by the sun is 2,381,000,000 times that received by us, and it has further been found that the amount we receive in a year would be sufficient to melt a layer of ice thirty-eight yards thick, and covering the whole globe. Photometric observations made upon the light of the sun have proved it to be 618,000 times that of the full moon, and equal to 5,563 wax candles at a distance of one foot from the eye. From whence arises the energy which maintains this continual drain of heat and light is a problem upon which even speculation fails, and the question must remain to be solved in the future; but it has been conjectured that meteoric streams pouring into the sun may supply the waste of combustion. There is one phenomena which gives some colour of probability to this theory. Accompanying the sun is a hazy nebulous cone of light—an indication of the existence of a mass of material particles, in the form of a very flat spheroid or lens, extending as far as the earth, or perhaps beyond it. This is often seen in tropical climates, and sometimes in this country, after sunset in early spring and before sunrise in autumn. It is called the *zodiacal light*, and resembles the milky way in appearance. It always occupies a position near the ecliptic, within the zone of the zodiac; hence the name. By some it is supposed that it is composed of meteors revolving round the sun in spiral orbits, and continually falling into it. It stretches to a distance of 50°

or 60° from the sun, and hence must be of immense extent. No satisfactory explanation has been given of the phenomena, but for the present, it may be considered as most likely to consist of meteoric matter, either supplying the loss of the solar combustion, or simply revolving round or with the sun. On the meteoric hypothesis it has been calculated that, to sustain the sun's enormous expenditure of light and heat, a depth of 24 feet per annum of such matter must be deposited all over its surface, which would increase its apparent size 1" in 100,000 years. However, this is far from being generally accepted as a satisfactory solution of this difficult question

III. MERCURY.

This planet, in spite of its constant proximity to the sun, was known to the ancients. It revolves round that body in a shorter period than any other planet, and is, of course, the nearest to it. The length of its synodical period, or that in which it will pass through all its phases, from one inferior conjunction to another, is $115^{\text{days}} 21^{\text{h}}$;* but its actual time of revolution round the sun, or sidereal period, is only $87^{\text{days}} 23^{\text{h}} 15^{\text{m}} 43.91^{\text{s}}$. This latter is determined by observing the interval of time between the successive arrivals of the planet at its node or the point of crossing the ecliptic. The node being a fixed point in its orbit, or only subject to very slight displacement, it serves well to find the sidereal period; and, notwithstanding the intricate movements of the planets, their intervals of departure from and arrival at the ecliptic are invariably equal. Of all the larger planets, Mercury has the most elliptical orbit, being more than 14,000,000 of miles more distant from the sun at aphelion

* During 23 days the planet has a retrograde motion; in the remainder it will have direct motion.

than at perihelion, though its mean distance is only 35,392,470 miles. The eccentricity may be expressed by the fraction $\frac{1}{888}$. Its orbit is also more inclined to the ecliptic than are those of the other large planets, and its last peculiarity is, that it is the smallest planet, with the exception of the asteroids, and the most dense.

In consequence of its apparent and also of its real nearness to the sun, very little is known of its physical constitution. Its lustre is most brilliant, and effectually hides its features; but it is believed to possess a dense cloudy atmosphere, which may possibly protect it from the extreme heat of the sun, which will shine there with seven times the intensity that it does upon the earth. Mountains have been seen upon it of very great height, certainly exceeding 10 miles, or about $\frac{1}{252}$ part of its diameter. This is relatively about six times higher than the highest summits upon the earth, the tallest peak of the Himalaya being only $\frac{1}{144}$ part of the earth's diameter. From the observation of one of these mountains, the time of its rotation on its axis has been found to be $24^{\text{h}} 5^{\text{m}} 30^{\text{s}}$; but the difficulties incident to such observations may render the result rather doubtful. Its form has been also examined by several observers, but only one has been able to detect satisfactorily its ellipticity. It is fixed at $\frac{1}{29}$; and the equatorial diameter being estimated at 2,961 miles, the polar will be about 100 miles less.

To discover the mass of Mercury has been a very difficult problem, and it is still to some extent a matter of doubt. Having no satellite, we are only enabled to find its weight or attracting power by observing the slight deviations in the motions of bodies that may pass near it. A small periodical comet has twice passed near it, and from the distance it has been pulled from its true orbit, an estimation of the mass has been made. It is not surprising that in consequence of the minuteness of these inequalities that different values have been obtained by different calculators. The most probable

amount is $\frac{1}{4,865,751}$ part of the sun's mass; and while its insignificance makes it so difficult to obtain, it at the same time renders the knowledge of the amount of little importance, since the effect it can produce upon the other bodies of the system must be proportionally slight. From this value of the mass the density of the planet will be found to be about 7.27 times that of water.

Like Venus, Mercury occasionally transits the sun's disc, but more often than it. The transits occur at intervals of either seven or thirteen years, and always take place in either May or November, according as the planet is at the descending or ascending node. The reason why the transits are confined to these months is, that the sun upon the 6th May and 8th November passes over the degrees of longitude in which the nodes are situated; and it is only when the planet is near these points that a transit can take place. Transits of Venus are similarly obliged to take place early in the months of June or December.

The transits of both planets were first predicted by Kepler; but those of Mercury are by no means so valuable to the astronomer as those of Venus, as may be seen from the consideration of fig. 18. The sun's parallax is quintupled by the interposition of Venus; but the ratio of the distances of Mercury from the earth and sun being as 61 to 39, the solar parallax is only multiplied by $\frac{4}{3}$ by the interposition of that planet, which is still too small an angle to measure satisfactorily.

Peculiar phenomena are seen to take place when a planet is upon the sun's disc, for which, until lately, no satisfactory reason was assigned. It is a principle of optics that when a dark object is seen upon a bright white background, the white light encroaches a little upon the black; and hence a planet in this situation is seen to be rather smaller than it really is. Also, if a bright object is seen upon a dark background, it dilates itself, and thus the sun appears rather larger than it really is. This is called the irradiation of light. The sun's apparent size is still further slightly augmented from another cause,

depending upon the action of light in passing through the telescope, which is known as **diffraction**. Now, when the diminished disc of the planet touches the interior of the augmented disc of the sun, both these optical effects are at once destroyed,—the planet is elongated at the point of contact, and the sun's disc seems to retreat to meet it. In this way the planet assumes a somewhat pear-shaped form. In fig. 21 the real borders of the sun and planet are marked by dotted lines, and the apparent borders by bold outlines. When the former come to touch, as at B, there being no longer any real source of light between the apparent borders, a dark belt is formed, and the planet assumes the form C. This occurs at both the ingress and the egress of the planet, and gives rise to an error, which, in the case of the planet Venus, has entailed a wrong evaluation of the solar parallax.

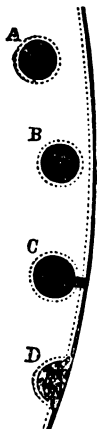

Fig. 21.

IV. VENUS.

Venus is the next planet in order from the sun, and revolves round him in a very slightly elliptical orbit, the eccentricity being only $\frac{1}{145,514}$. Its mean distance from the sun is 66,134,380 miles, and the difference between the greatest and least distances does not amount to 1,000,000 miles. It performs its revolution in 224^{days} 16^h 49^m 8^o, but for its synodical period requires 583^{days} 4^h 48^m,* which is the interval between the successive appearances of the planet in the same position as a morning or evening star—*i.e.*, at its western and eastern elongations. Its diameter measures 7,511 miles, or but little less than that of the earth; and

* Venus retrogrades during 42 days of her synodical period. Being an inferior planet, this occurs on either side of her inferior conjunction.

no polar compression has been observed. This arises not so much from its possessing a perfectly spherical form, although its ellipticity cannot be great, but from the rarity of a conjunction favourable for the purpose of determining it, namely, during a transit across the solar disc.

Having no satellite, the mass of Venus is almost as difficult to determine as that of Mercury; but being near the earth, and of nearly the same magnitude as it, the effect of its gravitation is felt in displacing the earth from her true orbit. The most satisfactory accordance exists between the various calculators, and the mass is set down with considerable exactness, at $\frac{1}{355,000}$ part of the sun's mass. Calculating, as in the case of the earth or sun, the bulk of the planet, and comparing it with the mass, we find the density of Venus to be 5.36 times that of water, and very nearly equal to that of the earth—the planet which in very many respects it seems to resemble closely.

Of all the planets, Venus shines with the greatest brilliancy, being often visible in daylight, at noon, and less frequently, when favourably situated it will cast a very perceptible shadow at night.* This does not happen, as might be supposed, when the whole disc is illuminated, for at that time Venus is very remote from us, but when it is a crescent, less than half-moon between the greatest elongation and inferior conjunction. Its diameter is then considerable; but as it approaches inferior conjunction, the diminution of the breadth of the crescent more than compensates for its lessening distance, and it declines in brilliancy. Its lustre, like that of Mercury, veils the peculiarities of surface, &c.; but from certain spots on its disc its time of rotation has been accurately determined—namely, 23^h 21^m 23^s—and the axis of that rotation has further been found to be inclined to the ecliptic about 75°. That it possesses an atmosphere of considerable density is certain; and from the amount of twilight which has been observed upon the unilluminated portion of the planet, the amount of horizontal refraction

* The author has witnessed both these proofs of brilliancy—the first notably in April, 1870; the second in November, 1863.

(hence the density of the atmosphere) has been found almost precisely equal to that upon the earth. Mountains have likewise been seen upon this planet of very great height, and the highest summits have been estimated at $\frac{1}{280}$ of its diameter; but it is necessary to state that, owing to the delicacy of all such measurements, no great accuracy is attainable.

QUESTIONS.

1. What is meant by the solar system?
2. State the distinction between superior and inferior planets.
3. Explain the terms conjunction, opposition, and elongation. What is the extent of the greatest elongations of the two inferior planets?
4. Explain the terms superior and inferior as applied to conjunctions?
5. What is meant by the synodical period of a planet? Why does it differ from the sidereal period?
6. Trace the phases of an inferior planet throughout its synodical revolution. At what phase will the apparent diameter be greatest?
7. State the principal peculiarities that the four interior planets have in common, and also the four exterior.
8. State Bode's (so-called) Law. In what case does it fail?
9. Give the illustration mentioned in the text of the relative sizes and distances of the planets?
11. Why does the apparent diameter of the sun vary? Give its limits, and also the real diameter in miles?
12. Compare the bulk of the sun with that of the earth.
13. How is the mass or weight of the sun measured against that of the earth? How much does the former exceed the latter?
14. What is the average specific gravity of the materials of the sun compared with those of the earth, also compared with water?
15. How are the effects of gravity at the surfaces of the earth and sun compared, and with what result?
16. Describe the usual appearance of a sun-spot, and explain the terms nucleus and penumbra, as applied to these phenomena.
17. What amount of light is emitted from the several parts of a solar spot?
18. Give some idea of the duration, magnitude, and mode of grouping of the spots.
19. State the generally received explanation of the origin of the spots. What is meant by the photosphere?
20. How is the inclination of the sun's axis to the ecliptic found? Give the amount of that inclination.

21. How is the time of rotation found? Give it, and likewise the period which determines the return of a spot.

22. What are faculæ, and from what arises the mottling of the sun's surface?

23. Where are spots most frequent, and what parts are always free from them?

24. With what terrestrial phenomena are the spots connected?

25. What period is recognized as governing the frequency of the spots? Does the same period occur in any other phenomena? What effect has the period upon the position of the spots?

26. Give the reason for the diminution of light towards the margin of the solar disc.

27. What is the corona, and from whence does its light come?

28. What is meant by the chromosphere, and what gives rise to the red flames or prominences?

29. Describe the several atmospheric envelopes of the sun in order from its surface.

30. What is the diameter of the earth as seen from the sun, and what proportion of its light and heat actually reaches us?

31. Compare the light of the sun with that of the full moon.

32. Explain the meteoric hypothesis of the maintenance of the solar light and heat.

33. What is the zodiacal light—give some explanation of it.

34. Give the duration of the sidereal and synodical periods of Mercury, and how is the former most readily determined?

35. Give the mean distance of Mercury from the sun, and state some peculiarity regarding the eccentricity of its orbit.

36. What is the principal obstacle to the making observations on the surface of Mercury? State what is known of its physical constitution.

37. Give its time of rotation, and state from what it has been determined; also its real diameter, and the amount of polar compression.

38. How has the mass of Mercury been obtained? Give it, and likewise its density.

39. At what intervals and in what months do transits of Mercury take place? In what months transits of Venus?

40. Why are transits of Mercury of little astronomical importance?

41. Explain what is meant by irradiation, and state its effects upon the sun and a planet transiting.

42. To what phenomena does it give rise at the ingress or egress of a planet?

43. Give the mean distance of Venus, and some idea of the eccentricity of its orbit.

44. Give its synodical and sidereal periods, and its true diameter in miles.

45. Why is the polar compression of Venus at present unknown?

46. How is the mass of Venus found, and what is the result ? Give also the density compared with water.

47. At what points of her synodical revolution is Venus at its greatest brilliancy ?

48. Give its time of rotation, and state what peculiarities of surface has been noticed upon it.

49. How do we know that it is surrounded by an atmosphere ? Summarize the points of similarity between the earth and Venus.

CHAPTER V.

I. THE EARTH.

THE globe we inhabit is the next planet in order from the sun; and being also that one of which it is possible to learn the most, it is necessarily taken as the standard with which to compare all the others. The mean distance of it from the sun is used as the astronomical unit of length, and as this can only be found after a thorough examination of the size and form of the earth, these have already been discussed. The time of its rotation on its axis and that of its revolution round the sun form the standards for the measurement of duration; and finally, its mass affords the means of determining that of the sun, as well as indirectly the masses of the planets also. There remain, however, a few points to which it is necessary to allude. The orbit which it describes round the sun at a mean distance of 91,430,230 miles is very little eccentric, though more so than that of Venus, being $\frac{1}{59.1553}$. When at perihelion upon January 1, it is rather more than 3,000,000 miles nearer the sun than at aphelion on July 3. As this is opposed, at least for the northern hemisphere, to what might be expected from the greater heat of summer, it is necessary to explain to what causes the warmth of the seasons is to be ascribed.

When a rotatory motion is given to a globe, there is, owing to the generation of a centrifugal tendency, scarcely anything in nature more permanent in direction than the axis of that rotation. In obedience to this feature of motion, the axis of the earth, during every part of its revolution round the sun, is carried parallel to itself. The effect of this will be most readily appreciated by a reference to the diagram (fig. 22). The axis of rotation being

inclined at an angle of $66^{\circ} 32'$ to the plane of the orbit—*i.e.*, to the ecliptic—is represented by the line Pp , and the

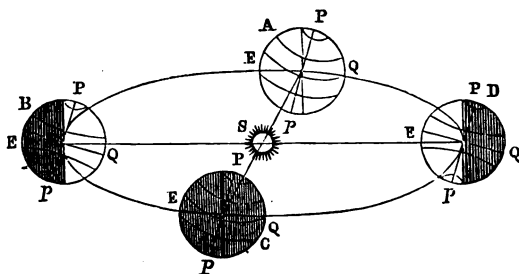

Fig. 22.

equator by $E Q$, at four several positions of the earth. At A , representing the position at the vernal equinox, the whole hemisphere from pole to pole is illuminated by the sun, S , and during the rotation every part of the earth will have an equal share of light and darkness. Similarly, at the autumnal equinox, C , the enlightened hemisphere, though turned away from the spectator, will extend from pole to pole. At B , the summer solstice for the northern hemisphere, the north pole is turned towards the sun, and within a circle of $23^{\circ} 28'$ radius the sun will not set. On the contrary, within an equal circle, of which the south pole is the centre, night will continue throughout the twenty-four hours. Further, the sun will be vertical over a point $23^{\circ} 28'$ north of the equator, or the tropic of Cancer. At the northern winter solstice, D , the south pole will be turned towards the sun, which will be vertical over the tropic of Capricorn, and the position of the hemispheres, with reference to the sun, will be exactly reversed. Hence arise the principal divisions of the globe into zones—the two tropics and the arctic and antarctic circles being the boundary lines.

From the consideration of fig. 23, which is the position

of the earth at the northern summer solstice, we shall be able to trace the effect of this upon temperature. M S,

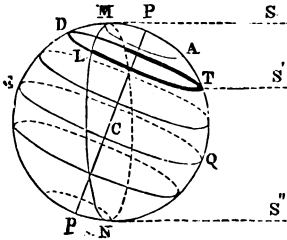

Fig. 23.

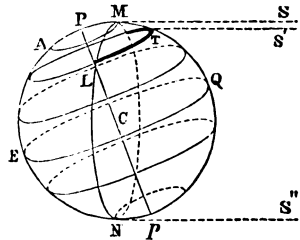

Fig. 24.

T S', &c., being the direction of the solar rays, the vertical circle, L M N, will separate the enlightened and dark hemispheres of the earth. If, then, we take any point, T, it will be seen that the nearer this is to the arctic circle, M A, the longer will be the day, represented by a broad outline, T L, and the less the night, represented by a fine outline, L D. The exact reverse of this is shown in figure 24, which represents the position of the earth at the northern winter solstice. It will further be seen, by comparing figs. 23 and 24, that the direction of the solar ray, T S', is much more oblique to the surface at T, at the winter, than at the summer solstice. Now, so long as the sun is above the horizon of a place, the earth is receiving heat from it; but when it has set, the earth parts with what she has received, radiating it back again into space. It will appear, therefore, that at the summer solstice the northern hemisphere will receive more heat in the long day than it can part with in the short night, and hence is accumulating a supply that makes each succeeding day warmer (disregarding local causes), until the days becoming shorter, the daily supply diminishes. This is the reason why the warmest part of the summer is not at the solstice, but nearly a month later. Again, if we suppose a bundle of rays to fall perpendicularly on the

earth, they will all be absorbed within a comparatively small area; but if a similar bundle fall in an inclined direction, they will cover a much larger space, or the same amount of heat is more distributed. Thus the more oblique direction of the sun's rays, as well as the shorter time that it is above the horizon, contribute to make the winter cold, in spite of our greater nearness to the sun, while the greater length of the day, and the less inclination of the solar rays, both tend to produce the heat of summer.

It must not be imagined, however, that our proximity to the sun during the northern winter has no sensible effect in ameliorating that season, as also of increasing the heat of the southern summer, with which it is coincident; but it requires to be borne in mind that when near perihelion the earth is moving with its greatest speed; and hence the greater heat of the southern summer is exactly compensated by its shorter duration, and the amount of heat received by either hemisphere is thus equalized.

It will be necessary to make a few remarks upon the problem of determining the position of places on the earth, or their geographical latitude and longitude. The first is very easily found, as it is always equal to the altitude of the celestial pole above the horizon; and since we have a most brilliant pole star, in the northern hemisphere at least, we have only to measure its altitude with the mural circle or altazimuth, if the station be on land, or by the sextant, if at sea, and making certain corrections for refraction, its non-coincidence with the pole, or its distance from the meridian at the moment of observation, and the latitude is found. There are various other methods in use, but all more or less resemble this, and are invariably very simple in principle.

The great problem of finding the difference of longitude is a more difficult question; but still, if the stations are on land, and within a moderate distance of each other, it is not troublesome. We have stated that the difference of longitude is nothing more than the difference of local time at the two places. If, then, we have two observa-

tories, furnished with clocks and transit instruments, by which the former can be made to indicate true local time, we have only to find some means of comparing the two clocks to know the difference of longitude. The most obvious method is to carry a chronometer, or a number of chronometers, to avoid error, from the one to the other, by which the difference of the two indications will be at once found. If not too remote, a better plan is to observe simultaneously at either station a concerted signal, as the firing of a rocket, which event will be referred to different local times at the two stations, and hence the difference of longitude will be found. The sudden appearances of meteors or shooting stars have been successfully employed as instantaneous signals visible over a great extent of country. More recently, the electric telegraph has been used to compare the clocks at the two stations, and undoubtedly affords the best means of doing so; but the details of the application of this method are beyond the limits of the present work.

It is manifest, however, that none of these methods will serve to determine the longitude at sea, where the sextant is the only instrument that can be used, and we are forced to have recourse to purely astronomical processes. Of all the heavenly bodies, the moon is by far the most rapid in its movements; and though these are extremely complicated, they have now been thoroughly mastered by the theory of gravitation. It has thus become possible to predict and publish beforehand its place with reference to certain standard stars with very great accuracy for very short intervals (three hours) of *Greenwich* local time. The position of the moon among the stars—that is, its distance from one of the standards—is to be measured by the sextant, and compared with the distances at fixed hours of *Greenwich* time in the published tables, when, from the rate of the moon's motion at the moment, the *Greenwich* local time of the observation will be found, and the deviation of the chronometer time therefrom, or its error. It remains to ascertain the local time, which may be found in various ways, as, for example, by observing the chrono-

meter times at which the sun is at equal altitudes on either side of the meridian. The mean of these is the Greenwich time of the local apparent noon, and the difference between this and the *Greenwich* apparent noon is the difference of local times, or the longitude measured from the standard meridian. The final solution of this important problem depends therefore solely upon the perfection of the lunar tables, the moon, when once its movements are sufficiently understood to be accurately calculated beforehand, being as it were the hand of the clock to tell us Greenwich time all over the world.

II. DENSITY OF THE EARTH.

The dimensions of the earth have been accurately given in Chap. I., and from them its bulk is most readily calculable. It will be found to be 259,801 millions of cubic miles; but before its absolute weight can be obtained, it is necessary to know the average weight of a cubic mile, or the mean specific gravity of its component matter. To find this, various experiments have been tried with more or less success. The most simple and obvious is to compare the attractive force of the whole earth with that of a mountain on its surface; and this is known from the mountain upon which the experiment was first tried, as the *Schehallien* experiment. This mountain is of tolerably regular form, and ranges east and west, and for these reasons is well suited for the purpose. Two stations—one on the north and the other upon the south side of the mountain—are selected, and by a triangulation similar to that explained in an early part of this work, the exact distance between them is obtained. Knowing, as we do, the length of the earth's radius, it is quite easy to find the angle that two radii drawn from the stations to the centre of the earth will form there. This angle will be none other than the true difference of latitude of the two stations. A zenith sector is next erected, and observations of certain selected stars near the zenith are made with it

successively at either station. This instrument consists of a telescope hanging from two pivots near the object-glass, and carrying at the lower or eye end a small graduated arc. Suspended from one of the pivots is a plumb-line, whose position, with reference to the graduated arc, measures the angular difference between the direction of a star and that of the zenith, as indicated by the plumb-line. When we have taken the differences of the zenith distances of each star, as found at the two stations, we shall have so many separate measurements of the difference of latitude, which will agree precisely with that obtained from the triangulation, provided that the direction of the plumb-line is accurately towards the centre of the earth. The centre of the earth is very distant, although its attraction is very powerful. The attraction of the mountain is very small indeed compared with it, but it is near, and so the plumb-line is slightly influenced by it, being directed a little towards the mountain when on either side of it.

The difference of latitude, as found by triangulation, will therefore be less than that found by the zenith sector, and the amount of discrepancy will be twice the effect of the attractive force of the mountain upon the plumb-line. The next step consists in surveying the mountain in every direction, so that its bulk may be calculated, and specimens of the rocks of which it is formed must be taken. These are submitted to examination, and their density or specific gravity, compared with water, determined. From these particulars, the absolute weight of the mountain will be found with some fair degree of accuracy, and the only question that remains is to find what weight must the earth be, that its attraction at the distance of its centre shall be such that the relative attractions of the mountain and it may bear the proportion to each other that the deviation of the plumb-line indicates. It was found that the average weight of the materials of the whole earth must be, bulk for bulk, nearly twice that of the rocks of Schhallien, or five times that of water, otherwise the deviation of the

plumb-line, on account of the mass of the mountain, would have been greater than the amount observed.

A second and somewhat similar method has also been employed. A pendulum that beats seconds truly at the sea level is carried to the top of a mountain, and its rate of going there is noted. The velocity of its vibrations depends upon the force of gravity acting upon it, which in this position may be regarded as two separate attractions—viz., the ordinary attraction of the earth at the sea-level, diminished by the increased distance from the centre; and secondly, the attraction of the mountain itself. The effect of the first on the pendulum is calculable from the law of gravitation, and the sum of the effects of both is observed; hence the difference gives the effect of the mountain's attraction. The structure of the mountain must be examined as before, and its density and weight determined; and the attractive force of the earth, which can then be compared with that of the mountain, will be found similarly as in the preceding experiment. In this manner the general density of the earth has been again found to be about five times that of water.

A third form of this experiment is to carry a pendulum down a deep mine, and there observe its rate of going. Newton has proved that the effect of gravitation in this situation is precisely as though a shell of a thickness equal to the depth of the mine had been everywhere taken off the globe, and that further its force would be diminished, supposing the earth to be formed of one density or material throughout in the proportion of the earth's radius to the radius minus the depth of the mine. When this experiment is made, it is found that the pendulum gains, which implies that the gravitation is greater there than at the surface; and hence the density of the interior of the earth is greater than that of the outer shell in a certain proportion, which the pendulum observations indicate. Of the density of the outer shell we can form a fair estimate; and hence that of the whole earth is determined. This experiment gives a rather greater density for the earth than the previous ones.

We come, lastly, to the most important of these methods,

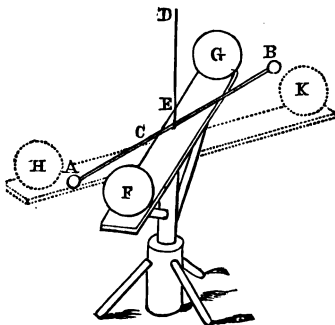

Fig. 25.

which is known as the Cavendish experiment. In it a light beam of wood is suspended from its centre by a fine wire, D E, and at either end a leaden ball of about 2 inches diameter is fixed. When left to itself this balance will assume a place of rest, such that the wire is free from any torsion or twist. A telescope is then employed to determine the exact position occupied by the balls. Two heavy balls, F, G, are now brought and placed very near the small ones, on opposite sides of the balance, and their attractions both tend to drag the small balls from the position of rest; and this being resisted by the torsion of the wire, a very slow oscillatory motion is produced. The deviation from the previous position and the length of the oscillations is then measured by the telescope. The position of the spheres is then reversed by means of a turning frame, when they will occupy the points H, K, and the same measurements made. Very great care has to be taken that no other effect than the attraction of the large balls is mixed up with the movements of the small ones, and the delicacy of manipulation of the observer is put to a most severe test. When the observations have been sufficiently repeated, the amount of the attraction of the large balls upon the small ones is ascertained. It is then a question of calculation, too intricate for these pages, to discover, if the earth was of the same general density as the balls, what would be the amount of the deviation and oscillation; and as lead balls have been usually employed, it has been found that the average density of the earth is

less than that of lead, in such proportion that 5.67 times the density of water will very nearly represent it. This is nearly the average of the five latest and most satisfactory determinations, and may be assumed to be very near the truth. The absolute weight of the earth is now a matter of simple arithmetic, as is likewise the weight of the sun or of any of the planets.

III. THE MOON.

The first example of a secondary planet or satellite which we meet with in the solar system, and by far the most important, is our own moon. It revolves (subject to great perturbations) in an ellipse with the earth in one of the foci, and with it is carried round the sun. Its orbit is only an ellipse with reference to the earth, being in fact a curved line, always more or less concave to the sun, when regarded as a movement in space. Yet we can separate the two motions completely, and regard its orbit round the earth as being performed in a strict ellipse, similar to the planetary orbits round the sun. Its mean distance from the earth, as before stated, is 238,851 miles, and the eccentricity of its orbit is rather greater than the earth's ($\frac{1}{18} \cdot \frac{1}{2} \cdot \frac{1}{12}$). At the point where it is nearest to the earth, called the perigee, it is about 226,000 miles; when farthest from the earth, or in apogee, it is about 252,000 miles distant. This variation of distance causes considerable changes in its apparent size. At perigee it will be 33' 31" in diameter, and at apogee only 29' 21". Its mean apparent diameter is therefore rather smaller than that of the sun, though it sometimes considerably exceeds and at others falls short of it.

It must be understood that these measurements will only be correct supposing the spectator to be situated at the centre of the earth; for the moon, being comparatively near us, the distance of the centres of the earth and moon being only 60 terrestrial radii, it makes a sensible difference in the apparent size of the moon, if the observer be situated so that he is nearer the moon by the length of

the earth's radius. Thus, when the moon is on the horizon of any place it is nearly as far from the spectator as from the centre of the earth; but should it pass through his zenith, it will only be 59 radii of the earth distant from him, and hence will appear larger. This, therefore, forms a correction in lunar observations, and is known as the augmentation of the moon's semi-diameter. It increases in amount with the altitude of the moon, reaching a maximum at the zenith, should the observer be so situated that the moon passes through that point.

The real length of its diameter is readily found from its apparent diameter and its distance, to be 2,160 miles, or but little more than $\frac{1}{4}$ that of the earth. From this it follows that the earth viewed from the moon will appear $13\frac{1}{2}$ times the size that the moon appears to us. It will also be found that the bulk of the moon is only $\frac{1}{49}$ that of the earth.

Notwithstanding the most careful observations having been made, no ellipticity of form or polar compression has been discovered. There are, however, some reasons which may lead us to suppose that the moon is not perfectly spherical. It has been suggested that it may be slightly egg-shaped, the thin end being turned towards the earth. The centre of gravity of such a mass would be towards the side which is removed from the earth; and if this supposition is made, a curious fact connected with the rotation of the moon is partly explained. Moreover, if the moon had been at one time in a fluid state, with motions something similar to those it now has, the attraction of the earth would have tended to produce this form.

The orbit in which the moon revolves is inclined to the ecliptic at an angle of $5^{\circ} 8' 48''$, and the moon may attain, therefore, a more considerable altitude than the sun does in summer by this amount, or it may be to an equal amount at a less altitude than the sun at the winter solstice. Connected with this is the explanation of the peculiarities of the harvest moon. This is a name given to the full moon that happens nearest the autumnal equinox (viz., Sept. 23). On this date the full moon, being

opposite the sun, is at the vernal equinox in Aries, and at its rising the whole of the southern portion of the ecliptic is above the horizon and to the west of the moon. Its motion being from west to east, it will day after day reach a higher north declination; and although ordinarily it rises almost an hour later each day, it will in consequence of its increasing north declination at this time rise nearly at the same hour for several evenings together near full moon. Its light is thus often useful in harvest operations. Should this moon, when full, be in the ascending node of her orbit, the increase of declination will be very rapid, as the inclination of her orbit to the ecliptic will be added to that of the ecliptic to the earth's equator; and in latitudes but little north of Britain, this will lead to the moon's rising even earlier each succeeding day for a short time. On the contrary, should this full moon be at the descending node, it will only be the difference of the two inclinations that will carry the moon north, and the peculiarity respecting the rising of the harvest moon will be less noticeable. It should be mentioned that in every lunation, when the moon is at this point, a similar fact may be observed regarding its rising; but not being at the full phase, it is not so much noted.

The length of the moon's sidereal period is $27^{\text{days}} 7^{\text{h}} 43^{\text{m}} 11.5^{\text{s}}$. The lunar month or **lunation** is the synodical period of the moon, or the time elapsing between one conjunction and the next, which, for the reason already explained in the case of the inferior planets, is more than one complete revolution. The length of the lunation is $29^{\text{days}} 12^{\text{h}} 44^{\text{m}} 2.87^{\text{s}}$. Twelve lunar months, or 354.367 days, is often called the lunar year; and as the difference between this and the tropical year is eleven days, it follows that the moon is eleven days older at the beginning of each succeeding year. The accumulation of this number of days each year, from which the length of a lunation must be subtracted, if it should exceed a lunar month, is called the **epact** of the year. This is of great use in finding Easter. Also, 235 lunar months, or 6,939.69 days, are *very nearly* equal to nineteen ordinary years. This is called the

Metonic Cycle, and is likewise used for finding Easter, as well as for correcting the calendar of those nations who use the lunar year.

A very singular fact is connected with the revolution of the moon on her axis, and seems to be a law which all secondary planets obey. The time of its rotation is precisely the same as the time of its revolution round the earth, or sidereal period; and in consequence of this fact the moon always turns the same side towards us. If the moon be egg-shaped, as has been supposed, the earth's attraction would tend to keep the thin end always turned towards her, since that part would be nearer than the other, and would be attracted more powerfully in the proportion of the squares of the distances. The axis of the moon's rotation is but little inclined from perpendicularity to the ecliptic, the plane of its equator making an angle of $1^{\circ} 32'$ with the plane of the earth's orbit, or about $6^{\circ} 41'$ with the plane of her own orbit. Now, if the axis of the moon's rotation had been exactly perpendicular to the plane of her orbit, it is clear that the lunar poles would have been always situated at the margin or limb of the moon as it is seen from the earth; but since it is inclined at an angle of $6^{\circ} 41'$, it follows that sometimes the north and sometimes the south pole is turned towards the earth to this extent. It is, therefore, not strictly true to say that the same face of the moon is invariably turned to us, for we are able to see at times a small portion—viz., in the vicinity of the poles—of the side usually turned from us. The name of libration in latitude is given to this phenomenon.

There is, however, another kind of libration which enables us to see a still greater portion of the opposite side of the moon. It arises from the fact that the lunar orbit being sensibly elliptical, the moon's daily motion will vary considerably, being now faster and now slower. Its rotation on its axis is, however, performed uniformly, and thus the two motions do not keep pace throughout the whole revolution, but the one will for a time gain upon the other, and then lose. For example, take a quarter of

the lunar orbit near apogee, which will be described more slowly than with a mean velocity, and will therefore take a longer interval than a quarter of the sidereal period. In this time the rotation will have executed more than a quarter of its revolution, or the moon will be more turned on its axis, than is compensated for by the orbital movement. This is called the **libration in longitude**, and by it we are enabled to see a few degrees on either side of the equatorial parts of the moon. There is yet one other but much smaller libration, which arises from the position of the observer upon the surface of the earth. If the moon be rising or setting, it will plainly be possible for us to see a small space round the moon's border, which we cannot see when she is on the meridian. This is known as the **diurnal libration**. From the combination of all three phenomena we are able at one time or another to see about $\frac{4}{7}$ of the moon's surface. Of the remainder we can have no knowledge whatever.

The mass of the moon is by no means so readily found as that of the earth. Satellites are always extremely useful in determining the mass of their primaries, the method being as easy as it is accurate; but the reverse problem, that of finding the mass of the moons, from the disturbances they effect upon the planet round which they revolve, is more difficult. As we have not yet spoken of perturbations generally, we shall content ourselves by saying that there are no less than four ways in which the moon's mass may be found. The attractions of the sun and moon cause slight motions of the earth's axis, tides on the ocean, &c.; and by apportioning these into two parts, separating what belongs to the sun's attraction from what belongs to the moon's, we may obtain a knowledge of their relative attractive forces, or their masses. It has been found that the moon's mass is about $\frac{1}{81\frac{1}{4}}$ or $\cdot 012285$ that of the earth; and since we have already found its bulk to be $\frac{1}{49}$ of the earth's, it follows that the density can only be about $\frac{3}{5}$, the earth's density being unity, or 3·43 times as heavy as water. From the lightness of its matter, as well as from its small size, the force of gravity upon the surface of the

moon will be very small—not more than $\frac{1}{8}$ of the gravity on the earth's surface. In other words, a pound of lead at the earth's surface, if transported to the moon, would weigh but $2\frac{2}{3}$ oz., and the muscular energy of a man would be increased sixfold for the same reasons.

Like all other bodies of the solar system, the sun excepted, the moon shines only by reflected solar light; and since it revolves round the earth, the variety of positions it assumes with reference to the two bodies must give rise to phases like those of the inferior planets. Fig. 26 represents eight several positions of the moon during her synodical revolution round the earth, T; the dotted lines indicating the nearly parallel direction of the solar rays upon either body, and the small circles the lunar phase. At A, the moon is in conjunction, the unenlightened hemisphere is wholly turned towards T: it is therefore invisible, or we have new moon. At C and G, one half of the hemisphere turned towards T is illuminated by the sun, and these are the first and last quarters; the moon is also said to be in quadrature at these points. Between them and conjunction, positions B and H, the moon will

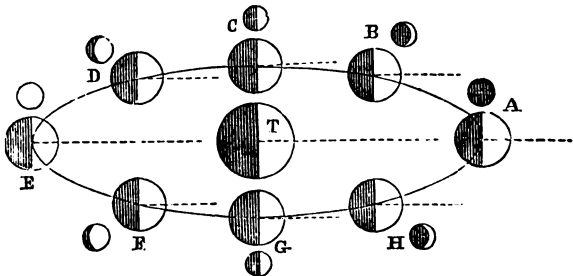

Fig. 26.

be a crescent, but evidently the horns will be turned in opposite directions, as seen from T—viz., at B, to the left hand, or east; and at H, to the right hand, or west. At E, or in opposition, the whole of the face towards the earth will be bright or *full*, and between opposition and

quadratures the moon will be gibbous. The points of conjunction and opposition are called the *Syzygies*, a term only applied to the moon; and points midway between the syzygies and quadratures are sometimes called *Octants*.

Notwithstanding the moon's brightness, she reflects but a small portion of the sun's light incident upon her. It has been estimated that she absorbs or retains for her own use nearly $\frac{5}{8}$ of the solar rays, reflecting only the remainder, or not more than would be reflected by "grey weathered sandstone rock." Some of the planets reflect far more than the moon—the albedo or reflecting power of Mars being $\frac{1}{4}$ of the incident light, of Saturn $\frac{1}{2}$, and of Jupiter nearly $\frac{2}{3}$. The cloudy atmosphere of the latter planet must therefore be nearly as brilliant as white paper. The earth, in like manner, reflects the solar light; and to the moon exhibits phases exactly complementary to hers, or being full when the moon is new to us, &c. The light which the earth reflects must be very considerable, and near the new moon, the earth being gibbous, as seen from our satellite, the *earth-shine* is again reflected back to us. At these times the entire outline of the moon is visible, part brightly illuminated by the sun, and the rest faintly by the earth. It is commonly enough seen thus in the twilight sky. As the moon's phase increases, however, the earth's decreases, and the earth-shine is not visible far from the new moon.

That our satellite is destitute of any sensible atmosphere is shown by a variety of facts, particularly by the absence of any twilight upon the borders of its darkened hemisphere, and by the sharpness of its shadows. Other phenomena, the effects of refraction, would also be noticed—as, for instance, a bright line round its border during a solar eclipse; but a more delicate test than either of these is found in the observation of *occultations*. The moon in her monthly course occasionally passes our fixed stars, and these are found invariably to disappear with astonishing suddenness upon touching the limb of the moon, emerging after an interval in a similar manner on the other side. Now, had the moon any atmosphere at all comparable in density

with the earth's, stars would be found to fade as their light passed through it, when close to the limb. It is therefore certain that there is no lunar atmosphere of any extent, and, by a necessary consequence, neither water nor clouds can exist upon its surface. The lunar day, which is likewise the lunar summer, will be nearly 15 days' duration; and during its continuance, the heat of the sun will be unmitigated in any way, resulting in a temperature far greater than that of the hottest African desert, where water, supposing it to exist, would be at once evaporated. The lunar night, of equal duration, will be far more intensely cold than is ever experienced on the earth. In these violent extremes vegetation will be impossible, and the surface must be alternately burnt up and frozen. Yet, notwithstanding the high temperature of the illuminated portion, none of the heat is reflected to the earth; or, if it is, must be absorbed in the higher regions of our atmosphere. Recent observations, it is true, show that by the most delicate apparatus some minute portion of heat is measurable; but it is far too small to have any effect on terrestrial temperatures. It has, indeed, been noticed that there is less cloud near the time of full moon, but that this is an effect of reflected heat, has not been fully made out.

When examined by the telescope, the surface of the moon is found to be very diversified. High mountains exist which throw long black shadows, especially when near the *terminator*—that is, the extremity of the enlightened hemisphere, or the line that indicates sunrise and sunset on the lunar surface. From the lengths of these shadows, the heights of more than a thousand of these mountains have been measured. The highest peaks reach to nearly 23,000 feet, or $\frac{1}{500}$ of the moon's diameter, and are therefore comparatively three times as high as those on the earth. That they have been raised by volcanic agency appears certain, from the form assumed by most of them—namely, immense crater-like basins, of which the interiors are often much lower than the general outer surface, and having near the centre of the basins a steep conical hill. Though on an immensely larger scale, they

present the exact conformation of terrestrial volcanoes; but there is no evidence of there having been any active volcanic agency at work since the invention of the telescope. The numerous craters are almost invariably circular, or fore-shortened into ellipses, near the moon's limb. The broad tracts called seas are not really oceans, for the reasons before stated: they are probably more allied to our alluvial plains, and their less reflective power is to be attributed to general roughness of surface.

IV. ECLIPSES.

The sun being the only source of light in the solar system, and all the planets, as well as their satellites, opaque bodies, it necessarily follows that each casts behind it a long conical shadow, and that if, in the course of their revolutions, any two bodies come into the same straight line with the sun, that luminary will be wholly or partially hidden from the body most remote from it, which will therefore be more or less incapable of reflecting light. Hence arise various phenomena, of which the eclipses of the sun and moon are the most important. The theory of an eclipse of the moon is very simple, as will be seen from the accompanying diagram. If S represent the sun, and E the earth, the dimensions of the earth's shadow will depend upon the diameters of the two bodies, and their distance from each

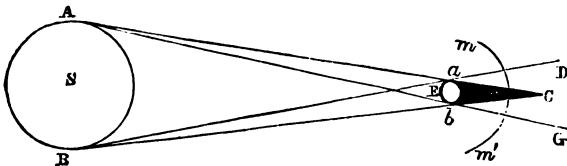

Fig. 27.

other, being determined by the lines $A a$ and $B b$. The distance of the apex of the cone, C , will vary slightly,

owing to varying distance of the earth from the sun, but it will never exceed 220, nor fall short of 212 terrestrial radii. It always reaches, therefore, far beyond the lunar orbit. There exists also a partial shadow outside the conical limits, $a b C$; for, if we draw the lines $B a$ and $A b$, and produce them beyond the earth to D and G , it is clear that the sun would be partially hidden or eclipsed to any spectator within the space $D a C$ or $C b G$, as it is totally eclipsed to a spectator within the cone $a C b$. This inverted truncated cone is called the **penumbral shadow**; and it will deepen in intensity of shade as we approach the umbra or perfect shadow, because the nearer a spectator is to the cone, $a C b$, the greater will be the portion of the sun hidden from him.

If the moon in her monthly orbit, $m m'$, pass centrally through this shadow, she will first enter the penumbra, which will gradually deepen as she proceeds, and afterwards be totally eclipsed in the *umbra*, and emerge finally after passing the penumbra again. If the moon only pass through the penumbra without touching the true shadow, it is not regarded as an eclipse, or a part of the disc only may be enveloped in the earth's true shadow, in which case the eclipse is *partial*. From the position of the earth and moon, it will be seen that a lunar eclipse can only take place when the moon is in opposition or full.

The cone of shadow cast by the moon is of course very much smaller and shorter than the earth's. Though at the time of new moon or conjunction, if the moon be at or near the ecliptic, it is directed towards us, it may or may not reach the earth, according as the moon is near her perigee or apogee. In the former case, the sun will be totally hidden from some portion of the earth; and in the latter, the moon's disc being too small wholly to cover the sun, a narrow ring of light will be left all round the moon at the moment that the centres of the two bodies coincide in direction. Such an eclipse is called **annular**.

The theory of solar eclipses is shown in figs. 28 and 29, where E represents the earth and M the moon. The

direction of the solar rays is indicated by the lines $S m$ and $S m'$ from the upper border of the sun, and by $S' m$ and $S' m'$ from the lower border. It will be seen that the

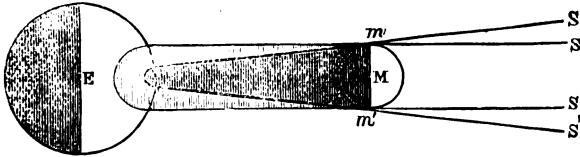

Fig. 28.

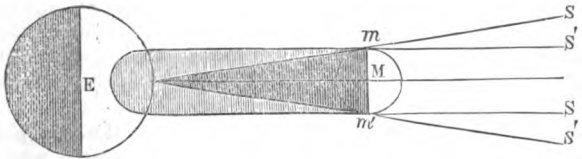

Fig. 29.

diameter of the shadow cone, when it reaches the earth is very narrow, under the most favourable circumstances not more than 180 miles, which is the extreme limit of the totality of an eclipse. The penumbra is limited to a circle of 4,900 miles diameter, beyond which there will not be even a partial eclipse. In consequence of the earth's rotation, it must be remarked, the cone of shadow traverses a considerable distance over the earth's surface; and the limits given above are those at any instant of time, or they express the breadth of the zone which is thus traversed by the shadow. In fig. 29 no part of the shadow touches the earth, and it is only near the centre of the penumbra, on a line joining the centres of the sun and moon, that an *annulus* will be formed round the latter body—elsewhere the eclipse will be partial.

It will appear from what has been said that the total phase of a solar eclipse is seen only from a very small portion of the earth, and even as a partial eclipse is not visible over a whole hemisphere. On the contrary, lunar

eclipses are seen over a much wider range. Thus, if m (fig. 30) represent the position of the moon when it enters the earth's shadow, and if its motion, together with the diurnal movement of the earth bring it to m' when it emerges from it, and at these times it is vertical over the points a and b of the earth's surface, then the limits of its visibility

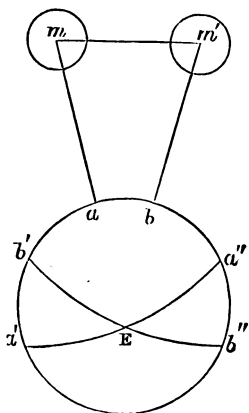

Fig. 30.

will be determined by the *rational* horizons of the two places — namely, $a'a''$ and $b'b''$.* Within the limit $b'Ea''b$ the eclipse will be visible throughout its whole duration, and the whole or a part of the phenomena will be seen within the limits $a'Eb''b$, or more than a hemisphere. If the moon's motion round the earth were performed in the plane of the ecliptic, there would plainly be a lunar eclipse at each full moon or opposition, and the moon would pass between the sun and earth, causing a solar eclipse at each conjunction or new

moon, but such is not the case. The lunar orbit, we have already stated, is inclined more than 5° to the ecliptic; and hence eclipses, either solar or lunar, can only take place when the moon is very near the ecliptic—i.e., near her node, at the same time that she is at either conjunction or opposition. To find at what distance from the node the sun and moon may be, and yet a lunar eclipse

* The rational horizon of any place is a plane parallel to the sensible horizon, and passing through the centre of the earth. Its intersection with the earth is a great circle, of which the position of the observer is the pole. At the almost infinite distance of the fixed stars the rational and sensible horizons are to be regarded as the same, for which reason no distinction has hitherto been made in this work between them.

take place, it is necessary to take into account the diameter of the earth's shadow at the distance of the moon, and the apparent diameter of the latter body. Thus, if $S E S'$ (fig 31) represent a section of the earth's shadow cone at the distance of the moon, the centre of which necessarily falls on the ecliptic $E N$, and M , the moon, moving along her orbit, $M N P$, of which N is the node, then the greatest distance at which an eclipse can occur is determined by the point at which these two circles touch one another. It is found by solving the triangle, $M N E$, for the greatest and least

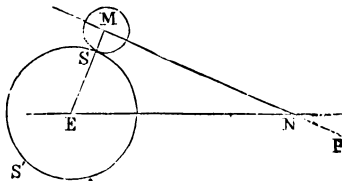

Fig. 31.

values of EM —that is, when the moon is in perigee (ES , the radius of the earth's shadow, and SM , the radius of the moon, being then greatest), and in apogee when they are least—that an eclipse may take place, if at the moment of opposition the moon is not distant from one of her nodes, and the sun from the other more than $12^{\circ} 24'$, and that if nearer than $9^{\circ} 23'$, a lunar eclipse is sure to occur. These points are called the greatest and least **lunar ecliptic limits**.

In determining the like points for a solar eclipse visible at *any* part of the earth, we have to take into account the apparent diameter of the sun as well as that of the moon; and hence the **solar ecliptic limits** are greater than the lunar. It is found that a solar eclipse may take place, if, at the moment of conjunction, the sun and moon are not more than $18^{\circ} 36'$ from either node; and that if less than $15^{\circ} 20'$, an eclipse visible somewhere upon the earth is certain. It will be concluded, therefore, that in a given time the number of solar eclipses will be greater than the number of lunar, the proportion being as 41 to 29; but, in consequence of the more extended range of visibility of the lunar eclipse, there will usually be visible at any one place nine lunar eclipses to four solar.

If the lunar nodes were fixed, or nearly fixed points, the sun would be in the same direction twice a year—once at either node—and the occurrence of an eclipse would simply depend upon the fact, whether the moon was in opposition or conjunction during the time that the sun was within the limits already assigned. Eclipses would then always be confined to particular months. The nodes have, however, a very rapid motion of retrogression; and hence the sun comes into the direction of the same node in less than a year, or in 346·6194 days. Now, if this were an exact multiple of the moon's synodical period, and an eclipse once took place, it would recur again and again at this interval of time; and although this is not so, something very similar happens. It is found that nineteen such periods, or 6,585·772 days, are very nearly equal to 223 lunations, or 6,585·321 days, from which it follows that at the end of this period the sun, moon, and lunar node are in the same relative positions as at the beginning, and that all the eclipses that take place within the period will recur again in the same order after the lapse of 6,585·321^{days}, or 18^{YRS.} 11^{DAYS} 7^H 43^{M.}*

The knowledge of this period and its use in predicting eclipses is very ancient, and was known to the Chaldeans, who gave it the name of the **Saros**. In it there are usually seventy eclipses, and as many as seven may occur in one year; the usual number will be four: but two only may occur, in which case they will both be solar eclipses. As many as five solar eclipses may occur in one year, but never more than three lunar. This arises from the great extent of the solar ecliptic limits, so that one conjunction must, and two may take place, while the sun is within the required distance on one side or the other of the node. Hence two solar eclipses, one at either node, must occur each year, and four may so occur. Should the first of them take place very early in the year, a fifth may happen very

* This period will be 18^{YRS.} 11^{DAYS} 7^H 43^{M.}, or 18^{YRS.} 10^{DAYS} 7^H 43^{M.}, according as four or five leap years are included in the interval.

late, the synodical revolution of the node being less than a year by nineteen days.

But since 223 lunations are not precisely equal to 19 synodical revolutions of the node, a slight irregularity arises. The difference is nearly $10\frac{1}{2}$ hours, and in this time the node will have moved, with reference to the sun, $28' 6''$, a space that in the lapse of about seventy-nine eclipse periods will carry the node completely through the greatest solar ecliptic limits. The effect of this upon solar eclipses is, that at each repetition they occur rather more southerly than before, till at last they disappear altogether off the earth at the south pole.

It will appear from what has been said that *total* solar eclipses at any particular spot of the earth's surface are very rare occurrences. No solar eclipse has been total in London between A.D. 1140, and A.D. 1715, nor has there been one since the latter date, though there have been several annular eclipses. It is this that renders the record of ancient eclipses invaluable in chronology, as they are also tests of the accuracy of our lunar tables. Now that the motions of the sun and moon are perfectly accounted for, we can trace back and calculate when and under what circumstances an eclipse occurred. For instance, the eclipse of Thales, named from the philosopher who predicted it, happened when the Medes and Lydians were engaged in battle; and in consequence of it a peace was concluded. The date of this event is fixed with the utmost certainty, by the fact that an eclipse did take place, which was total from the site of the battle, upon May 28, 585 B.C. In similar manner, the Persians took the city of Larissa (the modern Nimroud) while the inhabitants were alarmed by a total eclipse of the sun. This date is determined to be May 19, 557 B.C., from the fact, that an eclipse was total there on the date mentioned. Many others have been similarly fixed, the earliest of all being an eclipse recorded in Chinese annals of the date October 13, 2128 B.C. It is probable that the Chaldean Saros was known even at that remote date.

The phenomena which occur at a total eclipse of the sun

have been briefly noticed in the preceding chapter, and it only remains to notice the peculiarities of a lunar eclipse. Though totally immersed in the earth's shadow, it is but rarely that the moon is not visible to us, and it generally assumes a dull red or copper colour. The explanation of this fact is found in the refraction of the rays of the sun in passing through the terrestrial atmosphere, which absorbs the blue rays largely and transmits only the red and yellow, precisely as occurs at a rosy sunset. The red light thus bent in, encroaching on the earth's shadow, is sufficient to allow the moon to be seen; but its amount will vary in different eclipses on account of the different states of the atmosphere. There are instances on record of the moon being completely hid, in which case the zone of atmosphere through which the rays were refracted must have been heavily laden with clouds and moisture. At other times the brightness of the illumination has been such that the eclipse would almost have been questioned, but for the deep red colour, resembling that of a bright cloud at sunset.

QUESTIONS.

1. By what amount may the earth's distance from the sun vary? When is the earth in perihelion? When in aphelion?
2. Explain the position of the earth's poles with reference to the sun at the equinoxes and at the solstices.
3. What two causes combine to produce the heat of summer? Explain how they tend to do so.
4. What is the effect of the earth's varying distance from the sun upon the heat of the southern summer and the northern winter?
5. Are all the seasons equal in length? What causes the inequality?
6. How is the latitude of any place on the earth found?
7. How is the difference of longitude of two places found, if both are on land? State some methods that may be employed to compare local times.
8. Explain how the moon is employed to find the error of a chronometer, or to show Greenwich time at any point of the earth.
9. How may the local time at any place be found? Shew that this gives us the longitude.
10. Give the bulk of the earth in cubic miles.
11. What is the principle of the Schehallien experiment? Ex-

plain the various steps by which it leads us to a knowledge of the earth's mean density.

12. Describe the zenith vector and its use.

13. Give the result of the Schehallien experiment.

14. In what other way may the attraction of a mountain be employed to find the density of the earth?

15. What does the law of gravitation teach us of the effect of gravity down a mine? Under what circumstances will it be greater and less than at the surface?

16. How has this been employed to find the density of the earth?

17. Describe the apparatus used in the Cavendish experiment.

18. With what final result has this experiment been made?

19. Explain the moon's motion with reference to the earth; also with reference to the sun.

20. What terms are applied to the points of nearest approach and greatest distance from the earth? By what amount do they differ?

21. What are the limits to the variation of the moon's diameter? Compare with the sun's.

22. What is meant by the augmentation of the moon's semi-diameter? Explain the cause of it.

23. Give the actual diameter of the moon, and compare the dimensions and bulks of the moon and earth.

24. State what is known or suspected of the moon's form.

25. At what angle is the lunar orbit inclined to the ecliptic?

26. Explain the peculiarity of the harvest moon.

27. Give the sidereal and synodical periods of the moon.

28. What is meant by a lunar year? What by the epact? What is the Metonic cycle?

29. Give the time of the moon's rotation; and why do we see but one side of it?

30. At what angle is the moon's equator inclined to the ecliptic, and also to the plane of its own orbit?

31. What is meant by libration in latitude?

32. What causes libration in longitude? What the diurnal libration? Sum the effects of the three librations.

33. State generally the means adopted to find the mass of the moon. Give it and likewise its density, and the effect of gravity on its surface.

34. Trace the lunar phases through a synodical period.

35. Explain the terms lunation, quadrature, syzygy, albedo, octant.

36. Give an illustration of the brightness of the moon compared with terrestrial matter and the planets.

37. What phases does the earth present to the moon? What is the earthshine, and why is it only seen near the new moon?

38. From what phenomena is the absence of atmosphere on the moon proved, and what effect must result as regards temperature?

39. What is known and conjectured about the reflection of heat from the moon?

40. Give a general description of the lunar surface, and state what is meant by the terminator.

41. What are the usual characteristics of a lunar crater, and give the general height of the mountains compared with those of the earth.

42. State the general cause of eclipses.

43. Give the length of the earth's shadow, and the meaning of the terms umbra, penumbra. What is the degree of shade in the penumbra?

44. State the general conditions of a solar eclipse. Distinguish between annular and total eclipses. Whence do the two varieties arise?

45. Give the extreme limits of visibility of a total and partial solar eclipse, and state the effect of the earth's rotation on these limits.

46. By what is the visibility of a lunar eclipse determined? Explain the term rational horizon.

47. At what points of the lunation must eclipses respectively occur, and why not at every conjunction and opposition?

48. What are the greatest and least lunar ecliptic limits? Explain the term.

49. Give the solar ecliptic limits, and the reason why they exceed the lunar.

50. Give the proportion of solar and lunar eclipses generally, and for any one place upon the earth; also the cause of the difference.

51. State the length of a synodical revolution of the node. Why does it differ from an ordinary year?

52. Explain the reason of the recurrence of eclipses after eighteen years.

53. State the usual number of eclipses that occur in the Saros, and the number of either kind that may happen in one year.

54. What irregularity is there in the recurrence of eclipses, and how many times may an eclipse recur?

55. Explain and give illustrations of the use of ancient eclipses in chronology.

56. What is the cause of the redness of the moon in lunar eclipses? Explain why the redness varies.

CHAPTER VI.

SUPERIOR PLANETS.

I. MARS.

OF the planets revolving round the sun exterior to the earth, Mars is the nearest to it, and is in very many respects a most interesting planet. It was the consideration of its varying brilliancy, which is sometimes equal to Jupiter, and at others hardly equals a second magnitude star, that led Copernicus to reject the earth as its centre of motion, and transfer that point to the sun; and it was also from the rigorous examination of the motions of this planet that Kepler established his celebrated laws, which he extended by analogy only to the other planets.

Being a superior planet, it does not remain in constant attendance upon the sun; for it is evident that the earth may come between it and that luminary, when the two bodies must necessarily be in opposition to each other. Its distance from the earth at different times will vary to the extent of twice the earth's distance from the sun, and, indeed, owing to the great eccentricity of Mars' orbit, to even a greater amount than this. Its apparent diameter will similarly be liable to very extensive changes, the limits of its variation being $30''\cdot4$ and $4''\cdot1$. Its real diameter has been found to be 4,920 miles, or $\frac{5}{8}$ of the earth's. It is therefore the smallest planet in the system, after Mercury. Its mean distance from the sun is 139,312,000 miles; but owing to the eccentricity being great ($\frac{1}{10}\cdot74$), second only to Mercury in this respect also; its perihelion distance is about 126, and aphelion distance 152 millions of miles. To make one complete revolution in this orbit it requires very nearly 687 days; but for its synodical period, requires 780 days, during 73 of which it is retro-

grading.* It has thus the longest synodical period of any planet, and in consequence is most rarely seen, the intervals of its appearance in opposition, as stated above, being two years seven weeks. Further, it is the only one of the superior planets that present any perceptible phase.

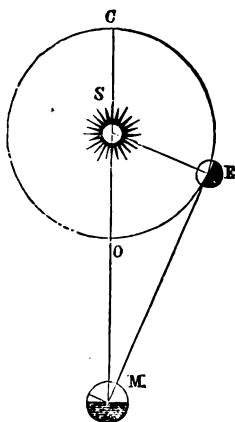

Fig 32.

This arises from the fact that the others are so distant that we view them very much as they would be seen from the sun. The phase of Mars never exceeds a slight gibbosity, seven-eighths of its disc being always illuminated. Fig. 32 shows the position of the earth and Mars when the latter presents its least possible phase—namely, when the earth is at its greatest elongation, as seen from Mars, and presents to it only a half-moon. At the points C and O, which represent the position of the earth when Mars is in conjunction and opposition, it is evident that the latter will be full, as seen from the former.

To ascertain the mass of this planet, it having no satellite, has been as difficult a problem as that of Mercury; but it has been fixed, from the disturbances it effects upon the earth, to be $\frac{1}{2,880,337}$ that of the sun. Its mean density, using this evaluation, will be scarcely half that of the earth, or 2.82 times the specific gravity of water. Also, the effect of gravity on the surface will be found to be only .304 of the earth's gravity; in other words, a pound weight taken to the surface of Mars would weigh there five ounces only.

Unlike the planets, of which we have already spoken, the surface of Mars is very distinctly marked,

* The retrograde movement of the *superior* planets occurs always at the time of opposition, and for an interval on either side of it.

offering many spots favourable for determining its period of rotation. This has therefore been found with great accuracy, as well as the direction of the axis round which it revolves. The most recent calculations give a period of $24^h 37^m 22.735^s$ for its rotation, and the inclination of the equator to the plane of the ecliptic as $28^\circ 51'$. From both these facts we see how nearly the conditions of climate must agree with our own; for, although the seasons will differ greatly in duration both among themselves, owing to the great eccentricity of the orbit, and from the earth's, owing to the much greater length of Mars' year, still the distribution and variation of heat over the surface must agree very closely with what we know to be the case with the earth.

This is still further confirmed by the presence of two brilliant white patches near the poles, which can be none other than masses of snow and ice, since they are seen to diminish as the Martial summer comes on in either hemisphere, and increase during the Martial winter. Moreover, since these patches are not of greater relative extent than exist on the earth, it follows that Mars must enjoy a similarly temperate climate. Yet the intensity of the sun's light and heat there will be only $\frac{3}{7}$ of that upon the earth—showing that there must either be a dense atmosphere, capable of retaining the solar heat better than our own, or that the soil and matter of the planet absorbs, but does not so readily part with the heat radiated upon it. That there does exist an atmosphere is clearly indicated by the presence of the snow at the poles, as well as by other phenomena; but that it is very dense or extensive has been denied.

Permanent markings and conspicuous diversity of colour upon the disc of the planet clearly indicate the existence of continents and seas; but, curiously enough, the larger portion of the surface would appear to be land. These parts always appear of a reddish tint in the telescope, and give rise to the fiery appearance of the planet to the naked eye. We must suppose that this is the real colour of the soil; and it is probably something like the red sandstone

districts on our own globe. The seas have a greenish or bluish-grey colour; but, owing to the preponderance of land, the general colour of the planet is red.

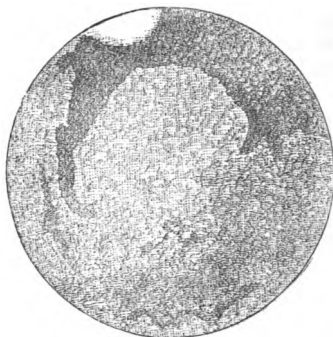

Fig. 33.

torial diameter, 4,920 miles; polar diameter, 4,789 miles.

Much controversy has been held upon the subject of the polar compression of Mars, it having been set down very variously by different observers. The latest determination seems to be the most trustworthy, and is nearly the mean of the best previous measures. The result is an ellipticity of $\frac{1}{37.8}$, or, equa-

II. THE ASTEROIDS

The zone of small planets situated between Mars and Jupiter form a group of bodies remarkable in very many respects. Their existence, though suspected in the last century, was not actually discovered till the commencement of the present, when a systematic search was made for them, to be rewarded by the discovery of four new planets in the space of a very few years. A long interval then intervened, and no more were found till the year 1845, since which date each succeeding year has added to the number. As many as 125 are at present known, and have their orbits calculated. It was an hypothesis of Olbers, one of the earliest successful searchers for them, that a large planet had been exploded or broken to fragments by a concussion, and that very numerous members would be found. This supposition, though to some extent verified, is now pretty generally rejected; yet the minute

bodies evidently belong to one family, for they revolve in orbits so entangled that it has been said that, if the orbits be imagined as material rings, the whole could be suspended by taking any one up at random. It is more probable that this zone of planetoids form a connecting link between the large planets and the streams of meteors, and that they have been at one time a mass of matter resembling the rings of Saturn; but, owing to their insignificant mass and great distance from the sun, the equilibrium has been lost, breaking up the ring, and forming a number of bodies revolving each in its own separate orbit.

With the exception of the diameters of one or two of them, which have with difficulty been measured, little is known of their size or weight. The largest are Ceres and Vesta—two of the earliest discovered. If we suppose all the planetoids equally to reflect the solar light, we may arrive at a very fair estimation of the magnitudes of the others from the consideration of their relative brilliancy and their distances from the sun and from the earth. In this manner it has been found that they most probably vary in size, from the superior limit of 228 miles in diameter to about 15 miles, the magnitude of the smallest yet known. Vesta is occasionally seen with the naked eye, but the others are very much fainter; and there is a well marked decrease in brilliancy and size to be observed in the more lately discovered planets. It would appear, therefore, that though the number of them is probably unlimited, yet the larger are nearly all known, and that the optical power of the telescopes now in use will gradually set a limit to the discovery of more of the group. It is known that the total mass of all the asteroids must be insignificant, and taken together they would not form a body of the size of Mercury.

Their orbits are frequently much more inclined to the ecliptic than those of the larger planets; and hence they have sometimes been termed ultra-zodiacal. Pallas is the most inclined of any, the inclination of its orbit being $34^{\circ} 42'$, or five times the inclination of Mercury. The eccentricity of the orbits is also usually greater, many of

them exceeding Mercury in this respect also. Their mean distances from the sun vary greatly: that of Flora, which is the nearest to it of any, is only 201,273,000 miles, and its sidereal period is 1,193 days, or $3\frac{1}{3}$ years. Camilla revolves at a mean distance of 325,509,000 miles, and its period is 2,453.6 days, or $6\frac{2}{3}$ years. These may be taken as very near the extreme limits of the zone.

It is possible to learn but very little of the physical constitution of these minute bodies. One or two of the earlier known and largest have been suspected to possess an atmosphere, but this is doubtful. The effect of gravity on their surfaces must be very small indeed. Their only practical use in astronomy would be to determine the mass of Jupiter; possibly that of Mars also; and one of them (Vesta) has already been used for the former purpose.

III. JUPITER.

We now come to the most important planet, Jupiter, the largest in the solar system. In brilliancy, when in opposition, it rivals Venus; and, though its apparent diameter varies between 50" and 30", it is always a very bright and conspicuous body. It revolves in an orbit but very slightly inclined to the ecliptic, and at a mean distance from the sun of 475,693,000 miles. The eccentricity of the orbit is moderate, $\frac{1}{20.763}$; so that its greatest distance from the sun can never exceed 500,000,000, nor its least fall short of 450,000,000 miles. The time taken in performing this extended orbit will of course be proportionally long, and is nearly twelve of our years. More accurately, Jupiter's year consists of 4,332.58 mean solar days. Its synodical period is 398.8 days; and its retrogradation, although it extends over a less arc than Mars', is performed much more slowly, requiring 121 days. This is necessarily the case with each succeeding superior planet, in consequence of their greatly increasing distances.

From the constant brilliancy of Jupiter, coupled with its great distance, it evidently follows, that it must be a

very large and magnificent planet. Its apparent equatorial diameter has been carefully measured, and is found to correspond to an actual length of 88,390 miles—that is to say, more than ten times the earth's, or than one-tenth of the sun's. A glance through a telescope shows that the planet is very considerably flattened, and the ellipticity is usually set down as great as $\frac{1}{13.71}$, which gives a polar diameter of 81,940 miles only.

The disc of Jupiter is usually crossed in a remarkable manner by dark-coloured belts, lying most generally in a direction parallel to the planet's equator. Sometimes only one or two are seen, frequently three, but occasionally the whole disc is covered with alternate belts of various intensities of shade. Jupiter is certainly surrounded by a dense cloudy atmosphere, capable of strongly reflecting the solar light. The dark belts are, in all probability, rifts or fissures in the clouds, exposing the surface, and caused by violent permanent winds, more or less resembling our own sub-tropical trade-winds.



Fig. 34.

Besides these are occasionally seen small round bright spots, whose origin is doubtful. They are not generally considered to be attached to the planet's surface, but more resemble bright patches of floating cloud. If we may hazard a conjecture, they are perhaps masses of cloud hanging about the summits of mountains, analogous to the ring-like craters of the moon; and since spots similar to these, but dark, are also occasionally seen, these may

possibly be the craters themselves, free from the accompanying vapour. It is by noting the passage of these across the disc that the time of Jupiter's rotation has been found. Notwithstanding its great size, the rotation is performed, without doubt, in so short a period as $9^{\text{h}} 55^{\text{m}} 21.3^{\text{s}}$ of mean solar time. From this it follows that the centrifugal force generated at the equator of Jupiter must be very great, and the very considerable polar compression is at once and satisfactorily accounted for. Indeed, Laplace has calculated what should be the ellipticity theoretically, as Newton did for the earth, and has found that it closely agrees with the amount observed. It would also appear that the rapid rotation produces the general parallelism of the belts.

Jupiter is attended by four satellites, which form with their primary a very beautiful and complete miniature system. Its mass has therefore never been a matter of doubt; and though various means have been employed in determining it, all have yielded almost identical results. The most accurate value is $\frac{1}{1,047.876}$ of the sun's mass; and it is thus the heaviest, as well as the largest planet in the system. The perturbations or disturbances which it effects upon the motions of comets and other bodies are, therefore, far more important than those of any other planet.

From the particulars already given, it will be found that the bulk of Jupiter is 1,290 times the earth's bulk; its mass 300.7 times the earth's mass; and its density .233, or scarcely a quarter of the earth's average density, and 1.32 as compared with water. It will further be found that the force of gravity on the surface will be 2.54 times that upon the earth.

The satellites of Jupiter, as seen from the earth, present most interesting, important, and varied phenomena. Their existence was first discovered by Galileo, and ever since they have occupied much of the attention of astronomers. They are distinguished from one another simply by numbers indicating their distance from Jupiter. If we imagine the planet to be represented by a globe three feet

in diameter, the distances of the satellites from the centre of their primary will be very closely represented by 18, 29, 46, and 81 feet respectively. As seen from the earth, they are of about equal brightness: the third, which is the largest, is generally rather more brilliant than the rest; and if it was not for the overwhelming light of the planet, they would probably just be visible to the unaided eye as very faint stars. As seen from Jupiter they will of course present phases like our own moon, and from certain periodical changes in their brilliancy, they are believed to resemble her also, in turning only one face to their primary; or, in other words, that, like her, they revolve on their axes in precisely the same time as they revolve in their orbits round the planet. These orbits are all circular, or very nearly so; and those of the two interior satellites do not deviate by the least appreciable amount from a strictly circular form; those of the two exterior are subject to slight variation. Their times of revolution round Jupiter are respectively $42\frac{1}{2}$, $85\frac{1}{4}$, $171\frac{3}{4}$, and $400\frac{1}{2}$ hours—so that they are far more swiftly moving bodies than our moon. Further, the orbits are all very slightly inclined either to the plane of Jupiter's orbit or to that of Jupiter's equator—a fact that considerably simplifies the theory of their motions.

When we consider the great magnitude of Jupiter, and the positions of the orbits of his satellites, it is plain that the latter must be subject to very frequent eclipses. Indeed, the three interior moons pass through the shadow of the planet, and are eclipsed in every revolution; the fourth also is frequently eclipsed; so that to the inhabitants of that distant planet such phenomena are of the most common occurrence. In like manner, they will pass between the sun and some point of the planet's surface just as frequently, and solar eclipses will be equally common, but of course are visible from only very small portions of the planet, owing to its immense distance from the central luminary. As seen from the earth, these phenomena are still further increased and varied. Not only do we see the satellites disappear on entering the shadow cone and

reappear on their emerging therefrom, as also the transit of a small black shadow across the bright planet, indicating a solar eclipse to all those portions over which it passes. We see further the frequent occultation of the moons as they pass behind the planet's disc and reappear on the other side, and we may observe the transit of the satellite itself projected on the disc, and accompanying at a greater or less distance its dark shadow, already spoken of. It will at once appear that when the planet is in opposition the shadow will fall directly below the satellite, and hence will not be seen, and the eclipses of the satellites will in like manner be invisible from the earth, owing to the planetary shadow cone lying directly behind the planet. Near opposition, also, the latter phenomena will only be partially visible, as the satellite may enter or emerge from the shadow cone, while it is hid behind the disc of the planet, according as Jupiter has past or not yet come into opposition with the sun.

These continually changing phenomena are not only interesting but useful. The eclipse of a satellite forms an instantaneous signal of time visible over one-half of our earth, and thus it may be employed to compare the local times of two very remote stations. Or, if our tables are sufficiently perfected to predict the eclipse with accuracy, it may similarly be employed for determining the longitude at sea. This use of them was first pointed out by Galileo; and it explains why so much attention has always been paid to these bodies; but, unfortunately, the difficulty of observing such delicate phenomena from the unsteady deck of a vessel almost precludes the use of this very promising method.

The attempt to form tables which should accurately predict these occurrences, however, led Roemer to the very important discovery of the gradual propagation of light. His first predictions of the eclipses, which are the most important of the various phenomena, were founded upon the average of a large number of such observations made in every position of the planet with reference to the earth—

that is, throughout the whole of its synodical revolution He soon detected, however, when he came to compare the predicted times with actual observation, that all those eclipses which happened near the time of opposition, Jupiter being then in perigee,* or nearest to the earth, occurred too soon; and, on the contrary, when Jupiter was in apogee, they occurred too late. The extreme variation was very considerable, being about $16^m 26^s$; and it became evident to Roemer that these irregularities would be at once explained, if the velocity of light was great, but not instantaneous, as it was previously supposed to be. In fact, if light required $16^m 26^s$ to travel across the orbit of the earth, by which amount the distances of Jupiter when at opposition and conjunction differ, the whole would be made clear. This solution of the difficulty was not generally accepted by astronomers till many years later, when Bradley discovered the aberration of light. It then became indisputable.

The diameter of the earth's orbit being, it was supposed, about 190,000,000 miles, it followed that the velocity of light must be about 192,000 miles in a second. Later on still, experiments were made to measure the velocity directly when passing horizontally through atmospheric air on the earth's surface; and the result so nearly agreed with that derived from the observation of the satellites that no doubt existed upon the subject. These experiments have been repeated within the last twenty years with improved methods and apparatus; and the velocity determined is something less—namely, 184,000 miles per second. This was but a short time before the accepted value of the solar parallax began to be suspected; and it is most satisfactory to find that, since it has been necessary to reduce the estimation of the sun's distance, the two modes of measuring the velocity of light again agree most closely, thereby mutually confirming each other.

* The term perigee is applied to any body, whether the sun or a planet, as well as to the moon, when it is at its nearest point to the earth.

The accompanying Table will give at a glance a general idea of the magnitudes and weights of the satellites:—

Sat.	Diameter in miles.	Mass compared with the earth.	Density com- pared with the earth.	Specific Gravity, or the density, compared with water.
I.	2,341	0·00521	0·2016	1·143
II.	2,101	0·00699	0·3738	2·120
III.	3,432	0·02661	0·3267	1·853
IV.	2,936	0·01283	0·2515	1·426

It will be seen that, excepting the third, they are not much larger than our own satellite, and that the two interior ones are of much less weight. The third satellite has twice the mass of our own moon, and the fourth is equal to it. As might be imagined, the matter of which they are composed is much lighter than that of the earth or her moon, but it is heavier than that of their own primary. This fact might readily enough be explained, if Jupiter is considered as a mass of heated matter, cooling slowly; but we must beware of too rash speculation upon what is only based on conjecture. Compared with the primary planet round which they revolve, the satellites of Jupiter are very small bodies indeed; and though the first is at a distance greater than the moon from us, it is very near when we consider the enormous magnitude of Jupiter; that is to say, while our satellite revolves at a distance of 60 radii of her primary, the nearest of Jupiter's revolves at a distance of 6 radii only, and even its most distant at not more than 27 radii. One fact which renders the discussion of this miniature system of the highest interest is the confirmation which it affords of the laws of Kepler, which are observed to apply as accurately to the periods and distances of the satellites as to those of the principal planets.

IV. SATURN.

This planet is the most distant of those known to the ancients. It is a tolerably conspicuous object, varying little in brilliancy or in apparent size, owing to its immense distance, compared with which that of the earth from the

sun is but a small fraction. For the same reason it is very sluggish in its motion. Its mean distance from the sun is about 872,134,000 miles, and the eccentricity $\frac{1}{17.089}$, so that it may extend its excursions to a greater or less distance than this by about 50,000,000 miles. Nearly $29\frac{1}{2}$ years, or accurately 10,759.22 mean solar days, are required by it to make the circuit of the sun. This slow motion allows the earth to come a second time between the planet and the sun in little more than a year; or, in other words, the synodical period is only 378 days; and though its arc of retrogradation is but 7° , it requires 139 days to travel over this short space.

The physical constitution of Saturn affords a striking exception to that of all the other planets. Not only is it accompanied by no less than eight satellites of various sizes, revolving at very various distances (from $3\frac{1}{3}$ to 64 radii of

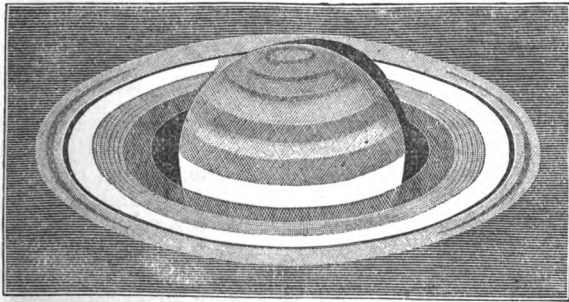

Fig. 35.

Saturn); but it is surrounded by three circular, flat, concentric rings, which revolve round the ball of the planet similarly to a very close satellite. The position of the rings with regard to the planet is most readily explained by a diagram (see fig. 35). These strange appendages render Saturn a most interesting object, although it is too distant for satisfactory observation of any markings on its surface beyond the identification of very faint belts, like those of Jupiter. The thinness of the rings is extreme, certainly

not more than 250 miles, and in all probability very much less, but their diameter as well as their breadth is very considerable. The interior of the three is not conspicuous, is even semi-transparent, and was not known to exist till the year 1850; but the two outer ones are very bright—indeed, are more strongly reflective of solar light than the ball of the planet. Extended series of angular measurements have been made to ascertain the various dimensions of this complex system. We shall append these particulars in a tabular form, but reduced to linear measure:—

Equatorial diameter of Saturn, . . .	71,903 miles.
Polar diameter,	64,213 „
Ellipticity, or Polar Compression, . . .	$\frac{7}{11}$ „
Extreme diameter of outer ring, . . .	169,530 „
Breadth of the outer ring,	10,160 „
Extreme diameter of middle or interior bright ring,	145,768 „
Breadth of the middle ring,	16,503 „
Distance between these rings,	1,725 „
Distance between the middle ring and the planet,	20,427 „

Saturn is thus even more elliptical than Jupiter, though its rotation on its axis is not quite so rapid. By watching the passage of some darker regions on its surface it is found to revolve in about $10^h 29^m$; and the rings have in a similar manner been observed to revolve in a period only 3 minutes greater. The rapid revolution of the rings tends greatly towards maintaining their equilibrium; for without it a very slight disturbance would be sufficient to precipitate them bodily upon the planet. Another fact which aids the conservation of this intricate and apparently unstable system is, that the rings are not quite concentric with the planet itself, revolving round a point about 450 miles distant from the centre of the ball.

As seen from the planet, the rings and satellites must present a most gorgeous spectacle. To an observer on the illuminated side of the rings they will be seen to span the sky in broad arches of light, invariable in their position; with the satellites, various in size and phase, threading their

paths on either side. Upon the other half of the planet the rings will only be seen as black bands, occulting all the stars that lie in the direction, and causing a perpetual eclipse of the sun over a portion of the hemisphere.

The plane of the rings, which is probably coincident with that of the planet's equator, is inclined to the ecliptic at an angle of $28^{\circ} 11'$; and since, like the earth, the planet revolves round the sun with the axis always parallel to itself, it is clear that, during half a revolution, or 14.7 years, the sun illuminates the northern, and for an equal time the southern side of the rings. Viewing them from the earth, which is comparatively near the sun, we usually see the illuminated side, whichever it may be, for the like periods. But when the sun is passing from the one side to the other, it is evident that it is only the thickness of the rings that is illuminated; and this is so extremely slight that, without the best instrumental means, they are quite invisible at this time. Further, it is possible, during a short time, for the sun to be on one side of the plane of the ring and the earth upon the other. They will then, of course, be invisible from the earth, except as a dark band across the disc of the planet. The sun only passes once through the plane of the ring at intervals of 14.7 years; but the earth may pass three times at or near the time of the sun's passage, and on all these occasions the ring will be turned edge-wise towards the earth, and hence is invisible.

It is then that the satellites, free from the glare of the rings, may be easiest seen, seven of them ranging along the line of the Saturnian equator, to which plane the eighth only is sensibly inclined. They are all small and faint, and two only are conspicuous enough to be seen in ordinary telescopes; the whole system is far less interesting or valuable than Jupiter's, and have not been so much studied. One of them, *Japetus*, the most distant and second brightest, has been noticed to be always much fainter at one point of its orbit, and is therefore suspected, like Jupiter's moons, to rotate on its axis in a period equal to its revolution round its primary

Of what kind of matter the rings can possibly be composed has long been a disputed question. That they cannot be solid is certain, since it would be necessary, in order to preserve the equilibrium, that the parts near the planet should revolve much more rapidly than the more distant regions—a motion that would at once tear a solid to pieces. It is possible that they may be fluid; but there are reasons why even a fluid would be liable to fall upon the planet. The inner or “dusky” ring, from its semi-transparency, would seem to be composed of small solid bodies, each revolving in a separate orbit, and not so thickly strewn but that we are able to see through the interstices. It is also possible that the other brighter rings may be similar but denser streams of such small bodies. There may be portions where these are exceptionally dense and numerous, which would explain the variability of brightness of different parts, and the existence of such denser portions would likewise tend greatly towards the stability of the System. The total mass of the rings has been found to be about $\frac{1}{118}$ the planet’s mass.

The mass of Saturn itself has been found by various methods, particularly from the observation of the sixth and largest satellite (Titan). The accepted value is $\frac{1}{35018}$ of the sun’s, from which it will be found, on comparison with the dimensions of the planet already given, that the matter of Saturn must be very light indeed, having but $\cdot1334$ of the density of the earth, or $\cdot756$ of water. The average component matter of Saturn would thus readily float upon water, not being heavier than ordinary deal. Of the satellites we know very little, and even the diameter of the largest is open to question. They are, however, certainly smaller than Jupiter’s, and are probably similar in density to their primary

V. URANUS.

While examining some stars in the constellation of Gemini, on the evening of March 13, 1781, the elder Herschel noticed one which appeared to have a disc.

This he first thought to be a comet; but when sufficient observations of it had been made, it was found to be a planet revolving round the sun exterior to Saturn, at a mean distance of 1,753,850,000 miles, in a period of 30,686·7 days, or more than 84 years. It will readily be understood that this object is too distant for satisfactory examination. It presents to us a very small disc, of uniform brightness, about 4" in diameter, and shines as a star of the sixth or seventh magnitude. It is therefore barely visible to the naked eye when most favourably situated, and is fainter than the minute asteroids, Vesta and Ceres. Its real diameter will be about 33,023 miles.

Uranus is attended certainly by four satellites. They are extremely faint objects, but they are interesting, as forming an anomaly in the solar system. It is to be remarked that all the planets revolve round the sun in orbits but little inclined to the ecliptic. Moreover, all motion, whether that of the planets round the sun or that of rotation on their own axes, is invariably performed in one direction—viz., from west to east. The satellites of the Earth, Jupiter, and Saturn conform to the same characteristics; but when we come to Uranus, we find that its moons revolve in the opposite direction, or from east to west, and further, that the plane of their orbits is inclined to the ecliptic at an angle of $78^{\circ} 38'$, or not far from perpendicular to it. They are thus the sole, but a very remarkable exception to what seems to be a general law of planetary motion. If, as we are led to conclude from analogy, the planet's equator lies nearly in the plane of the orbits of the moons, the axis of rotation of Uranus must lie very nearly in the plane of its own orbit. This would produce the strange effect of bringing the sun vertically over every part of its surface in the course of a revolution. No rotation on an axis has been observed, nor has any spheroidicity been noted with certainty, but the unusual position of the planet's axis offers obstacles to the identification of this fact.

The mass of Uranus has been calculated in various ways; the best estimation is probably $\frac{1}{24,005}$ of the sun's.

Assuming the diameter given above to be correct, and the planet to be spherical, we shall find the density of the planet to be 0.174 as compared with the earth, or 0.99 as compared with water. It is therefore slightly heavier than Saturn. It is noteworthy, that the distance of Uranus is so great that the light and heat of the sun will be only $\frac{1}{388}$ part of the intensity on the earth, and that the apparent diameter of the sun as seen from it, will be but $\frac{1}{20}$ of its diameter as seen by us—facts that must have immense influence on the planetary economy.

The eccentricity of the orbit of Uranus is very nearly the same as Jupiter's, $\frac{1}{21.428}$, but the exact determination of the elements of its orbit was long a perplexing question, for reasons that will be stated in the ensuing section.

VI. NEPTUNE.

A brief consideration of the law of gravitation will lead us to the conclusion that the motion of a planet can never be a strict ellipse round the sun. Every object in the solar system tends to draw it away from its true path with ever-varying force and direction. If it was not that the forces the planets exert upon each other are very small, owing to their great distances from one another, and the great preponderance of weight or attractive power resident in the sun, their motions would be intolerably complicated, and in all probability would have been for ever inexplicable. Fortunately, the effects of planetary perturbations are only very slight disturbances, discernible by the most careful observation. Still, it will be readily understood that the effects of the gravitation of a planet upon the one next it will be sensible, especially if the disturbing body is large, and particularly when the disturbing and disturbed body are in conjunction or have the same longitude, as seen from the sun*—in other words,

* It is often necessary to reckon longitudes and latitudes as seen from the sun; they are then called *heliocentric*. If the centre of the sun be taken as the origin of co-ordinates, and the ecliptic plane of reference, *heliocentric latitude* will be the angular

when they are at the least possible distance from one another.

When Uranus had been observed for some years, careful calculations of its orbit were made, and its path traced out in advance with all possible accuracy, the disturbances produced by Saturn and Jupiter being rigorously taken into account. Yet it was soon found to deviate considerably from its predicted orbit, and suspicions arose as to the possible existence of an ultra-Uranian planet which was causing the deviation. The problem that was then presented to astronomers was to point to the position of a disturbing planet, which should be capable of producing the effects on Uranus which had been observed. This was attempted almost simultaneously by two astronomers, Adams in England, and Le Verrier in France; and notwithstanding the enormous difficulty and novelty of the problem, they each arrived independently, and by different methods, at results in close agreement with one another. A search was then instituted near the place indicated, and it was crowned with success by the discovery of the planet, since called Neptune, very near indeed the predicted place, by Dr. Galle, upon September 23, 1846. This is one of the most brilliant triumphs of astronomical science, and reflects the greatest credit upon the eminent geometers who brought it to so successful a termination.

From the time of the discovery of Uranus (1781) until the year 1822, when the two planets were in conjunction, Neptune had been increasing the velocity of Uranus, and after that date it had been retarding its motion. During

distance of a body north or south of the ecliptic, and *heliocentric longitude* the angular distance measured on the ecliptic from the first point of Aries. The advantage of this system of co-ordinates is, that the sun being fixed, at least with reference to the planets, any change in the latitude or longitude is the effect of an absolute change of direction of the object; whereas, in any change of geocentric latitude and longitude, the absolute movement is necessarily mixed up with the motion of the earth itself. It will be understood that the sun's geocentric latitude being always nothing, the earth's heliocentric latitude will also be nothing; and the sun's geocentric longitude will be the same as the earth's heliocentric longitude, *plus* 180°.

the greater part of the interval it had been drawing Uranus slightly from the sun, with a force which reached its maximum at the conjunction in 1822.

The orbit described by this planet requires no less than $164\frac{1}{2}$ years for its completion, and the mean distance from the sun is 2,746,250,000 miles. Its eccentricity is small, $\frac{1}{1177}$ only. It shines like a star of the eighth magnitude, and has a minute but measurable disc, from which its real diameter has been found to be 38,180 miles; but such delicate measurements are liable to very sensible error. Neptune possesses one minute satellite, and possibly another; so that its mass is better known than might be anticipated. It is equal to $\frac{1}{18.780}$ of the sun's mass. This gives a density of .150 compared with the earth, or .848 compared with water. The sun will shine with only $\frac{1}{300}$ part of its intensity on the earth, and but $\frac{1}{8030}$ part of its intensity on Mercury.

QUESTIONS.

1. To what variations in brilliancy, apparent diameter, and distance from the earth is Mars subject?
2. Give the mean distance of Mars from the sun, and its diameter in miles.
3. What are the sidereal and synodical periods of Mars? In what part of the latter do superior planets retrograde?
4. To what phase is Mars subject, and whence does it arise?
5. What is the mass and density of Mars?
6. State what is known of the climate of Mars. Compare the seasons upon the Earth and upon Mars.
7. Give the time of rotation and the amount of polar compression.
8. Describe the general appearance of this planet. Whence does the redness of its light arise?
9. Compare the intensities of solar light and heat on Mars and the earth.
10. Give the history of the discovery of the asteroids. What is Olbers' hypothesis? What is known of their collective mass and probable numbers?
11. State what is known or conjectured of the magnitude and brightness of the asteroids.
12. Summarize the points of difference between the major and minor planets.

13. Give the extreme limits of the zone of small planets, and the periods of the nearest and most distant of them.

14. State the period and distance of Jupiter; also, its synodical period.

15. What are the limits of the apparent diameter of Jupiter; likewise its real diameter in miles, and the polar compression?

16. Describe its general appearance, and explain the nature of its belts.

17. What is the time of Jupiter's rotation? How has it been found?

18. Give the mass of Jupiter compared with the sun; also, its volume, mass, and density compared with the earth.

19. State the number and relative distances of Jupiter's moons. In what particulars do they resemble our own?

20. State their respective times of revolution round Jupiter.

21. From whence arises the frequent eclipses of the satellites?

22. Explain the various phenomena of the moons as seen from the earth, and how are they modified when Jupiter is in opposition?

23. To what use have the eclipses been applied? With what success?

24. How did the observations of the eclipses lead to the discovery of the velocity of light?

25. What is the most recent evaluation of the velocity of light?

26. Compare the dimensions of Jupiter's moons with our own, and with their primary.

27. What is the mean distance and period of Saturn? and give an illustration of its slow motion.

28. How many and at what distances are the satellites of Saturn?

29. How many and of what nature are its rings?

30. What are the dimensions of this planet? and give a general idea of the size and thickness of the rings.

31. State the time of rotation of Saturn and its ellipticity.

32. What causes contribute to the stability of the rings?

33. Describe the appearance of the rings to an observer on Saturn.

34. Under what conditions are they usually seen from the earth? Explain why the opposite sides are alternately illuminated, and for what time.

35. State a peculiarity in the light of Japetus, and the conclusion drawn from it.

36. Discuss the question of the constitution of the rings. Compare their collective weight with that of Saturn.

37. How has the mass of Saturn been found? What is the result? Give its density.

38. By whom and when was Uranus discovered?

39. State its distance and period ; also, its brilliancy, real and apparent magnitude.

40. What peculiarity is observed in the motion of its satellites ?

41. If this peculiarity extends to the planet's rotation, what would result ?

42. What is the mass and density of Uranus ? What the intensity of solar light and heat there ?

43. Explain the terms heliocentric longitude and latitude. What is the advantage of these co-ordinates ?

44. Why are planetary perturbations always small ? Under what circumstances are they greatest ?

45. Whence arose the difficulty of accounting for the motions of Uranus ?

46. Give the history of the discovery of Neptune.

47. What is its period and mean distance ? Likewise, its real diameter and mass ? How has the mass been found ?

48. Contrast the intensity of light and heat on Neptune with its intensity on the Earth and Mercury.

CHAPTER VII.

I. COMETS.

THROUGHOUT all ages comets have excited the most profound interest, in consequence of their strange and erratic character. Their sudden appearance, their surpassing brilliancy, and their astounding apparent size has ever made them objects alike of dread and of admiration, and has ensured the record of their appearances in all old chronicles. We are thus made acquainted with the apparition of some hundreds of comets, many of them at periods very remote. Still it is certain that a far greater number has escaped without being seen. But few are now found to be visible to the naked eye, compared with those visible only by the aid of the telescope, of which five or six are frequently found each year. Large numbers also must be invisible, in consequence of their orbits lying in such a manner as only to be above the horizon in the daytime. Thus, for instance, one large comet was seen (A.D. 62) during the rare conjunction of a total eclipse of the sun. This fact is recorded by Seneca; and the comet would unquestionably have escaped but for this unusual coincidence. It will appear, therefore, that the number of comets that belong to the solar system must be very large, probably many thousands.

Although assuming an immense variety of forms, comets generally consist of three distinct parts—the *nucleus*, the *coma*, and the *tail*; but not infrequently one or even two of these parts are wanting. The nucleus is a small bright point or disc, situated in the densest part or head of the comet, and sometimes assuming the minute, sharp, and dazzling appearance of a star. This is the solid part of the comet, if indeed any is really so dense, and it is evidently the part upon which the other developments depend. The coma is a nebulous haze surrounding the

nucleus like an envelope of atmosphere, usually semi-circular in the direction of the comet's path, but frequently fading imperceptibly into the third and most remarkable part of the comet—its tail. This latter is usually a hollow conical appendage, stretching often to immense distances, and generally in a direction opposite to the sun. Comets are, however, frequently observed having no tails, and sometimes with more than one, directed in different ways. Frequently the nucleus is wanting, and the comet presents nothing more than a circular or oval, faint, hazy disc.

It is in the latter form that they are usually first descried, and while approaching and passing round the sun the various phenomena and developments occur. As it nears the sun the disc is observed to contract, and eventually a condensed and brighter part is seen to form at or near the centre of the coma, forming gradually a nucleus, the whole slowly increasing in brightness. When still nearer, a bright jet as of gas is projected from the nucleus in the direction of the sun, which, after proceeding a short distance, is gracefully curved round and thrown back in the opposite direction, forming a tail often of enormous length. This is generally brighter at the edges than in the centre, giving it the precise appearance of a hollow cone, to which the coma forms a hemispherical top. The form and direction of the jets are very various, not only in different comets, but in the same comet at different times, and their continuance is apparently capricious. But the rapidity with which a tail is formed by them, and the immense distances to which it extends, plainly indicates the most violent commotion going on in the nucleus of the comet. Most commonly these marvellous changes reach a maximum, and the comet assumes its most splendid appearance shortly after it has passed its perihelion, pointing thus to the sun as the exciting cause; but sometimes the tail has disappeared before the perihelion is arrived at. As the comet leaves the sun it usually goes through similar changes in the opposite order, and appears to absorb again the matter it has emitted, and to return to

the condition in which it was when first seen. Such are the phenomena generally witnessed, but there are many exceptions to the rule, and scarcely two comets can be found that present precisely the same features.

When we come to inquire what is the physical constitution of comets, we are at once involved in difficulty. They are certainly bodies of very little weight or mass, as is proved by the fact that in 1779 a comet passed through the orbits of Jupiter's moons without in the least deranging those bodies. Another comet has twice passed very near to Mercury, but without causing any change in its orbit. It is also certain that the matter of which the coma and tail, and possibly in some cases even the nucleus, are formed, must be of the most extreme tenuity. Faint stars have frequently been passed over, not only by the tails, but by the most dense parts of a comet without any diminution of their brightness; and as such stars would have been totally obscured by a slight fog on the earth's surface only a few yards thick, it follows that the vapour of a comet must be of extreme rarity as compared with such a fog. Refraction through the vapour of a comet should cause a displacement in the position of stars, supposing it to have any conceivable density, but no such displacement has been observed. It would therefore seem that, notwithstanding the enormous dimensions of the tails of comets, they will not weigh more than a few pounds, or possibly ounces. Newton has calculated that a globe of atmospheric air one inch in diameter, carried to an altitude from the earth equal to its radius, would expand itself through all the planetary regions as far as the orbit of Saturn. It is not surprising, therefore, that the atmosphere or gas surrounding a body of so slight a mass as a comet should thus diffuse itself, though it is still impossible to account for the fact that the tail appears to be subject to a strong *repellant* force appertaining to the sun.

There remain, however, many strange phenomena connected with this subject in need of explanation. The matter of which the tail is composed is occasionally, in the

case of comets that approach the sun very nearly, whirled round, entire, through many millions of miles in the space of a few hours, retaining always a direction opposite to the sun, in apparent defiance of all law; and it further seems almost inconceivable that the matter thus emitted can be collected again by the feeble attraction of a comet.

Notwithstanding their small weight and extreme tenuity, they are capable of shining with great brilliancy. Several have been visible in the day time, and some even in close proximity to the sun—as, for example, the great comet of 1843. On the other hand, some are so faint and ill-defined as to be amongst the most difficult objects to observe. They shine, unquestionably, by reflecting solar light—a fact satisfactorily proved by Arago with the aid of his polariscope. This is an instrument devised to distinguish between direct and reflected or *polarized* light, and which depends upon the different course taken by these rays in passing through any doubly-refracting crystal, as Iceland spar. But it is also certain that they shine by their own proper direct light—facts not incompatible. This has been shown by the spectroscope, an instrument that has given us a most astonishing insight into the nature of light and the constitution of the heavenly bodies, but to which it is only possible to allude in the present work. Attempts have frequently been made to prove the existence of phases in comets, but without success. When it is remembered that they are not solid bodies, but are more of the nature of a cloud or smoke, capable of reflecting light among their own particles, phases will be understood to be impossible. The nuclei of some are probably solid, and must exhibit phases, but they are too small to be satisfactorily made out.

To the earlier astronomers the motions of comets were a complete puzzle. The merit of first determining the form of their orbits belongs to Newton. He demonstrated that any curve of the conic sections was compatible with the law of gravitation, and pointed out that the orbits of comets would be in the form of an ellipse of great eccen-

tricity or of a parabola, which is the limiting form of the ellipse—*i.e.*, one whose eccentricity is infinity. The orbit of the comet of 1680, one of the most remarkable of any, was calculated by him, and fully confirmed the views he had expressed only five years before in the *Principia*. Comets are visible only during a short period, when they are passing perihelion, by far the larger part of their extended orbits being performed at distances too remote for them to be seen by us. The orbits of the great majority differ very little, if at all, from a parabolic form during the time that they are visible. This implies either that they will not return to the sun, or that the distances to which their elliptical orbits extend is so enormous that they require the lapse of ages to perform their revolutions. A few have been ascertained with certainty to move in hyperbolic orbits; but generally these differ so little from the parabola as to lead to the suspicion that they have originally had that form, and that the attraction of some planet has so quickened their motion as to give it the form of the hyperbola.* These, of course, can never return to the sun after having once passed perihelion, but must travel on to other systems, or be lost in the immensity of space. The remainder move in orbits of moderate eccentricity.

The inclination of the orbits of comets to the ecliptic is often very great, and in some instances is nearly perpendicular to that plane; their motion also is as frequently retrograde as direct—facts which contrast strongly with planetary characteristics. It has, however, been noted that the comets of short period (seven in number) conform to the planetary rule—namely, direct motion and small inclination to the ecliptic.

The distances of the cometary perihelia from the sun is various, but never very great. The majority approach

* It is to be remarked that the velocity of motion in the parabola is greater than in the ellipse, and in the hyperbola greater than in the parabola, the distances from the sun being supposed equal. This explains, therefore, how a comet can approach the sun so nearly, and yet be able to disentangle itself again from the powerful attraction of that body.

the sun nearer than the earth's mean distance, and all are included within the orbits of the asteroids. Some, however, and these principally the larger and brighter comets, pass extremely near the sun. The great comets of 1680 and 1843 are most remarkable in this respect. The latter approached the sun's surface within 80,000 miles, or less than $\frac{1}{5}$ of the solar radius, and the former to within $\frac{1}{3}$, or 142,000 miles. For a time, therefore, they must have been subjected to a most intense heat—which may possibly account to some extent for the changes which they underwent, as well as for the enormous distance to which their tails extended. The tail of the comet of 1843 had an apparent length of not less than 65° , and its actual length must have been more than *twice* the earth's distance from the sun; and that of the comet of 1680 must likewise have exceeded the same unit of measurement. It has been calculated by Sir J. Herschel that the heat sustained by the former of these comets was equal to 47,000 times that of the sun at the distance of the earth—a temperature more than sufficient to melt cornelian, agate, or rock crystal! How it is possible for these flimsy bodies to sustain this glare, and yet emerge from it none the worse for the exposure, is one of the singular enigmas connected with this subject.

It is to be noted, however, that the intense heat is to some extent compensated by the short time of exposure. This comet was travelling at the rate of 366 miles per second at the time, and in the space of an hour from the perihelion passage, would have escaped to a distance where the glare would be but $\frac{1}{4}$ of that mentioned. Neither is it, perhaps, quite correct to say that they experience no loss from the intense heat, and the changes to which it gives rise. It has been observed that in the case of those comets which return frequently at short intervals, that they appear less bright at each succeeding apparition—pointing to a waste of material from some cause or other.

The aphelion distances of those comets that move in elliptical orbits is often very great, extending far beyond

the orbit of Neptune. Thus the great comet of 1811, one of the most brilliant of the present century, and the length of whose period exceeds 3,000 years, extends to fourteen times the distance of Neptune, or 38,493,000,000 miles. There is good reason to believe that some, retreating to a much greater distance, may return after the lapse of several thousands of years; but since they are only visible at most for a few months, the elements are to some extent uncertain, and a parabolic orbit would equally well satisfy their movements during the short period of their visibility.

It is natural that more interest should be attached to those comets whose periods are comparatively short, although they may be much less splendid objects. Of these the comet of Halley is the first in importance. It was the first whose return was predicted, and which actually came into perihelion at the calculated time. Its orbit was computed by Halley from its apparition in 1682; and from the similarity of its elements with those of other cometary orbits, which he had computed as belonging to comets that appeared in 1378, 1456, 1531, and 1607, he was led to conclude them to be identical. Attributing to it a period of 76 years, he ventured to predict its reappearance in 1759. This comet is frequently retarded by the attraction of the planets, especially Jupiter, and this causes the intervals of its appearance to be rather irregular; but no doubt can exist as to the identity of the comet as seen at the above mentioned dates. It has now twice returned to perihelion—in 1759, when its coming was looked for with the greatest interest, and in 1835. In the first instance it arrived at perihelion within a month of the computed time, and in the second, its orbit being better known, within five days, all the perturbative effects of the planets having been carefully taken into account. The mean distance of Halley's comet from the sun is scarcely so great as that of Uranus, and its aphelion distance is beyond, but not greatly beyond, the orbit of the planet Neptune (3,235,500,000 miles). Several other comets are now known to have orbits similar to this, and together form a group of themselves, possibly having a common origin.

Perhaps even still more interesting is the second family or group of comets of short period, which revolve in orbits for the most part interior to that of Jupiter. Seven members are at present known, having periods varying from $3\frac{1}{3}$ to $7\frac{1}{2}$ years. The first (Encke's) has made twenty-six revolutions since its first discovery by Pons, in 1786, and has been observed at eighteen separate apparitions, upon each occasion forming the theme of the most careful discussions. These have brought to light the important fact, that its period is slowly diminishing at the rate of about $2\frac{1}{2}$ hours each revolution. It follows that the distance from the sun is slowly diminishing, and the conclusion would naturally be, that eventually, in the lapse of ages, the comet must fall into the sun, if not previously dissipated by its heat. Whether any circumstances will avert such a catastrophe is at present quite unknown.

This peculiarity has led to speculations as to its probable cause; and the suggestion of Encke, that there may exist in the inter-planetary space an ethereal medium so rare as not to affect the motions of solid bodies as the planets, but capable of producing a retardation of velocity in comets, has generally been received with favour. The effect of such retardation would evidently be to allow the comet to be drawn nearer the sun, and hence to shorten its period. The *resisting medium* is the name applied to this supposititious ether; but it is quite possible that other causes may be found adequate to account for the observed fact without having recourse to conjectures of this nature. It is nevertheless considered by many astronomers to have a real existence, and to be the true explanation of the shortening of the period of this comet.

Another most interesting member of this group is the comet known as Biela's, which was first seen in 1772, and which has a period of about $6\frac{1}{2}$ years. From the time of its discovery till 1852, when it was last seen, it had made twelve revolutions and been visible six times. From some unknown cause the comet has never been found since the latter date. What renders this comet so extremely in-

teresting is the fact that, during the apparition, in 1846, it was observed to divide into two comets, which attained nearly equal lustre, and which travelled side by side in separate orbits, maintaining a constant distance from each other. At the next return, in 1852, both members were found still travelling in company, but separated by a rather greater interval. The possibility of such an extraordinary circumstance renders the solution of the vexed question of the physical constitution of comets still more difficult; but it may perhaps aid us in understanding how groups of comets come to exist having similar periods.

Of late years, the most splendid comets have been those of 1858 (Donati's) and 1861. The first was remarkable for the brightness of its nucleus, and the marked and graceful curve of its tail. This last is a frequent feature in comets, and is caused by the change of the velocity, since the matter of the tail had been emitted from the nucleus. This was certainly one of the long period comets, requiring more than 2,000 years for one revolution in its elliptical orbit. The comet of 1861 was noted for the great apparent length of its tail (105°), and for the unusual circumstance that the earth passed either through or very near the tail, upon the evening of its first discovery, in the northern hemisphere (June 30, 1861).

The most important discovery of modern times, relating to the theory of comets, is their unexpected and rather mysterious connection with the streams of meteors through which the earth occasionally passes. The most important of these streams is that which gives rise to the well-known shower of November meteors. Upon almost any clear night one or two shooting stars may be seen by a patient observer, but upon certain nights of the year these are much more numerous. Records are not wanting of very remarkable showers occurring at different dates, the earliest being October 13, 902 O. S., and it has been found that similar extraordinary showers have happened at regular intervals of thirty-three years, though the day of

their occurrence advances slowly on the calendar, so as to be equivalent to November 13, N. S. in the present century. The shower is an annual one, but at the intervals stated it assumes a much more imposing character than ordinarily. The explanation of these phenomena is, that there exists an annulus of meteors, or minute planets, revolving round the sun in a long ellipse, and in a retrograde direction, in a period of thirty-three and a quarter years, and that there is one point of the ring where it has a much more considerable density—i.e., where the meteors are more closely packed, than elsewhere. The perihelion of their orbit lies very near the earth's orbit, and that planet meets them and passes through the ring each year, encountering the densest part of it only once in thirty-three years. Of course, the gravitation of the earth attracts the nearest of the group so powerfully as to cause them to fall to the earth, if their extinction is not previously occasioned by the heat evolved in their passage through the atmosphere, which will invariably be the case of all the smaller ones.*

It has been observed further, that the meteors of any night radiate always from some particular point of the heavens—those of November from that point towards which the earth is moving at the moment, yet not precisely so, for the *radiant point* is not on the ecliptic, but considerably to the north of it. From the amount of the deviation it is possible to compute the inclination of the meteoric orbit to the ecliptic. The perihelion distance of the orbit and the longitude of the node are of course none other than the distance of the earth from the sun, and its longitude at the moment that it encounters the densest part of the stream. In this way the elements of the meteoric orbit have been approximately arrived at, when it was soon discovered that they precisely agreed with those of a comet of like period, known as Tempel's comet,

* Specimens of those that have actually fallen are common in museums, and have frequently been chemically analyzed. Some are very small; one, however, is known to exist on the plains of South America too heavy for transportation.

and which had been visible in the year 1866. We are thus obliged to ascribe a community of origin to these bodies and the comet; but of what precise nature is the connection is at present unknown.

A similar discussion has led to the identification of the orbit of another well-known meteoric stream (that causing the annual shower of August 10) with that of a comet observed in 1862. Many other streams of meteors are known to exist, giving rise to annual showers, but of far less imposing character, and each of these have their proper radiant point; but they have not yet been identified with the paths of any known comet. This branch of astronomy is extremely interesting and of growing importance, but we may not refer to it at greater length here. Very much yet remains to be added to our knowledge of meteors, ærolites, &c., and their connection with comets.

QUESTIONS.

1. Give reasons for believing the number of comets to be very great.
2. Describe the several parts of a comet. Give their designations. Are they found in every comet?
3. Describe the general appearance of a comet when first descried. Trace the changes it undergoes during its apparition.
4. What is the usual direction of cometary tails? Describe the phenomena of their development.
5. What is the probable cause of the changes comets undergo? Upon what part do they principally depend?
6. Prove that the mass of a comet is usually insignificant.
7. Prove that the materials composing them is of extreme rarity.
8. Enumerate some of the difficulties to be explained in the phenomena of the tails.
9. Give an illustration of the brightness of comets.
10. How do we know that they shine by their own proper light, and also by reflecting solar light?
11. Should comets present phases? Why have none been observed?
12. Give the possible forms of cometary orbits and an idea of their relative frequency.
13. Compare the relative velocities in each of the three forms.
14. Contrast the inclinations of cometary and planetary orbits. Give one marked case of similarity.

15. State the limits of the distances of comets from the sun in perihelion. Give instances of very near approach.

16. Estimate the amount of heat sustained by the great comet of 1843. What effect had it upon the comet? How long endured?

17. Do comets suffer loss from exposure to the solar heat?

18. Give illustrations of the aphelion distances of elliptical cometary orbits. What is that of Halley's comet?

19. How was the period of Halley's comet established? How nearly to computed time has it returned to perihelion? Why are the intervals irregular?

20. How many comets of short period are known? What are their periods, and within what limit are they for the most part confined.

21. State a peculiarity of Encke's comet, and what must result from it?

22. How is the shortening of its period explained?

23. State a peculiarity of Biela's comet.

24. What were the remarkable characteristics of the comets of 1858 and 1861?

25. Explain the cause of the annual appearance of the November meteors, and also of the extraordinary displays that occur at intervals.

26. What is the period of their orbits and the date of the first recorded extraordinary display?

27. What is meant by the radiant point? How has the orbit of the meteors been determined?

28. With what cometary orbit is the meteor stream coincident? Have similar coincidences been found in any other cases?

CHAPTER VIII.

PERTURBATIONS.

To treat fully of this interesting but complicated branch of astronomy would be far beyond the range of the present work; but it is nevertheless the case that some classes of perturbation are far too important to leave untouched. Of these the precession of the equinoxes, nutation of the earth's axis, and the tides, are examples. The latter, being of the greatest terrestrial moment, will be treated first. A brief sketch of lunar and planetary perturbation will also be appended, that the student may form some notion of their nature; but to trace their causes would in most cases require a higher knowledge of mathematical reasoning than is here assumed.

I. THE TIDES.

A very superficial observation of the tides shows them to depend chiefly on the moon, and this has long been known. The explanation of the manner in which they do so was first given by Newton. The moon's attraction upon the earth, considered as a rigid, solid body, acts upon its centre; but the waters of the ocean vertically below the moon experience and obey a greater attraction, being nearer. An immense flat wave is thus heaped up below the moon. On the other hand, the moon's attraction on the rigid earth being greater than on the waters upon the other side of the globe, a similar wave is left heaped up there also. It is thus the *difference* of the moon's attraction upon the waters on opposite sides of the globe vertically below her that causes the two tidal waves. Secondly, the earth being in rotation, and the moon's attraction always keeping these waves below her, they will clearly traverse the earth, following the diurnal motion of

the moon. The intervals of the arrival of the lunar tidal wave at any place is therefore half the apparent lunar day, or, upon an average, $12^{\text{h}} 24^{\text{m}}$.

It is evident further that the sun will have a precisely similar wave below it, which, in consequence of its great mass, is of considerable height. It is inferior to the moon's, because its much greater distance renders the difference of its attraction on either side of the earth but slight. The proportion is as 25 to 10, or, since the lunar wave in the open sea is $2\frac{1}{2}$ feet in height, the solar will be one foot only. The period of the solar tidal wave will be half a solar day, or about twelve hours. In consequence, however, of the friction met with, neither wave exactly follows the attracting body, and does not arrive, even at places where the land does not further delay it, till about three hours later than the meridian passage of the sun or moon.

It will be observed that the solar wave always gains on the lunar, and that their superposition is inevitable. This of course takes place when the moon is in syzygy, when there will be but two waves, the sum of the effects of both sun and moon. This is called the spring tide. At all other times there will be four tidal waves of unequal height. Practically, however, this is not the case, for a blending of the solar and lunar waves must take place. When the moon is in quadrature (90° distant from the sun), this will be effected by a reduction of the height of high water and a raising of the level of low water. The solar wave will be coincident with the lunar low tide, and will therefore raise it; and the lunar wave alone, tending to produce high water, it will be less than ordinary. These are called neap tides, and the *range* will evidently be small compared with the spring tides.

Another peculiar effect of this blending will be felt on either side of the syzygies. It being remembered that the time of high water does not depend upon the arrival of the solar or lunar wave, but upon the effective height produced by their combination, it will be apparent that before the new or full moon, high water will occur after

the arrival of the lunar wave—*i. e.*, between the crests of the two waves, which are then approaching coincidence. On the contrary, after syzygy the high water will be before the arrival of the lunar wave. The latter is known as the *priming*, and the former as the *lagging* of the tide. In consequence of this, the intervals between high water, though nearly half the lunar day, and on the average during the month exactly that amount, will be subject to a disturbance, giving rise to longer intervals before and shorter intervals after the moon is in syzygy.

To comprehend in some measure the complicated nature of the theory of the tides, which, indeed, has not yet met with a complete mathematical solution, the reader must bear in mind that the lunar day is not itself of equal length, the moon neither moving with uniform velocity nor in the equator.* Further, the height to which the spring tide rises will depend upon the distances of the sun and moon from the earth, being greatest, of course, when they are in perigee. To a still greater degree it depends upon the declination of the sun and moon, since the crest of the wave will be vertically below the attracting body. Other things being equal, the tide will be highest when the sun is on the equator at the equinoxes, the moon not being far off.†

The atmosphere is also affected by similar tidal waves. They are very slight, but may nevertheless be observed by the barometer.

II. PRECESSION OF THE EQUINOXES—NUTATION.

In an early part of this work it was mentioned that the equinoxes were not, strictly speaking, fixed points.

* The same remark applies to the solar day, but to a less extent.

† We have considered the tides wholly independent of the delay and changes the waves undergo in consequence of the tortuous course they are often forced to take. This branch of the subject plainly belongs to physical geography, though often treated of in astronomical books. The establishment of a port, as depending on these features mainly, has also not been mentioned.

This fact was first discovered by Hipparchus, in consequence of its effect of constantly increasing the longitude of all stars, as any motion of the starting point or zero of longitudes must necessarily do. The amount of the movement is about $50''\cdot23$ per year, and it is caused by the attraction of the sun and moon upon the ring of matter situated around the earth's equator. We may evidently consider the spheroidal figure of the earth under this form, and will proceed to trace the effect of the sun's attraction upon it at the four positions of the earth, given in fig. 22. At the solstice, D, the ring is elevated above the sun, but being nearer that body at E than the earth's centre is, the pulling force of the sun tends to bring it into the plane of the ecliptic—in fact, to make E Q coincident with D S, and P p perpendicular to it. If we examine the effect on the ring at the farther side of the earth, we shall find it precisely the same, and also at the other solstice, B. At the equinoxes the sun can have no such tendency; but at every other point it will tend more or less to bring about this result. In the course of time, it would most unquestionably permanently annihilate the inclination of the equator to the ecliptic, if the earth was not in rotation, which not only opposes this movement effectually, maintaining the permanence of direction of the earth's axis and the constancy of the obliquity of the ecliptic to the equator, but forces the perturbation to take another form.*

The effect of the solar attraction is converted from its original tendency, and produces instead a slow retrograde movement of the point of intersection of the two planes along the ecliptic. The manner in which this is produced is not easy to explain, but it may be very simply illustrated. If a top is made to spin, and then forced from perpendicularity, it does not fall to the ground as it would

* It is true, the obliquity of the ecliptic is not an absolutely fixed angle, and is at present very slowly decreasing; but this is owing to other causes—viz., the mutual action of the planets on one another—and further, it is only a secular variation; so that after the lapse of many years it will be changed into an increase of the obliquity, oscillating between certain definite narrow limits.

do if not spinning, but on the contrary, the axis maintains its inclination, and slowly revolves around the perpendicular in the direction of its rotation. This would be an exact illustration of precession, if the action of gravity had been to draw the axis *towards* the perpendicular, as is the case with the earth, and not from it; the révolution of the axis would then have been opposed or retrograde to its rotation.

The time taken for one revolution of the pole of the equator round that of the ecliptic, or, what is the same thing, for the first point of Aries to perform a complete circle round the ecliptic, is 25,800 years. As a consequence, it follows that the pole star is not the same at different epochs. At present the pole of the earth is approaching more nearly the direction of the bright star Polaris, but it will soon begin to recede from it, and some other star coming more nearly in the direction, will then be the polar star. Another effect is the constant changing of the right ascensions and declinations of all stars, planets, &c., since the equinox is the zero, and the motion is along the ecliptic (not the equator). The former will generally increase; the latter, to a less extent, will either increase or decrease, according to their position in the heavens; but though the amount is the same each year, it will not be uniform throughout that period, being nothing when the sun is at the equinoxes. The effect of precession on the length of the year has been already noted.

As in the case of the tides, the greater part of the perturbation is to be attributed to the moon's attraction, and for the same reason; but the lunar precession is subject to an inequality, which causes another change in the position of the earth's axis, and which is known as **Nutation**. The moon's attraction tends to bring the earth's equator, not into the ecliptic, but into the plane of her own orbit, which is inclined to the ecliptic more than 5° . As before stated, the nodes of the moon's orbit are in a state of rapid retrogression (from a precisely similar cause to that which produces the precession of the equinoxes), so that

the inclination of her orbit to the plane of the *equator* varies, during the period of the nodal revolution (nineteen years), from $28^{\circ} 37'$, to $18^{\circ} 19'$ —*i.e.*, by twice the inclination to the ecliptic. The lunar contribution to the effect of precession will therefore vary, and the movement of the poles of the equator round those of the ecliptic will be subject to an undulation on either side, of which the period is nineteen years. In theory these effects are quite distinguishable, that of the nutation being, that the pole is carried round in a minute ellipse, with a major axis of $18.5''$, at the same time that it is carried forward in its proper circle by the general precession. It also will affect the places of all objects, stars or planets.

III. LUNAR AND PLANETARY PERTURBATIONS.

When we consider the simple case of one planet revolving round a central sun, we find that the movement of that body must be a perfect ellipse with the sun in the focus, or still more accurately, both bodies will revolve in ellipses round the common centre of gravity in an equal period and always on opposite sides of that centre. (The sun's mass so enormously exceeding that of any planet, this point is always situated within the sun, and we may thus disregard the motion of that body; such, however, is not the case with the earth and moon.) As soon, however, as a third body is considered, no perfect ellipse is possible. Now, all cases of perturbation reduce themselves to a problem of three bodies—a central, a disturbed, and a disturbing body—which, however, may change places as one or other of them forms the subject of enquiry.

Let us suppose the earth the central, the moon the disturbed, and the sun the disturbing body, and trace the source of one or two of the lunar perturbations. *1st*, When the moon is in quadratures, the sun will attract the earth and moon equally, but along converging lines; it therefore tends to bring them together, or aids the terrestrial attraction. At the syzygies it tends to separate them, because it has the stronger attraction on whichever

is nearest it. It thus tends alternately to increase and diminish the earth's attraction, or it increases the moon's velocity before either syzygy, and diminishes it before either quadrature. The increased velocity at syzygy makes the moon's orbit more straight or flattened there; and the reverse taking place at quadrature, it is there more curved. The observed effect is, that, during the synodical revolution, the moon is twice in advance and twice behind the place she would have occupied if not disturbed by the sun. This is called the moon's variation, and was the first perturbation explained by Newton by the theory of gravitation. *2ndly*, The sun's power to disturb the moon must be greatest in winter, when it is nearest to it; hence arises another inequality depending on the eccentricity of the earth's orbit, and known as the **annual equation**. *3rdly*, Its power must be greater when the moon is performing the half of her orbit nearest the sun, than when in the other half—hence a **parallactic inequality**. Other perturbations consist in the advance of the line of apsides, secular acceleration of its mean motion, but greatest of all is a diminishing of the equation of the centre at the syzygies, and increasing at quadratures, known as the **evection**. There are, besides, others depending on the attraction of Venus.

The planetary perturbations are all small, owing to their great distances from one another. They consist chiefly in changes of their eccentricities,* the positions of the nodes and the line of apsides, and the inclination of their orbits. The major axes of their ellipses are subject to no change, and those of the inclination and eccentricity are secular only, varying within certain narrow limits. It is upon these facts that the law of the stability of the solar system is established.

Another class of planetary perturbations depends upon

* The eccentricity of the earth's orbit is at present slowly decreasing—i.e., it is approaching the form of a circle, which is the limit of its change. At one time very remote, it was nearly four times more than now; so that the earth must have been much nearer the sun at some time of her year than it ever is now, and hence must have had a much higher temperature.

the near commensurability of some of their periods. Thus, five revolutions of Saturn are very nearly equal to eight of Jupiter, and thirteen revolutions of Venus to eight of the earth. The effect is to bring the planets into conjunction (where their attractions on each other are the greatest) at nearly, but not precisely, the same points of their orbits. This produces an acceleration of the motion of one and a retardation of the other, which takes many years to pass through its changes.

As the intention of the present sketch is only to give the reader some idea of what this branch of astronomy treats, and not to give a summary of perturbations, far less their explanations, it is hoped that enough has been said to shew that the law which satisfactorily elucidates these complicated changes effectually, and indeed frequently points them out, to be afterwards verified by observation, can be none other than the true cause of them. Such is the triumphant position, at the present day, of the law of gravitation as it was first enunciated by Newton.

QUESTIONS.

1. Explain the effect of the moon's attraction on the waters of the ocean. Why is a tidal wave formed on the side of the earth removed from the moon?
2. What is the period of the lunar wave? What the cause of its motion? and why is it not directly below the moon?
3. Does the sun produce tidal waves? Compare with the moon's, and explain why the latter is greater.
4. What is the period of the solar wave? What results from the difference of the periods?
5. Explain what is meant by a spring tide; what by neap tide.
6. Explain the priming and lagging of the tides. When do these occur?
7. Why are the intervals of high water not equal?
8. What two causes tend to produce the highest spring tides?
9. Has the atmosphere tidal waves? How shown?
10. By whom and how was the discovery of precession made?
11. Explain the effect of the sun's attraction on the spheroidal earth at the solstices. Where has it no effect?
12. What maintains the constancy of the obliquity of the equator to the ecliptic?

13. Is the obliquity absolutely permanent? Of what nature is the change it undergoes?

14. Give an illustration of precession from the motion of a top. In what does the illustration differ? What lunar perturbation is analogous to it?

15. What is the period of the revolution of the pole of the equator round the pole of the ecliptic?

16. What is the effect of the revolution on the pole star? On stars generally?

17. Whence arises nutation? What is its period? What effect has it on the pole of the equator, considered separately and in conjunction with precession?

18. If the sun had but one attendant planet, describe precisely the motion that would arise.

19. How many bodies have to be considered in discussing any perturbation?

20. What is the effect of the sun's attraction on the earth and moon, when the latter is in quadrature and in syzygy?

21. How is the lunar variation produced?

22. Whence arise the annual equation and the parallactic inequality?

23. Of what nature are the planetary perturbations? Which of the elements does not change? In which is the perturbation secular?

24. Whence arise the inequalities of long period?

25. What change is going on in the eccentricity of the earth's orbit? What effect has that change on terrestrial temperatures?

CHAPTER IX.

SIDEREAL ASTRONOMY.

I. OF THE FIXED STARS.

HAVING now considered all the components of the solar system, there remains only the regions of the fixed stars to be briefly examined. It is a popular error to suppose that these stars are absolutely fixed, although their relative positions are subject to such slight changes that the lapse of many ages would fail to render them perceptible to the naked eye. They are, however, doubtless in rapid motion, and it is their extreme distance only, that produces their apparent fixity. Their numbers are also the subject of some exaggeration. Of the brightest class or magnitude, there are but 20; of the second, 65; of the third, 190; of the fourth, 425; and so on in rapid proportion; so that the total number which are brighter than the sixth or the faintest magnitude, visible to the naked eye, is about 5,000; but even a smaller number—namely, $\frac{2}{3}$, or about 3,300—is all that rise above the horizon in these latitudes, and of course only $\frac{1}{2}$, or 2,500, are all that are visible at any particular instant.

The stars are not equally distributed over the heavens, although no particular grouping of the larger stars can be noticed. When we examine the distribution of the smaller stars, however, from the sixth magnitude downwards to the faintest visible in the largest telescopes, not only are they found to be infinite in number, but certain districts are found to be enormously rich in stars, while others are comparatively barren. The zone of the **Galaxy** or **Milky Way** is the region of special richness. This band of hazy light, so well known to all, has been found to be composed wholly of stars too small to appear individually, but so crowded as to exhibit the hazy light so character-

istic of this portion of the sky. It extends very nearly in a great circle of the heavens, of variable breadth, and sometimes with brief gaps (one of these, in the southern heavens, forms the well-known coal sack), but is generally continuous. During one part of its course it is split into two parallel streams, which eventually unite again. The most probable explanation of the peculiar grouping is, that the solar system is situated towards the centre of a mass of bodies similar to our own sun, which collectively have the form of an immense and somewhat irregular lens. This supposition accounts for the great number of stars of the smaller magnitudes, which lie in the direction of the Milky Way, or that of the breadth of the lens, and which extends to a much greater distance than what we must consider the thickness of the lens, or those much more extensive regions of the sky where the stars are comparatively few. But it must be remembered that the individual members of this group are probably as isolated from one another as we are from them.

It is only within the last fifty years that any satisfactory results have been arrived at regarding the distances of any stars whatever, and still our information on this point is very meagre. In order that this difficult problem may be solved, it is necessary to observe the precise position of a star as seen when the earth is situated at opposite points of her orbit. Such measurements being taken, they must be cleared of the effect of precession during the interval, as well as of the total effect of nutation and aberration; and when these corrections have been made, it is found that the star occupies almost precisely the same position at the two epochs. In this way it has been repeatedly proved that the diameter of the earth's orbit, great as it is, must be absolutely insignificant compared with the distance of the star under discussion. The refined instruments of modern times have, however, at length shown that some very small parallax displacement may be observed and measured for a few stars. In no case does the observed displacement exceed $2''$, or indicate an annual parallax of $1''$. One star (α Centauri) very

nearly approaches this limit, and is believed to be the nearest fixed star. Its annual parallax has been found, with considerable certainty, to be $0''.9158$, which is equivalent to a distance of 20,590,500,000,000 miles, or roughly, twenty billions of miles. Such is the enormous distance of the nearest fixed star! It would require more than $3\frac{1}{2}$ years for light to travel from α Centauri to the earth, though its velocity is equal to 184,000 miles in a second.

There are about ten other stars whose parallax has been found to be sufficiently large to be measurable; and of this group the most interesting is perhaps 61 Cygni. The parallax of this star—and it was the first that yielded a satisfactory result—was determined by Bessel to be $0''.3483$, which is equivalent to a distance of $2\frac{2}{3}$ times that of α Centauri, and to travel which, light would require $9\frac{1}{3}$ years. This star has been found to have a most rapid motion of its own (the fact which pointed it out as likely to be one of the nearest of the stars); and since we have now found its distance, we are able to discover its absolute velocity. It has been found that the star is moving at the rate of 1,280 millions of miles per annum—a fact that at once dispels the idea of fixity. α Centauri has an absolute movement about one-fourth as great.

It is evident that we have at present very insufficient data on which to found general ideas of the average distances of the stars. None have yet been found whose distance is not greater than those of the two above mentioned; but it would appear that although the fainter stars may generally be more distant than the brighter, yet the distance of a particular star cannot be even approximately inferred from its faintness. Thus, the star 61 Cygni is of the sixth magnitude; and some of the first, whose parallax has been determined, are two or three times more distant than it; and in the case of others no sensible annual parallax whatever has been found. Still, it must be accepted that the very faint stars visible in large telescopes must be immensely beyond those visible to the naked eye; and supposing such to be suns equal in

size and brightness to our own, we are obliged to conceive them at distances so remote, that light would take upwards of 3,000 years to reach us from thence. There is thus neither limit of distance nor of number to the fixed stars. Each successive increase of optical power brings into view fainter and fainter specks of light, to which we are obliged to attribute greater and greater distance. These remarks apply principally to the Milky Way, as it is possible, that in other regions the largest telescopes may pierce through the stratum of stars to regions beyond.

The distances of the stars having in a few instances now been found, it becomes an important question to discover, whether there are any means at our command by which we may arrive at some approximate estimation of the dimensions of any of these bodies. The discs of stars which are seen in good telescopes being known to be spurious—*i.e.*, produced by optical phenomena, and no true indication of the diameter of the star—we are obliged to judge solely by a comparison of their light with that of the sun. Notwithstanding the difficulty of such an unequal comparison, it has been effected; and the general result is, that if the sun was removed to the distance of the fixed stars, it would shine as a star of average magnitude. In the case of α Lyræ, the brightest star in the northern heavens, and whose parallax is $0''\cdot261$, it has been found that its intrinsic brilliancy is three and a-half times that of the sun; or, supposing their surfaces equally bright, the diameter of the star will be nearly twice that of the sun. From a similar comparison with Sirius, the most brilliant of all the stars, and whose parallax is only $0''\cdot150$, it has been found that the sun has probably but $\frac{1}{150}$ part of the lustre of this star, and that supposing its surface no more brilliant than the sun's, it must have a diameter more than twelve times as great as it. On the other hand, 61 Cygni, and the next four nearest stars at present known as such, must be many times less in splendour and size to our own sun.

When the positions of stars, as observed at remote epochs, are compared, due allowance having been made for precession, &c., it is found that many, and perhaps all

have more or less motion, so slight as only to be perceptible after long intervals, yet certainly established, and generally uniform in direction and amount for each star. 61 Cygni has a motion exceeding 5" per year; but this is exceptionally great, the vast majority of even bright stars having much less proper motion than this. If, however, this motion was found to be general and similar in direction for all stars—if there was a tendency manifested for all stars to move away from one particular spot in the heavens, and to crowd together towards a spot diametrically opposite to this—the cause would clearly have to be traced to the movement of the sun, with its attendant planets in space, towards that point from which the stars appeared to move, rather than to the fact that all the stars had a common motion. This has been found to be the case; and though there are still outstanding independent motions, belonging doubtless to the stars themselves, and various in direction, still a large part of the movement of all the stars used in the determinations (a very considerable number) is accounted for by supposing the sun to be in motion towards a particular spot in the heavens, near to a star called α Herculis. The amount of this proper motion of our own sun in a year, has been found to be equal to $1\frac{2}{3}$ times the earth's radius vector, or about 150 millions of miles. It is impossible at present to determine more than the direction and velocity of the sun's motion, and ages must elapse before it can be found whether its path deviates from a straight line, and if curved, round what point and in what precise figure.

OF DOUBLE AND VARIABLE STARS.

When the fixed stars are examined individually, either by the unaided eye or by the telescope, they are found to differ from each other in more respects than simply in brightness. Telescopes of very small power are frequently able to resolve a single star into two or more stars situated very close to each other. These are known as **Double**

or **Multiple stars.** In very many cases the two component stars are unequally bright, and may be at immense distances from one another, being simply situated very nearly in the same direction, as regards the spectator. Such are said to be only **optically double**, their apparent nearness being the effect of perspective, and they are only interesting in so far that the more distant, and hence more fixed star, may help to bring to light either the proper motion or the parallax of its brighter and nearer companion, by means of the measurement of their angular distances at different epochs.

It is, however, very frequent to find the stars nearly equal in brightness, and so conspicuous that their nearness, on the law of chances alone, can only be accounted for by supposing a physical connection. This is occasionally still further confirmed by finding that the two components have a precisely similar proper motion. It is not, however, usually assumed that they are actually connected, until some revolution of the one round the other has been observed. They are then classed as **binary stars**, or systems connected by the law of gravitation, and their relative motions, as they revolve slowly around each other, are watched with great interest. Sir William Herschel was the first who made extensive searches for double stars, and measurements of their relative positions and angular distances, with the view of detecting, after a time, any motion of the one star round the other. At the present day as many as 650 have been clearly established to be true binary systems, and many others will probably, in the course of some years, be added to the number. The components of these are by no means invariably equal in brightness; so that large numbers at present classed as optically double only, may be found to be physically connected, though many of that purely casual class must exist. The total number of double stars known is about 6,000.

From the relative positions and distances of binary stars at different epochs, it has been found possible to determine the elements of the stellar orbits, and to estab-

lish the strict applicability of the law of gravitation to these distant suns. A very few have made complete revolutions since they have become objects of exact measurement, and many have performed a considerable part of a revolution. Their orbits are ellipses (sometimes viewed so as to be much foreshortened) round their common centre of gravity, and performed in various periods—from 30 to 1,000 years. Both the stars α Centauri and 61 Cygni are well-known binary systems, and their parallax being known also, we are able to find the absolute dimensions of their orbits with pretty close approximation. The components of the former star are about as distant from each other as Uranus from the sun, and those of the latter about half as far again as Neptune, exceeding the aphelion distance of Halley's comet.

Another peculiarity of individual stars, and which is found to exist very conspicuously in the case of double stars, is variety of colour. The great majority of all stars are white or pale-yellow, like our own sun, but many also have most pronounced and deeply-marked colours. The most interesting and numerous class of isolated coloured stars are those which shine with a red light, of which about 300 examples are known, varying from the deepest crimson to orange. The orange and yellow stars also form a numerous class; but very few indeed, of any other colour are to be found among isolated or unaccompanied stars. In double stars, however, it is frequent to find the two members of different and strongly contrasted colours, as red and green, yellow and blue, orange and purple. This, in some cases, may be purely the effect of contrast, the fainter star being really white, but it is also shown to be actually the case in many instances. If such systems are surrounded by revolving planets, the inhabitants (if any) will have days of variously-coloured light. It is frequent also to find the components of a double star similar in colour, but the fainter of a deeper tint.

There is some reason to believe that the colour of a star may vary; and in one instance—that of the bright

star Sirius—it is historically ascertained that a change of colour has taken place. To the ancients this star was undoubtedly red, and was classed by them with α Orionis, Aldebaran, and others that have still that colour; but Sirius is now a brilliant white star. A temporary star that was seen in 1572 by Tycho Brahé still more certainly changed its colour. This star was only visible for seventeen months, appearing suddenly of a most brilliant white lustre. It was afterwards seen to change to yellow and red, and then again, as it was growing fainter, to white again.

The apparition of temporary stars is so rare a phenomena that very little is known about them. The star above mentioned is the most remarkable, and of recorded instances is perhaps the brightest, having been visible in the daytime. They have always been considered as periodical; but perhaps this is doubtful. About twenty instances are on record of the sudden appearance of a new star, but in no case has it long retained the brightness with which for a period it shone; so that a temporary catastrophe, rather than a natural increase of lustre, would appear to be the cause of the change. This is strongly confirmed by the latest apparition of a new star, which occurred in 1866, in Corona, when a very small but known and permanent fixed star suddenly attained the second magnitude, and slowly faded, with slight alternations during several months, till it reached its original degree of faintness. The spectroscope revealed the astonishing fact that this additional brightness was caused by the ignition of the gas, hydrogen. It must be remembered that, owing to the gradual propagation of light, this catastrophe must have happened many years, possibly many ages, before it was seen by us. Whether all temporary stars are produced by like catastrophes, or whether they are simply variable in brightness, taking a long interval for their periodical changes, must for the present remain unsettled. Connected with this subject is the fact, that some stars known and catalogued by the

astronomers of ancient times have now entirely disappeared.

The next class of stars that we have to consider resembles in some degree the temporary stars—that is, they are found to be variable in their magnitude or brightness. They form a tolerably large class, of which each member has its own distinctive features. One of the best known, and whose variability is most easily recognizable, is α Ceti. It varies from the second to the twelfth magnitude in a period little less than a year (331.34 days). It maintains its maximum brightness about fifteen days only, and is invisible to the naked eye during five months. Another well known variable (Algol or β Persei) strongly suggests the presence of some dark body revolving round it, and periodically occulting it partially. It is usually of the second magnitude, but suffers a diminution to the fourth magnitude for the space of a quarter of an hour, at intervals of only 2.867 days. The southern star, η Argûs, is still more remarkable, its changes being so capricious that it has not been found possible as yet to establish a regular cycle of them. It is sometimes as faint as the sixth magnitude, and at others ranks among the brightest of first magnitude stars, being surpassed by Sirius alone. The above are given as examples of the nature of stellar variability; but a few stars are known that totally disappear for a time, and regularly attain to very considerable brightness, while in others the variation is but slight, requiring careful comparison to be detected at all. The periods are various, but many, and these the most remarkable, do not exceed a year—in some, as Algol, it is only a few days.

The rapid changes of intensity of light, as well as of colour of stars, known as scintillation or twinkling, are unconnected with the stars themselves. They form one of the numerous phenomena of interference depending on the undulatory motion of light, when passing through strata of various densities. For this reason twinkling takes place mostly near the horizon, where the ray has to pass

through a very thick stratum of air. In tropical regions, where the atmosphere is more homogeneous, twinkling is never noticeable except very near the horizon. The planets do not twinkle, owing to their comparatively large discs, and the light of some stars appears to scintillate more than that of others.

III. CLUSTERS OF STARS—NEBULÆ.

Small local aggregations of stars exist in many parts of the heavens, besides the great concentration in the ring of the galaxy. A few of these are sufficiently bright to be seen by the naked eye. The Pleiades will occur to every one as a rich spot, and others, as Præsepe in Cancer, the sword-hilt of Perseus, &c., may be found as hazy spots of light when viewed by the unaided eye, which a very slight optical power shows as clusters of stars. Several thousands of these groups lie scattered over the heavens; and in some the stars are so densely packed, and are so very minute, that a powerful telescope is required to show them as composed of separate individual stars; and there are still some which defy the highest optical means that can be brought to bear upon them, and which remain as faint milky patches, resembling cloud, under the highest magnifying powers. The term *nebula* is applied to these irresolvable groups, though many of them, and at one time all, were thought to have a structure entirely distinct from vaporous cloud.

True nebulae, it is now known, really exist, and that there are, at the most extreme distances from us, immense tracts of nebulous matter capable of radiating light, and subject possibly to the dynamical laws peculiar to themselves. Some of these patches extend over an apparent area several times greater than the moon, and their real dimensions must be enormous beyond anything of which we can form conception. Their forms, too, are as various as their character is anomalous; and there are not wanting

suspensions of strange alterations of form and brilliancy, which have invested these distant objects with a great deal of interest. They have been divided into several classes, according to their form, but perhaps not altogether successfully. Thus the elliptical nebulæ constitute one well-marked class—this form being frequent. One of these, in Andromeda, is bright enough to be visible to the naked eye, and has often been mistaken for a comet. Sometimes nebulæ present a flat planetary disc, at others strangely convoluted spiral forms. Some are found circularly surrounding a star, which is frequently a red one; but many most important, large, and bright nebulæ are so irregularly shaped as to defy classification.

When the distribution of these nebulous spots over the heavens is examined, they are found to be extremely numerous near the poles of the Milky Way—that zone itself being nearly destitute of them. Easily resolvable clusters are found, on the contrary, to be more numerous in the vicinity of the galaxy. In the southern hemisphere both clusters and nebulæ are extremely numerous in two spots, which thus present a remarkable appearance to the naked eye, and are known as the Magellanic clouds.

It may be conjectured that clusters are distant congeries of stars, similar to the bright galaxy of which our own sun forms probably an individual member; but it is necessary in this case to assume their distances as being most enormous, so that light would require many thousands of years to reach us from thence. The faintness of the component stars in most cases favours this supposition, however. For any insight into the physical constitution of the nebulæ proper, we must wait till the continually increasing powers of our telescopes enable us with more ease and certainty to delineate their forms and trace their changes. They are probably, at least, as distant as the clusters; but their nature is such that we cannot hope for an early solution of the difficulties involved.

QUESTIONS.

1. Give some idea of the numbers of the brighter stars, and of those visible to the naked eye.

2. What is known of the distribution of the fainter stars, and whence arises the nebulous light of the Milky Way?

3. How is the grouping of the smaller stars explained?

4. How are the parallaxes of the stars measured, and with what general results?

5. State the parallax and distance of the nearest fixed star, and the time of its light reaching the earth.

6. Give the same particulars for 61 Cygni, the second nearest star. For what is 61 Cygni remarkable?

7. To what extent is the faintness of stars a guide to their distances?

8. How do we arrive at an estimate of the true dimensions of stars? State some results of such estimation.

9. How is the proper motion of a star found?

10. Supposing the sun to be in motion, what effect would be noticeable in the fixed stars? Is this effect really observed?

11. Does the supposition of the sun's movement in space account for all the observed proper motions? Towards what star is the sun moving, and with what rapidity?

12. What is meant by double and multiple stars? Distinguish between optically double and binary stars.

13. What may the observation of optically double stars bring to light? State the reasons for believing binary stars to be actually connected.

14. State the number of known double stars, and of these, how many are recognized binary systems?

15. In what orbits do the binaries revolve, and in what periods? Give the dimensions of the orbits of 61 Cygni and α Centauri.

16. What colours predominate among isolated stars? State the number of known red stars.

17. What peculiarities are frequently observed in the colours of double stars?

18. What is the colour of the star, Sirius? Has it changed?

19. State peculiarities of colour and brightness of Tycho Brahe's temporary star.

20. How many instances of temporary stars are on record? Give the history of the star of 1866. Have stars disappeared permanently?

21. Give examples of variable stars, the amount and period of their variability.

22. What is the suspected cause of the variability of Algol? Within what limits are the periods of variables mostly confined? What southern star is a notable exception?

23. To what cause is the scintillation of stars traceable? Why is the phenomena little noticed in the tropics?

24. What are clusters? Distinguish them from nebulae. Do true nebulae exist?

25. Give some classes into which nebulae have been divided.

26. Where are nebulae mostly found? Where clusters?

27. What are the Magellanic clouds? What is the coal sack? Explain the probable constitution of clusters.

INDEX.

- ABERRATION, 62.**
 Aberration, diurnal, 63.
 Aberration time, 63.
 Achromatism, 39.
 Adams, 133.
 Airy, 13.
 Albedo, 103.
 Algol, 166.
 Altair, 28.
 Altazimuth, 39.
 Altitude, 27.
 Angle of the vertical, 55.
 Annular eclipse, 106.
 Anomaly, 49.
 Aphelion, 48.
 Apogee, 97.
 Apsides, line of, 49.
 Arago, 140.
 Aristarchus, 58.
 Asteroids, number known, 118.
 " size of, 119.
 " their brilliancy, 119.
 " orbits, 119.
 " periodic times, 120.
 Atmosphere, constitution of, 19.
 Augmentation of moon's semi-diameter, 98.
 Axis of the earth permanent in direction, 88.
 Azimuth, 27.
 " error of, 34.

BASE line, measurement of, 11.
 Bessel, 13, 160.
 Binary stars, 163.
 " number recognized, 163.
 " orbits of, 164.
 " distances and periods of, 164.
 Biela's comet, 144.
 Bode's law, 68.
 Bradley, 61, 125.

CALENDAR, arrangement of, 43.
 Camilla, 120.
 Cancer, tropic of, 29.
 Capricorn, tropic of, 29.
 Cavendish experiment, 96.
 Ceres, 119.
 Chromatic dispersion, 39.
 Chromosphere, 78.

 Clusters of Stars, 167.
 Collimation, line of, 34.
 " error of, 34.
 Coma, 137.
 Comets, probable numbers, 137.
 " changes of form, 138.
 " mass of, 139.
 " their tenuity, 139.
 " brilliancy, 140.
 " orbits, 140.
 " inclination of orbits, 141.
 " heat sustained by, 142.
 " perihelia of, 141.
 " aphelia of, 142.
 " tails of, 142.
 " of Halley, 143.
 " of Encke, 144.
 " of Biela, 144.
 " of Donati, 145.
 " orbits identical with those of meteors, 145.
 " Tempel's, 146.
 Conic sections, 53.
 Conjunctions of inferior planets, 66.
 Conservation of areas, law of, 49.
 Copernicus, 47, 115.
 Corona, 78.
 Craters of the moon, 104.
 Cyclones, rotation of, 18.

DAY, sidereal, solar, and lunar, 41.
 Declination, 28.
 Diffraction, 83.
 Dip of the horizon, 10.
 Direct motion, 46.
 Dollond, 39.
 Double stars, 162.
 " their numbers, 163.
 " colours, 164.
 " orbits, 163.

EARTH, curvature of, 10.
 " its diameter, 13.
 " form, 9.
 " circumference, 12.
 " ellipticity, 13, 16.
 " eccentricity of orbit, 88.
 " bulk, 93.
 " density, 94, 97.

- Earth, mean distance from sun, 88.
 its distance how found, 59.
 " rotation of, 14.
 Earthshine, 103.
 Eccentricity, angle of, 49.
 " of planetary orbits
 liable to change, 153.
 Eclipse of the moon, 105.
 " sun, 106.
 Eclipses of Jupiter's satellites, 123.
 Ecliptic, 30.
 Elongations of inferior planets, 66.
 Encke, 144.
 Epact, 99.
 Equation of the centre, 49.
 " time, 42.
 Equatorial, 38.
 Equatorial horizontal parallax, 53.
 Equinoctial, 28.
 " colure, 32.
 Equinox, 29.
 Evection, 155.

FACULÆ, 76.
 First point of Aries, 28.
 " Libra, 31.
 Flora, 120.
 Focus, 33.
 Foucault's pendulum experiment,
 14.
 Frequency of eclipses, 110.

GALAXY, 158.
 Galileo, 72, 122, 124.
 Glass specula, 40.
 Gravitation, law of, 54.
 Great Bear, 32.
 Gregorian Calendar, 44.
 Gregory, 39.
 Gyroscope, 15.

HALLEY, 60.
 Harvest moon, 98.
 Heliocentric co-ordinates, 133.
 Herschel, 73, 130.
 Hipparchus, 47, 152.
 Horizon, rational, 108.
 Hour angle, 31.
 Hyperbolic orbits, 141.

 Inferior Planets, 66.
 Irradiation of Light, 82.

JAPETUS, 129.
 Julian Calendar, 43.
 Jupiter, apparent diameter, 120.
 " brilliancy, 120.
 " bulk, mass, and density
 of, 122.
 " belts of, 121.
 " distance from sun, 120.
 " ellipticity of form, 120.
 " eccentricity of orbit, 120.
 " real diameter, 121.
 " rotation of, 122.

 Jupiter, satellites, 122.
 " sideral and synodical
 periods, 120.
 " spots upon, 121.

KEPLER, 47, 82, 115.
 Kepler's laws, 47.

LARISSA, eclipse of, 111.
 Latitude, 30.
 " geographical, to find, 91.
 " length of degree of, 12.
 Level, error of, 34.
 Le Verrier, 133.
 Libration, diurnal, 101.
 " in latitude, 100.
 " in longitude, 101.
 Light, aberration of, 62.
 " velocity of, 125.
 Limits of visibility of eclipses, 107.
 Longitude, 30.
 " terrestrial, to find at
 sea, 92.
 Lunar ecliptic limits, 109.
 " perturbations, 154.
 Lunation, 99.

MAGELLANIC clouds, 168.
MARS, apparent diameter, 115.
 " brilliancy, 115.
 " climate of, 117.
 " distance from sun, 113.
 " phases of, 116.
 " polar compression of, 118.
 " eccentricity of orbit, 115.
 " real diameter, 115.
 " intensity of light on, 117.
 " sideral and synodical re-
 volutions, 115.
 " mass and density, 116.
 " rotation of, 117.
 " surface of, 118.
 Mean solar day, 41.
 Mean sun, 42.
MERCURY, apparent diameter, 68.
 " distance, 81.
 " eccentricity of orbit, 81.
 " mass and density of, 82.
 " transits of, 82.
 " mountains on, 82.
 " real diameter, 81.
 " rotation of, 81.
 " sideral and synodical
 periods, 80.

 Meridian, 31.
 Meridional arc, 12.
 Meteors, 145.
 Metonic cycle, 100.
 Milky way, 158.
MOON, mean distance of, 97.
 " apparent diameter, 97.
 " real diameter, 98.
 " bulk of, 98.
 " mass and density, 101.
 " gravity on surface, 102.

- Moon, sidereal and synodical re-**
 volutions, 99.
 " rotation of, 100.
 " eccentricity of orbit, 97.
 " probable form, 98.
 " inclination of orbit, 98.
 " phases, 102.
 " mountains on, 104.
 " parallax, how found, 57.
Motion, laws of, 51.
Mountains, attraction of, 93.
Mural circle, 33.
NADIR, 27.
Nebulae, 167.
 " classification of, 168.
 " distribution of, 168.
Neptune, discovery of, 133.
 " period, 134.
 " distance, 134.
 " diameter, 134.
 " mass and density, 134.
 " intensity of light upon,
 134.
 " eccentricity of orbit, 134.
Newton, 51, 95, 140, 149.
Nodes, line of, 50.
 " lunar, retrogression of,
 110.
Noon, mean and apparent, 42.
Nucleus of comets, 137.
 " of solar spots, 73.
Nutation, 153.
OBJECT glass, 33.
Oblate spheroid, 13.
Obliquity of the ecliptic, 32.
 " its variation secular, 152.
Occultations, 103.
 " of Jupiter's satel-
 lites, 124.
Octants, 103.
Obers, 118.
Opposition, 66.
PARABOLIC orbits of comets, 141.
Paraboloid of revolution, 39.
Parallaxic inequality, 155.
Parallax, 56.
 " of the moon, 57
 " of the sun, 58.
 " of Mars, 61.
 " annual, 61.
 " of stars, 159.
 " correction for geocen-
 tric, 37.
Pendulum, length of, 16.
 " Foucault's, 14.
 " density of the earth
 measured by, 95.
Penumbra, in eclipses, 106.
 " of solar spots, 73.
Perigee, 97, 125.
Perihelion, 48.
Periodic times, law of, 43.
Perturbations, 55, 149, 154.
Phases of inferior planets, 67.
 " of the moon, 102.
Photosphere, 74.
Planets, superior and inferior, 66.
 " retrogradations of, 46, 83,
 116.
 " phases of, 67, 116.
Pleiades, 167.
Plumb line, direction of, 12, 55.
Polar distance, 31.
Polariscope, 140.
Poles, celestial revolution of,
 153.
 " of ecliptic, 32.
Pope Gregory XIII., 43.
Præsepe, in Cancer, 167.
Precession of the equinoxes, 151.
Priming and lagging of the tides,
 151.
Principia, 141.
Ptolemaic system, 47.
Proper motion of stars, 162.
 " of the sun, 162.
Pythagoras, 47.
QUADRATURE, 102.
RADIANT point of meteors, 146.
Radius vector, 48.
Redness of moon in eclipse, 112.
Reformation of calendar, 43.
Reflecting telescopes, 39.
Refraction, 20.
 " law of atmospheric,
 21.
Resisting medium, 144.
Retrograde motion, 46.
Right ascension, 28.
Rings of Saturn, 127.
 " their dimensions, 123.
 " phases of, 129.
 " inclination, 129.
 " physical constitution of, 130.
 " mass, 130.
Roemer, 32, 62, 124.
Rotation, diurnal, 13.
 " " proof of, 14.
 " of planets, 68.
 " of Saturn's rings, 123.
SAROS, 110.
Satellites of Jupiter, 122.
 " their distances, 123.
 " periodic times, 123.
 " eclipses of, 123.
 " rotation, 123.
 " their dimensions, den-
 sity, and mass, 126.
 " of Saturn, 127.
 " their inclination, 129.
 " of Uranus, 131.
 " of Neptune, 134.
Saturn, distance of, 127.
 " eccentricity of orbit, 127

- Saturn, sidereal and synodical periods, 127.
 " diameter, 128.
 " ellipticity, 128.
 " rotation, 128.
 " mass and density, 130.
 " rings of, 127.
 " satellites, 127, 129.
 Schehallien experiment, 93.
 Schwabe, 74, 77.
 Scintillation, 166.
 Seasons, 89.
 Sidereal day, 41.
 " time, 35.
 " year, 43.
 Sirius, 28, 161, 165.
 Solar day, 41.
 " eclipse, theory of, 106.
 " " phenomena witnessed during, 77.
 " ecliptic limits, 109.
 " system, 66.
 " " general view of, 69.
 Solstice, 29.
 Solstitial Colure, 32.
 Spectroscope, 140, 165.
 Speculum, 40.
 Spheres, attraction of, 55.
 Spots on the sun, description of, 72.
 " degree of light from, 73.
 " magnitude of, 73.
 " duration, 74.
 " explanation of, 74.
 " regions where found, 76.
 " periodicity, 77.
 Stars, diurnal movements of, 13.
 " numbers and magnitude of, 158.
 " distribution, 158.
 " parallax of, 159.
 " proper motion of, 160.
 " estimated size of, 161.
 " double, 162.
 " coloured, 164.
 " variability of colour in, 164.
 " temporary, 165.
 " missing, 165.
 " variable, 166.
 Style, old and new, 44.
 Sun, distortion of figure on horizon, 22.
 " parallax of, 60.
 " apparent and real diameter 70.
 " distance from earth, 70.
 " bulk, 70.
 " mass and density, 71.
 " gravity on surface, 72.
 " rotation of, 72, 75.
 " atmospheres, 78.
 " heat received from, 79.
 " motion in space, 162.
 Superior planets, 66.
 Survey, trigonometrical, 11.
 Synodical revolution, 67.
 Syzygy, 103.
 TELESCOPE, 33.
 Terminator, 104.
 Thales, eclipse of, 111.
 Tides, cause of, 149.
 " spring and neap, 150.
 " priming and lagging of, 151.
 " atmospheric, 151.
 Time, measurement of, 40.
 Titan, 130.
 Trade winds, cause of, 17.
 Transit instrument, 32.
 " circle, 37.
 Transits of inferior planets, 59, 82.
 Tropics, 29.
 Tropical year, 43.
 Twilight, explanation of, 22.
 " duration, 24.
 Tycho Brahé, 35, 47, 165.
 ULTRA-ZODIACAL planets, 119.
 Umbra, 106.
 Uranus, discovery of, 130.
 " distance, 131.
 " period, 131.
 " real and apparent diameter, 131.
 " satellites of, 131.
 " mass and density, 131.
 " eccentricity of orbit, 131.
 " intensity of light on, 132.
 VARIATION, lunar, 155.
 Velocity of light, 125.
 " of motion in orbits, 141.
 Venus, transits of, 59, 85.
 " distance, 83.
 " eccentricity of orbit, 83.
 " sidereal and synodical periods of, 83.
 " apparent diameter, 68.
 " true diameter, 83.
 " mass and density of, 84.
 " brilliancy, 84.
 " rotation, 84.
 " atmosphere, 84.
 " mountains on, 85.
 Vesta, 119.
 WEIGHT of bodies in different latitudes, 15.
 ZENITH, 27.
 " distance, 31.
 " sector, 12, 93.
 Zodiac, 50.
 Zodiacal light, 79.

COLLINS' ELEMENTARY AND ADVANCED SCIENCE SERIES,

Adapted to the requirements of the South Kensington Syllabus, for Students in Science and Art Classes, and Higher and Middle Class Schools.

ELEMENTARY SERIES,

Printed uniformly in Fcap. 8vo, fully Illustrated, cloth lettered, price 1s. each.

1. PRACTICAL PLANE & SOLID GEOMETRY. By H. Angel, Islington Science School, London.
2. MACHINE CONSTRUCTION AND DRAWING. By E. Tomkins, Queen's College, Liverpool.
- 3A BUILDING CONSTRUCTION—STONE, BRICK, AND SLATE WORK. By R. S. Burn, C.E., Manchester.
- 3B BUILDING CONSTRUCTION—TIMBER AND IRON WORK. By R. S. Burn, C.E., Manchester.
4. NAVAL ARCHITECTURE—SHIPBUILDING AND LAYING OFF. By S. J. P. Thearle, F.R.S.N.A., London.
5. PURE MATHEMATICS. By Lewis Sergeant, B.A., (Camb.) London.
6. THEORETICAL MECHANICS. By William Rossiter, F.R.A.S., F.C.S., London.
7. APPLIED MECHANICS. By William Rossiter, F.R.A.S., London.
8. ACOUSTICS, LIGHT AND HEAT. By William Lees, A.M., Lecturer on Physics, Edinburgh.
9. MAGNETISM AND ELECTRICITY. By John Angell, Senior Science Master, Grammar School, Manchester.
10. INORGANIC CHEMISTRY. By Dr. W. B. Kemshead, F.R.A.S., Dulwich College, London.
11. ORGANIC CHEMISTRY. By W. Marshall Watts, D.Sc., (Lond.), Grammar School, Giggleswick.
12. GEOLOGY. By W. S. Davis, LL.D., Derby.
13. MINERALOGY. By J. H. Collins, F.G.S., Royal Cornwall Polytechnic Society, Falmouth.
14. ANIMAL PHYSIOLOGY. By John Angell, Senior Science Master, Grammar School, Manchester.
15. ZOOLOGY. By M. Harbison, Head-Master Model Schools, Newtonards.
16. VEGETABLE ANATOMY AND PHYSIOLOGY. By J. H. Balfour, M.D., Edinburgh University.
17. SYSTEMATIC AND ECONOMIC BOTANY. By J. H. Balfour, M.D., Edinburgh University.
19. METALLURGY. By John Mayer, F.C.S., Glasgow.
20. NAVIGATION. By Henry Evers, LL.D., Plymouth.
21. NAUTICAL ASTRONOMY. By Henry Evers, LL.D.
- 22A STEAM AND THE STEAM ENGINE—LAND AND MARINE. By Henry Evers, LL.D., Plymouth.
- 22B STEAM AND STEAM ENGINE—LOCOMOTIVE. By Henry Evers, LL.D., Plymouth.
23. PHYSICAL GEOGRAPHY. By John Macturk, F.R.G.S.
24. PRACTICAL CHEMISTRY. By John Howard, London.
25. ASTRONOMY. By J. J. Plummer, Observatory, Durham.

London, Edinburgh, and Herriot Hill Works, Glasgow.

ADVANCED SCIENCE SERIES,

Adapted to the requirements of the South Kensington Syllabus, for Students in Science and Art Classes, and Higher and Middle Class Schools.

Printed uniformly in Post 8vo, averaging 350 pp., fully Illustrated, cloth lettered, price 2s. 6d. each.

1. PRACTICAL PLANE AND SOLID GEOMETRY. By Professor F. A. Bradley, London.
2. MACHINE CONSTRUCTION AND DRAWING. By E. Tomkins, Queen's College, Liverpool.
3. BUILDING CONSTRUCTION. By R. Scott Burn, C.E.
4. NAVAL ARCHITECTURE—SHIPBUILDING AND LAYING OFF. By S. J. P. Thearle, F.R.S.N.A., London.
5. PURE MATHEMATICS. By Edward Atkins, B.Sc., (Lond.,) Leicester.
6. THEORETICAL MECHANICS. By P. Guthrie Tait, Professor of Natural Philosophy, Edinburgh.
7. APPLIED MECHANICS. By Professor O. Reynolds, Owens College, Manchester.
8. ACOUSTICS, LIGHT AND HEAT. By W. S. Davis, LL.D., Derby.
9. MAGNETISM AND ELECTRICITY. By F. Guthrie, B.A., Ph.D., Royal School of Mines, London.
10. INORGANIC CHEMISTRY. By T. E. Thorpe, Ph.D., F.R.S.E., Professor of Chemistry, Andersonian University, Glasgow. 2 Vols.
11. ORGANIC CHEMISTRY. By James Dewar, F.R.S.E., F.C.S., Lecturer on Chemistry, Edinburgh.
12. GEOLOGY. By John Young, M.D., Professor of Natural History, Glasgow University.
14. ANIMAL PHYSIOLOGY. By J. Cleland, M.D., F.R.S., Professor of Anatomy and Physiology, Galway.
15. ZOOLOGY. By E. Ray Lankester, M.A., (Oxon.,) London.
16. VEGETABLE ANATOMY AND PHYSIOLOGY. By J. H. Balfour, M.D., Edinburgh University.
17. SYSTEMATIC AND ECONOMIC BOTANY. By J. H. Balfour, M.D., Edinburgh University.
19. METALLURGY. By W. H. Greenwood, A.R.S.M. 2 Vols.
20. NAVIGATION. By Henry Evers, LL.D., Professor of Applied Mechanics, Plymouth.
21. NAUTICAL ASTRONOMY. By Henry Evers, LL.D., Plymouth.
22. STEAM AND THE STEAM ENGINE—LAND, MARINE, AND LOCOMOTIVE. By Henry Evers, LL.D., Plymouth.
23. PHYSICAL GEOGRAPHY. By John Young, M.D., Professor of Natural History, Glasgow University.

