

ASTRONOMY

FOR

EVERYMAN

# ASTRONOMY FOR EVERYMAN

Edited by  
DR M.  
DAVIDSON

SOLAR SYSTEM  
THE SUN  
THE MOON  
THE PLANETS  
MINOR PLANETS  
COMETS, METEORS  
AURORA AND  
ZODIACAL LIGHT  
THE STARS  
LIGHT AND  
INSTRUMENTS  
HISTORY OF  
ASTRONOMY  
NAVIGATION  
THE ROAD  
TO THE  
PLANETS  
NOTES ON  
IDENTIFICATION

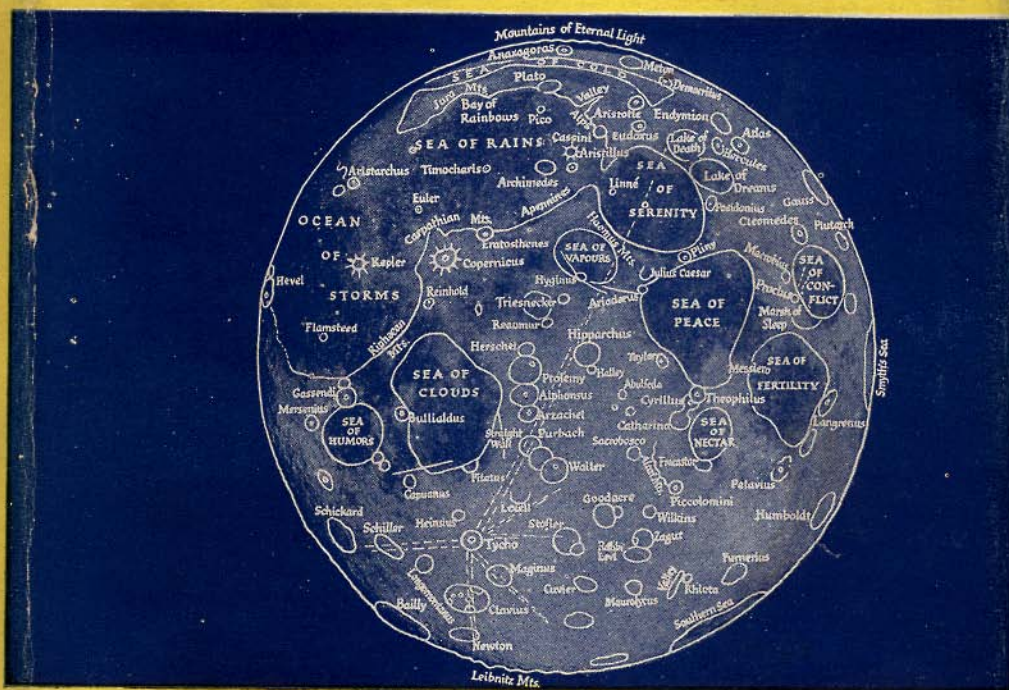

DENT

Edited by

MARTIN DAVIDSON

B.A., D.Sc., F.R.A.S.

With contributions by leading Astronomers, including  
Directors of Sections of the British Astronomical Association



ASTRONOMY  
FOR  
EVERYMAN

EDITED BY  
M. DAVIDSON

DENT  
DUTTON









DELAVAN'S COMET, 1914  
26th September, Greenwich

*R. Obs., Greenwich*

# ASTRONOMY FOR EVERYMAN

Edited by

MARTIN DAVIDSON

B.A., D.Sc., F.R.A.S.

Contributors

M. B. B. HEATH, F.R.A.S.

F. J. SELLERS, M.I.MECH.E., F.R.A.S.

DR. H. P. WILKINS, F.R.A.S.

A. F. O'D. ALEXANDER, M.A., PH.D., F.R.A.S.

MARTIN DAVIDSON, B.A., D.SC., F.R.A.S.

W. B. HOUSMAN, F.R.A.S.

P. DOIG, F.R.A.S.

E. G. MARTIN, F.R.A.S.

H. L. KELLY, F.R.I.B.A., F.R.A.S.

J. B. PARKER, M.A.

W. A. SCOTT, B.SC., F.R.A.S.

A. C. CLARKE, B.SC., F.R.A.S.

E. O. TANCOCK, B.A., F.R.A.S.

LONDON: J. M. DENT & SONS LTD  
NEW YORK: E. P. DUTTON & CO. INC.



All rights reserved  
 by  
 J. M. DENT & SONS LTD  
 Aldine House · Bedford Street · London  
 Made in Great Britain  
 at  
 The Aldine Press · Letchworth · Herts  
 First published 1953  
 Revised edition 1954

## CONTENTS

CHAP.	PAGE
PREFACE	ix
INTRODUCTION: A GENERAL VIEW OF THE UNIVERSE. <i>By M. Davidson, B.A., D.Sc., F.R.A.S., President  of the British Astronomical Association, 1936-8</i>	xv
I THE SOLAR SYSTEM. <i>By M. B. B. Heath, F.R.A.S.,  Director of Saturn Section, British Astronomical  Association</i>	I
II THE SUN. <i>By F. J. Sellers, M.I.Mech.E., F.R.A.S.,  Director of Solar Section, British Astronomical Association,  1937-51</i>	8
III THE MOON. <i>By Dr. H. P. Wilkins, F.R.A.S., Director  of Lunar Section, British Astronomical Association</i>	73
IV THE PLANETS. <i>By M. B. B. Heath, F.R.A.S., Director  of Saturn Section, British Astronomical Association,  and A. F. O'D. Alexander, M.A., Ph.D., F.R.A.S.,  Director of Jupiter Section, British Astronomical  Association</i>	110
V MINOR PLANETS. <i>By A. F. O'D. Alexander, M.A.,  Ph.D., F.R.A.S.</i>	210
VI COMETS, METEORS AND METEORITES. <i>By M. Davidson,  B.A., D.Sc., F.R.A.S., formerly Director of Comet  Section, British Astronomical Association</i>	220
VII THE AURORA AND ZODIACAL LIGHT. <i>By W. B. Housman,  F.R.A.S., formerly Director of Aurora and Zodiacal  Light Section, British Astronomical Association</i>	262
VIII THE STARS. <i>By P. Doig, F.R.A.S., Editor of 'The  Journal of the British Astronomical Association,'  Author of 'An Outline of Stellar Astronomy'</i>	286



CHAP.		PAGE
IX	LIGHT AND INSTRUMENTS. <i>By E. G. Martin, F.R.A.S., Senior Experimental Officer, Royal Observatory, Greenwich</i>	358
X	HISTORY OF ASTRONOMY. <i>By H. L. Kelly, F.R.I.B.A., F.R.A.S., Director of Historical Section, British Astronomical Association, and P. Doig, F.R.A.S. Author of 'A Concise History of Astronomy'</i>	406
XI	NAVIGATION. <i>By J. B. Parker, M.A., and W. A. Scott, B.Sc., F.R.A.S., H.M. Nautical Almanac Office</i>	447
XII	THE ROAD TO THE PLANETS. <i>By Arthur C. Clarke, B.Sc., F.R.A.S., Chairman of the British Interplanetary Society. Author of 'Interplanetary Flight,' 'The Exploration of Space,' etc.</i>	480
XIII	NOTES ON IDENTIFICATION. <i>By E. O. Tancock, B.A., F.R.A.S., Author of 'Starting Astronomy,' Editor of Philips' 'Chart of the Stars,' etc.</i>	486
	APPENDICES I—X. <i>By M. Davidson, B.A., D.Sc., F.R.A.S.</i>	500
	APPENDIX XI. THE PLANETS. <i>By A. F. O'D. Alexander, M.A., Ph.D., F.R.A.S.</i>	506
	APPENDIX XII. NOTES ON THE NUCLEUS OF A COMET. <i>By M. Davidson, B.A., D.Sc., F.R.A.S.</i>	508
	APPENDIX XIII. MAIN SEQUENCE STARS. <i>By E. G. Martin, F.R.A.S.</i>	508
	APPENDIX XIV. NOTE ON THE SPIRAL STRUCTURE OF THE GALAXY. <i>By M. Davidson, B.A., D.Sc., F.R.A.S.</i>	509
	INDEX	511
	STAR MAPS	<i>end-papers</i>

## PREFACE

THIS book provides an up-to-date and authoritative outline of our knowledge of the heavenly bodies—their distances, dimensions, masses, constitutions, temperatures, etc.—and explains the methods used by the astronomer for acquiring this knowledge. As far as possible anything except elementary mathematical treatment of the problems has been avoided in the text, with the exception of the chapter on Navigation. Where it has seemed desirable more difficult mathematical matters have been relegated to footnotes at the ends of chapters or to the Appendices which, however, are not essential for understanding the subjects outlined in the text. The various branches of astronomy are dealt with by specialists, many of them present or past directors of sections of the British Astronomical Association. As they have all made an intensive study of their own particular subjects and have had the experience of assisting the members of their sections who work under their direction, and also others who consult them for advice and guidance, they understand the difficulties of beginners and know how to express themselves in language suitable to the novice as well as to those who are more advanced.

The Introduction gives a general survey of the universe, from our own planet to the remote extra-galactic nebulae, and it is hoped that this chapter will enable readers to gain a balanced perspective of the subject before they embark on the specialized portions which are dealt with in the various chapters. After this general view of the whole universe the first chapter outlines the main features of the solar system, suggesting a simple model of the Sun and its family of planets, which can be easily visualized. This model will assist in giving an idea of the immense distances with which the astronomer deals, even in the solar system which, compared with the distances of stars and nebulae, is a mere speck in the universe.

Chapter II deals with the Sun in relation to evolution and the life of man, its physical features, composition, the process by which its enormous output of heat and light is supplied and maintained,

its relation to various terrestrial phenomena such as the aurora, interference with short-wave radio transmission, etc., and also the methods used for observing sunspots, flares, prominences, and other features. The author of this chapter is well known for his work on solar prominences and for the device that he invented several years ago for facilitating the observations of prominences by the spectrohelioscope. He has copious illustrations—photographs and line diagrams—in his chapter.

Chapter III gives a detailed description of the night-to-night lunar features that can be seen with a small telescope and will prove most instructive and stimulating to every one who has any interest in our nearest neighbour—the Moon. The author of this chapter, with his band of workers on lunar topography, has made a very comprehensive investigation of the surface of the Moon, and as a result he has produced the largest map of the Moon in existence. This is in twenty-five sections and when assembled is twenty-five feet in diameter; he is now engaged in producing a still larger map. This chapter, unlike many of the others, is practically self-contained and can be read without reference to other parts of the book. Some who read it will probably want to purchase a small telescope, or, if they cannot afford this, may feel disposed to make one for themselves—not a difficult or expensive matter. Thus equipped they will find a wonderful recreation in studying some of the larger lunar formations, with the assistance of the descriptions given in Chapter III.

In Chapter IV each of the planets is dealt with separately, and nothing of real interest or importance to readers has been overlooked; the results of the most recent research on the planetary features, their atmospheres, physical conditions, dimensions, etc., have been included and copious illustrations by photographs and drawings—some of the latter by the authors themselves—are included.

Chapter V contains a short account of the minor planets or planetoids (usually known as asteroids, though the term is misleading), and Chapter VI deals with comets, meteors, and meteorites. These, with the planets and their thirty-one satellites, complete the members of the solar system.

'The Aurora and Zodiacal Light,' Chapter VII, has not been included under the solar system; the aurora is a 'border-line case' between

astronomy and meteorology. Although its origin comes under the province of astronomy the final cause of the phenomenon is largely of a meteorological character, but it is usually included in astronomical works. It is not a common phenomenon in the southern parts of this country, but is frequently seen in the northern parts of Scotland. Statistics show that on the average it is observed a hundred times a year in Lerwick, twenty-five times in Edinburgh, and seven times in London. Most of the chapter is devoted to descriptions of its appearance and will prove very helpful to those who have the opportunity of observing this beautiful spectacle, but there is also a short account of the causes of the phenomenon. It must not be assumed that this explanation settles all the difficulties connected with the aurora; many unsolved problems still remain and probably will remain for a considerable time before the geophysicist has provided a complete solution.

Except for the Introduction, the book has so far been concerned with very parochial matters—merely a survey of the solar system of which the outermost planet is only about 4,000 million miles from us. This distance shrinks into utter insignificance when compared with the distance of the nearest star, the light from which takes over four years to reach us. Chapter VIII, 'The Stars,' explains how the depths of space are plumbed and stellar distances determined, how the stars are weighed, the nature of the instruments used by the astronomer to tell what stars are made of and what their temperatures are, how they came into existence, what their end will be, and so on. Perhaps some who read this chapter will wonder why astronomers waste their time in studying such trivial things as planets and their satellites, comets and meteors, and other members of the solar system—all mere specks in the immense universe. They will learn, however, that the solar system must be used as the base for operations, and unless the distance of the earth from the sun is first known, it would be impossible to proceed with the computations of the distances of the stars and nebulae—galactic and extra-galactic—or of their masses, dimensions, movements, temperatures, and many of their other characteristics. The methods adopted by the astronomer for deriving these are fully explained in the simplest manner, and the reader will be enlightened on the step-by-step procedure from the use of the earth's diameter to find the Sun's distance—the *astronomical unit*—and then from this



to find the distances of the stars comparatively close to us—about a hundred light-years away—and from this to proceed to other stars and extra-galactic nebulae hundreds of millions of light-years away. It is a thrilling story and one that cannot fail to impress every reader with the wonders and majesty of the heavens, as well as with the power of the human mind to grapple with abstruse problems which a few hundred years ago seemed incapable of solution.

Very little up to this point has been said about the instruments used by the astronomer; this has been relegated to Chapter IX, which has been purposely reserved for the end of the descriptive portions because its introduction earlier would have burdened the minds of readers with many details that would have caused more confusion than enlightenment. Throughout the book there are many cross-references, some of them directing attention to the instruments employed, and it will be found advisable to refer to these just as the occasion arises. On the whole this will be better than studying this chapter first of all (though this can be done if preferred), and the practical application to any specific problem that arises will then be more obvious.

No work on astronomy is complete without some historical sketch of the developments in the subject, and this has been provided in Chapter X, which is divided into two sections, one dealing with astronomical development from the earliest times to the middle of the seventeenth century, the other giving a brief outline of the discoveries and developments from the days of Flamsteed, the first Astronomer Royal, up to recent times. This is a fascinating story, showing how the early astronomers formulated the most grotesque theories about the heavenly bodies and how, during the last four hundred years, enormous strides have taken place in every branch of astronomy, in spite of reactionary tendencies and opposition through bigotry and superstition during the first two centuries of this period of rapid progress.

The practical application of astronomy to navigation is dealt with in Chapter XI; this has been compiled by two authors, the first of whom has had the practical experience of navigation, the second dealing more especially with the theoretical side. This chapter may not be easily understood by every reader, and if it proves too difficult it can be omitted without affecting the sequence

of the book; some who are interested in the subject and who have sufficient mathematical background will, however, find it very helpful, and it provides a useful introduction to a more advanced study of navigation.

Chapter XII, 'The Road to the Planets,' for which the chairman of the British Interplanetary Society is responsible, explains how it is proposed making journeys to other heavenly bodies—the Moon first and afterwards the planets. Some may think this is a fantastic idea, but it is fairly certain that the attempt to reach the Moon will be made within the next twenty or thirty years, and the scheme for making the journey is not so fantastic as it seems.

Chapter XIII, 'Notes on Identification,' supplies the necessary information for identifying the stars in their seasons.

The book ends with a number of Appendices to explain more fully certain points in the text. Star Maps are printed on the front and back end-papers as well as in Chapter XIII.

I should like to acknowledge the assistance rendered by Dr. W. H. Steavenson, Dr. A. F. O'D. Alexander, and Mr. P. Doig,<sup>1</sup> who read through the manuscript and galley proofs and made a number of valuable suggestions. Where differences of opinion arose—and in several cases this has occurred—the final decisions on controversial matters were given by the authors of the various chapters, who must, therefore, accept responsibility for the views expressed.

Acknowledgment is also made to a number of publishers and observatories for permission to reproduce diagrams and photographs; the names are inserted on these. A very large number of reproductions has been made from *Splendour of the Heavens*, published in 1923 by Hutchinson. The Council of The British Astronomical Association and members who have made contributions to its publications have also kindly given permission for a number of plates and diagrams to be reproduced.

Finally I wish to thank the United States Navy Department Hydrographic Office for permission to reproduce the tabular matter shown on pp. 478-9, from H.O. 214, *Tables of Computed Altitude and Azimuth*, 1940, and H.O. 249, *Star Tables for Air Navigation*, 1947, and also the Controller of H.M. Stationery Office for permission to reproduce the tabular matter shown on pp. 474-7.

September 1952

M. DAVIDSON.

<sup>1</sup> Mr. Doig died shortly before the publication of the book.

## PREFACE TO SECOND EDITION

IN the preparation of this second edition advantage has been taken of a number of suggestions made by reviewers and correspondents.

The Index has been enlarged, and an additional chapter has been added dealing with the identification of the stars and planets; this chapter also includes a number of star maps to supplement those on the end-papers. A number of extra Appendices have been inserted, many of which deal with developments in astronomy since the appearance of the first edition.

M. DAVIDSON.

1954.

## INTRODUCTION

# A GENERAL VIEW OF THE UNIVERSE

BY M. DAVIDSON, B.A., D.SC., F.R.A.S.

*President of the British Astronomical Association, 1936-8*

THE first chapter gives a general survey of the solar system, starting with the Sun which, on the model suggested by Mr. M. B. B. Heath, is taken as two feet in diameter (its actual diameter is about 860,000 miles). On this scale the planet Pluto—so far as we know at present the most distant from the Sun of the nine planets—is nearly  $1\frac{3}{4}$  miles away at its average distance. On the same scale the nearest star is about 10,000 miles away.

It is easy enough to visualize a distance of a few miles, and those who do a lot of travelling by road—drivers of motor vehicles, for instance—can form a rough idea of distances of hundreds of miles, but distances of thousands of miles are much more difficult to visualize. When we come to millions of miles it is quite impossible to form any conception of such distances, and as these figures would be necessary in dealing with our Galaxy<sup>1</sup> if we started with the Sun two feet in diameter as the basis, a different method will be adopted in this chapter. We shall start with our Galaxy and assume that it has a diameter of 1,000 miles, which is more than twice the distance from Berwick to Land's End. We shall anticipate what is fully described in Chapter VIII by saying that all the stars you can see with the naked eye lie in our Galaxy, and although you can see only a few thousand of these there are about 100,000 million altogether.

Suppose that the Galaxy, which is shaped somewhat like a bun,<sup>2</sup> has its longest diameter 1,000 miles and its shortest diameter 160 miles; this is like a very flattened bun, six times as long as it is deep, but even this does not give an adequate representation of the

<sup>1</sup> See page 346.    <sup>2</sup> This is only a provisional conception. See page 348.



Galaxy because the 'bun' rapidly tapers off so that towards its edges its depth is only about 30 to 60 miles. Having formed a mental picture of this—and it may not be very easy for many readers to do so but it is the best that we can suggest—now let us look at what lies in the interior of the bun. (See Fig. 112 and Plate XXXVIII, Chapter VIII.)

Imagine that inside the bun there are about 100,000 million tiny specks, each one with an average diameter ten-thousandth part of an inch, and that they are all moving round the central portions with various velocities. Fix your attention for the present on one of these specks which is about 300 miles from the centre of the bun; although it would be invisible to the naked eye a microscope magnifying a thousand times would show it as a tiny sphere apparently about one-tenth of an inch in diameter. This speck is our Sun and on closer examination you would see a number of much smaller specks revolving around it, but of course an ordinary microscope would be useless for observing these, and you would find it necessary to use an electron microscope. These very minute specks—much smaller than the main speck—are the planets, and the one at greatest distance is two-fifths of an inch away, but of more interest than Pluto is another speck at one-hundredth of an inch from the central one. This is our Earth which, on the scale adopted, is about one-millionth of an inch in diameter. It happens to be so situated that something we call life has been able to develop on it and to survive so far because the heat and light from the Sun are favourable for this, but how far they are favourable for the same purpose on the other specks is largely a matter of conjecture.

Having formed a mental picture of the Galaxy, now let us turn to the distances between the specks composing it. In the first chapter it is shown that, adopting a model of the solar system with the Sun two feet in diameter, the nearest star is 10,000 miles away, and this could be taken as a fair representation of the distances between any one star and its nearest neighbour. On the present scale, however, where the Sun is a microscopic object, its nearest neighbour is about 80 yards away. You can, therefore, form a picture of a very minute speck representing the Sun and another minute speck representing the nearest star separated by 80 yards, and about 100,000 million more occupying a space like a bun 1,000 miles long and 160 miles in depth. This is a picture of the Galaxy.

What lies outside this bun—in other words—our Galaxy? The answer is other galaxies more or less of similar shape in many cases and some of them about the same size as our Galaxy, though many of them are much smaller. One of the largest of these, visible to the naked eye in the northern hemisphere, is the Great Nebula in Andromeda.<sup>1</sup> On the adopted scale it would be about 8,000 miles away, and although several are known to be nearer to us than this, there are hundreds of millions of others incomparably more distant. The 200-inch telescope at Mount Palomar can photograph galaxies more than a thousand times as far away as the Great Nebula in Andromeda, which would imply on our scale more than 8 million miles. Now turn your attention for a moment to this scale.

We started with the Earth's diameter as one-millionth of an inch, in other words, by placing side by side a million specks like that described earlier, each speck representing the Earth with a diameter of nearly 8,000 miles, we arrive at galaxies of stars more than 8 million miles away. Perhaps this will enable readers to appreciate better the magnitude of the universe than to be told that there are external galaxies a thousand million light-years distant. The explanation of this term appears elsewhere.<sup>2</sup>

This brief survey of the universe should enable readers to gain a clear perspective of the problems confronting the astronomer. Formidable as they may seem to be when such immense distances are to be plumbed from his speck representing the Earth, nevertheless he has succeeded in unravelling many of the secrets of the universe, but many still remain unsolved.

Some may want to know what lies between all these galaxies of stars which are separated from one another by such immense distances. The answer is that it is not isolated stars which do not belong to any galactic system but are wandering about on their own; such stars do not seem to exist. All the stars in the universe appear to belong to some galactic system, and outside this and between it and the next system there is nothing but scattered molecules and atoms of various elements—sodium and hydrogen especially, but many other elements are represented—and cosmic dust. Although these molecules, atoms, and cosmic dust are so scattered that the most perfect vacuum that can be produced on Earth is incomparably more dense than is found in interstellar

<sup>1</sup> See page 320.

<sup>2</sup> See page 290.

space, nevertheless it is believed that the total mass of all this interstellar and internebular matter is about the same as that of all the stars combined or even much greater. It need scarcely be added that the temperature in interstellar space is very low—almost absolute zero.<sup>1</sup>

The interstellar matter is responsible for raising many complications in the problems confronting the astronomer, more especially in his attempts to determine the distances of the external galaxies, but this is explained later in the book.<sup>2</sup> Enough has been said to assist the reader in realizing the immensity of the universe. In the first chapter the scale adopted is very suitable for describing the solar system, but this scale is too large for describing the extent of one galaxy—to say nothing of hundreds of millions of others. The scale is nearly a quarter of a million times as great as that used in the Introduction to describe the Galaxy and its distance from some of the nearest external galaxies, and this scale will be more fully appreciated when Chapter VIII has been read. Some might find it advantageous to re-read the Introduction while they are studying the contents of Chapter VIII.

## BIBLIOGRAPHY

Many of the books on cosmology are beyond the standard aimed at in this work, but a few can be recommended, amongst which are the following:

Sir James Jeans: *The Stars in their Courses*, Cambridge University Press, 1931.

W. de Sitter: *Kosmos*, Harvard University Press, 1932.

Sir Arthur Eddington: *The Expanding Universe*, Cambridge University Press, 1933.

Fred Hoyle: *The Nature of the Universe*, Basil Blackwell, Oxford, 1950.

G. J. Whitrow: *The Structure of the Universe*, Hutchinson's University Library, 1951 (more advanced than the others mentioned).

<sup>1</sup> In dealing with the heavenly bodies—in particular with the stars—readers will frequently find that temperatures are expressed in degrees K., not in C., which means degrees Centigrade. Sometimes A. is used instead of K., and these letters signify 'absolute' and 'Kelvin,' respectively, the latter after Lord Kelvin. Physicists take as the zero point a temperature 273° Centigrade below 0° C., which is the *absolute zero*, and temperatures reckoned from this zero point are denoted by A. or K., more frequently the latter. Thus, 300° K. means a temperature 300° C. above -273° C., which implies a temperature 27° C. In the case of very high temperatures it makes little difference whether we refer to C. or K. For instance, 16,000° K. is the same as 15,727° C., and as the determination of such high temperatures on the stars is subject to considerable uncertainty, it makes very little difference whether we call the temperature 16,000° K. or 16,000° C. Nevertheless in many computations physicists use absolute temperatures only, one example of which occurs on page 332.

<sup>2</sup> See pages 344 ff.

## CHAPTER I

## THE SOLAR SYSTEM

M. B. B. HEATH, F.R.A.S.

*Director of Saturn Section, British Astronomical Association*

## CONSTITUTION, ORIGIN

THE solar family includes a very large, hot, massive, and luminous central Sun, with innumerable much smaller bodies revolving around it in paths varying from near circularity to very elongated ellipses. The principals of these dependent orbs are nine planets, one of them our world, all moving in approximately circular orbits, in the same direction as the Sun rotates on its axis and roughly in the plane of the Sun's equator. These planets also turn on their own axes in a similar direction to the solar rotation (only the tilt of the axis of Uranus being unusual)<sup>1</sup> and most of their satellites revolve around them in conformity to the general direction. All this, together with its extreme isolation—for the nearest star is about 6,000 times as far away as the outermost planet when at its mean distance—shows that the system is no fortuitous assembly of matter but had some common origin. What that origin was we know not. Condensation from a nebula, an encounter with an intruding star both with or without collision, and the supposition that the Sun was once a double star whose companion encountered the intruding star—these and many other theories<sup>2</sup> have been invoked but have been found more or less inadequate.

There are also vast numbers of yet smaller bodies within the Sun's domain. Thousands of little planets called asteroids or planetoids, and innumerable fragments ranging from great meteorites such as

<sup>1</sup> See page 189.

<sup>2</sup> Some of these are discussed in the four books referred to in the Bibliography, page 7.



have fallen on the Earth at rare intervals, down to tiny flashing 'shooting stars' of less than pin-head size, and many comets, all pursue their ways in orbits very different from those of the principal planets.

#### A MODEL OF THE SYSTEM

It is impossible to represent on paper the relative sizes and distances of the Sun and planets because the distances are so much greater than the sizes. In order to obtain an accurate mental picture of the system we may imagine a globe 2 feet in diameter to represent the Sun; then Mercury will be represented by a small shot or moderate pin's head revolving round the globe at an average distance of about 83 feet, Venus by a small pea at about 156 feet, the Earth another small pea at about 215 feet, Mars by a slightly larger shot than that representing Mercury at about 109 yards, Jupiter by a fair-sized orange at about 373 yards, Saturn by a large plum at about  $\frac{2}{3}$  mile, Uranus by a large cherry at about  $\frac{4}{5}$  mile, Neptune by another cherry at about 1.22 miles, and Pluto by a small pea at an average distance of about  $1\frac{3}{4}$  miles, but when farthest from the Sun a little over 2 miles. On the scale of this model the nearest star is about 10,000 miles away.

#### APPARENT PLANETARY MOTIONS

Viewed from the Sun the planets would be seen as an orderly procession, the nearer ones continually catching up and passing the more distant. Viewed from the Earth, however, these motions lose all this simplicity and become very complicated. Long ago, probably as soon as the stellar heavens had been divided into constellations, it was noticed that five bright star-like objects appeared to move about among them. Prolonged observations showed that their roamings were confined to a narrow belt in the sky within which the Sun and Moon appeared to move continually eastward, and which we call the zodiac. In various periods, the longest being nearly 30 years, they circled this belt and returned practically to their original place among the stars, only to recommence their ceaseless round. Their motions in the zodiac, however, appeared

very irregular. Mercury and Venus appeared to recede from the Sun up to certain limits and then seemed to approach it, but Mars, Jupiter, and Saturn were not so limited—they receded from the Sun until they were opposite to it (and consequently seen in the south

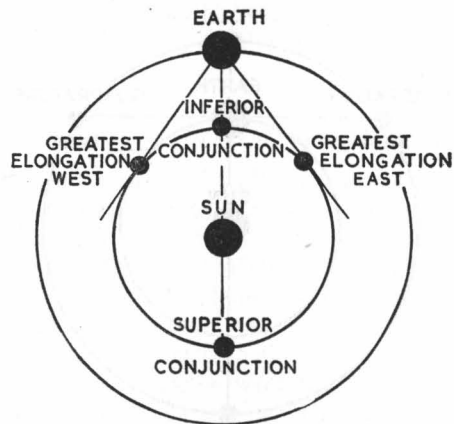

FIG. 1  
ORBITS OF THE EARTH AND AN  
INFERIOR PLANET

Only two planets, Mercury and Venus, revolve in orbits inside that of the Earth. The diagram shows why they are nearest to us in inferior conjunction, and at their greatest apparent distance from the Sun at their elongations. Obviously the Earth can never get between them and the Sun.

(From *Splendour of the Heavens*, Hutchinson)

at midnight) before seeming to approach it once more. Meanwhile they had moved eastward among the stars, slowed down, stopped, moved westwards, stopped again, and then resumed their eastward journey. When opposite the Sun they were found to be about midway between the two stationary points. These errant orbs are the planets—a word derived from the Greek, meaning a wanderer. To account for these motions, men, obsessed by the ideas that the Earth was the centre of the universe and that all celestial motions must be performed in a circle,<sup>1</sup> devised extremely complicated

<sup>1</sup> See page 409.

systems of cycles and epicycles to account for the observed appearances, but they never completely succeeded in doing so. The first step in the right direction was taken by Copernicus, who suggested that all the planets, the Earth included, revolved round the Sun.

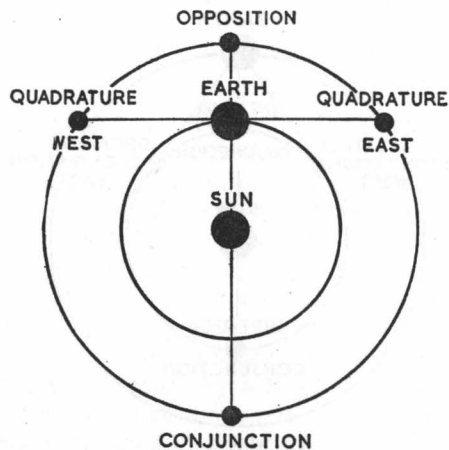

FIG. 2

#### ORBITS OF THE EARTH AND AN EXTERIOR PLANET

The planets from Mars outwards to Pluto revolve in orbits outside that of the Earth. The diagram shows why they are nearest to us at opposition, when the Earth is between them and the Sun.

(From *Splendour of the Heavens*, Hutchinson)

Kepler followed this up by enunciating his three laws of planetary motion,<sup>1</sup> and finally Newton showed that these three laws were the consequences of his universal law of gravitation.<sup>2</sup>

#### THE ASTRONOMICAL UNIT

The mean distance of the Earth from the Sun is used as a unit to express many distances in the Solar System. In 1930-1 the tiny asteroid Eros made one of its close approaches to the Earth and

<sup>1</sup> See page 418.

<sup>2</sup> See page 421.

fourteen different countries co-operated in taking nearly 3,000 photographs of it upon the stellar background. From these the Astronomer Royal, Sir Harold Spencer Jones, deduced a solar parallax of  $8''.790$ , which corresponds to the equatorial radius of the Earth as seen from the Sun. Adopting Hayford's value of 3963.35 miles for that radius we find that the Astronomical Unit is almost exactly 93 million miles.<sup>1</sup>

#### PLANETARY ORBITAL ELEMENTS

In order to define the orbit of a planet completely we must have certain basic quantities known as elements. These are (1) the mean distance of the planet from the Sun; (2) the eccentricity of its orbit; (3) the inclination of the plane of the orbit to the plane of the Earth's orbit, i.e. to the ecliptic plane; (4) the position of the ascending node, the point where the two planes intersect when the planet is moving from the south to the north side of the plane of the Earth's orbit; (5) the angle between the ascending node and the point where the planet is nearest the Sun; and (6) the period of revolution round the Sun. The connection between (1) and (6) is explained elsewhere.<sup>2</sup> Knowing these and the precise position of the planet in its orbit at some particular epoch, any past or future position of the planet can be computed in so far as that depends solely upon the Sun's attraction.

#### PERTURBATIONS

The Sun's mass is about 745 times that of all the planets combined, so it is evident that its attraction is paramount in controlling the orbits, but the planets also slightly attract each other, giving rise to small disturbances in those orbits, which are known as perturbations. The short periodic perturbations never become large, the greatest being those of Jupiter and Saturn, long known as the 'Great Inequality,' having a period of about 913 years. Even then, as seen from the Sun, Jupiter is only displaced by about half a degree and Saturn a little more than a degree. The secular perturbations, however, are of much longer periods—anything from 50,000 to nearly 2 million years. The mean distances of the planets

<sup>1</sup> See pages 72, 214.

<sup>2</sup> See pages 232, 418.



from the Sun and consequently their periods of revolution remain unchanged by these, but elements numbered (2), (3), (4), and (5) change slightly in the course of ages. Laplace and Lagrange, eminent French mathematicians, showed that these could not alter the stability of the system to any great extent. The inclinations and eccentricities oscillate slightly but, according to Brown, cannot become large in less than many millions of revolutions.

## BODE'S LAW

The name of J. B. Titius of Wittenburg (*d.* 1796) is associated with that of Bode—another celebrated German astronomer—in formulating this law which can be explained very simply as follows:

Write down the numbers 0, 3, 6, 12, 24, and so on, each number after the second being double the one preceding it. We add 4 to each of these and we have the series of figures 4, 7, 10, 16, 28, and so on. These give the relative mean distances of the planets from the Sun, except in the cases of Neptune and Pluto. While the figures are not exact they are fairly close and have proved very useful to astronomers on various occasions which are mentioned later. The table below shows the application of Bode's law to the planets.

	Mercury	Venus	Earth	Mars	Asteroids	Jupiter	Saturn	Uranus	Neptune	Pluto
According to Bode's law	4	7	10	16	28	52	100	196	388	772
Actual distances	3.9	7.2	10	15.2		52	95.4	192	300.7	394.6

If 10 represents the distance of the Earth from the Sun, the distance of Mercury should be 4, of Jupiter 52, and so on, mean distances being always used, and the agreement between the figures computed by Bode's law and the actual figures are close except in the cases of Neptune and Pluto. It may be pointed out, however, that Pluto's actual distance is practically the same as the distance of Neptune as found from Bode's law, and this raises certain problems which are beyond the scope of this book. The average distance

of the asteroids fits in satisfactorily with 28—the computed distance—and reference is made to this and also to the discoveries of Neptune and Pluto in other portions of the work.<sup>1</sup> While no satisfactory explanation has yet been given of Bode's law (it was derived merely from empirical evidence, that is, from a knowledge of the distances of the planets) it cannot be considered a mere coincidence.

The first four planets, of the Earth's order of size, are called the 'terrestrial planets,' while the next four, which are much larger than the terrestrial planets, are known as the 'giant planets.' Until recently it was generally believed that the diameter of Pluto was about half that of the Earth, but there are now reasons for thinking that the planet is about the same size as the Earth.<sup>2</sup>

Reference has been made on page 1 to suggestions regarding the origin of the solar system, but it is outside the scope of this book to deal with these theories, more especially as some of them involve abstruse mathematical analysis. It should be emphasized that there is no generally accepted theory at present; all of them present difficulties and are open to a number of objections—some more than others. Readers who wish to study this subject more fully can refer to any of the books mentioned in the list below, in some of which a comprehensive survey is given of various theories. When cosmologists attempt to explain a process which took place at least 3,000 million years ago they must necessarily indulge in speculation because of their ignorance of the conditions prevailing at that time. For this reason no theories of the manner in which the Sun and its attendant planets, satellites, and other members of the solar system were formed, can claim to be final, and plausible as many of them may seem they must be regarded as largely tentative, based in many cases on mere *ad hoc* postulates.

## BIBLIOGRAPHY

Sir James Jeans: *The Universe Around Us*, Cambridge University Press, 3rd edition, 1933, pages 249 ff.

Fred Hoyle: *The Nature of the Universe*, Basil Blackwell, Oxford, 1950, Chapter IV.

Sir Harold Spencer Jones: *Life on Other Worlds*, English Universities Press Ltd., 2nd edition, 1952, pages 215 ff.

M. Davidson: *From Atoms to Stars*, Hutchinson, 3rd edition, 1952, Chapter XIII.

<sup>1</sup> See pages 192 ff.; 200-1.

<sup>2</sup> See page 203.

## CHAPTER II

# THE SUN

---

F. J. SELLERS, M.I.MECH.E., F.R.A.S.

*Director of Solar Section, British Astronomical Association, 1937-51*

### THE SUN IN RELATION TO THE EVOLUTION AND LIFE OF MAN

SOME two or three hundred million years ago the radiation from the Sun, such as its light and heat, was not very different either in nature or amount from what it is to-day; so that during evolution, under the unvarying influence of this radiation, vegetable and animal life, including in the later stages that of mankind, has steadily and persistently adapted itself to conditions which are still in existence.

The surface of the Earth had long ceased to be seriously affected by happenings in its interior, beyond, perhaps, some changes in local contours, and, although the atmosphere has probably become less moist, life on this surface has depended almost entirely on the effects of solar radiation. In fact, man's existence from his inception, and his further continued development, have been made possible and controlled by the Sun.

The primeval forests forming the coal beds, and the waterfalls of condensed water raised from the sea by evaporation, are also due to the Sun's influence, and many of the other effects of solar radiation, more recently discovered, greatly add to man's indebtedness to the Sun.

Briefly then, mankind receives from the Sun not only direct heat and light, but also indirect and artificial heat and light, as well as his food, his clothing, his fuel and power, his health, in fact everything that tends towards his general well-being.

It is natural, therefore, and not to be wondered at, that, with the

first glimmering of logical intelligence, man should have realized this to some extent and have worshipped the Sun as the deity from whom all blessings came. It may seem strange, that in spite of this it was not until comparatively recently—about 350 years ago—that the Sun was given anything approaching a central place in the cosmos.

### THE SUN AS A STAR AMONG OTHER STARS—ITS DISTANCE, MOTION, SIZE, DENSITY, ETC.

Now, of course, we know that the Sun *has* a central place, but only in the midst of its family of planets comprising the Solar System: that it is, in fact, merely one of the millions of millions of other stars in the galaxies, and quite an average one at that.

No doubt the Sun evolved much as other stars, and has, until recently, been regarded as a G-type dwarf star<sup>1</sup> which is slowly cooling. In the last decade or so considerable doubt has been expressed upon this latter point, as we shall see later, and the Sun may now be classed as a G-type main sequence star,<sup>2</sup> still getting hotter.

If removed to the standard distance from the Earth at which the Absolute Magnitude<sup>3</sup> of stars is judged to compare correctly their intrinsic brightness (10 parsecs or 32.6 light-years, about 200 million million miles), the Sun would shine as a yellowish star of fifth magnitude, not too easily visible to the naked eye on a clear moonless night.

The Sun's brilliance and importance to us are due to its comparative nearness. It is 93 million miles away and its light, travelling at a speed of 186,283 miles a second, takes only eight and one-third minutes to reach us. The light from the *next* nearest star, called Proxima Centauri, takes no less than four years to come and there are stars many millions of light-years away. It will be realized, therefore, that the Sun, together with its family of planets, is extraordinarily isolated in space. It is the only star which we can observe at close quarters, and like all stars has its own motion; in fact it is moving at a speed of 12 miles per second towards a point in the sky situated in the constellation 'Hercules,' as explained elsewhere.<sup>4</sup>

<sup>1</sup> See page 326-9. <sup>2</sup> See Appendix I. <sup>3</sup> See page 290. <sup>4</sup> See pages 297-8.

The diameter of the Sun is 864,000 miles, rather over 100 times that of the Earth. In its early stages of development the diameter was probably much greater; some early type stars of very tenuous gas have diameters of some hundreds of million miles, but the Sun has gradually shrunk to its present size.

The Sun is, however, entirely gaseous: its mean density is rather less than one and a half times that of water, but this varies greatly from intense compactness at the centre to extreme rarefaction in the outer parts.

Having regard to the periodicity of sunspots and other solar activity, the possibility was considered of the Sun having been, and perhaps still being, a variable star of the Cepheid or pulsating type,<sup>1</sup> and attempts have been made to find a variation in the solar diameter corresponding with the maxima and minima of activity, but such variation, if it exists, is so small and the difficulty of measuring it so great, owing to the turmoil of the surface and irradiation caused by its intense brilliance, that up to the present no definite conclusion has been arrived at.

#### A BRIEF NOTE ON SUNLIGHT AND THE ATOMICITY OF MATTER AND ENERGY IN RELATION TO SOLAR PHYSICS

In order to secure a better understanding of what follows it is expedient, before proceeding, to say something about light, radiation energy, and the atom.

Ordinary daylight is radiation from the Sun whose range of frequencies of pulsation happens to fall within that to which our eyes are sensitive. We can analyse sunlight by means of a spectro-scope<sup>2</sup> by spreading out a narrow beam of white daylight or sunlight, issuing from a slit, into a very wide beam, much weakened, of course, so that the varying range of frequencies of the analysed light appears in proper order as a kind of scale. This spread-out beam constitutes the spectrum of sunlight, generally known as the *solar spectrum*.

The varying frequencies are interpreted by our sense of sight as a variation in colour. Thus the colour of objects around us is due to the property of the surface of the object (or the paint on it) to select and reflect particular frequencies of pulsation from the general

<sup>1</sup> See page 315.

<sup>2</sup> See pages 61, 367, 395.

mixed white sunlight. The visible colours range from violet through indigo, blue, green, yellow, orange, and red until the deeper tones of red become invisible: but radiation from the Sun extends vastly farther in either direction beyond the tiny portion within the range of our vision. Ultra-violet frequencies, somewhat outside our vision, are intensely registered by the ordinary photographic plate, while

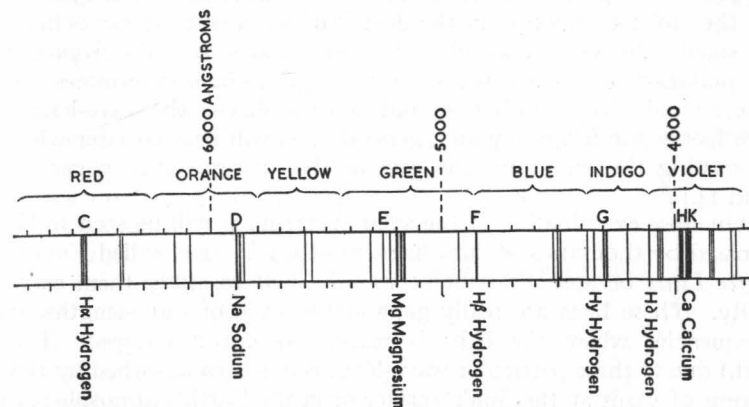

FIG. 3

#### THE SOLAR SPECTRUM

Part of the visible spectrum is here shown comprising the spectrum lines mentioned in the text. Only the more prominent lines are shown, but some 24,000 lines have been mapped in this part of the spectrum. The colours have no marked boundaries but merge into one another. Fraunhofer's letters are given. His A and B lines are in the deep red, where many of the lines are due to absorption by the atoms in the Earth's atmosphere.

infra-red frequencies are particularly associated with heat radiation. Photographic plates can now be specially made to register infra-red frequencies and a photograph may be obtained of hot objects, say a boiling electric kettle, in absolute darkness.

On the assumption that radiation is a wave phenomenon, the frequency of pulsation results from the number of waves passing a given point in a given time. As the length of the waves of light is very small, an average of about  $\frac{1}{50,000}$  of an inch, and the speed of light propagation very great, 186,283 miles a second, the resulting frequency of pulsation is of an extremely high order, being,



for green light, about 600 million million per second. It is more convenient and easier to think about and to visualize if the wave-length rather than the frequency is used. For this and other reasons radiation is generally defined by its wave-length in angstrom units—one angstrom or 'A.' being the 10 millionth part of a millimetre, or one 250 millionth part of an inch.

The visible part of the solar spectrum ranges from about 4,000 A. in the violet to 8,000 A. in the deep red: we might say *one* octave. It should always be remembered, however, that it is the *frequency* of pulsation, a direct result of wave-length, which determines the energy and effect of radiation, and that the shorter the wave-length the higher the frequency and, generally, as will be seen later when discussing the quantum, the greater the energy. (See pages 13 and 14.)

On close examination of the solar spectrum it will be seen to be crossed by thousands of dark lines, mostly very fine, called *Fraunhofer Lines* because Fraunhofer was the first to study them carefully. These lines are really gaps in the scale of wave-lengths or frequencies where the light is missing or much reduced. The light due to these particular wave-lengths has been absorbed by the atoms of gases at the Sun's surface or in the Earth's atmospheres, as will be further explained later.

The atom has been pictured as a very miniature solar system in which the Sun is replaced by a nucleus consisting of protons and neutrons (in the case of the hydrogen atom there is only one proton). Around this nucleus revolve a number of electrons, one in the hydrogen atom, two in the helium atom, three in the lithium atom, and so on. The proton carries one charge of positive electricity, but the neutron, which has the same mass as the proton, does not carry a charge. As the atom is normally electrically neutral, this implies that the number of electrons, each carrying a negative charge, which revolve around the nucleus, is the same as the number of protons. Thus the lithium atom has three protons and four neutrons in its nucleus, and to neutralize the three positive charges on the protons there must be three electrons revolving around the nucleus. These revolving electrons are often known as 'planetary electrons,' and are regarded as revolving in different shells—not all the planes of revolution lying in the same plane—each shell containing a number of electrons, which varies with the

element. The chemical and physical properties of the atom depend on the number of electrons in the outer shell. While this mental picture of the *Bohr Atom* (after Bohr, a Danish physicist, to whom this model is largely due) serves most purposes fairly well, it cannot be regarded as anything more than a convenient mental representation of the atom, and 'wave-mechanics' is now largely replacing it.

The electron may move in many different, but very definitely fixed, orbits: it cannot take up an intermediate position. In a normal state it will choose the smallest and easiest orbit nearest the nucleus. If the atom is heated or otherwise excited by collisions with other atoms in a gas or by electric discharges, etc., the electron will jump into the next orbit farther away from the nucleus, and in doing so will *absorb* a definite amount of energy; the amount of this energy is one *quantum* of a frequency which depends upon the particular orbits between which the electron jumps. The quantum, which may be regarded as the atom of energy, is generally indicated by the letters  $h\nu$  ( $h$

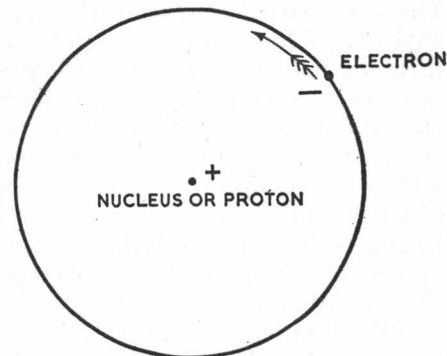

FIG. 4

## HYDROGEN ATOM (Bohr model)

An almost infinitely small nucleus with one electron revolving round it. If the atom is ionized and the electron driven out of it, the nucleus remains with a positive charge and is called a proton.

being a constant, called *Planck's Constant*, and  $\nu$  (the Greek letter 'nu') being the frequency. It will be seen that the quantum varies in its energy or power to effect physical changes—the higher the frequency the more powerful or energetic being the quantum. Left to itself the electron will fall back again into its original orbit and will *emit*, in doing so, this same quantum of energy. This energy will be registered in the spectrum of hydrogen, as examined with a spectroscope, by a line in the position of the wave-length, or wave-frequency, corresponding to the jump that the electron has made between certain orbits. There are four lines in the visible part of the hydrogen spectrum, designated by the letters  $H\alpha$ ,  $H\beta$ ,

H $\gamma$ , and H $\delta$ , corresponding with the jumps between the 1st and 2nd, 2nd and 3rd, 3rd and 4th, and 4th and 5th orbits.

It is interesting to note that these lines in the visible part of the hydrogen spectrum, together with several others in the ultra-violet, form an ordered and regular sequence known as the *Balmer Series*. The Balmer Series is confined between wave-lengths 6,563 and 3,646, but there are other series of hydrogen spectra beyond the range of vision, which likewise follow strict laws, as do, in fact, all the apparently haphazardly arranged lines in the solar spectrum. This arrangement resolves itself into perfect order on competent analysis. When hydrogen or any other gas is present in the Sun, there are millions of atoms colliding with one another millions of times per second, and therefore millions of electrons jumping from one orbit to another and back again. All the various orbits are occupied by some electrons in some atoms, and jumps are occurring millions of times per second between each and all the adjacent pairs of orbits, so that spectrum lines are registered in all possible wave-lengths or frequencies which are peculiar to hydrogen. The same applies, of course, to all the other gases in the Sun, so making up the complete solar spectrum.

If the electron, having been driven outwards from orbit to orbit, finally reaches the outermost, it will, by the absorption of more energy, be entirely separated from and driven out of the atom. The atom is then said to be *ionized* and is unstable. In the case of hydrogen the nucleus is left without an electron and is called a hydrogen ion, or proton, which appears at present to be indivisible. It is positively charged because of the missing negative electron and will recapture another electron at the first opportunity. Atoms with many electrons may be singly, doubly, or trebly ionized and so on, and the nuclei of the more complicated atoms are composed of more than one proton and other components.

One must picture the Sun, therefore, as an incandescent mass of swarming atoms, free electrons, and nuclei partly or almost completely stripped of their electrons, especially as we approach its centre, the energy of radiation resulting from all this turmoil always passing outwards towards its surface.

This digression into the property and construction of atoms and their relation to the spectrum has been necessary, and in describing the composition of the Sun, its radiation and the phenomena of its

surface, more will be said about the behaviour of atoms and its interpretation by the spectroscope. This brief note will help towards a better understanding of such descriptions.

#### THE STRUCTURE AND COMPOSITION OF THE SUN

If a solid lump of some imaginary material, incapable of being burnt, melted, or gasified at any high temperature, were allowed to fall into the Sun, it would enter the solar globe for many thousands of miles before encountering any appreciable resistance whatever. This extreme rarefaction in the outer parts of the Sun—a much higher vacuum than any we can produce on Earth—is difficult to realize, having regard to the apparent solidity and opacity of the Sun with its definite, hard-looking edge or *limb* as seen in the telescope. It is still more so when one remembers that the force of gravity at the surface of the Sun, due to its enormous mass, is no less than twenty-eight times as great as that at the Earth's surface, so that an ordinary man would weigh the equivalent of about two tons if subjected to such a gravitational field.

The explanation for this extreme tenuity is that in the Sun, as in other stars, a new force comes into operation, acting outwards from its centre, as against gravity acting inwards towards the centre. This force becomes important where there is intense radiation from massive gaseous bodies of high temperature. It is known as *Radiation Pressure* and is due to the perpetual shedding and recapturing of electrons by the atoms of high temperature gases in the presence of radiation. These electrons are dispelled and recaptured in all directions, but those in the direction of the radiation outwards from the Sun's centre impart impulses to the atoms in that direction, whereas other *random* impulses imparted in various other directions counteract one another, eventually cancelling out and leaving no integrated directional effect. Thus each atom of the gas receives thousands of impulses per second from the centre of the Sun outwards more than in any other direction. At the surface of the Sun, radiation pressure, assisted by the ordinary pressure exerted by any gas, is nearly but not quite equal to the effect of gravity, so that the Sun does exhibit a definite surface outline giving the appearance of a hard edge to the huge solar globe.

The approximate temperature of the surface is 6,000° K.—about twice that of our hottest furnace—and this increases rapidly towards

the centre. At the centre it is estimated that the temperature is of the order of  $20,000,000^{\circ}\text{C.}$ ,<sup>1</sup> and the pressure such that one ton of matter is compressed into two or three cubic inches of space. Nevertheless, the Sun is entirely gaseous, as stated above, and it was for some time difficult to reconcile a density greater than that of any solid we know with a purely gaseous state. It is now realized that at the extraordinary temperature and pressure obtaining near the centre of the Sun, the atoms may be completely ionized, and their nuclei, stripped of all electrons, forced close together and yet, owing to their almost infinite smallness, able to move freely as in a gas. This would be assisted, no doubt, by the effect of radiation pressure which would be enormously increased near the solar centre.

The Sun rotates on an axis inclined at an angle of  $7^{\circ}25'$  to the perpendicular of the ecliptic or plane of the Earth's orbit, the north pole being towards the Earth about 8th September each year. This rotation is unlike that of a solid body so far, at any rate as concerns the surface, because the equatorial regions move with greater angular velocity than those nearer the poles. At the equator the period of rotation, as deduced from the motion of sunspots, is 25 days, but at a latitude of  $40^{\circ}$  or so, north or south, is 27.5 days, while at a latitude of about  $80^{\circ}$  the period, as shown by investigations in connection with the magnetic poles, is about 30 days. The adopted mean period which occurs at about latitude  $15^{\circ}$  is 25.38 days. This is called the *Sidereal Period of Rotation*.

As seen from the Earth the period of rotation appears longer, the mean period becoming 27.27 days, because the Earth travels in its orbit round the Sun in the same direction, causing an apparent lag in the solar rotation. This latter period, 27.27 days, is called the *Synodic Period of Rotation*, and is nearly always used in defining solar observations.

The rotational speeds of the various zones of the Sun's surface can also be measured by means of the spectroscope. If the spectra from the limb at the east and west ends of the solar equator be superimposed it is found that most of the Fraunhofer Lines do not quite correspond in the two spectra. This is due to what is known as the *Doppler Effect*. If a source of light is moving rapidly and

<sup>1</sup> In dealing with very high temperatures it makes little difference whether they are measured in C. or K. See page xviii.

steadily towards us, the waves are shortened by the amount that the light source approaches between the setting out of successive waves. Similarly, the wave-length is increased when the light source moves away. The light sources from the east and west limbs of the Sun are respectively approaching and receding, due to the Sun's rotation—at a speed of over one mile per second—resulting in a sufficient difference in wave-length and relative shift in the Fraunhofer lines to permit of measurement with powerful spectroscopes. The various zonal rotations are found, in this way, to agree well with those deduced from the motion of sunspots, etc.

Hydrogen is by far the most abundant gas in the Sun. The spectroscope indicates that considerably over 90 per cent of the visible gases at the surface are hydrogen, and it is estimated, according to some recent work, that about the same, possibly more, is maintained throughout the solar globe.

Of the ninety or more elements known to us, some sixty are found definitely in the Sun and others are doubtful. About half the remainder are difficult to identify on account of their unfavourable spectra. Near the surface, particularly in the cooler regions of sunspots, the lower temperature allows some compounds to exist, such as cyanogen (CN) and the hydrides of carbon, nitrogen, and oxygen and some of the metals, but, in the intensely hot inner parts the gases can only exist as elements.

At the uppermost level of the Sun's surface, to be described later, in addition to the abundant hydrogen, calcium and helium are the most evident elements, particularly calcium. Calcium is a considerably heavier gas than either hydrogen or helium, but its prevalence in the upper solar atmosphere may be attributed to the fact that calcium is easily ionized, and during this process is affected by radiation pressure upwards more than other gases of similar atomic weight. Helium was discovered and named by Sir Norman Lockyer because, by means of the spectroscope, it was first detected in the Sun, even before it was known on Earth, but, as we shall see later, it was very happily named, for it is an extremely important, though not necessarily a very abundant, ingredient of the Sun. If, as many, but not all, physicists now believe, hydrogen forms more than 90 per cent of the Sun's mass, helium must be relatively scarce there. The solar surface structure and features will be more fully described in appropriate sections.



## THE CORONA AND MAGNETIC FIELD

Beyond and outside the ordinary solar surface as seen in the telescope there exists a vastly more rarefied atmosphere, called the *corona*, with a tenuity almost equivalent to the vacuity of interstellar space. Until quite recently the corona could be seen and studied only during the brief moments when the Sun was totally eclipsed, the Moon entirely blocking from view the brilliant light from the Sun, thus allowing the faint corona to become visible. During the last few years instruments have been devised<sup>1</sup> which, used high up on a mountain above the haze and dust-laden lower atmosphere, make it possible to see at any rate the brighter parts of the corona at any time in suitable weather conditions without the necessity of waiting for an eclipse. (See pages 68-9.)

Owing to its extreme tenuity, the atoms in the corona are so comparatively far apart that they can travel unusually long distances before colliding with, or being disturbed by, other atoms. Under these conditions the orbital jumps of the electrons are unusual, and it has recently been shown that this can explain the strange lines seen in the coronal spectrum. These lines were formerly regarded as indicating an unknown element, which was actually named 'coronium,' but they are now found to be due to very highly ionized atoms of nickel, iron, and other elements of the usual constituents of the chromosphere. Evidence is accumulating to show that the temperature of the coronal gases is extremely high, possibly 1,000,000° C. and over. The energy necessary to maintain this high temperature would probably be small, as radiation losses in such a rarefied gas would be comparatively insignificant. It is, nevertheless, somewhat difficult to explain this extremely high temperature in the coronal gases, seeing that the solar surface temperature is only 6,000° K. Recently it has been suggested that influx of interstellar material to the solar atmosphere at a very high velocity is likely, and would satisfactorily remove the difficulty. It could give a temperature of over 1,000,000° to this atmosphere.

The general outline of the corona varies with the Sun's state of activity, or perhaps this may be according to the variation in the Sun's general or local magnetic fields.

The Sun, like the Earth, is a huge magnet, the magnetic poles

<sup>1</sup> See page 427.

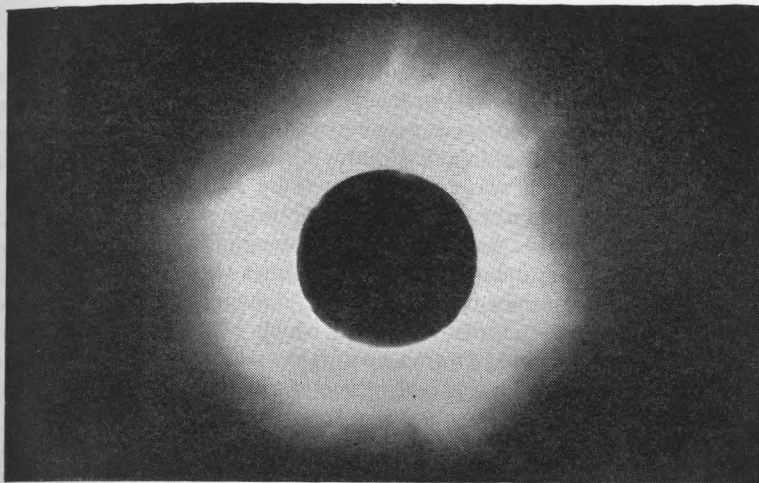

PLATE I

*Jokkmokk, Hamburg Obs.*

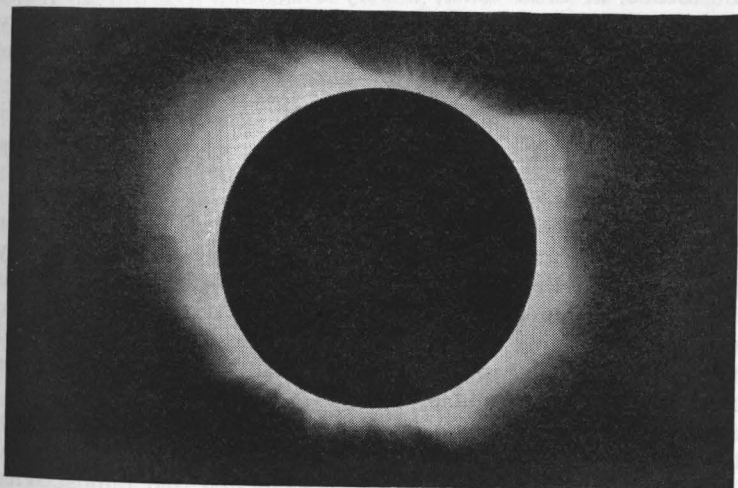

PLATE II

*E. E. Barnard*

## PHOTOGRAPHS OF THE CORONA

These photographs were taken during total eclipses of the Sun.

Plate I. When the state of solar (sunspot) activity was near maximum.

Plate II. When near minimum.

It will be noted that the corona during maximum activity is more evenly spread around the solar disk, whereas at minimum it tends to spread equatorially with short plumes at the poles.

being about  $6^\circ$  from the poles of the axis of rotation. The Sun's general magnetic field, however, is comparatively weak and quite recently has been reported as almost imperceptible to measurement; it may be variable. Estimates of its intensity have differed considerably since it was first measured by Hale.

During the period of minimum solar activity, when not disturbed by strong local fields, the Sun's general magnetic field is very like that of an ordinary magnet. At these times the corona assumes a form with short plumes from the poles, following the magnetic lines of force, somewhat similar to those which become evident when iron filings are peppered around a straight steel magnet, but extends at the equatorial regions to a distance of about a solar diameter on either side as though bunched together at these positions.

Sunspots themselves also give rise to very much more powerful local magnetic fields, and during times of maximum activity, when sunspots are prevalent, the general magnetic field is much disturbed. The corona, at these times, is very irregular but is more equally distributed around the solar globe with loops and arches, apparently following the local magnetic lines of force due to sunspots, but the polar plumes are not so evident.

#### THE SOURCE OF THE SUN'S CONSTANT OUTPUT OF ENERGY AND THE NATURE OF ITS RADIATION

The Sun has been radiating energy at a prodigious rate for some 2,000 million years or more. It is still doing so without any apparent sign of diminution and, so far as we believe at present, is capable of continuing to do so for many thousands of millions of years in the future. How this wonderful feat is performed and maintained and what is the mechanism that makes it possible was for a long time an insoluble problem.

The discovery of radium, and subsequently the better understanding of radioactivity, may perhaps be said to have first offered a glimmering of the truth. Scientists suggested that radioactivity in the Sun might account for its observed radiation over a reasonable period of existence. Unfortunately no radioactive elements are to be found in the Sun though *lead*, the ultimate product of exhausted radioactivity, is present. This seems to show that if the Sun did at some previous epoch possess radioactive elements, they must

have long since disintegrated. It was not until the implications of Relativity and Quantum mechanics made it evident that the classical idea of the conservation of matter, as matter, must be discarded, that the way lay open for a true explanation of the continual radiation from the Sun and stars.

The great research carried out by Lord Rutherford and continued by his colleagues and associates, both here and in America, in liberating sub-atomic energy by breaking up the nuclei of atoms, has made the physical mechanism of the Sun's interior more understandable. It is now generally admitted that the conversion of hydrogen into helium would liberate the energy needed to satisfy the observed radiation from the Sun, and its continuous maintenance.

Rutherford started by bombarding atoms of nitrogen and other gases with  $\alpha$ -rays from radium and other radioactive substances. He showed that these  $\alpha$ -rays were actually fast moving, positively charged nuclei of helium. By this means, on the rare occasions when the nitrogen nuclei were struck, he succeeded in breaking up nitrogen atoms into atoms of oxygen and hydrogen. This opening result was so surprising that it was at first supposed that nitrogen could no longer be considered an element. Later fast moving protons—hydrogen nuclei—were found to give better results than  $\alpha$ -particles as bombarding missiles. A high energy beam of these protons was produced by accelerating hydrogen nuclei along a tubular channel in an intense electric field. In this way lithium bombarded by hydrogen produced helium only. A still more powerful apparatus was designed, culminating in the *cyclotron*, wherein the proton stream takes a spiral path in an enormously powerful magnetic field and is excited to a potential of a million volts and more. Neutrons, components of atomic nuclei, which have *no* electric charge, were discovered and used as bombarding missiles and proved still more effective as they were not deflected from a target in the way that  $\alpha$ -particles and protons were on account of their positive charge.

Now in the central parts of the Sun the temperature is of the order of  $20,000,000^\circ$  C. and the pressure some thousands of millions of atmospheres. Under these conditions atomic nuclei will be stripped of their electrons and crushed together, and the kinetic energy of thermal motion is estimated to be at least comparable with, and probably much greater than, that produced in the

laboratory under intense electric excitation. Moreover the chances of collision among the crowded nuclei, and therefore the effect of the bombarding particles, say hydrogen protons, must be greater than can be attained in the laboratory. Having this in mind, a suggestion was put forward in 1939 by Dr. Hans Bethe, an American physicist, and also by Weizsäcker, a German physicist, that a certain cycle of nuclear reactions, which was defined, converting hydrogen into helium, may very well happen near the central parts of the Sun and could account fairly accurately for its observed radiation.

There is not space to give details of this cycle of reactions, but, according to it, *four* hydrogen nuclei are converted into *one* helium nucleus and *three* quanta of radiation. Carbon and nitrogen are the only other elements necessary for the operation of this cycle and they are not in any way altered. The net result is the conversion of hydrogen into helium, the resulting radiation energy being liberated.

This suggested series of reactions has been generally accepted as being most probably the medium of the hydrogen-helium conversion, but whether it actually takes place or not, it does seem likely that the abundant hydrogen in the Sun serves as fuel in that or a similar process. At any rate it is evident that the building up of hydrogen nuclei into nuclei of a heavier element—and helium is the most likely—liberates radiation energy. Suggestions have recently been made regarding a possible proton-proton reaction.<sup>1</sup>

It is possible that there are in addition other reactions at various depths, adapting themselves to the temperature, pressure, and other conditions existing at any depth. For instance, the reaction between hydrogen and lithium and some other light elements takes place at a much lower temperature and may happen nearer the surface and, possibly, give rise to local outbursts of sunspots, flares, etc., to be discussed later, but this is conjecture. On the other hand, it seems impossible that the heavier elements can be disintegrated in the Sun, as much higher temperatures would be required.

The supposition that the large supplies of hydrogen in the Sun are being gradually converted into helium raises another interesting question, as pointed out by Professor Gamow, namely, is the general temperature of the Sun rising or falling? The Sun has generally

<sup>1</sup> See page 335.

been referred to as a G-type dwarf star which is cooling, but, provided that sufficient hydrogen is present, the time taken to complete the cycle of reactions described above will depend upon the proportion of carbon and nitrogen available in the Sun. Assuming that this is 1 per cent, which astro-physical evidence seems to show, then the energy liberated at 20,000,000° would agree with the observed amount of energy radiated from the Sun. The amount of helium would gradually increase and to some extent replace the hydrogen. Helium at high temperatures is more opaque to radiation than hydrogen, therefore there would be a tendency for some of the liberated energy to be retained, and this might very well result in a gradual *increase* in the general temperature of the Sun during the next 10,000 million years or so. This would mean that the Sun is still a G-type *main sequence* star<sup>1</sup> not yet started on the dwarf stage of its existence.

Radiation is continually passing outwards from the solar surface, and it is estimated that some 4 million tons of solar matter are being converted into energy every second to keep up this radiation. Almost the whole of this enormous output of energy is dissipated in space, only an infinitesimal portion, about one 100 millionth, being intercepted by the planets.

The measurement of the intensity of solar radiation in the form of heat, received and intercepted by the Earth, is the only direct means of estimating the total *observed radiation* mentioned several times above. A proportion of this radiation is absorbed by our atmosphere and this necessitates considerable and careful research to arrive at a true valuation of that received outside, or above, the atmosphere. This absorption varies, not only with the state of the atmosphere, but according to the wave-length of the radiation received, so that the latter must be analysed in this respect. Also measurements must be made through different thicknesses of atmosphere from varying heights and for different angles of altitude of the Sun, as well as at different times under varying atmospheric conditions.

The instruments used, bolometers (invented by S. P. Langley), pyrliometers, etc., are very sensitive and all depend upon the varying resistance to electric current of certain metals when heated. The metals, wires, or strips are blackened to ensure absorption and

<sup>1</sup> See page 326 and Appendix I.



eliminate reflection, and their change in resistance can be accurately determined by noting, by sensitive galvanometers, the change in the electric current passing through them when heated. The radiation can be spread into a gradation of wave-lengths by means of a spectroscope so that it can be analytically measured.

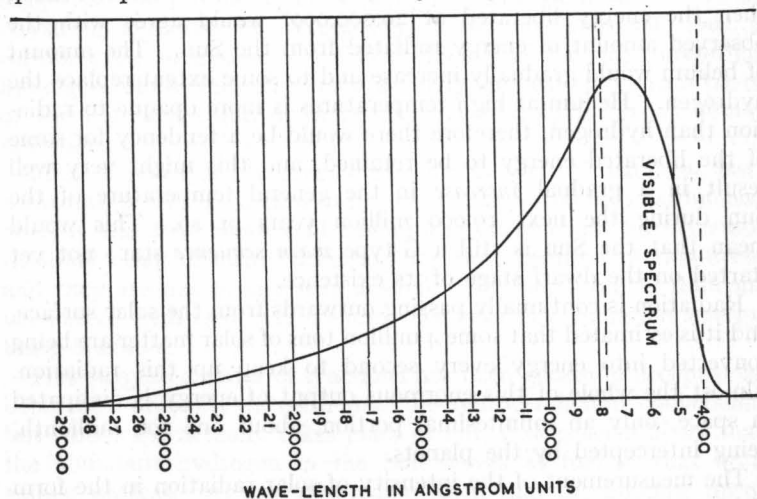

FIG. 5  
LANGLEY'S BOLOGRAPH

Showing the amount of heat radiated from the Sun. The height of the curve from the base line indicates the amount of the radiation of different wave-lengths according to the position along the base line.

Note, the largest portion of intense radiation occurs in the visible part of the spectrum, between the dotted lines.

Most of the ultra-violet or short-wave radiation from the Sun is intercepted by our higher atmosphere, and it is found that nearly all the radiation that reaches the Earth's surface falls within the range of wave-lengths peculiar to visible light and in the infra-red region largely peculiar to heat. This is, perhaps, to be expected because, doubtless, life on Earth, both animal and vegetable, has adapted itself to make the most efficient use of the kind of radiation received during its evolution.

The accompanying figure shows the smoothed curve, eliminating breaks due to atmospheric absorption, given by the bolometric

observations. From a number of records by various observers, however, the peak of solar radiation is in the blue light. It falls off rapidly in the ultra-violet, partly due to great absorption in the upper atmospheric layers, but extends by a gently falling curve, as shown in the diagram, far into the infra-red. (See Fig. 5.)

The total amount of heat received from the Sun upon a square centimetre of surface, the plane of which is perpendicular to the direction of the Sun's rays, above the atmosphere, and when the Earth is at its mean distance from the Sun, is found to be 1.94 gram-calories per minute. This is the amount of heat necessary to raise the temperature of 1 gram of water from 0° C. to 1.94 C. in one minute—or to raise the temperature of 1 ounce of water from 32° F. to 35.5 F. in 28½ minutes. This is called the *Solar Constant*. It varies slightly from time to time, apparently with the state of solar activity, but its vagaries are not yet thoroughly understood.

From the value of the solar constant it is possible to calculate the temperature of the solar surface which radiates this measured heat. By various computational methods it is found to be from 5,800° C. to 6,150° C. The exact figure depends largely on whether the Sun may be considered a perfect radiator—that is, a so-called 'black body' radiator, from the fact that perfect radiation is obtained from an opening in a heated hollow body blacked inside. Theoretically the Sun *should* be a perfect radiator, but actually it is not quite so. In any case the round figure of 6,000° C. is very nearly a correct estimate for the temperature of the solar surface.

Attempts have been made from time to time to use the direct heat of the Sun to produce power, but in these the same difficulty presents itself as in the case of 'harnessing the tides.' Although the Sun's rays in the tropics may be sufficiently hot to be very uncomfortable for human and animal sufferance, they are not very hot from a power-producing viewpoint. While this source of power is enormous in the aggregate, or even over a wide area, it is so sparsely distributed that it is impossible to concentrate or focus a really useful amount on to a power unit, such as a steam boiler or heat engine. There is also the added difficulty that, except in certain confined areas of the Earth, sunshine is intermittent owing to weather conditions. The maximum heat-power value from vertical sunshine, as in the tropics, is less than half a horse-power

per square yard of exposed surface, one horse-power being the power necessary to raise 33,000 lb. one foot in one minute, so that at a focus of a lens or mirror 12 feet in diameter the theoretical power value would be about 6 horse-power while the Sun was directly overhead. In actual practice it would be very much less than this owing to the low efficiency of such an arrangement. If a boiler were used most of the heat would be taken up in the preliminary heating of the water and the latent heat absorption in converting the water into steam.

In nature, of course, as already mentioned, the direct heat from the Sun over large areas evaporates water from the sea, which is later deposited on the land in the form of rain and snow, again over vast areas, and is then concentrated into rivers, swift-flowing torrents, and waterfalls which *are* very efficiently used for power purposes.

While there are so many efficient and more adaptable sources of stored solar energy available, it is hardly likely that the direct application artificially of solar heat for this purpose will find favour.

#### THE SURFACE OF THE SUN

When we look at the Sun with a telescope, using a protective solar eyepiece and dark glass, or by projecting its image upon a white screen, we see its brilliant surface, brighter towards the centre, with an apparently well-defined hard edge to the disk (called the limb). There may be sunspots and faculae (bright areas near the limb), but we will speak of these later.

The surface which we see is known as the *photosphere*. As already explained, the outer parts of the Sun consist of very tenuous or rarefied gas, and it is difficult to say what depth of the surface gases is necessary to give this opaque appearance, but probably we do not see far below the surface. If the sky is clear, the atmosphere very steady, and the seeing conditions consequently good, we may increase the magnification considerably and concentrate our attention upon the central parts of the disk. We shall see that the solar surface is mottled, so to speak, in two ways. There are patches of white surface separated by slightly darker spaces or divisions, something like loosely arranged crazy pavement, and the whole surface consists of very tiny, more or less circular, grains with dark areas

between. The grains, or granules as they are generally designated, are actually about 500 miles in diameter. From the Earth they appear extremely small, subtending an angle of only one second of arc, equivalent to a halfpenny removed to a distance of about three and a quarter miles. On closer examination it will be seen that

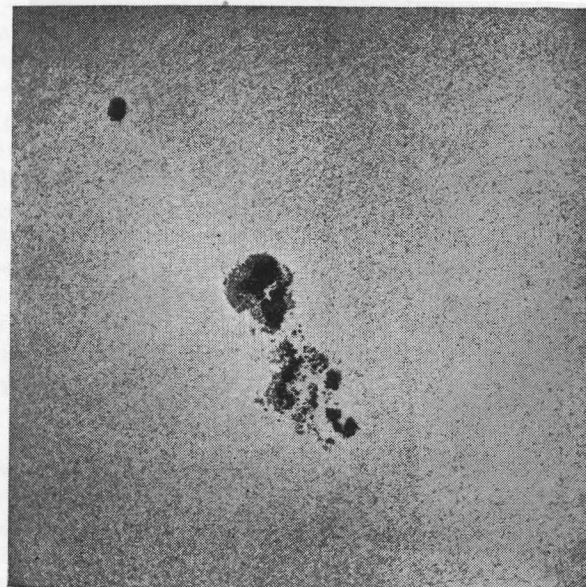

Janssen

PLATE III  
THE GRANULATION OF THE SOLAR SURFACE

the larger white patches are due to the closer crowding of the granules in certain parts.

It is not definitely known what is the origin or mechanism of these granules, but it has been suggested that they are the upper parts of columns of hot gases kept slowly in rotation (hence their circular form) by the varying speeds of the surface due to the zonal difference in speed of rotation, as already explained. (See page 16.) The granules normally lie fairly close together, there being about two seconds of arc between their centres. The somewhat darker

parts between consist no doubt of cooler gas. The granules appear to be continually in motion and give one the impression that they jostle one another rather than that they change their relative positions. They are crowded together in the neighbourhood of sunspots, especially between two spots which are very near together.

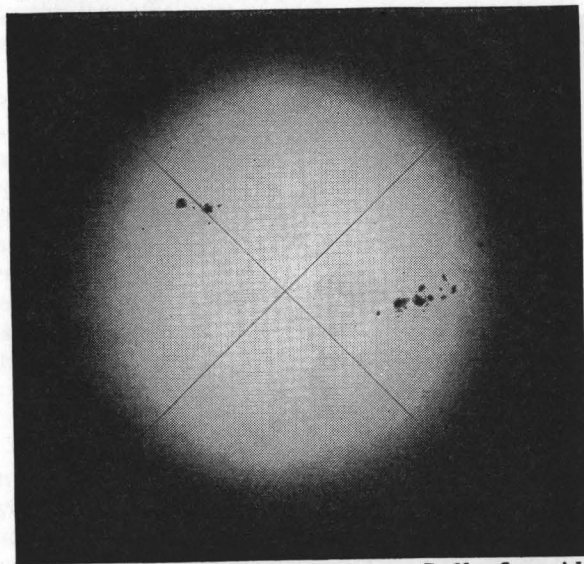

R. Obs., Greenwich

#### PLATE IV

#### THE SOLAR DISK

Showing the falling off of brightness as the edge or limb is approached.

This crowding gives a still whiter appearance to those parts of the photosphere where it occurs. The granules are not visible near the limb, but only in the more central parts of the disk. The high temperature of the gases comprising the granules, together with the extremely low pressure at the surface, result in their being highly ionized, and it is probable that this ionization, combined with the resulting free electrons, causes the extreme brightness and apparent opacity of the photosphere and the continuous type of spectrum which it emits.

It may be that the convective mechanism of the solar surface, in part at least, vested in these granules. If they are rotating columns of gas (somewhat akin to a forest of waterspouts) the much hotter gases from below might rise, radiate some of their heat at the surface and then return as cooler gas between the columns, or if they are huge clouds of gas (they have been described as bubbles), they might rise to the surface, discharge their heat, and then sink and give place to others.

The brightness of the photosphere diminishes towards the limb, owing partly to the fact that some of the Sun's radiation, including light, of course, proceeding radially from a depth in the surface, is more direct in the central part of the disk, which therefore appears brightest, and partly because some of the falling off, or darkening, towards the limb is due to general absorption by the cooler gases in the Sun's upper atmosphere. The light has to pass through a greater thickness of these upper gases as the limb is approached. Much research is being carried out in the study of the change in the spectrum (indicating changes in the behaviour of the atoms) of these upper gases, which can be seen to some advantage near the limb.

#### SUNSPOTS

Sunspots were first seen, with any kind of precision, by Galileo and others about 1610, as soon, in fact, as the invention of the telescope made it possible to see them. Exceptionally large sunspots, however, had been observed by the ancients, without optical aid, and recorded centuries if not millenniums before then. The Chinese went so far as to describe some of them as 'round,' 'egg-shaped,' or 'bird-like' and their records have been found quite useful in later research concerning sunspot periodicity.

When seen with moderate magnification in a telescope, sunspots tend to give the impression of being rather disfiguring blotches on the otherwise serene-looking, immaculate solar surface. With higher magnification it will be noticed that each separate spot has one or more dark and apparently even-toned nuclei called *umbrae*, partly or completely surrounded by a light and, generally, uneven-toned background or 'frame'—the *penumbra*—which increases the total area of the sunspot considerably, often four or five times, but this increase is very variable.

The *umbrae* of sunspots appear intensely dark, but this is due



to the contrast with the brilliant photosphere. Both are greatly dimmed by the protective darkening arrangements necessary when observing the Sun. On the rare occasions when a planet (say Mercury) transits, that is passes between us and the Sun, it is quite surprising how very much darker the disk of the planet appears than the umbrae of sunspots. If sunspots could be seen by themselves without the glare of the solar surface, they would be far too bright to be looked at with the naked or unprotected eye. Professor Menzel has said that a large sunspot under these conditions would give as much light as one hundred full moons.

The origin and cause of sunspots is at present unknown, and exactly what they are can only be deduced from our observation of them with the various instruments available. In considering their form and formation it is always very necessary to have in mind that they occur in the extremely tenuous and rarefied gaseous medium of the outer Sun, already discussed. How deep they extend below the surface of the photosphere is not known, but doubtless this is very variable. Probably they are generally funnel-shaped vortices, somewhat akin to earthly tornadoes or cyclones, but this may not apply to all. Evidence of vortical whirls is found in photographs taken with the spectroscope. The spectroscope tells us that the umbra of a sunspot is some  $1,000^{\circ}$  to  $1,500^{\circ}$  C. cooler than the surrounding photosphere, this being no doubt due, in part at least, to the effect of this whirling motion causing the inner gases to be thrown outwards by centrifugal force and thus expanded. In any case there is little doubt that the expansion of the inner gases, however caused, results in a fall in temperature. This is the converse of the heating effect on a gas by compression as experienced in a bicycle pump, for instance.

The appearance of the penumbra seems to be due to a general disturbance of the photospheric granules around the spot umbra. At the periphery of the penumbra these granules are often crowded together, giving an extra brilliance to the adjoining photosphere. This also occurs next the umbra itself at those positions where, as so often happens, there is no penumbra. In the penumbral area the granules often appear elongated or otherwise distorted and more separated. This leaves spaces or lanes of the darker gases between them, generally more or less radial to the umbra.

Evershed discovered that the Fraunhofer lines of the solar

spectrum were often distorted in certain ways over sunspots, and this had been interpreted as indicating a radial motion outwards of the heavier metallic gases from the umbra across the penumbra and also a return flow inwards of hydrogen and calcium gases at a higher level. This is known as the *Evershed Effect*.

A 'pore,' the tiny beginning of a sunspot, seems to come into being by the separation or parting of the photospheric granules exposing a larger patch of the darker and cooler gas between, which becomes the umbra. Such a pore, if single, generally disappears again in the course of a few hours. If it persists, however, it gradually increases in area, the umbra becoming darker, due no doubt to the cooling consequent upon its expansion, the granules at its periphery being at first crowded but eventually disturbed and partly separated, giving rise to the penumbra. As a rule the penumbra does not appear until the umbra is definitely formed, but there are exceptions, especially in complicated groups, where patches of penumbra are sometimes found without visible umbrae.

A single pore, appearing alone without neighbours, often develops into a round or 'regular' type of sunspot, with a more or less circular umbra surrounded by a penumbra of even width about twice the diameter of the umbra. Regular sunspots, generally speaking, do not exhibit very much activity (this word to be more clearly defined later) and do not attain very great dimensions. On the other hand, they are very persistent, lasting sometimes for several weeks, in spite of their generally moderate size.

When several pores develop simultaneously in proximity with one another it may mark the beginning of a large and complicated and active group of sunspots, especially so if there is a long stream of such pores or a second group in about the direction of the Sun's rotation. There are plenty of exceptions to this, however, but in cases where development continues this may be very rapid. The pores increase in size and coalesce, forming perhaps a combined umbra of irregular shape, surrounded or partly surrounded by the common penumbra. Some of the photospheric granules may remain compressed between some of the amassed umbrae, forming intensely brilliant divisions or lanes (generally called 'bridges') across or partly across the main umbra. On rare occasions some of these bunches of granules are entirely isolated and appear as photospheric islands completely surrounded by the umbra. New pores and

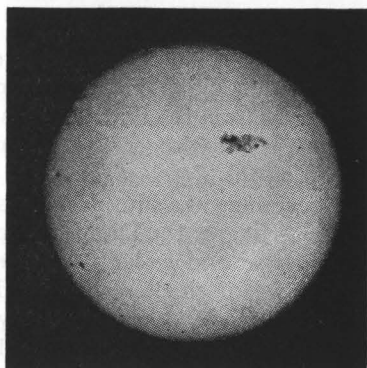

*Journal of the B.A.A.*

PLATE V

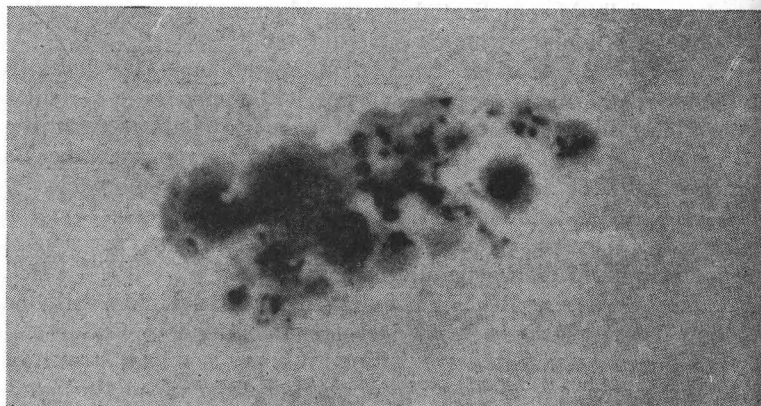

*Journal of the B.A.A.*

PLATE VI

A GIANT SUNSPOT

*Above:* The whole solar disk, enabling one to realize the size of the sunspot.

*Below:* The sunspot in detail.

This sunspot crossed the central meridian of the Sun on 1946 July 26. It reached a maximum area of 4,700 millionths of the solar hemisphere. It occurred in nearly the same locality on the Sun's surface as a previous giant sunspot in February of the same year and may have been a recrudescence of this spot which showed great activity.

Its size has since been exceeded by a sunspot of April 1947 which reached 6,100 millionths of the solar hemisphere.

umbrae continue to appear and grow in size. Large and intricate groups of sunspots often have as many as one hundred accompanying pores and small umbrae. In cases where there are two groups of pores, which are very frequent, each coalescence producing two main umbrae, the leading one, seen towards the west, is generally the better defined and more condensed. It often persists longer, becoming still more compact, while the eastern spot, the follower, and its attendant pores gradually disintegrate. Sunspots of a pair of this kind are often separated by  $10^\circ$  or  $15^\circ$  of longitude and yet are associated, as we shall see later.

Sunspots vary in size from the most minute pores, hardly visible in the telescope under high magnification and good seeing conditions, to enormous outbreaks covering thousands of millions of square miles. The largest sunspot ever recorded, since reliable observations have been made, was near the central part of the solar disk on 1947 April 7. It covered 6,100 millionths of the solar hemisphere, that is, over 6,000 million square miles or about one hundred and twenty times the area which would be presented by the Earth's disk at the distance of the Sun.

Before discussing the distribution of sunspots and other surface features and their real and apparent motions, it will be expedient to study the solar disk as it appears to us from the Earth at different times in relation to the actual position of the globe of the Sun. For convenience the solar surface is defined by parallels of latitude and meridians of longitude similarly to those of the Earth.

As already stated, the Sun's polar axis, about which it rotates, is fixed at an angle of  $7^\circ.25$  to the perpendicular of the ecliptic. The ecliptic may be considered as the plane in which the Earth revolves in its orbit around the Sun. About 8th September in each year the Earth reaches a point in its orbit towards which the north pole of the Sun inclines. At this date, therefore, the Sun's equator would appear—in imagination, of course, as it cannot be seen—as a curved line dipping  $7^\circ.25$  south of the centre of the solar disk. Similarly, about 8th March, at an interval of six months, the Sun's south pole being towards the Earth, the solar equator lies north of the centre of the disk by  $7^\circ.25$ . Early in December and June, half-way between these dates, the solar equator lies straight across the centre of the disk.

All this is with reference to the ecliptic, but, as the Earth's equator

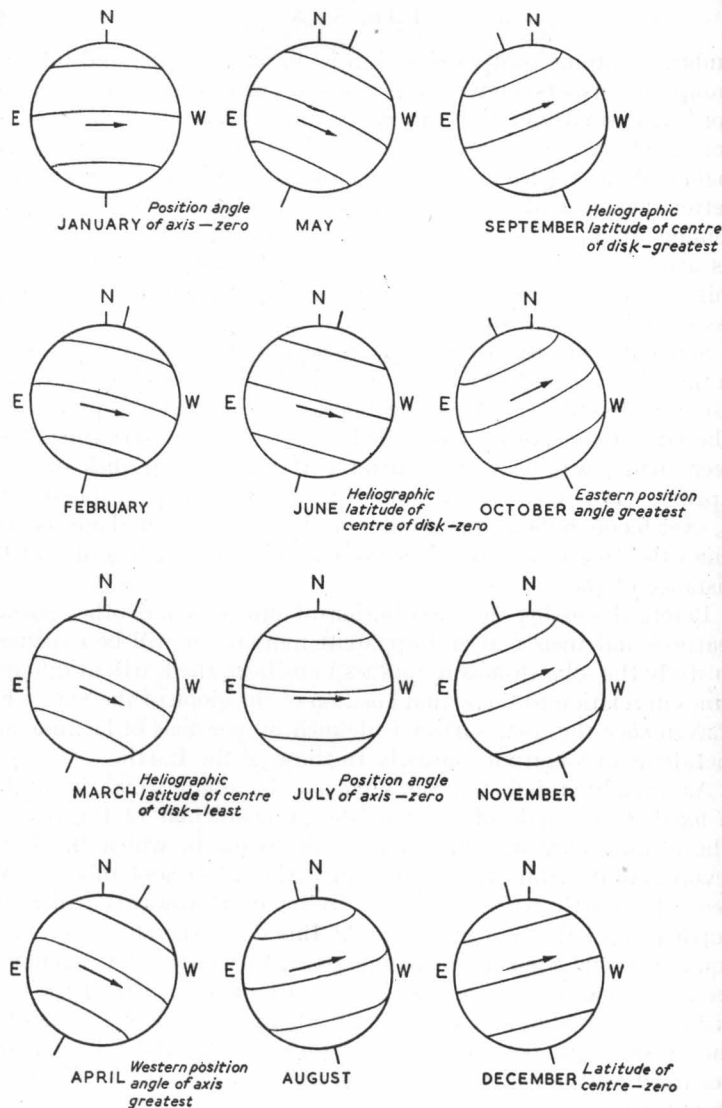

FIG. 6

POSITION OF THE SOLAR GLOBE RELATIVELY TO THE VISIBLE DISK

also slopes at an angle of about  $23^{\circ}.5$  to the ecliptic, the Sun's central meridian and its equator generally lie at an angle with the north-south and east-west positions of the observer on the Earth. This angle is a consequence of the combination of the slopes of the solar and earthly polar axes to the ecliptic. About 5th January and 5th July, the solar axis *does* coincide with that of the Earth and lies due north and south, but early in April and October its angle is greatest, being about  $26^{\circ}.4$  west and east of the north-south line respectively.

The accompanying diagram (Fig. 6) shows approximately the position of the Sun's globe with reference to its visible disk at certain times of the year, but the exact positions are given in astronomical tables, such as the *Nautical Almanac*.

Three figures only are necessary each day to define the position of the solar globe at a given hour on that day, namely:

- P. The angle of the central meridian of the Sun (or its polar axis) to the north point of the disk.  
Plus (+) if the c.m. is east of the north point.  
Minus (-) if west of the north point.
- B<sub>0</sub>. The solar (or heliographic) latitude of the centre of the disk.  
Plus (+) if it is north latitude, the equator south of it.  
Minus (-) if it is south latitude.
- L<sub>0</sub>. The heliographic longitude of the centre of the disk. This is the adopted standard longitude from which the mean solar rotation is derived.

It is often customary, however, to define the longitudinal position of a sunspot or other phenomenon by stating its longitude in degrees east or west of the central meridian at a given time. With the above information it is quite easy to determine the exact position of the solar globe with reference to its visible disk at any time.

Sunspots never appear near the solar poles. They are rarely seen at higher latitudes than  $40^{\circ}$  north or south and practically never at more than  $45^{\circ}$ , though very minute and evanescent pores have occasionally been reported at somewhat higher latitudes. Sunspots do not often appear at less than  $2^{\circ}$  from the equator. They are most prevalent between, say,  $6^{\circ}$  and  $28^{\circ}$ , but the general latitude varies with the state of solar activity, as we shall see later. They



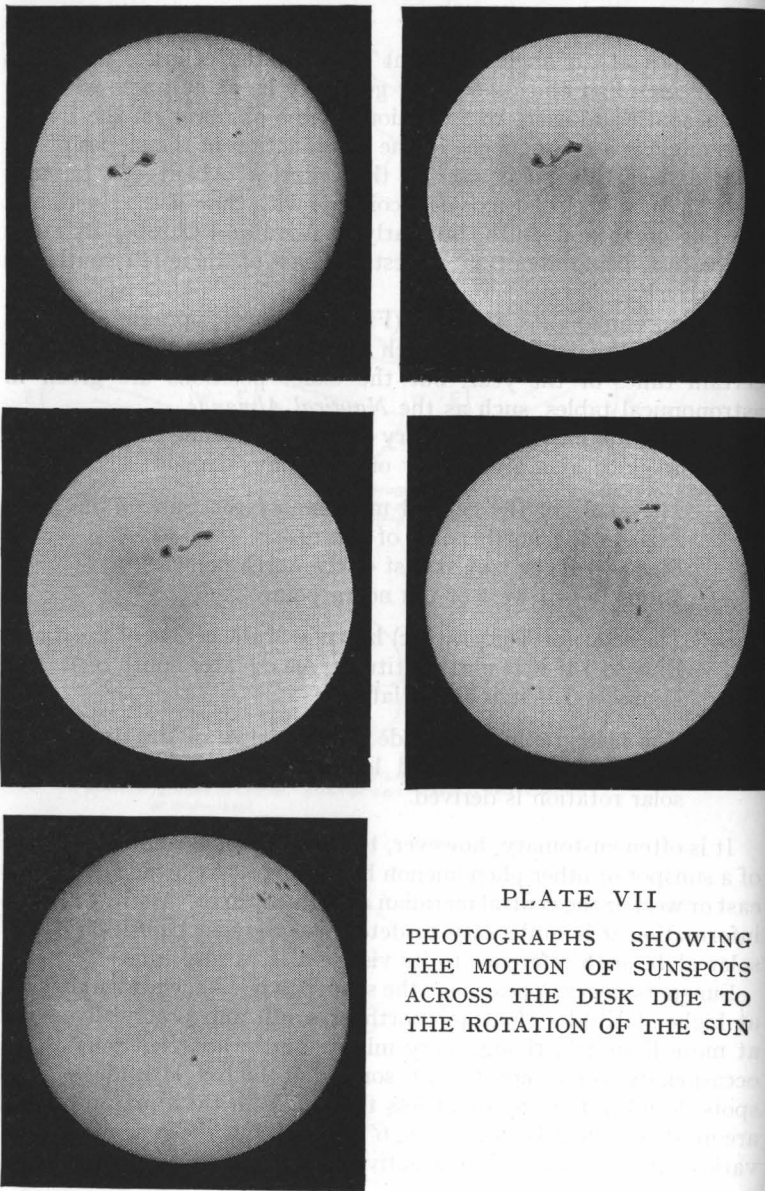

PLATE VII  
 PHOTOGRAPHS SHOWING  
 THE MOTION OF SUNSPOTS  
 ACROSS THE DISK DUE TO  
 THE ROTATION OF THE SUN

do not generally move very much from the positions on the surface at which they first appear, though pairs of spots or extended groups tend to separate, the leading spots often moving slightly forwards.

All sunspots *appear* to move across the disk from east to west with the Sun's rotation as would be expected, and this movement partakes of the varying zonal rotational speeds of the surface already described. This varying surface speed sometimes imparts to sunspots an apparent motion of their own *on* the surface. For instance, if a pair of spots or groups appear at the east limb, the leading spot being nearer the equator, it will apparently gain on the following spot, the pair becoming rather more separated, and the angle of the centre line through the spots with the equator will be slightly flattened. This is not a true individual motion of either of the spots relatively to the adjoining solar surface and must not be confused with the kind of actual surface motion of spots mentioned above.

There is some doubt as to whether the umbrae of sunspots are at a lower level than the photospheric surface. Possibly some of them are, for it has been noted that in the case of 'regular' type spots which are among the most permanent, the eastern penumbra sometimes appears the broader when the spot is near the east limb and the western penumbra broader when near the west limb. This is known as the *Wilson Effect*. It does not always apply, and moreover very few sunspots are sufficiently permanent to be sure that this interpretation is correct. In any case such differences in level that may exist are comparatively very small.

#### FACULAE

Faculae are extensive and brilliant areas on the solar disk and are conspicuous nearer the edges, or limb, where the general photospheric surface is somewhat darker. Under perfect seeing conditions, and if proper precautions are taken, they can, however, be seen at the central parts of a projected image of the solar disk. They appear to overlie the photosphere, than which they are slightly brighter, but nevertheless they cannot be seen standing out beyond the limb. When seen near the centre of the disk they do not hide the granules, but whether the granular structure pervades them or is merely seen through them it is impossible to say.

Faculae are much more generally found around, or in the neighbourhood of, sunspots or other active parts of the surface, such as in regions where pores are forming or where sunspots have recently disintegrated and disappeared; in fact, they often give warning to

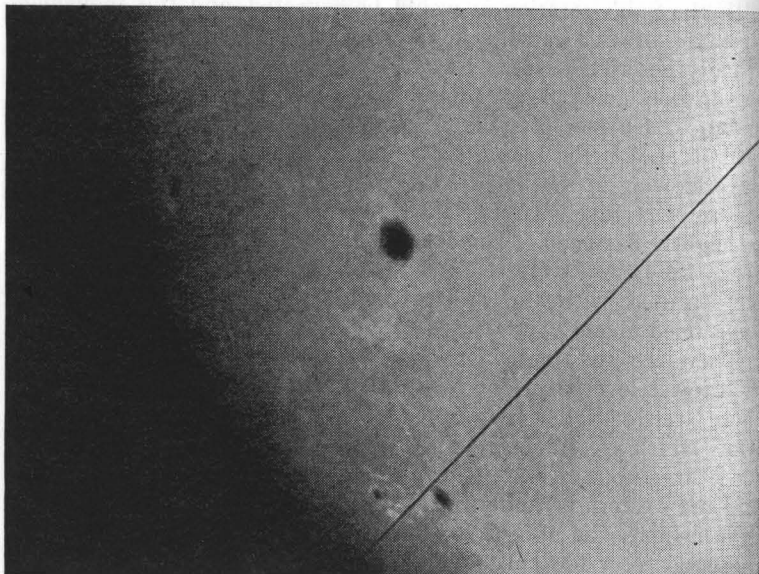

R. Obs., Greenwich

PLATE VIII  
SUNSPOT AND FACULAE

the observer of the position of coming sunspot groups. Nevertheless, they do sometimes occur where there is no other visible sign of activity.

Faculae are apparently clouds of the photospheric gases at a slightly higher level than the surface of the photosphere itself, but cannot be distinguished from it by observation with the spectroscope. Their outline is varied; at some places it consists of brilliant streaks and at others of fairly even-toned masses.

It is possible that faculae may result, in some way, from the emission areas of hydrogen and other gases immediately below them, and around sunspots (to be discussed later) with whose

outlines they agree more often than chance would lead one to expect. They are, however, an entirely different phenomenon from the hydrogen outbursts, or flares, seen in the spectrohelioscope, both described later.

#### THE PERIODICITY OF SUNSPOTS AND SOLAR ACTIVITY GENERALLY

We now have to consider one of the most baffling of the solar problems, namely, the periodicity of the Sun's activity.

It has already been stated that sunspots vary very greatly as to their size. They also vary greatly in their number or daily frequency. Both these variations follow a definite period in their rise and fall, which averages to just over eleven years.

The cause and mechanism of this periodicity is at present unknown, and probably will remain so until we know more about the origin of sunspots. It is almost impossible to dissociate it from some similarity with the variability of other stars, though perhaps in a lesser degree. Curiously enough, sunspots had been carefully observed from about 1611 until 1843 before this periodicity was definitely established, though the variation in number and size of sunspots had been recorded more than once. H. Schwabe of Dessau was the first to recognize a definite period, and shortly afterwards R. Wolf of Zürich found from numerous past records of sunspot observations that such a period did exist and had indeed existed since sunspots had first been observed with telescopes. Wolf estimated the average length of the period to be 11.1 years.

By studying carefully recorded observations Wolf was able to design a formula which would correlate the counts and records of sunspots, made by observers with different instruments and under different conditions of observations, etc. Using this formula he arrived at and recorded the so-called *Wolf Relative Numbers*, and this formula has proved to be very efficient. It is still used, and the relative numbers, next to actual measurement of daily sunspot areas, are to-day the best criterion of sunspot activity.

The period 11.1 years suffers some variation, as does also the intensity of the maxima of activity. Great efforts have been made to find some super-period which would bring these variations into line and enable the exact epoch and intensity of the maxima to be predicted, but so far all these efforts have failed. Usually after a

minimum the rise to maximum is steep, the maximum being often reached in 3.5 to 4.0 years, the fall to minimum again taking 7.0 to 7.5 years. The span of time from minimum to minimum has varied from about 9 to 12 or 13 years.

The most accurate records of sunspot prevalence or activity are

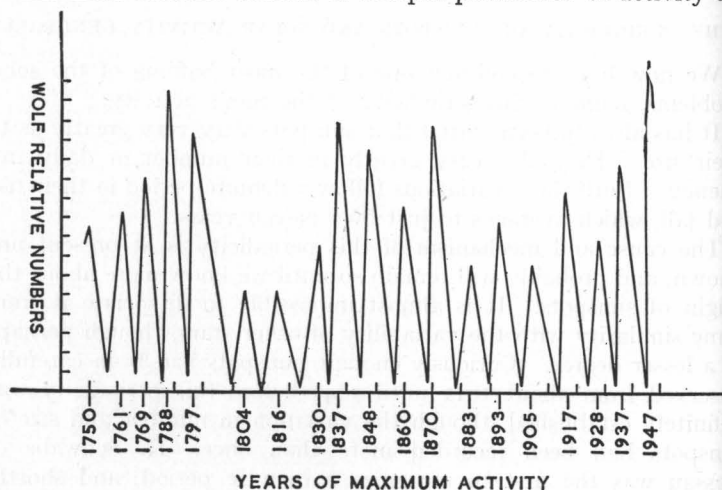

FIG. 7

CURVE OF WOLF RELATIVE NUMBERS FROM 1750 TO 1947  
Showing periods of solar activity and intensities of maxima and minima.  
Notice that both periods and intensities vary considerably.

measurements of the daily total area of all spots seen on the disk from photographs. These are corrected for foreshortening when the sunspot is not near the centre of the disk and is therefore seen in a slanting direction. This method is adopted at the Royal Greenwich Observatory, where photographs, taken in England or at the Cape or Kodaikanal in India, are available for nearly every day in the year. Careful and accurate measurements are made from these photographs with special instruments and the areas are recorded in millionths of the solar hemisphere.

This method requires accurate execution and is, therefore, not easily carried out by the ordinary observer, for whom the simplest method is to record the daily frequency of sunspot groups. This gives a fairly close approximation to the Greenwich area records.

The Wolf relative numbers method, described above, is generally very closely in accord with the Greenwich areas, but necessitates co-operative work and organization.

It may be mentioned that at about the time of the minimum of the period there may be many days together when the solar disk

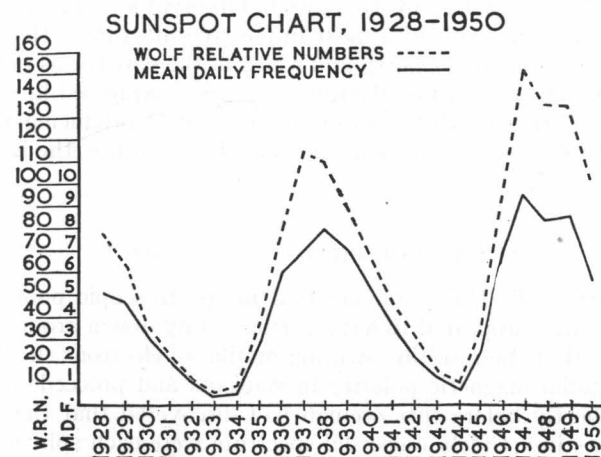

FIG. 8

CURVES COMPARING WOLF RELATIVE NUMBERS AND MEAN DAILY FREQUENCIES FROM 1928 TO 1950

Note that these two methods of estimating solar activity compare favourably, the two curves being in general agreement, but the maximum M.D.F. occurred in 1938, whereas that of the W.R.N. occurred in 1937.

appears quite clear, no sunspots being visible, while at maximum 15, 16, or even 17 groups of sunspots, including many hundreds of umbrae, may be seen day after day.

A curve derived from the Wolf numbers each year since 1750 is given (Fig. 7), also a curve for the period 1928 to 1950 and a similar curve for the same period showing group frequency counts by members of the Solar Section of the B.A.A. (Fig. 8).

In addition to the variation in size and number of sunspots, there are many other characteristics of solar periodicity amongst which the following may be noticed.

The general average latitude of sunspots gradually changes throughout a solar cycle from about  $30^\circ$  at the commencement to



about  $10^\circ$  at the end. At the end of a cycle, just before minimum is reached, most of the spots of the waning cycle will be found at low latitudes, while at the same time a few of the spots of the new cycle may be appearing at  $30^\circ$  to  $35^\circ$  north and south of the equator. This change is generally known as Spoerer's law of sunspot latitudes, and E. W. Maunder, of Greenwich Observatory, pictured this peculiarity of the Sun in a most impressive diagram. He plotted a chart, using latitudes north and south of the equator as ordinates (vertical distances on the diagram), and time expressed in years as abscissae (horizontal distances on the diagram), producing what is now a classical solar figure, called, from its appearance, the Butterfly Diagram. (See Fig. 9.)

#### MAGNETIC FIELDS IN SUNSPOTS

In 1908 G. E. Hale, noticing that in spectroscopic photographs sunspots often appeared to have vortices of hydrogen around them, surmised that the resulting swirling motion of electrons should give rise to radial magnetic polarity in sunspots and proceeded to test this. Shortly before this Zeeman had discovered that the Fraunhofer lines in a widely dispersed spectrum were each split into two or three lines if the light causing the spectrum was passing between the poles of a very powerful magnet. It was known that the spectrum lines were broader over sunspots, and Hale suspected that this might be due to the same cause and that with greater power, that is higher dispersion in the spectroscope, the Zeeman effect might be disclosed, showing that a magnetic field in sunspots existed. His surmise proved to be correct in so far that sunspots were found to be associated with very powerful magnetic fields; but it was also found, and has been confirmed since, that the direction or sense of the vortex in a sunspot did not necessarily agree with the direction of the polarity of the magnetic field found. As often as not it was opposite, so that sunspot magnetic fields cannot generally be due to this vortical motion. The latter seems to result principally from the effect of the varying zonal rotation speeds of the solar surface. Evidence derived from spectroscopic examination shows that sunspot magnetic fields rapidly weaken above the surface of the photosphere.

Pairs of sunspots, even when well separated, were found to

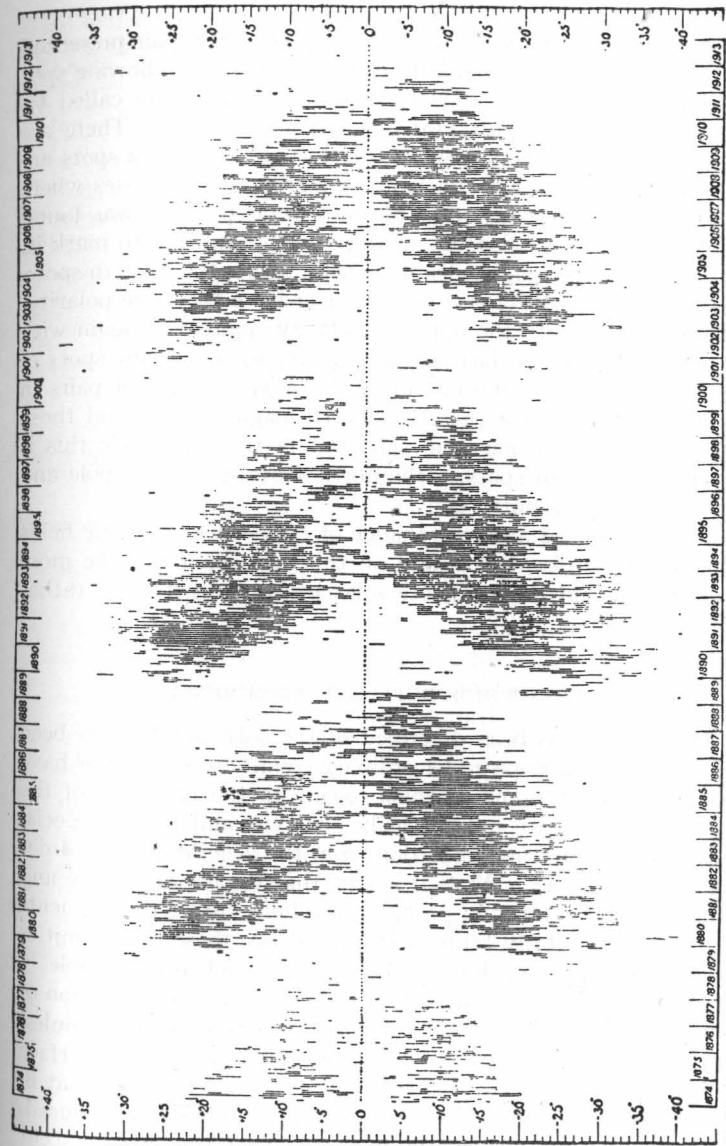

E. W. Maunder

Fig. 9. MAUNDER'S BUTTERFLY DIAGRAM. Described in text.

[Royal Astronomical Society.]

possess opposite polarities. If the leading spot of a pair presented a north magnetic pole upwards from the surface, the following spot presented a south pole and vice versa. Such pairs are called *bi-polar pairs* and, as already stated, are very common. There are some exceptions, but these tend rather to show that such spots are *not* associated and do not constitute a pair. In some cases where only one spot appeared a trace of the reverse polarity was found near by—in *faculae* or *focculi*—with no visible sunspot to mark it.

With a few exceptions the leading spots, that is the western spots, of bi-polar pairs north of the solar equator have the same polarity, and those in the south the opposite polarity; moreover, again with a few exceptions, the polarities change over with the new spots of every solar cycle. During one cycle the western spots of pairs in the northern hemisphere present a north magnetic pole and those in the south a south magnetic pole, but in the next cycle this is reversed, the western spots in the north showing a south pole and those in the south a north pole.

This has happened at every change of cycle since magnetic fields in sunspots were discovered, and on this account it may be more correct to say that the complete solar period is 22.2 years rather than 11.1.

#### THE CHROMOSPHERE AND PROMINENCES

So far all that has been described of the solar surface has been visible with the telescope under ordinary conditions. We now have to discuss some phenomena which, owing to the brilliance of the photospheric light, are not so easily observed and require special apparatus to isolate their radiation from the general glare in order to make them visible. While it is true that the chromosphere and prominences *may* be seen in profile at the limb during the moments when the Sun is totally eclipsed by the Moon, these opportunities are so rare and fleeting that much useful research is impossible.

We have seen that the photosphere, in spite of its composition of extremely rarefied gas, presents, mostly by reason of the granules, an apparently opaque surface of extreme brilliancy. This surface radiates light of every visible frequency or wave-length, so that in the spectroscope a complete or 'continuous' spectrum is produced. Work in the laboratory leads us to expect that only incandescent

solids and liquids, and gases under very high pressure, show the continuous spectrum. Doubtless the great depth of the gases comprising the photosphere and the high ionization of the atoms and the masses of free electrons—due to temperature, conditions foreign to laboratory experience—are responsible for this apparent anomaly.

The chromosphere, so named on account of the rosy hue it gives to the limb of the Sun during total eclipses, is a layer of incandescent gas immediately above but in contact with and resting on the photosphere, rapidly thinning with height to a much greater tenuity and probably eventually merging into the corona.

In the extreme lower layers of the chromosphere, up to perhaps only 500 miles or less above the photosphere, the atoms of all the elements found in the Sun are present, but in the upper layers, to some 10,000 miles or more, only the lighter or more easily ionized gases, such as hydrogen, helium, and calcium, with a few others, seem to exist.

The Fraunhofer lines, dark gaps in the continuous spectrum, are due primarily to the atoms in the lower chromosphere. These atoms are extremely agitated by thermal collisions, ionization, and radiation, and their electrons, 'jumping' in and out from orbit to orbit, emit and absorb light of the frequencies corresponding to these jumps. So long as the brilliant continuous emission spectrum of the photosphere acts as a background, only their absorption jumps outwards are visible as dark Fraunhofer lines corresponding to these frequencies. When, however, during a total eclipse of the Sun, the Moon has just covered and blocked out the light of the photosphere, this lower layer of the chromosphere is seen for an instant without the bright photospheric background; then the *inward* or emission jumps of the electrons only are seen. This results in a bright line emission spectrum, and therefore there is a complete reversal of the ordinary dark line solar spectrum. The Fraunhofer lines are seen suddenly for a moment, bright against a dark background, and for this reason the lower layer of the chromosphere is called the *Reversing Layer* and the momentary bright line spectrum the *Flash Spectrum*.

We must think of the chromosphere, therefore, as a kind of ocean of incandescent gas overlying and spreading all over the brilliant photospheric surface of the Sun. Here and there in this vast expanse are enormous flames (prominences), some steadily and

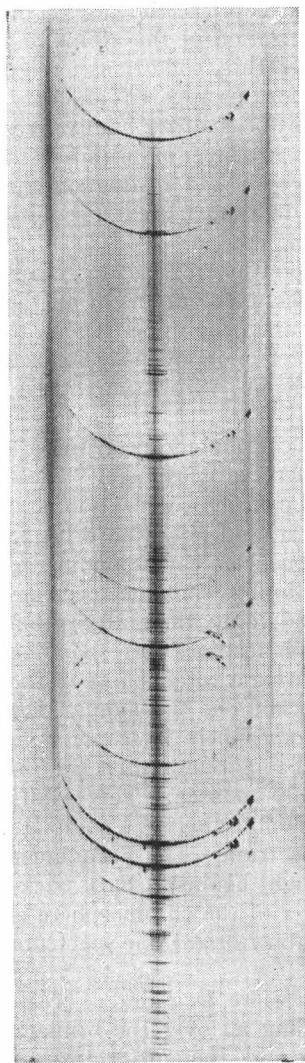

R. Obs., Greenwich

## PLATE IX

### THE 'FLASH SPECTRUM'

This photograph is taken with a spectrum camera (spectrograph) without a slit, the fine edge of the solar disk, just as the Moon nearly covers it, constituting a natural slit. This fine edge is the chromosphere, seen in profile, and its Fraunhofer lines, curved by reason of the curved edge or natural slit, are all reversed, that is, appear bright against the dark background. The excrescences are prominences.

The photograph is, of course, a negative. All the lines, etc., on it should appear bright on a dark background, not dark on a bright background. The 'flash spectrum' is what is called an 'emission spectrum' and is the effect of the inward, or emission, jumps of the electrons only being visible against the dark background beyond the bright solar disk. The same applies to the spectrum of the corona (page 19), which is also an emission spectrum.

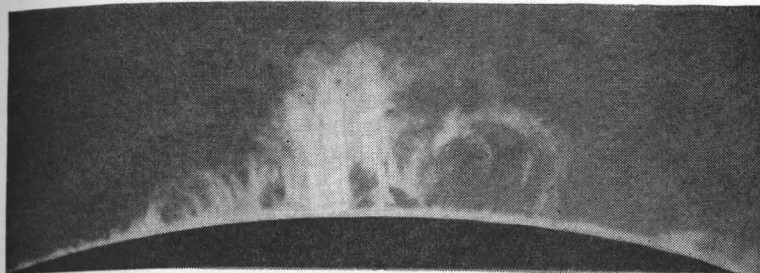

Yerkes Obs.

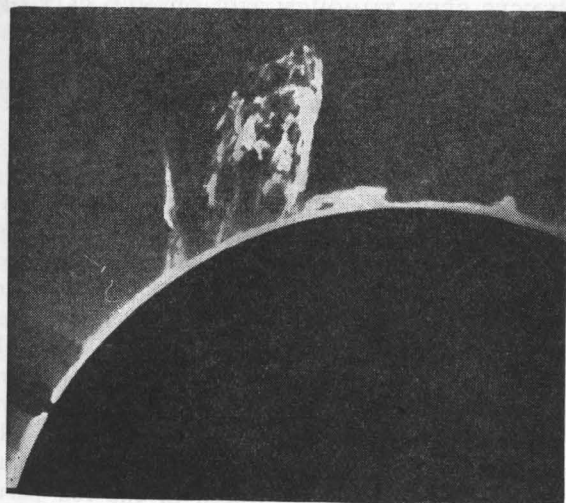

Evershed

## PLATE X

### PHOTOGRAPHS OF PROMINENCES

These photographs are taken with the spectroheliograph, the brilliant solar disk being blocked out by a metal disk of suitable diameter.



quiescently glowing, with stems from the chromosphere like forests, others, especially near sunspots, spurting up with explosive speed in the form of tapering jets, curving over to form arches, or flying right away high above the surface, and some rushing down into the solar surface.

The word 'prominence' is ordinarily applied to the incandescent gaseous masses of chromospheric material, akin to flames, when seen in profile standing up from the limb of the Sun. With modern appliances they may also be seen on the disk, more or less in plan, as it were, and there is a tendency for the term to become more general, though the words 'absorption flocculi' or 'filaments' are at present preferred for them when seen on the disk. (See page 000.)



FIG. 10

PROMINENCES SEEN THROUGH THE OPENED SLIT OF THE SPECTROSCOPE

1. In the ordinary straight slit.
2. In the curved slit. The slit is made to fit the radius of the edge of the solar image produced by the telescope. This is more generally used for observing prominences.

Until 1868 prominences were only seen during total solar eclipses. During the eclipse of that year the bright line or emission spectra of the prominences were particularly noticed by Janssen and Lockyer, quite independently, and each conceived the idea that it should be possible to see these spectra, and therefore locate prominences in full sunlight, without waiting for an eclipse. Both tried and found that not only were the emission spectra visible, but that by slightly opening the slit of the spectroscope the whole prominence, if not very large, could be seen in its true outline, and even a large one could be seen piecemeal through the widened slit. This was especially easy and satisfactory if the  $H\alpha$  line, that is Fraunhofer's line 'C,' the strongest line of hydrogen in the red part of the spectrum, was placed on the slit for the observation.

Since then prominences have been systematically observed and

recorded in this way, and it is still the best method for observing the fine detail and contrast in brightness, though several other methods have been devised since.

Prominences obey, but to a lesser extent, the sunspot frequency law. They are larger, more frequent, and more intense during periods of maximum activity, especially in sunspot zones, but they often appear in higher latitudes, even at the poles.

As seen in the spectroscope with opened slit, the upper surface of the chromosphere presents numberless points and jagged teeth which appear to be flames, and are in fact very small prominences. When a sunspot is on or near the limb, these points or jets in the vicinity are often larger and more brilliant, frequently leaping up as very bright spurts, sometimes to great heights, often curving over until the point enters the region of the sunspot umbra or penumbra, as if drawn into it, as it probably is.

Prominences may be very definitely classified. The type just described was named by Pettit the 'surge' or 'sunspot' type, and this has many variations but is generally very brilliant and rapidly moving. There are several eruptive types which may or may not be associated with sunspots. They often take the form of arches, the gases seeming to rise from the chromosphere up one root of the arch, which is very brilliant, and curve over to reach the chromosphere again at any distance from 20,000 to 300,000 miles away; or the 'interactive' type, the material rising at two points, each bending over to the other, so that the gaseous material flows in both directions over the top of the arch or bridge so formed.

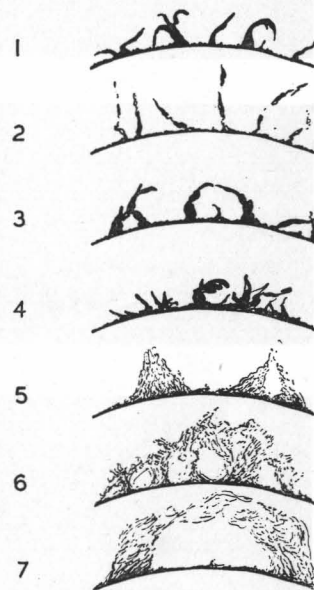

FIG. 11

TYPES OF PROMINENCES

1. Surges.
2. Rockets.
3. Interactive.
4. Brilliant and active. Often associated with sunspots near the limb.
5. Quiescent pyramids.
6. Quiescent, trees or forests.
7. Quiescent, large arches.

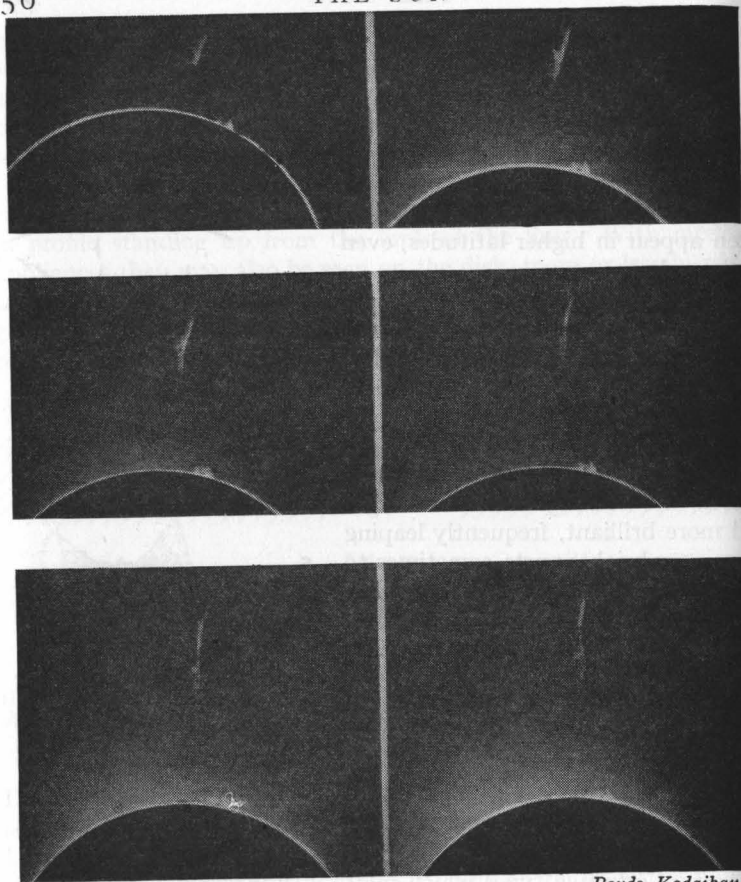

PLATE XI

*Royds, Kodaikanal*

## REMARKABLE PROMINENCE

A 'rocket' type of prominence which reached a height of nearly 600,000 miles from the surface of the Sun.

Other eruptive prominences, known as the 'rocket' type, spurt rapidly from the chromosphere and travel at enormous, explosive speed, radially or almost radially from the Sun. In one instance such a prominence was recorded at Kodaikanal, on 1928 November

19, as reaching a height of 567,000 miles, considerably over half the diameter of the Sun. (See Plate XI.)

Some prominences apparently rotate in the nature of a water-

*Eclipse, 29th May 1919. Sobral, Brazil. Greenwich Exped.*

PLATE XII

## REMARKABLE PROMINENCE

The famous 1919 eclipse prominence, fully described in text.

spout or tornado. These sometimes remain in one position for a considerable time, and the so-called 'coronal' prominences appear to condense from invisibility, high above the chromosphere, and to descend rapidly into it.

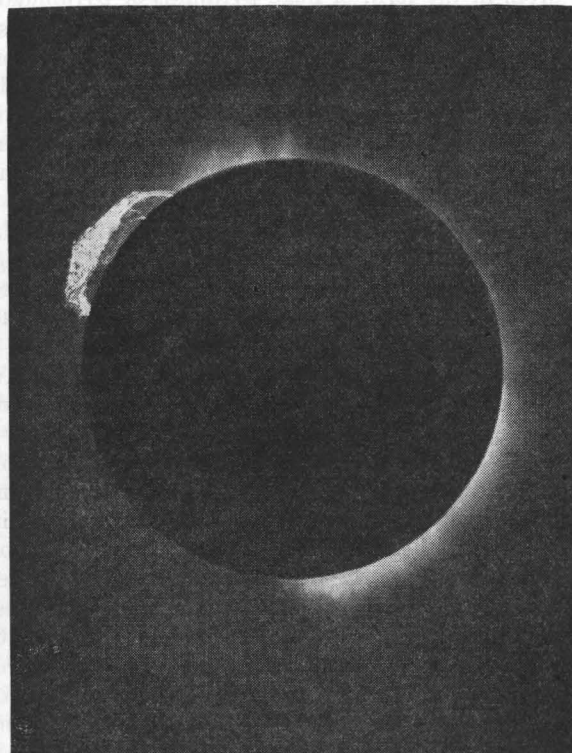
Lastly there is the 'quiescent' type of prominences. These are not generally so dense or brilliant as the above described more active prominences, but are much larger and visually more massive. They are often in the form of huge pyramids or pyramidal arches, and still more often of a series of arches with numerous stems or roots, giving one the impression of a fiery forest. They sometimes attain enormous dimensions and remain without much alteration during weeks or even months, often eventually disappearing suddenly by rising bodily and floating upwards to disperse into invisibility. One of this type of prominence figures as almost a classic example on the photographs of the total eclipse of the Sun in 1919. It first appeared on the east limb on 22nd March, at latitude  $35^\circ$  south of the equator. It increased in height and intensity on each successive appearance at the east and west limbs as the Sun rotated, and on 28th May, over two months later, was 76,000 miles high and 400,000 miles long. On 29th May, the day of the eclipse, it began to rise at 2 h. 57 m., and some five hours later had reached a height of nearly 500,000 miles and had almost disappeared. (See Plate XII.)

During the last fifteen years or so, series of photographs of prominences have been taken at about two-minute intervals and these have then been combined on a cinematograph film, the intervals between each picture being thus diminished some 400 to 600 times. Much has been learnt from these motion pictures as to the behaviour of prominences, and much of this behaviour is at present inexplicable. New problems have arisen of which the solution will be difficult. One of the most surprising facts is the large proportion of chromospheric gas which appears to materialize, or condense, high above the chromosphere and descend to it. Surge-type prominences frequently ascend in a curved path and then return along the same path in such a way that one must conclude that this motion is controlled by electric or magnetic fields. These apparently fixed curvilinear paths along which the prominence gases seem to be constrained to flow in either direction are quite common in these motion pictures. In some cases doubt must be expressed as to whether the motion seen is truly a motion of the incandescent gases or whether a mass of gas is stationary and successive portions of it are lighted up, their atoms excited into emission by heat, electric, or other agencies.

## SPECTROSCOPIC OBSERVATIONS OF THE SOLAR DISK

By means of the spectroheliograph and spectrohelioscope, the different elements and levels in the chromosphere may be observed over the Sun's disk. With the former instrument photographs may be taken in any selected wave-length, all other light being eliminated. Seeing that the upper chromosphere is constituted mostly of hydrogen, calcium, and helium, photographs are usually taken either of the hydrogen, using the broadest and most convenient hydrogen line  $H\alpha$  (Fraunhofer's C line), or of the calcium, using the very broad line 'K' at the violet end of the spectrum. The only available helium line  $D_3$  is too narrow and evanescent for satisfactory photography.

The spectrohelioscope (see pages 62-3) is a similar but visual instrument and allows the hydrogen content of the chromosphere over the disk to be visually observed to the exclusion of all other light. The advantage of the spectrohelioscope lies in its ability to enable the disk to be kept under continuous observation. What is observed is much the same with either instrument so far as concerns hydrogen, but the spectrohelioscope is not suitable for observing the calcium at the violet end of the spectrum, for which the photographic instrument—the spectroheliograph—is almost exclusively used.

Some illustrations of photographs in hydrogen by the spectroheliograph are given, and in the account of observations with the spectrohelioscope which follows, reference may be made to these illustrations.

If the slit of the spectrohelioscope is placed in the continuous spectrum, that is, not on any particular Fraunhofer line, sunspots with umbrae and penumbrae are seen much as with the ordinary telescope, but faculae and the granules are not observed. This may be due to want of contrast, which is considerably reduced. If, however, the slit is placed exactly on the  $H\alpha$  (Fraunhofer C line) and seeing conditions are suitable, the disk immediately becomes full of detail, due to the hydrogen in the chromosphere.

Prominences on the disk appear as dark, often sinuous, markings. They are darker than the disk background because only the absorption—outward jumps—of the electrons of their atoms are observable. When a prominence is partly on the disk but extends beyond the



limb, the portion on the disk is darker than the disk but the portion beyond the limb is brighter than its dark background. The reader should refer to the paragraph under 'Chromosphere,' in which the cause of the difference between the Fraunhofer solar spectrum and the flash spectrum seen at eclipses is explained. This applies also to the change from absorption dark outlines of prominences on the disk to emission outlines at the limb. Prominences which are brilliant at the limb, such as the surge type seen near sunspots, are intensely dark on the disk, often appearing considerably darker than the umbrae of sunspots. They move and alter in shape very quickly and their motion in the line of sight, that is, towards or away from the observer, may be seen and its velocity measured.

Motion *towards* the observer, that is, upwards from the disk if near its centre, called a *minus* sight-line motion, can be seen and measured by moving the slit slightly off the  $H\alpha$  line towards the blue end of the spectrum, the absorption outline becoming most intense at a particular displacement of the slit. The measurement of this displacement indicates the velocity of motion upwards, as has been already explained, by the Doppler effect. For any given wave-length, such as  $H\alpha$ , the velocity in line of sight is proportional to the amount of displacement of the slit necessary, plus or minus according to which way such displacement has to be made.

The sight-line motion of prominences at the limb may be studied in the same way; this will be the component of the motion tangential to the limb.

The helium content of prominences may be observed by setting the slit of the spectrohelioscope on the helium line  $D_3$ , and any difference in outline from that in  $H\alpha$  is then recorded.

Sunspots are nearly always surrounded, or partly surrounded, by bright patches of emission hydrogen, generally with a definite outline. It has already been mentioned that faculae (not, of course, seen in the spectrohelioscope) often follow somewhat similar outlines, but so far there is no evidence that faculae in any way result from, or are dependent upon, this emission hydrogen.

In addition to the absorption outlines (prominences) and the emission outlines around sunspots the disk has a network of bright or darker markings, sometimes including spiral whirls around the umbrae of sunspots. The small absorption markings of this network generally appear linear or sinuous in hydrogen as opposed to

the surface markings as seen in photographs taken with the spectroheliograph in calcium. These latter have a distinctly mottled appearance.

Probably the most useful observations with the spectrohelioscope are the detection and examination of the behaviour of 'flare' outbreaks. These have very definite and striking terrestrial repercussions in radio fade-outs and radio interference, aurorae, and magnetic storms, as we shall see later.

#### FLARES

These are sudden appearances of excessively bright patches of emission hydrogen which reach maximum intensity very rapidly, generally within a few minutes, and die down more slowly. They almost invariably occur in the vicinity of active sunspots and often in sunspot groups which are irregular in form and quickly changing, either growing or disintegrating. The intensity of the activity in a sunspot group has, apparently, a closer association with or more effect in producing a flare than its size, though large groups are often the more active, but not always so. Flares are classed as 1, 2, or 3 intensity. This is an arbitrary classification that depends on the size, that is the area covered, and the brightness. Some endeavour is being made to render this classification more definite, but at present no very satisfactory agreement has been reached. A major flare of Class 3 may be considerably brighter than the continuous spectrum near the  $H\alpha$  line. The brightness of the flare is estimated by means of a photometer<sup>1</sup> which places the flare patch alongside a portion of the continuous spectrum 15 A. away, where it so happens there are no appreciable Fraunhofer lines. The area of the flare is more difficult to estimate accurately because its outlines are often in the form of streaks spread for several heliographic degrees. Class 1 flares are often minute but very brilliant points, possibly several near one another, but they fade more quickly than major flares. Flares appear to remain at one level and do not show appreciable motion upwards or downwards with respect to the solar surface. They do, however, sometimes spread very rapidly over the surface. Major flares may be observed also in  $H\beta$ , in the blue part of the spectrum. Their brightness in  $H\beta$  is perhaps a better indication of intensity than in  $H\alpha$ , especially

<sup>1</sup> See pages 399-402.

in the absence of a sensitive photometer. On extremely rare occasions flares have been so brilliant that they have been seen with the ordinary telescope as whiter patches on the photosphere; that is,

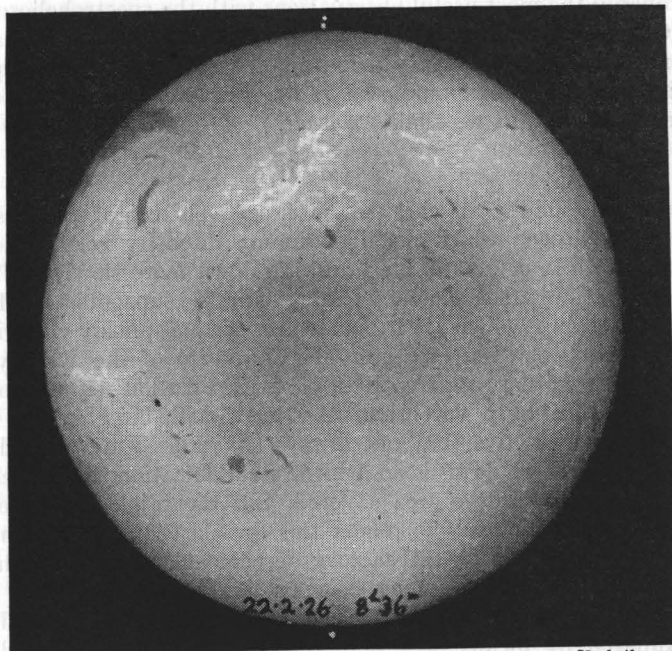

Kodaikanal

### PLATE XIII

#### SPECTROHELIOGRAMS

Photographs of the solar disk taken with the spectroheliograph.

1. Taken on the  $H\alpha$  line in hydrogen light. Note the bright 'flare' emission and its streaky formation, in the northern hemisphere. Also the dark absorption filaments, indicating prominences on the disk. The one on the north-east limb, top left, is partly on the disk, and in the original photograph can be seen partly beyond the limb as a prominence in profile, brighter than the background.

without the assistance of the spectroscope to eliminate all but hydrogen light.

Satisfactory visual observations in calcium have not, so far, been made. The K Fraunhofer line in the violet cannot be seen at all

by many people without some filter, and in any case violet or ultra-violet is very injurious to the eyes. The calcium lines in the more visible part of the spectrum are thin and weak and very

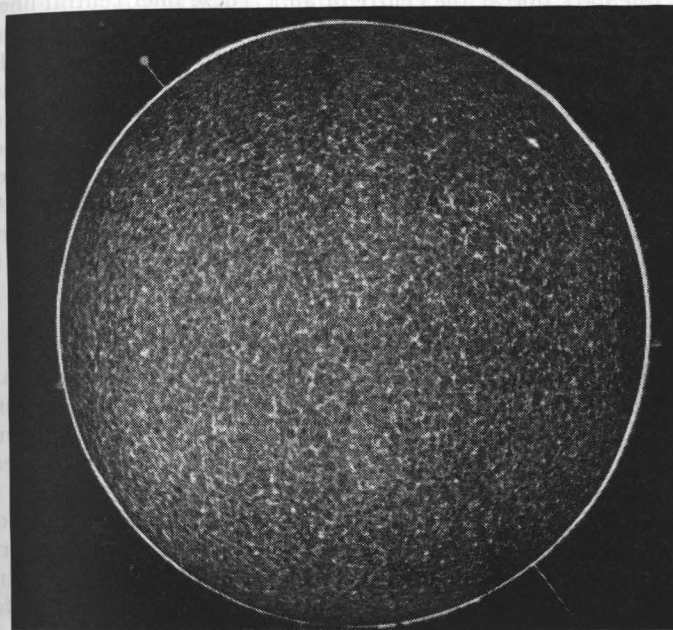

Evershed

### PLATE XIV

2. Taken on the K line of calcium. Note the mottled appearance of the disk in calcium.

unsatisfactory. However, *photographs* in calcium are, on the other hand, entirely satisfactory. Calcium photoheliograms are entirely different from those in hydrogen, as may be seen by a comparison of the illustrations. Calcium photographs of the solar disk show an excessive and large type of mottling or flocculi with very decided and extensive bright areas around sunspots and also in other parts.

In photographing calcium the K line is almost invariably used. It is more convenient than the nearby H line, also due to calcium, as this line lies very close to a line due to another element. The

K line is an extremely broad line, its full width being due to masses of calcium in the lower chromosphere. It is often reversed at its centre by a bright line and sometimes doubly reversed, appearing with a fine dark line at the centre of all. These finer central lines, either bright or dark, are due to the calcium at higher levels where the gas is more tenuous and more highly ionized. It is possible, therefore, by setting the slit of the spectroheliograph on these central portions of the line, to photograph the calcium content of the chromosphere at different levels. The mottled appearance or flocculi seen at the lower levels seems to correspond with the uneven surface of the lower chromosphere seen in profile at the limb. At higher levels the darker markings are longer and more sinuous and correspond more with the prominence absorption outlines seen in the photographs taken in  $H\alpha$ .

#### SPECIAL INSTRUMENTS USED FOR SOLAR OBSERVATION

Astronomical instruments have been dealt with in another part of this book,<sup>1</sup> but the observation of the Sun is so very different from that of other celestial bodies and objects that it is expedient to describe the special instruments necessary for this purpose here instead of under the Instrument Section.

*Solar telescopes.* There is plenty of light from the Sun and a good deal of heat which is often a nuisance. Telescopes of large aperture, that is, of great light-gathering power and capable of revealing fine resolution or ability to show minute detail, are not required for solar observation. The heat of the Sun tends to disturb the air so that the almost perfect steadiness and fine conditions of seeing, which are sometimes available in night observation, are never present for solar observation. For this reason the capabilities of an objective lens of only 5 or 6 inches aperture or diameter are sufficient, and larger lenses are not ordinarily necessary.

Refracting telescopes (those with lens objectives) are preferred to reflecting telescopes the mirrors of which tend to become heated by the Sun, their figure and image-forming properties being thereby distorted, whereas the heat mostly passes *through* lenses. Mirrors without any added reflecting surface, such as silver or aluminium, are sometimes useful if the cell (or mount) of the mirror and the lower end of the telescope tube are open to allow the heat and

<sup>1</sup> See Chapter IX.

unwanted light to pass through. Mirrors of quartz or pyrex glass, which do not appreciably expand with the heat, are more suitable than those of ordinary glass. Generally speaking, a small objective lens of from 4 to 6 inches aperture is adequate for solar observation, and very useful work can be done with even smaller lenses of good quality.

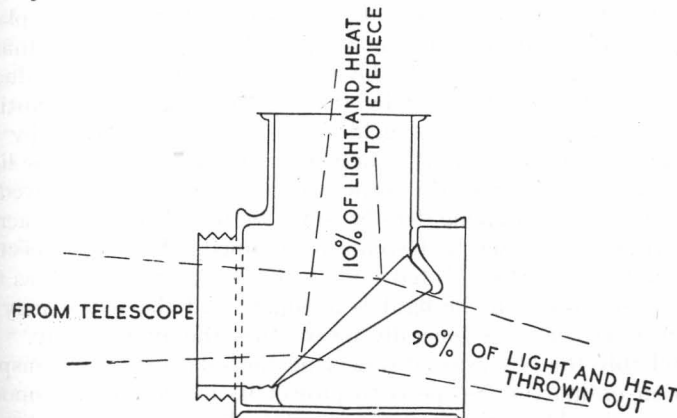

FIG. 12  
THE SOLAR DIAGONAL

The image is reflected from the plane unsilvered surface to the eyepiece. Ninety per cent of the unwanted light and heat is thrown out at the end of the tube.

*The Sun should never be observed directly through a telescope, even though the eye may be protected by a darkened glass. This glass may be suddenly splintered by the concentrated heat and the eyesight ruined.*

There are various kinds of solar eyepiece in use. The most common and quite satisfactory is a short right-angled tube with a plane glass reflector (unsilvered) at its corner. (See Fig. 12.) The end of the tube directly opposite the telescope is open. About 90 per cent of the heat and light pass *through* the reflecting glass and out at the end of the tube, the remaining 10 per cent being reflected at right angles, and the solar image is observed in this reduced light with an eyepiece and a darkened glass. The back of the glass reflector is at an angle to the front surface, the reflection



from the inside of the glass being deflected so that it does not form a double image with the primary reflection from the front of the reflector. Most solar eyepieces are constructed on this basic principle, but there are various devices for controlling the amount of light admitted to the eye to suit the conditions of seeing. If light be polarized by passing it through a specially designed prism of quartz, called a *Nicol Prism*, its waves are confined to one plane. If, then, a second Nicol prism is inserted and arranged so that it can be turned axially with the first, the light can be gradually reduced and almost cut off by turning the second prism until it admits only light-waves at right-angles to those admitted by the first prism. This system is sometimes used for controlling the light after its reflection from the plane glass, or a photographic 'wedge'—a dark glass of varying density—may be moved in a slide across the eyepiece until the best seeing is obtained. In this connection it should be remembered that under certain conditions, such as fog, a small reduction in the light is adequate and the seeing may be excellent because fog generally means that the air is steady.

Probably the best way of observing the solar disk and sunspots with an ordinary telescope is to project its image on to a smooth white card. This will dispense with the solar eyepiece and dispose of all danger to the eyes. A low-power eyepiece fitted to the telescope, preferably a Huyghenian<sup>1</sup> or other type with uncemented lenses to avoid damage by the heat, will project the whole solar disk on to a screen held by rods to the telescope tube and at about 8 or 10 inches from the eyepiece. The diameter of the projected disk may be adjusted by the distance of the screen from the eyepiece. A standard of 6 or 8 inches will admit of printed disks being used with parallels of latitude and meridians of longitude so that by properly adjusting for the current position of the solar globe with the visible disk, as already explained, the heliographic position of sunspots and faculae, etc., may be determined.

For many purposes in solar observation a long focus is an advantage and sometimes a necessity. Solar telescopes are therefore often of the fixed type, either horizontal or vertical. In this case the Sun's rays are fed to the lens by means of a coelostat, generally with a second mirror to control the position of the solar image. A description of the coelostat, which includes a fixed telescope, is given elsewhere.<sup>2</sup>

<sup>1</sup> See page 387.

<sup>2</sup> See page 394.

A fixed telescope does not necessarily require a tube if the observing room—behind the lens—is reasonably dark. In many cases it is found convenient to mount the lens horizontally at the top of a tower, directing its focal axis vertically and forming its solar image on a horizontal screen at the bottom of the tower or on the slit of a spectroscope or other apparatus. The coelostat and control mirror are then fixed just above the objective lens. This arrangement may avoid trees and secure more steady air and seeing conditions. It is more affected by wind, but this difficulty is often overcome by an outer strong and rigid tower or tube around the telescope proper and not in any way connected to it.

*The Solar Spectroscope.* The spectroscope is described under Instruments.<sup>1</sup> The form used for solar observation is similar in principle to that used for stars and planets, but, there being plenty of light, it is generally much more powerful, that is, it gives a much greater dispersion or spreading of the spectrum. To attain this end diffraction gratings instead of prisms are generally used as the dispersing agent, and longer foci for the collimator lenses or mirrors are employed. Any spectroscope incapable of showing the D Fraunhofer lines of sodium well separated, with the nickel line between them, is inadequate for solar work. A small solar spectroscope is used mostly on the ordinary refracting telescope of from 4 to 6 inches aperture for the observation of prominences as already explained.

*The Spectroheliograph* is an instrument for photographing the calcium at different levels or the hydrogen on the Sun's disk. It acts eventually as a light-filter which only allows to pass, and therefore to photograph, light of certain definite chosen wave-lengths. A certain amount of success has been achieved in the construction of a real filter for this purpose (see Monochromator below), but at present the spectroscopic method employed in the spectroheliograph is more efficient. It is merely a photographic spectroscope<sup>2</sup> (called a spectrograph) of high dispersion with a means for isolating any very narrow part of the spectrum, that is any particular wave-length. This is achieved by means of a second slit immediately in front of the photographic plate. If this second slit is placed exactly on the K line of calcium, a photograph will show a narrow strip of light which will be due to the calcium on that particular strip of

<sup>1</sup> See pages 395-6.

<sup>2</sup> See pages 396-7.

the Sun's disk whose image was focused on, and admitted through, the first or primary slit of the spectroscope. If now the Sun's image is caused to move across the first slit and at the same time the photographic plate is caused to move across the second slit exactly in time with it, there will result a composite photograph of a succession of strips of the calcium on the Sun, side by side, until the whole disk is photographed. If the motion is smooth and regular and exactly 'in step,' the strips in the photograph merge

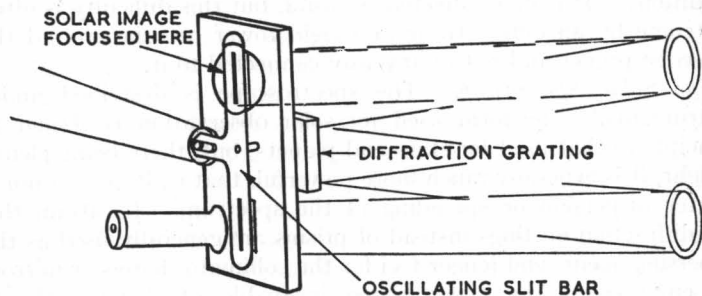

FIG. 13

Diagram showing the general arrangement of Hale's spectroheliograph. Described in text.

into one another and a smooth photograph of the entire disk in calcium is obtained. It is obvious that the desired motion may be attained either by moving the whole spectroscope, the Sun's image and the photographic plate remaining stationary, or, conversely, by keeping the spectroscope fixed and moving the Sun's image and the photographic plate together. This latter may be accomplished by allowing the Sun's image to move naturally across the first slit by reason of the Earth's rotation, and moving only the photographic plate exactly in unison with it. With the spectroheliograph, photographs, or spectroheliograms, as they are called, are obtained in calcium, at different levels according to the narrowness and position of the slit on the K line, as already explained, and hydrogen, using the  $H\alpha$  line (Fraunhofer's C line) at the red end of the spectrum.

The *Spectrohelioscope* is almost an exact counterpart of the spectroheliograph except that it is adapted for visual instead of photographic use. The modern design is due to G. E. Hale (though it

was invented many years ago by Young, to enable him to see prominences without waiting for a total eclipse of the Sun). When

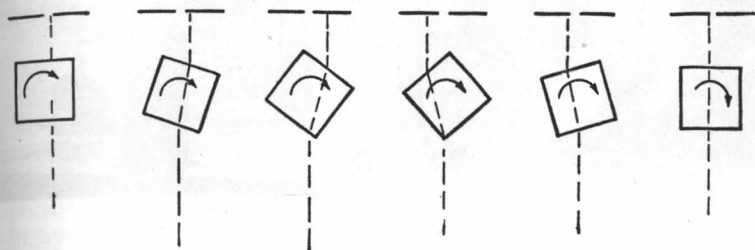

FIG. 14

## ANDERSON'S ROTATING PRISMS

Used in the spectroheliograph with *fixed* slits. Four passages of the portion of the Sun's image falling upon the prism are caused to pass across the slit for every rotation.

it was discovered that prominences could be seen quite well with the ordinary spectroscope by slightly opening the slit, Young's invention was dropped until resuscitated by Hale for observing the hydrogen on the solar disk. Hale so arranged the optical axes of the instrument that the first and second slits could be placed close together. The two slits were arranged in line with each other at either end of a light metal bar mounted on a central pivot about which it could be rocked or rapidly oscillated. This bar, in its central position, was vertical and the Sun's image was focused on the upper slit, the light rays passing through the slit to a concave mirror 15 feet behind it. This returned the light by reflection in a parallel beam to a diffraction grating mounted just behind and between the two slits. This grating dispersed the beam into a long spectrum, a portion of which fell by reflection from the grating on to a second

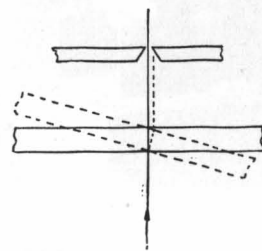
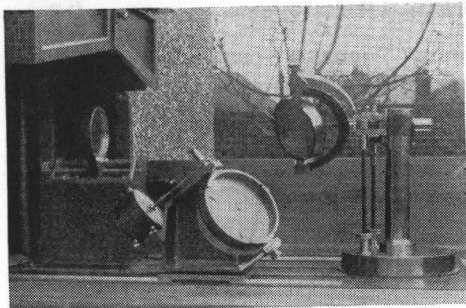

FIG. 15

## THE LINE SHIFTER

This glass deflects the  $H\alpha$  line by a small measured amount when turned to a slight angle. The same principle of refraction is used in both the line shifter and the Anderson prisms.

concave mirror immediately underneath the first. Any portion of the spectrum could be directed to this mirror by slightly turning



1

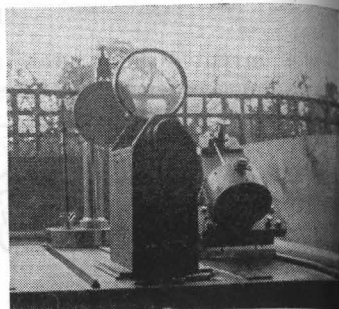

2

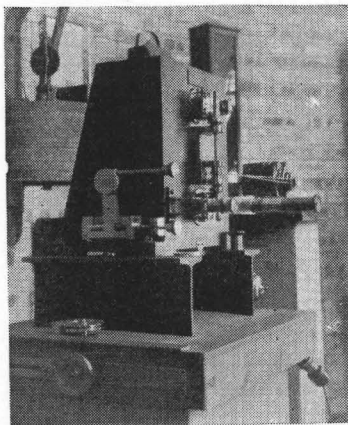

3

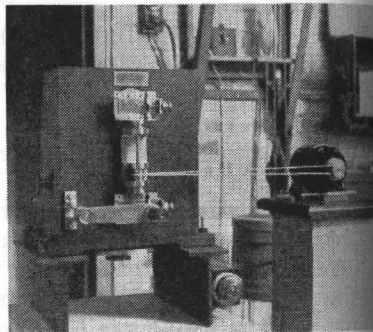

4

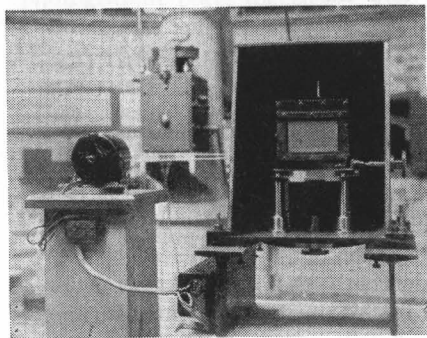

5

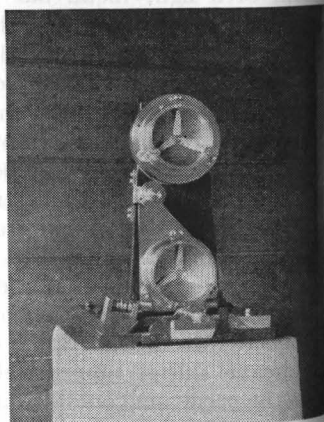

6

PLATE XV

the grating, controlled by a micrometer screw. This portion of the spectrum was reflected back by the second and lower mirror in focus on the second or viewing slit. Thus any desired line of the spectrum could be placed exactly on the viewing slit at the lower end of the bar. This slit was observed with a low-power eyepiece. With the  $H\alpha$  line adjusted exactly on the slit and the bar stationary, a mere very thin line of red light only could be seen, but when the bar was rapidly oscillated by means of an electric motor a much wider apparent opening presented itself owing to persistence of vision, disclosing an appreciable part of the solar disk in hydrogen only. The upper or first slit also oscillated with the bar, causing the whole spectrum to oscillate so that the  $H\alpha$  line also oscillated in unison with the second or lower viewing slit, but the solar image and the eyepiece being fixed, it was possible to obtain a steady view of the Sun in hydrogen. Any part of the solar disk could be placed on the first slit by the telescope controls already described. (See Fig. 13.)

While the Hale spectroheliograph was still more or less in the experimental stage, Dr. Anderson suggested the alternative arrangement mentioned above under the Spectroheliograph, in which the slits and spectrum remain fixed and the solar image and eyepiece move in unison. The slits were one above the other as before, but fixed. Immediately in front of them were two long prisms of square section mounted on a common spindle which could be rapidly

## PLATE XV

## PHOTOGRAPHS OF THE HALE SPECTROHELIOSCOPE

This spectroheliograph was made to G. E. Hale's design by Mr. A. M. Newbegin, a well-known amateur solar observer. It is now in use at the Royal Greenwich Observatory, Herstmonceux, fixed alongside a similar instrument from Greenwich, which was originally the first spectroheliograph in general use in this country.

1 and 2 show the solar telescope of 20-ft. focus. The mirrors themselves were not actually in their cells when these photographs were taken.

3 and 4. Two views of the body of the instrument, showing the slits, Anderson prisms, and motor driving them, also the eyepiece and line shifter adjustment and measuring circle underneath.

5. Back view of the body, showing the diffraction grating and line shifter.

6. The collimating mirror frame (mirrors themselves not in place). The upper mirror returns the light beam received through the first and upper slit to the grating and the lower one returns this beam, reflected from the grating as a spectrum, to the second and lower slit and eyepiece.



rotated by an electric motor. The rotating prisms were of nearly half-inch square section and mounted with their angles exactly in line (later *one* very long prism to cover both slits has been used). The effect of the rotating prism is to cause, by refraction through the thick glass, a rapid and successive passage of the portion of the solar image falling on the prism to move over the first slit and, in a similar manner and exactly in time with it, successive passages of the point of vision over the second or lower slit. The result is the same as before—a portion of the Sun is seen in hydrogen light. (See Fig. 14.)

This prism arrangement proved to be more satisfactory than the original slits in an oscillating bar and was adopted by Hale in his later designs.

However, oscillating slits *have* certain technical advantages over revolving prisms, and a spring system, designed by the writer, in which the two slits are parallel and side by side, has proved very satisfactory in a number of spectroheliscopes, including one at the Royal Observatory, Edinburgh. With this arrangement there are no pins or spindles and therefore no wear of any kind, and it is possible greatly to increase the amplitude of oscillation and yet maintain perfect synchronization between the second slit and the  $H\alpha$  line. With slits long enough and the spring system slightly enlarged it would be possible to view the whole solar disk at a time.

Hale also designed a simple method for displacing the  $H\alpha$  line by an accurately measured amount to right or left, thus affording a means for ascertaining the sight-line velocity of observed phenomena by the Doppler effect, already explained. A piece of plane glass, about  $\frac{1}{16}$  of an inch in thickness, is mounted on a vertical spindle immediately behind the second or lower slit, so that it can be deflected in line with the slit. The amount of the deflection is determined by the angle through which the glass is turned, this being shown on a quadrant which may be calibrated in angstrom units. The effect is, of course, to cause a visible shift of the  $H\alpha$  line, due to the varying refraction through the glass according to the amount of deflection. Hale called this the *Line shifter*. (See Fig. 15.)

Both the spectroheliograph and the spectroheliroscope require long focal lengths in both telescope and collimator, which are interdependent, so as to obtain sufficient spreading or dispersion of the spectrum. There is a limit to the practicable narrowness of slits,

which is about  $\frac{1}{10}$  of a millimetre or  $\frac{1}{250}$  of an inch. To get good results it is necessary that the width of the  $H\alpha$  line or the thin central part of the K line shall be wider than this so that the width of the slit will be completely covered by the spectrum line; this means a well-dispersed spectrum. It is found that with a diffraction grating of 15,000 lines to the inch, a collimation, or focal length of the spectroscope, of about 15 feet is required. This also means that to secure a solar disk image of 2 inches in diameter, the focal length of the telescope objective lens must be nearly 20 feet.

*Diffraction Grating.* It may be expedient here to say a few words about this instrument, but there is not space to give a detailed description of its working.

It consists of a metal plate, accurately flat and of highly reflective surface, such as speculum metal or other metal aluminized, ruled by means of a delicate precision machine with excessively fine lines very close together and evenly spaced. The usual standard is about 15,000 lines to the inch, that is, 150 lines in every hundredth of an inch. The very fine strips of metal between the rulings retain their highly reflective property and when daylight or sunlight falls on this plate its reflection is spread out into varying wave-lengths, forming a solar spectrum, by reason of the evenly and closely spaced strips of reflective surface. The diffraction grating gives a much more accurately spaced spectrum than prisms.

This type, a reflecting grating, is generally used, but celluloid replicas of the ruled surface may be obtained, and when mounted on glass form transmission gratings which transmit the spectrum through them instead of reflecting it. The same effect may often be seen in those closely ribbed, iridescent buttons, or in the very thin oil films formed when oil is spilled on the road.

*The Monochromator.* This is a light-filter of somewhat complicated construction, invented by Bernard Lyot. It passes only a narrow spectral band in which the  $H\alpha$  line is central. Unfortunately a great deal of light is lost, and this loss increases rapidly as the band of the spectrum passed is narrowed. With a band of from 3 to 5 Å. wide around  $H\alpha$  it is possible to see prominences well. The band passed has been reduced to about 1.5 Å., but detail on the solar disk requires more light and a still narrower band, and so far the spectroheliroscope is more satisfactory for this

purpose. It would require much space to describe this instrument fully; but briefly its effect depends on the polarization of light and its passage through a series of quartz blocks each double the thickness of the preceding one. Suffice it to say then that by this means it is possible to admit only a series of evenly spaced bands of the spectrum, which become narrower as more quartz blocks are used. By choosing the correct thickness for the first and thinnest quartz block, it is possible to centralize one of the bands admitted on  $H\alpha$ . The remainder of the bands admitted may be cut out by ordinary light-filters. Satisfactory construction of this instrument is difficult and requires great optical skill, and moreover it is very sensitive to change in temperature. At the moment it is more or less in the experimental stage, but when perfected it is quite possible that it may supersede the spectrohelioscope.

*The Coronagraph.* This instrument was also designed and first used by Lyot in 1931. It was known, of course, that scattered and reflected sunlight prevented the possibility of seeing the corona except during total eclipses when this extraneous light from the Earth's atmosphere was cut off by the Moon. Several attempts had been made to see it from the summits of high mountains, above the denser parts of the atmosphere, but these had all failed. Lyot recognized that a very considerable portion of this unwanted, scattered, and reflected light proceeded from the telescope itself. He therefore set to work to make the coronagraph, which is merely a special design of telescope from which this defect is eliminated as far as possible.

The main objective lens, rather under 6 in. in diameter, is of a single plano-convex type<sup>1</sup> of a fine quality of glass, free from bubbles or striae, ground and polished with extreme care to avoid the slightest scratches, any of which defects would give rise to scattered light. This was mounted in a long tube, extending for some distance beyond the objective to prevent side daylight falling upon it. The blackened inside of the tube was covered with a special liquid to obviate reflection, and the cell of the lens was silvered and shaped so as to reflect the sunlight falling upon it around the lens straight out again without falling upon the inside of the extension tube. The solar image formed by the lens fell upon a silvered disk, very slightly larger than the image itself.

<sup>1</sup> See page 364.

This disk was set at an angle so that the bright sunlight falling upon it was reflected out through a 'window' in the side of the tube, none of it falling on the inside of the tube itself. A second single, carefully prepared lens was mounted immediately behind the silvered disk and beyond that a diaphragm and screen, so that, as far as possible, only the light from the corona was allowed to pass to an achromatic lens producing an image of the corona, more or less free from extraneous light, which could be viewed or photographed.

Lyot employed this instrument at a special observatory on the summit of the Pic du Midi in the Pyrénées. Prominences were very well seen and, under good atmospheric conditions, photographs and spectrograms of the inner corona were obtained which have added much to our knowledge. By combining the coronagraph with the monochromator, Lyot was able to obtain still better results.

#### SOLAR ACTIVITY AND TERRESTRIAL PHENOMENA

As was pointed out at the beginning of this chapter, our existence here and all earthly phenomena are primarily due to the Sun's influence. We must, however, avoid the tendency to attribute all local earthly disturbances, such as weather, earthquakes, floods, etc., to some definite happening on the Sun, such as a large sunspot, for instance. The Earth is less than one-hundredth of the diameter of the Sun, and although it is possible that the average weather all over the Earth and during many years may have some correlation with the solar period of activity, there is no evidence whatever that such local events can be attributed to particular solar influence. Many years ago Douglass discovered that the yearly growth rings, seen in felled trees, especially in the sequoia, showed in general a variation, gradual in strength or prominence, every eleven years or so, corresponding with the solar period, which seems to show that there may be a long-term variation in the moisture, or some other characteristic of the weather, due to solar variation. Many writers have suggested various other correlations, such as crops, lake levels, arctic and antarctic ice, etc., but all these generally fail under close examination.

Up to the present the only correlation for which we have definite evidence is between solar flares and disturbance of the ionosphere or

upper atmosphere. This causes fading in short-wave radio transmission, generally followed by magnetic storms and sometimes by aurorae. When a major flare first appears on the Sun there is, with very few exceptions, a *simultaneous* fading of short-wave, long-distance radio transmission and also effects, known as 'solar noise,' on radar instruments. The fact that these phenomena are simultaneous indicated that they are radiation effects, radiation travelling to the Earth at the same speed as the light by which we see the flare. In most cases this is followed, about 24 to 30 hours afterwards, by a magnetic storm, that is, a disturbance in the Earth's magnetic field, causing the magnetic compass needle to wander and become unreliable, and often an aurora is seen in the northern or southern latitudes towards the Earth's poles. These effects are apparently caused by electronic particles ejected from the flare; it is estimated that these particles would require about 24 to 30 hours to reach the Earth. They occur only when the flare is not too far from the centre of the Sun's disk, whereas the radio fade-outs are liable to occur whenever the flare is visible, even if near the limb of the Sun. The aurorae, which occur in the upper, more rarefied atmosphere, are probably closely connected with the magnetic disturbance and are caused by the electronic particles; they may be likened to the lighting up or glowing of vacuum tubes when excited by a spark coil which produces a stream of electrons through them.<sup>1</sup>

Much research is being carried out in the investigation of these geophysical effects of solar flares. There is often a 27-day recurrence of slight electronic effects corresponding with the synodic rotation of the Sun,<sup>2</sup> which seem to be due to certain active regions on the solar surface that are not easily defined.

#### FUTURE POSSIBILITIES FOR SOLAR RESEARCH

From what has gone before the reader will gather that mankind really knows very little about the origin and causes of what he is able to observe in connection with the Sun. It appears obvious that research in the future, as in the present, will be mainly directed towards learning more about these causes. We do not know the origin or cause of sunspots, or even exactly what they are. We do

<sup>1</sup> See page 268.

<sup>2</sup> See page 16.

not know the cause of the solar period, though it *may* be closely connected with the origin of sunspots. We know very little about the reason for the corona, or why, as divulged by the motion pictures, more prominence matter seems to condense from the corona and fall into the solar globe than that which leaves it.

A new field in solar research, and for that matter in general astronomy, is opening in radio and electronic observation which, at present, is quite in its infancy. Flares can already be detected by electronic observation even when clouds obscure the Sun, but their exact position on the Sun's surface cannot be located. However, this defect appears already to be on the point of solution.

Considerable research is being carried out in England, Australia, and America investigating this short-wave electronic radiation from the Sun—*Solar Noise*, as it has been termed, from the hissing sound first noticed on certain receiving instruments. Bursts of solar noise occur apparently simultaneously with the outburst of flares and other activity. It has been difficult to correlate definitely the location on the solar surface of the source of these bursts with the position of flares observed. Recently, however, observational methods have been so improved that the source of the radiation can now be located to within about two minutes of arc.

This radiation from the Sun seems to require a very high temperature of the order of 1,000,000° C. or over and may originate in the corona over flare outbursts. Experiments at total solar eclipses when the changes in radiation can be measured as the Moon gradually occults the Sun seem to show that this radiation proceeds from a disk area larger than the visible solar disk.

As already stated, however, this new method of observation is at present only at the commencement of its development. Most of the effort so far has been towards improving the instruments, and perhaps in a few years' time, when solar activity again approaches maximum, considerable new knowledge of the Sun may be acquired.

During the past twenty years or so the spectrohelioscope, by making it possible for the Sun to be kept continuously under observation, has added very greatly to our knowledge, and doubtless will continue to do so, aided and possibly superseded by the new instrument or filter, the monochromator. Photographs of the solar spectrum whilst flares are at maximum intensity, which observation with the spectrohelioscope makes possible, have proved extremely



useful, and much information is yet to be gained from this technique.

Finally, the improvement and perfecting of instruments which are more or less experimental at present, such as the monochromator, cinematograph recording of solar happenings, and especially the electronic observational possibilities, must help our researchers to discover many things, some of which may hardly be dreamt of at the present moment.

*Note on finding the mean distance of the Earth from the Sun.* On page 4 and elsewhere <sup>1</sup> reference is made to this distance, which is known as the astronomical unit, and the following brief outline describes the principles involved in its calculation. It is necessary to anticipate some later matter in the book.

If  $P$  is the periodic time of a planet and  $a$  its mean distance from the Sun, the former being expressed in sidereal years and the latter in astronomical units, then  $P^2 = a^3$ . The periodic time of the planet Eros is about 1.76 years; the square of 1.76 is 3.0976, the cube root of which is 1.4577, and hence the mean distance of Eros is 1.4577. The mean distance of Eros, the Earth, or any other planet is easily calculated for any time when the elements, referred to earlier, <sup>2</sup> are known, and the *Nautical Almanac* gives these distances for the Earth for every day of the year. Suppose we take any arbitrary date, say May 21, when the distance of the Earth from the Sun is about 1.0123, and calculation shows that at the same time the distance of Eros from the Sun is 1.1843, then, if the Sun, the Earth, and Eros are in a line at that time (this has been assumed to simplify the problem but actually it does not occur), the distance of the Earth from Eros is 0.1720 astronomical unit.

Now suppose the distance between the Earth and Eros is found by trigonometrical methods <sup>4</sup> to be 16 million miles at the same time, then 16 million miles = 0.172 astronomical unit, or 1 A.U. = 93 million miles, approximately.

In 1930-1 Eros approached the Earth to within 16 million miles and twenty-four observatories co-operated in observing its exact positions, from which Sir Harold Spencer Jones completed his calculations in 1941 and found its distance from the Earth and Sun, thus deducing the most recent value of the astronomical unit. The angle subtended by the Earth's equatorial radius at the Sun's mean distance, the Sun being on the horizon, is known as the *solar parallax*, the value of which is 8".790. The corresponding value for the Moon is over 57'.

#### BIBLIOGRAPHY

- S. A. Mitchell: *Eclipses of the Sun*, Columbia University Press, 1923.  
 Giorgio Abetti: *The Sun*, 1938, English translation, Crosby, Lockwood & Sons Ltd.  
 Donald H. Menzel: *Our Sun*, The Blakiston Co., Philadelphia and Toronto.  
 F. J. Sellers: *Memoir of the British Astronomical Association*, vol. xxxvii, Part 2, *The Sun*.  
 Most modern text-books on astronomy have a good chapter or two on the Sun, such as W. T. Skilling and R. G. Richardson's *Astronomy*, Chapman & Hall Ltd., 1947. A very good book, though rather old, is C. G. Abbot's *The Sun*, L. Appleton & Co., New York and London, 1911.

<sup>1</sup> Pages 214, 437.    <sup>2</sup> Page 418.    <sup>3</sup> Page 5.    <sup>4</sup> Appendix II.

## CHAPTER III

# THE MOON

DR. H. P. WILKINS, F.R.A.S.

*Director of Lunar Section, British Astronomical Association*

### GENERAL REMARKS

OF all celestial bodies or objects the Moon is one of the most interesting and always attracts the most casual observer. Sometimes it hangs in the sky like a golden crescent—a bow of light; at others it is half lit up, while at full it appears as a great round ball of light so brightly lighting up the sky that only the more brilliant stars remain visible to the naked eye.

The earliest men were struck by the brightness of this beautiful orb, and long before the dawn of history men had noticed two facts about the Moon: firstly, it seemed to change its shape from night to night, from the crescent mentioned above to the broad, round face of the full Moon; and secondly, they saw that, unlike the Sun, the Moon was spotted and shaded, and these spots, whatever their nature, were always there. Whether the Moon was a crescent, half lit up or full, the same spots were seen in the same positions, and it was soon recognized that the Moon always turned the same face towards us, otherwise the spots would appear to move and the appearance of the face of the Moon would alter.

Primitive people actually thought that the Moon was a body which really changed its shape, but as time went on doubts were expressed. It was noticed that when the Moon was a thin crescent the rest of the face could be dimly seen, so that it was evident that the whole body was there all the time. The fact that the crescent was always near the place of the Sun while the full Moon was more or less opposite to the Sun's place clearly proved that the Moon was

a dark body, having no light of its own but was merely illuminated by the Sun, and thousands of years ago it was known, at least to the more educated and observant men, that the Moon was a body revolving around the Earth. The fact that its size was nearly always the same proved that its distance was more or less constant, a dark world, like the Earth itself.

#### THE MOON'S SURFACE FEATURES

The dusky markings on the face or disk, as it is technically called, of the Moon were thought by some people to be forests, by others to be a reflection of the seas and lands of our own Earth, while other people thought that they were caused by mountains and plains. The Moon is in fact too far off for the surface details to be clearly seen; it merely presents a patchy appearance, and these patches happen to resemble the outlines of a human face, as observers can see for themselves if they will look at the Moon when it is full. There are the two eyes, a rather curved nose, and a mouth, and these features have for ages been known as the 'Man in the Moon.'

For a long time nothing more was known; indeed it seemed hopeless to expect anything else unless men either travelled to the Moon or brought the Moon nearer to them; both seemed equally impossible of achievement. But the human mind is inventive, and Galileo's telescope, constructed in 1609, enabled men to visit the Moon, so to speak, without leaving the Earth. The telescope is an instrument which first forms an image or picture of some object, and this image is then magnified so that, when the telescope is turned on the object, it looks larger than it does to the naked eye.<sup>1</sup> Now if a thing is made to look bigger it is just the same thing as bringing it nearer, and for the first time men could see what the dusky spots on the face of the Moon really were and the science of selenography began. (Selenography is the delineation of the Moon's features; Selene was the goddess of the Moon in Greek mythology.)

The Moon is only just too far off for the features to be seen satisfactorily by the naked eye, so that quite a low magnifying power will show their true nature. A good field-glass or a pair of binoculars is all that is needed to give a true picture of our *satellite*—another name for the moons of the various planets, including the Earth. Any one

<sup>1</sup> See pages 371 ff.

who will take the trouble to look at the Moon with such an instrument will find a wonderful spectacle displayed. The face of the 'man,' or whatever other shape his fancy may have suggested, has disappeared and he will see a silvery globe or ball, with here and there dark grey patches, evidently plains or low-lying areas, while all over the rest of the face are large numbers of round objects, and these are the so-called *craters* or mountains of the Moon.

If the Moon is a crescent or a half-disk some of these round objects will be seen to stand on the line between the dark and light portions, and are filled with blackness. Others, farther from this line, are partly filled with this darkness, from which it is not difficult to see that the round objects are elevations, that is, mountains, and the blackness within them is only shadow; in other words, that the Moon, like our own Earth, is lit up by the Sun and that on our satellite, as with us, the mountains throw shadows.

#### MOUNTAINS AND CRATERS ON THE MOON

It is, however, somewhat difficult to realize that the bright spots are mountains until it is remembered that we are looking at the Moon from a rather peculiar position. On the Earth we see mountains from the side, but we look down on the mountains of the Moon just as if we were in an aeroplane flying at a great height above its surface. A moment's thought will show that we cannot expect to see the mountains from the side except those which actually happen to lie on the round edge of the Moon; these are seen from the side just as we see mountains on the earth, only of course we look at the Moon's mountains from a vastly greater distance.

As soon as these points are realized we cannot help marvelling at the wonderful spectacle presented to our view. The rings or craters seem innumerable; in some regions, especially towards the bottom or south, as seen in binoculars, they crowd together until the surface there looks just like a honeycomb.<sup>1</sup>

<sup>1</sup> The difference between a terrestrial and an astronomical telescope is explained in Chapter IX. If an astronomical refracting telescope is used inverted images are produced, and the north of the Moon will appear at the bottom and its south at the top to an observer in the Earth's northern hemisphere, and vice versa in the southern hemisphere. The illustrations show the lunar features as seen through a terrestrial telescope.

The craters will be seen to be of all sizes and shapes, although the majority are more or less round. Some are very large, others are mere pits of shadow. For instance, near the centre of the disk a very large one will be noticed which, when we come to apply measurements, turns out to be nearly a hundred miles across from one side to the other. In order to distinguish the craters from each other the custom arose of giving them names, chiefly those of famous men, and this large crater near the centre is known as Ptolemy.

The dark patches which, to the naked eye, combine to form the outlines of the face of the Man in the Moon are, as already stated, when seen with optical aid, in reality great plains. Now in the days when the telescope had just been invented and men gave names to the spots on the Moon, these plains were thought to be seas, because water was supposed to reflect less light than land, and they were given fanciful names such as the 'Sea of Rains,' the 'Sea of Clouds,' or the 'Ocean of Storms.' Although we now know that they are not seas (there is almost certainly no water on the Moon), the names given 300 years ago have been retained, and so have the names given to the craters.

#### BEST TIME FOR LUNAR OBSERVATIONS

The best time to look at the Moon is when it is a crescent or a half-moon, not when it is full. A moment's thought will show that when the Moon is full it is, so to speak, behind the Earth as seen from the Sun, and thus more or less directly opposite to the Sun as seen from the Earth, so that the Sun's light falls directly on to the surface turned towards us, and therefore there are no shadows. Thus at full Moon we do not get that impression of hill and hollow which is so strikingly evident in the crescent or half-moon. The full Moon indeed looks, when seen through the telescope, like a ball of light with the dark plains clearly seen, but very few craters are recognizable. (See note on page 109.)

Let us suppose that we have binoculars, or perhaps a small telescope, and look at the Moon from night to night from the time when it first appears as a fine crescent in the evening sky to the time when it is full and rises about the time the Sun sets.

The crescent Moon is hanging in the sky like a silver bow; we use our little telescope and it is immediately transformed into a

ball, for we see very plainly not only the bright portion but also the dark part faintly illuminated against the dark sky.

For a long time men were puzzled to account for this faint shining of the dark part, and it was not until the fifteenth century that the true explanation was discovered. If we remember that the Sun is shining on our own Earth as well as on the Moon it will be seen that, to other heavenly bodies, such, for example, as the Moon, the Earth must shine just as the Moon does to ourselves. From the Moon the Earth must look like a great ball of light—much larger than the Moon does to us because the Earth is so much larger than the Moon. It has indeed been calculated that the Earth reflects about sixty times as much light as the Moon does,<sup>1</sup> and if we also bear in mind that, as seen from the Moon, the Earth looks 'full' when the Moon is 'new' to us, it will be seen that when the Moon is a crescent the Earth is nearly 'full.' It acts, in fact, as a great moon to the Moon. We all know how brightly our landscapes are sometimes lit up by the full Moon, and hence it is no wonder that the lunar landscape is lit up so much that it becomes visible to us and thus enables us to see the dark part against the evening sky. It is the reflection of a reflection, for the Earth is so brightly lit up by the Sun that, acting as a mirror, the Earth reflects part of the light on to the Moon and the Moon in turn is so brightly lit up that it again reflects part of this light back to us. Of course the part of the Moon thus lit up by the Earth is not nearly so bright as the part directly lit up by the Sun, that is, the crescent, but it is sufficient to enable us to see the dark part. This phenomenon is known as the 'earth-shine.'

#### SOME CONSPICUOUS CRATERS, MOUNTAINS, AND SEAS

Having satisfied ourselves as to the explanation of this appearance we turn to the bright crescent. Several craters are seen along the line dividing the dark and the bright portions; three near the middle of the crescent are especially prominent and are known as Langrenus, Vendelinus, and Petavius. Petavius in particular is a splendid object; we can clearly see the walls which seem to cast a shadow on part of the interior, while in the centre is a mountain peak. From this peak a dark line will be seen to extend to the

<sup>1</sup> See Appendix III.



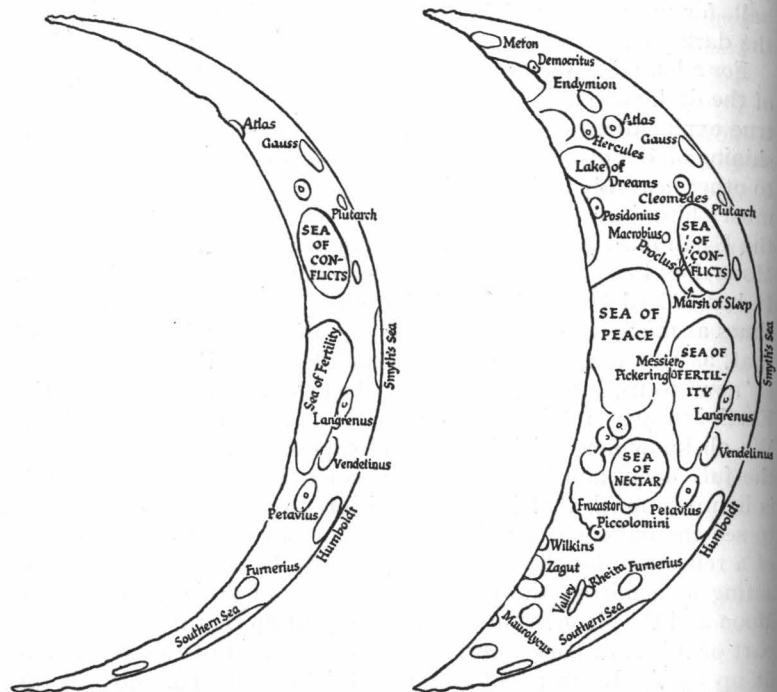

H. P. Wilkins

FIG. 16  
THE CRESCENT MOON

H. P. Wilkins

FIG. 17  
THE MOON ABOUT FOUR  
DAYS OLD

surrounding wall. This line is one of the so-called 'clefts,' which seem to be great cracks in the surface. Many are known, but few are so prominent as that within Petavius, which can easily be seen in the smallest telescope. A little plain, known as the Sea of Conflicts, will also strike the eye. This is the first plain to be seen after new Moon, and for this reason it is the first to disappear after full. It will be seen to be not perfectly level, but a few ridges, long winding banks somewhat like railway embankments, will be noted on its dark surface. It is evidently surrounded by high mountains, for they cast long black shadows across the plain. Towards the top or north of the crescent craters are few, but on

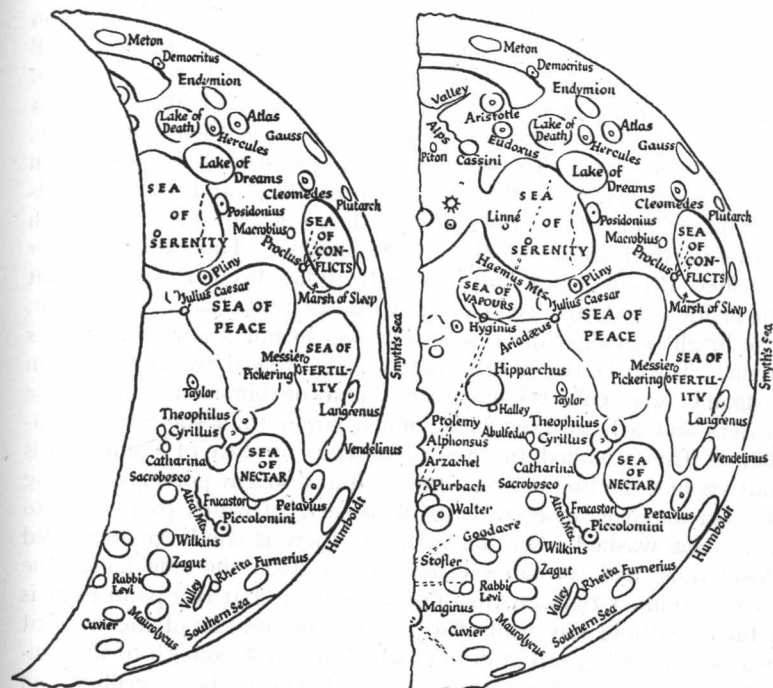

H. P. Wilkins

FIG. 18  
THE MOON BEFORE FIRST  
QUARTER

H. P. Wilkins

FIG. 19  
HALF MOON

the south they are crowded, each with the shadow inside it, some with peaks within them, while others again are smooth, and they vary greatly in size. Finally, we will be struck by the sharp points of light of the crescent, the *cusps* as they are called, and they will be seen to be drawn out into a series of dots of light, evidently the summits of mountains lit up by the Sun while their bases are still in shadow. These mountains at the bottom, known as the Leibnitz Mountains, are the highest on the Moon; some of the peaks are as high as any on the Earth, and one or two are even higher.

The next night, or better still two nights later, the Moon being

about four days old,<sup>1</sup> the crescent is bolder and wider and the Moon does not set so soon after the Sun. The Sea of Conflicts has lost all shadow and now appears as an oval spot near the bright round edge, while Petavius is now almost lost in the brightness of that part. But new craters and plains have made their appearance. On the edge of the Sea of Conflicts we are attracted by a golden tinted area. This is called the Marsh of Sleep, and on its edge is a brilliant star-like crater. From this, long bright rays stretch across the dark surface of the Sea of Conflicts. This brilliant crater is called Proclus, and quite recently it has been discovered that the inside is no longer such a pure white as it used to be, but dusky; also bright streaks can be seen, but we do not know what causes them. Towards the north, that is, the top if we are using an ordinary terrestrial telescope or a pair of binoculars, are some craters and a large grey plain, much larger than the Sea of Conflicts. This is called the Sea of Serenity or Sea of Calm and is half visible, the line between the dark and bright portions crossing it. On its edge some craters will be seen, of which parts seem to have been washed away: for instance, there is one large one called Posidonius, and we can see how the wall on the side facing the 'sea' is thinner than on the opposite side, and at one point there is a break without any wall at all. Near the middle of the crescent is a very grand group of craters which has just come into the sunlight. There are three of these called Theophilus, Cyrillus, and Catharina. Theophilus is evidently newer than Cyrillus, because it has partly overlapped the latter. In the centres of Theophilus and Cyrillus are mountain peaks which cast long shadows on the interiors. Catharina contains all manner of objects, and one of the chief of these is a ring on the floor, a crater within a crater. These three grand craters lie on the borders of a little plain known as the Sea of Nectar. Between it and the Sea of Conflicts is another plain, on the edge of which lie the craters of Petavius and Langrenus, which we noted in the fine crescent. This plain, called the Sea of Fertility, is rather rough and contains numerous ridges. In it are two little craters called Messier and Pickering, and we note that two very peculiar light streaks stretch towards the east, giving the

<sup>1</sup> The *Nautical Almanac* and other publications give the dates of new Moon, but about two days must elapse before observations are possible; the slender crescent near new Moon is difficult to see.

appearance of a comet's tail. Now the earlier observers declared that the two craters were exactly alike, whereas the smallest telescope will show that now they are quite different. One is oval from north to south while the other is oval from east to west. Some astronomers think that a change of some sort has happened to these craters.

Below the Sea of Nectar is a mountain range called the Altai Mountains, but they are best seen after the full Moon, for then the shadows stretch across the plain, whereas now there is little shadow to be seen.

#### SURFACE FEATURES AT HALF MOON

Perhaps the best view is obtained when the Moon is a half-moon, at the first quarter. All the seas we already know and another called the Sea of Peace are visible, but the craters already described are only patches on the bright surface because the sunlight is streaming down directly upon them. All along the line between the dark and the light portions numerous craters can be seen, some of which are much larger than any previously referred to. For example, nearly in the centre of the Moon is a very large one called Ptolemy, which is over 90 miles across. Although Ptolemy is so large and the surrounding walls rise thousands of feet, any one situated in the middle would not see a trace of them because the Moon is such a small world that the curve of the surface is much sharper than that of the Earth. Below Ptolemy a string of large craters stretches right down to the bottom of the Moon and their names can be found from the map. There is a great mass of craters quite close to the round edge of the Moon, and we see one crater standing out above the others. This is called Tycho, about which we shall learn more later on. Compared with these huge craters our Vesuvius is quite insignificant, for the crater of Vesuvius is little more than one mile across.

Now if we look above Ptolemy we see a little plain called the Sea of Vapours, and in this plain is a very curious object. It is a sort of great crack in the surface of the Moon and passes right through a small crater called Hyginus. Just to the north of it is a very peculiar object—a spiral or snail-shaped mountain.

A grand range of mountains separates the Sea of Vapours from



H. P. Wilkins

FIG. 20

## THE MOON AFTER FIRST QUARTER

another plain which is partly lit up. This is the Sea of Rains, which joins on to the Sea of Serenity: it will be better seen in a day or two. Near the place where the two seas join we will notice a bright spot shining like a patch of snow. This is called Linné and has a curious and interesting history. Two astronomers, Lohrmann and Mädler, who lived in the early part of the nineteenth century, drew maps of the Moon, and they showed and also described Linné as a deep crater full of shadow at certain times, whereas now we have only to glance at it to see that Linné is not a crater at all but merely a white patch, so that it looks as though some change has taken place. Perhaps the walls have crumbled and fallen in, either because a meteor struck this part or from other causes.



H. P. Wilkins

FIG. 21

## THE MOON ABOUT TWO DAYS BEFORE FULL

Finally, not far from the edge of the Moon, we see two grand craters, one called Eudoxus and the other called Aristotle. Aristotle is surrounded by rows of little hills and its walls rise thousands of feet; in the centre is the usual peak.

## LUNAR FEATURES A FEW DAYS AFTER FIRST QUARTER

About a day or two after the first quarter the view is still more interesting. The Sea of Rains is now plainly seen and the range of mountains separating it from the Sea of Vapours is very distinct.



This range is called the Apennines, and that the chief peaks are very high is evident from the long black shadows they cast. The range is so prominent that it can even be seen with the naked eye as a sort of spike jutting out into the still dark part of the Moon. In a small telescope the hills and the valleys between them will be plainly seen. On the other side of the Sea of Rains, that is, on the north or top, is also a mountain range, or rather two ranges, one called the Caucasus and the other the Alps. Some of the peaks in the Alps rise to 12,000 feet; the highest is called Mont Blanc, after the highest mountain in our own Alps. One peak in the Caucasus rises 19,000 feet above the plain. What a wonderful sight it would be to any one on the Moon, with its towering spire gleaming white against the dark sky, for on our satellite, which has no air or water, the sky must be almost black, not only by night but also during the day, and a day on the Moon lasts fourteen of our days. On the surface of the Sea of Rains, and not far from the Apennines, three craters at once catch the eye. There are two somewhat small ones, one above the other, and to the left of these is a large one with a wide wall and a smooth floor. This crater is called Archimedes and is about 50 miles across. With large and very powerful telescopes some tiny craters have been seen within Archimedes.

There is one thing about the Alps which can be seen in the smallest telescope, and that is a great valley cutting right through them. It looks as though a gigantic chisel had been driven through the mountains, and the valley is supposed by some people to have been caused by a meteor ploughing its way ages ago. Other people think it was caused by a moonquake, but there is necessarily considerable speculation on such matters.

#### MEASURING THE HEIGHTS OF THE LUNAR MOUNTAINS

How can we find out the heights of the mountains on the Moon since we cannot go there to measure them? Even on the Earth men have not yet climbed all the mountains; Mount Everest has not been conquered, but we know its height. This has been done by two people with small telescopes, both looking at the mountain-top through their instruments and measuring certain angles. The two people and the mountain-top are at the three angles of a triangle,

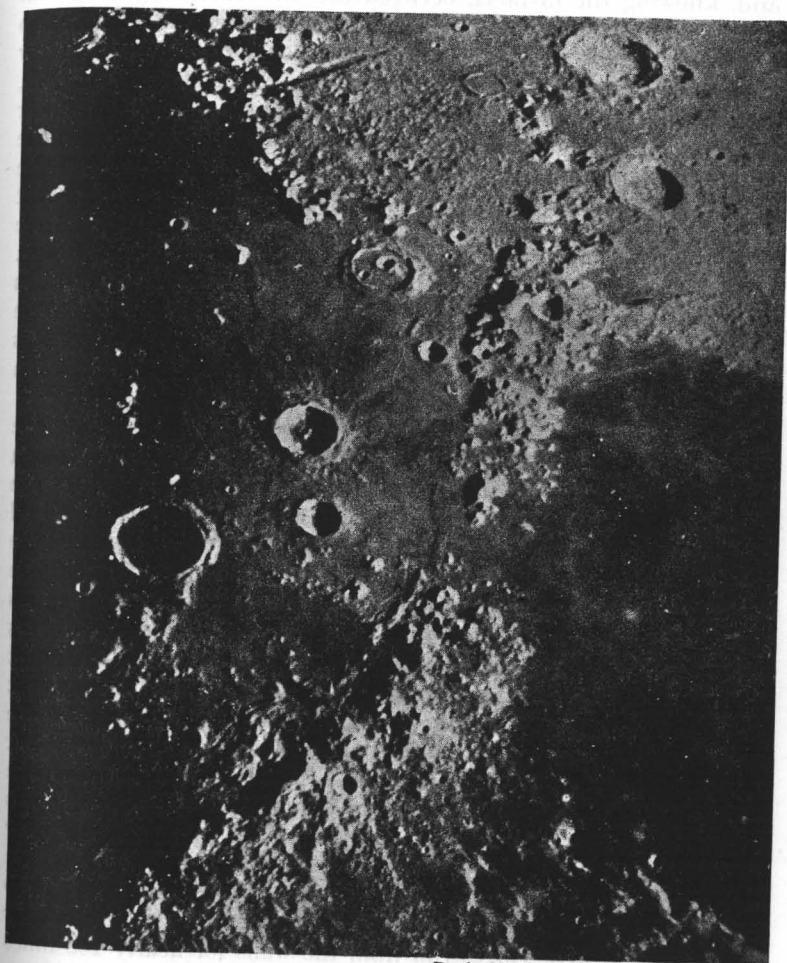

*Paris Obs. From 'Paris Lunar Atlas'*

#### PLATE XVI

THE SEA OF RAINS, ARCHIMEDES, AND THE ALPINE VALLEY

and, knowing the distance between the two observers, they can calculate the distance of the mountain, from which, having also found its angular elevation, they can calculate its height. Now although we cannot go to the Moon and set up instruments there, we can measure the height of its mountains by a somewhat similar method. As we have seen, the mountains cast long shadows, and the length of the shadow of any object depends upon the height of the source of light. We all know that the shadows of things are longest in the mornings and the evenings, when the sun is low down, while at midday the shadows are shortest. Here then we have the clue. We can measure the length of the shadows of the moon mountains and calculate the height of the Sun<sup>1</sup> as it would be seen by any one on that part of the Moon. Then all we have to do is to ask ourselves what height the mountain must be to cast a shadow of such a length if the Sun is at such an altitude in the sky of the Moon.

On the tenth night after the new Moon the shadows of the Apennines are not so long and pointed, but the Alps still show much shadow, and at the end the crater of Plato is just coming into the sunlight. What a grand object this is, even in a small telescope! The floor or inside is very smooth and level, and the shadows of the peaks of its surrounding wall of mountains stretch over the surface like the spires of some great cathedral. At least three such spires can be seen, the longest nearly reaching the other side, and this is 60 miles away. Plato seems to get darker night by night, and at full Moon it looks like a great dark oval. It has been thought that this may be caused either by some change in the surface or by the spreading of some strange form of vegetation. Having had a look at Plato we glance at the other parts of the Moon, and beyond the tip of the Apennines, and therefore almost due south of Plato, is another grand crater called Copernicus. This is one of the very finest on the Moon, over 50 miles from one side to the other, with a group of little hills in the centre and a great wall rising over 11,000 feet above the interior. All around Copernicus the surface is very disturbed and little ridges run from the walls for nearly 100 miles on every side. With large telescopes vast numbers of tiny craters

<sup>1</sup> This does not mean its height in miles but refers to its angular elevation or *altitude*. This is the angle between the observer's horizon and a line drawn from him to the Sun. A full description of the method, which involves a number of mathematical computations, is given by Thomas L. MacDonald in Goodacre's *The Moon*, pages 361-4.



FIG. 22

## THE MOON WHEN FOURTEEN DAYS OLD

can be seen nestling between the ridges. Copernicus is evidently situated on a raised part of the surface, for we can see the ground rising up towards it on all sides, and it is probably the result of a great upheaval millions of years ago.

To the south of Copernicus the Sea of Clouds can be seen, and on its right is a most peculiar object which looks for all the world like a ruler or straight-edge. This object, known as the 'straight wall,' is in reality a great cliff over 60 miles long and almost perfectly straight. By some people it is called the 'railway.'

On the southern border of the Sea of Clouds we notice a crater

\* D

from which part of the wall has vanished; this is Pitatus. Beyond this is a great mass of craters among which one stands out above the others; this is the crater Tycho, 50 miles across, and interesting because of all craters it is the most prominent at full Moon. Still farther south, and not far from the edge, is a vast pit called Clavius, and this is no less than 145 miles in diameter. Can we imagine a great pit 145 miles across entirely surrounded by mountains, and the inside very deeply sunk so that from the top of the highest part of the wall to the interior is over 3 miles? Soon after first quarter Clavius appears as a great oval patch filled with black shadow, and can just be detected by the naked eye. The smallest telescope will show that on the inside are many little craters, of which the largest are arranged in a beautiful curve.

#### FEATURES A FEW DAYS BEFORE AND AT FULL MOON

About two days before full Moon still more of the Moon's surface is lit up, and the very first glance reveals a brilliant spot on the line between the dark and bright portions. This is the crater Aristarchus, the brightest object on the entire Moon, as brilliant as newly fallen snow and in striking contrast with the now very dark Plato. So brilliant is Aristarchus that it can sometimes be seen on the dark part when the Moon is a crescent. Sir William Herschel saw it like this and thought it was a volcano in activity!

And now we have arrived at the full Moon. Just before this we cannot help noticing the great craters coming into the sunlight. For instance, nearly in the middle of the edge is a very large dark one known as Grimaldi, almost as big as a small 'sea,' while still farther south is the largest of all the Moon's craters, known as Bailly, after a famous French astronomer of the eighteenth century. Bailly is no less than 180 miles across and is full of ridges and craters.

If we remember that the diameter of our satellite is 2,160 miles, so that it is about 1,000 miles from the centre to the edge, we have a measure by means of which it will be easy to estimate the size of the various craters and 'seas.'

The full Moon looks attractive to the naked eye but very little can be seen in the telescope because, as already explained, no shadows are then visible. What will strike us are the long, bright

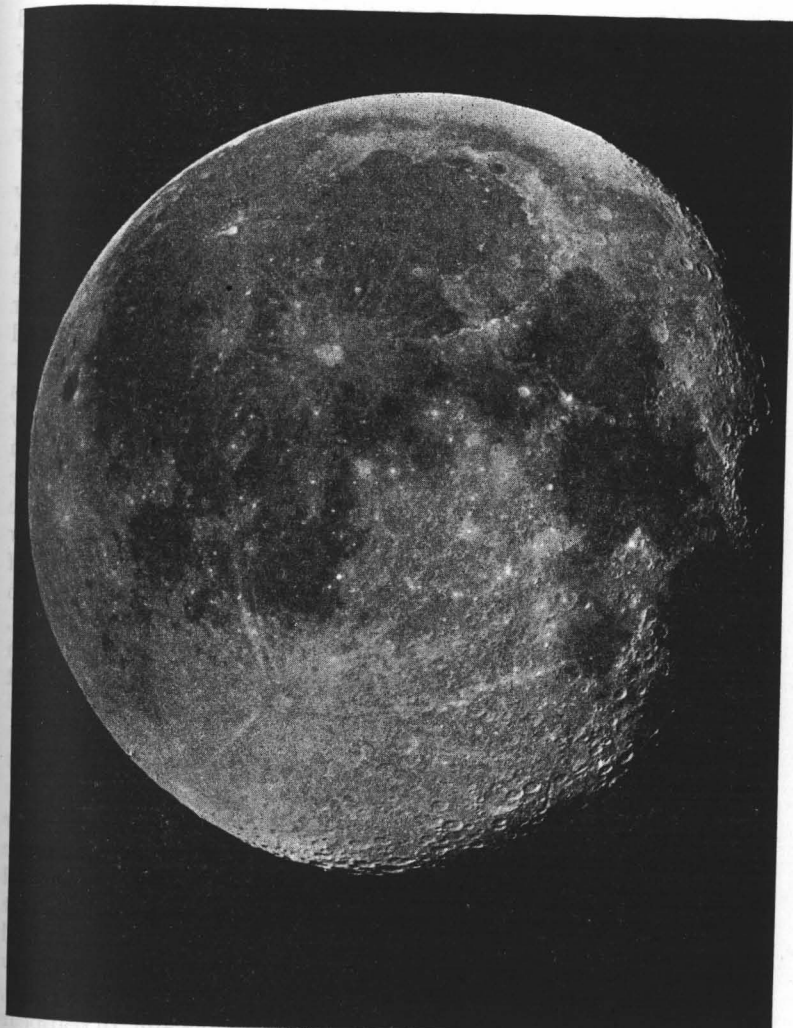

*Paris Obs. From 'Paris Lunar Atlas'*

PLATE XVII.  
THE MOON PHOTOGRAPHED NEAR FULL



rays which seem to surround the craters Tycho, Copernicus, and Aristarchus. The rays around Tycho are so numerous that they give the full Moon the appearance of a badly peeled orange. Some astronomers think that the rays are great cracks filled with a very white kind of lava; others believe they were caused by a meteor striking the surface and splashing the material all around.

There are two chief theories about the craters: one is that they are the remains of vast volcanoes in eruption millions of years ago, the other that the Moon was pelted by large meteors which acted as a sort of natural atom bomb digging great pits and throwing up the walls, thus forming the craters we see to-day. We must remember that the Moon is a small world, and because of its small size and also its comparatively low density—three-fifths that of the Earth—the force of gravity there is much less than on the Earth. It has indeed been calculated that the pull on the Moon's surface is only one-sixth of that on the Earth's surface, so that a man on the Moon could jump six times <sup>1</sup> as high or throw a ball six times as far as he could on the Earth. Some think it quite possible that the craters are really volcanoes, which for this reason would naturally be larger than any on the earth; and if we believe meteors were the cause of the craters we have to explain how it is that the Earth now shows so few signs of them. It may be pointed out, however, that the craters, if formed by large meteors striking the Earth, would be destroyed in time by the action of air and water. So the above objection is not really valid.

#### THE WANING MOON

After full Moon the bright surface begins to get smaller night after night—the Moon wanes, as we say. The first parts to go are those which first appeared in the crescent, the Sea of Conflicts and Petavius. About seven days after full the Moon is at its last quarter when one half is lit up. It now rises about midnight, and can only be seen well in the early morning. The half-moon now gives place to the crescent, the dark part becoming faintly visible, and the Moon finally disappears in the glow near the Sun, to reappear

<sup>1</sup> This refers to the man's centre of gravity, not to his feet. On the Earth an average height for the rise of a man's centre of gravity in a high jump is about 4 feet, and hence would be about 24 feet on the Moon.

on the other side, i.e. east of the Sun, as a crescent in the evening sky once more.

During all this time we can see the chief craters as one after the other they become filled with shadow and disappear in the advancing night, but now the shadows are cast the opposite way to what they were when the Moon was increasing.

These, then, are the sights which any one can see who takes the trouble to look at the Moon even with the smallest telescope or good binoculars. If we had a very large telescope we should see more, thousands of tiny craters, cracks, and other objects, but even with the largest telescope in the world, the new 200-inch on Mount Palomar in California, we could not approach the Moon sufficiently close to see living creatures even if they were larger than elephants. But it is not impossible that it will be a commonplace, a century or so hence, for men actually to visit the moon in a 'space-ship' propelled by atomic power.

#### A TRIP TO THE MOON

Suppose then we were about to visit the Moon in such a 'ship,' what would we see during our journey?

We set off at night, the Moon being just after first quarter, and since with atomic power we should be able to go very fast, the entire journey would take only a few hours. Very soon after leaving the Earth we should come out of its shadow and see the Sun again, a strange Sun shining in a black sky, for we have now left the atmosphere and there is none of that scattering of light which makes our sky like a blue dome. Already the Moon seems brighter and clearer, and as we proceed it gets larger and larger. Soon we can distinguish the various 'seas'; there is the Sea of Conflicts, there is the Sea of Serenity, and the Sea of Rains is just coming into view. As we near the Moon we notice that the Apennines are indeed a great range of mountains, for we can see the peaks jutting up towards us and the shadows black and forbidding before our eyes. It would never do to land among those formidable peaks as our ship would inevitably be destroyed, so we steer to the smooth surface of the sea not far from Copernicus, the highest summits of which are just catching the sunlight. Before stepping out we must be careful to put on our 'space-suits,' otherwise we should find it

impossible to breathe, for the Moon has no atmosphere. As soon as we step from the ship we feel very light, and we remember that on the Moon the force of gravity is only one-sixth of what it is on the Earth. For the fun of it we could make a jump or two, and what jumps they would be! It would be quite easy to jump over a good-sized house; not that we should find any houses there, for it is difficult to imagine there can be any life without air and water. Long ago the Moon may have had an atmosphere and water, and if so many forms of life could then have flourished; now all the evidence we should be likely to find would be the fossils in the rocks. And talking of rocks, what a rocky place the Moon would seem—bare rock everywhere, even the surface of the 'sea' or plain was once liquid lava and now cold and solid! From our location the newly risen Sun gives little heat to the surface, although it glows in the sky without a single cloud. The absence of air means that the heat of the Sun is not retained as it is on the Earth and the cold is intense, at least in the early morning and again in the late afternoon. Slowly, very slowly, the Sun mounts up in the sky, for the Moon, like the Earth, turns on an axis, but so slowly that it takes a *sidereal month* (which is about  $27\frac{1}{3}$  days) to make one rotation, whereas the Earth takes only a day. In fact, if we had a good cycle we could keep pace with its turning, and, moving with the Sun, see the Sun above us, but to do so we should require good roads, which, so far as we know, do not exist on our satellite! If, however, there were good roads we might accomplish the feat with an ordinary 'push-bike,' because the diminished force of gravity previously referred to would assist in attaining a high speed, and except for the fact that we should require rest and sleep, we could move all the time with the Sun. This assumes equatorial regions, but in higher latitudes we could accomplish the feat by walking. Thus in latitude  $66^\circ$  it would be necessary to move with only two-fifths of the speed required at the equator to keep pace with the Sun.

Near noon, when the Sun is high in the sky, in the Moon's equatorial regions it gets very hot indeed, almost as hot as boiling water, and at a point directly under the Sun a temperature of more than  $130^\circ$  C. exists, so we are glad to shelter from the heat and glare. We must also take precautions against dangers other than sunstroke, or rather from a very special kind of sunstroke caused by

the ultra-violet rays. On the Earth the layer of ozone in our atmosphere protects us from this, but on the Moon there is no such layer to protect us, so that we should have to use shields to cut off these dangerous rays. Almost as dangerous would be the ever-present possibility of a meteor hitting us. Without an atmosphere no warning would be given, and during our journey it would be necessary to adopt means—deflection plates—to ward off meteors. If one did strike the ship it would go right through, for meteors are like very minute planets revolving around the Sun and move round the Sun with speeds greater than that of the Earth. A device to prevent the ship's atmosphere escaping if small meteors penetrated its sides has been suggested, and would probably be used.

The first thing that would impress us would be the silence, for on the Moon no sound is ever heard. Sound is caused by waves in the air, and on an airless world like the Moon no sounds could be carried. It is a world of eternal silence, a world where the largest cannon might be fired without the least sound being heard. Looking up the sky appears black, and we note with surprise that some stars are visible even though the Sun has risen. By day as well as night the stars can be seen, strange stars which never twinkle but always shine with a steady light, for the twinkling we associate with stars is entirely due to sudden temperature changes in our atmosphere. The Sun is seen to have an apparently slow movement amongst the stars—a strange spectacle for people born on the Earth.

But above everything else we should be interested in the Earth from which we have just come. Where is it? Right over our heads, shining in the sky like a great Moon, but at this moment a crescent. As the morning wears on (and how slowly it seems to go!) the Earth still hangs overhead, but the Sun seems to approach it. Usually the Sun passes above or below the Earth, but at certain times—and this is one of them—it actually goes behind the Earth. Slowly it moves; half of it has disappeared, but still the light hardly seems to have diminished; when it has nearly disappeared we shall be enchanted by the wonderful spectacle. Although the Sun has passed behind the Earth it is still visible as a bright red light stretching for a considerable distance around the dark globe. This red light is so intense that the moonscape is lit up by it. To any one on the Earth the Moon would seem to be eclipsed, and we know that it is a very common thing for the eclipsed Moon to loom deep

red. When we on the Earth see an eclipse of the Moon, to any one then on the Moon the Sun would be eclipsed by the Earth; only these eclipses of the Sun are different from our Sun eclipses, for with us the Sun and the Moon look about the same size, whereas from the Moon the Earth looks much larger than the Sun. Then, seen from the Moon, the Sun can be entirely hidden or totally eclipsed for a much longer time than is possible with our Earth's Sun eclipses.

This red light around the Earth, as seen from the Moon, is not equally bright all round; in some parts it is very intense while at other points it is almost too faint to be seen, and at one or two points it is wanting altogether. From the Moon it is quite easy to see why this is so. The parts where the red light is most intense are places on the Earth where the weather is clear and fine, with no clouds, while other places have cloudy weather. If the weather is fine the rays of the Sun pass through our atmosphere, and when they come out again and begin their long journey to the Moon they are much redder than when they entered the air. Every one knows how in fine weather the Sun sets red, in fact if we see a red sunset we say it will be a fine day to-morrow. On the other hand, if there are many clouds about we get no red sunset but a greyish one, and rain is possible before many hours have passed. The fact is that the atmosphere sorts out the various coloured rays which together make up white light, scattering the blue ones while allowing the red rays to pass more freely. Now when the Earth comes between the Sun and the Moon, as happens when an eclipse of the Moon takes place, the various countries which lie on what to the 'people in the Moon' would be the edge, have different weather. One place has fine weather and the red light shines out; at another place the weather is cloudy and the result is that hardly any red light passes, so that part of the Earth looks dark. Hence, whenever we see an eclipse of the Moon and it looks very red when the total eclipse is in progress, we know that the weather is fine at those places which, for the 'Moon people,' seem to lie on the edge of the Earth. (The expressions 'people in the Moon,' 'Moon people,' are used for convenience of description. There is not, of course, any implication that such people exist.)

So you see it makes a great difference whether a planet has an atmosphere or not. If the Moon had an atmosphere, then, when it was passing in front of the Sun as it does when an eclipse of the

Sun takes place, the dark moon-ball would appear to be surrounded by a bright halo of red light. Instead of that we see no such halo around the dark Moon. True there is a halo, but this has nothing to do with the Moon and is white, not red, being indeed the well-known solar corona.<sup>1</sup>

Another thing which would strike our explorers on the Moon would be the duration of the eclipse. With us a total eclipse of the Sun lasts only a short time, never as long as eight minutes and nearly always much less, because the Moon looks only just large enough to cover the Sun, but to the 'Moon people' the Earth looks nearly four times as large as the Sun, and so their eclipses of the Sun last longer than those seen by Earth dwellers. During this time, when the Sun is covered up by the Earth, the temperature falls very much. We know this because with certain delicate instruments we can detect the heat which the Moon sends us, and this is, of course, only reflected Sun heat, the Moon itself having neither light nor heat. But whenever an eclipse of the Moon takes place its heat at once begins to fall, and when the Moon is quite covered it sends us no heat at all.

That is how it is on the Moon. When the Sun is high in the sky it is very hot, when the Sun is low down it is very cold, and during the night, or when the Earth cuts off the Sun's light and heat, it is extremely cold.

Still, we have not come all the way to the Moon to admire the Earth but to see the Moon, and since we are close to Copernicus the obvious thing to do is to visit this celebrated crater. Long before we arrive at the crater itself we should have to pick our way across the ridges which surround it. At first these ridges are mere mounds, but as we proceed they get bigger and higher, and before long we should arrive at the very rough outer terraces, great steep mountains with equally deep gulleys between them. Then the actual slopes of the crater would be reached, and we could easily climb these, for they are not very steep on this outer side, and we can climb six times as fast on the Moon as on the Earth. As we go up more and more of the surrounding country becomes visible, until suddenly we arrive at the summit and find ourselves standing on the edge of a vast round pit or cauldron. We are looking down into the crater of Copernicus. As far as the eye can see the walls can be traced,

<sup>1</sup> See page 18.



for the opposite side is nearly 60 miles away and to us the crater fills the landscape. Looking down we see that the inside slopes are much more rugged and much steeper than the outer ones; the floor or bottom of the crater is evidently much lower than the outer surface. But we cannot see the slopes immediately beneath our feet, for they are in shadow and on the Moon the shadows are terribly black. On the Earth our atmosphere reflects a certain amount of sunlight into the deepest shadows, but on the Moon there is no atmosphere and so everything in shadow is intensely black.

Still, we can see the jagged outline of the shadow cast on the floor far below us, and the smaller shadows thrown by the group of hills which rise in the centre of the crater. Everywhere there is the same desolation, black shadows, glaring light, rocks, rocks everywhere, no trace of vegetation, and, of course, no birds or insects or animals. It is a volcanic wilderness, a scene of grandeur but also a scene of lifelessness.

If we had gone to any other part of the Moon we should have found the same general picture: the silence, the rocky surface, the black shadows, and the brilliant light. Truly the Moon is a strange world, a place where everything always seems the same, without change or motion or life.

Yet perhaps we are a little too hasty after all. If we had visited Eratosthenes instead of Copernicus, and they are not very far apart, we would have seen strange dusky patches spreading up the slopes and even overflowing the crater wall. Even from the Earth these patches can be plainly seen and our explorers might possibly discover that the patches are really caused by a low type of vegetation, something quite peculiar to the Moon, and which is brought out by the light and heat of the Sun, just as our vegetation flourishes.

This at any rate was the explanation given by a well-known student of the Moon, the late Prof. W. H. Pickering, who had an observatory in Jamaica. Here he studied these strange moving spots from night to night and drew up elaborate charts of Eratosthenes and was firmly of the opinion that they were caused by some low form of life, perhaps the only life on the Moon at the present time. Whether this is so or not, any one can see the dark spots in Eratosthenes changing their shapes from night to night, and even if the professor is wrong it is thrilling to be able to watch these moving spots and to think that they may be due to living objects.

Our explorers would be able to settle once and for all the question as to the cause of the craters of the Moon. As pointed out on page 90, some astronomers believe that they were caused by volcanic action long ago, and that the craters are in reality the craters of gigantic volcanoes. If this is so what a grand sight it must have been when they were in full activity. Just try and imagine volcanoes 50, 70, or even 100 miles across, all steaming and glowing with molten lava. It is true that they are very much larger than any on the Earth, but they certainly look like ancient volcanoes. Many astronomers believe, however, that they were really caused by meteors striking the surface. If we drop things into clay, or if we have a mass of paste and force air through it, we make little 'craters' very like those on the Moon, even to the walls around them and a little hill in the middle. Also, as many people will know, bombs cause craters which are often deep pits with steep slopes, and just like the appearance of the Moon craters to us. Perhaps the Moon craters were formed by both volcanic action and meteors.

This suggests that possibly new craters may still be formed on the Moon. As we have seen, it is believed that Linné has changed and Messier also seems to have changed its form. Then we have seen that there are some strange spots which, in the case of Eratosthenes, can actually be seen to spread from night to night. It looks, therefore, as though the Moon may not after all be a dead world where nothing ever happens, as a great astronomer of the past declared, but a world strange indeed to ourselves, but nevertheless a world where life of some sort may still exist and where changes take place.

As we said at the beginning, we see only one side of the Moon or, to be quite accurate, a little more than one half. The Moon slowly turns on an axis just as regularly as the Earth does, taking about a month to do it, so that the day up there lasts about fourteen of our days, and, of course, the night on the Moon also lasts about fourteen of our nights. The path of the Moon around the Earth is not a circle but an ellipse, and our satellite sometimes moves more quickly than at other times, its speed being greater the closer it is to the Earth. But the Moon rotates about its polar axis with a speed that is almost uniform, and obviously this uniform speed does not keep in step with the other variable speed all through the

month, although they balance over this period. A little thought will show that under these circumstances we can occasionally see farther round the eastern and western sides of the Moon's disk.

Again, the Moon's axis of rotation is inclined at an angle of about  $6\frac{1}{2}^\circ$  to the perpendicular to its orbit (the corresponding figures for the Earth<sup>1</sup> are about  $23\frac{1}{2}^\circ$ ). For this reason, during a revolution round the Earth, the Moon's north and south poles are alternately turned towards and away from the Earth. In consequence of this people on the Earth see a little beyond each pole during the month, which implies that more than half the Moon's surface can be seen, irrespective of the other effect which gives a view of portions of the Moon's surface on the eastern and western sides of its disk.

There is also another effect due to the position of an observer on the surface of the Earth. In the northern hemisphere a little more of the Moon's northern portion, and in the southern hemisphere a little more of its southern portion, are visible. For a similar reason we see a little farther round the Moon's western side when it is rising and a little more round its eastern side when it is setting than we should do if we were in a place where the Moon happened to be vertically overhead. In these ways we get peeps at parts of the other side of the Moon. In the past some astronomers thought that the other side might be different from the side we always see, and that perhaps there are seas there and forests and other signs of life. But from the glimpses that we get of that other side we find that it is in no way different from the side we know so well. There are craters, hills, and plains, so it looks as though the entire moon were covered with the same features. Of course the views we get of the other side are not very good: we only just glimpse them round the edge of the moon-ball and cannot see them squarely as we can the side facing us. Nevertheless 59 per cent of the Moon's surface is seen from the Earth, though only 41 per cent is *always* visible from the Earth.<sup>2</sup>

#### BRIGHT STREAKS ON THE MOON

The most mysterious of all the features of the Moon are the strange bright streaks that we mentioned as surrounding Tycho and

<sup>1</sup> See page 206.

<sup>2</sup> The three effects referred to are known respectively as *libration in longitude*, *libration in latitude*, and *diurnal libration*.

Copernicus. Any one can see for himself that these strange streaks look exactly like paint marks. It is as though someone had dipped a vast brush in white paint and lightly drawn it over the Moon's surface. The bright streaks do not hide anything: they pass over the plains and mountains alike and are best seen at full Moon. When the Moon is a fine crescent and the earth-shine is bright we can faintly trace some of the streaks, so this proves that they are there all the time. When, however, there is much shadow about, as there always is except at full Moon, the dark shadows break up the streaks and they are not seen well, but at full Moon the Sun is shining more or less directly on to the surface and then the bright streaks shine out in all their glory. All sorts of theories have been proposed to account for them. We have already mentioned the idea that they are great cracks now filled with a white lava, and also the idea that they were caused by a meteor striking the Moon and splashing the soil all around. Another theory is that they may be caused by salts oozing out from the soil. In India we find something similar, and long white lines of salts dry out as the day advances, until under the hot sun they appear as bright lines.

Of course there are all manner of curious and very interesting objects on the Moon which we have no space to describe, and the features we have mentioned for each night are but the most prominent of the multitude. The entire surface of the Moon is rough and 'warted,' and compared with it our Earth seems remarkably smooth.

#### LUNAR FEATURES COMPARED WITH TERRESTRIAL FEATURES

In one way the Moon is the exact opposite of the Earth. Every one knows that on the Earth the seas are chiefly in the southern hemisphere as a glance at an atlas will show, but on the Moon the 'seas,' that is, the low-lying plains which if any water did exist on the Moon would really be seas, are nearly all in the northern hemisphere. We can see this quite clearly without any telescope, for we have only to glance at the full Moon with the naked eye to see that the dark patches are on the top or north. So in this particular the Moon is the opposite of the Earth.

In another way the Moon is very different from the Earth, and that is in the amount of light it reflects. The Earth has an atmosphere,

always containing more or less cloud, and the result is that, seen from another planet, it must appear very bright indeed. But the airless Moon has no clouds to turn their 'silver lining' and is really a very bad reflector of the Sun's light. If we look carefully at the Moon when it is a crescent, first in the evening sky and afterwards when it is waning and appears as a crescent in the morning sky just before dawn, we shall be struck by the greater brightness of the dark part of the Moon faintly lit up, as we know, by the light the Earth reflects upon it, when the Moon is a crescent in the morning sky than when it is visible in the evening. It is said that this brightness of the 'old Moon' was noticed many years ago, and men came to the conclusion that there must be some great continent in the southern hemisphere which was the cause of this lighting up of the Moon. This continent was afterwards discovered and is none other than Australia, so the existence of Australia was known long before it was reached by Europeans.

This statement appears in *Popular Astronomy*, page 100, by N. C. Flammarion, the famous French astronomer (1842-1925), translated by J. Ellard Gore. A similar statement is made by R. A. Proctor in *The Moon*, third edition, pp. 135-6, and also in other astronomical books. The effect referred to was supposed to have been noticed by navigators in the East, but the writer of this chapter cannot accept any responsibility regarding the authenticity of the story. It may, however, be pointed out that many hundreds of years ago the Polynesians were excellent mariners and are known to have steered by the stars. They also constructed crude but very effective instruments for determining their positions at sea, and it is by no means improbable that the story originated with them. Irrespective of the source of its origin, the story is of some interest for present-day astronomers.

We have mentioned the remarkable mountain peaks which so often appear right in the centres of the craters and that some of them have little craters on their tops. In some craters these peaks stand up high above the floor, in other cases they are much lower, while in many craters we can see only the little 'pips' of peaks. Evidently this means that the craters were once filled with fluid lava and this rose to different levels in various instances. There may indeed have been cases where the lava rose so high that it quite covered the peaks, and in fact we know of several craters

which, while they have regular walls and the outside slopes, have no hollow on the inside. The crater is flat, so that it looks like the stump of a tree. One of these is called Wargentín, and lies quite close to the edge of the Moon on the east or left-hand side. On the whole, however, the mountains of the moon are hollow mountains, strange to us because they have no tops.

We must not think that there are no mountains like those on the Earth, although it is easy to see that they are far fewer than the craters. On the Sea of Rains, a little way below Plato, is a fine mountain, standing quite alone and casting a long and pointed shadow in the sunlight. This mountain is called Pico and it rises sheer from the 'sea,' as though the bottom parts had been buried by the lava forming the 'sea.' It rises to 8,000 feet, twice as high as Ben Nevis in Scotland, the highest mountain in Great Britain. Not far away is another very similar mountain, which does not rise quite so high, and this is called Piton. Both are easily seen in a small telescope or binoculars, and Piton is especially remarkable because sometimes it glitters and sends out rays like a searchlight, a fact which we cannot explain.

It may be that parts of the Moon are composed of some substance which glows when bombarded with electrons—something after the manner of the ends of the cathode ray tubes used in television sets. We know that the Sun sends out all manner of rays and also electrons which from time to time reach the earth. Why should they not reach the Moon as well and, striking the surface, as the Moon has no air to ward them off, make the surface at those points glow and glitter just as we see Piton do?

#### UNFORMED LUNAR CRATERS

There are some other peculiar objects on the Moon that we have not mentioned yet, because they are not quite so easy to see as the great craters and the plains. Here and there we find what one would take for domes—just like the domes of St. Paul's or the Albert Hall. We know that they cannot actually be buildings, for they are of enormous size, and so we conclude that they are in reality rounded hills. They are great rounded swellings and some astronomers believe that they are craters which never formed, in other words, that the gases working their way up from the inside



of the Moon had not sufficient strength to burst open the crust and form craters, but merely caused the crust to swell up into blisters.

Very often these domes have a tiny crater on their tops, and several are cut right through by one of the clefts or cracks. One of these domes lies close to the 'railway' which is visible soon after first quarter, and this is cut through by a crack. A little to the east of Copernicus there is quite a cluster of domes which can be seen in a telescope of only 2-in. aperture, and many readers will have a telescope of that size. The largest of all the domes is within a very large crater called Darwin, close to the south-east edge of the Moon, and this dome is so big that it fills this part of the crater. A strange thing about these domes is that until quite recently very few were known, but within the last twenty years a large number has been discovered, which suggests that perhaps they are still being formed.

We left our explorers perched on the summit ridge of Copernicus and gazing down into the interior which was half filled with shadow. Even they would find it difficult to realize that the crater is 56 miles across, especially because, since there is no air on the Moon, objects far away would look as sharply defined as those close at hand—a very different thing from what we find on the Earth, where distant mountains look mere pale outlines because we are viewing them through a considerable thickness of atmosphere. On the Moon, however, where all atmosphere is lacking, everything is bright and sharp.

#### SCENERY AT THE SOUTH POLE OF THE MOON

Before returning to the Earth we simply must have a peep at the parts of the Moon near the south pole, at Clavius and the gigantic ranges on the edge. We indeed saw them from the Earth with our little telescope, but they would look very different to any one on the Moon itself. Let us therefore visit Clavius, which we already know is over 145 miles from one side to the other. A very tedious walk it would be, for to reach Clavius we have to make our way over a great mass of craters—nothing but craters—for in this part of the Moon there are no plains or indeed any level ground at all. One crater cuts into another—it is up and down all the time. At last we find ourselves on a gentle rise, and suddenly we are on the

edge of an enormous pit; a stupendous gulf has suddenly opened beneath our feet and we are looking down into Clavius. 'Looking down' is the proper term, for Clavius is a great pit, very deeply sunk indeed below the outside level. From where we stand on the western side we see the inside far below us, and from our position the ground slopes steeply downwards with great cracks and tumbled masses of rocks everywhere, down and still down, dropping over three miles until at last the floor is reached. And what a floor it is! A great plain so big that we cannot see the end of it; neither can we trace the wall all round. On the floor we see the smaller craters we noted through our telescope and many more besides—too small to be seen except with the very largest instruments. But the travellers would see them all quite close at hand. What a gulf of mystery, a gulf so big that Wales could easily be dropped into it. Surely no meteor could have made this vast pit; it must have been formed by the sinking of the crust of the Moon, and the tumbled rocks all around us are doubtless but the marks left as the floor fell and fell. We could spend days or even months exploring Clavius and still find marvels to astound us.

But the Sun is beginning to get low in the sky and the cold creeps through our space-suits, so we take a last look at Clavius before resuming our climbing over craters and still more craters ever southwards towards the pole.

As we approach the pole an enormous mountain range appears on the horizon. At first we see only the tops of mountains sticking up and gleaming white against the black sky, but as we still go along the mountains seem to rise higher and higher, until at last we find our way barred by them. Now they can be seen in all their majesty—and how majestic they look! Perhaps some readers have been to Switzerland and seen the Alps; or some may have been to India and seen the Himalayas, but the mountains we are now gazing at are far greater than any on the Earth. To begin with, they are much more rugged and barren. On the Earth even the finest mountains have had their sides smoothed by the winds or by streams or frost, but on the Moon there is none of these things, and so the mountains are jagged and rough beyond anything we know of on the Earth. Then again they are higher than the Earth mountains, whose heights are always reckoned from sea level. That great peak, for instance, which rears itself so

boldly into the sky, is at least a thousand feet higher than Mount Everest, while in the far distance is another spire which is at least two thousand feet more lofty. One thing which strikes us is the absence of any ice or snow on the peaks, a very different state of things from that on the earth where the tops of high mountains are all capped with an icy mantle. So lofty are these Moon mountains that their tops know no night; the sun always shines up there, and they may be called the 'Mountains of Eternal Light' rather than by their true name of the Leibnitz Mountains.<sup>1</sup>

But if the Sun never sets on the Leibnitz mountain peaks it does on their bases, and even as we look it sinks slowly below the horizon. Night is coming on, the long night of the Moon, as long as fourteen of our nights. But now the cold becomes unbearable, even though we have electrically heated suits, for during the night of the Moon the temperature falls very low; that of the centre of the dark side (the side away from the Sun) has been measured and found to be about  $-150^{\circ}$  C.! We could never stand it and so we must hurry to get into our space-ship and, when we have warmed ourselves up a little, we will take off for our home in space, the Earth.

We have a good view of the Moon as we slowly leave it, but we have not yet said what the Moon is. True it is a world—a strange world—very different from our own, but how was it formed and what is its importance in the universe?

#### ORIGIN OF THE MOON

Some astronomers think that the Moon is nothing more than a bit of the Earth which broke off thousands of millions of years ago, when the earth itself was a great molten ball. Others believe that the Moon never was a part of the Earth, but that it was a little planet which came so near to the Earth that our planet 'captured' it, and ever since has forced it to revolve around us. Nobody really knows. What we do know is that the Moon is a great ball, cold and solid, the faithful companion of the Earth, revolving around us once a month, and acting as a mirror to reflect to ourselves the Sun's light so as to brighten up our nights. We also know that it is the chief cause of the tides and that without the

<sup>1</sup> Perpetual light from the Sun on lunar mountains could occur only on those which are near either pole of the Moon.

Moon there would be only very small tides, so that ships would never come up the Thames without its influence in producing tides, this influence being more than twice that of the Sun.

We have just said that the Moon is a great ball, and so it is, for it is over 2,000 miles across, yet if we compare it with the Earth we cannot call it anything but small. The earth is nearly 8,000 miles across, so that it is very much larger than the Moon. It all depends what we compare the Moon with; compared with ourselves it is enormous; compared with the Earth it is small; compared with the Sun it is like a speck of dust placed beside a ping-pong ball.

#### OCCULTATIONS

The Moon is, as we know, a solid ball, and it is also nearest to the Earth of all the bodies in space. (Meteorites and meteors are exceptions.)<sup>1</sup> Now since it is a solid ball and travels around the Earth once a month, it follows that it must hide from our view any other object in the sky which happens to lie in its path. The Sun is very much farther from us than the Moon, but sometimes the Moon passes between us and the Sun and, of course, hides the Sun from our sight. We call this an eclipse of the Sun, that is to say, a hiding of the Sun by the Moon. In the same way the Moon passes in front of stars and, of course, hides them for the time being. When the Moon thus passes in front of a star we say that there is an *occultation*. Really it is an eclipse of the star by the Moon, but the word occultation is used because, whereas the Sun and the Moon look roughly the same size so that the Moon can hide the Sun for only a short time, a star looks so small in comparison with the Moon that it is swallowed up for quite a long period, often about an hour.

An occultation of a star is a very beautiful sight, and one easy to see even in a pair of binoculars. Especially beautiful is the occultation of a bright star by the crescent Moon, for then we can see not only the bright crescent but also the dark part faintly lit up by the Earth's light. Thus we can actually see the dark edge of the Moon getting nearer and nearer to the star, until at last the latter shines as a point of light actually on the edge of the Moon. We must keep a close watch, for suddenly, even as we look, the

<sup>1</sup> See pages 241 ff.

star disappears. One moment it is shining brightly, the next it has vanished as though it never existed. This sudden vanishing of a star is always striking, and is another proof, if we need any proof after our journey, that the Moon has no atmosphere. In a similar way, when the occultation is about to end, we must carefully watch at the other side of the Moon, for suddenly the star will shine out where a moment before there was nothing. Not only are these occultations beautiful sights, but it is possible to do work of real scientific value by carefully timing the disappearance or reappearance of the star, having set our watches by the radio time 'pips.' For if this is done we can fix the exact place of the Moon in the sky at those times, and this information is of value in improving our 'Tables of the Moon' as they are called. From these tables we predict eclipses, the tides, and other things, so anything which will improve them is of great importance.

It may be explained that in spite of calculations of the positions of the Moon, there are frequently small discrepancies between the predicted and observed positions. Careful observations of the times of occultations are of great assistance in correcting the tabulated positions of the Moon. Although such corrections are always very small—of the order of a second or two of arc, or less—they are important for various purposes.

Of course, not only stars are thus hidden by the Moon; sometimes a planet is occulted, and the occultation of a planet is even more interesting than that of a star. It is easy to see why this should be so, for even in the largest telescopes a star is only a point of light, but most planets viewed with only a moderate-sized telescope look like a small Moon, that is, they have a definite size. Jupiter and Mars, for instance, show broad faces in the telescope and we can see markings on them, while Saturn is seen surrounded by its marvellous rings, and Venus and Mercury appear as the Moon does, sometimes as a crescent, then half lit up, and finally as a full, round face. When a planet is occulted it obviously cannot vanish at once as a star does, because of its size. It is a very wonderful sight to see Saturn hidden by the Moon; first of all part of the rings is hidden; then Saturn itself begins to disappear, and takes several seconds as it glides behind the Moon. Saturn looks dull compared with the Moon, but Venus is so brilliant that in comparison with it the Moon seems like a badly tarnished mirror.

Any one wishing to observe occultations should look up beforehand the times which appear in the *Nautical Almanac* or in *The Handbook of the British Astronomical Association*.<sup>1</sup> These are given in Greenwich Mean Time, for various observatories and explanations are provided for computing the times at other places the latitudes and longitudes of which are known. As some readers may find these computations difficult they are recommended to start their observations some minutes before the predicted times, because otherwise they may miss the occultations. As the minutes pass the particular star under observation will be seen to get closer and closer to the Moon, although of course it is actually the motion of the Moon around the Earth which is bringing it nearer to the direction of the star. Then, having noted the time to the nearest minute, start counting the seconds and so determine the exact instant at which the star disappears. With practice it will be possible to estimate fractions of a second. From the times as observed, and knowing the longitude and latitude of the place, the mathematical astronomer will find the position of the Moon in the sky at the time. The difference between this and that supplied in the tables will at once give the error of these, and therefore how much alteration is required. Apart from the interesting spectacle, such observations—very simple to perform—will, as already stated, prove of definite scientific value, and may indeed earn the observer a niche in astronomical fame. But naturally everything depends upon the care taken to get the exact times when the star vanishes and reappears again, and a cheap stop-watch would enhance the accuracy of the timing.

#### HINTS ON OBSERVING THE MOON

It is hardly necessary to say that in order to observe the Moon or any other object in the heavens we should go outside. If we have no garden and are compelled to take our peeps from a room, we must of course select one that faces the south, for that is the direction in which the Sun, Moon, and planets are best seen in the northern hemisphere. It will be necessary to open the window; many people try to have a look at the Moon without doing this and then wonder why the view is bad and distorted. The window

<sup>1</sup> See page 474.



glass, being an imperfect sheet, will spoil the picture given by the best telescope. Even binoculars perform very much better if used out of doors. Still, if we have to use a room, open the window and have no fire in the room, otherwise the heated air will cause everything to jump about or 'boil,' as observers say. But in the open air, resting the telescope on some support so as to steady it, all the wonderful features we have described in this chapter will be clearly seen.

From what we have said every one will agree that the Moon is by far the best and the most interesting of all objects in the sky. When we look at it with the naked eye we see the dark markings which we now know to be great plains, and with the simplest of instruments we can make a delightful journey to this shining world. We find it covered with strange things of all sizes, shapes, and brightness; we see mountains rising from the surface, and casting long black shadows behind them; great cracks, mighty valleys, and long mysterious rays are all plainly revealed and, best of all, the scene changes night after night, presenting a spectacle full of charm and always new. Every one can see these things for himself, for every one can have some sort of optical aid, even if it is only a pair of binoculars.

#### CONSTRUCTION OF A SIMPLE TELESCOPE

If any reader happens to be one of those unfortunate mortals who possesses no instrument and cannot afford to buy one, he may still see these wonders, for it is easy to make a telescope of sufficient power. All that is wanted will be a cardboard tube and a spectacle lens with as long a focus as possible. Mounting this at one end of the tube and having a smaller tube sliding within at the other end, with a simple lens of short focus, known as the eyepiece, we have a telescope quite capable of revealing most of the features described. If the eyepiece is convex the instrument is an astronomical telescope, and if concave it is a terrestrial telescope.<sup>1</sup> Such a telescope may be constructed for a few shillings, for the lenses can be picked up anywhere, and the only thing required is a little patience and common sense in fitting the tubes together.

Such then is the Moon, our Moon, the faithful companion of the Earth, and in leaving it we hope that many a reader will spend the

<sup>1</sup> See footnote, page 75.

short time necessary to become acquainted with the principal features, and then, taking his instrument, spend many and even more delightful hours in viewing the Moon itself.

*Note.* As many maps of the Moon give only the Latin names of its seas, the following list of seas with their Latin equivalents may be useful to readers.

English	Latin
Sea of Cold	<i>Mare Frigoris</i>
.. .. Rains	.. <i>Imbrium</i>
.. .. Serenity	.. <i>Serenitatis</i>
.. .. Conflicts	.. <i>Crisium</i>
.. .. Peace	.. <i>Tranquillitatis</i>
.. .. Fertility	.. <i>Fœcunditatis</i>
.. .. Nectar	.. <i>Nectaris</i>
.. .. Clouds	.. <i>Nubium</i>
.. .. Vapours	.. <i>Vaporum</i>
.. .. Humors	.. <i>Humorum</i>
Smyth's Sea	.. <i>Smythii</i>
Southern Sea	.. <i>Australe</i>
Lake of Death	<i>Lacus Mortis</i>
.. .. Dreams	.. <i>Somniorum</i>
Marsh of Sleep	<i>Palus Somnii</i>
Ocean of Storms	<i>Oceanus Procellarum</i>
Bay of Rainbows	<i>Sinus Iridum</i>

*Note on the light of the Moon.* Some readers might gain the impression from reading page 76 that the crescent or half-moon gives more light in proportion than full moon, but the opposite to this takes place. At first quarter, when half of the visible hemisphere is turned towards the Sun, the brightness then is only about 12 per cent that of full moon, and a little less—about 10 per cent—at the last quarter. The reduction of 2 per cent at the last quarter is due to the visible sunlight area including the dark seas at that time.

#### BIBLIOGRAPHY

- E. Neison: *The Moon*, Longmans, 1876.  
 T. G. Elger: *The Moon*, George Philip & Son Ltd., 1895.  
 (Both of these are out of print but are obtainable in astronomical libraries.)  
 W. H. Pickering: *Lunar Photographic Atlas*, *Harvard Annals*, vol. li, 1903.  
 W. Goodacre: *The Moon*, published by the author 1931.  
 J. E. Spurr: *Features of the Moon*, Science Press Printing Co., Lancaster, Pennsylvania, U.S.A., 1944.  
 R. B. Baldwin: *Face of the Moon*, University of Chicago Press, 1948.
- Amongst maps of the Moon may be noticed the following:  
 T. G. Elger: *Map of the Moon*, new edition, 1951, edited by H. P. Wilkins (George Philip & Son Ltd.); 18-inch diameter.  
 H. P. Wilkins: *Map of the Moon*, third edition, 1951; 100-inch diameter in 25 sections. (Published by the author.)

CHAPTER IV  
THE PLANETS (I)

MERCURY AND VENUS

M. B. B. HEATH, F.R.A.S.

Director of Saturn Section, British Astronomical Association

MERCURY

*Visibility.* Mercury, the planet nearest to the Sun, is usually lost to the naked eye in blazing sunlight and there is even a gap in telescopic observation around the time of inferior conjunction. In Great Britain during the most favourable apparitions the planet can never set more than a little over two hours after the Sun or rise more than about two hours before it. Mercury is only seen with the unaided eye when it is rather near the horizon in the evening or morning twilight. In the former it may become visible about three-quarters of an hour after sunset, in the latter it fades out about three-quarters of an hour before sunrise. Thus seen it usually resembles a rosy twinkling star, particularly if viewed with field-glasses, but both colour and scintillation are due to low altitude. Seen in a powerful telescope in full daylight and high in the sky, the planet is a dull livid white colour with only a slight yellowish tinge.

Those who wish to see this elusive orb without instruments should look for it a little before those elongations which happen in the spring when the planet is an evening star, or a little after those elongations in the autumn when the planet is a morning star. When about four-fifths illuminated and in the most favourable circumstances, such as occurred in 1950 and will recur in 1957 and 1963, Mercury can appear as an evening star only about half a

stellar magnitude<sup>1</sup> inferior to Sirius, and as bright as Canopus (a far southern star not visible in England) when a morning star. Telescopically it may appear about a third of a magnitude brighter than Sirius in special circumstances. Identification of the planet

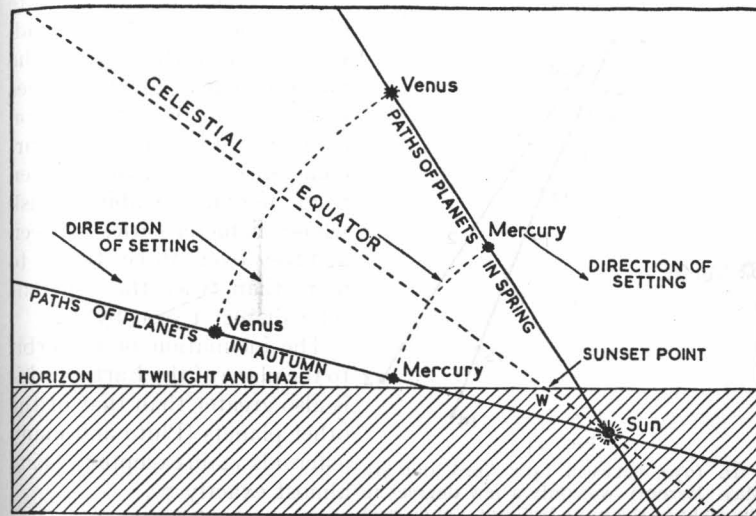

FIG. 23  
COMPARATIVE VISIBILITY OF THE INNER PLANETS AS  
EVENING STARS

Their path is roughly in the ecliptic, which makes a much steeper angle with the horizon in spring than in autumn evenings. Consequently they are much better seen as evening stars in spring and conversely, for the same reason, as morning stars in autumn.

(From *Splendour of the Heavens*, Hutchinson)

is sometimes assisted by the proximity of the much more brilliant Venus or of the crescent Moon, particulars of which may be found from a current astronomical almanac.

*Orbit, temperature, speed.* Mercury's orbit has a greater eccentricity<sup>2</sup> than that of any other planet in the solar system, Pluto and many of the asteroids alone excepted. Thus its distance from the Sun varies from about  $28\frac{1}{2}$  million miles at perihelion (its nearest

<sup>1</sup> See pages 287-8.

<sup>2</sup> See page 123.

distance from the Sun) to about  $43\frac{1}{2}$  million miles at aphelion (its greatest distance from the Sun). In the former position its sunward surface is scorched by a heat more than ten times as great as that received by the Earth on the same area, and the temperature under a vertical Sun is quite high enough to melt lead. Even at its farthest from the Sun the heat is about  $4\frac{1}{2}$  times that received by our world on an equal area. In these circumstances the Sun as seen from Mercury exhibits a disk whose diameter varies between a little over three times to more than twice the apparent solar diameter seen by us.

☉ Venus

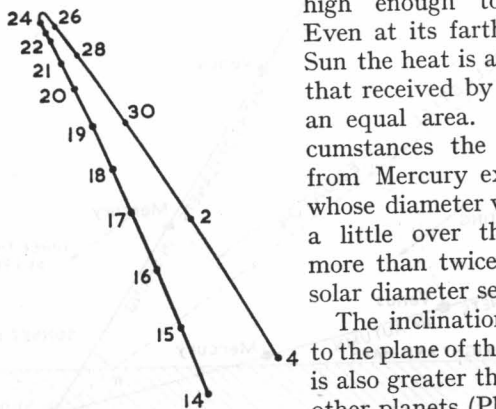

FIG. 24

In 1930, between 14th April and 4th May, Mercury was only a few degrees to the right of the more brilliant Venus, and was so seen on several evenings when the sky was clear.

(From a drawing by M. B. B. Heath)

but owing to the eccentricity of the orbit its speed varies within considerable limits, namely from about 35 miles per second when nearest the Sun to about 23 miles per second when farthest from it.

*Period of revolution.* Mercury makes a complete revolution round the Sun in just under 88 days, but in consequence of the Earth's motion in its own orbit the mean synodic period, or interval from one inferior conjunction to the next, is about 116 days, subject to a considerable variation either way. Thus generally there are in each year either four appearances as a morning star and three as an evening star or vice versa, and the planet returns to the same phase on an average about 17 days earlier than in the previous year.

The inclination of the orbit to the plane of the Earth's orbit is also greater than that of the other planets (Pluto and many asteroids again excepted), being almost exactly  $7^\circ$ .

As might be expected from its nearness to the Sun, Mercury travels around it faster than any of the other planets,

*Distance from Earth, size.* The distance of Mercury from us also varies very considerably. At the nearest inferior conjunction it is about 50 million miles away, but at the farthest superior conjunction the distance increases to about 136 million miles. The apparent diameters range from  $12''.7$  to  $4''.7$  from which we conclude that the real diameter of the planet is about 3,100 miles.<sup>1</sup>

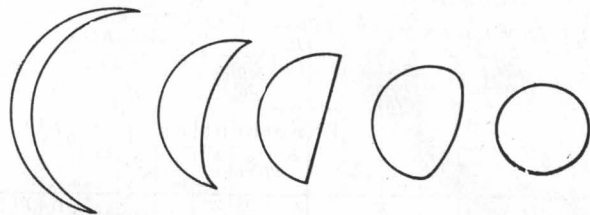

FIG. 25

#### COMPARATIVE SIZES OF MERCURY AT DIFFERENT PHASES

The planet when full is farther away from the Earth than when it is a crescent, so its disk appears smaller. It has not been observed at inferior conjunction (other than in transit), but in favourable circumstances can be seen when the phase is less than  $0.1$ .

(From a drawing by M. B. B. Heath)

*Mass, gravity, density.* It is very difficult to determine the mass of Mercury, due to the fact that it has no satellite, and moreover is so small and so near the powerfully attracting Sun that its perturbative effects on the other planets are but little. Newcomb estimated that the amount of matter in the Sun is about  $7\frac{1}{2}$  million times that in Mercury, which makes the planet's mass only about  $\frac{1}{22}$  that of the Earth and the force of gravity on the surface of the planet about  $0.29$  that on the Earth's surface. Thus a body which weighs 1 pound here would weigh only about  $4\frac{1}{2}$  ounces on Mercury. The density of Mercury, based on the above data, is about four times that of water, so we may reasonably suppose that the planet is composed of rocks not very unlike those of the Earth.

*Phases.* Revolving in an orbit within that of the Earth, Mercury must exhibit phases. These can be observed telescopically, particularly when the planet is at about half-phase or is a crescent, but not even then so easily as can those of Venus. The planet is not always equally brilliant even at the same phases. At its greatest elongation it may be as bright as  $-0.24$  or as faint as  $+0.57$

<sup>1</sup> See page 303.



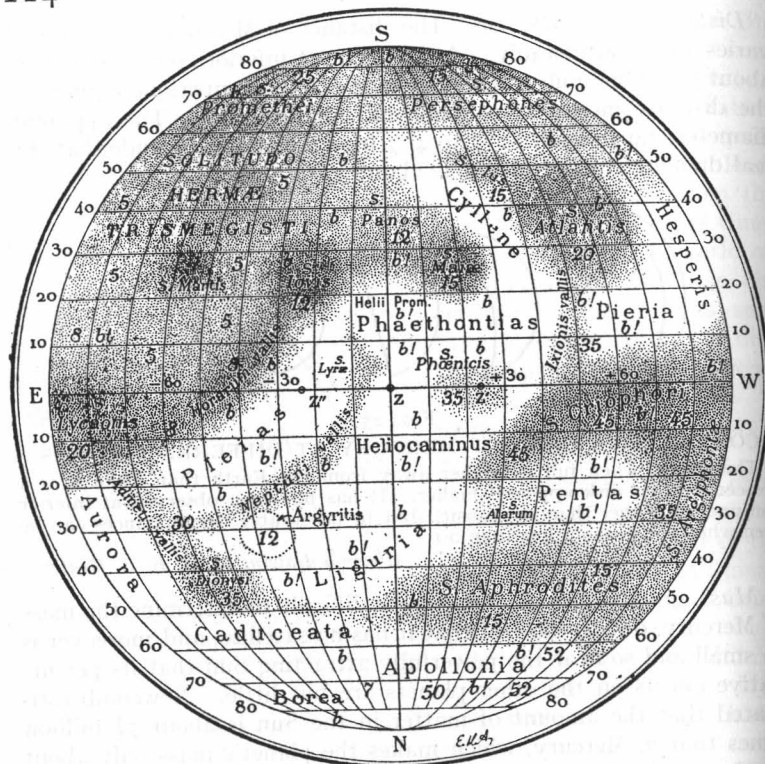

FIG. 26

## CHART OF MERCURY

By E. M. Antoniadi, from his own observations with the Meudon 33-inch refractor. Owing to libration, the point which is vertically below the Sun swings backwards and forwards along the line  $Z''Z'$ . Areas occasionally seen whitish or white on the limb are indicated by *b*, those brilliant on the limb by *b!*

(From *B.A.A. Journal*, 45, 6)

magnitude. The apparent distance of Mercury from the Sun at a greatest elongation may vary from a little less than  $18^\circ$  to nearly  $28^\circ$ .

*Markings, rotation.* In 1889 Schiaparelli discovered markings on the disk, and these did not move for several hours. They have been confirmed and added to by others, notably Antoniadi, and the general opinion now is that Mercury revolves on its axis once in

eighty-eight days and so always presents more or less the same face to the Sun. In these circumstances the sunward side must be very hot and the opposite side intensely cold. Owing to libration,<sup>1</sup> however, these extremes are parted by a belt in which the Sun rises above the horizon and drops back again, and here there must be great variations of temperature. In large instruments the markings have been seen to approach and recede from the terminator by amounts corresponding to this libration. Sometimes even in good seeing conditions the disk is practically featureless, the markings being replaced by pale livid patches which Antoniadi suggested may be clouds composed of very fine dust floating in a tenuous atmosphere. A bright area is often seen at or near the north cusp, and occasionally on the limb as well. The south cusp is often slightly shaded, and this is probably the cause of its apparent blunting near half phase, as reported by Schröter and many others.

*Surface.* The albedo or reflecting power of the surface of Mercury is very small, slightly less even than that of the Moon. Approximately only about 7 per cent of the light falling upon it is reflected back into space. The rate at which the brightness varies with the phase tends to show that the surface is probably very rugged as suggested by Zöllner. In 1893 Müller pointed out that the light curves of Mercury and the Moon agreed in an astonishing manner, and Lyot, by means of a greatly improved polarimeter which he had himself designed, found that the polarization curve also resembled, and was very close to, that of the Moon, and concluded that the surface may be covered with volcanic ash.

*Atmosphere.* In consequence of the low velocity of escape at the planet's surface Mercury must long since have lost all the lighter gases, but a very thin atmosphere of the heavier gases may still be retained. Definite proof of such an atmosphere has recently been obtained by A. Dollfus, using the 60-cm. telescope at the Pic du Midi, as well as indications that the surface may well be similar to that of our Moon. The atmosphere, however, is far too rarefied to be seen as a ring of light around the planet near transit, as with Venus, and may exert a pressure as low as 1 mm. of mercury. Even when Lyot photographed the planet as a dark spot projected on the inner corona of the Sun, 1937 May 11, no such light-ring was recorded.

<sup>1</sup> See page 98.

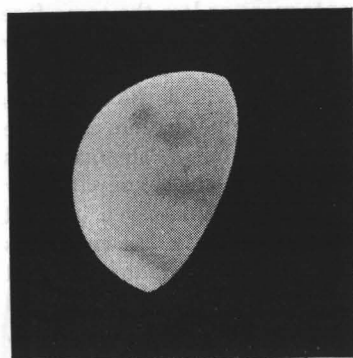

1946 June 20

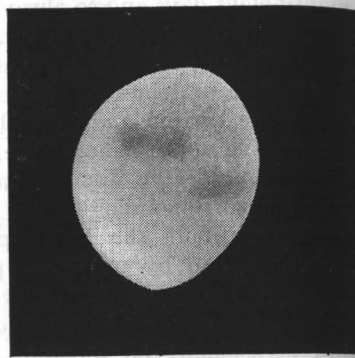

1949 April 25

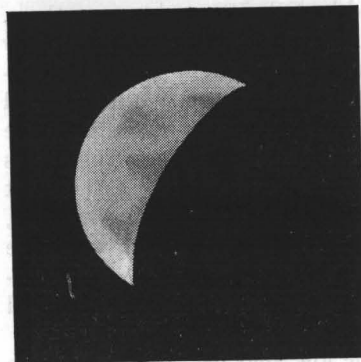

1949 May 8

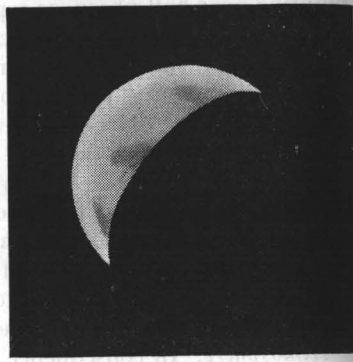

1951 April 9

FIG. 27

## OBSERVATIONS OF MERCURY

Made with  $9\frac{1}{4}$ - and  $10\frac{1}{4}$ -inch reflectors by M. B. B. Heath. To reproduce these drawings it has been necessary to exaggerate the dusky markings considerably.

(From drawings by M. B. B. Heath)

*Transits.* Occasionally when Mercury is at inferior conjunction it is seen with the telescope as a small, round black disk traversing the Sun's bright face, but the planet can only so transit when it is also at or near a node, that is, within a few days of 7th May or of 9th November. Gassendi was the first ever to observe a transit of Mercury on November 7, 1631. The next transits will be on

1953 November 14 and 1957 May 5. These transits are not only interesting spectacles—accurate observations and measurements of them are utilized to correct still further the planet's place and its basic orbital elements.

## VENUS

*Apparent movements.* Unlike Mercury the planet Venus is anything but a shy or elusive object. Even the most unastronomically minded must at some time have asked the name of that brilliant white 'star' which becomes visible soon after sunset long before any of the stars can be seen. In these circumstances Venus has emerged from the Sun's overpowering rays where it has been at superior conjunction on the far side of the Sun. Evening by evening the apparent distance or elongation from the Sun increases, and the planet sets later and later until it reaches its greatest elongation east of the Sun. Thereafter it appears to approach the Sun, slowly at first but ever more rapidly, so that in a few weeks it is too near it to be seen with the unaided eye. Passing through inferior conjunction, more or less between us and the Sun, it next reappears after a few weeks in the morning sky before sunrise. It then moves outward from the Sun, rising earlier on each successive morning, until it attains its greatest elongation west of the Sun. Thereafter it again appears to approach the Sun until it is at superior conjunction once more and the cycle starts all over again.

As we might expect, such a conspicuous object has been known from the very earliest times and has been mentioned by ancient and modern writers alike. It is the only planet mentioned by Homer in his *Iliad* and he describes it as the most beautiful star in the firmament, calling it Hesperos when an evening star and Eosphoros when a morning star. Among the more modern poets Blackmore, Dryden, Longfellow, Milton, Pope, Spenser, and Tennyson extol the beauty of the planet or refer to it as the harbinger of eventide or dawn.

*Orbital and synodic periods.* Venus revolves around the Sun in an orbit well outside that of Mercury but within that of the Earth. Its mean distance from the Sun is a little over 67 million miles, but the orbit is so very nearly circular that this distance does not vary by as much as a million miles. In consequence its orbital speed

varies but little from an average of about 22 miles per second, and the heat and light received from the Sun remain nearly constant at about twice that received by our world on an equal area. Seen from the Earth the greatest apparent distance or elongation of Venus from the Sun can vary only between about  $45^\circ$  and  $47^\circ$ . The revolution around the Sun is performed in a little under 225 days, but the mean synodic period (the interval from one inferior conjunction to the next) is about 584 days, subject to a variation of about 4 days either way.

Now it happens that 13 revolutions of Venus are nearly equal to 8 terrestrial years, consequently all the phases, elongations, and conjunctions in any 8-year period are repeated in the next, but about 2 or 3 days earlier. Moreover 5 synodic periods are also nearly equal to 8 of our years, whence it is easy to see that inferior conjunction can only happen around about one of five different dates. At the present time (1951) it must occur either about the end of January, mid April, third week in June, beginning of September, or mid November. Inferior conjunctions in February, March, May, July, October, and December cannot now take place though they have done so in the past and will again do so in the future.

*Favourable appearances.* Obviously all these apparitions will not be equally favourable at any particular place. At the present time, in middle northern latitudes the most favourable and prolonged appearances of Venus, both as an evening and morning star, occur in those years when inferior conjunction takes place in June or September, such as will happen in 1956 and 1959 respectively. In 1953 Venus will also be moderately well placed for observation as an evening star at the beginning, and a morning star at the end of the year, but in 1957 and 1958 it will be badly placed for northern observers.

*Inclination.* The orbit of Venus is tilted nearly  $3\frac{1}{2}^\circ$  to the plane of the Earth's orbit. This is more than that of any of the planets except Mercury and Pluto (minor planets are not included).

*Distance from Earth, size, mass, density.* The planet's distance from the Earth varies enormously, giving a corresponding change in the apparent size of the telescopic disk. At superior conjunction Venus is about 160 million miles away, but at inferior conjunction its distance is only 26 million miles. Only the Moon, a few comets,

and some of the small asteroids approach the Earth more closely. The apparent angular diameter changes from about  $10''$  to  $64''$ , and from these measures we deduce that the diameter of Venus is about 7,700 miles, or only some 220 miles less than the Earth's. The mass of the planet has been derived from its perturbations of the Earth and Mars. In this way the Sun's mass is found to be about 418,000 times that of Venus, so Venus has a mass about 0.82, density about 0.89, and surface gravity about 0.86, of those of the Earth. Thus in all these respects, as well as in size, Venus so closely resembles the Earth that it has been called its twin sister.

*Visibility.* Whenever visible to the naked eye the planet is always a very brilliant star-like object. Its stellar magnitude attains a maximum of  $-4.4$  and it is over two and a half times brighter at greatest brilliancy than at superior conjunction. Maximum brightness always occurs when the planet is between 0.25 and 0.28 illuminated, and it then appears in the telescope as a lovely crescent resembling the waxing Moon at about five days old or the waning Moon about twenty-four days old. Around about these times Venus can be seen with the unaided eye in full daylight provided one knows exactly where to look, while on a dark sky it shines so brightly as to cast a distinct shadow on any white surface.

*Phases.* The phases of Venus are easily seen in small telescopes and were first announced by Galileo, who succeeded in seeing them in the crescent and slightly gibbous aspects. A good instrument will render the planet visible all around its orbit—as a round disk at superior conjunction, and also (unlike Mercury) when the crescent has become a mere hair-like line of light. In the crescent phases many telescopic observers in full daylight have described the space inside the crescent as being slightly darker than the outside sky, often in seeing conditions when it was difficult to accept this as an illusion or contrast effect. On a darkening sky the unilluminated portion of the planet has appeared to some observers faintly lit by a greyish, reddish, or brownish glow not unlike the 'earthshine' seen on the crescent Moon. The phenomenon is known as the 'ashy light,' but it has been suggested that the appearance is wholly illusory.

*Surface.* From the variation of brightness with the phase we conclude that the reflecting surface of Venus is much smoother than



that of either the Moon or Mercury. The albedo of the planet is about  $\frac{6}{10}$ , which is near what would be the case if the planet were cloud-covered or if its atmosphere were charged with fine dust. When Venus and Mercury are seen in the same telescopic field, as by Nasmyth on September 28, 1878, comparisons of their surface brightnesses are easily made. On that occasion Venus looked like

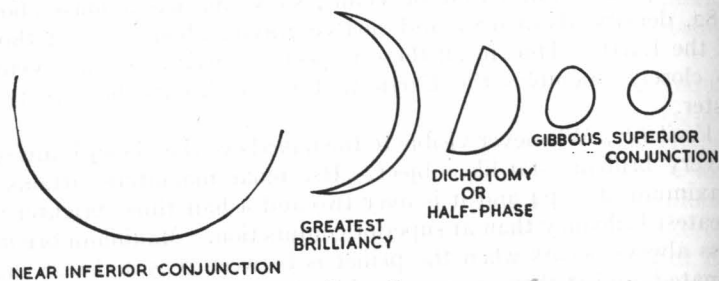

FIG. 28

#### COMPARATIVE SIZES OF VENUS AT DIFFERENT PHASES

The planet is roughly six times as far away from the Earth when full as it is when at inferior conjunction. Thus it appears six times as large in the latter position as it does in the former. Unlike Mercury, Venus can be seen when the phase is as little as 0.001.

(From a drawing by M. B. B. Heath)

clean silver, Mercury more like lead or zinc. Yet the positions of Mercury, Venus, and the Earth in their orbits were such that if Mercury had the same reflecting power as Venus its surface would have appeared five and a half times as bright as that of the latter.

*Markings.* Such markings as can be seen are very faint, diffuse, and ill-defined. They are more conspicuous when photographed in ultra-violet light and appear to be of atmospheric origin. We probably never see the solid surface of the planet. Brightish areas sometimes appear at the cusps and there is usually some faint shading on the terminator, particularly at about half-phase.

*Rotation, temperature.* We do not know how long it takes the planet to turn round on its axis. Various periods, varying from a little less than 24 hours to 225 days, have been proposed. J. D. Cassini in 1667 thought he had found a period of 23 hours 16 minutes; Schröter and De Vico much later deduced one about 5 minutes longer. Bianchini observed spots in 1726-7 and inferred a rotation in 24 days 8 hours. The short periods are now inadmissible, since

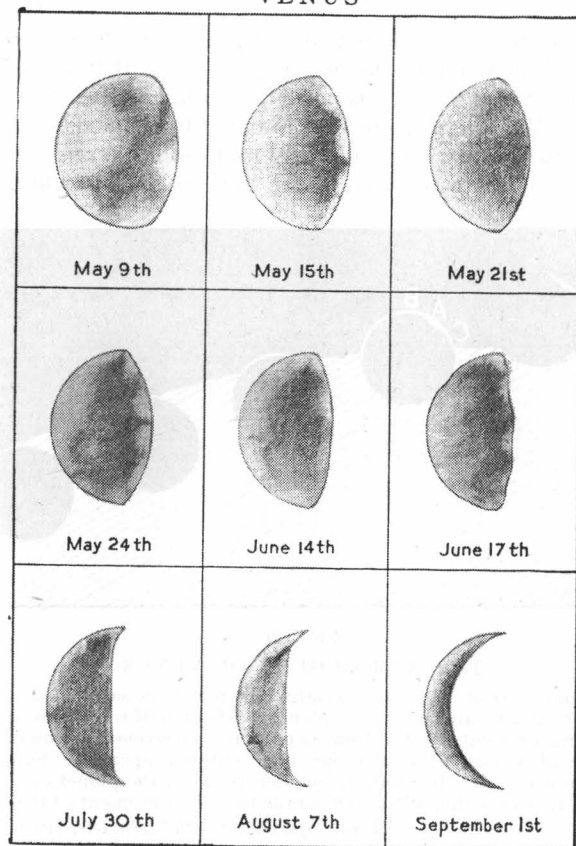

FIG. 29

#### ATMOSPHERIC EFFECTS ON VENUS

Patches, slightly brighter than the general background of the planet, are occasionally observed both at the cusps and on the terminator. In order to reproduce these drawings it has been necessary to exaggerate the dusky areas a great deal.

(From *The Heavens and their Story*, by A. and W. Maunder, by permission of the Epworth Press)

if they were correct the spectroscope<sup>1</sup> would have disclosed the radial velocity of points on opposite sides of the disk if the period was anything much under 20 days, though one of 35 to 40 days

<sup>1</sup> See pages 16-17.

would probably escape detection. Observations made at Lowell and Mount Wilson Observatories support each other by indicating that the velocity of rotation is not large enough to measure spectroscopically. Measurements of heat radiated from the dark side show it to be both considerable and fairly uniform so Venus can hardly always present the same face to the Sun, as Schiaparelli thought.

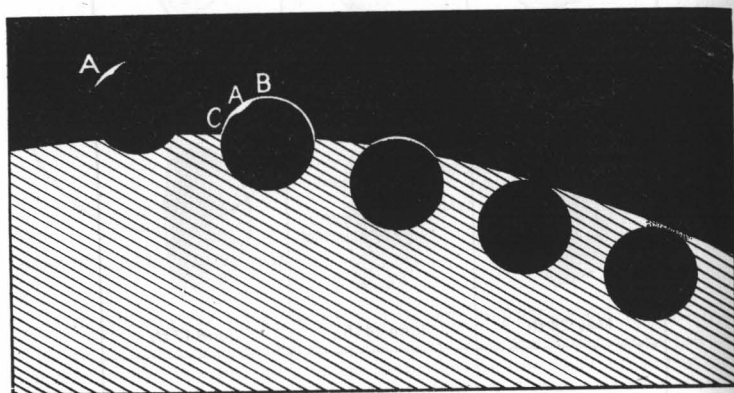

FIG. 30  
THE ATMOSPHERE OF VENUS

When Venus transits the Sun a bright spot A is first seen. This gradually extends to B and C, and when the planet is about half immersed appears as a bright semi-ring outside the Sun, caused by refraction of sunlight by the atmosphere of Venus. When about fully entered upon the Sun, a dark shading (known as the 'black-drop') is seen between the planet and the solar limb, hence it is very difficult to determine the exact moment of true contact.

(From *Splendour of the Heavens*, Hutchinson)

According to Wildt the temperature on the day side of the planet under a vertical Sun is probably as high as that of boiling water.

*Atmosphere.* There is no doubt that Venus has a considerable gaseous envelope. When it is near inferior conjunction the cusps have faint extensions, which may even form a complete ring of light around the dark disk, due to diffuse reflection by an atmosphere. Moreover when projected on the Sun's limb at the time of transit a much brighter ring, due to refraction, surrounds the dark disk. Absorption bands in the spectrum of the light received from Venus show that the heavy gas carbon dioxide is certainly a constituent

of its atmosphere, being in quantity possibly 200 times as great as in our own, but the exact amount is uncertain.

*Transits.* When Venus is both at inferior conjunction and at or near a node it appears as a round black spot moving across the bright solar disk. This can only occur around about 7th June or 8th December. The first transit to be observed was seen only by Horrocks (who had computed its occurrence) and by his friend Crabtree, December 4, 1639. It was followed by four transits, June 6, 1761, June 3, 1769, December 9, 1874, and December 6, 1882, observations of which were used to determine the Sun's distance from the Earth. It will be noticed that the transits occur in pairs. The next pair will be 2004 June 8 and 2012 June 6. In Great Britain the former will be completely visible, first external contact being well after sunrise, at the latter only the egress is visible. They will not be used to determine the astronomical unit, the method having been superseded by a more accurate one based on the parallax of the minor planet Eros.<sup>1</sup>

*Note on the eccentricity of an orbit.* In Fig. 89, page 221, if C is the centre of the line AP, which passes through S, the Sun, and CA or CP is denoted by a, the eccentricity e of the ellipse is SC/a. CA or CP is the semi-major axis of the ellipse and is also the mean distance of the comet from the Sun. The same applies to the orbits of the planets and minor planets, but in the former S is much closer to C, the centre of the ellipse, than in the case of the comets, and hence e is smaller in the former.

<sup>1</sup> See page 5

## THE PLANETS (2)

MARS, JUPITER, SATURN, URANUS,  
NEPTUNE, AND PLUTO

A. F. O'D. ALEXANDER, M.A., Ph.D., F.R.A.S.

Director of the Jupiter Section, British Astronomical Association

## MARS

*The Earth-like planet.* 'Almost as soon as magnification gives Mars a disk,' wrote Dr. Percival Lowell, 'that disk shows markings, white spots crowning a globe spread with blue-green patches on an orange ground.' Telescopes show the actual surface of this beautiful little neighbouring world, and of all planets Mars most resembles the Earth. But there are important differences also, apparent in the following summary<sup>1</sup> of characteristics of Mars:

(1) Polar snow-caps each shrinking in its summer, spreading in winter. (2) A reddish belt encircling Mars's globe in the northern tropics: probably a counterpart to the terrestrial desert belt from Sahara to Gobi. (3) Dusky greenish and brownish surface areas, permanent in general size and shape but undergoing seasonal and irregular changes of visibility, colour, and outline, suggesting vegetation. (4) Few high mountains. (5) No seas or even lakes. (6) A considerable atmosphere containing carbon dioxide, no ammonia, no methane, but only about  $\frac{1}{40}$  of the water vapour and not exceeding  $\frac{1}{1000}$  of the oxygen in the Earth's atmosphere. (7) Extensive yellow veils (probably dust or sand clouds) and smaller occasional moving white patches (possibly moist clouds); rain (if any) limited to insignificant showers. (8) Light winds,

<sup>1</sup> Atmospheric and physical details on pages 137-47.

deduced by E. M. Antoniadi from movements of presumed clouds, with estimated speeds up to 25 miles per hour. (9) Appearances like mist and hoar-frost. (10) Reasonable midday temperatures in the tropics but severe night and winter cold. (11) Similar rotation period (or day): 24 hours 37 minutes  $22\frac{2}{3}$  seconds. (12) Longer year: 687 terrestrial or 670 Martian days. (13) Similar tilt of axis: inclination of equator to orbit-plane about  $24^\circ$  (Mars),  $23\frac{1}{2}^\circ$  (Earth), so Martian seasons are analogous, but longer. (14) Equatorial diameter 4,216 miles, twice the Moon's, rather over half the Earth's; volume  $\frac{3}{20}$  of the Earth's; surface area equalling Europe and Asia. (15) Mass only  $\frac{1}{10}$  the Earth's mass; surface gravity only 0.38 of the Earth's, so a man weighing 10 stone would weigh under 4 stone on Mars. (16) Mean density  $\frac{7}{10}$  of the Earth's or nearly four times that of water, greater than that of any other planet but Venus. (17) Atmospheric density perhaps  $\frac{1}{2}$  of that at the top of Everest; pressure at the surface only about 8 per cent of the Earth's, probably suitable only for creatures with body temperature under  $60^\circ$  F.

*Orbit, distances, oppositions.* Mars's orbit, inclined only  $1.9^\circ$  to the Earth's orbit-plane, is more elliptical than that of any major planet except Pluto's and Mercury's. Only 129 million miles from the Sun at perihelion, Mars is 154 million miles away at aphelion, the mean being  $141\frac{1}{2}$  million miles, about  $1\frac{1}{2}$  times the Earth's mean solar distance. Mars is (from the Sun) the next planet beyond the Earth, and periodically comes nearer the Earth than any other celestial body save the Moon, some asteroids, occasional comets, and Venus. But the variation in the Earth-Mars distance is enhanced by the eccentricity of Mars's orbit and by the ellipticities of the two orbits being in different directions. The Earth is *farthest* (about 95 million miles) from the Sun in early July; Mars's solar distance is *least* with Mars in the direction from the Sun in which the Earth lies on 23rd August.

Mars's mean orbital speed is 15 miles per second, but appreciably faster around perihelion, slower around aphelion. The Earth, moving on the average  $3\frac{1}{2}$  miles per second faster on a much smaller orbit, catches up with and passes Mars, causing an opposition about every 780 days. If the Earth passes approximately between Mars and the Sun about 23rd August, the Earth-Mars distance is the minimum, 35 million miles (129-94). This happened on August 23 1924, the closest opposition since Mars began to be systematically



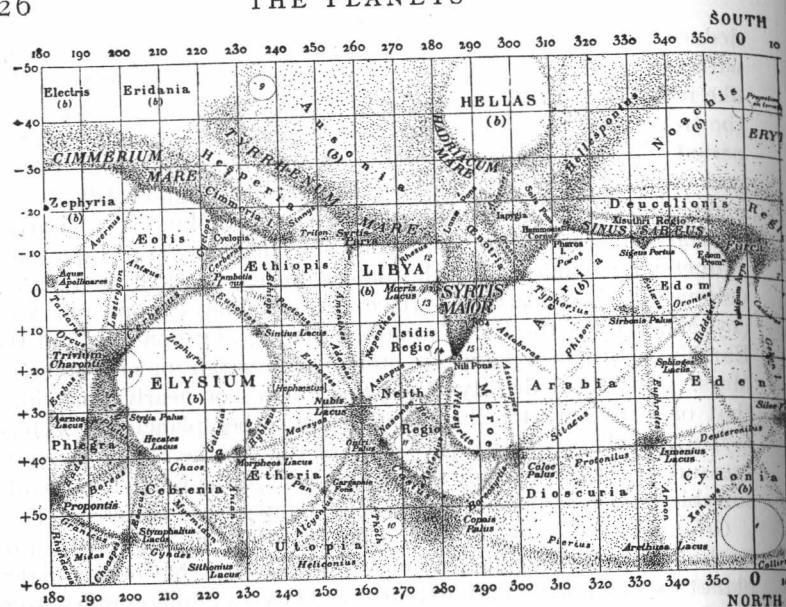

FIG.

## CHART OF MARS ON

Prepared from the observations of the British

observed. If the Earth passes Mars about 22nd February (where the separation between their paths is widest), the Earth-Mars distance is 63 million miles (154—91), the most distant opposition possible. When the Earth and Mars are on opposite sides of the Sun their separation can be as great as 248 million miles. The variation of Mars's orbital speed causes successive winter oppositions to occur at shorter intervals than summer ones, so in every fifteen years there are two close summer (perihelic) oppositions and five distant ones, as the following list shows:

Opposition	Earth-Mars (miles)	Opposition	Earth-Mars (miles)
1939 July 23	36,171,000	1950 March 24	60,700,000
1941 October 10	38,508,000	1952 May 1	52,400,000
1943 December 5	50,599,000	1954 June 24	40,300,000
1946 January 14	59,800,000	1956 September 10	35,400,000
1948 February 18	63,000,000		

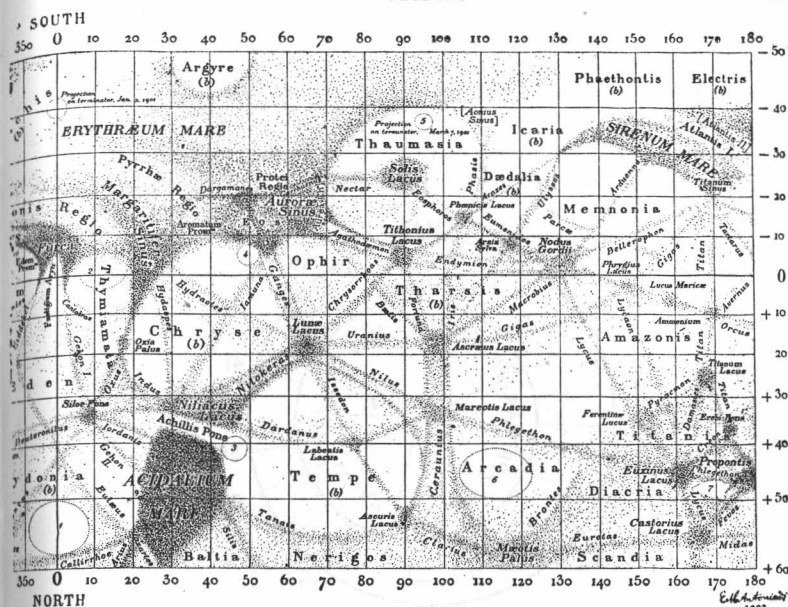

31

## MERCATOR'S PROJECTION

Astronomical Association's Mars Section, 1900-1.

(British Astronomical Association: 5th Mars Report)

*Martian seasons.* Mars's axis, though not vertical to its orbit-plane, has a fixed direction in space, so its tilt from the view-point of Sun and Earth continually varies. At perihelion Mars's south pole tilts towards the Sun, as does the Earth's at its perihelion. Consequently Mars's southern hemisphere is in full view at perihelic oppositions (e.g. 1939, 1941), its northern hemisphere at aphelic ones (e.g. 1946, 1948). Mars is too distant for satisfactory (telescopic) observation except during the few months around oppositions every alternate year. The season is always late spring, summer, or early autumn in the Martian hemisphere tilted earthward at opposition. Neither hemisphere is ever so well seen in its winter. The lengths of the Martian seasons (in terrestrial days) are: southern spring (northern autumn) 146; southern summer (northern winter) 160; southern autumn (northern spring) 199;

southern winter (northern summer) 182. Mars's southern hemisphere has therefore a shorter warmer summer but a longer colder winter than the northern. Hence the south polar cap melts more rapidly and completely than the northern, sometimes entirely disappearing in its late summer, yet in winter can extend to a latitude circle of  $60^\circ$  diameter, the northern cap only to one of  $50^\circ$ .

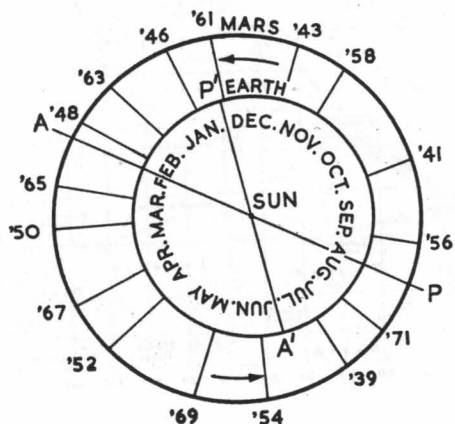

FIG. 32

## OPPOSITIONS OF MARS, 1939-71

Earth-Mars separation at each opposition shown by straight line joining orbits. Perihelion of Mars, P; of Earth, P'. Earth months shown.

*Visibility.* Perihelic oppositions should be very favourable for observation because Mars, then at 150 times the Moon's distance, is near enough to subtend an angle up to 25 seconds. Magnified 72 diameters the disk appears through a telescope as large as the full Moon to the naked eye. A magnification of 144 gives the disk the (naked eye) width of a forefinger or waistcoat button held at arm's length, and some prominent markings are visible in a 3-inch aperture telescope. But at June and July oppositions Mars's nearness is outweighed for observers as far north as England by the planet's low altitude and unsteady image through the turbulent horizon atmosphere. At aphelic oppositions (January-March) Mars is much higher in the English sky and its *northern* hemisphere well placed for observation, but the apparent diameter, at most 15 seconds

of arc, requires a magnification of 240 to reach 'waistcoat button' size and apertures below 5 inches are ineffectual.

Fine detail requires large apertures ( $1\frac{1}{2}$  to 3 feet); even they show less on Mars than strong binoculars do on the Moon. Good detailed images of Mars are seen most frequently at observatories on isolated mountains in dry regions of fairly low latitude (Flagstaff, Mount Wilson, Pic-du-Midi); periods of *perfect* seeing even there may last one second or less. Terrestrial air currents play havoc with Mars's image, and Martian atmospheric obscurations affect it also.



FIG. 33

Martian longitude  $120^\circ$  from left limb (about  $180^\circ$ ) to right (about  $300^\circ$ ), where Syrtis Major is much fore-shortened. Dark area right of centre: Utopia.

A. F. O'D. Alexander,  $5\frac{1}{2}$ -in. O.G.  
1950 April 6.  $w=243^\circ$ ;  $\phi=+24^\circ$

Mars's rotation advances the central meridian  $14^\circ.62$  in longitude per *hour* (e.g.  $10^\circ$ ;  $24^\circ.62$ ;  $39^\circ.24$ ), but Mars's slightly longer day moves the meridian back about  $9^\circ$  *daily* (e.g. next day at same hours:  $1^\circ$ ;  $15^\circ.62$ ;  $30^\circ.24$ ), enabling an observer to 'tour' all round the planet within six weeks. Foreshortening leaves at most  $120^\circ$  of longitude available for observation at one time. To the unaided eye Mars is merely a brilliant orange-red 'star' even at opposition. Though the planet appears fully illuminated at oppositions, the Earth would then show only a thin crescent to Mars.

*Early discoveries.* Remarkable advances were achieved by pioneers with small imperfect telescopes. Galileo (1610) noticed that Mars does not always look circular. The phase is gibbous: never less than  $\frac{6}{7}$  of the disk is illuminated, corresponding to the Moon within four days of full. Fontana (1636) first glimpsed dusky markings, but too vaguely to draw them. Huyghens (November 28,

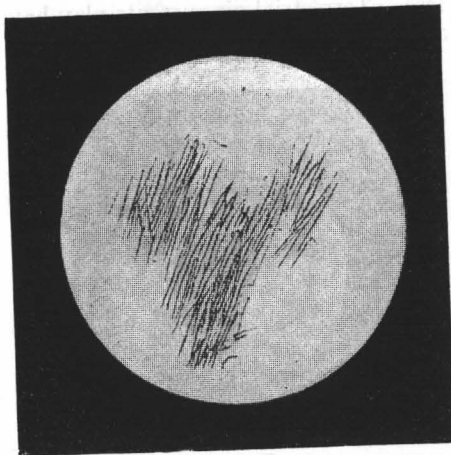

F G. 34

Earliest sketch of Mars's surface: Syrtis Major by Huyghens, 28 November, 1659.  
(From *Splendour of the Heavens*, Hutchinson)

1659) made the first drawing—of Syrtis Major, the most prominent dark marking. This sketch, nearly three centuries old, enables Mars's rotation period to be calculated to within  $\frac{1}{50}$  of a second. The markings were soon seen to have permanent shapes; Fontana (1638) and Hooke (1666) observed them moving across the disk through the planet's rotation. J. D. Cassini (1665) calculated a rotation period 40 minutes longer than the Earth's—within  $1\frac{1}{2}$  minutes of the correct figure. He also discovered (1666) the brilliant white patches, which Maraldi (1719) inferred were polar caps, as their positions seemed fixed compared with the dark markings. Maraldi also found their size variable and that they were slightly eccentric to the poles. William Herschel confirmed that the dark

markings were permanent but varied slightly in appearance, as if occasionally obscured by Martian clouds. He also showed that the changing size of the polar caps corresponded to Mars's seasons and suggested (1784) that they were snow-covered areas.

*Nature of polar caps.* A theory that the polar whiteness is solidified carbon dioxide is demolished by the experimental results of Faraday. These prove that under the lower Martian atmospheric pressure, carbon dioxide could not remain solid at temperatures above  $-150^{\circ}$  C. and would not liquefy on melting but evaporate. Mars's polar caps appear to liquefy at the edge; their minimum temperature, from recent radiometrical estimates, is  $-70^{\circ}$  C.; and recent infra-red light tests in America indicate a likeness to frozen water, not carbon dioxide snow, so Herschel's theory is confirmed.

*Early maps.* Patient observation (1830-9), including the close 1830 opposition, with a telescope of hardly 4 inches aperture, enabled Beer and Mädler to publish (1840) the first map of Mars, with lines of latitude and longitude. Thus they founded the science of areography (geography of Mars; Greek: 'Ares'). Other maps followed, including R. A. Proctor's (1869) based on W. R. Dawes's drawings; Kaiser's (1872); N. E. Green's (1877). But all were rendered obsolete by the amazing discoveries of Schiaparelli at the oppositions of 1877, 1879, and 1881.

*Schiaparelli.* In the historic year 1877 Asaph Hall (Washington) discovered Mars's two satellites and Giovanni Schiaparelli (Milan) remapped Mars and detected the famous canals. Having a new  $8\frac{3}{4}$ -inch aperture refractor, Schiaparelli decided to use the favourable opposition to determine accurately the Martian latitudes and longitudes of a series of points on Mars's surface. Pursuing this modest objective he was astounded at the complexity of surface detail revealed by exceptional seeing conditions. He detected hundreds of additional features and found that the shapes and positions of several of the few dozen depicted (and named after astronomers) on published maps were inaccurate. He therefore decided to construct an entirely new map with a new nomenclature, based partly on ancient names of Mediterranean and Middle East lands and seas, partly on names in the Bible and classical mythology. So he renamed Kaiser Sea, Syrtis Major (old name for Gulf of Cyrenaica); Dawes Sea, Solis Lacus (Lake of the Sun, or Caspian Sea); Delarue Ocean, Mare Erythraeum (Indian Ocean). The group Hooke Sea,



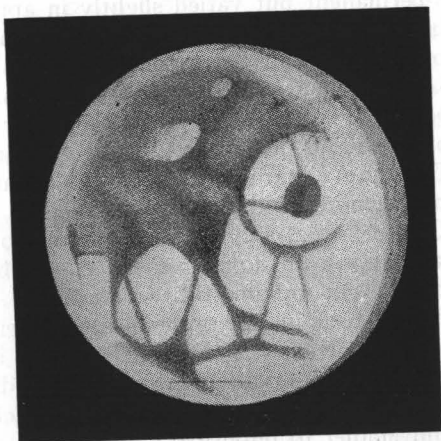

FIG. 35A  
Mars, 1879—Schiaparelli  
(From *Splendour of the Heavens*, Hutchinson)



FIG. 35B  
Mars, 1877—Schiaparelli  
Left: Forked Bay central. Right: Solis Lacus central.  
(From *Splendour of the Heavens*, Hutchinson)

Cassini Land, Dawes Ocean, Lockyer Land, became Mare Tyrrhenum (Tyrrhenian Sea), Ausonia (Italy), Mare Hadriacum (Adriatic), Hellas (Greece). Mythological names include Mare Sirenum (Sea of the Sirens), Elysium, Atlantis. His Mars maps and names, with additions by Lowell and Antoniadi, form the basis of modern areography.

*Schiaparelli's canals.* Following convention, Schiaparelli named dark areas *mare* (sea), *sinus* (gulf or bay), *fretum* (strait), *lacus* (lake) according to size and shape, and detecting many narrow dusky streaks crossing light areas, naturally called them *canali*, a term (already used by Secchi) meaning *channels*. Unfortunately 'canali' was translated *canals*, implying an artificial origin that Schiaparelli never intended to convey. Though a few of the largest darkest canals had been drawn by earlier observers from Herschel to Dawes, the announcement of the discovery of many fainter ones was received with uncompromising scepticism. In 1879 Schiaparelli saw the canals again, and many more, drawing them as narrower straighter lines. Worse still (1881), he not only made them more geometrical but even said that some had doubled: markings like tram-lines appeared on his drawings. 'His critics were dumbfounded,' wrote Dr. R. L. Waterfield; 'nobody had so much as seen these geometrical lines; surely their duplication could only be a proof that Schiaparelli was a victim of illusions!'

Schiaparelli's revolutionary discoveries started a tremendous controversy among astronomers. He continued observing through many oppositions, but realizing that his eyesight was weakening, would not publish any observations made after 1890. E. M. Antoniadi, severe critic of canals, wrote of him: 'As an observer Schiaparelli was our master in everything, his great artistic talent, his numerous original discoveries on Mars... the fact that his "canals" correspond after all to details quite different... but real... make him the first planetary astronomer of modern times...'

*Lowell's canal theory.* Generally repudiated in Europe the canals found support in America. Lowell founded (1894) Lowell Observatory, Flagstaff, Arizona, for the observation of planets, particularly Mars. Using apertures of 18 inches and later 24 inches, he and his colleagues discovered narrow canals in great number until his Mars maps were covered with a network of geometrical lines. A multitude of canals, single and double, seemed to radiate from the polar

caps, many intersecting at dusky spots named *oases*. Their narrowness, straightness, and frequent intersections discouraged natural explanations such as river-beds or surface cracks, so Lowell

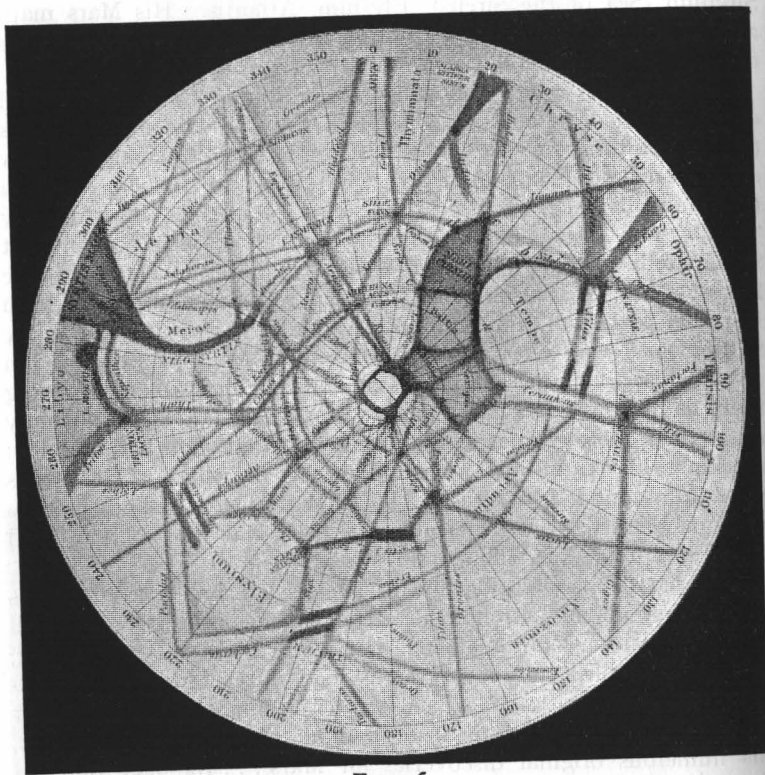

FIG. 36

Chart of northern hemisphere of Mars by Schiaparelli, 1888, showing canals, many double, radiating from melting north polar cap (*centre*).

(From *Splendour of the Heavens*, Hutchinson)

boldly asserted that they *were* artificial; the vegetation growing along watercourses constructed by intelligent Martians to irrigate their arid planet from the melting polar snows! This sensational theory was strenuously opposed, and now has few, if any, adherents. It fitted the phenomena, including seasonal colour changes and

germination (doubling) of canals, but this was no proof of the theory, for an assumption of intelligent activity would explain almost any phenomenon, as Waterfield has pointed out.

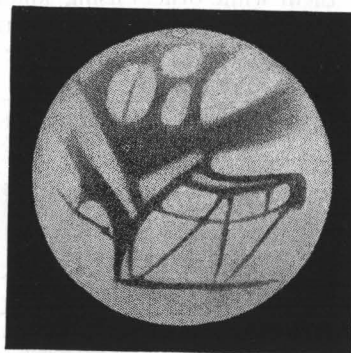

FIG. 37

Mars, 7 October, 1894. A. Stanley Williams, first man in England to detect fine canals;  $6\frac{1}{2}$ -inch aperture.

(From *Splendour of the Heavens*, Hutchinson)

*Canals disputed.* Most European astronomers endeavoured to explain away the canals. Extremists said they were pure illusions

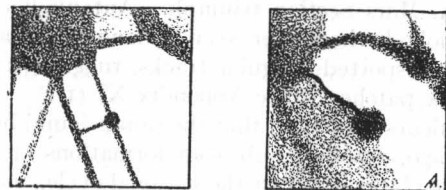

FIG. 38

Canals from Aurorae Sinus drawn by Schiaparelli (*left*), Antoniadi (*right*), Baetis (*central*) drawn dark and narrow but sinuous by Antoniadi.

(British Astronomical Association: *9th Mars Report*)

or optical effects. But faint canals had, by 1890, been detected by Perrotin (at Nice) and Stanley Williams, and later by many others. Nevertheless there were suspicious circumstances: canals appeared

single one day, double the next, single to one observer, double to another the same night; some seemed too narrow for detection with the telescopes employed; excellent observers with large telescopes failed to see them while others using small ones drew them. English observers, notably N. E. Green (1879), noticed that many canals were *edges* to lightly shaded areas. Major P. B. Molesworth

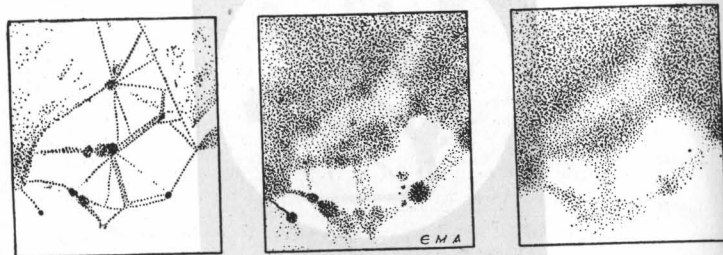

FIG. 39

Solis Lacus region in 1909 according to Lowell, 17th September (*left*); Antoniadi, 6th and 11th October (*centre*); Lowell Observatory photograph, 18th October (*right*). Note resemblance of Antoniadi's drawing to the photograph.

(British Astronomical Association: *9th Mars Report*)

said they were *streaks* rather than lines. He and Antoniadi, using large telescopes, resolved many into discontinuous lines of dusky spots—a B.A.A. Mars Section triumph. Antoniadi's lifelong contention was: nobody had ever seen a true rectilinear canal on Mars; all were on spotted irregular tracks, rugged grey borders, or isolated complex patches. (See Appendix XI (1).)

G. de Vaucouleurs points out that the canals found by Schiaparelli seventy years ago, whether unbroken formations or not, are still seen in the same places, share in the seasonal cycle, and can develop into prominent dark bands (e.g. Cerberus, Nepenthes-Thoth) lasting years or decades, and become faint and insignificant again. Some at least obey the laws of perspective as real markings should.

The term 'canal' is still used, conveniently describing a particular type of marking on Mars without any implication about its nature. Though most canals are now considered curved, broad, and diffuse, many observers admit that some can appear narrow and sharp, some double on occasion. The dispute was partly one about different styles of drawing: Antoniadi's natural-looking soft shadings

and Lowell's artificial-looking sharp lines. Excellent recent Mars photographs by H. Camichel (Pic du Midi) strongly resemble many beautiful drawings by Rev. Dr. T. E. R. Phillips and Antoniadi.

The faint canals are fugitive, some, then others, appearing momentarily in good seeing, but not long enough to be photographed. During the 1956 opposition cinephotography, if used with the 200-inch telescope which could photograph Mars in exposures of  $\frac{1}{10}$  of a second or less, might reveal the structure of faint canals.

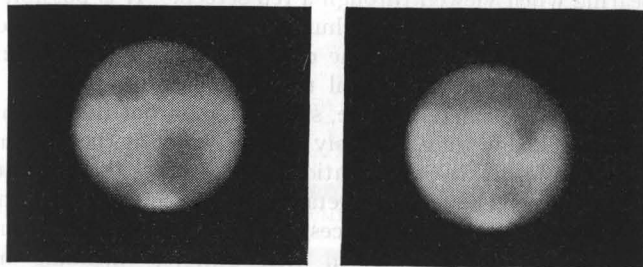

PLATE XVIII

MARS PHOTOGRAPHS BY H. CAMICHEL

(Pic du Midi Observatory, 1948 March 3 and 14)

*Deserts, plateaux.* There is strong evidence (from albedo, Lyot's<sup>1</sup> polarimeter, Kuiper's<sup>2</sup> infra-red light tests) that the light areas are deserts with a dusty cover resembling brown, fine-grained felsite rather than iron oxides, the yellow veils probably being of similar composition. It is uncertain whether there are mountains higher than 2,500 feet, the only suspected elevations being bright spots in the tropics (e.g. Nix Olympica), possibly snow-capped or cloud-capped, and polar plateaux (e.g. Thyle I, II; Argyre II; Olympia) where the caps melt tardily. The atmosphere has possibly flattened Mars by sand erosion, if it ever had mountains. (See Appendix XI (2).)

*Melting polar caps.* Schiaparelli observed that the polar whiteness disappeared more rapidly from dusky than light ground, and that the southern cap's last vestige was at about latitude 84° S.,

<sup>1</sup> Dr. Bernard Lyot, famous French inventor and astronomer, whose premature death (1952 April 2) is a serious misfortune to science.

<sup>2</sup> Dr. G. P. Kuiper, director of Yerkes Observatory, U.S.A., an eminent authority on the planets and their satellites and atmospheres.



longitude  $40^\circ$ . The caps photograph in both ultra-violet and infra-red, suggesting both overlying vapour and surface whiteness.

De Vaucouleurs outlines their seasonal cycle somewhat as follows: Towards winter's end in each hemisphere the cap, emerging very large and dull from its cloudy veil, shrinks slowly at first, becoming brilliantly white. Cracks appear by mid spring; fragments break off. In late spring when melting is most rapid a dark fringe is prominent. Though dismissed by Antoniadi as a contrast effect, the fringe seems mainly real, being darker near duller parts of the cap and not disappearing when viewed through a red screen. It is possibly not a polar sea, but ground several hundred miles wide dampened by melting ice. During summer the cap becomes very small, finally disappearing under a whitish veil until late winter.

The caps are presumably of ice, snow, or frost not thicker than a few inches. Though they probably melt to water at the edge, most shrinkage would be by evaporation, considering the low atmospheric pressure. The fissures, detached parts, and brightest areas appear always at the same places. Why do the Martian snow-caps come nearer the equator in their winters, shrinking much more in their summers than the Earth's caps? The reasons are: the seasons are twice as long; the absence of seas and the atmospheric dryness make snowfall lighter; the ellipticity of Mars's orbit entails greater difference between summer warmth and winter cold.

*Dark regions.* Though perhaps former sea-beds, the dark areas are certainly not seas. J. Phillips (1863) and Schiaparelli remarked that the *maria* did not reflect the Sun's image as sheets of water should. Final proof came when W. H. Pickering (who published many valuable reports on Mars) traced (1892) several canals across Mare Erythraeum, and Lowell and A. E. Douglass found (1894) all the *maria* crossed by canals.

Confirming earlier observations by Liais and Trouvelot, Lowell and Douglass noted (1896-7) the colour change of the southern *maria* towards midsummer from green to brown, then yellow. Antoniadi and Baldet (1924), using the Meudon 32-inch refractor, saw discoloration coming from the south polar region turn some canals brown and most—not all—of the greenish areas brown, brown-lilac, or carmine. Antoniadi found that the brown colouring did not usually last long and varied in (Martian) date of arrival. He did not confirm the further change to yellow. G. Fournier and

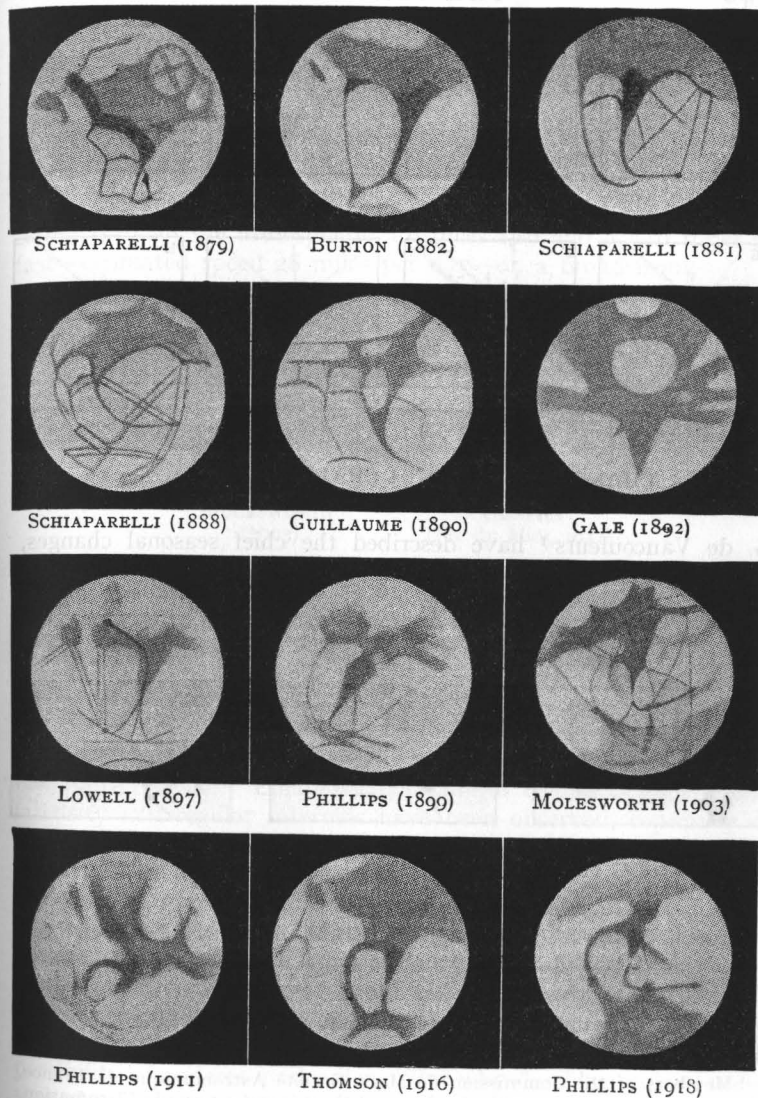

FIG. 40  
CHANGES IN SYRTIS MAJOR, 1879-1918  
(H. Thomson's collection of drawings. Hutchinson: *Splendour of the Heavens*)

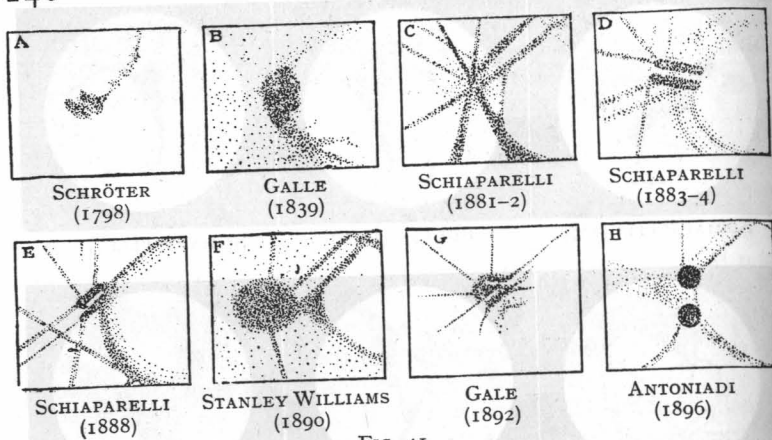

FIG. 41  
CHANGES IN TRIVIUM CHARONTIS REGION  
(British Astronomical Association: *3rd Mars Report*)

G. de Vaucouleurs<sup>1</sup> have described the chief seasonal changes, which seem strictly connected with polar cap shrinkage: In early

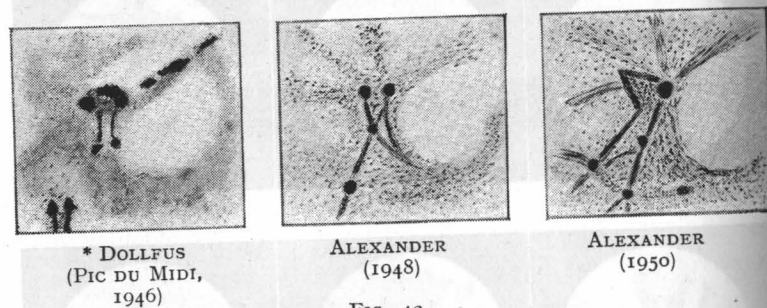

FIG. 42  
RECENT IMPRESSIONS OF TRIVIUM CHARONTIS REGION  
[\* By permission of Société Astronomique de France from *L'Astronomie*, September 1947.]

spring the circumpolar area becomes very dark, the brownish darkening extending rapidly over the temperate zone, reaching the

<sup>1</sup> Members of the Commission de Mars, Société Astronomique de France, whose observers, following the tradition of their founder Camille Flammarion, celebrated historian of Mars observations, have contributed much to our knowledge of Martian features.

equator and crossing into the tropics of the other hemisphere, so some areas (e.g. Mare Erythraeum) have a double seasonal cycle. By summer most dark areas have changed from greenish to brownish hues. During summer the polar regions become pale again. The darkening is inclined to follow great canals (e.g. Hellespontus) in line with cap fissures; this may be a flow of surface water. The wave of general darkening, probably produced by moisture transferred through the atmosphere, advances two and a half times as fast—estimated speed 28 miles per day—on a broad front.

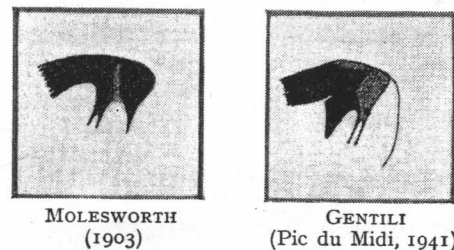

FIG. 43  
UNUSUAL APPEARANCES OF THE FORKED BAY

(Left: British Astronomical Association: *6th Mars Report*. Right: By permission of Société Astronomique de France from *Bulletin*, April 1943.)

Certain dark markings show regular seasonal extensions into neighbouring light regions—e.g. Syrtis Major's autumn encroachment into 'Libya.' Encroachments and/or changes of shape and intensity at irregular intervals have been observed, especially of Solis Lacus, Mare Cimmerium, Nepenthes-Thoth, Trivium Charontis, and (at recent oppositions) Utopia.

*Vegetation theory.* Explanations, other than vegetation, of the seasonal changes, such as alterations in the degree of hydration of minerals and salts, seem unconvincing, but the vegetation theory involves many difficulties. Could vegetation withstand the great temperature variations, low pressure, and dryness? Antoniadi suggested that Mars's rather low density favours porousness and the possibility of underground water. But why should presumed moisture change tints from green to brown? Also there is the lack of oxygen and failure of Martian green areas to darken in red

light:<sup>1</sup> evidences against plants with chlorophyll. The only possible vegetation seems to be dry lichens, mosses, or green algae (the family of seaweeds, pond scums, and certain microscopic plants). In some algae under suitable conditions photoreduction instead of photosynthesis occurs, oxygen compounds, not free oxygen, being produced.<sup>2</sup> E. J. Öpik's strong argument for some form of Martian

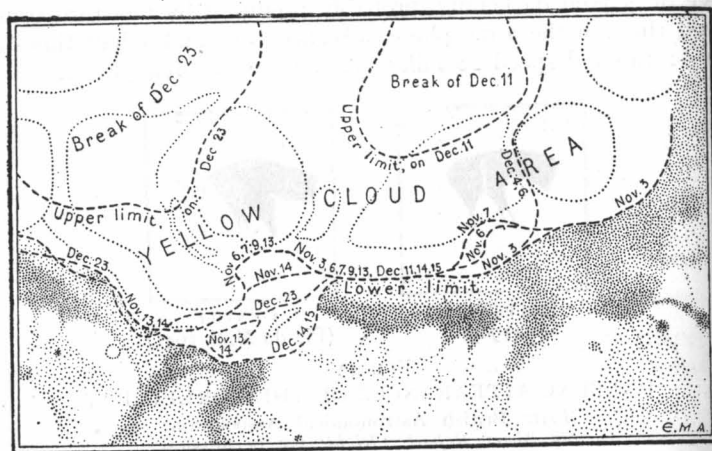

FIG. 44

Yellow obscuration in Mars's atmosphere as seen by E. M. Antoniadi at Meudon, November 3–December 23, 1911

(British Astronomical Association: *10th Mars Report*)

vegetation 'defying the sand drifts and feeding on the dust,' is that nothing else could prevent the (probably low-level) dark areas from being swamped by desert dust, and the whole planet except the poles assuming a uniform orange-yellow colour.

*Atmosphere.* Though very sensitive tests failed to detect water vapour or oxygen in Mars's spectrum, Kuiper found (1947) carbon

<sup>1</sup> Kuiper, examining the surface of Mars by infra-red light, found the green spots were only about half the intensity of the so-called deserts. As green plants on Earth strongly reflect the near infra-red and appear white when photographed through an infra-red filter, the green spots on Mars, appearing dark, could not consist of seed plants and ferns of terrestrial type. Also it is thought that the cold of the Martian nights would freeze the water in such plants.

<sup>2</sup> This was pointed out by James Franck, an American scientist.

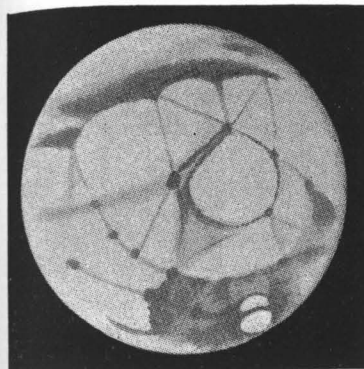

(a)

P. B. MOLESWORTH  
12¼-in. Spec. April 14, 1903.  
 $\omega=200^\circ$ .  $\phi=+24^\circ$ .

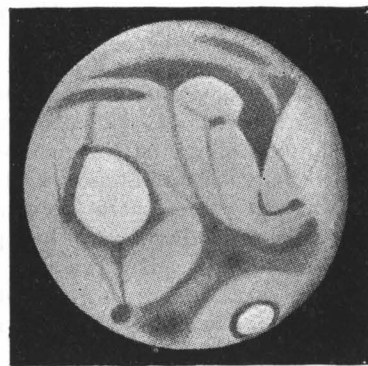

(b)

T. E. R. PHILLIPS  
9¼-in. Spec. April 19, 1903.  
 $\omega=252^\circ$ .  $\phi=+24^\circ$ .



(c)

A. F. O'D. ALEXANDER  
5½-in. O.G. 1946 February 23.  
 $\omega=285^\circ$ .  $\phi=+4½^\circ$ .

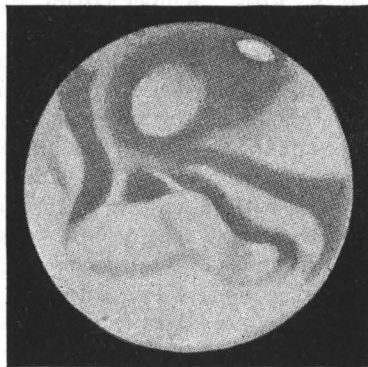

(d)

T. E. R. PHILLIPS  
12¼-in. Spec. September 18, 1909.  
 $\omega=310^\circ$ .  $\phi=-20^\circ$ .

FIG. 45

#### ELYSIUM AND SYRTIS MAJOR REGIONS

Spec.=reflector.

O.G.=refractor.

$\omega$ =Martian longitude of central meridian.

$\phi$ =Martian latitude of centre of disk, + north, - south latitude.

(a, b, d from British Astronomical Association: *6th* and *9th Mars Reports*)



dioxide (lines) in the infra-red spectrum, less than on Venus but probably more abundant than on the Earth. Photographs in light of various colours indicate an atmosphere 60 miles deep, with yellow cloud-like patches in the lowest layer; then a 'violet layer' powerfully absorbing and scattering short-wave light; above that whitish or 'blue' patches (estimated heights 6 to 19 miles) visible in violet light, invisible in red, possibly corresponding to terrestrial fog and cirrus. The presence and effect of the 'violet layer' in Mars's atmosphere is evident on comparing photographs of Mars taken with filters of various colours. Whereas the surface features photograph clearly in yellow light and even more so in red and infra-red, yet photographs in blue, violet, or ultra-violet show no surface features as a rule, though occasionally registering indistinctly one or two of the most prominent surface markings. This important discovery was made at the 1924 and 1926 oppositions of Mars by the American astronomers W. H. Wright and F. E. Ross. Kuiper (1948), using narrow-band filters, found that the Martian atmosphere was opaque for wave-lengths below 4500 Å. and nearly transparent for those longer than 5000 Å. He also found the haze least dense on what must have been the warmest part of the planet at the time, and that white clouds often formed near the sunset edge, while others near the sunrise edge seemed to break up. Hence Mars is thought to have a light scattering atmosphere with much haze, gathering in cold conditions but dissipated by warmth. Vast yellow veils (1909, 1911) obscured millions of square miles of Mars for weeks, according to reports of the B.A.A. Mars Section (whose director, 1896-1917, was Antoniadi). Temporary white edges to dark areas when near the sunrise limb were regarded by Antoniadi as mere contrast effects, but Lyot's polarimeter indicates that they are probably hoar-frost. Various investigators by different methods, all involving doubtful assumptions, obtained very similar values—mean about 3 inches—for the atmospheric pressure at Mars's surface.

*Temperature.* Solar heat reaching Mars is probably only 40 per cent of the Earth's quota. Using sensitive thermocouples attached to large telescopes, Pettit and Nicholson (Mount Wilson), Menzel, Coblentz, and Lampland (Flagstaff) obtained (1922, 1924, 1926) the first Martian surface temperature readings: Bright tropical regions at noon, 50° to 68° F. (10° to 20° C.); dark tropical areas, 68° to



(a)

A. F. O'D. ALEXANDER  
5-in. O.G. 1943 December 20.  
 $\omega = 350^\circ$ .  $\phi = -10^\circ$ .

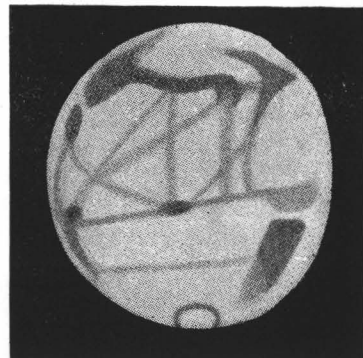

(b)

W. H. STEAVENSON  
Greenwich 28-in. O.G. April 22, 1918.  
 $\omega = 353^\circ$ .  $\phi = +23^\circ$ .

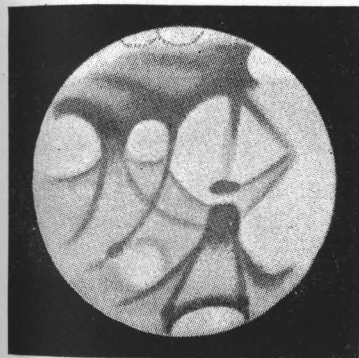

(c)

P. B. MOLESWORTH  
12½-in. Spec. March 7, 1901.  
 $\omega = 28^\circ$ .  $\phi = +20^\circ$ .

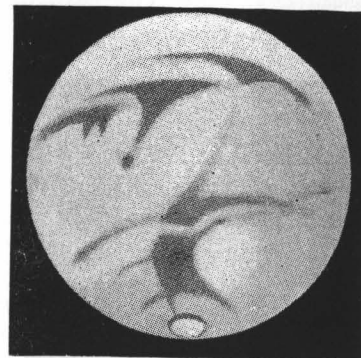

(d)

T. E. R. PHILLIPS  
8-in. O.G. March 9, 1918.  
 $\omega = 37^\circ$ .  $\phi = +22^\circ$ .

FIG. 46

## SINUS SABAEUS AND MARE ERYTHRAEUM REGIONS

(b from Hutchinson's *Splendour of the Heavens* (permission of Astronomer Royal); c, d from British Astronomical Association: 5th and 13th Mars Reports.)



(a)

E. M. ANTONIADI  
Meudon 32 $\frac{3}{4}$ -in. O.G. October 11,  
1909.  $\omega=76^\circ$ .  $\phi=-22^\circ$ .

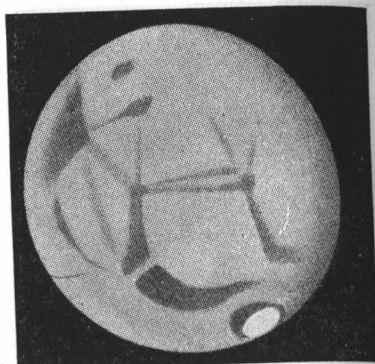

(b)

T. E. R. PHILLIPS  
9 $\frac{1}{4}$ -in. Spec. May 7, 1903.  
 $\omega=80^\circ$ .  $\phi=+25^\circ$ .

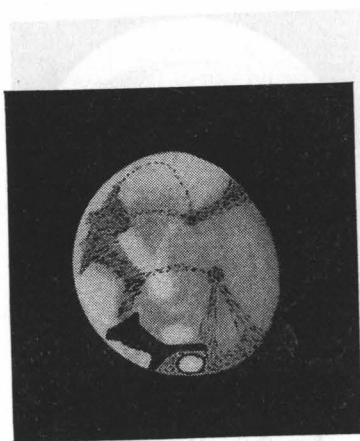

(c)

A. F. O'D. ALEXANDER  
5 $\frac{1}{8}$ -in. O.G. 1950 April 20.  
 $\omega=88^\circ$ .  $\phi=+23^\circ$ .

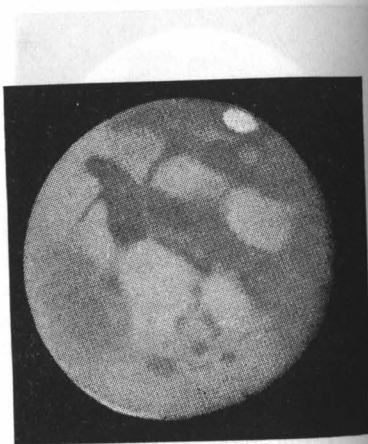

(d)

E. M. ANTONIADI  
Meudon 32 $\frac{3}{4}$ -in. O.G. November 5,  
1909.  $\omega=197^\circ$ .  $\phi=-24^\circ$ .

FIG. 47

AURORAE SINUS, SOLIS LACUS, MARE SIRENUM REGIONS  
(a, b, d from British Astronomical Association: 6th and 9th Mars Reports)

86° F. (20° to 30° C.) and even higher; high latitudes at winter noon, 32° to 68° F. (0° to 20° C.) under clear sky but -40° C. under high 'blue' cloud. The south polar temperature in late summer may be from 0° to 20° C. [Note.—These are *sunlit surface* temperatures, *not* air shade temperatures (the terrestrial standard).]

*Satellites.* In *Gulliver's Travels* (1726) Swift said of the fictitious Laputan astronomers: 'They have likewise discovered two lesser



FIG. 48

## MARS WITH ITS MOONS

Phobos (*left*), Deimos (*right*), drawn by W. H. Steavenson.

(From *Splendour of the Heavens*, Hutchinson)

stars, or satellites, which revolve about Mars, whereof the innermost is distant from the centre of the primary planet exactly 3 of his diameters, and the outermost 5; the former revolves in the space of 10 hours, and the latter in 21 $\frac{1}{2}$ .' This was the most extraordinary piece of guess-work in literature, because two tiny satellites *were* found 151 years later<sup>1</sup> whose distances from Mars's centre are 5,800 miles (1 $\frac{1}{2}$  diameters) and 14,600 miles (3 $\frac{1}{2}$  diameters), and whose revolution periods are 7 hours 39 minutes and 30 hours 18 minutes respectively. Phobos ('panic'), the nearer, is the only known satellite to revolve round its planet more quickly than the planet rotates. It revolves in less than  $\frac{1}{3}$  of Mars's rotation period and therefore rises in the *west*, rushes across the sky, and sets in the east 4 hours later, changing within that time from new to full or full to new. Deimos ('fear') revolves in little longer than Mars rotates, so Deimos stays above the Martian horizon for three days without setting, going through all its phases twice over in that time.

<sup>1</sup> By Asaph Hall, Washington. (See Appendix XI (3).)

As moons they are ineffectual. Phobos (estimated diameter 15 miles) is never above the horizon in higher Martian latitudes than  $69^\circ$ . At the equator Phobos gives Mars only  $\frac{1}{60}$ , Deimos  $\frac{1}{1200}$  of the Moon's light on Earth. Deimos may have only half Phobos's

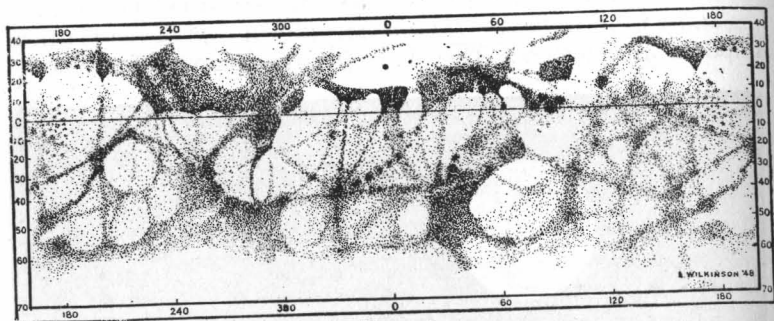

FIG. 49

Map of Mars, 1947-8, as observed by A. Wilkinson; 12-in. Spec.

diameter. From the Earth they are no brighter than a man's hand in sunlight 100 miles distant, and require very large telescopes to be detected. Their mass and surface gravity are extremely small; a man would weigh on either but a few ounces and could never move freely without bouncing off the ground.

## JUPITER

*The giant planet.* Beyond Mars and the belt of the asteroids lies Jupiter, the largest, most massive, and most turbulent planet, whose volume and mass exceed those of all the other planets combined. It powerfully affects the motion of less massive bodies—minor planets, meteor swarms, and comets—which approach near enough, having deflected some into new orbits. Its surface gravity is 2.64 times the Earth's: a man weighing 10 stone would not be more than about a stone lighter or heavier on Uranus, Saturn, or Neptune, but would weigh over 26 stone on Jupiter.

This huge planet has a mean diameter of 86,700 miles, nearly eleven times the Earth's diameter, and therefore 1,312 Earths might be packed within it. But as its mass is only 317 times the

Earth's mass, Jupiter cannot be of similar composition. Like the other great planets Jupiter has a low mean density, only  $\frac{1}{4}$  of the Earth's density or 1.34 times that of water. It is evident from observation that the planet's globe consists partly of a deep and stormy atmosphere. Dr. R. Wildt has estimated the diameter of Jupiter's metallic rocky core at about 37,000 miles, encased in ice about 17,000 miles thick and an atmosphere 8,000 miles deep. 'Ice' here includes vapours such as water, methane, and ammonia condensed under high pressure, and only the outer layers of the deep 'atmosphere' would contain gases in a normal state.

*Dr. W. H. Ramsey's theory of hydrogen planets.* Wildt's view was generally held until quite recently, but a different conclusion is reached in an investigation by Dr. W. H. Ramsey, who has kindly sent the writer an advance copy of his paper on 'The Constitution of the Major Planets,' which has since appeared in the *Monthly Notices of the Royal Astronomical Society*, 111, 5, 1951. Ramsey finds that Wildt's models for the major planets are based on too low assumed densities for the core and 'ice' layer, and shows that the hydrogen content of Jupiter must be about 80 per cent by mass—of Saturn about 60 per cent—the hydrogen being molecular in the outer layers but metallic in the inner. This would sufficiently account for the low mean densities of these two planets. Uranus and Neptune, denser in proportion to mass, cannot have such a hydrogen preponderance, but must consist mainly of somewhat denser materials, e.g. water, methane, and ammonia. Yet even they must contain only rather small percentages of metallic iron and oxides of iron, magnesium, and silicon, which make up the bulk of the terrestrial planets. Ramsey considers that the total mass of 'ice' and terrestrial material in Jupiter is probably about twenty times, and in Saturn about seven times, the Earth's mass.

*Distance, year, day.* At a mean distance of 483 million miles, more than five times as far as the Earth, Jupiter travels around the Sun in a somewhat elliptical orbit, inclined only  $1^\circ.3$  to the ecliptic. Jupiter's mean orbital speed is 8 miles a second and its year 11.86 terrestrial years. This planet travels almost erect, the plane of its equator tilting only  $3^\circ$  from its orbit-plane. Jupiter's rotation on its axis, discovered by J. D. Cassini, is extremely rapid for its huge bulk, the equatorial rotation period (or day) being only 9 hours  $50\frac{1}{2}$  minutes, representing a speed exceeding



28,000 miles an hour, 27 times the Earth's rate of spin. There are therefore about 10,500 Jovian days in one Jovian year. The rotation speed is such that the centrifugal force, in spite of the great surface gravitation, causes considerable polar flattening ( $\frac{1}{5}$ ), though less than on Saturn. Jupiter's polar diameter is nearly 6,000 miles less than its equatorial diameter of 88,700 miles. This rapid rotation and solar heat doubtless produce atmospheric currents parallel

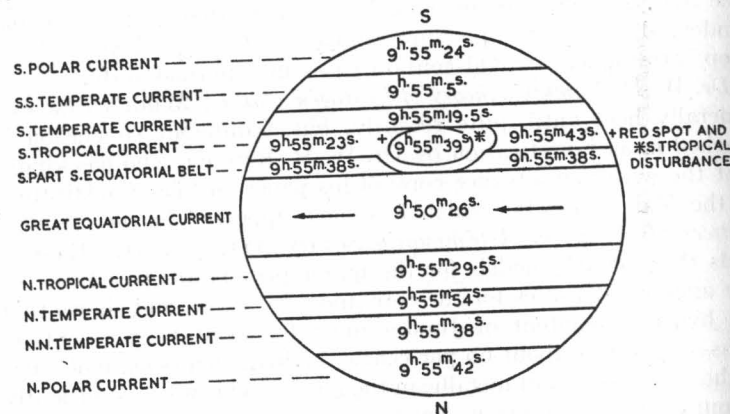

FIG. 50

Rotation periods of Red Spot, South Tropical Disturbance, and the chief atmospheric currents on Jupiter

(From diagram by T. E. R. Phillips in *Scientia* and Hutchinson's *Splendour of the Heavens*.)

to the equator and preserve them owing to the deep atmosphere, so the cloud belts appear as bands parallel to the equator, and irregularities on them can be seen with a telescope to move appreciably on the disk in  $\frac{1}{4}$ -hour or less.

*Differential rotation.* J. D. Cassini and Schröter noticed that Jupiter, like the Sun and Saturn, has different rotation speeds in different latitudes, proving that the visible surface is not solid. The equatorial zone rotates fastest, the areas next to the polar regions slowest. The equatorial rotation period is about 5 minutes shorter than the others, which differ from each other only by fractions of a minute. Hence for observers to work out the longitude of any marking whose transit across the central meridian they

have timed, only two systems of longitude are needed: System I for the equator and  $10^\circ$  latitude north and south; System II for the rest of the planet. But currents of differing speed complicate matters: certain features in the same latitude may move at different rates and the same feature's speed may vary. Rotation periods for markings on Jupiter range between 9 hours 48 minutes and 9 hours 59 $\frac{1}{2}$  minutes.

*Visibility and appearance.* To the unaided eye Jupiter seems a

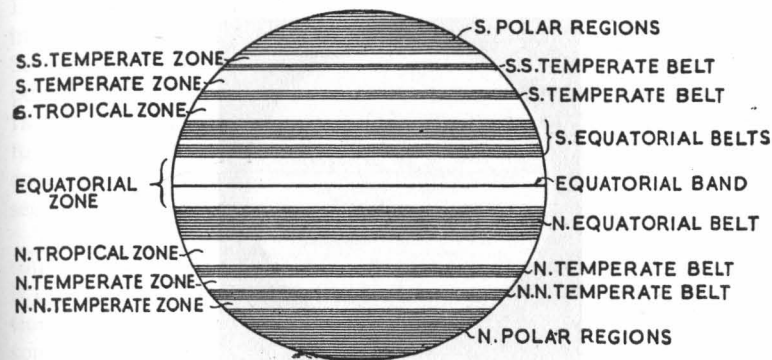

FIG. 51

Belts and zones of Jupiter (and also Saturn)

(British Astronomical Association: *Jupiter Reports*.)

brilliant star, second only to Venus though occasionally outshone by Mars. A very small telescope, even strong binoculars, can show the flattened golden disk (with perhaps a glimpse of the darkest belt) and the four brighter moons, a charming sight and one of the first to delight Galileo when observed through his new telescope in January 1610. A larger instrument shows more reddish-brown belts with bright zones between, both belts and zones variegated with irregular dark and bright spots and streaks of different tints and sizes. Frequent changes in belts and spots display the atmospheric turmoil, and atmosphere with curvature of the globe make most belts appear to terminate short of the limbs. At various times great variety of colour is seen: shades of brown, red, pink, orange, yellow, green, blue, and purple have been recorded as well as grey and white. Stanley Williams even suspected regular

colour changes in the equatorial belts corresponding to the Jovian year.

*Work of Jupiter Section.* Almost everything known about the currents and disturbances in Jupiter's atmosphere during the past sixty years has been found out through the observations of the members of the B.A.A. Jupiter Section, chiefly by timing transits of disk markings across the central meridian. The section throve under the inspiring directorship for thirty-three years of one of the

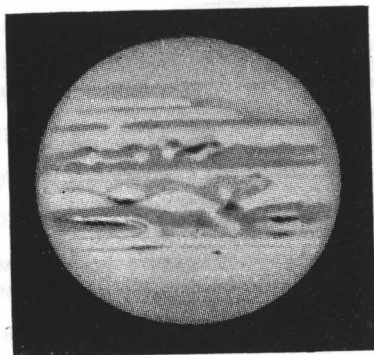

FIG. 52

T. E. R. PHILLIPS

18-in. Spec. 1932 March 18.

 $\omega_1 = 71^\circ$ ,  $\omega_2 = 323^\circ$ 

Both equatorial belts disturbed.

[ $\omega_1$ ,  $\omega_2$  = Jovian longitudes of central meridian, System I (II).](British Astronomical Association: 29th *Jupiter Report*)

greatest of planetary observers, the Rev. Dr. T. E. R. Phillips, and of his successor, B. M. Peek. Detailed reports of observations from 1891 to 1947 have been published. Other outstanding observers in this section, past and present, include A. Stanley Williams who initiated the systematic observation of surface markings, and by 1896 had discovered eleven of the atmospheric currents; P. B. Molesworth, discoverer of the South Tropical Disturbance (1901), who timed over 12,000 transits of spots within two years; W. F. Denning, M. A. Ainslie, F. J. Hargreaves, Dr. W. H. Steavenson, W. E. Fox, and E. J. Reese (in U.S.A.). Most of the information in the next few paragraphs is derived from the work of this Jupiter Section.

*The Red Spot.* Jupiter's great Red Spot or a prototype was discovered by R. Hooke (1664). J. D. Cassini investigated its rotation period; it disappeared and reappeared several times and was finally lost sight of in 1713. The Red Spot of to-day, or its Hollow, was drawn by Schwabe (1831) and has been regularly observed since, especially by the members of the Jupiter Section from 1891. By 1878 it had developed to an ellipse stretching 30,000 miles in Jovian longitude and 7,000 miles in latitude—about equal in area to the Earth's entire surface. At that date it also reached maximum intensity, changing from a pale pinkish to a deep brick-red colour. Since 1882 it has often looked more the shape of a capsule with pointed ends and has faded at times almost to invisibility, now and then reviving (as in 1920, 1926, and 1936), but not, except in 1936, to the intensity of 1878–81. Peek has described its modern appearance as 'a dark ellipse with a comparatively light interior.' It seemed (1949) sometimes salmon pink, sometimes colourless.

The Spot is situated in a curious Hollow in the south side of the south equatorial belt. Peek has affirmed that whenever the Spot is conspicuously dark, what seems to be an atmospheric condensation, avoiding the Spot itself, obliterates the Hollow and makes the south tropical zone brilliantly white; not a mere contrast effect, for it has been verified by ultra-violet photographs. The Spot's reddish colour has also been photographically confirmed, as it shows up most darkly and clearly in ultra-violet or violet photographs, less in green or yellow, and is invisible in red or infra-red.

The Red Spot's position does not remain fixed. Its range in longitude (1831–1938) was  $1,046^\circ$ , nearly equivalent to three circuits ( $3 \times 360^\circ$ ) round the planet. From the Jupiter Section's statistics Peek showed that the Spot moved forward in Jovian longitude  $477^\circ$  (1891–1910), then backward  $313^\circ$  (1910–29), and again forward, with oscillations,  $81^\circ$  (1929–38). The Red Spot cannot therefore be attached to Jupiter's surface but must float in the atmosphere, yet its permanence argues a much greater solidity than that of a cloud. Wildt considers that at a relatively small depth, Jupiter's atmosphere must be compressed to a density equivalent to that of the liquid or solid state of its materials, and that at great depths even the permanent gases such as hydrogen and helium may become solidified by a pressure a million times that at the Earth's surface. The Red Spot may, therefore, be a solid body floating in

an ocean of permanent gases. A comparatively small change in the level of the Spot, Peek considers, could account for all its velocity and colour changes, and when it darkens appreciably its rotation period always seems to increase.

Phillips drew attention to the curious fact that while the Spot in general appears to repel surrounding matter, the Hollow being usually separated from it by a clear interval, yet it seems to attract the South Tropical Disturbance, either end of which markedly accelerates when approaching and is retarded when receding from the Spot.

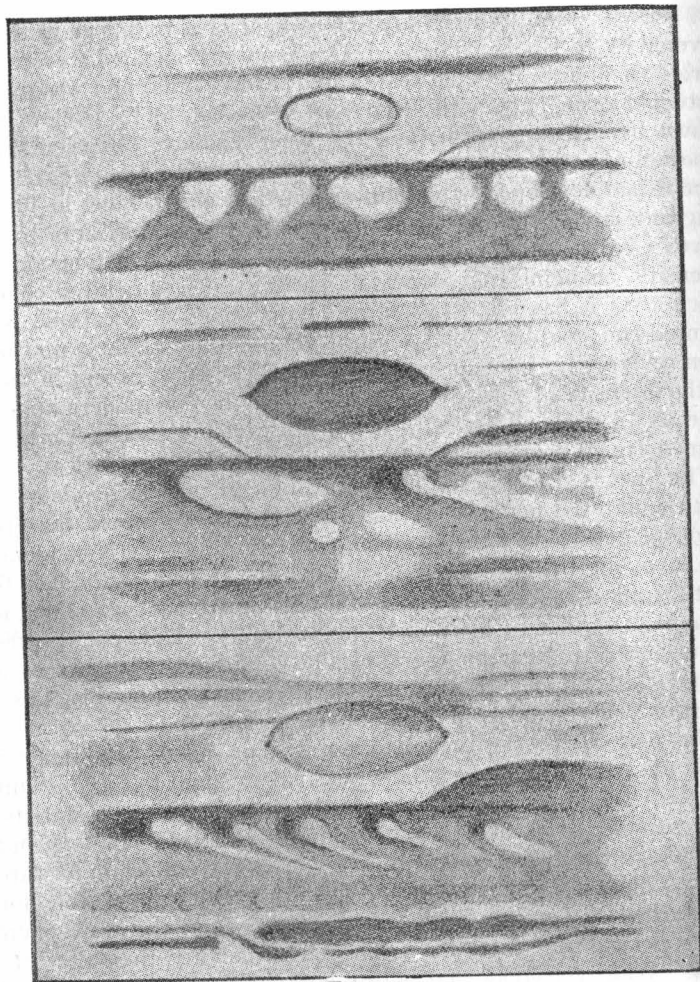

FIG. 53

Red Spot: *top*—J. Gledhill, January 23, 1870; *middle and lower*, after the Spot became prominent—W. F. Denning, about 1882 and October 11, 1886.

(From *Splendour of the Heavens*, Hutchinson)

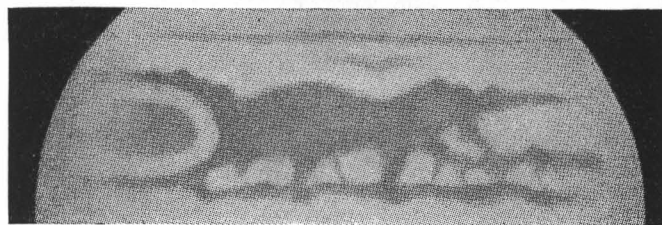

FIG. 54

E. M. Antoniadi's drawing, May 21, 1901, of the Red Spot in its Hollow and (to the right) part of the South Tropical Disturbance following it.

(From *Splendour of the Heavens*, Hutchinson)

*South Tropical Disturbance.* Though Dr. E. B. Knobel before 1890 observed a similar feature, the South Tropical Disturbance is generally considered to have started in 1901 with a dark marking across the zone which rapidly expanded in longitude. The Disturbance has since been a regular though intermittent feature of Jupiter, showing great changes in motion, extent, and shape. Formerly about  $25^\circ$  long, it has never extended over less than  $100^\circ$  of longitude when active since 1916, and since 1930 has exceeded  $200^\circ$ . The two ends have generally been well marked, dark, and concave, the rest often vague and confused. At first the ends of the Disturbance, rotating in 20 seconds less than the Red Spot, used to circulate round the planet and overtake that Spot again in two years. Conjunctions of Disturbance and Red Spot have since been less frequent but nine have occurred in forty years. When they meet the Disturbance temporarily pushes the Red Spot



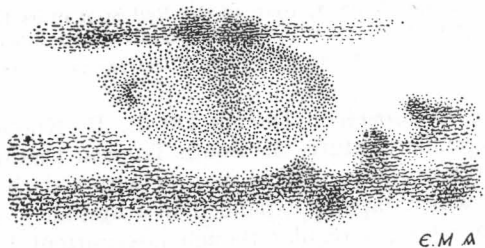
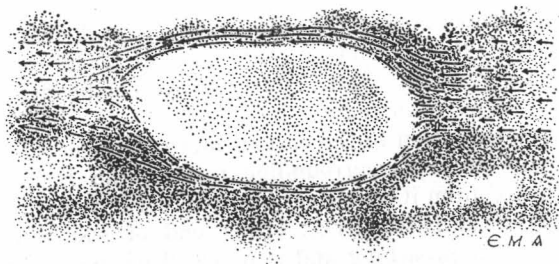

FIG. 55 [E. M. Antoniadi.]

Top: Antoniadi's diagram of the South Tropical Disturbance flowing round and accelerating the Red Spot. Middle and lower: his drawings (May 22 and July 7, 1911; Meudon 32½-in. O.G.) of the Red Spot and Hollow with south temperate belt above and double south equatorial belt below.

(From *Splendour of the Heavens*, Hutchinson)

forward while flowing round or below it. In years when the Disturbance, the Hollow, and most of the south equatorial belt have disappeared, the Red Spot has been more prominent. (See Appendix XI (4).)

*Circulating Current.* Spots are rarely found on Jupiter to move in latitude, and this lends unusual interest to the Circulating Current, discovered by the Jupiter Section's observers and described

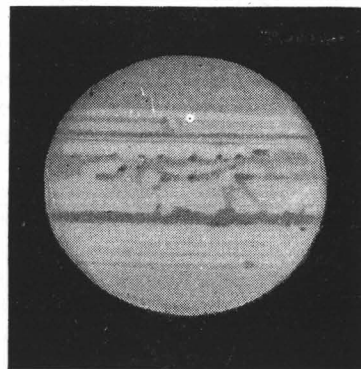

FIG. 56

B. M. PEEK

12-in. Spec. 1934 April 19

 $\omega_1 = 167^\circ$ ,  $\omega_2 = 5^\circ$ 

Above the middle is a row of the spots in the Circulating Current and to their right the 'smoke-stack' at the preceding end of the South Tropical Disturbance.

by B. M. Peek, when director. At intervals between 1919 and 1934, dark spots, starting near the following end of the Red Spot Hollow, appeared to drift *backward* along the *northern edge* of the

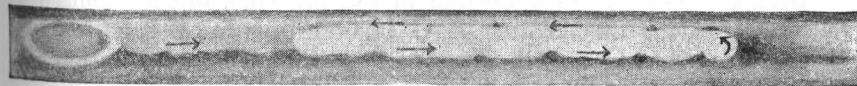

FIG. 57

T. E. R. Phillips's diagram of the Circulating Current between the two ends of the South Tropical Disturbance. The Red Spot and Hollow are to the left, in the Disturbance.

(British Astronomical Association, 29th *Jupiter Report*)

south tropical zone as far as the preceding end of the South Tropical Disturbance. Apparently this barred their progress, turning them *southward* across the zone, and reversed their motion, so that they

then moved *forward* along the *southern* edge of the zone. About 1930-4 this forward movement appeared to be along the track of a narrow horizontal belt like a smoke trail running from a vertical dark streak like a chimney (nicknamed 'the smoke-stack') at the front of the Disturbance. What happened to the spots when they reached the other end of the Disturbance and whether they were then diverted northward across the zone, completing their circuit, could not be observed. The Circulating Current extends only along the part of the zone not occupied by the Disturbance and therefore encounters the latter at both ends of its course.

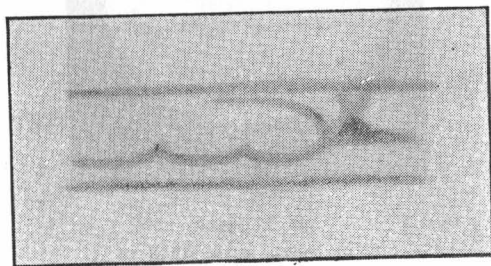

FIG. 58

The 'smoke-stack' drawn by B. M. Peek

*South equatorial belt upheavals.* Sometimes the southern component of the double south equatorial belt, along with the Red Spot Hollow, fades, almost vanishing for one to three years, and the South Tropical Disturbance dies down. Then comes a major outburst on the belt, heralding the return of the missing features. Such upheavals occurred in 1919-20, 1928-9, 1938, 1943, 1949, and 1952-3. They generally operate in two branches, one spreading forwards along the northern edge, the other backwards along the southern edge of the belt. They encircle the planet, meet again, and pass each other, preserving their original motion. The upheaval produces many spots, light and dark, and many rapid changes of detail. In 1928 the spots were at first deflected by the Red Spot, but when the latter faded they crossed right over the area without deflection. The reappearance of the preceding end of the South Tropical Disturbance, however, seemed to bar their progress. Irradiating bright spots, projecting beyond the terminator, formed part of this display.

R. A. McIntosh has described his individual impressions of a fifth notable upheaval (July-October 1949) as observed in New Zealand with a 14-inch aperture reflector: A small bright spot expanded in ten days spanning the space between the belt's components and  $10^\circ$  in longitude. About twenty more bright spots formed successively in the same place, following one another along the belt 'like pearls on a string.' A dusky shading filled the area round about them. Dark spots also appeared. The spots spread around the planet, the ends meeting in front of the Red Spot which blocked the dark material, turning it from the southern to the northern component with reversed motion. Matter moving along the northern component, however, seemed to pass the Red Spot with undiminished speed, round masses appearing flattened while passing. On reaching their starting place again, the clouds did not mix with those of the original 'cloud-belt,' but piled upon the northern side of the belt, moving in a narrow band along that edge. Dark blobs forming ahead of the advancing end of the upheaval moved rapidly backwards, passing over the bright spots at a higher level. At times material seemed to come from the adjoining equatorial zone to feed the disturbance. (See Appendix XI (5).)

*Rapid currents ; oscillating spots.* Phillips described spots occasionally seen on the southern edge of the north temperate belt as 'the swiftest current known on Jupiter,' their rotation period being 9 hours 49 minutes, seven minutes less than the normal for the region. While spots in one current sometimes seem influenced or even controlled by a neighbouring current, Peek drew attention to the anomaly in the north temperate region of two rapid belt currents, both often observed with a very slow current in the narrow zone between. Occasionally individual spots on Jupiter oscillate in longitude like the Red Spot, but on a much smaller scale.

*Atmosphere.* Very dark lines and bands in the spectra of Jupiter and the other great planets long puzzled astronomers until Wildt (1932) determined theoretically that these bands should be produced by ammonia ( $\text{NH}_3$ ) and methane ( $\text{CH}_4$ ), a conclusion completely verified by laboratory experiment and improved photography of spectra. Methane is a poisonous product of decaying vegetable matter encountered in marshes and coal-mines. Why should the great planets have atmospheres so unlike the Earth's? One cause

is extremely low temperature due to distance from the Sun, but the main reason is mass. This not only accounts for the depth and enormous pressure of their atmospheres, but explains why they must have retained all the gases originally there, including great quantities of hydrogen. Their 'velocities of escape' (on Jupiter 37 miles per second) are too great to lose even hydrogen, though it cannot be detected from their spectra, being masked by the strong lines of solar hydrogen.<sup>1</sup> If, as seems possible, they were once molten, Jupiter and the other giants probably had atmospheres mainly of hydrogen, with much helium and some water vapour, carbon oxides (chiefly monoxide), and nitrogen. As they cooled the following reactions would occur at successive temperature stages: the carbon oxides would combine with hydrogen, forming methane and water; then hydrogen and nitrogen would combine into ammonia; the water would condense to an ocean, absorbing some ammonia and ammonium salts; the ocean would freeze, and nearly all gases except hydrogen, helium, and methane would solidify out of the atmosphere. But on Jupiter, with a temperature of  $-216^{\circ}$  F. ( $-138^{\circ}$  C.), a certain amount of ammonia could stay in the atmosphere, partly as gas but mainly as droplets or crystals. These may cause the reddish colours, which may, however, be due to nitrogen dioxide or unusual sodium compounds or to minute solid metallic particles scattered in great quantities in the Jovian 'clouds.' Under the extraordinary conditions of pressure, solid particles and ammonia crystals may float in methane gas, liquid hydrogen on compressed helium gas, and in the depths of Jupiter's atmosphere there is probably no clear separation between gases in solid, liquid, and gaseous states. Surface markings are believed to arise from eruptions of dense viscous gases from below.

*Smaller satellites.* Jupiter's eight smaller moons have no names, merely the numbers V to XII. They range in magnitude from about 14 to 19, roughly 1,000 to 100,000 times fainter than Jupiter's four larger satellites. Jupiter V, discovered by Barnard (1892), is the nearest of all to the planet, 112,000 miles distant, about 100 miles in diameter, and circles round it in 12 hours. Far beyond the larger moons, at distances of about 7 million miles and with revolution periods about 250 days, there is a group of three little

<sup>1</sup> Moreover absorption lines of cool hydrogen would only occur far in the ultra-violet of the spectrum and be blocked by the terrestrial atmosphere.

satellites: Jupiter VI and VII, discovered by Perrine (1904, 1905), and Jupiter X, discovered by S. B. Nicholson (1938). These three cannot collide as they all have highly inclined orbits in different planes. Another group of three is found at about 14 million miles from Jupiter, taking 700 to 750 days to circle round it; the first two of these also have greatly inclined orbits. This group comprises Jupiter VIII, discovered by P. J. Melotte (1908), and Jupiter IX and XI, discovered by Nicholson (1914, 1938). All these seven have very eccentric orbits and are very small, IX, X, and XI being probably a mere few miles in diameter and X is visible only on photographs taken with very large telescopes. Jupiter VIII, IX, and XI have retrograde motion round their planet like Saturn's Phoebe and were once thought to be captured asteroids, but this theory is no longer favoured. Jupiter XII, magnitude 18.3, some 13 million miles from the planet—moving in a nearly circular but highly inclined and retrograde orbit—was detected by Nicholson on plates taken on 1951 September 29 and October 24 with the Mount Wilson 100-inch telescope. Nicholson, like Galileo, has thus discovered four Jovian satellites.

*Galilean satellites: dimensions and phenomena.* Io, Europa, Ganymede, and Callisto (Jupiter I to IV) are called the 'Galilean' satellites because Galileo discovered them. Their respective distances from Jupiter are about 260,000, 417,000, 665,000, and 1,176,000 miles: from one to five times the Moon's distance from the Earth. But they have to circle round much faster than the Moon does, their revolution periods ranging from  $1\frac{3}{4}$  to  $16\frac{1}{2}$  days. Io a little over, Europa a little under, 2,000 miles in diameter are similar in size to the Moon; Ganymede and Callisto, each more than 3,000 miles in diameter, are slightly larger but much less massive than Mercury. They would be visible to the unaided eye were they farther from Jupiter's glare, as their brightness varies around mean magnitudes of about 5 to 6. Brightness and approximate alignment with Jupiter's equator make them easy to find with small telescopes, and their rapid changes of position are fascinating to amateur astronomers.

These moons are frequently occulted or eclipsed by Jupiter or in transit across the planet's disk accompanied by their round black shadows, and occasionally one satellite eclipses another. The different directions, except at opposition, of Sun and Earth from



Jupiter, can cause a satellite to disappear, eclipsed by the planet, when well outside Jupiter's limb, or to cross the planet's disk far from or overlapping its own shadow, or the shadow to be crossing when the satellite is not. Unless in front of a dark belt or very close to the limb, satellites are much harder to detect on the disk than their shadows. The predicted dates and times of these

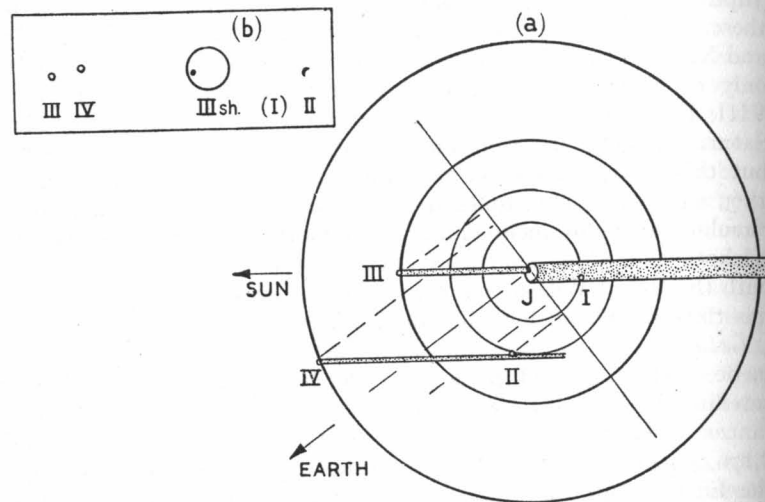

FIG. 59

A hypothetical situation of the Galilean satellites: (a) in plan—radii of orbits approximately to scale (28 : 45 : 72 : 126); (b) as seen from the Earth: shadow of III in transit; I eclipsed by Jupiter; II partially eclipsed by IV (large aperture could show this).

phenomena for each year are given in the *B.A.A. Handbook*, and transits and occultations can be watched with a fairly small telescope. But a large instrument is needed to see a satellite's disk markings or its shape when partially eclipsed by another or partially occulted by Jupiter.

The Galilean satellites rendered one distinguished service to science. From the variation in the time intervals between successive eclipses of each satellite Olaus Roemer in 1675 deduced that light,

previously thought to move instantaneously, must take a finite time to traverse the diameter of the Earth's orbit.<sup>1</sup>

*Galilean satellites: mass, surface markings.* Ganymede is about

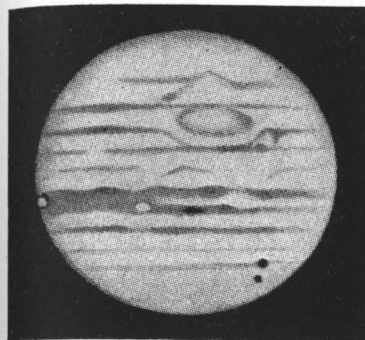

FIG. 60

T. E. R. PHILLIPS

18-in. Spec. 1933 March 9

 $\omega_1 = 129^\circ$ ,  $\omega_2 = 185^\circ$ 

By the limb (*left*) Sat. I (Io) is partly occulting its shadow. On the disk also (*lower right*) are Sat. IV (Callisto) and its shadow. The Red Spot is seen above and to the right of the centre. Eight belts (two double) are shown.

(British Astronomical Association, *29th Jupiter Report*.)



FIG. 61

B. M. PEEK

12-in. Spec. 1927 October 10

 $\omega_1 = 222^\circ$ ,  $\omega_2 = 242^\circ$ 

The black spot cutting the south limb (*top*) is Sat. IV's shadow. The black spot on the right is the shadow of Sat. I, which is also seen in transit as a faint grey spot some way left of its shadow. The north equatorial belt is disturbed, but the south equatorial belt is quiet and its south (upper) component is missing. The loop in the South Tropical Zone (*upper left*) is an object nicknamed the 'false Red Spot.'

twice as massive as the Moon; the other three are similar to the Moon in mass, Europa being the least massive. Callisto, nearly as large as Ganymede, has about  $\frac{2}{3}$  its mass and a mean density 1.3 times that of water. These satellites, perhaps rocky like the Moon, but much better reflectors, may be thickly coated with frozen gases. Ability to retain an atmosphere is based on mass and low temperature combined, Ganymede ranking next after the planets with known atmospheres. Pic du Midi observations by Lyot and others have confirmed the formation of white veils on Ganymede,

<sup>1</sup> See pages 370, 422.

possibly indicating an atmosphere, but there is no evidence yet of an atmosphere on Callisto.

At the Pic du Midi Observatory during September–October 1941

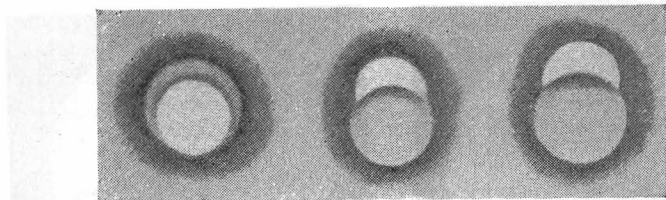

FIG. 62

Left: Occultation of Sat. IV by Sat. II, 1932 January 8—T. E. R. PHILLIPS.  
Centre: Occultation of Sat. I by Sat. IV, 1932 February 18—B. M. PEEK.  
Right: Same as centre—T. E. R. PHILLIPS.

Note the duskiertone of IV (Callisto)

(British Astronomical Association, 29th *Jupiter Report*)

H. Camichel, M. Gentili, and B. Lyot, in very favourable seeing conditions, independently made 245 disk drawings of the Galilean satellites, using a telescope with object-glass 38 cm. in diameter and magnifications of 500 and 900. They found Europa white and very

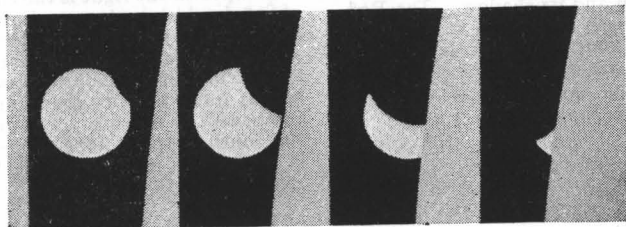
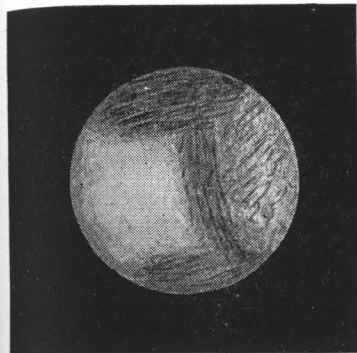

FIG. 63

Eclipse of Sat. I by IV during occultation of I by Jupiter, 1932 February 18—W. H. STEAVENSON. Left at 9 hrs. 34.3 min.; others at intervals of 1 min. after.  
(British Astronomical Association, 29th *Jupiter Report*)

brilliant; Io appreciably larger than Europa but paler and yellowish; Callisto much larger than Io but of very weak lustre and dull chestnut tint; Ganymede, the largest, like Io in brightness and colour. They arranged the drawings of each satellite in order of longitude on its orbit and by comparing the positions of surface markings,



(a)

I (Io)

1941 October 8

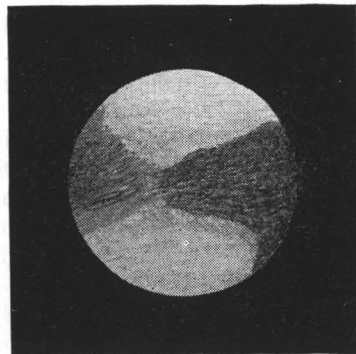

(b)

II (EUROPA)

1941 September 26



(c)

III (GANYMEDÉ)

1941 September 20

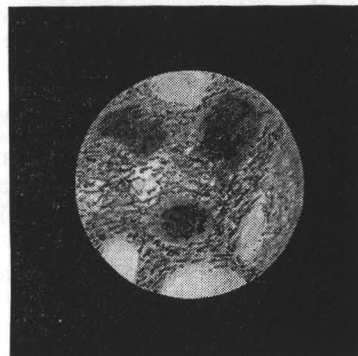

(d)

IV (CALLISTO)

1941 September 23

FIG. 64

From sketches by H. Camichel, M. Gentili, and B. Lyot, Pic du Midi Observatory

(By permission of Société Astronomique de France, from *Bulletin*, April 1943)

concluded that all these four moons revolve round Jupiter with axis approximately perpendicular to orbit-plane, and that the revolution period of each is about equal to its rotation period. These

satellites therefore may keep the same side always facing Jupiter as the Moon does to the Earth.

Maps based on the drawings show that Io has darkish poles (making it look elongated when in transit), but several light areas along the equator separated by dusky north-south bands, while Europa has light poles but a wide dusky equatorial belt with three dark spots on the equator. Ganymede has two white areas, a little eccentric, near the poles, the larger by the north pole, and two dark belts parallel to the equator with at least two dark spots on each; the darkest spot adjoins the white north polar area. Callisto, similarly to Ganymede, has a little white cap at the south pole and small light patches near the north pole, one rather brilliant, but no dark spot of definite longitude in the dusky equatorial region.

The Pic du Midi observers afterwards compared their results with those of previous observers, including Holden, Barnard, Antoniadi, and W. H. Pickering, and found many points of agreement, especially on Io and Ganymede, while one of the dark spots detected on Europa corresponded with one found (1927) by Antoniadi. (See Appendix XI, p. 507.)

### SATURN

*Vanishing rings.* Galileo was puzzled. Pointing his newly invented telescope at Saturn, he saw, not one globe but three in a row. About a year afterwards he had another surprise: the smaller flanking globes had vanished. The following year they reappeared. Thus early did Saturn, by optical tricks and startling changes, begin to perplex astronomers.

This first enigma was due to the imperfections of primitive telescopes, which could not show a true image of the planet's rings. The wide 'ansae' (handles) of the rings appeared to some observers as smaller globes, either attached or self-contained; to others as bright 'ears' or 'handles' at the planet's sides. Huyghens (1656) solved the mystery, publishing the result in 1659, saying that Saturn was girdled by 'a flat ring nowhere touching the planet.' This ring is now known to comprise at least three concentric rings.

Their disappearance and reappearance, so mystifying to Galileo, arise from their changing aspect, as viewed from the Earth. Every fifteen years these thin, flat appendages come into line with the Earth, seeming to close to an edgewise position, being then hard to

detect even with the largest modern telescopes. Occasionally they vanish completely for a day or so. This can occur when they are exactly edgewise to the Earth, or edgewise to the Sun, so that only their fringe is illuminated, or when the Sun shines obliquely on one

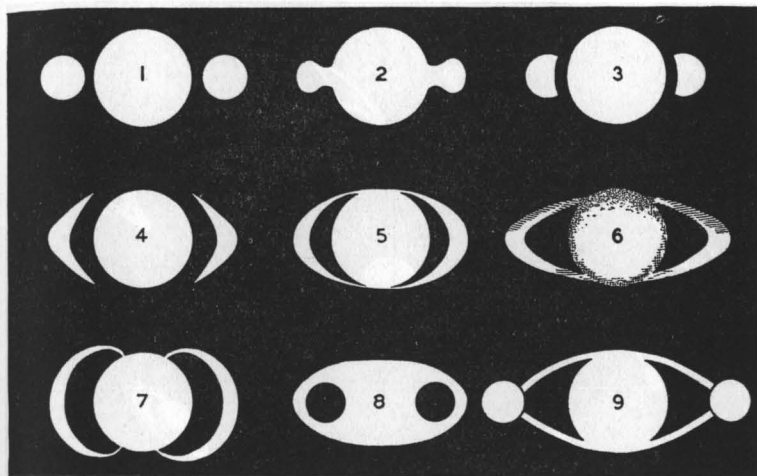

FIG. 65

Early seventeenth-century Saturn drawings: 1. GALILEO, etc. (1610); 2. SCHEINER (1614); 3. GASSENDI (1645); 4. HEVELIUS (diagram); 5. RICCIOLI (1648-9); 6. DIVINI (1646-8); 7. FONTANA (1639); RICCIOLI (1646); 8. BIANCANI (1616); GASSENDI (1638-9, 1646); 9. FONTANA, etc. (1644-5).

(From Huyghens's *Systema Saturnium* and Hutchinson's *Splendour of the Heavens*.)

face of the rings and observers have a very oblique view of the other face.

Saturn's orbit is tilted  $2\frac{1}{2}^\circ$  to the Earth's orbit-plane. Hence Earth and Sun are generally at different elevations above or below the ring-plane, sometimes the Earth higher, sometimes the Sun, and occasionally even situated one above it, the other below.

*Opening and closing of the rings.* Like the Earth, Saturn moves around the Sun with axis not vertical to its orbit-plane but tilted. The rings are exactly in the plane of Saturn's equator, which is inclined about  $28^\circ$  to the Earth's orbit-plane and remains fixed with



reference to the stars as Saturn travels around the Sun. Thus from the Earth, which is much nearer the Sun, the rings are viewed at an ever-changing angle, from above, edgewise, from below, edgewise again, successively.

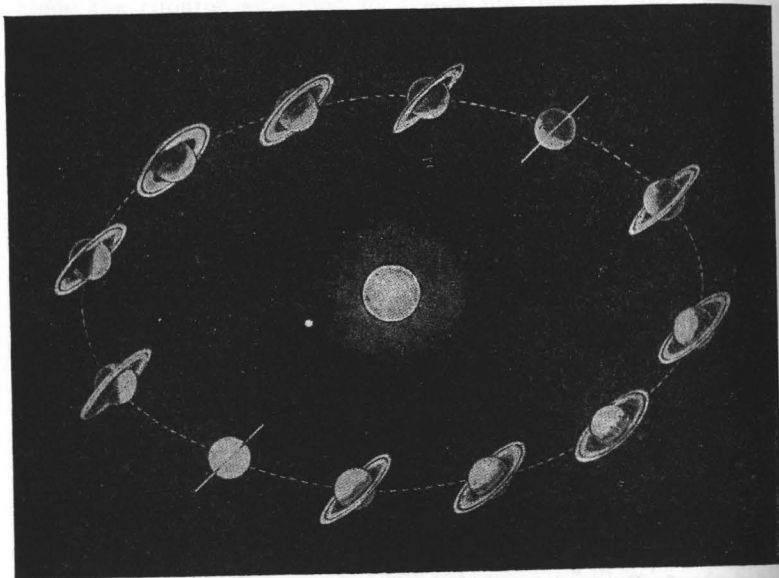

FIG. 66

Huyghens's explanation of the changing aspect of Saturn's rings.

(From Huyghens's *Systema Saturnium* and M. Davidson's *From Atoms to Stars* (Hutchinson, 1952).)

In 1936 the planet's equator was practically in line with Earth and Sun, so the rings appeared edgewise. Thereafter Saturn's south pole turning more and more towards Earth and Sun, the rings appeared to open out wider until, by 1943, they were hiding the planet's northern hemisphere from view, and the far edge of the outer ring could be seen beyond Saturn's south pole. From 1943 to 1950 this process was reversed, the tilt appearing to lessen, the rings narrowing, disclosing more and more of the northern hemisphere, and becoming edgewise again in 1950-1.

During the next seven years the rings will open out on the reverse

side, gradually covering the planet's southern hemisphere, Saturn's north pole being turned more and more towards Earth and Sun, and the far edge of the outer ring projecting beyond that pole in 1958. Another closing up will bring back the edgewise position by 1966. Then the whole sequence will begin again.

If it had a flat ring in the plane of its equator the Earth would give a similar performance (from the Sun's viewpoint) though in 1 year instead of 29½ years. The terrestrial ring would be edgewise to the Sun about 21st March and 23rd September; it would appear to open out and hide the southern hemisphere from the Sun from March to June, gradually closing again from June to September. A similar opening out and veiling of most of the sunlight from the northern hemisphere (September to December) would be followed by a gradual reversal (December to March).

The opening and closing of Saturn's rings is therefore analogous to the seasons on Earth, important differences being: Saturn's rings, and its remoteness from the Sun, making its seasons thirty times as long, and all unutterably cold.

Major P. H. Hepburn, a former director of the B.A.A. Saturn Section, suggested a simple model to demonstrate the ring positions, made from an orange, a penknife, a flat, circular cardboard ring, and a block of wood, as shown

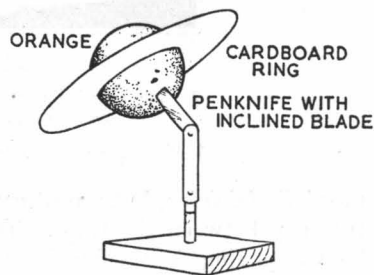

FIG. 67

P. H. Hepburn's model (Hutchinson: *Splendour of the Heavens*)

in the illustration. If the model is placed at eye-level, the observer, by walking round it, will see the whole cycle of ring positions roughly reproduced.

*Some early discoveries.* Huyghens, who first recognized the ring, also noticed that Saturn like Jupiter had dusky belts parallel to its equator, and once counted as many as five. He (1655) discovered Titan, Saturn's largest and brightest moon. Hadley<sup>1</sup> observed changes in the shape and number of the belts on the globe, and that the ring seemed thinner at its outer edge, and that globe and ring cast shadows upon each other.

From changes in the belts Halley deduced that Saturn rotates

<sup>1</sup> According to R. A. Proctor, in *Saturn and its System*, page 57.

on an axis perpendicular to the ring-plane. Maraldi made a clever observation (1714) just before the rings vanished. He noticed the two ansae alternately disappearing, and inferred that the ring-system rotates in its own plane about Saturn.

*Cassini's discoveries.* Meanwhile J. D. Cassini had drawn attention (1675) to the ring being 'divided by a dark line into two equal parts, of which the interior and nearer one to the globe was very bright, and the exterior part slightly dark.' The dark line is called



FIG. 68

J. D. Cassini's 1676 drawing, the first showing Cassini's division

(From *Splendour of the Heavens*, Hutchinsonson)

*Cassini's Division*, but a century passed before it was accepted as a true gap between the rings. The greyish-white outer ring is now known as ring A, the brilliantly white one inside the division as ring B. Cassini discovered (1671-84) four moons and, being attached to Paris Observatory, wished to call them after Louis XIV. Fortunately they bear the more poetic names of Iapetus, Rhea, Dione, and Tethys. Cassini noticed the great variation in brightness of Iapetus, inferring that half the surface must reflect better than the other half, and that Iapetus probably always keeps the same face towards Saturn (as the Moon does to the Earth), an opinion supported by Newton and later by Herschel.

Cassini's son Jacques, and Thomas Wright of Durham, made the far-seeing suggestion that the rings might be composed of small satellites.

*Herschel's discoveries.* By carefully measuring the position and width of Cassini's division on both faces of the rings and showing that the measurements agreed, William Herschel proved it to be a

gap right through the ring-system. This was but one of a splendid list of achievements. He found that ring B was wider than A. He thought he glimpsed, as had Cassini and Hadley, other fainter ring divisions, but with his usual caution said they needed more confirmation. He discovered the two faint innermost satellites,

Mimas and Enceladus. By timing successive appearances of spots he made a good estimate of the rotation period. He noted a variation in brightness of the polar regions, finding each pole whiter after being turned away from the Sun for some years and darkening while tilted towards the Sun. But he held that nearly a century of such observations was needed to establish the regularity of the change. He concluded (1790) that the rings were very thin and made one of the first estimates of their thickness. Noticing that as satellites disappeared behind the globe their light seemed to fade gradually, he inferred that Saturn had an atmosphere.

*The crepe ring.* Almost the only important feature overlooked by Herschel was the crepe ring, which he drew (1793) but doubtless assumed to be a belt. This almost transparent, innermost ring is also traceable on drawings by Campani (1664), Picard (1673), and Hadley (1720). It was probably first seen as a ring, being traced in the ansae as well as across the globe (1828) by an assistant at Rome Observatory. But this discovery passed unnoticed, as did Galle's accurate measurement (1838) of the width. So the credit went to Bond (in America) and Dawes (in England) for independently rediscovering ring C (1850). Lassell suggested the name by remarking, when shown ring C by Dawes, that it was 'something like a crepe veil covering a part of the sky within the inner ring.'

*Appearance and colours.* To naked-eye observers Saturn looks like a bright star with softer, creamier lustre than the brilliant Venus and Jupiter. Through a telescope it has a most beautiful

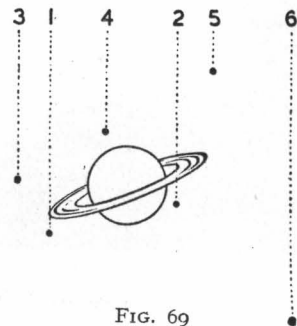

FIG. 69

Saturn and its six inner moons:  
1. MIMAS; 2. ENCELADUS; 3.  
TETHYS; 4. DIONE; 5. RHEA;  
6. TITAN

(From R. A. Proctor's *Saturn and its System* (Chatto & Windus, 1882).)

and wonderful appearance with its delicate tints and shadings and amazing ring; clear in its perfect outline, yet seeming to melt at the edges into the sky. The brightest features usually are the brilliant white outer part of ring B and the equatorial zone. (The light areas of the globe are called zones; the dusky stripes belts.) Ring A seems greyish-white, the crepe ring blue-grey or slate, the south equatorial belt a soft orange-brown; sometimes one of the

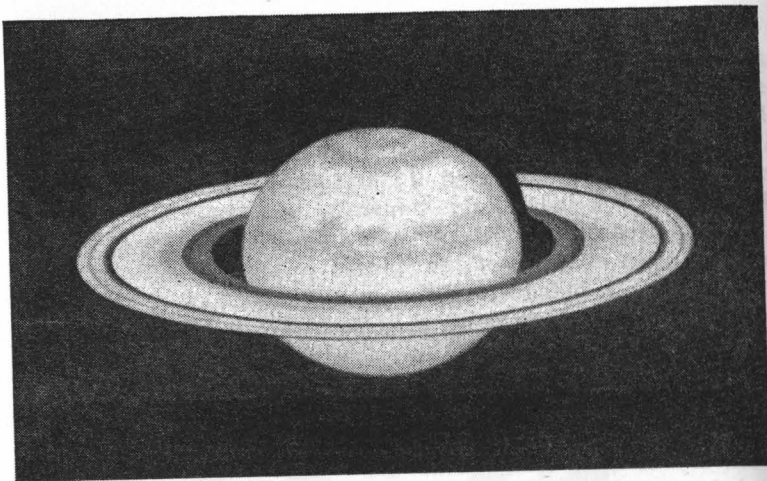

FIG. 70

S. MURAYAMA (Tokio). 8-in. O.G. 1948 March 30  
Shows crepe ring, Encke's and Cassini's divisions, the globe's shadow across the rings, and the south equatorial belt delicately shaded.

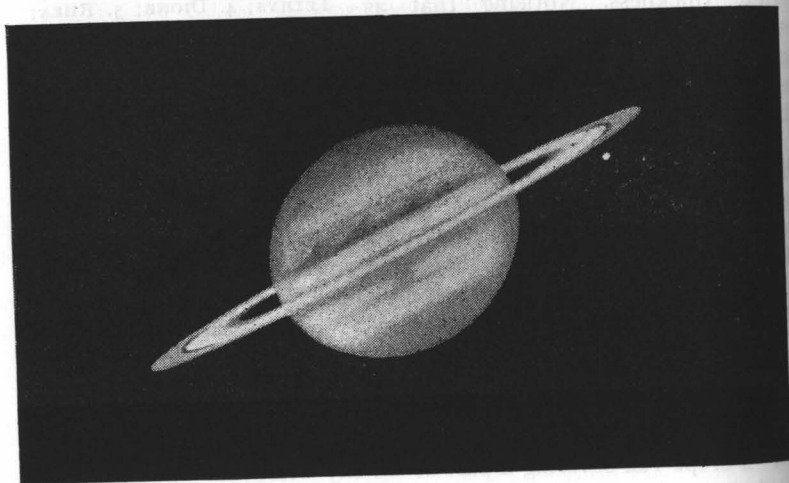

FIG. 71

L. F. BALL. 10-in. Spec. 1950 March 9  
Shows belt shadings, a satellite, and the duskiness of the polar regions. Cassini's division is visible only in the ansae of the narrowing rings.

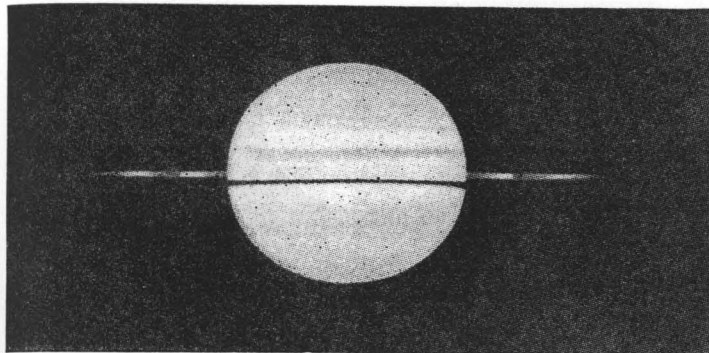

FIG. 72

W. H. STEAVENSON. Greenwich 28-in. O.G. November 16, 1920, about nine days after the plane of the rings passed through the Earth. The ring's unilluminated face is seen faintly by sunlight penetrating through the rings, appearing segmented and with a delicacy of shading the observer said was impossible to reproduce exactly.

polar areas is yellowish, the other greenish. The globe's usual tone is cream or yellow. When the rings are open, the satellites are seen above, below, or alongside the planet, and transits (crossings in front) and occultations (disappearances behind) do not occur, but there are many of both for about two years when the rings are nearly edgewise. Then the rings have sometimes appeared cut up into bright segments, which may be thicker parts, and the innermost moons, passing directly before or behind the edgewise rings, can present the beautiful spectacle (in large telescopes) of jewels threaded on a golden wire.

*Visibility.* Saturn's disk, the ring (when open), and Titan can be seen with very small telescopes, perhaps even with strong binoculars. But for details on the globe and ring-system a telescope of at least



5 inches in aperture is needed, and one much larger for fine detail, especially when the rings are edgewise. Cassini's division, easily seen as a black curve in each ansa, is much more difficult to trace along the front of the rings, even when they are rather open. Rhea and Iapetus (at brightest) are visible with a 3-inch, Dione and Tethys with a 4-inch, aperture; the other moons require larger telescopes.

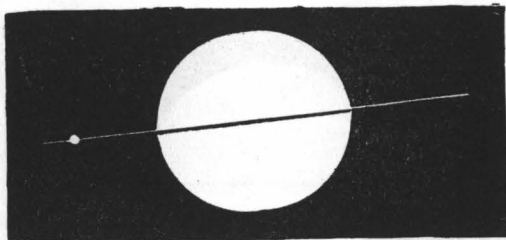

FIG. 73

H. P. WILKINS. March 2, 1921. Dione on the line of the edgewise rings approaching the planet, to be eclipsed 2 hrs. 10 min. later.

*Shadows.* Optical illusions; distortions by Saturn's atmosphere; ring irregularities of surface, brightness, and thickness: all these have been suggested to explain the queer shadow effects. The globe casts a black shadow athwart the far part of the rings adjacent to it as if a slice had been cut out right across the rings. As the Earth passes Saturn at opposition this shadow crosses behind the globe to appear at its other side, but the illusion of a thin line of shadow lingers temporarily on the original side. Also the shadow's outline across the rings sometimes looks distorted and, by a contrast effect, a small patch of the rings adjoining the shadow may seem brighter than all the rest.

Equally intriguing is the shadow of the bright rings on the globe. According to the positions of Earth and Sun it sometimes adjoins the outer edge of ring A, sometimes is hidden by the rings, sometimes mingles with the crepe ring and its faint shadow, and often looks widest at its extremities. When the rings are edgewise and barely visible the ring shadow across the globe is sharpest and blackest, being cast by the rings in maximum depth.

*Dimensions.* Saturn, second largest of the planets, has a diameter of 75,100 miles at the equator, but only 67,200 miles if measured from pole to pole. The globe therefore bulges at the equator and is even more flattened at the poles than Jupiter. The ring-system is on a colossal scale, spanning 169,300 miles from tip to tip: more than twenty-one times the Earth's diameter. The Earth could easily fit between Saturn's globe and the inside edge of the rings:

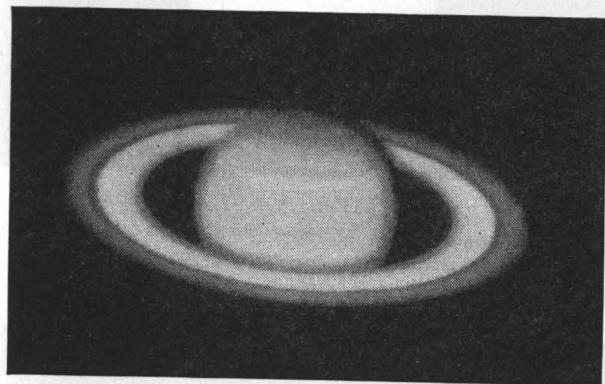

FIG. 74

Photograph by H. Camichel, Pic du Midi Observatory. 1946 February 11.

The rings are wide open, covering the northern hemisphere. The globe's shadow on the rings and Cassini's division are very distinct, and the contrast in brightness between rings A and B is striking.

the gap is nearly 9,000 miles wide. The crepe ring's width is 10,000 miles; that of ring B 16,500 miles; of Cassini's division nearly 1,800 miles; of ring A 10,000 miles.

The extraordinary thing about the rings is their extreme thinness. William Herschel's estimate (1790) was only 856 miles, yet subsequent authorities have reduced this more and more: Schröter (1808), 539 miles; Sir John Herschel (about 1850), less than 220 miles; W. and G. Bond (1857), less than 43 miles; more recently, H. N. Russell, less than 13 miles; and Dr. Bell, less than 10 miles. Bell based his calculation on the visibility of bright thin lines on a dark background and of small, highly reflecting satellites, taking into account the doubtful visibility, even in the largest telescopes,

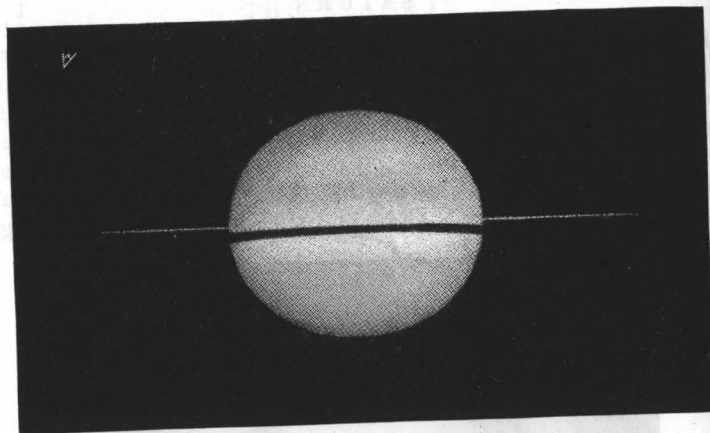

FIG. 75

E. M. ANTONIADI. 1936 July 2. The edgewise rings and their black shadow.  
(British Astronomical Association, *Journal*, 47, 7, May 1937)

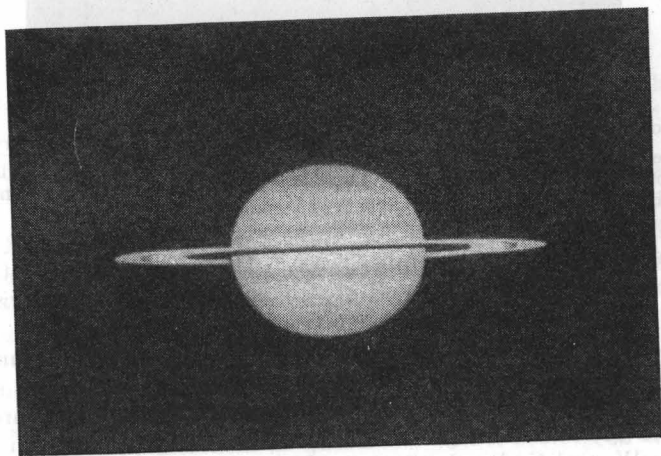

FIG. 76

S. MURAYAMA (Tokio). 8-in. Spec. 1950 April 10. The rings almost edgewise, but a glimpse of Cassini's division in the ansae. Several belts and the shadow of the rings can be seen.

of the rings when exactly edgewise. *In proportion* to their immense size the rings are much thinner than a sheet of foolscap paper is *in relation to its surface area*.

*Distance, year, day.* The orbit being elliptical, Saturn's distance from the Sun ranges from 841 million to 931 million miles, the mean being 886 million miles, and the planet takes  $29\frac{1}{2}$  years to travel round the Sun. To reach one's third birthday on Saturn a long life would be needed. From the high degree of flattening a rapid rotation can be inferred, and in the equatorial region Saturn spins at 23,000 miles an hour, the rotation period (or day) being 10 hours 14 minutes, not much longer than Jupiter's, so some 25,000 brief days make up a Saturnian year. On Saturn's globe, rotation periods increase steadily with latitude to nearly an hour longer at  $57^\circ$  than at the equator, showing that the markings observed are atmospheric, not surface features.

It is very convenient for observers that Saturn rotates seven times in about twenty minutes less than three days; any unusual feature should be in nearly the same position at almost the same time every third day.

*Mass, density, temperature, atmosphere.* Saturn's volume is 734 times the Earth's, but its mass is only 95 times the Earth's mass. Consequently it is the least dense of all the planets, having only half Jupiter's density, and only  $\frac{7}{10}$  that of water. This is below that of any known solid except lithium, similar in fact to the density of newly fallen, unpacked snow. The startling deduction is that if Saturn were a wholly solid body it would float in water even more easily than pumice does. Hence the solid part may be much smaller than it appears. Wildt's estimate of diameter of the metallic rocky core is 28,000 miles, within a layer of ammoniated ice 6,000 miles thick and an atmosphere 16,000 miles deep.<sup>1</sup> Though the rate of spin is less than Jupiter's, the concentration of mass to the centre is even greater than for Jupiter, and that is why the polar flattening is so extreme.

The spectrum shows that Saturn's atmosphere is a poisonous one like Jupiter's, but containing less ammonia and more methane. As the temperature is believed to be  $-243^\circ\text{F}$ . ( $-153^\circ\text{C}$ .), about  $27^\circ\text{F}$ ., ( $15^\circ\text{C}$ .) colder than Jupiter's, more of the ammonia has probably been frozen out of Saturn's atmosphere.

<sup>1</sup> But see page 149.

*Resemblances to Jupiter.* It is evident that, apart from its unique ring, the resemblances of Saturn to Jupiter are very striking: in size, shape, shifting cloud-belts parallel to the equator, colours, and general appearance of the globe; in temperature and atmosphere; in rapid and differential rotation; and also in having a large family of satellites; and in hydrogen content.

*Nine and a half.* Almost the only resemblance of Saturn to the Earth is the tilt of its axis. But there is a numerical relationship, a pure coincidence but a useful aid to memory: Saturn's mean diameter is  $9\frac{1}{2}$  times the Earth's; it is  $9\frac{1}{2}$  times as far from the Sun; its mass is 95 times the Earth's mass; and its year is  $29\frac{1}{2}$  years.

*Nature of the rings.* For two centuries after discovery the bright rings were generally believed to be solid, rigid, and opaque. The finding of the crepe ring raised doubts: through its filmy transparency the edge of the globe was seen undistorted; so Bond revived Jacques Cassini's theory of small satellites to explain this ring. Moreover several nineteenth-century observers detected faint divisions in the rings, as Cassini and Herschel had done. Though impermanent, except possibly Encke's division in the outer part of ring A, these faint lines parallel to the ring edges suggested gaps or cracks rather than shadows due to surface irregularities.

But it was the mathematicians who 'shattered' the rings. Laplace had already shown that the planet's pull would disrupt solid rings unless they were very narrow, eccentrically placed, and unequally weighted in their various parts: an arrangement that seemed too artificial to exist. J. Clerk Maxwell (1857) proved mathematically that the rings could be neither solid nor fluid without going to pieces. His conclusion was: 'The only system of rings which can exist is one composed of an indefinite number of particles, revolving round the planet with different velocities according to their respective distances.' These particles could be solid or liquid, he said, provided that they were independent; Jacques Cassini's theory was upheld.

*Spectroscopic proof.* Keeler (1895) proved Maxwell's conclusion by the spectrum, which he photographed with the slit parallel to the major axis of the rings. The lines of the spectrum of half the globe and rings were slightly displaced towards the blue, indicating approach; those of the other half of both towards the red, indicating recession; so both globe and rings were rotating. But the displace-

ments varied in amount, all the lines being slanting, and the displacements were greatest for the inner edge of ring B. This made it evident not only that the rings were rotating faster than the globe, but that the inner edge of ring B was rotating faster (by  $2\frac{1}{2}$  miles a second) than the outside of ring A in accordance with Kepler's third law, proving that the rings must consist of multitudes of separate particles.

*Nature of the ring particles.* H. Struve calculated that if the total mass of the rings were as much as  $\frac{1}{27000}$  of the mass of the planet, they would disturb the movements of Saturn's inner satellites. Clerk Maxwell worked out the average density of the rings at less than  $\frac{1}{300}$  of the density of Saturn. Moreover any material when pulverized reflects far better than it does in large pieces and observa-

tion shows that the brighter rings reflect light much better than rock surfaces do. The ring particles must therefore be small: bits of rock, pebbles, and dust less fine than white flour, or perhaps even minute ice crystals.<sup>1</sup> Revolving in a huge swarm round Saturn, they would tend by collisions to grind one another to powder. There has been much discussion whether the greater brilliance of ring B is due to its particles being more tightly packed than those in the other rings, or more finely powdered but equally sparse, or of a more highly reflecting substance.

*Reason for ring divisions.* The American astronomer Kirkwood suggested that the reason why there were gaps at certain distances from the Sun in the belt of asteroids, was that the revolution

<sup>1</sup> The reflection spectrum of the rings is similar to that of Mars's polar caps.

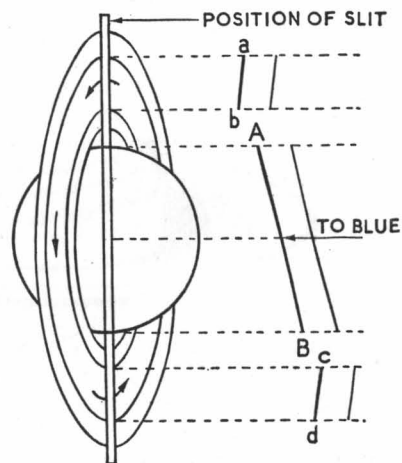

FIG. 77

The shifts and slants of the spectral lines *ab*, *AB*, and *cd* show that the globe and rings rotate, the rings faster than the globe and the inner edge of ring B faster than its outer edge.

(Spencer Jones's *General Astronomy* (Edward Arnold & Co.).)



periods of small bodies in those situations would cause them to be pulled out of their orbits by Jupiter. The same argument explains the divisions in Saturn's rings. A particle in Cassini's division would have a revolution period half that of Mimas, one-third that of Enceladus, one quarter that of Tethys. Hence one or other of these inner satellites of Saturn would pull upon the particle about every 11 or 22 hours, forcing it into a different orbit out of Cassini's

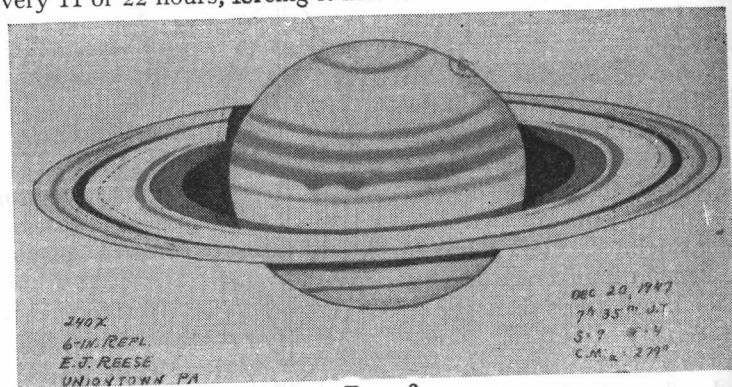

FIG. 78

E. J. Reese (a skilful American amateur) here shows a minor division in ring B, Cassini's and Encke's divisions, the crepe ring, globe and ring shadows, brighter areas, and several belts.

division into one of the adjoining rings. A similar argument applies less strongly to the junction of rings C and B, to perhaps six concentric circles within ring B and three in the outer part of ring A, one of which corresponds to Encke's division. Theoretically divisions might be expected in these places, and the perturbing effect of Mimas, only 30,000 miles outside ring A, must be very strong. Since 1942 American observers have fairly often glimpsed in the ansae a gap between rings B and C, and two faint divisions in ring B, as well as Encke's in ring A. (See Appendix XI (7).)

*Translucency of the rings.* Their solidity demolished by mathematics and the spectroscope, are the bright rings at least opaque? No, even this illusion was dispelled by skilful observations. On examining photographs of Saturn taken at Mount Wilson and Lowell Observatories, Hepburn found (1914) the globe visible

through ring A, but some doubted this interpretation. Observational proof came on February 9, 1917, when two B.A.A. members, Instructor-Captain M. A. Ainslie with a 9-inch aperture reflector and J. Knight with a 5-inch refractor, independently watched a star cross behind ring A from the inner to the outer edge. It was dimmed but remained visible throughout, twice brightening a little as it passed behind faint divisions of the ring.

On March 14, 1920, W. Reid, D. G. McIntyre, and others at Rondebosch, S. Africa, watched an orange-coloured star greatly dimmed crossing behind ring B, and were even able to see it for some distance behind the limb of the globe. The observation, made with a 6-inch refractor, proved that the brightest ring is translucent and that the outer part of the globe is atmospheric.

*Suspected spread of rings.* Otto Struve considered that the width of the bright rings was gradually but continuously increasing by the approach of the inner edge to Saturn's equator. Estimates of this width indicated an increase of over 4,500 miles in two centuries, while successive estimates of their thickness lessened. The crepe ring seemed to improve in its visibility. R. A. Proctor surmised that the rings might be spreading; the inner, duskier part of ring B might become a new crepe ring, and ring C become gradually wider and/or brighter. It may take centuries to test this theory. But several observers claimed to have detected (1907-8) a very faint dusky ring outside ring A, so transparent as to be usually invisible.

*Satellites.* The inner satellites: Mimas, Enceladus, Tethys, Dione, and Rhea range in distance from Saturn, from 113,000 to 330,000 miles, in revolution period from  $22\frac{1}{2}$  hours to  $4\frac{1}{2}$  days, and in estimated diameter from about 400 to 1,100 miles. Of these Rhea is the largest, brightest (magnitude 10), and most distant from Saturn. Titan,<sup>1</sup> which moves round Saturn in 16 days at a distance of 760,000 miles, is believed to exceed 3,500 miles in diameter: larger than Mercury and nearly twice the Moon's mass. Kuiper found (1944) from Titan's spectrum an atmosphere of methane. Bond discovered (1848) Hyperion, nearly a million miles from Saturn, with a period of 21 days and magnitude 15. The mean distance of Iapetus exceeds 2 million miles and its period is  $79\frac{1}{3}$  days. When at western elongation Iapetus outshines Rhea; at eastern elongation it is fainter than Tethys: a variation between about magnitudes

<sup>1</sup> See Appendix XI (8).

9 and 11. W. H. Pickering discovered photographically (1898) a ninth satellite, Phoebe, and even announced a tenth, but that proved to be a mistake. Phoebe (magnitude 14) is believed not to exceed 50 miles in diameter, and at a mean distance from Saturn of 8 million miles it takes 550 days to circle round in a retrograde sense, the opposite way to the movement of the other moons. Its orbit, like that of Iapetus, is steeply inclined to the planet's equatorial plane, approximately in which the other seven moons revolve. Phoebe's and Hyperion's orbits are the most eccentric in the Saturnian system, but less so than those of Jupiter VII, VIII, IX, XI, and XII. Several of Saturn's moons, having highly reflecting surfaces and seemingly very low densities, have even been supposed to be mere balls of ice or packed snow.

*Origin of satellites and rings.* As the outer edge of ring A comes inside 'Roche's limit,'<sup>1</sup> the calculated distance within which a satellite would be torn to pieces by the tidal pull of the planet, it used to be thought that the rings are the debris of a former moon which met this fate. A diametrically opposite theory has recently been propounded: that the inner satellites have condensed out of a former gigantic ring. It is considered that this would explain how Titan comes to possess an atmosphere similar to that of its parent planet.

*Observations by Saturn Section.* Saturn's most famous spot, an elliptical white one in the equatorial zone, much larger than the Earth, was discovered (1933 August 3) by Will Hay and (independently) by A. Weber. Many observations by members of the B.A.A. Saturn Section showed that the spot had a variable rotation period of about  $10\frac{1}{4}$  hours. The Section dates from 1891, and earlier leading members, including Denning, Rev. Dr. T. E. R. Phillips, and A. S. Williams, determined rotation periods for infrequent remarkable spots, the Section's greatest achievement being the visual proof (already mentioned) of the translucency of the rings. Since 1946 regular observers have made many observations (in England unless otherwise stated), some of their work being: J. R. Bazin and M. B. B. Heath, variations in brightness of satellites; Heath, varying latitudes of belts; L. F. Ball and R. L. T. Clarkson, changing tints, especially of polar areas; E. K. White<sup>2</sup> (Canada), shadows and faint ring divisions. Saturn, superficially so placid,

<sup>1</sup> See footnote, page 219.

<sup>2</sup> See footnote, page 183.

has sprung many surprises: outbreaks of dark spots on the south equatorial belt, timed by W. H. Haas,<sup>1</sup> E. E. Hare,<sup>1</sup> and E. J. Reese<sup>1</sup> (all in America), W. E. Fox, and others, showed departures from the normal rotation period; one dark patch (north temperate belt) accelerated in a few weeks to a rotation period of 9 hours 55 minutes. Haas, F. H. Thornton, and E. P. Coney observed the remarkable raggedness, faintness, and narrowness of the crepe ring (autumn 1947), and Reese by many careful estimates found that the temporary decline in width exceeded 1,000 miles. Most of this recent work was done with fairly small telescopes.

Dr. W. H. Steavenson (1950 May), using a 25-inch aperture refractor, found the inner part of ring A brighter than ring B, and Cassini's division unwontedly pale. These peculiar effects he ascribed to the unusual illumination of the nearly closed rings, the Sun being at considerably less elevation than the Earth above the ring-plane.

*Imaginary visit to Saturn.* If a rocket-ship could leave the Earth's orbit at 25,000 m.p.h.,<sup>2</sup> an explorer might reach Saturn in about  $3\frac{1}{2}$  years. He would need to take all means of sustenance, oxygen, and protection against the crushing atmospheric pressure and deadly cold. He would not select the polar regions where the Sun sets for nights of 15 years and the rings are always hidden by the globe's curvature. But if he journeyed southward from latitude  $63^{\circ}$  N., toiling in the viscous atmosphere, he would see at night the rings just above the southern horizon and ever higher as he went south: a great scintillating arch reflected on the icebound land, but blocked out in the centre by the huge oval shadow of the globe. In the daytime in 'summer' the rings would form an enormous arch of sparkling mist, while the tiny Sun, showing a disk  $\frac{1}{90}$  of the area seen from Earth, would shine feebly amidst the ammonia clouds as it raced across the sky in five or six hours. But in the 'winter' days the rings would darken the land like a curtain of fog dimming the weak sunlight, and the icy ground would be striped with mottled bands of shadow interspersed with sunlit spaces under the ring divisions. At the equinoxes, the rings being edgewise to the Sun, probably only the bright curved outer edge of ring A would be seen to catch the sunlight.

<sup>1</sup> Also members of the American Association of Lunar and Planetary Observers.

<sup>2</sup> See also page 204.

In the equatorial region at night the small moons would best be seen, sometimes perhaps five in the sky together, none appearing more than one-quarter the size of the full Moon, and frequently eclipsed. On the equator at an equinox at night a short vertical bright line (of ring) might be seen above west and east horizons in turn. By day a dark line would halve the sky, blotting out the zenith Sun, and a belt of dusky shadow lie across the ground.

Visiting the innermost satellite Mimas, the traveller, reduced in weight to a few pounds, leaping upwards at each step, and needing artificial pressure besides oxygen to compensate for the lack of atmosphere, would get an impressive view of Saturn and the rings rotating. The globe would seem 5,000 times the size of the full Moon and the rings edgewise would stretch  $170^\circ$ , almost right across the sky. Eclipses of the Sun would last much longer than on Earth, occurring daily, and then the other near satellites would look like little crescent moons, the crescents turned opposite ways on the two sides of Saturn. When the planet was at first quarter, not half but only a sector would as a rule be fully illuminated, the rest of the sunward half being lightly shadowed by the rings.

### URANUS

*Discovery.* Prior to the late eighteenth century there is no record of the discovery of a planet. Mercury, Venus, Mars, Jupiter, and Saturn, being easily seen with the unaided eye as bright wandering stars, had been known as such to the peoples of antiquity. The invention of the telescope revealed their disks and the brighter moons of Jupiter and later those of Saturn, but there was no reason to suppose the existence of planets beyond Saturn, and hence no incentive to search for them. The accidental finding of Uranus (1781) was therefore an astonishing event in astronomical history, a sort of celestial 'discovery of America.' Literally a new world had been found, so remote that its advent doubled the radius of the known planetary system of the Sun. It led directly to the later discoveries of Neptune and Pluto, and began the search for unknown planets which is still adding to the long catalogue of the asteroids.

Uranus was found by William Herschel, a Hanoverian who had settled in England when a young man, earning his living as an organist and music teacher. He took up astronomy with immense

enthusiasm as a hobby and became the greatest of amateur astronomers, for he was at once a tireless and careful observer, of keen eye and sound judgment, and a highly skilled craftsman, who built larger and better telescopes than any of that time. He made the discovery quite unexpectedly while engaged, with a 6.2-inch aperture reflector, on a survey of the stars, and he recorded it as follows:

'On Tuesday the 13th of March (1781), between ten and eleven in the evening, while I was examining the small stars in the neighbourhood of H Geminorum, I perceived one that appeared visibly

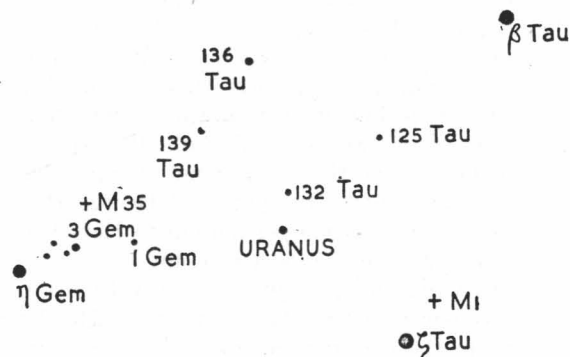

FIG. 79

Where Herschel found Uranus, March 13, 1781.

larger than the rest; being struck with its uncommon magnitude, I compared it to H Geminorum and the small star in the quartile between Auriga and Gemini, and finding it to be much larger than either of them, suspected it to be a comet.<sup>1</sup>

Herschel might easily have overlooked the tiny disk, as many others had done previously. Subsequent research into past records showed that Uranus had actually been observed and had had its position measured no less than nineteen times in the preceding ninety years. Flamsteed, the first Astronomer Royal, had done this six times in 1690, 1712, and 1715, without suspecting that the

<sup>1</sup> According to Dr. Steavenson, 'H Geminorum' is now known as '1 Geminorum' and the 'small star' is probably 132 Tauri, whose magnitude is 5. This was the nearest naked-eye object to Uranus at discovery and is one of a 'quartile,' or quadrilateral, of stars: 125, 132, 139, and 136 Tauri (*B.A.A. Journal*, 59, p. 34).



planet was not a star, and owing to the inferior quality of their telescopes other good observers had been equally deceived.

Herschel noticed the disk at once and thereupon used various eye-pieces, finding it enlarged in strict proportion to the magnification, while the images of comparison stars were not increased in the same ratio and their light was less dimmed by magnification. He continued the observations whenever possible for several weeks, charting the planet's path among the stars, working out its speed of motion, and measuring by micrometer the apparent size of the disk. Though he noted that there was no sign of a tail or beard and that the disk was well defined, he still referred to it as 'the comet.' This was cautious and correct, for many comets had been discovered before, but never a planet. Other astronomers, though told where to look, had difficulty at first in picking it out from among the stars. Further observations, however, showed beyond doubt that the path of the strange object could not be that of a comet: it must be a planet. The discovery was brought to the notice of George III who soon afterwards made a grant of £200 per annum to Herschel, enabling him to devote the rest of his life to astronomy.

*Name.* Out of loyalty and gratitude to his royal patron, Herschel wanted to call his new planet the Georgian Star. He also felt that this would indicate the country and period of discovery and was more modern and suitable than seeking a name in Graeco-Roman mythology. Others wished to name it Herschel. But tradition in the end prevailed and the new planet now goes by the name of an ancient Greek deity, Uranus, though one of its symbols, ♃, recalls the discoverer.

*Distance, year, day.* The mean distance of this planet from the Sun is 1,783 million miles, twice as far as Saturn and nineteen times as far as the Earth. Travelling on a nearly circular path, inclined less than one degree to the Earth's orbit, Uranus, proceeding at about 4 miles a second, takes 84 years to go round the Sun once. Since discovery it had completed only two circuits by March 1949. The irregularity of the motion of Uranus along its orbit will be dealt with in the next section, for this concerns very vitally the discovery of Neptune. (See page 192.)

Percival Lowell and Dr. V. M. Slipher measured (1912) the displacement of the lines in the planet's spectrum and found a rotation speed of  $10\frac{1}{2}$  miles a second, making the rotation period (or day) of

Uranus only 10 hours 45 minutes. The planet's immensely long year thus contains 68,450 of these brief days. L. Campbell at Harvard Observatory confirmed the rotation period by a different method—the observation and timing of regular changes in the planet's brightness, caused by its diverse markings. Uranus, like Jupiter and Saturn, has much polar flattening due to rapid spin.

*Size, mass, density.* The diameter is 32,000 miles, four times the Earth's, so Uranus is a large planet though smaller than Jupiter and Saturn. A planet with satellites can be 'weighed' by calculation from their distances and revolution periods, using the law of gravitation. The mass of Uranus turns out to be rather small in relation to the volume; though 64 times the Earth's volume, Uranus has a mass less than 15 times the Earth's mass. The mean density is therefore similar to Jupiter's and only about  $1\frac{1}{4}$  times that of water.

*Visibility and appearance.* Though illuminated only by  $\frac{1}{360}$  of the sunlight falling on the Earth, Uranus reflects well the light it receives. But the apparent diameter of the disk is only four seconds of arc, like a halfpenny viewed from about four-fifths of a mile. On a clear dark night the planet is just visible to the unaided eye as a faint 'star' (magnitude 6), but distinctly seen with binoculars, and not difficult for a careful observer with a good chart to follow. A new B.A.A. member, N. J. Cape (Weymouth), plotted Uranus's positions among the stars for several months (1950-1), using the *B.A.A. Handbook* chart and a 2-inch aperture predictor telescope.

To get a good view of the slightly flattened pale blue disk, however, and to glimpse its faint belts and white central zone requires a large instrument. The white zone seems to vary in position, having sometimes been seen along the equator, parallel to the planes of the satellite orbits, and at other times inclined at an angle of  $25^\circ$  or  $30^\circ$  to them.

*Temperature and atmosphere.* The mass of Uranus is sufficient to have retained all the gases of its original atmosphere, including hydrogen. But owing to its great distance from the Sun this remote planet can receive very little solar heat, and the surface temperature is believed to be below  $-300^\circ\text{F.}$  ( $-185^\circ\text{C.}$ ). Hydrogen and helium are probably present in the atmosphere; inert gases such as argon and krypton may also be there and undoubtedly methane, which

remains gaseous at very low temperatures. Other gases such as oxygen, carbon dioxide, water vapour, and even ammonia are probably frozen out of the atmosphere of Uranus.

Observation strongly supports these opinions. The spectrum of the planet shows abundant methane but only a trace of ammonia,

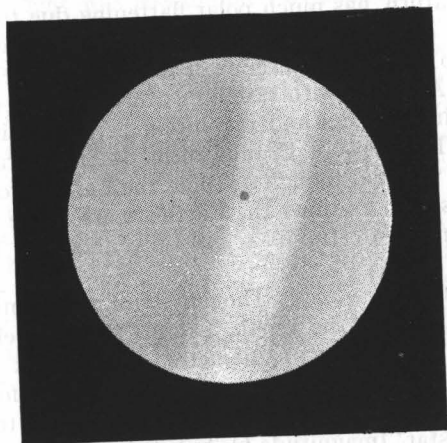

FIG. 80

W. H. STEAVENSON. 10-in. aperture. September 1915. Uranus, showing a broad white zone between two dusky belts. (From *Splendour of the Heavens*, Hutchinson)

in contrast to Jupiter, the brownish colour of whose belts may be due to ammonia. If, as is possible, there are no opaque clouds on Uranus, their absence would enable sunlight to penetrate deeper into the methane layers, accounting for the great intensity of the methane bands in the spectrum. Moreover since methane strongly absorbs red and yellow light, a deep atmosphere of this gas would give Uranus its pale bluish colour.

From the low mean density and the degree of flattening, Dr. R. Wildt has estimated the metallic rocky core at only about 14,000 miles in diameter, covered by a layer of 'ice' some 6,000 miles thick and an 'atmosphere' 3,000 miles deep. These together make up the globe of 32,000 miles diameter as seen from the Earth. (See also page 149.)

*Peculiar tilt of axis.* The most extraordinary thing about Uranus is the excessive tilt of its axis. While Jupiter marches around the Sun almost erect and the Earth and Saturn in a leaning position, Uranus, like a trick rider, crawls around recumbent, not merely flat

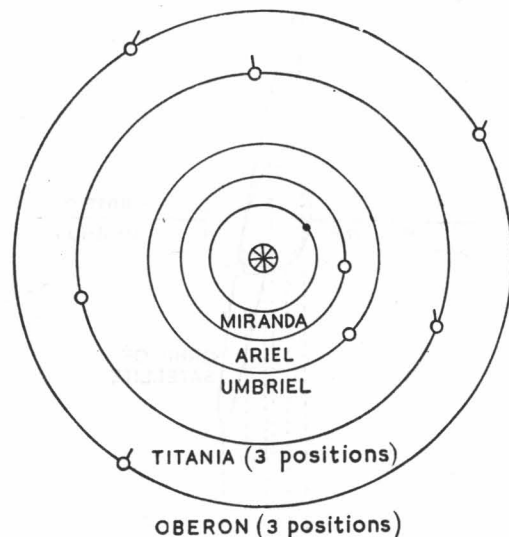

FIG. 81

Satellite orbits when a pole of Uranus turns earthward; Uranus then appears circular. Radii of orbits approximately to scale (5 : 8 : 11 : 18 : 24). Supposed directions of the north poles of Oberon and Titania are shown, assuming that they revolve 'lying on their sides.'

on its side but tipped over still more. The axis instead of being more or less vertical to the orbit-plane, is tilted  $98^\circ$  from the vertical, that is,  $8^\circ$  beyond the horizontal. This has curious effects. Observers sometimes see Uranus with equator nearly upright from its path and the poles at the sides, while at other periods one of the poles faces the Earth. The satellites therefore travel around the planet in orbits almost vertical to the ecliptic instead of horizontal or slightly inclined. With respect to its north pole, Uranus like the Earth and the other planets has a direct (anti-clockwise) spin on its

axis and the satellites circle around its equator in the same sense. But since the whole system is tilted over by more than  $90^\circ$ , the rotation of the planet and the revolution of its moons are technically retrograde (clockwise) as projected on to the plane of its orbit.

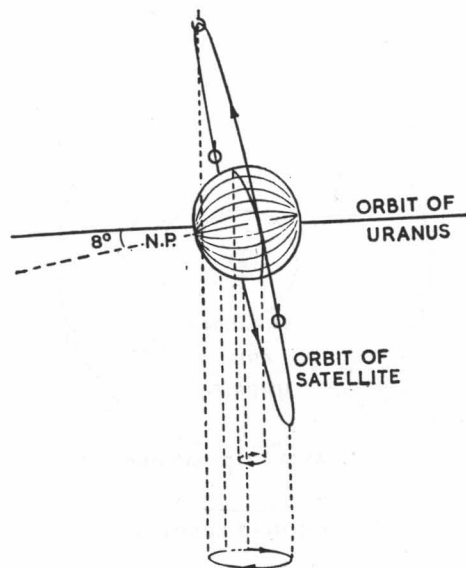

FIG. 82

Uranus (poles flattened) sideways to the Earth, with Oberon or Titania (three positions). Their anticlockwise motion becomes clockwise (retrograde) when projected on to a plane parallel to the orbit-plane.

*Discoveries of satellites.* Uranus, the third largest planet, happens to be suitably escorted on its travels by the third largest retinue of moons. Five of these small bodies have so far been discovered and they did not all escape the vigilance of Sir William Herschel. After finding Uranus he confidently hoped to detect one or more satellites, but for a time he searched in vain. Early in 1787 an improvement he had made in the light grasp of his telescope encouraged him to resume the quest. This time he met with almost immediate success, for on 12th January (the second night of observation) he noticed

that of a number of faint stars seen by him close to Uranus on the previous night, two had disappeared. His comment was characteristic: 'Had I been less acquainted with optical deceptions, I should immediately have announced the existence of one or more satellites to our new planet; but it was necessary that I should have doubts. The least haziness, otherwise imperceptible, may often obscure small stars.'

His subsequent actions help to explain his outstanding achievements and reputation as an astronomer. He spent the next six clear nights in noting carefully *all* the faint stars in the vicinity of the planet. By the end of this time Herschel was fairly certain that one at least of the two 'stars' first suspected was really a satellite. But he resolved to try to watch it actually in motion. On 7th February he observed Uranus and this 'star' continuously for nine hours. He saw that it was accompanying the planet and he was able to follow the satellite along a considerable arc of its orbit. He gave up the vigil at 3 a.m., but only because further observation of that part of the sky was blocked by his house.

The next night he watched especially the other 'star' for over three hours, finding that it changed position more quickly than the first and so presumably was travelling on a smaller orbit nearer to Uranus. He calculated that this inner satellite circled the planet in  $8\frac{1}{2}$  days, the other in  $13\frac{1}{2}$  days. He drew them in the places he expected them to occupy in relation to Uranus on 10th February, and when that night came was delighted because: 'The heavens now displayed the original of my drawing.' Thus were discovered first Oberon and then Titania.

Lassell found (1851) two more moons nearer to the planet than Titania. These were Umbriel and Ariel with revolution periods around Uranus of 4 and  $2\frac{1}{2}$  days respectively. While Oberon revolves at a mean distance of about 360,000 miles, Ariel, the nearest of these four, is at only one-third of Oberon's distance. The surprising thing is that Dr. Kuiper announced (1948) the discovery of a fifth moon, Miranda, even nearer, at about 76,000 miles from Uranus and taking only 34 hours to scurry round its path. This very faint and active little body of about magnitude 17 and perhaps less than 200 miles in diameter, was found by photography with the 82-inch McDonald reflector, only two or three minutes' exposure being required, though it could not be seen visually, owing to its nearness



to the planet. The other four, though probably larger than the current estimates of 400 to 1,000 miles in diameter, are all smaller than the Moon.

*Brightness of Satellites.* A large telescope is required to see any of these small faint moons. Until recently Oberon and Titania were usually rated at magnitude 14, Ariel and Umbriel at 16 to 17. But Dr. W. H. Steavenson after a series of observations (1947-8) with his 30-inch reflector, finds that their brightness, especially that of Ariel and Umbriel, has been underestimated owing to their nearness to the planet whose light swamps their own. He says in fact that Ariel and Umbriel can only be seen clearly with the 30-inch when Uranus is covered by a field bar. He estimates the magnitudes as follows: Titania and Ariel 13.7, Oberon 13.8, Umbriel 14.5.

Steavenson also found that Oberon and Titania vary appreciably in brightness from night to night, probably because some parts of their surface reflect better than others. He had noticed this about twenty years previously when a side of Uranus was towards the Earth, but he was surprised to observe the variation again distinctly (1946-8) when one pole of Uranus was turned almost directly earthward. If these two moons were travelling upright on their paths around the planet they should at this time also have been keeping one pole towards the Earth and not have shown this change of light. Steavenson has therefore suggested that Oberon or Titania or both may revolve around Uranus at a considerable tilt, perhaps even lying on their sides, as Uranus does on its journey around the Sun.

## NEPTUNE

*Method of discovery.* The story of the tracking down of Neptune is among the most remarkable in the history of astronomy and of science. Success was due, not to skilful recognition of an intruding star as a planet, but to long, laborious, intricate calculations by two young mathematicians of genius. Telescopes played a minor part in the exploration of a certain area of sky for a planet which must be there. Good and ill fortune affected the search, but ultimate victory was assured by mathematical reasoning.

*Problem of Uranus.* It all arose from the irregularity of the motion of Uranus. Accurate observations often have a future importance quite unrealized by the observer. So it was with the nineteen early

records of Uranus's position, made at dates between 1690 and its discovery by Herschel (1781). One of these early records was inscribed on a paper bag that had contained hair powder. As may be guessed, that observer was no Herschel; otherwise he should have discovered Uranus in 1769, when he had the good fortune actually to observe it on four consecutive nights and twice more within nine days. But Le Monnier did not compare his observations; six of his 'stars' were really one moving planet.

Within their limitations, however, all the pre-discovery observations were sound: their accuracy was vindicated by Bessel in 1840. They should have been extremely useful because, extending over so many years, they gave widely separated points on Uranus's path. This should have enabled the elements (basic dimensions) of the orbit to be so well determined that future positions of the planet could be accurately predicted. Unfortunately when A. Bouvard came to work out the elements, making due allowance for the pulls of Jupiter and Saturn on Uranus, he could not find an orbit into which both the early observations and those of 1781-1820 would fit even approximately. Thus he had to base his tables of Uranus (published 1821) on the later observations alone. He suggested that the impossibility of reconciling the two sets of positions might be due either to inaccuracy of the earlier ones, or to some unknown influence on the planet.

As time went on the situation steadily worsened. Observations after 1820 showed Uranus falling farther and farther behind its predicted places. By 1834 the pull of a remote planet was already being suggested as the cause. In 1837 G. B. Airy, the new Astronomer Royal, wrote: 'The errors of longitude are increasing with fearful rapidity.' But he was dubious about the unknown planet. 'If it be the effect of any unseen body,' he wrote, 'it will be nearly impossible to find out its place.' The accumulation of data for several centuries, he considered, would be required as a basis for such calculations.

No longer able to blame the early observations for the continuing misbehaviour of Uranus, Airy was inclined to suspect errors in the calculation of the orbit, and even to share, with a few other astronomers, doubts whether the law of gravitation was absolutely correct at such great distances from the Sun.

Wilder theories were mooted at this time: a resisting medium; an

undetected satellite; a collision with a comet. But no one could explain why a resisting medium should afflict Uranus and no other planet; how a large massive satellite could possibly have gone undetected; or how it or a collision could continue to slow down the planet's motion.

By 1845 Uranus was out of place by the 'intolerable quantity' of two minutes of arc, a difference that could hardly be detected with the unaided eye, but more than enough to darken the lives of astronomers and mathematicians. Yet the dawn was at hand.

*Mathematical solution.* On July 3, 1841, a gifted young mathematical student at Cambridge, John Couch Adams, had made the memorable entry in his diary of a resolve, as soon as possible after taking his degree, to investigate the irregularities in the motion of Uranus, find out whether they were due to an undiscovered planet, and if so try to work out its orbit, so that it might be found in the sky. In January 1843 he took his mathematical degree with more than double the marks of the second highest candidate. He began his difficult task and obtained a rough solution the same year. Then he applied through Professor Challis, director of Cambridge Observatory, to the Astronomer Royal for full particulars of the errors of position of Uranus. These were promptly supplied.

By September 1845 Adams (then only twenty-six years old) had virtually solved the intricate problem. He had calculated from its effects on Uranus the probable mass, orbit, and position in the sky of the disturbing planet.

*Misunderstandings and delay.* Adams gave Challis a copy of his results and wanted to explain them personally to the Astronomer Royal. Challis wrote introducing him, but Adams did not apply for a definite appointment. This was unfortunate, for Airy was an extremely busy man, much occupied with observatory routine and practical affairs outside, advising the government on all manner of subjects from lighthouses to railways. Adams called at Greenwich three times in September and October in vain. The first time Airy was in France; the second out; the last time he was in but apparently did not receive Adams's message. Pained at what seemed like a refusal to see him, Adams departed, leaving a brief statement of his results. Not knowing how they had been calculated Airy was sceptical. He wrote a fortnight later, thanking Adams and expressing interest, but asking a question he thought would be a

crucial test, whether Adams's solution explained the error in the radius vector of Uranus.

The shy diffident Adams, now much discouraged, found letter writing difficult and to him Airy's question seemed trivial and the answer obvious, so he did not reply to it for a year. Also it happened that Adams's solution had made him wish to change slightly his assumed distance for the unknown planet. This involved reworking all his calculations, and being much interrupted, he was unable to send his improved but not very different results to Airy until September 1846.

Challis and Airy had been handed the clue to the most perplexing astronomical mystery of the day. It is strange that during that autumn they made no attempt to follow it up. But as Challis himself said afterwards, the idea of a telescopic search based on 'merely theoretical deductions' was so novel that 'while much labour was certain, success appeared very doubtful.'

Airy had long been interested in the problem, and with his energy and forcefulness was just the man to organize a search, success in which would have added still more to the growing prestige of the Royal Observatory under his leadership. But he seems to have doubted the care and accuracy of mathematicians, though one himself, and to have been unduly impressed with the risks of error. Also he felt debarred from further action by Adams's failure to answer his question, to which he attached great importance. He could not understand Adams's silence. Had his crucial question upset the solution? Airy had always thought the problem insoluble.

*Mathematical confirmation.* Meanwhile a French mathematician of the first rank, U. J. J. Le Verrier (aged 35), with faith in Newton's law and the unknown planet equalling that of Adams, solved the problem independently. His solution, presented to the French Academy, was published in June 1846, and as soon as it reached England, Airy read it with 'delight and satisfaction,' for Le Verrier placed the disturbing planet within one degree of the position assigned to it by Adams. Airy's doubts were now at an end, but he nevertheless put his crucial question to Le Verrier also, yet unfortunately made no mention of Adams's solution. Le Verrier replied promptly and fully, asked for a search to be made, and offered to work out and send Airy exact particulars of the expected place of the new planet.

*Search and discovery.* Airy did not reply to Le Verrier, but hurried on the search. As he thought the telescopes at Greenwich were inadequate, he urged Challis to begin immediately with the Northumberland refractor at Cambridge, then one of the largest in the world. He sent a detailed scheme of search and offered the help of an assistant from Greenwich. The trouble was that no satisfactory star chart was available, so Challis had to chart all the faint stars down to magnitude 11 in the fairly large region assigned

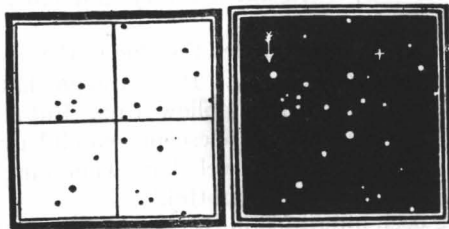

FIG. 83

## DISCOVERY OF NEPTUNE

*Left:* A corner of Galle's map; *right:* the corresponding patch of sky showing where Galle found Neptune (marked by arrow), and where Le Verrier calculated the planet would be (cross).

(From *Splendour of the Heavens*, Hutchinson)

by Airy. He was so busy with this—Challis charted over 3,000 star positions—that there was no time to compare the observations. Had he done so he would have been the first to find Neptune, for he actually charted it on 4th and 12th August, when the telescope was directed towards the place indicated by Adams. But he did not realize that these two 'stars' were the planet in two positions. Early in September W. Lassell, a very skilful amateur astronomer, was also asked to search, but he was laid up; yet another misfortune for England.

The scene now shifts to Berlin Observatory. On September 23, 1846, exactly a year after Adams's first call to see Airy, Dr. J. G. Galle, then assistant astronomer, received a letter from Le Verrier giving the expected position of the disturbing planet and suggesting a search. When this was being discussed a young astronomer,

D'Arrest, said that the relevant part of the sky might be included on a new star chart not yet distributed. This proved correct, so on the same evening the search began, Galle at the 9-inch aperture refractor calling out the stars, D'Arrest checking them on the chart. When they had reached an area near one corner of the chart Galle described the position of an eighth magnitude star. D'Arrest replied: 'That star is *not* on the map.' Neptune was found,<sup>1</sup> less than one degree from the place Le Verrier had predicted. Two nights later its motion had been confirmed and its disk measured.

The situation was (in 1946) humorously summed up by P. J. Melotte: 'A great catch had been made by Galle, and Le Verrier was the successful bowler. On the other hand the batsman should have been stumped during the previous over' off the other bowler 'if the wicket-keeper had not fumbled the ball.'<sup>2</sup>

But at the time the affair caused no amusement though much heat and rancour. Rejoicings in France at the great achievement of Le Verrier were sadly interrupted by Sir John Herschel's announcement of Adams's independent solution. National pride was aroused on both sides of the Channel and a most deplorable controversy ensued; many and unfair attacks were made, especially on Airy. The modest and gentle Adams made no claim and no complaint. He and Le Verrier became the best of friends, and are now accorded equal honour for the greatest mathematical triumph of the age.

*Why Uranus lagged behind.* When discovered (1781) Uranus happened to have just entered the half of its orbit nearer to Neptune and in 1822 it passed Neptune, making its closest approach, as it does once every 172 years. So Bouvard's calculations of the orbit of Uranus were based on a period (1781-1820) when that planet's speed was faster than normal, being accelerated by the increasingly strong forward pull of Neptune. After 1822 Neptune was, of course, pulling *against* the motion of Uranus and slowing it down.

What would have happened had Uranus been in 1781 on the opposite side of its orbit? In that case it would have been getting very distant from Neptune during the ensuing forty years, and the latter's effect would have been so slight that no irregularity in the motion would probably have been noticed until the last quarter of the nineteenth century. Neptune might then have been found by

<sup>1</sup> About 1° north of a point one-third of the distance from  $\iota$  Aquarii to  $\mu$  Capricorni.

<sup>2</sup> *J.B.A.A.*, 57, 1, 13.



observation before being deduced by mathematics. In any event its discovery would have been delayed, perhaps by as much as half a century.

*Distance, day, year.* A search of past records revealed that Neptune had actually been observed twice as a 'star' by Lalande

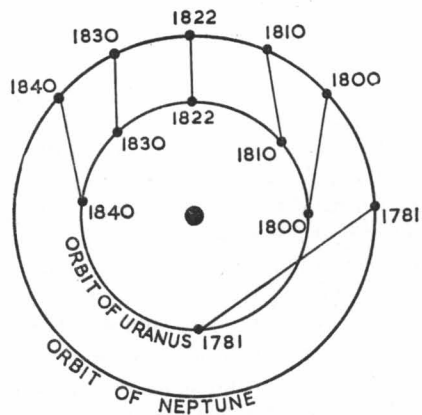

FIG. 84

Showing how Neptune accelerated Uranus 1781-1822 and retarded Uranus after 1822.  
(Hutchinson: *Splendour of the Heavens*)

(1795). These observations, made half a century before its discovery, helped greatly in computing the actual orbit of the slow-moving planet. Adams and Le Verrier had had to assume as a basis of their calculations that in accordance with Bode's law (which approximately gave relative distances of other planets from the Sun) Neptune should be at twice the distance of Uranus. It will be recalled that Adams's solution showed him that this ought to be slightly reduced. Neptune actually proved to be an exception to this law, the mean distance from the Sun being 2,793 million miles, only about  $1\frac{1}{2}$  times Uranus's distance or 30 times the Earth's. In fact Pluto's mean distance is nearly the same as Neptune's should have been to comply with Bode's law.<sup>1</sup>

Neptune takes nearly 165 years to journey around the Sun and will not finish one circuit since discovery until the year 2011. Its

<sup>1</sup> See page 6.

path is very nearly a circle. The rotation period (or day) was computed by J. H. Moore and D. H. Menzel from small variations in its light, in the absence of definite markings or measurable shift of spectral lines. Regular fluctuations in light indicate that brighter or darker parts of the planet are coming round to the front through its rotation. Neptune's day seems to be 15.8, or perhaps only 13.8, hours, giving over 91,000 short days in its long year. Like the other large planets its poles are flattened by the rapid rotation.

*Size, mass, density.* Neptune's great distance and small disk made the size difficult to determine, and until recently it was thought to be as large as Uranus or even larger. However, Kuiper (1949) found the diameter to be only 27,600 miles, about  $\frac{2}{3}$  that of Uranus or  $3\frac{1}{2}$  times the Earth's. This value was obtained by using an artificial disk and a double-image micrometer with the 82-inch aperture McDonald reflector.

Being much nearer to Uranus's orbit than Adams and Le Verrier could have foreseen, Neptune is able to exert its pull on Uranus without being so massive as they had estimated. But though a little smaller than Uranus, Neptune is the more massive of the two. From the distance and revolution period of its chief satellite, Neptune's mass has been calculated at seventeen times the Earth's. Its mean density is therefore 2.2 times water, so it is the densest of the great planets, and according to Wildt's calculation probably has a metallic rocky core about 12,000 miles in diameter, an ice layer about 6,000 miles and an atmosphere some 2,000 miles deep.<sup>1</sup>

*Visibility, temperature, atmosphere.* Neptune is visible, as an eighth magnitude star, in a small telescope, but not to the naked eye. A large telescope is needed to show properly the bluish-white disk. No cloudlike belts can be seen, probably because the crystals of ammonia have settled out of the hydrogen layer, making the atmosphere clearer of cloud.<sup>2</sup> The temperature is estimated at  $-330^{\circ}\text{F.}$  ( $-200^{\circ}\text{C.}$ ), somewhat lower than Uranus's. There is only a trace of ammonia in the spectrum, but the bands of methane are even stronger than those of Uranus's spectrum, probably because sunlight penetrates even deeper into the methane layer.

*Discoveries of satellites.* It will be remembered that in the race to find Neptune by observation, Lassell was a non-starter (owing to a sprained ankle). But the man who was to discover two more moons

<sup>1</sup> See also page 149.

<sup>2</sup> See Appendix XI (9).

of Uranus a few years later, quickly showed his rare skill as an observer. Using his 2-foot aperture reflector he managed to discover Triton, Neptune's fourteenth magnitude satellite, on October 10, 1846, less than three weeks after Neptune itself was found.

Triton, though too distant to measure exactly, is believed to be about 3,000 miles in diameter. If so it is much larger than the Moon and more of the size of Mercury and of Jupiter's largest satellites, Ganymede and Callisto. At only about 220,000 miles from Neptune, Triton circles round it in less than six days in retrograde (clockwise) motion, whereas Neptune's rotation and movement around the Sun are anti-clockwise, which is orthodox for planets. Also, though Neptune's orbit is almost in the same plane as the Earth's, Triton's track is tilted at about 35° to both these orbit-planes. Triton is large and cold enough to have an atmosphere, probably of methane, and Kuiper (1944) found a suspicion of this in the spectrum.

Kuiper also discovered (1949) by photography with the 82-inch reflector an additional but tiny and distant moon (now named Nereid) of Neptune. Van Biesbroeck (also of Yerkes Observatory) has found Nereid to have the most eccentric orbit (eccentricity 0.76) of any satellite, the distance from Neptune ranging from under 1 million to over 6 million miles. Nereid's period of revolution is 359 days and its motion round Neptune is direct. From its extreme faintness (magnitude 19.5) this little moon is estimated to be, like Uranus's Miranda, less than 200 miles in diameter. Nereid, so small and far, can shed on Neptune only a minute fraction of the Moon's light on the Earth, and Triton, though large and close, is not a brilliant object in the Neptunian sky, as it would give only  $\frac{1}{400}$  of the light the Earth gets from the full Moon.

## PLUTO

*Discovery.* Pluto, like Neptune, was discovered through mathematical calculations, based on the irregular motion of Uranus. Ill luck again delayed discovery, this time for eleven years. But there was no international rivalry. The finding of Pluto was an all-American success, and photography (not available in the search for Neptune) ultimately played a decisive part.

Perturbations caused by Jupiter, Saturn, and Neptune had not

completely accounted for the vagaries of Uranus. Therefore Percival Lowell (famous for his Mars observations) began (1905) calculations to find out the mass, position, and orbit of a supposed trans-Neptunian planet, whose pull on Uranus might clear up the remaining discrepancies in the observations. His results were published (1914) only two years before he died. Other mathematicians were also studying the problem, notably W. H. Pickering (another famous American planetary observer). His first solution had appeared in 1909, but ten years later he published a revised one, including in the calculations small irregularities of Neptune's motion also. He persuaded Milton Humason (Mount Wilson Observatory) to photograph the sky in the region where he expected the planet might be found.

Pluto was actually photographed by Humason more than once in 1919, but unluckily it was not detected. The image happened to fall on a flaw in one plate and was camouflaged by a coincident star on another. So the search seemed to have failed and was not resumed until 1929, when a new 13-inch refractor was used, at Lowell's own observatory, and Clyde Tombaugh was in charge of the work. He took long-exposure photographs to cover systematically the appropriate part of the sky, each section being photographed twice at an interval of two or three days. The pairs of plates had to be carefully examined under a blink microscope, which would make any object that had moved in the interval appear to jump on the plate. The movement would indicate the presence of a comet or planet. After some months of laborious work, Tombaugh announced (1930 March 13) that he had found and followed Pluto among the stars, and that its distance, position, path, and speed agreed well with Lowell's prediction. It was, in fact, only 5° from the position assigned by both Lowell and Pickering, and its apparent brightness (magnitude 14.8) confirmed Pickering's calculation. Pluto was found in the same constellation, Gemini, in which Uranus had been discovered just 149 years previously.

*Mass.* The only disappointment, but a grave one, was its mass. To exert the necessary pull on Uranus and Neptune, Pluto's mass should have been twice the Earth's (according to Pickering), seven times (according to Lowell). But it proved to be smaller than the Earth, though its size could not until recently be measured at all.

<sup>1</sup> See page 402.

This is because, although it is discernible with an 8-inch telescope, it does not show a disk even in the 100-inch.

In 1950 March, with a disk meter fitted to the 200-inch telescope and a magnification of 1,140, Dr. G. P. Kuiper and M. Humason measured the disk, finding its diameter less than 3,700 miles—less than half the Earth's diameter and intermediate between those of Mars and Mercury. It could not exert its assumed pull on Neptune unless its density is 40 or 50 times that of water. As the Earth's mean density, the greatest known among planets, is only  $5\frac{1}{2}$  times that of water, the probability is that Pluto's mass corresponds to its size and does not exceed  $\frac{1}{10}$  the Earth's mass. Hence it cannot have produced the effects on which Lowell and Pickering based their calculations, and its appearance at the place they predicted now looks like a remarkable coincidence. Nevertheless Pluto might well have escaped discovery but for the work of Lowell and his observatory, and it seems fitting that the first two letters of 'Pluto' and its symbol **P** should commemorate Percival Lowell.

Moreover, the struggle to vindicate Pluto has not been abandoned. Recent experiments<sup>1</sup> by D. Alter, G. W. Bunton, and P. E. Roques at Griffiths Observatory, indicate that if Pluto had a mottled surface (suggested fifteen years ago by the late Dr. A. C. D. Crommelin), its apparent diameter may be due to specular reflection and thus much smaller than the true value. Such mottling could arise from frozen surface pools of gases from a former atmosphere. Pluto's temperature is now too low for an atmosphere unless composed of hydrogen, helium, or neon.

*Distance and orbit.* At a mean solar distance of 3,666 million miles, Pluto's average orbital speed is only 3 miles a second, slow compared with the Earth's  $18\frac{1}{2}$  and Mercury's 30 miles per second. Pluto's year is therefore 248 terrestrial years. Though most major planets have nearly circular orbits, its path (like Mercury's) is very eccentric, its solar distance being at aphelion nearly 50 times the Earth's, but at perihelion (in 1989) just under 30 times, which is inside Neptune's orbit. However, Pluto's path never crosses Neptune's and there is no more chance of a collision than (say) between a Metropolitan and a Bakerloo train at Charing Cross, for its orbit-plane is inclined  $17^\circ$  to the ecliptic plane, to which the other chief planetary orbits (except Mercury's) are inclined only  $1^\circ$  to  $3^\circ$ . In

<sup>1</sup> See page 440.

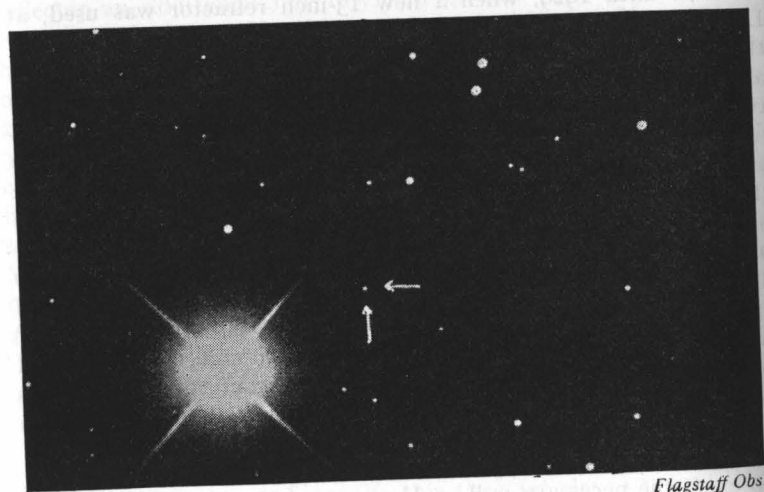
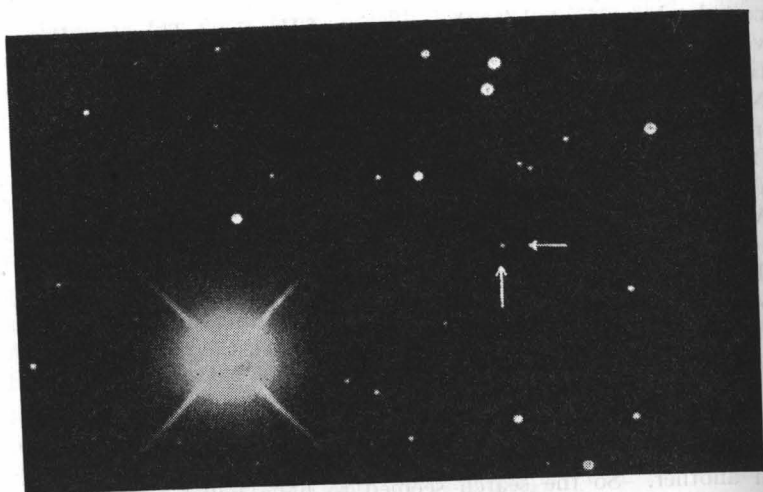

Flagstaff Obs.

### PLATE XIX THE DISCOVERY OF PLUTO

How Pluto (shown by arrows) was discovered by comparing Flagstaff Observatory photographs, of 1930 March 2 and March 5, of the same sky area. The bright naked-eye star is  $\delta$  Geminorum.



the eccentricity and tilt of its orbit Pluto more resembles comets and asteroids than major planets. This suggests that, just as there is a belt of asteroids between the orbits of Mars and Jupiter, there may be outside Neptune's orbit another belt of small planets, of which Pluto is the first to be discovered. At Lowell Observatory a search has been made for others, but so far without success. To find extremely faint little planets at that great distance would require perhaps many decades of laborious seeking with the world's largest telescopes.

*A trip to Pluto.* If in future a rocket-ship could be built which could leave the Earth's orbit at a speed of 25,000 m.p.h., generally considered necessary to escape the Earth's pull, a visit to Pluto, farthest outpost of the solar system, might be considered. But provision of oxygen, water, food, and fuel for 33 years would be needed for the return trip even at this speed unless a date were selected near Pluto's perihelion, which occurs once in 248 years, when the double journey might be done in 25 years. Although Pluto's remoteness from the Sun and extreme cold may have allowed it to keep an atmosphere, this is doubtful because of its small mass, and the atmosphere could only be of hydrogen, helium, or neon. So the visitor would have to be equipped with air, pressure, and warmth. Seen from Pluto's barren rocky or ice-covered surface, the familiar stars and constellations would look much as they do from Earth, just as remote but more brilliant in the clear black sky. There would probably be no satellite to brighten the scene, while the Sun's light would be greatly reduced and its warming power negligible. For the solar disk would seem little more than a brilliant point though at least 190 times as bright as full Moon and at perihelion 760 times. Neptune might be seen if the visit were made when it happened to be in a near part of its orbit, but that would only occur at intervals of many years. To see other planets a powerful telescope would be required. It might just show one or two of them very close to the Sun and best seen when half illuminated. It is true that an average man might weigh less than  $1\frac{1}{2}$  stone on Pluto and could, as on the Moon, perform prodigious feats in jumping and driving of golf balls. But would these accomplishments and the unusual aspect of Sun and planets, compensate him for half a lifetime spent in space travel to a dead airless frozen world of perpetual starlight?

## BIBLIOGRAPHY

- E. M. Antoniadi: *La Planète Mercure*, Grauthier Villars, Paris, 1934.  
 F. Zöllner: *Photometrische Untersuchungen über die physische Beschaffenheit des Planeten Merkur*. Publisher unknown.  
 E. M. Antoniadi: *La Planète Mars*, Paris, 1930.  
 M. Davidson: *From Atoms to Stars*, Hutchinson, 1952.  
 P. Doig: *Concise History of Astronomy*, Chapman & Hall, 1950.  
 C. Huyghens: 'Systema Saturnium' (in *Œuvres de Christiaan Huyghens*, Société Hollandaise des Sciences, 1888, etc.).  
 Sir William Herschel: *The Scientific Papers, Royal Society and Royal Astronomical Society*, 1912.  
 Sir H. Spencer Jones: *General Astronomy*, Edward Arnold & Co., 1951.  
 Sir H. Spencer Jones: *Life on Other Worlds*, English Universities Press, 1952.  
 D. McIntyre: 'The Translucency of Saturn's Rings' (reprint from *Journal of Astronomical Society of South Africa*, 1935).  
 E. W. Maunder: *The Royal Observatory Greenwich*, Religious Tract Society, 1900.  
 T. E. R. Phillips and W. H. Steavenson: *Splendour of the Heavens*, Hutchinson, 1923. (Chapters on planets by A. C. D. Crommelin, W. F. Denning, P. H. Hepburn, T. E. R. Phillips, and R. L. Waterfield.)  
 R. A. Proctor: *Saturn and his System*, Chatto & Windus, 1882.  
 G. Schiaparelli: *Osservazioni di Marte, 1877-82*, Rome, 1878-86.  
 G. de Vaucouleurs: *The Problem of Mars*, Faber & Faber, 1950.  
 F. G. Watson: *Between the Planets*, Harvard Books on Astronomy, Churchill, 1947.  
 F. L. Whipple: *Earth, Moon, and Planets*, Harvard Books on Astronomy, Churchill, 1947.  
 British Astronomical Association: Circulars, Handbooks, *Journal* (especially Presidential Addresses by B. M. Peek, P. J. Melotte, and J. G. Porter), and *Memoirs* (Jupiter, Mars, History of Association).  
 M. Davidson: 'The Atmospheres of the Earth and Planets,' *Irish Astronomical Journal*, vol. i, No. 3, 1950 September, and *Science News*, 18, 1950 November.  
 Royal Astronomical Society: *Monthly Notices and Occasional Notes* (W. M. Smart: 'John Couch Adams and the Discovery of Neptune').  
 Société Astronomique de France: *Bulletin—L'Astronomie*' (especially papers on planetary observations at Pic du Midi Observatory, 1943 April and 1947 September, and 1953 January, February, and March).

PLANETARY

	Mercury	Venus	Earth
Distance from Sun (millions of miles)			
Mean	B 36.0	67.2	92.9
Mean Distance from Sun (Astronomical Units)	B 0.39	0.72	1.00
Sidereal Period—revolution round Sun (years)	B 0.24	0.62	1.00
Mean Synodic Period—between Oppositions or * Inferior Conjunctions (days)	B *115.88	*583.92	—
Eccentricity of Orbit	B 0.206	0.007	0.017
Inclination of Orbit to Ecliptic	B 7°.0	3°.4	0°.0
Inclination of Equator to Orbit	?	?	23°.45
Mean Orbital Velocity (miles per second)	W 29.7	21.7	18.47
Diameter (miles)	{ Equatorial W 3,100	7,700	{ 7,927 Polar 7,900
Apparent Diameter at Mean Opposition or * Inferior Conjunctions (seconds of arc)	*10.9	*60.8	—
Volume (Earth=1)	W 0.06	0.92	1.00
Mass (Earth=1)	W 0.04	0.81	1.00
Density (Water=1)	W 3.8	4.86	5.52
Surface Gravity (Earth=1)	W 0.27	0.85	1.00
Velocity of Escape (miles per second)	W 2.2	6.3	7.0
Rotation Period	B 88 days	? 5 weeks	23 <sup>h</sup> 56 <sup>m</sup>
Surface Temperature (maximum)	{ F. W 77° C. W 41°	14° 60°	? 140° ? 60°
Gases identified in Atmosphere	—	CO <sub>2</sub>	O, N, H <sub>2</sub> O, CO <sub>2</sub> , etc.
Albedo	W 0.07	0.59	? 0.5

The above figures have been compiled from different sources and there is of the *British Astronomical Association*; W, Whipple's *Earth, Moon, and* sometimes a compromise between different results. Where any of these contrary is stated.

DATA

	Mars	Jupiter	Saturn	Uranus	Neptune	Pluto
	141.5	483.3	886	1783	2793	3666
	1.52	5.20	9.54	19.18	30.07	39.52
	1.88	11.86	29.46	84.01	164.8	248.4
	779.94	398.88	378.09	369.66	367.48	366.73
	0.093	0.048	0.056	0.047	0.009	0.249
	1°.9	1°.3	2°.5	0°.8	1°.8	17°.1
A	25°.2	3°.1	26°.75	98°	29°	?
	15.0	8.1	6.0	4.2	3.4	3.0
	4,216	{ 88,700 82,800	{ 75,100 67,200	32,000	T 27,600	<3,700 ?
	17.88	{ 46.86 43.74	{ 19.52 17.46	3.76	2.52	[ < 0.23 ]
	0.15	1,312	T 734	64	42	0.1 ?
	0.11	317	94.9	14.7	17.2	0.1 ?
	3.96	1.34	0.71	1.27	2.2	?
	0.38	2.64	1.17	0.92	1.4 ?	?
	3.1	37	22	13	14	?
	24 <sup>h</sup> 37 <sup>m</sup>	{ I 0 <sup>h</sup> 50 <sup>m</sup> .5 II 9 <sup>h</sup> 55 <sup>m</sup> .7	Eq. 10 <sup>h</sup> 14 <sup>m</sup>	10 <sup>h</sup> 45 <sup>m</sup>	15 <sup>h</sup> 48 <sup>m</sup> or 13 <sup>h</sup> 48 <sup>m</sup>	?
	86° 30°	-216° -138°	-243° -153°	? -300° ? -185°	? -330° ? -200°	? -348° ? -211°
	CO <sub>2</sub> , H <sub>2</sub> O	CH <sub>4</sub> , NH <sub>3</sub>	CH <sub>4</sub> , NH <sub>3</sub>	CH <sub>4</sub> , (NH <sub>3</sub> )	CH <sub>4</sub> , (NH <sub>3</sub> )	—
	0.15	0.44	0.42	? 0.45	? 0.52	?

some uncertainty in many cases regarding their accuracy. B denotes *The Handbook Planets*; A, Antoniani's results; and T, the figures given in the text, which are letters appears on the first column it refers to everything in the row unless the

SATELLITE

DATA (mainly from *B.A.A. Handbook*)

Planet and Satellite	Discoverer and Date	Mean Distance from Planet		Estimated Diameter (miles)	Period of Revolution round Planet			Eccentricity of Orbit	Mass (Sun = 10,000 million)	Apparent Stellar Magnitude (at Mean Opposition Distance)		
		(Astronomical units)	(Thousands of miles)		d.	h.	m.					
<i>Earth</i> Moon	—	0.002	571	239.1	2,160	27	7	43	0.0549	367.4	-12.5	
<i>Mars</i> I Phobos	Hall, 1877	0.000	062	725	15?		7	39	0.017		10 to 12	
II Deimos	Hall, 1877	0.000	156	95	7?	1	6	18	0.003		11 to 12	
<i>Jupiter</i> I Io	Galileo, 1610	0.002	819	56	2,000+?	1	18	28	Small and variable	429.4	5.3 to 5.8†	
II Europa		0.004	486	2	2,000+?	3	13	14		242.1	5.7 to 6.4†	
III Ganymede		0.007	155	9	665.5	3,200+?	7	3		43	762.7	4.9 to 5.3†
IV Callisto		0.012	586	5	1,170.6	3,100+?	16	16		32	430.0	6.1 to 6.4†
V (unnamed)		0.001	207		112.3	100?		11		57	—	
VI†	Barnard, 1892	0.076	605			250	16		0.155		14.7	
VII†	Perrine, 1904	0.078	516		A few miles	260	1		0.207		17.5 to 18	
VIII*†	Perrine, 1905	0.157	2	14,620.0		739			0.38		17	
IX*†	Melotte, 1908	0.158	1	14,694.0	14?	745			0.248		18.6	
X†	Nicholson, 1914	0.077	334	7,192.3		254	5		0.1405		19	
XI*	Nicholson, 1938	0.150	834	14,028.0	A few miles?	692	12		0.2068		19	
XII*†	Nicholson, 1951	0.14†		13,000.0±		600±			Small		18.3	
<i>Saturn</i> I Mimas	W. Herschel, 1789	0.001	240	1	400-?		22	37	0.019	0.175	12.1	
II Enceladus	W. Herschel, 1789	0.001	590	9	400+?	1	8	53	0.0046	0.714	11.7	
III Tethys	J. D. Cassini, 1684	0.001	969	4	700+?	1	21	18	0.0	3.099	10.6†	
IV Dione	J. D. Cassini, 1684	0.002	522	4	900?	2	17	41	0.002	5.328	10.7†	
V Rhea	J. D. Cassini, 1672	0.003	522	6	1,100?	4	12	25	0.0009	11.42	10†	
VI Titan	Huyghens, 1655	0.008	166		3,500?	15	22	41	0.0289	607.6	8.3	
VII Hyperion	W. C. Bond, 1848	0.009	892	9	200?	21	6	38	0.119		15	
VIII† Iapetus	J. D. Cassini, 1671	0.023	797	6	1,000?	79	7	56	0.029		9 to 11†	
IX*† Phoebe	W. H. Pickering, 1898	0.086	593		50?	550	10	50	0.166		14	
<i>Uranus</i> I* Ariel	Lassell, 1851	0.001	282		1,000?	2	12	29	—		13.7	
II* Umbriel	Lassell, 1851	0.001	785	9	700?	4	3	28	—		14.5	
II* Titania	W. Herschel, 1787	0.002	930	3	1,000?	8	16	56	—		13.7	
IV* Oberon	W. Herschel, 1787	0.003	918	7	1,000?	13	11	7	—		13.8	
V* Miranda	Kuiper, 1948	0.000	825+		200?	1	9	50	—		17	
<i>Neptune</i> I*† Triton	Lassell, 1846	0.002	363	5	3,000?	5	21	3	—	1,800	14	
II Nereid	Kuiper, 1949	0.03±		3,500.0	200?	359±			0.76		19.5	

\* Motion retrograde. † Orbit highly inclined.

[Note: Satellite

diameters very uncertain.]

‡ Variable.

|| Steavenson.



## CHAPTER V

# MINOR PLANETS

A. F. O'D. ALEXANDER, M.A., PH.D., F.R.A.S.

### FIRST DISCOVERIES

**E**IGHTEENTH-CENTURY hopes of discovering one fair-sized planet between Mars and Jupiter were disappointed. Four dwarfs, each under 500 miles in diameter, were found instead: Ceres (by Piazzi, January 1, 1801), Pallas (by Olbers, 1802), Juno (Harding, 1804), Vesta (Olbers, 1807). A section through the centre of Ceres (the largest) would nearly cover the British Isles; through that of Juno (the smallest), Wales. Pallas boasts an orbit highly inclined (nearly  $35^\circ$ ) to the ecliptic. Vesta, the brightest (magnitude 6), is occasionally visible to the unaided eye. Though seen in small telescopes, they show disks only in very large instruments, and from their star-like appearance are often called 'asteroids.' Dr. Olbers (German amateur astronomer) suggested that they are fragments of a former planet which exploded, and that other fragments should exist. But mainly owing to the lack of satisfactory star charts, no more were found for thirty-eight years.

### ADDITIONS

After fifteen years' search Hencke discovered Astraea (1845). New star charts (used to find Neptune) helped the discoveries of Hebe (1847), Iris and Flora (from London, 1847), Metis (1848), Hygeia (1849), all with diameters less than 100 miles. Four more additions (1850) provoked the Royal Astronomical Society's comment that this rate of increase could 'hardly be expected to continue very long.' But by 1870 there were 109 with numbers, names,

and computed orbits; by 1890 discoveries totalled 287, all confined between the orbits of Mars and Jupiter.

Arguments over choice of names convulsed the 1850s. Purists opposed any but names of goddesses mentioned in the classics.

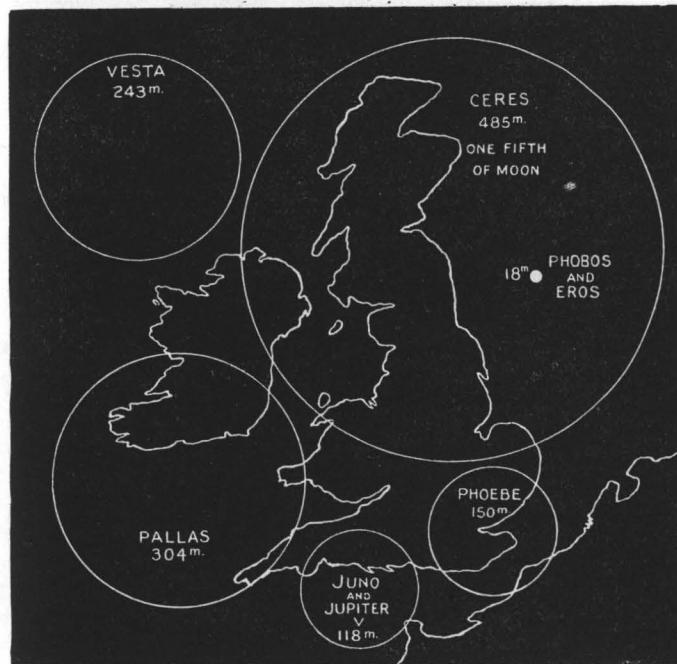

FIG. 85

Minor planets and satellites of planets (Jupiter V, Phoebe, Phobos) compared in size with the British Isles

(From *Splendour of the Heavens*, Hutchinson)

When Hind (London) discovered (1852) and named the twelfth asteroid 'Victoria,' but Americans rejected the name, substituting 'Clio,' the Astronomer Royal (Sir George Airy) was indignant. 'Angelina,' called after Von Zach's observatory at Notre Dame des Anges, undermined the classical tradition, and modern Philistines have plumbed the depths with 'Lagrangea,' 'Piazzia,' 'Pittsburghia,' 'Rockefellia,' 'Chicago'!

*Multiplication.* In 1891 Max Wolf (Heidelberg) discovered Minor Planet No. 323 by photography. In a time exposure of an hour or two with a photographic telescope guided on the stars, asteroids

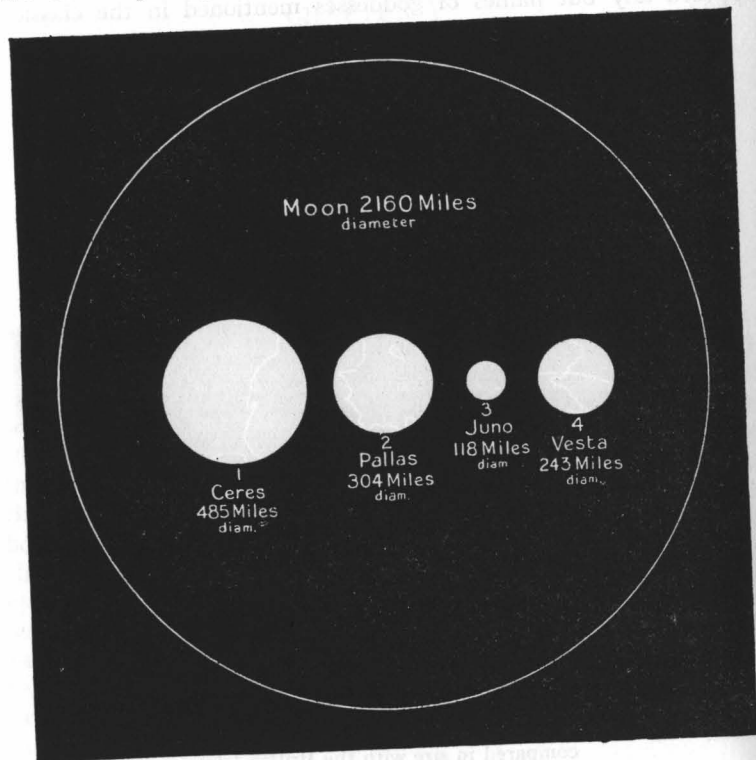

FIG. 86

The largest minor planets compared in size with the Moon.  
(From *Splendour of the Heavens*, Hutchinson)

(known also as planetoids) move sufficiently to register as little trails on the plate. This powerful new method ushered in the 'mass production' era of asteroid discovery. Within ten years Wolf and Charlois had found about 100 each, Palisa over 80, C. H. F. Peters over 50, all to be surpassed later by Reinmuth (Heidelberg) with over 80, including rediscoveries and single observations. But only 189

of Reinmuth's asteroids were numbered, compared with 228 of Wolf's eventual total of 582, for not only naming but numbering in order of discovery had to be abandoned. Nowadays some get names, usually feminine, but asteroids of special interest are given masculine names. Those with accurately computed orbits receive definitive numbers. Successive systems of provisional designation were, as Dr. J. G. Porter has shown,<sup>1</sup> swamped by the flood of discoveries: (1) year and letter—a few months used up the alphabet; (2) double alphabet—used up in 15 years; (3) double letter with year—the double alphabet was run through nearly thrice by 1925. Since then the double alphabet has been started afresh each year, the first letter denoting *half-month* of discovery (e.g. early February 1951: 1951 CA, CB, CC . . .). This allows for two new asteroids a day, with provision for excess. A Mount Wilson photographic search (1938) for additional satellites of Jupiter, revealed on the plates two new satellites and thirty-one new asteroids. By 1939 discoveries totalled 2,799, of which 1,489 had numbers. There were 216 discoveries in 1948 and 275 in 1949. The 1950 list contains 1,568 orbits.

Hubble estimated that the 100-inch telescope could photograph 30,000 if confined to this task; Baade's statistical estimate is 44,000. Most recent additions are very faint, the average magnitude at discovery by 1938 being 14.3. To compute a reliable orbit requires at least three accurate observations separated by several weeks. Only about 20 per cent of those found nowadays can be sufficiently observed, so the proportion with reliable orbits lessens as the total mounts. Losing them is hard to avoid; Aethra was missing 1873–1922, though specially searched for because of its very eccentric orbit. Frequent perturbations by Jupiter and Saturn make future movements of asteroids uncertain and complicated to calculate, but mass production methods have arrived with the American use of electronic computing machines.

*Eros.* Witt (Berlin) discovered (1898) the remarkable little planet known at first as DQ, temporarily in America as 'Pluto,' finally as 433 Eros. Its mean solar distance, 136 million miles, was the smallest then known for an asteroid, and it can come within 14 million miles of the Earth. Close approaches of Eros: 30 million

<sup>1</sup> *Journal of the British Astronomical Association*, 61, 1, 1950 December Presidential Address.

miles (1901), 16 million miles (1931), were used, like those of Victoria, Iris, and Sappho previously, to measure the astronomical unit (mean Earth-Sun distance). The method by which this is done is explained elsewhere.<sup>1</sup> At least eighteen asteroids show light variation in periods of about 3 to 9 hours, including Vesta, Iris, Eunomia, Sirona, and Tercidina. Eros (period about  $5\frac{1}{4}$  hours) is not always variable. F. G. Watson considers Eros is about 14 miles long, 4 miles wide, irregularly shaped and rotating about its minor axis. Van den Bos actually observed (1931) with a large refractor its shape and light change. When the Earth is in Eros's equatorial plane, end and side views alternating produce large light change; when a pole faces earthward, variation is inappreciable. Such asteroids may be irregular splinters of a fragmented planet.

*Albert group.* No. 719 Albert, 887 Alinda, and 1036 Ganymede (not Jupiter's satellite) form a group of planetoids with very eccentric orbits. They travel out almost to Jupiter's path and in almost to the Earth's. Though remaining outside the Earth's orbit they move, owing to their orbital eccentricity (about 0.54), faster than the Earth when near it, so, like Eros, they can be in opposition without appearing to move backwards. Ganymede's orbital inclination to the ecliptic is considerable ( $26^\circ$ ). Their close approaches to the Earth's orbit about every four years might sometimes make them useful for measuring the astronomical unit, but Albert, very faint, is missing since its brief discovery visit (1911). Jupiter may have pulled it into a different path.

*Near visitors.* Some recently discovered asteroids come much nearer the Earth than Eros does. No. 1221 Amor, found (1932) by Delporte (Belgium) who recovered it (1940) from the computed orbit, was only about 10 million miles away at discovery and has a large eccentricity (0.448). Though not crossing the Earth's orbit, Amor overtakes and passes us, moving nearly 30 per cent faster than the Earth. This asteroid can have three oppositions at one visit, the middle one when it overtakes the Earth, the others when (from the Sun's viewpoint) the Earth appears to overtake Amor.

Apollo, found (1932) by Reinmuth, came within about 2 million miles of the Earth and was the first asteroid with an orbit known to extend inside those of the Earth and Venus. Such planets are both exterior and interior; Apollo, best seen at opposition, can have

<sup>1</sup> See page 72.

inferior conjunctions and transit the Sun, though far too small to be then visible.

Adonis, another Delporte discovery (1936), was about a million

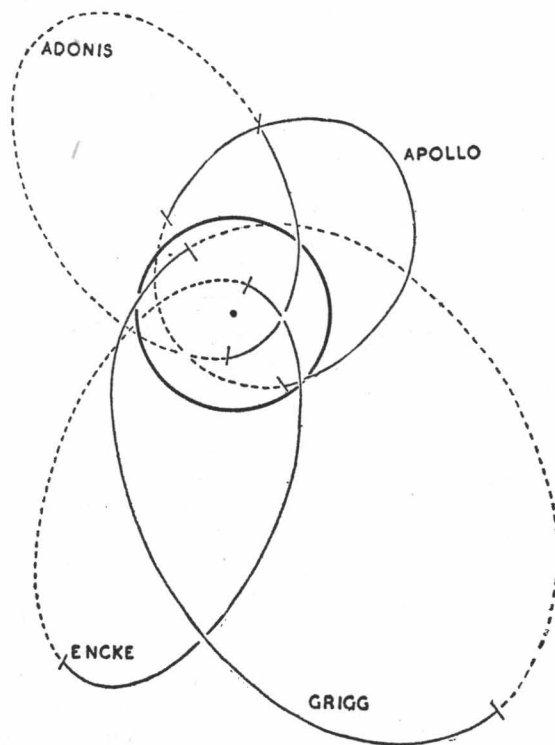

FIG. 87

Earth's orbit (dark circle) with the orbits of the planetoids Adonis and Apollo and the comets Encke and Grigg. All the orbits are in different planes, each intersecting the Earth's orbit-plane at only two points, the nodes (shown by cross lines). Parts of orbits south of the Earth's orbit-plane are dotted.

(Dr. J. G. Porter's diagram in *Journal of the British Astronomical Association*, 61, 1, page 13.)

miles from the Earth on a most eccentric orbit (0.779) extending from a little outside Mercury's to twice Mars's solar distance. Icarus, detected June 1949, comes much nearer the Sun (within 18 million miles) than Adonis, yet at aphelion is 183 million miles



distant, farther than Mars. Its extremely eccentric orbit (0.827) has also a high ( $23^\circ$ ) inclination.

Hermes, nicknamed 'Earth-grazing planet,' discovered and photographed as a long trail (1937 October 28) by Reinmuth, came within 400,000 miles of the Earth, less than twice the Moon's distance. On 1937 October 30 Hermes (magnitude 8) hurtled past the Earth at  $5^\circ$  an hour on the sky, so fast that normal mathematical methods of computing its distance broke down, and this had to be deduced from its observed parallax as between two observatories. Hermes appeared to traverse the whole sky in nine days.

Though these close-approaching asteroids have periods less than three years, observation was too brief for reliable orbits; hence they have no numbers. Adonis, Apollo, and Hermes are all lost. The only hope of recovery is the chance of their again crossing the Earth's orbit near the Earth. Their passage was too near and fast to help correct the astronomical unit. Close approaches of Icarus to Mercury and of Sirene to Mars may, however, supply better values for the masses of these two major planets. Hundreds of such 'flying mountains' (perhaps only a mile wide) may cross the Earth's orbit, and if one hit the Earth great local devastation would result. But the chance of a direct hit is extremely remote, and collisions probably occur less often than once in 100,000 years.

*Kirkwood's gaps.* D. Kirkwood showed (1866) that planetoids were scarce at mean solar distances where their orbital periods would be a simple fraction of Jupiter's. He inferred that the cumulative effect of Jupiter's pull repeated at regular intervals would force them into other orbits, and gaps would occur like Saturn's ring divisions. Mounting discoveries tend to close some of Kirkwood's gaps, but they are still conspicuous at periods  $\frac{1}{3}$ ,  $\frac{2}{5}$ ,  $\frac{3}{7}$ ,  $\frac{1}{2}$ , and  $\frac{2}{3}$  of Jupiter's period, and the huge accumulation of asteroids with a period just under half Jupiter's—the Hecuba group, 400 strong—recalls the brilliance (probably through massed particles) of Saturn's ring B just inside Cassini's division. Since Kirkwood's time, *groups* instead of gaps have been found with period ratios to Jupiter's of  $\frac{2}{3}$ ,  $\frac{3}{4}$ ,  $\frac{1}{2}$ , and Professors E. W. Brown and K. Hirayama have shown that other forces as well as Jupiter's attraction must operate to account both for gaps and clusterings.

*Hirayama's families.* By mathematical investigation of orbits Hirayama identified five families of asteroids which he named, after

the first discovery in each, the Flora, Maria, Coronis, Eos, and Themis families, their orbital periods being near  $\frac{2}{7}$ ,  $\frac{1}{3}$ ,  $\frac{2}{5}$ ,  $\frac{3}{7}$ ,  $\frac{1}{2}$  of Jupiter's, respectively. For each family he found common characteristics in the orbits such as to give a strong presumption of a common origin of the members.

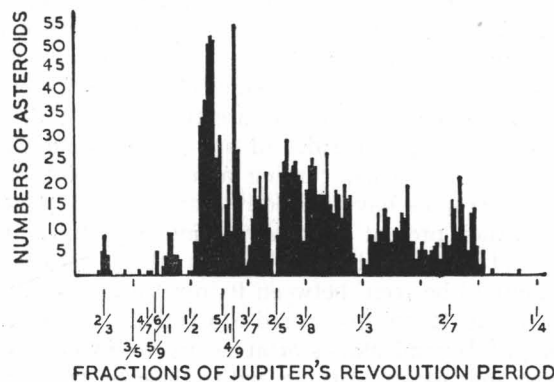

FIG. 88

Planetoid period groups and Kirkwood's gaps  
(Dr. J. G. Porter's diagram in British Astronomical Association's *Journal*, 60, 1, page 8.)

*Period groups.* Groups of asteroids of like period, but not necessarily common origin, include (besides the Hecuba and Trojan groups) the large Hestia and Minerva groups and smaller Hilda group with periods near  $\frac{1}{3}$ ,  $\frac{2}{5}$ ,  $\frac{2}{3}$  of Jupiter's period, respectively.

*Trojans.* A minor planet with period ratio  $\frac{3}{4}$  was named 'Thule,' being considered the outermost, until the discoveries (1906 onwards) of the interesting Trojans, sharing Jupiter's period. They are named after heroes of the Trojan war, Trojan and Greek, but with Hector and Patroclus placed in the wrong camps! They illustrate one of Lagrange's theoretical solutions of the Problem of Three Bodies: a large body, a smaller one, and an infinitesimal body of negligible mass, if situated at the points of an equilateral triangle, would remain in that relative position, each revolving about the centre of gravity of the system. But the Trojans do not strictly obey the law, for they have mass, are perturbed by Saturn and other planets, and where two have similar oscillation periods they affect

each other. So one equilateral triangle is formed by the Sun, Jupiter, and a point on Jupiter's orbit,  $60^\circ$  in front of that planet, about which seven Trojans oscillate; another by the Sun, Jupiter, and a similar point  $60^\circ$  behind Jupiter with five Trojans near it.

A thirteenth Trojan is suspected. Their orbits are normal ones, concave to the Sun, but differing from Jupiter's in eccentricity and inclination. The oscillations are slow, long-period movements, and though each set has a common centre of oscillation, collisions are unlikely, for they are tiny bodies (magnitude 14; diameter probably a few miles) swinging in different directions. Two, Priamus and Patroclus, are on opposite sides of an ellipse round which they travel in about 150 years, turning about the point  $60^\circ$  behind Jupiter. The Trojans have perfectly stable motion which should keep them in their present orbits almost indefinitely. Jupiter may eventually capture and add to the Trojans other asteroids that may exist, too faint to be seen, between its orbit and Saturn's.

*Hidalgo.* Baade (1920) discovered 944 Hidalgo, travelling in 13.9 years from just beyond Mars's orbit nearly to Saturn's and back, its apparent magnitude varying with distance from 10 to 19. Hidalgo's eccentricity is 0.656 and its orbital inclination ( $42^\circ.6$ ) exceeds even Pallas's, resembles those of comets, and protects it from near approaches to Jupiter and Saturn.

*Mass and orbits.* From the sizes of the larger and the brightness of the smaller planetoids Watson estimates that all together would make a body of diameter 600 miles, only about 5 times Juno's diameter, with mass about  $\frac{1}{4000}$  of the Earth's mass. Asteroid revolution periods range mostly from  $3\frac{1}{2}$  to about 6 years, the commonest period being just under half Jupiter's. Of 1,568 asteroids with orbits determined, 97 per cent have mean solar distances between 195 and 288 million miles. Orbital eccentricity averages 0.15, larger than those of major planets except Mercury and Pluto while individuals have eccentricities 3 to 6 times this average. Long-period asteroids with large orbits, except Hidalgo, have small eccentricities. The average orbital inclination to the ecliptic is  $9^\circ.7$ , exceeding that of any major planet except Pluto; a few lie almost in the ecliptic plane, while a few have inclinations above  $30^\circ$ . Yet they are typical planets in having in every case direct motion round the Sun, whereas many comets have retrograde motion. The commonest direction (from the Sun) of asteroid perihelia is that of

Jupiter's perihelion; fewest perihelia are in the opposite direction—one more indication of Jupiter's dominant influence.

*Origin.* Leuschner suggested (1927) that short-period comets, having lost their gases by solar radiation pressure or electrical repulsion, may become asteroid families. But recent work by Oort supports Olbers's theory of asteroid formation by disruption of a larger planet, and Kuiper cites their multitude, irregular shapes, and relation to meteorites in favour of planetary disruption, probably by collision rather than explosion, rapid rotation, or tidal forces. Kuiper considers the largest (e.g. Ceres) may be true original planets; 5 to 10 may have been formed in the zone  $2-3\frac{1}{2}$  astronomical units from the Sun. Assuming orbital inclinations under  $5^\circ$  and eccentricities about 0.1, the chance of two colliding during the solar system's life (say,  $3 \times 10^9$  years) would be 1 in 10. A single collision would encourage further collisions; the Hirayama families by retaining their family relationship, in spite of perturbations, by Jupiter in particular, suggest their formation from relatively recent collisions.

*Roche's Limit.* If a small body which consists of a loose agglomeration of matter with little or no coherence and held together merely by its own gravitation, approaches a more massive body, at a certain distance apart the smaller body will be disrupted. Suppose that the density of the smaller body is  $1/\rho$  that of the larger body whose radius is  $r$ , then when the distance between the centres of the two bodies is  $2.44 r \sqrt[3]{\rho}$  the smaller body will be disrupted. This distance is known as Roche's limit, after Roche, who investigated the subject. If the smaller body were in the form of a solid rock where cohesion is responsible for holding it together the above results would not be valid.

In the case of Saturn, whose radius is about 37,500 miles, the distance of Roche's limit from its centre is  $91,500 \sqrt[3]{\rho}$ . Since Mimas (see page 208) is 115,000 miles from the centre of Saturn, it would disrupt if  $91,500 \sqrt[3]{\rho} = 115,000$ , or  $1/\rho = 0.5$  that of Saturn's density. As Mimas shows no signs of disintegration it may be assumed that its density exceeds 0.5 that of Saturn, or 0.35 that of water. The corresponding figures for a satellite at the distance of the outer ring are just over 0.84, for the satellite to survive.

# CHAPTER VI

## COMETS, METEORS AND METEORITES

M. DAVIDSON, B.A., D.S.C., F.R.A.S.  
Formerly Director of Comet Section, British Astronomical Association

### I. COMETS

#### PECULIARITIES IN THE ORBITS OF COMETS

COMETS have been described as lawless members of the solar system—and the title is not inappropriate. All the planets, all the known minor planets, and most of the satellites revolve around their primaries in the same direction, but this rule of the road is defied by the comets, approximately half of them revolving round the Sun in one direction and the other half in the other direction. In another way they display utter carelessness about celestial regulations; unlike the planets whose orbits are inclined at fairly small angles to the plane of the ecliptic (the inclinations of some of the minor planets are much greater than those of the planets), comets move in orbits which are inclined at all angles between  $0^\circ$  and  $90^\circ$  to the ecliptic plane.

Another peculiarity about the orbits of comets is that they are usually very elongated ellipses and in this respect also they differ completely from the planets, though not so much from the planetoids, some of which have also elongated elliptical orbits.

These peculiarities are quite apart from their revolutionary appearance, unique amongst bodies in the solar system (see page 225 ff.).

Fig. 89 shows the usual orbit of a planet and also of a comet, the former being practically circular and the latter very elliptical.  $E$  is the Earth, the arrow indicating its direction of motion around the

Sun  $S$ , and  $C$  represents the comet which, as will be seen, is moving in a direction opposite to that of the Earth. The orbits of both bodies have been drawn in the plane of the paper, but of course it is very exceptional for a comet's orbital plane to coincide exactly with that of the Earth. The comet makes its closest approach to the Sun at  $P$ —the distance  $SP$  is called its *perihelion distance*, meaning nearest to the Sun—after which it recedes from the Sun, and after a fairly long time which varies for different comets, but may be

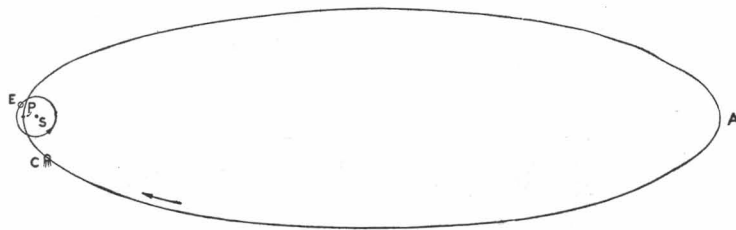

FIG. 89

The paths followed by a planet and a comet. The small circle represents the Earth's orbit and the ellipse the orbit of a comet—in the present case Halley's Comet. While many orbits of comets are not as elliptical as that of Halley's Comet, many are more elliptical.

anything from a few years up to many thousands of years, it arrives at  $A$ , its greatest distance from the Sun. The length of  $SA$  is known as the comet's *aphelion distance*, and one example will show how very much greater it usually is than the perihelion distance.

One of the most famous comets is Halley's, which made its last return nearest the Sun in April 1910. Its perihelion distance  $SP$  is 54 million miles and its aphelion distance  $SA$  is about sixty times as great as its perihelion distance, so at its greatest distance this comet is farther off from the Sun than Neptune, while at its least distance it is nearer to the Sun than Venus. Its period is about seventy-six years, but this varies owing to disturbances by the planets.

Although in most cases the orbits of comets are ellipses there are some exceptions to this statement, and at this point it will be necessary to digress to explain the nature of three different kinds of curves.



## DIFFERENT CURVES IN WHICH A COMET MAY MOVE

Fig. 90 shows three orbits in which a comet could move; actually a comet could also move in a circular orbit, but no such case has ever been known, and the probability of a comet (or any other

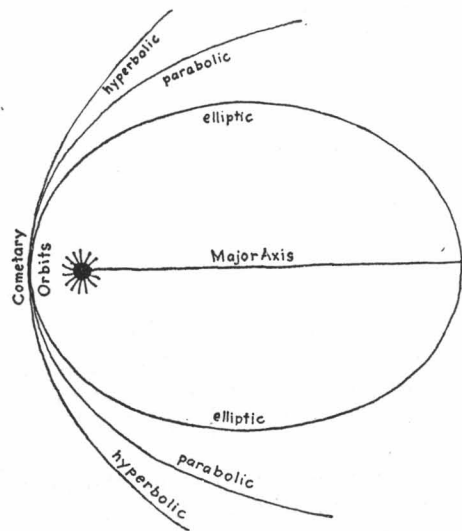

FIG. 90  
The different paths in which a comet may move  
(From *Splendour of the Heavens*, Hutchinson)

heavenly body) moving in an exact circle is so remote that such an orbit need not be considered. In the figure the inner curve is an ellipse, and it will be seen that it is a closed curve whereas the other two are not closed. Hence if a body—a comet or a planet—moves in an ellipse, it returns to certain positions on the curve at definite times which can be easily calculated. For instance, the Earth moves in an elliptical orbit around the Sun, and each year about 4th January it reaches its perihelion point, and about 4th July its aphelion point. Similar results are known for the other planets, and also for a large number of comets for which orbits have been computed. But if a comet moves in either of the other orbits

shown—a parabola or a hyperbola—it never returns on its former track, passing away from the solar system out into the remote depths of space to return no more. Something will be said later about these latter comets, which are in the minority.

An ellipse is easily drawn by inserting two pins in a piece of paper, passing a loop over them, and then moving a pencil round the paper, the point maintaining the string stretched tightly. (See Fig. 91.) Each pin occupies one focus of the ellipse, and by varying the distance between the pins or altering the length of the string any number of ellipses can be drawn. The Sun occupies one focus of the ellipses which the planets and comets describe in their revolutions, the other focus being empty, that is, there is no heavenly body

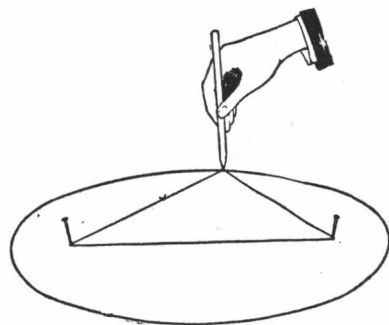

FIG. 91

Method for drawing an ellipse. (Reproduced from Davidson's *Elements of Mathematical Astronomy* (Hutchinson).)

in this other focus. It will be seen that the type of curve described by the members of the solar system is the same, that is, an ellipse, and hence the orbits of the various members differ not in kind but merely in degree, in other words, the ellipses traced out by comets are more elongated than those traced out by the planets, and in a few cases the latter ellipses can scarcely be distinguished from circles.

Returning to the other curves, the parabola and the hyperbola, if a comet moves in a very elongated ellipse it resembles a parabola for a considerable portion of its orbit. It will be seen from Fig. 90 that in the neighbourhood of perihelion there is little to distinguish the elliptical and parabolic paths; a short distance from perihelion, however, the paths are seen to separate. The same remarks apply to the hyperbolic path, and it may now be pointed out that while both parabolic and circular orbits are possible, no case has ever been found where such orbits exist. The reason is that it is extremely improbable that a body should move in either of these orbits; if it moved in a circle the very slightest disturbance from the

attraction of another planet, or even from a satellite, would cause it to move in an ellipse, and although it might be difficult to detect the elliptical motion, the fact remains that the orbit would cease to be a circle. For similar reasons, if a body moved in a parabola the slightest disturbance would throw it into an elliptical orbit on the one side or into a hyperbolic orbit on the other side, as shown in Fig. 91 where the parabolic orbit is seen lying between those that are elliptical and hyperbolic. Hence we may consider only two orbits of comets: the elliptical—by far the most numerous—and the hyperbolic.

#### HOW COMETS ARE EJECTED FROM THE SOLAR SYSTEM

It is remarkable that in every case in which a comet has been found to be moving in a hyperbolic orbit, one or more of the planets has been responsible for making it move in such an orbit. At first it was moving round the Sun in an ellipse, but on coming too close to a planet or planets its path was disturbed by the attraction of these other bodies, and it was thrown first of all into a parabolic orbit in which it moved for a very short period, and then from the parabolic orbit it was thrown into a hyperbolic orbit. When this took place the comet moved in a curve something like the outer one in the figure—a curve which does not close in on itself like an ellipse—and disappeared for ever from the solar system. In this way a number of comets that were members of the solar system have been lost to it, expelled by some of the planets, and once a comet is thus expelled there is no hope of its return again. Even if a comet is not expelled from the solar system its period can be considerably altered by the disturbances (known as perturbations) by the planets.

A comet moving in a very elongated ellipse has a speed of almost 26.1 miles per second at a distance of one astronomical unit from the Sun. If its speed exceeds 26.1 miles per second, as it might do through planetary perturbations, its orbit is hyperbolic and it will leave the solar system. If it is  $18\frac{1}{2}$  miles per second—the same as that of the Earth at its mean distance from the Sun—its orbit will be practically a circle, and between  $18\frac{1}{2}$  and 26 miles per second its orbits will be ellipses which become more elongated the higher the velocity. (See page 261.) A speed of exactly 26.1 miles per second

implies parabolic motion but, as already remarked, such an orbit is extremely rare.

#### COMETS FORMERLY OMENS OF DISASTER

In ancient times, and also in medieval times, comets were regarded as heralds of some disaster, and even to-day amongst the superstitious they are sometimes regarded with forebodings of catastrophe—war, earthquakes, epidemics, etc. The appearance of Halley's Comet in A.D. 66 was a warning to the Jews of the coming destruction of Jerusalem, and when it appeared in 1066 it was regarded as an omen of the conquest of England by the Normans. While the superstitious dread has largely disappeared from civilized races there is a more reasonable fear of a collision with the head of a comet, or of being poisoned or of the Earth being burnt up by the gases in its tail. In connection with this latter dread the following story is interesting.

Before Halley's Comet reached the perihelion towards the end of April 1910, astronomers believed that the Earth might possibly pass through its tail, and in a town in the interior of Asia Minor the report of this contingency created considerable alarm amongst the inhabitants. Many were convinced that their safety could be ensured by immersing themselves up to their necks in water to avoid the baneful effects of the tail, and as the comet drew closer to the Earth barrels of water were in evidence everywhere. It does not appear, however, that they were used!

The danger of fire or asphyxiation from the gases in the tail of a comet is non-existent, but the possibility of a collision with the head of a comet cannot be entirely ignored, though the probability of such an occurrence is extremely remote. What would happen if the Earth encountered the head of a comet? Before answering this question we shall describe the composition of a comet, and from this description readers will be better able to judge of the extent of the disaster that would ensue from such an encounter.

#### COMPOSITION OF COMETS

The most harmless portion of a comet is that which is usually the most visible and on some occasions the most terrifying—the

tail. The part that is smallest—the nucleus—is actually the most dangerous, not because it is a massive solid body like a minor planet, but for other reasons. The nucleus consists of an aggregation of small particles of varying sizes, some like specks of dust, others like pieces of rocks, and others very much larger, perhaps the size of a house, with all intermediate dimensions. These particles are not in contact but are spread out, and in some cases may occupy a volume similar to that of a planet. On September 12, 1909, the diameter of the nucleus of Halley's Comet was about 6,000 miles, and although there is no danger of the nucleus of this comet colliding with the Earth (the same remark does not apply to the tail) there is always the possibility that a comet may appear whose orbit brings it into proximity with the Earth. A nucleus spread out as is the nucleus of Halley's Comet would be more likely to encounter the Earth than would minor planets, as the diameters of many of these bodies are only a few miles, though many are considerably larger than this. For this reason we must not entirely rule out the possibility of a collision with the nucleus of a comet, but, as just remarked, the probability of this taking place is extremely remote.<sup>1</sup> In addition, recent investigations on the nuclei of comets show that their diameters are often comparable with those of the larger minor planets, a few hundred miles, and this small size diminishes the chance of collisions, in comparison with large nuclei, as in Halley's Comet. (See, however, Appendix XII.)

The next part of a comet is the coma; this is a foggy-looking disk surrounding the nucleus, which nearly always enables the astronomer to distinguish a comet from a minor planet or a star. Although the coma looks like a disk it is more or less spherical in shape; the Moon seen with the naked eye, or the planets viewed through a telescope, have the appearance of a disk because it is impossible to see the other side of the spheres. The coma varies considerably in size in different comets and also according to the distance of the comet from the Sun. It is gaseous and is caused by the heat of the Sun acting on the nucleus, which then exudes various gases which have been identified by means of the spectroscope. Carbon

<sup>1</sup> This view about the danger of a collision with the nucleus of a comet may require modification in the future. If the nucleus contains large bodies that would cause serious damage by colliding with the Earth it is remarkable that no meteorites have yet been associated with the debris of comets. (See pages 253-4.)

monoxide, cyanogen, gases of different metals such as sodium, iron, nickel, etc., have been detected in the coma, and, as might be expected, the gases from the metals appear as the comet approaches the Sun and its nucleus is subjected to a higher temperature.<sup>1</sup> In some cases the coma is very large; thus that of the great comet of 1811 was about a million miles in diameter, but this is exceptional, and perhaps a fair average size of the coma might be considered comparable with that of one of the giant planets, say 50,000 miles in diameter.

There seems to be a marked contrast between the spectra of new comets and old comets, which is due to some difference in the nucleus and coma. This is clearly shown by comparing the spectrum of Comet Encke—an old comet—with that of a new comet such as 1942 IV. Using the 82-inch reflector at the McDonald Observatory, Texas, it was found that the latter comet had an almost continuous spectrum, which showed that there must have been dust reflecting the sunlight. The spectrum of Encke's Comet, on the other hand, showed the weakness of the continuous light, indicating that its head consisted almost entirely of gas. The same thing has been observed in other cases and it seems that the older the comets the less dust they retain in their head.

Stars have been telescopically observed and also photographed through the heads of comets (the head of a comet includes its nucleus and coma) and little or no diminution of brightness has been noticed, nor have refraction effects been detected even when the light of the stars passed through the nuclei.

The tail of a comet develops as the object approaches the Sun, though in many cases scarcely any tail is visible to the naked eye. The gases exuded by the nucleus form the coma and these gases in turn stream away from the coma to form the tail, carrying along with them very small particles like dust which are also continually renewed from the nucleus. The tail of a comet always points away from the Sun, and this is due to the effect of light repulsion upon the minute particles. It has been shown that this repulsive effect exceeds that of the gravitational attraction of the Sun when the particles are very small—of the order 0.00004 inch in diameter—but this varies with the density and also with the power of the material

<sup>1</sup> In the list of works which can be consulted for further information (see page 261) will be found some which deal very fully with the spectra of comets.



to absorb the light of the Sun. As the comet comes closer to the Sun the nucleus becomes hotter, gases are exuded in greater quantities, the coma becomes larger, and the light pressure from the Sun drives off more gases which carry with them fine dust. These reflect the light of the Sun so that the coma becomes more distinct and the gases and dust stream away from the coma to form the tail—usually the most spectacular part of a comet. Sometimes these tails attain great lengths, and if the comet lies between the Sun and the Earth we may pass through the tail; this happened on May 19, 1910, when the Earth passed through the edge of the tail of Halley's Comet. Although a careful watch was maintained, especially in America, for any possible meteorological effects which could be caused by the tail, there is no certainty that the haloes, coronas, and various other effects observed were due to the tail of the comet, because they were frequently seen when there was no comet to which they could be attributed. A peculiar phosphorescence of the sky was noticed when the Earth passed through the tail of a comet in 1861, and there would be nothing improbable in the tail being responsible for this. Owing to the very attenuated condition of the gases in the tail of a comet the danger of being poisoned by cyanogen—which certainly exists in many cases in the tail—is infinitesimal and alarmist reports on such matters should always be discounted. The tails are visible partly because of the reflected sunlight and partly because the diffuse molecules absorb the light and re-radiate it, a phenomenon which also occurs in the case of some of the gaseous nebulae.<sup>1</sup> Sometimes comets do not appear to have tails, or if they have they are too faint to be seen, and in other cases tails may be 150 million miles in length or even longer—the tail of the great comet of 1843 was nearly 200 million miles long. On May 5, 1910, the tail of Halley's Comet, measured at Mount Hamilton, was estimated to be nearly 30 million miles in length and within a few weeks it had increased to about three times this length. It should be emphasized that tails are not definite parts of comets but are continually changing streams of very diffuse gas and dust particles, which sometimes break off from the comet and disappear.

Within recent years there has been increasing evidence of corpuscular streams shot off from the Sun, affecting the tails of

<sup>1</sup> See pages 342-3.

comets and in some cases producing a sudden and high acceleration in the tails. It is also suspected that increased ultra-violet radiation is sometimes responsible for causing a sudden increase in the brightness of comets. Comet Schwassmann-Wachmann I, whose orbit is nearly circular, seems to be susceptible to such changes, and when this last took place in 1946 January a very large sunspot appeared on the hemisphere of the Sun which was turned towards the comet. While there is no proof that the sudden increase in brightness was due to increased ultra-violet light, this in turn being due to the sunspot, nevertheless there are sufficient grounds for suspecting the connection.

#### MASSES OF COMETS

The mass of a comet is concentrated in its nucleus, and for various reasons it is known that the mass of the nucleus is extremely small in comparison with that of any of the planets. It is impossible to estimate the exact mass of a comet; the planets can be very easily weighed if they have one or more satellites, but in the case of Mercury, Venus, and Pluto, which have no satellites, the problem is more difficult as their masses can be determined only by their perturbations on some other planet or planets or on comets, and this method cannot always supply very exact figures. Estimates of the mass of Halley's Comet suggest that it could not have been less than 30 million tons, or greater than 10,000 million million tons. There is an enormous range between these figures, but if we take the higher value the mass of a comet would be comparable with that of a minor planet with a diameter of 100 miles. It has already been pointed out that the nucleus of Halley's Comet was 6,000 miles in diameter on September 12, 1909; but after this it decreased as the comet approached the Sun and towards the end of April 1910 its diameter was only 2,300 miles. After this it still continued to decrease until 23rd May when its diameter was less than 300 miles. While the coma usually increases in size and brightness as a comet approaches the Sun, the tail at the same time increasing in length, the nucleus often decreases. At the time of minimum diameter of the nucleus of Halley's Comet, even allowing for the maximum mass given above, its density must have been very much less than that of water, which shows that under the most favourable conditions

the matter composing the nucleus must still have been a loose aggregation of particles. It must be admitted, however, that the dimensions and masses of the nuclei of comets cannot be determined with great accuracy. (See Appendix XII.)

#### HAVE THE NUCLEI OF COMETS EVER STRUCK THE EARTH?

If a comet collided with the Earth at any time during the early geological periods the crater that it would have produced would probably long since have been effaced, but this would not necessarily happen if the collision took place in comparatively recent times. It was once believed that such a collision happened in 1908, but the original view that the phenomenon, which was accompanied by considerable devastation, was due to the impact of the nucleus of a comet, is now discredited, and the phenomenon was caused by a meteorite (see page 253). The circumstances are briefly as follows.

On June 30, 1908, a large meteorite fell in north central Siberia and devastated about a thousand square miles of forest, killing a large number of deer at the same time. It happened in a part of Siberia which was sparsely inhabited and it was many years before any real investigation of the crater and the damage to the surrounding country could be carried out. In 1927 Professor L. A. Kulik of the Russian Academy of Science led an expedition to the place (for various reasons there was a considerable delay in the investigation), and the following is a short summary of the effects of the collision of the Earth with the meteorite.

In the place where the meteorite fell, about longitude  $101^{\circ}$  E. and latitude  $60^{\circ}$  N., rivers, swamps, and forests are very much in evidence, and the swampy nature of the ground where impact occurred made some of the investigations very difficult. A shallow depression about two miles in diameter had been produced, and inside this there were about two hundred 'craters' which resembled shell holes, a few about 50 yards in diameter, some only a yard or two, with others intermediate in size. The depression must have been caused by the compressed air in front of the missile, which may have consisted of a number of separate bodies moving closely together. On the other hand, it may have been one solid body which disintegrated owing to atmospheric resistance before it struck the ground—a more probable view. Within the three square miles

of the shallow depression the trees had been destroyed, but the greatest damage was done outside the area of direct impact, and this was obviously due to the blast of hot air from the body rushing rapidly through the atmosphere. On all sides for miles around the trees were lying with their tops turned away from the depression, and where a few trees had survived the blast and remained standing in places that were partly protected, they were stripped of their bark and branches. A very interesting fact is that all the trees—those that had been blown down as well as those that remained standing—were seared, showing the intense heat developed in the disturbed atmosphere. The total area affected had a diameter of 30 to 40 miles.

Several eye-witnesses of the phenomenon gave descriptions of what they saw and heard. Some saw a circular glow at a distance of nearly 400 miles; this was bluish, about half the size of the Moon, and moving rapidly, and the bluish track left by the body along the greater portion of its path remained for some time, gradually disappearing. The passage of the body through the atmosphere was accompanied by a terrific noise like a cannonade which completely demoralized a number of boatmen on the Angara River. A native Tungu lost most of his herd of 1,500 deer which were feeding near the scene, and another native at a greater distance from the spot where the meteorite fell had the top of his hut blown away.

On the day of the fall of this meteorite the Earth was very close to the orbit of Comet Pons-Winnecke; this does not imply that it was necessarily near the comet itself but merely that it was close to the track along which the comet had moved. The assumption was that a portion of the nucleus had become detached from the agglomeration, and following on in the path of the main nucleus, had collided with the Earth. The evidence, however, did not support this view because a fragment of the nucleus of Comet Pons-Winnecke would have been moving from the N.N.W. but the body that caused the devastation was moving from the S.S.W. It is just one of those coincidences that have occurred in the realm of astronomy—and there are several others—and if the meteorite had been moving in the correct direction it is practically certain that it would have received the credit of being a portion of Comet Pons-Winnecke. This is an illustration of the necessity for exercising great care before drawing conclusions. Readers must

not, however, assume that astronomers are easily misled or that they are prepared to accept theories without subjecting them to the most comprehensive scrutiny; amongst men of science it is doubtful whether there are any who have the critical faculty more developed than the astronomers!

This digression on the large meteorite—seriously believed for a time to be a fragment of a comet—has been introduced to confirm what was previously said about the effects of the collision of the nucleus of a comet with the Earth. If the meteorite had fallen in a thickly populated area there would have been an appalling loss of life and property—probably very much greater than would be effected by an atomic bomb. But the devastation caused by a large meteorite is insignificant in comparison with what would be caused by a collision with the nucleus of a comet which, being spread out over a large volume, would devastate many parts of the Earth. (See, however, footnote on page 226.)

#### THE ORBITS OF COMETS

When three observations of a comet have been made, the intervals between the observations differing by two or three days, it is possible to compute a rough orbit, but observations over a much longer period—several months in many cases—are necessary to obtain a very reliable orbit. It has been shown that six elements are essential in an orbit of a planet to enable its position at any time to be computed, and the same applies to a comet. It may be pointed out, however, that in accordance with Kepler's third law, the semi-axis major can be found from the periodic time and vice versa, so that only five elements are generally necessary. Where perturbations by planets have to be taken into consideration, which is often the case when very accurate results are required, all the elements require revision, and the computations in these circumstances are tedious. In such cases the comet does not move in an exact ellipse or in any regular curve, but if it does not make a close approach to a giant planet the computations of the perturbations can be dispensed with, practically elliptical motion being assumed. The orbits of about 750 comets have been computed and every year new comets are discovered—an average of about four a year,<sup>1</sup> though in some years

<sup>1</sup> This is the average over the last twenty-one years.

the figures are much higher—orbits being generally computed if the objects can be kept under observation for a sufficiently long time. Occasionally, however, circumstances are unfavourable for this and the comet disappears before its orbit can be computed.

Comets are roughly divided into two classes: (a) those with long periods which may run into anything from a hundred to many thousands of years; (b) those with short periods under which may be included Encke's Comet, period  $3\frac{1}{3}$  years, and Halley's Comet, period 76 years, with many others with intermediate periods. Most of the short-period comets have direct motion (Halley's Comet and a few others are exceptions), and it has been suggested that they have some connection with the different giant planets. The following figures for Halley's Comet will explain this so-called connection.

It has been shown at the beginning of the chapter that Halley's Comet is about sixty times as far from the Sun at aphelion as it is at perihelion, which implies an aphelion distance of about 3,300 million miles. The mean distance of Neptune from the Sun is nearly 2,800 million miles, and this approximate correspondence in distance suggests some connection between the comet and the planet. The same thing applies to the other giant planets, each of which has its 'family' of comets, Jupiter's family being by far the largest with more than fifty members.

Many bright naked-eye comets have very long periods whereas most of the short-period comets are faint telescopic objects. This is easily explained by the fact that comets lose some of their material on each return to perihelion, and as these returns are infrequent in the case of long-period comets they retain their material longer than the short-period comets and hence appear brighter. Halley's Comet, which is included amongst the short-period comets, is an exception as it is a bright object, but ancient records suggest that it was much more spectacular for several centuries after its discovery than it has been in the last few centuries.

#### ORIGIN OF COMETS

An explanation of the short-period comets has been advanced which is worth mentioning, though it is not now considered tenable. This theory suggests that the short-period comets were once long-period comets which came too close to some of the giant planets



and were annexed as parts of their families. The annexation does not imply that the comets revolve around some of the giant planets instead of the Sun; the theory postulates that the comets were so attracted by the planets that instead of moving in very elongated ellipses they were made to move in ellipses with shorter major axes and therefore to complete their revolutions around the Sun in a shorter time. Unfortunately for the theory, it requires that the comets should pass very close to some of the giant planets for this annexation to take place, and the probabilities in favour of such close approaches for the short-period comets are extremely small. Thus it has been estimated that Jupiter would require many thousands of years to annex even one comet, and as comets wear out fairly rapidly it seems that Jupiter's family would become defunct much more rapidly than they could be annexed. The same applies to the other giant planets and, with the exception of Jupiter, there is now considerable doubt regarding these 'families' associated with these planets; the so-called association may be only a coincidence.

Another theory of the origin of the short-period comets is that they were ejected by the giant planets during periods of intense activity—the great Red Spot<sup>1</sup> already referred to is a case of some form of gaseous activity on Jupiter. Underneath the cold exterior of the giant planets there may be less cold gaseous layers, and from these, during periods of abnormal eruptions, material may be ejected which later becomes comets. This theory, proposed many years ago by the late Richard Proctor, was shown by the late Dr. A. C. D. Crommelin to be feasible. He dealt with the necessary velocities of ejection from the various planets if they were to lose control of the ejected matter, and although some of these seemed rather high, they were not impossible.

In such matters a considerable amount of speculation is inevitable, and while it cannot be denied that some comets might have been formed by the process described, it would be going too far to assert that any were ever formed in this way. There is another 'ejection' theory which will now be described before considering a modern theory which has been recently proposed.

The conjecture that some comets have been ejected from the Sun receives a certain amount of support from the fact that a few comets

<sup>1</sup> See page 153.

pass very close to it. Thus the great comet of 1882 passed within 720,000 miles from its centre, and as the Sun's radius is 433,000 miles, this comet, at perihelion, was about 290,000 miles from its surface. The period of the comet was 760 years and its aphelion distance 16,000 million miles—more than four times Pluto's mean distance. There are several of these 'sun grazers'—all long-period comets—so even if we accept the view that they were ejected by the Sun we cannot apply the theory to the short-period comets or to those which do not pass very close to the Sun at perihelion. A serious objection to the theory is that ejections by the Sun would necessarily be in a gaseous condition owing to the Sun's temperature, and the condensation of comparatively small gaseous masses into the myriads of solid bodies of various sizes which compose the nucleus of a comet presents serious difficulties to the physicist. It is much more probable that such gaseous wisps, far from condensing into solid particles, would rapidly dissipate into space, their own gravitational attraction being too small to retain the gaseous molecules. The theory has very few exponents to-day, and we shall now examine a more recent theory advanced by Dr. R. A. Lyttleton.

#### DR. R. A. LYTTLETON'S THEORY OF THE ORIGIN OF COMETS

In the chapter on the stars it is shown that throughout the Galaxy there are great interstellar clouds,<sup>1</sup> and it is also shown that the Sun moves round the centre of gravity of the Galaxy, completing its circuit in about 200 million years.<sup>2</sup> It is reasonable to suppose that the Sun passed through some of these interstellar clouds of dust and gaseous molecules, and in doing so its attraction would draw a stream of dust towards its 'accretion axis'; Dr. Lyttleton defines this as the line through the centre of the Sun parallel to the direction of motion of the particles relative to the Sun. A conception of this axis can be obtained from Fig. 89, page 221, if  $AP$  is taken to be very great in comparison with the width of the ellipse which then becomes almost a line, this width being insignificant. The internal gravitation of the stream causes it to split up into a number of segments that contract lengthwise, the greatest length lying approximately in the direction  $AP$ , and the attraction

<sup>1</sup> See pages 343 ff.

<sup>2</sup> See page 349.

of the Sun on each of these segments acts as a disruptive force, thus preventing any segment from becoming very large. Each segment is a potential comet the mass of which is strictly limited by the Sun's disruptive tendency just referred to, and here we have an explanation of the fact that cometary masses are always very small, comparable with those of some of the largest minor planets. From the passage of the Sun through a cloud several thousand comets might be formed, and the process could be repeated from time to time during the Sun's revolution round the centre of the Galaxy.

The giant planets have an important influence in the process. Up to the present there seems to be no reason why the aggregations along the accretion axis should not be drawn into the Sun, in which case they would never become comets. This possibility is obviated by the giant planets which are responsible for causing the centre of gravity of the solar system to lie outside the centre of the Sun. An explanation of the revolution of binaries round their common centre of gravity<sup>1</sup> is given in the chapter 'The Stars,' and the same argument applies to the solar system, the planets revolving around its centre of gravity which is not the centre of the Sun. As an example, it is known that Jupiter's mass is 0.000955 the mass of Sun and that the distance of Jupiter from the Sun is about 1,120 times the Sun's radius, from which it is easily found that the centre of gravity of Jupiter and the Sun lies just outside the Sun's surface ( $0.000955 \times 1120$  exceeds 1). When the other giant planets are taken into consideration (the effect of the terrestrial planets is insignificant) the centre of gravity of the solar system can lie outside the Sun's surface by more than a solar radius. This requires that the giant planets should be more or less in a line and all on the same side of the Sun—a configuration that occurs with sufficient frequency over the comparatively long periods during which the comets were formed to render the argument valid.

It is shown that the aggregations which begin to form several hundred astronomical units from the Sun would at first be drawn towards the centre of gravity of the solar system, but when they had passed some distance inside the orbit of Jupiter the attraction would be towards the Sun's centre. The displacement in the original direction of motion would prevent some—though not necessarily all—of the aggregations from falling into the Sun, and

<sup>1</sup> See page 306 ff.

there is also the possibility of deflections by passing stars. In addition, if the accretion axis passed near the orbit of a giant planet, a considerable direct disturbance by the latter would ensue. The various influences would co-operate in preventing the aggregations from falling into the Sun, and most of the orbits would be practically parabolic.

It should be said, however, that the theory of the Sun picking up material from gaseous nebulae to form comets is not new. Russell, Bobrovnikoff, and others suggested it many years ago, but Lyttleton was the first to deal very comprehensively with quantitative results and to show that observational data on various features of comets lend support to the theory. His paper appeared in *Monthly Notices of the Royal Astronomical Society*, 108, 6, 1948, and should be studied by those who desire further information on the subject and whose mathematical equipment is equal to the task of following the arguments. The above is a mere outline of the theory as limits of space prevent a full and comprehensive exposition of various details that are dealt with. It provides a reasonable explanation of the peculiar motions of comets—direct and retrograde—and also of the wide range of inclinations to the ecliptic plane. Some of the earlier theories of the origin of the solar system include planets and comets in the same process, but attempts to fit comets into the scheme were not very successful. Lyttleton's theory postulated an entirely different origin for them, and this demands that the planets should be in existence before the comets were formed. While some points in the theory may require further consideration, on the whole the theory has much to commend it.

#### DR. J. H. OORT'S THEORY OF THE ORIGIN OF COMETS

A more recent theory than Lyttleton's, by Dr. J. H. Oort, has appeared, and a short account of this follows.

Oort attributes comets, minor planets, and meteors to the debris of a planet which exploded between the orbits of Jupiter and Mars. Fragments with approximately circular motion round the Sun became minor planets and meteors, but portions with elliptical orbits which approached Jupiter or other planets were subjected to perturbations which, on the whole, increased the major axes of their

orbits. About 97 per cent of the debris was so perturbed that it moved in hyperbolic orbits and was lost to the solar system, but a small fraction of it—about 3 per cent—was thrown into orbits with major axes from 25,000 to 200,000 astronomical units, and this portion formed an outer cloud of comets from which they have been supplied since the catastrophe occurred. Assuming that the original planet that exploded had a mass comparable with that of the Earth, then material of about one-thirtieth the Earth's mass would have been found in the cloud of the outer comets, and this is adequate to account for 200,000 million comets, each with an average mass of 10,000 million tons.

A comet in the outer cloud would not return to the point where the explosion took place because stellar perturbations would prevent this, but these perturbations could finally distort the velocity of a comet in the cloud to such an extent that it could return to the nucleus of the solar system. Assuming that the cloud had a random distribution of directions with respect to the Sun, then a very small fraction of the comets would cross the sphere with the Sun at its centre, the radius of which is about two astronomical units, and computations by Dr. A. F. F. van Woerkom, an associate of Dr. Oort at the Leiden Observatory, show that such comets would be thrown out of their original orbits and be converted into short-period comets or would be forced into hyperbolic orbits and so removed from the solar system.

The latter comets—those that escape from the solar system—would become interstellar objects, and the question arises whether other stars may not also assist in producing a large number of freely moving comets which have been formed in a similar manner—by the explosion of some of their planets. If this occurred we might expect that comets from such planetary systems would occasionally move into the region of the solar system and be seen. Such comets would have hyperbolic velocities, and although up to the present no such comets have been detected this is no argument against their existence. If a comet moving with hyperbolic velocity were ever discovered, then, unless such velocity could be traced to the perturbations of some of the planets, it would afford strong evidence for the existence of planetary systems of other stars.

This is a very brief account of Oort's theory, but many other points are discussed and details are considered which meet difficulties and

objections. It is impossible in the limited space to deal with these, and readers who desire fuller information are advised to consult some of the publications in which the theory is more fully explained.<sup>1</sup> One matter is worth consideration—the disruption of a planet. The mechanism by which such a catastrophe could take place is not discussed, and although this view of an exploded planet was suggested many years ago, it was regarded by some as the least satisfactory explanation of the planetoids. Within recent times, however, it has been shown by Dr. W. H. Ramsey and Dr. J. Light-hill that during the evolution of a planet a condition of instability might be reached when it is passing from one configuration to another, and blast-waves and vibrations of the planet might shatter its material, fragments flying off into space.<sup>2</sup>

#### DISINTEGRATION OF COMETS

The nucleus of a comet is held together by its own gravitational attraction which is very feeble owing to the comparatively small mass of the nucleus, and for this reason a small force is capable of disintegrating it. The attraction of the Sun, in particular when the comet is near perihelion, is one factor responsible for dissipating the nucleus, and light pressure has also a certain effect on the very small particles. Hence as a comet revolves round the Sun it will discard a certain amount of debris which will follow on in its wake, and which will also be spread out in the plane of the comet's orbit. We should therefore expect that after many revolutions round the Sun there would be a considerable amount of the debris of a comet spread out along its track, though it need not be evenly spread out, some parts having a greater concentration than others. Fig. 92 shows a comet with retrograde motion, from the nucleus of which debris has been discarded, but it is still following on in the wake of the comet. The Earth in its revolution round the Sun is shown encountering some of the debris; as a result of this encounter meteors appear in the upper regions of the Earth's atmosphere. (See page 242.) It must not be assumed that all meteor showers are associated

<sup>1</sup> *Bulletin of the Astronomical Institute of the Netherlands*, 11, 408, 13th Jan. 1950; Also *Sky and Telescope*, 11, 4, Feb. 1950; and *The Observatory*, 71, 129, Aug. 1951.

<sup>2</sup> *Monthly Notices of the Royal Astronomical Society*, 110, 4, 1950.



with comets; probably about a dozen comets are, or have been, responsible for meteor showers at various times in the year, and some of those so responsible are now nearly or entirely worn out and will

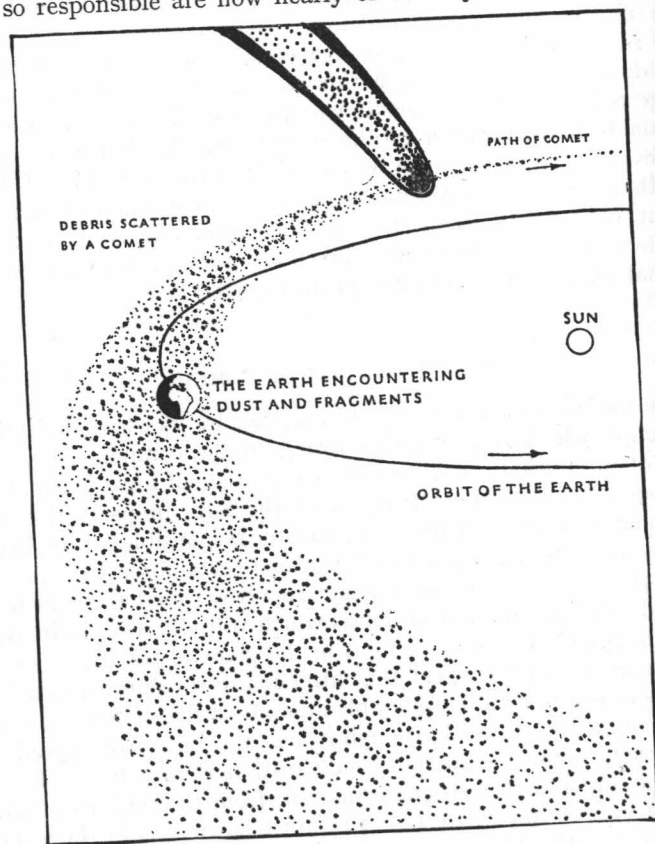

FIG. 92  
The Earth encountering the debris of a comet.  
(From Davidson's *From Atoms to Stars* (Hutchinson).)

never be seen again. (See pages 246 ff.) It is remarkable that the oldest comet of which we have authentic records, and which shows little signs of the dissipation of its nucleus, is believed to have the debris from its nucleus spread out to a considerable extent along its

track. This is Halley's Comet which the Chinese observed in 240 B.C. and which has since made twenty-eight returns. The debris from this comet is possibly responsible for a meteor shower each year at the beginning of May, and the fact that the debris encounters the Earth each year, even when the Comet itself is thousands of millions of miles away, shows that the debris must be spread out along its whole track. Not only is it spread out along its track; it is also spread out along the plane of the comet's orbit, and it has been estimated that the debris is probably moving along in the form of a cylinder whose diameter is about 26 million miles. While it is generally accepted that the Aquarid meteor shower is connected with the debris of Halley's Comet, there is no definite proof of this, and although there is a close similarity between the elements of the orbits of the comet and of the meteor stream, there is the possibility that this is a mere coincidence. The same remark applies to the connection between Halley's Comet and the Orionid meteor shower in October. This subject will be considered later in the chapter.

We shall now deal with another class of bodies, many of which are associated with comets, but by far the greater majority of which do not appear to have any connection with them.

## 2. METEORS AND METEORITES

### THE NATURE OF METEORS

On any clear night, provided there is not too much moonlight, a watch on any part of the heavens is almost certain to be rewarded by the observation of meteors or 'shooting stars,' as they are frequently called. It is not necessary to keep up the watch for long as meteors are fairly abundant at all times of the year, and at certain periods, to be referred to later, there are very prolific showers of these bodies. About 8,000 million meteors enter the Earth's atmosphere every 24 hours, but only a minute fraction of these can be observed, as most of them are very faint. The figures include meteors up to tenth magnitude, but if much fainter meteors are taken into consideration the number might be increased tenfold or more.

Meteors have nothing to do with the stars and the title 'shooting star' for a meteor is a misnomer. They are very small particles of matter, many about the size of grains of sand, others as large as a pin's head, others the size of a pea, and some as large as a small pebble, but when they are larger than this they are very conspicuous and attract attention by their brightness. They enter the upper regions of the atmosphere with very high speeds, varying between 10 and 45 miles per second, and owing to the heat generated by friction with the molecules of the atmosphere they are quickly burnt up. A certain amount of light is given out when the bodies are raised to a high temperature as they rush through the atmosphere over distances which vary from about 15 to 100 miles, though in some cases their paths exceed the latter figure. Ionization also occurs through the heat and the impact of the bodies on the molecules in the rarefied atmosphere, and is responsible for their light as well as for the train which they sometimes leave and which may persist for some minutes, though it usually disappears in a few seconds, and in cases of a very short persistence the name *trail* is usually given to the streak.

#### THE HEIGHTS OF METEORS

The heights at which meteors appear and disappear vary with their speed and size; a fair average is 70 miles for appearance and 50 miles for disappearance, but these figures are only approximate and considerable divergences are found on either side. Very faint meteors, which can be seen only with the telescope, are much higher when they appear and disappear; their paths are short as they burn out very quickly because the particles causing them are minute.

#### THE ORBITS AND SPEEDS OF METEORS

The particles that are responsible for the flash of light that we call meteors are moving in orbits round the Sun and many of these orbits are believed to be very elongated ellipses, like those of a number of comets, while others may be moving in comparatively small ellipses. Unlike the orbits of comets which can often be computed with great accuracy, the orbits of meteors are open to a considerable amount of speculation. In the case of very elongated

ellipses the speed with which meteors are moving round the Sun at the distance of the Earth is about 26 miles per second, but in the smaller elliptical orbits their speed is less than this. It is doubtful whether any meteors have speeds round the Sun at the Earth's distance much less than 23 miles per second. The speed of the Earth round the Sun is nearly  $18\frac{1}{2}$  miles per second, and hence if these particles meet the Earth the relative speed of impact is  $26 + 18\frac{1}{2} = 44\frac{1}{2}$  miles per second, and if they are overtaking the Earth the relative speed of impact is  $26 - 18\frac{1}{2} = 7\frac{1}{2}$  miles per second, taking the maximum speed of 26 miles per second given above. As, however, the Earth's attraction hurries these bodies on in their orbits when they come close to our planet, the above results are too low, and the actual speeds are 45 and 10 miles per second, respectively, the effect of the Earth's attraction being much greater for the slower meteors. (See Appendix IV.) Between these two extremes meteors encounter the Earth with all speeds according to the angle between their directions and the direction of the Earth's motion. (See page 246.) Meteors moving in short ellipses would have speeds a little less than those given above.

The speed of 26 miles per second round the Sun at the distance of an astronomical unit is the same as that which a comet has if it is moving in a very elongated ellipse; this is derived from a simple computation (see page 260) and in the case of comets is easily verified, but it is much more difficult to verify it for meteors. The reason for this will be obvious from the following considerations.

#### REAL PATHS OF METEORS

When the same meteor is seen by two or more observers who are separated by a distance of 30 or 40 miles, and each is able to give an accurate description of its flight, that is, its positions with reference to the stars as seen by each one, its actual path can be calculated. This implies giving the place over which it first appeared, its height at the time, and the place over which it disappeared and its height there. From these its total flight in miles, kilometres, or any other convenient unit is easily derived, and if its time of flight is known its speed is then calculated. The difficulty is in timing its flight very accurately, as it is a matter of a few seconds at the most and often only a fraction of a second. An

error of one-third of a second in timing the flight of a meteor which, it is estimated, was two seconds, would imply an error in its speed of about 16 per cent. In actual practice with naked-eye observation the timing error can be considerably more than this. Cameras have been used which photograph the same meteors, the cameras being separated by a distance of 30 or 40 miles, and they are provided with a special arrangement for timing the flight of the meteor. The accuracy of this is very much greater than anything that could ever be obtained by naked-eye work, but the probability of catching the same meteor with the two cameras is small, and in addition the fainter meteors cannot be photographed—none fainter than about third magnitude.<sup>1</sup> When meteors have been caught in the cameras it has been found that the speeds vary between the limits given above—about 10 to 45 miles per second—and the higher limit confirms that their speed round the Sun does not exceed 26 miles per second. In a few cases, however, speeds a little greater than 45 miles per second have been obtained, and if these were accurately determined they would suggest hyperbolic motion, but there is some doubt about these speeds greater than 45 miles per second. Meteors are now believed to be members of the solar system like comets, except for those that have suffered perturbations from the planets and have been thrown into hyperbolic orbits. Recent work with radar on meteors confirms that their velocities are not hyperbolic and that they are therefore members of the solar system.

#### METEOR RADIANTS

When observations are made of some of the well-known meteor showers and the paths of the meteors are traced backwards in the heavens, it is found that these converge to a small area somewhere in the sky or in a few cases almost to a point. This does not imply that the meteors are diverging from some point and striking our atmosphere; strange as it may seem, it proves that they are moving in parallel lines, and a good illustration of the principle underlying this phenomenon is seen in an ordinary straight railway track. Looking as far away as one can see along the track, the two parallel rails seem to converge in the distance, and if there were a number of such parallel rails they would all seem to converge to a point,

<sup>1</sup>Dr. F. L. Whipple's Super-Schmidt cameras can photograph third magnitude meteors.

provided one had a clear view of them sufficiently far away. Applying the same principle to a shower of meteors it is easily seen why the paths seem to converge to a point or to a small area in the heavens. Fig. 93 shows the paths of some meteors, from which it is seen that the paths when traced backwards appear to converge to a small area marked by a circle near the foot of the diagram.

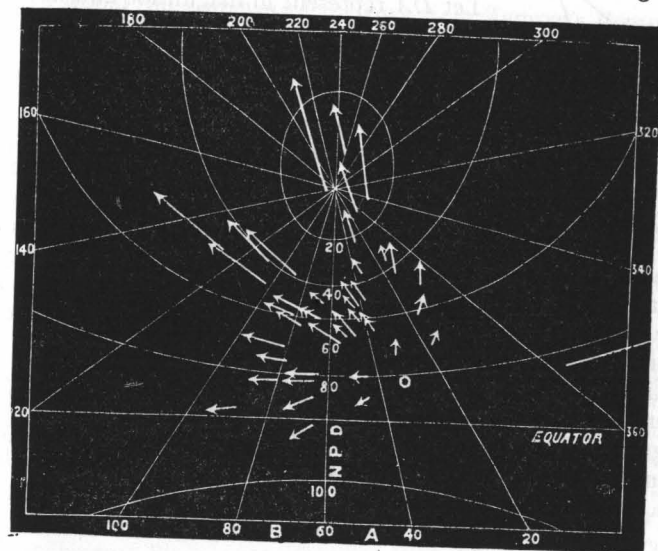

FIG. 93  
Radiant of meteors on 15 October. (Royal Astronomical Society.)

The reason for the movements of the meteors in parallel paths can be seen by referring to Fig. 92, which shows the debris of a comet following in the wake of its nucleus and encountering the Earth with almost a 'head-on' collision. Although the particles are moving in an ellipse, nevertheless, over a small portion of the track they are travelling in parallel paths which are in the direction of the tangent to the ellipse in the neighbourhood of the debris under consideration. Of course, the direction of this tangent changes from one part of the ellipse to another, and the direction of the particles changes too. In addition, the direction of motion of the Earth also changes from night to night, which explains why the



radiant of a shower shifts its position in the sky from one night to another. It should be pointed out that an observer does not see the meteors of any shower in the direction in which they are moving but in a direction which is the result of the movement of the particles and of the Earth. This is explained in Fig. 94.

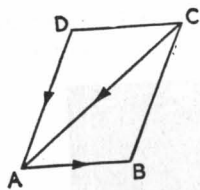

FIG. 94

Showing how to combine the motion of the Earth with that of a meteor

Let  $DA$  represent in magnitude and direction the speed of a particle encountering the Earth at  $A$  and let  $AB$  represent in magnitude and direction the speed of the Earth, each of these being the speed and direction of motion with reference to the Sun. Then the speed of the meteor with reference to the Earth is represented in magnitude as well as in direction by the line  $CA$ , where  $CA$  is the diagonal of the parallelogram  $ABCD$ .<sup>1</sup> If  $DA$  and  $AB$  are in the same line the resultant is also in the same line and its numerical value is the sum or the difference of  $DA$  and  $AB$ , according to whether the particle is meeting or overtaking the Earth. The line  $AC$  points in the direction of the radiant and obviously if the direction of  $DA$ , the tangent to the ellipse at the time, changes, or the direction of  $AB$  changes, the direction of  $AC$  will also change, thus explaining why the radiant of a shower alters its position in the heavens from night to night.

#### METEOR SHOWERS FROM THE DEBRIS OF COMETS

There are some well-known cases of comets producing very intense showers of meteors. Biela's Comet, which had a period of  $6\frac{3}{4}$  years, was observed to split into two parts when it made its return in 1845, and at its next return in 1852 these two parts had separated much more. The comet was not seen on its next two returns, but astronomers hoped to see it in 1872 on its fourth return after it had divided. They did not see it as they expected, but as a wonderful display of meteors on the night of 27th November. The debris of the disintegrated comet must have continued moving along the old track of the comet, and as this track practically intersected the orbit of the Earth about 27th November, the Earth encountered the particles, the result being a meteor shower. For many years this

<sup>1</sup> This diagram is based on the well-known method for finding relative velocity.

shower, known as the Bielids or the Andromedids, the former after the comet and the latter because the radiant was in the Constellation Andromeda, was active towards the end of November, but now the display is very feeble about the middle of November, and obviously most of the debris which was capable of colliding with the Earth has done so.

More wonderful displays of meteors from Tempel's Comet were seen on various occasions—1799, 1833, and 1866. The period of Tempel's Comet is  $33\frac{1}{3}$  years, and if the debris of the comet is very dense at some portion of its track and the Earth encountered it on any particular year, it might be expected that it could possibly encounter it again thirty-three years later. The displays of meteors in 1833 and 1866 were wonderful. On the night of November 12, 1833, an eye-witness in America described the meteors as 'thick as snow coming down in a snowstorm.' This does not imply that they were close together like snowflakes; even in very intense showers 20 miles or more intervene between the individual meteors, but owing to their height in the atmosphere they appear close together. The shower that was predicted for 1899 disappointed the public who had been led to expect a great display, but a few days before the date when the shower was due astronomers knew that Jupiter had disturbed the thick part of the stream that the Earth should have encountered. Unfortunately the public did not become aware of this in time and was disappointed with the astronomers' predictions of a fine display of meteors; the shower that took place was quite ordinary. Since 1866 this shower has not been remarkable and at present is very feeble on the nights of 15th–16th November. Tempel's Comet was not observed when it was supposed to return in 1932, and it seems possible that it is practically dissipated and will never be seen again. The comparatively few meteors associated with it—the Leonids—are now of little interest.

Of other notable showers associated with the debris of comets, mention may be made of a shower at the end of June from the debris of Comet Pons-Winnecke; a shower from the debris of Comet Giacobini-Zinner on 10th October; a shower extending over some weeks, but attaining a maximum from 10th to 12th August, known as the Perseids, due to the debris of Comet 1862 (III); and the Lyrids from about 20th to 24th April, which are associated with Comet 1861 (I). The names Perseids, Lyrids, etc., are given to showers

because the radiants are in these constellations. There are other showers associated with comets, but some of these associations are doubtful. As one example we may take the Orionids which are active after the middle of October, continuing for a few nights. There is a similarity between the elements of the orbit of this stream and those of the orbit of Halley's Comet, but it is very doubtful whether this is anything more than merely fortuitous. Reference has already been made to the  $\eta$ -Aquadrid shower in the early part of May and to its alleged connection with Halley's Comet. Although the evidence for this is stronger than that for the connection between the Orionids and the comet, the similarity between the elements may also be fortuitous for the  $\eta$ -Aquadrids, so named because the radiant is close to the star  $\eta$ -Aquadrii.

Dr. J. G. Porter, Director of the Computing Section of the British Astronomical Association, who has done a considerable amount of work on comets and meteors, dealt with the connection between them in his presidential address to the association on 1949 October 26. This address is given in full in the *Journal of the British Astronomical Association*, 60, 1, 1949 December, and shows some of the difficulties in accepting the so-called relation between comets and meteor showers. A very short outline of Porter's views follows.

The computing section investigated the orbits of all known comets and found that sixty came within 9 million miles of the Earth's orbit and thirty-five within half this distance. If the debris of these comets had been spread out along the planes of their orbits a number of meteor showers would have been expected, but there was no obvious accordance between any of these comets and meteor showers except for six which have been already mentioned. Another remarkable fact is that while the Leonids and Perseids have been active for a thousand years and the Lyrids for more than twice that period (the earliest record of this shower is 687 B.C. and appears in the Chinese annals for that year), the comets with which they are associated were not discovered until the nineteenth century. A more curious thing is that the debris does not always seem to follow the comet, as has been asserted in the few preceding pages; Porter points out that in 1926, when a shower of meteors associated with Comet Giacobini-Zinner occurred, the particles responsible for this actually preceded the comet. The process by which the debris of the comet achieved this feat provides a headache for mathematicians.

Porter conjectures that comets and particles may be travelling in practically the same orbit without any physical connection, though at some time in the remote past they may have had a common origin. Irrespective of the origin of the meteoric dust, its particles cannot continue indefinitely in the same orbit as the perturbations of the planets and light-pressure will break up the original orbit into a number of orbits. This accounts for the fact that most radiants are distributed over a small area and are not points in the heavens. As Porter says: 'We must therefore visualize the particles as travelling together through space in a bewildering array of entangled orbits, intersecting each other at small angles, crossing and recrossing, continually perturbed by the planets, no two exactly alike.'

There is no space left to deal further with this very interesting and important subject, but before concluding the subject of meteors a few words will be said about the recent application of radar to determine radiants and meteor velocities.

#### APPLICATION OF RADAR TO METEORIC ASTRONOMY

A team of workers under the direction of Dr. A. C. B. Lovell, at Jodrell Bank Experimental Station, Manchester University, has obtained some extraordinary and also very valuable results by the use of radar. A description of the technical details of the apparatus is beyond the scope of this book, and it will be sufficient to outline the main principle involved and to refer to some of the results obtained.

It has been shown that the light of meteors is due to ionization, and the electron trail left behind is responsible for the detection of the meteor by radar. A radio wave emitted from the earth and impinging on this trail causes the electrons to vibrate, and in doing so they re-radiate a small proportion of the energy which they received from the original wave. This energy travels back to the earth and is received on a sensitive set. The beam is reflected from those meteor trails that cross the beam at right angles, and radiants and meteor velocities can be determined with considerable accuracy. The transient echoes on the radar equipment, working on wave-lengths of 4 and 5 metres, increased enormously on 1946 October 10 when the Earth passed close to

Comet Giacobini-Zinner, the increase being due to its encounter with some of the debris of the comet.

A full description of the techniques of the apparatus can be found in many publications. (See a short list on page 261.) Radar observations of meteors are also carried out in America, Canada, Japan, and several other countries.

In addition to investigations on some of the usual showers, which largely confirmed previous results obtained by visual work, it was found that the  $\eta$ -Aurigid shower which commenced on 1947 May 1, when this shower was first investigated by the use of radar, was the beginning of a great belt of meteoric activity which continued with increased activity until the middle of June, after which it gradually decreased and returned to normal in August. Detection of meteors by radar is not, of course, restricted to the hours of darkness, and the great daylight stream of mid June would, if visible by night, have been a perfect blaze of meteoric activity. The meteors of this daylight stream came from the direction of the Sun, thus falling in all cases on the sunlit face of the Earth. The results have been confirmed by further work carried out in more recent years, and although there were many major showers which were active up to the end of August, no marked radiants were detected during September. A few meteors were suspected to be moving with slightly hyperbolic velocities, but there was some doubt about these and recently Dr. Lovell has asserted that there is no proof that any meteors move with hyperbolic velocities.

It is significant that, with one exception, none of the orbits derived from the radiants of these streams can be associated with any comets. The exception is the  $\beta$ -Taurids, active at midsummer, the orbit of which coincides with that of Encke's Comet. The debris of many of the night-time showers investigated at various periods throughout the year is associated with comets. In 1946 the Earth crossed the orbit of Comet Giacobini-Zinner on 10th October, the comet itself having passed this point fifteen days earlier. For a short period the radio-echo rate increased on 10th October by 5,000 times, and here there seems to be a curious contradiction between the behaviour of the debris of the comet in 1926 and 1946; as already pointed out, the debris of the comet preceded its nucleus in the former case. Obviously much still remains to be done on the subject of comets and meteors, and it is highly probable

that investigations on these bodies will yet lead to a solution of the still unsolved problem of the origin of the planetary system.

## METEORITES

If meteors are not completely volatilized in the atmosphere some portion or portions of them will strike the earth. The name *meteorite* has been given to these bodies, which are comparatively rare in this country but are fairly common in America. This is not because they have any special preference for falling in America but because more will naturally fall in the larger area. In many cases these bodies rush through the atmosphere with a loud noise and if they break up, as they frequently do, into a number of fragments, the disintegration is accompanied by a sound like an explosion. Analyses of many meteorites have been made, and it has been found that they differ very much in their composition. Some are stony and contain very little metal and are called *aerolites*, meaning air stones. Others contain a number of metals, iron, nickel, calcium, magnesium, manganese, sodium, etc., but very often the first two metals predominate, only traces of the others being found. These meteorites are called *siderites*, a word which implies that they are composed of iron, which is partly, though not entirely, true. A third class has a much lower iron-nickel content than the siderites, but a fairly large amount of stony material, and to these the name *siderolites* is given, a word denoting iron and stone.

The writer of this chapter has sometimes received communications from people who alleged that they saw a comet dashing across the sky. What they actually saw was a bright meteor (or possibly a meteorite). From what has been already said, readers will understand that a comet—many millions of miles from the Earth—appears to share with the stars the slow movement from east to west, which is due to the Earth's rotation, though if the comet is observed from night to night its position with reference to the stars will have changed, just as the positions of the planets do. A meteor or meteorite appears about 70 miles or often much less above the Earth's surface, and the flight ends in a few seconds.

In other cases he has received so-called 'meteorites' which were picked up after a thunderstorm. There is no connection between a thunderstorm and a meteorite, but when lightning strikes the



ground it may bore a hole in the earth, and this hole is sometimes lined with vitrified sand. Portions of this fulgurite may occasionally be mistaken for a meteorite, but not by those who know what a meteorite is. These thunderbolts, as they are called, are not very frequent—perhaps fortunately so, because any one who was struck by a thunderbolt would suffer from a severe shock which would probably prove fatal.

#### SIZES AND MASSES OF METEORITES

Meteorites vary very much in size and mass. Peary brought back three large meteorites from Greenland during his polar expeditions, and these, like many other meteorites, are in a museum. The largest of them weighs  $36\frac{1}{2}$  tons and its dimensions are  $10.9 \times 6.8 \times 5.2$  feet. Reference has already been made to the Siberian meteorite which at first was supposed to have been a portion of the nucleus of Comet Pons-Winnecke. On 1947 February 27 a number of meteorites fell at a mountain site on Sikhote-Alinsk, south-eastern U.S.S.R., and the swarm gouged 120 craters with diameters up to about 25 yards. It has been estimated that the total mass may have been a thousand tons, but this is probably an exaggeration. The place where the fall occurred is in longitude  $130^{\circ} 39'.7$  E. and latitude  $49^{\circ} 9'.6$  N., which is a long way from the place where the Siberian meteorite fell. At the time of writing the only information available is briefly as follows.

The meteorite appeared at a height of 15 to 20 miles and was like a small, faintly luminous, reddish sphere. When it had dropped to a height of seven or eight miles, a trail of reddish-brown smoke was visible in its wake and could be seen more than a hundred miles away; the light of the meteorite was then described by an eyewitness as brighter than the Sun. At a height of about 5 miles it appeared to burst into dozens of fragments which fell almost vertically to earth. The burst was accompanied by noises like thunderclaps and lasted four or five minutes; these noises must have been very intense as they were heard fifty miles away. The falling fragments produced craters scattered over an area of one-tenth of a square mile, and some of these craters were driven into hard rock. A preliminary analysis of its composition showed that it contained only 6 per cent of nickel, the remainder consisting chiefly of iron.

The famous crater near Cañon Diablo in Arizona was formed by a large meteorite of which there are no records as it fell many centuries ago. This crater is 570 feet deep and 4,200 feet in diameter. Within a radius of six miles from the crater meteoric iron has been found, and the pieces, which weigh several tons, must have been associated with the main mass which is buried in the ground. Within recent times sixty-seven metallic meteorites have been recovered from 20 cubic yards of the material thrown out in earlier excavations, and the average weight of these is  $\frac{1}{2}$  lb. Cedar trees are growing on the rim of the crater and the age of these has been estimated at 700 years, and the crater must have been formed before the trees started their growth. An upper limit to the time when the meteorite fell is set by the weathering of the rocks in the vicinity; this is about 5,000 years, and any time between these two extremes the fall may have taken place. Other smaller meteor craters have been found in various parts of the world.

Meteorites can be seen in many museums. The small ones weigh anything from an ounce or two up to several pounds, and they frequently show the effects of passing through the heated atmosphere. The radioactive methods for determining the ages of these bodies show that these vary considerably—between a few million and about 3,000 million years. The Earth is supposed to be about 3,000 million years old, and it is interesting to notice that the meteorites are not older than our planet nor, presumably, than any of the planets. The significance of this is of great importance to the cosmologist.

Until comparatively recent times the ages of meteorites were greatly exaggerated; increasing evidence from the relative amounts of helium, uranium, and thorium in these bodies has led to more satisfactory results. This subject is dealt with by F. A. Paneth in his publications given on page 261, and elsewhere.

Before concluding this chapter it should be emphasized that there does not appear to be any connection between meteorites and the debris of comets, although there is undoubtedly a connection between meteors and comets. It is remarkable that no meteorites have ever been found as a result of some of the great meteor showers. In recent times it has been suggested that meteorites are the debris from 'an exploded planet,' and the process by which small planetary cores could become unstable has been investigated. Even minor

planets might have originated in the same way,<sup>1</sup> according to this theory, but the subject requires much more investigation before it can be accepted, and in the meantime it must be admitted that the origin of both meteorites and minor planets is a problem still awaiting solution.

#### METEOR OBSERVATIONAL METHODS IN ENGLAND AND IN OTHER COUNTRIES

Observations of meteors in England by members of the B.A.A. Meteor Section, under the direction of Mr. J. P. M. Prentice, have been conducted almost entirely without instrumental equipment—unlike the methods pursued in some other countries. Very valuable results have been obtained which have appeared from time to time in *Memoirs* and *The Journal of the British Astronomical Association*, and in two papers with the title 'Analysis of British Meteor Data' in *Monthly Notices of the Royal Astronomical Society*, 103, 3, 1943, and 104, 5, 1944. Dr. J. G. Porter, Director of the Computing Section, gave very detailed accounts of his deductions from the data supplied. Of special importance was his conclusion that, apart from a few exceptional cases, all meteors moved in elliptical orbits and so were members of the solar system. He pointed out that certain assumptions made by Hoffmeister, Öpik, and others were not justified, and that these assumptions invalidated some of their conclusions. This matter will be better understood when the results of the Harvard Expedition to Arizona are referred to later.

The American Meteoric Society consists largely of amateurs working under the able direction of Dr. C. P. Olivier, director of the Flower Observatory, who, many years ago, attained renown through his work in observing meteors and computing the orbits of meteor streams. He laid great emphasis on the importance of deriving radiants from observations made on one night, under no circumstances combining observations over two or more nights. This rule is to be highly commended, though under some exceptional circumstances, such as a very weak shower, or when the meteor orbit has a small major axis and also a small inclination, as in the case of the Taurids (see page 260), it might be relaxed and observations combined over a few nights. In many cases radiants are not

<sup>1</sup> See page 219.

sharply defined points but are small diffuse areas, and it may be attempting too much accuracy if observations are not combined over a few nights. Nevertheless it must be admitted that many fictitious radiants were derived by the late W. F. Denning, who combined observations over weeks and sometimes over months to determine radiants. It has been already explained on page 246 why a shift in the position of the radiant is inevitable from night to night if the same shower is under observation, and hence it is theoretically unsound to deduce radiants from observations over long periods. Olivier's book, *Meteors*, which appeared in 1925, is an excellent work and should be read by all who are interested in meteoric astronomy.

Until the use of radar at Jodrell Bank, meteor work in England was confined almost entirely to amateurs, but in America the subject was taken up many years ago by professional astronomers. In 1931 the Harvard Observatory and Cornell University sent an expedition to Arizona to study meteors. Oscillating mirrors were used to determine meteor velocities, and observations made at different stations twenty miles or more apart enabled the workers to compute the real paths of the meteors. Dr. E. Öpik, who was responsible for much of the theoretical work, concluded that a large proportion of sporadic meteors—those which do not come from any of the well-known showers—moved with hyperbolic velocities round the Sun, some attaining velocities of about 120 miles a second. Meteor photography at different stations was carried out, though the number of meteors photographed was very small, but their real paths and velocities did not confirm the high hyperbolic speeds. A full account of the results appeared in *Harvard Annals*, 105, 30, 1937. It is now generally accepted that hyperbolic meteors are practically non-existent, or if they do exist their number is extremely small, and hence, generally speaking, meteors are members of the solar system. Nevertheless very important work was done by the expedition, and even more important work since, of which a brief account will be given.

At the suggestion of Dr. F. L. Whipple, two of the Harvard Observatory's short-focus cameras started operating in 1936, one at Harvard and the other at Oak Ridge, about 24 miles apart. Each camera lens is occulted by a rotating thin blade which breaks up the photographed trails 20 times a second, thus providing the

means for accurately determining meteor velocities, and even the rate at which meteors are slowed down through atmospheric resistance can be found. Comparatively few of the doubly photographed meteors are believed to have hyperbolic velocities; those so suspected have velocities only slightly above parabolic velocities, and it is possible that small errors in timing the flight or in computing the length of the paths, or in both, are responsible for the apparent hyperbolic velocities. If many sporadic meteors have entered the solar system from interstellar space, it is remarkable that their velocities are not decidedly hyperbolic and not mere 'border-line cases.' The radiant of any doubly observed or doubly photographed meteor is determined by tracing back the apparent paths as seen by each observer, the point of intersection being the radiant, and knowing this the orbit of the meteor is easily computed. It was found that the orbits of many of the sporadic meteors have very small major axes, and hence such meteors are as far removed as possible from the category of hyperbolic meteors. All this is in accordance with Porter's deductions from the visual observations of British observers. (See page 254.)

From the velocities and orbit derived from some of the November Taurids, Whipple found that the orbit in which they moved had a period of about  $3\frac{1}{2}$  years and he identified them with Encke's Comet. Additional computations suggested that their association with this comet must be very old—perhaps 10,000 years or more. Encke's Comet must have been a very spectacular object in the past.

In *Harvard College Observatory, Technical Report Number One, Harvard Meteor Program, 1947*, Whipple deals with the plans for instrumental equipment, the preliminary experimental programme, measurements of photographic meteor trails, and many other matters. As this book is intended primarily for amateurs and the programme and equipment are generally outside the amateur's scope, those who are anxious to know more about the formidable programme should consult some of the publications on the subject, a list of which is given at the end of this chapter. A few points of special interest will be briefly dealt with, though some of them are meteorological rather than astronomical.

Reference has just been made to the deceleration of meteors through atmospheric resistance, and this deceleration has provided

the data for determining the density of the atmosphere at various heights. Jacchia and Kopal found that there was a marked seasonal change in the density at great heights, the whole atmosphere at a height of about 50 miles appearing to rise more than 5 miles in the spring and to drop by the same amount in the autumn. This matter is also dealt with in *The Atmospheres of the Earth and Planets, 1949*, edited by Gerald P. Kuiper. This book is chiefly concerned with the information obtained on the upper atmosphere by the use of rockets which carried meteorological instruments.

Whipple has developed a method for measuring photographed single meteor trails from which radiants can be derived with great precision. When radiants can be predicted with reasonable accuracy single photographed shower meteors supply quite satisfactory data on heights and decelerations, and most valuable work on meteor showers can be accomplished. In addition, the measure of single trails provides data on the light-curves and other characteristics of photographic meteors.

When photographic methods differ in results from visual methods this may not necessarily be due to defective equipment or to bad observation. As one instance, reference may be made to the spread of radiants, which, determined photographically, are much smaller in the Perseid shower than they are when observed visually by Prentice and other British observers. It is possible, however, that the photographic methods do not secure the fainter meteors which can be seen by the naked eye, the former detecting the larger bodies which may move more nearly parallel to one another than the smaller meteors. More work on this matter may finally establish that this is the cause of the apparent discrepancy, and if so it would be very important in seeking for the physical effects that could disperse shower meteors about the mean orbit beyond the range of planetary perturbations. Reference is made later to two important papers by Whipple which deal with certain physical relations for comets and meteors and have an indirect bearing on this subject.

While direct photography of meteors is a slow process, photography of spectra is much slower still, as a longer exposure is required to record the spectra. A number of professional astronomers as well as amateurs have taken up the photography of spectra, chiefly in Canada, America, and the Soviet Union. In the first



country Dr. P. M. Millman, assisted by several groups of amateurs, is doing very useful work in the photography of meteor spectra. Millman started this work more than twenty years ago at Harvard and now continues it at the Dominion Observatory, Ottawa. In *Dominion Observatory Reprint*, No. 45, he gives a full description of the spectrum of a bright Perseid observed on 1949 August 13. Its visual magnitude was  $-4$ , which implies that it was nearly ten times as bright as Sirius, the brightest star in the heavens, and it was very fortunate that its spectrum was photographed. It was typical of other Perseid spectra which had been previously photographed, showing neutral iron, calcium, magnesium, and silicon. The spectrum of the train which remained visible for 11 seconds differed from that of the meteor itself in two respects: (1) the absence of ionized lines in the train; (2) the relative enhancement of the neutral magnesium and calcium lines, and the neutral iron lines arising from transitions to levels higher than the ground state of the atom. Millman points out that these features support the hypothesis regarding the luminosity of the train—that it is due to a recombination spectrum involving chiefly the elements common in the light of the meteor.

In *Contributions from the Dominion Observatory*, 2, 8, 'Meteoric Ionization,' Millman gives a summary of this subject, utilizing a large amount of material published in different papers from 1907 to 1950, and also a considerable quantity of unpublished material secured at Ottawa by Dr. D. W. R. McKinley and himself. A brief explanation has already been given of the method of detection of meteors by radio and the subject is dealt with very fully in the paper referred to above. In addition, results of the work are discussed, and at the time of publication it was stated that the reduction of about 2,500 meteors observed in 1947-9 in the combined Dominion Observatory-National Research Council programme at Ottawa, and recorded by both visual and radio methods, was then nearing completion.

Before leaving this subject reference may be made to two papers by Whipple in *The Astrophysical Journal*, 111, 2, 375, March 1950, and 113, 3, 464, May 1951, in which he presents a new comet model which, he claims, accounts for many problems connected with comets and also meteors. He assumes that the nucleus of a comet is a conglomeration of ices such as water, ammonia, methane,

carbon dioxide or carbon monoxide, and possibly other materials, combined in a conglomerate with meteoric matter, all initially at a temperature less than  $50^{\circ}$  K. As a convenience in terminology the term 'ices' is used when referring to substances the melting points of which are below about  $300^{\circ}$  C., and 'meteoric material' is used for substances with higher melting points. Solar radiation would vaporize the external surface and leave an outer matrix of non-volatile insulating meteoric material, and it is shown how rotation of the nucleus can cause an acceleration or deceleration of the mean motion according to the direction of rotation compared with that of revolution round the Sun. The acceleration of Encke's Comet with a corresponding decrease in its period of revolution is explained in this way, and the decelerations of Comets d'Arrest and Wolf I, with an increase in their periods, are similarly accounted for. The ejection of meteoritic material depends upon various factors, and it is shown that large comets should eject the particles with greater velocity than smaller ones, for which reason meteor streams from the former should be more dispersed and also more uniform from year to year than such streams from the smaller comets with comparable orbits, and quantitative results are deduced for some comets. Encke's Comet would lose 0.002 of its mass during each revolution, the corresponding figures for Comets d'Arrest and Wolf I being 0.005 and 0.002 respectively.

In his second paper Whipple shows in Table 3 that the showers that are most widely spread and associated with known comets, the Perseids, the Taurids, the  $\eta$ -Aquadrids and the Orionids, all arise from very bright comets. Encke's Comet, now a faint object, which is responsible for the Taurid meteors, is believed to have been very massive in the past because it has persisted for a long time in a short-period orbit. (See page 256.) It was a small telescopic object when discovered in 1786 by Méchain, and had a bright nucleus; Whipple does not accept Vessviatsky's conclusion that it has faded by one magnitude in the last 100 years.

It may be pointed out that Table 3 does not support the theory as strongly as it appears to do, because Whipple questions the association between Halley's Comet and the  $\eta$ -Aquadrids and the Orionids (the writer of this chapter has already expressed some doubts about this connection on pages 241, 248).

Whipple admits that the evidence for the theory is preliminary

in character and subject to alternative explanations, and as the photographic and radar observations of meteors become more extensive, much greater precision in testing the theory will be possible.

## METEOR SHOWERS BELIEVED TO BE ASSOCIATED WITH COMETS

Meteor Shower	Date	Comet
Lyrids	April 21	1861 I
$\eta$ -Aquarids	May 6	Halley
Draconids	June 30	Pons-Winnecke
Perseids	August 10	1862 III
Draconids	October 10	Giacobini-Zinner
Orionids	October 18	Halley
Taurids	November 11	Encke
Andromedids	November 14	Biela
Leonids	November 16	1866 I Tempel
Ursids	December 22	Tuttle

In many cases the showers extend over several nights or even weeks as with the Perseids. The dates refer to the times of maximum display.

The daylight  $\beta$ -Taurids, detected by radar, are active at the end of June and early in July. They are also associated with Encke's Comet and, like the Taurids, are moving in an orbit with a very small inclination to the plane of the ecliptic. The  $\eta$ -Aquarids and Orionids are included in the list in spite of the doubt expressed about their association with Halley's Comet.<sup>1</sup>

At the time of writing Mr. R. A. McIntosh, a meteor observer in New Zealand, announced that he had found a radiant on 1951 August 4 for a meteor shower, which was close to the position predicted by Porter for possible meteors associated with Comet 1951a, Pajdusakova. This association cannot yet be accepted as established.

*Note on the orbital velocity of a body moving round the Sun.* If  $a$  is the semi-major axis of the orbit and  $r$  the distance of the body from the Sun at any instant, its velocity  $V$  is given in miles per second by the formula,

$$V = 18.47 \sqrt{(2/r - 1/a)},$$

where  $r$  and  $a$  are expressed in astronomical units. In the case of the Earth, since  $r$  is always close to  $a=1$ , the formula gives about  $18\frac{1}{2}$  miles a second for its orbital velocity. In the case of a comet moving in a very elongated ellipse where  $a$  is so large that  $1/a$  is practically zero,  $V = 18.47\sqrt{2} = 26.1$  miles per second when  $r=1$ , that is, when the comet is at the same distance as the Earth from the Sun.

<sup>1</sup> While correcting the page proof it was announced by Lovell that possibly neither of these showers is associated with Halley's Comet.

## BIBLIOGRAPHY

The amount of literature on the subjects discussed in this chapter is very large and only a very small portion of it can be referred to. For this reason many important publications are not included, but sufficient is given to enable those specially interested in the subject to derive much fuller information. Books and other publications mentioned in the text are not repeated in the following list.

Amédée Guillemin: *The World of Comets*, translated and edited by James Glaisher, F.R.S., Sampson Low, Marston, Searle & Rivington, 1877.

George F. Chambers: *The Story of the Comets*, Clarendon Press, Oxford, 1909.

Charles P. Olivier: *Comets*, Baillière, Tindall & Cox, 1930.

Mary Proctor and A. C. D. Crommelin: *Comets, their Nature, Origin, and Place in the Science of Astronomy*, The Technical Press, 1937.

Fletcher G. Watson: *Between the Planets*, Churchill, 1947.

Bernard Lovell and J. A. Clegg: *Radio Astronomy*, Chapman & Hall, 1952.

J. G. Porter: *Comets and Meteor Streams*, Chapman & Hall, 1952.

Amongst Astronomical Journals, etc., the following may be noticed:

E. Opik, 'Meteorites and the Age of the Universe,' *Popular Astronomy*, 41, 2, February 1933.

Dorrit Hoffleit: 'A Study of Meteor Light Curves,' *National Academy of Sciences*, 19, 2, 212-21, February 1933.

M. Davidson: 'The Computation of the Real Paths of Meteors,' *Journal of the British Astronomical Association*, 46, 8, 292-300, June, 1936.

F. A. Paneth, 'The Age of Meteorites,' *Occasional Notes, Royal Astronomical Society*, No. 5, June 1939; also *The Origin of Meteorites*, Oxford University Press, 1940.

P. Swings: *Spectra of Comets, Publications of the Astronomical Society of the Pacific*, 54, 319, 123-36, June-August 1942.

A. C. B. Lovell, J. P. M. Prentice, J. G. Porter, R. W. B. Pearse, N. Herlofson: 'Meteors, Comets, and Meteoric Ionization.' Reprinted from *Reports on Progress in Physics* (The Physical Society), 11, 389, 1948.

Peter M. Millan and D. W. R. McKinley, 'A Note on Four Complex Radar Echoes,' *Journal of the Royal Astronomical Society of Canada*, 42, 3, 121-30, 1948. Also the following by the same authors: 'Determination of the Elements of Meteor Paths from Radar Observations,' *Canadian Journal of Research*, A, 27, 53-67, 1949. 'A Phenomenological Theory of Radar Echoes from Meteors,' *Publications of the Dominion Observatory*, 11, 8, 1949. 'Three-Station Radar and Visual Triangulation of Meteors,' *Sky and Telescope*, 8, 5, March 1949.

Luigi G. Jacchia, Zdeněk Kopal, and Peter M. Millman: 'A Photographic Study of the Draconid Meteor Shower of 1946,' *Astrophysical Journal*, 3, 1, 1950.

J. G. Porter, Presidential Address, *British Astronomical Association Journal*, 61, 1, December 1950, and also Presidential Address by G. Merton in *Journal*, 62, 1, December 1951.

## CHAPTER VII

THE AURORA AND  
ZODIACAL LIGHT

W. B. HOUSMAN, F.R.A.S.

*Formerly Director of Aurora and Zodiacal Light Section,  
British Astronomical Association*

THE aurora and zodiacal light belong to the realm of astronomy, being luminous objects outside the Earth, revealed at certain times to our gaze during the hours when daylight is almost or quite absent from the sky. They are, however, amongst the nearest of the many lights we see at night. The aurora is nearer to the Earth's surface than any astronomical object except the so-called shooting stars, which may occasionally reach the surface. The zodiacal light is produced at a much greater distance than aurorae, but is still of the order of distance of the nearest planets.

Those who take an interest in astronomy—in any or all of its branches—cannot fail to have noticed at some time these features of the night sky and to have admired their beauty. To the astronomer they appear without causing any surprise, but always command his interest. To the lover of nature who is not an astronomer there is often surprise coupled with admiration, for even such a person may live for years without having had a chance to see them because of an artificially lighted environment. Often in the neighbourhood of towns such phenomena, though actually visible, may be so mingled with glows from the streets as to be unrecognizable. It is in the open country beyond the range of

street lighting, when the Moon is absent from the sky and the vault of heaven is like ebony studded with diamonds, crossed by the silver stream of the Galaxy, that the cone of the zodiacal light or the pale golden arc of the aurora arrests the attention. These phenomena then present themselves as heavenly visitors, demanding of the inquiring mind an explanation of their unusual presence.

For observing all manifestations of the zodiacal light and the fainter displays of the aurora, it is necessary for the eyes to have become adapted to the dark by having been some minutes outside, so that the retina has attained its greatest sensitivity. Any magnification by the use of optical instruments can only serve to reduce the visibility of these lights; hence even the best night binoculars are no use for observing them, and the naked eye is the supreme equipment for viewing the form, colour, and extent of these celestial illuminations. For scientific purposes, however, there are instruments that can be usefully employed; the analytical properties of the spectroscope, the exact measure of the photometer, the permanent record of the camera, are all used with great advantage to tell us more than the eye alone could, but only the naked eye can behold their great beauty.

Besides the aurora and the zodiacal light, which are quite distinct in appearance, in position, and in origin, there is another phenomenon which the regular observer cannot fail to detect sooner or later; this is called the luminous night sky, and it is often difficult to say whether it is a form of aurora or not. It certainly seems to have no connection with zodiacal light, as it occurs in any part of, or all over the sky, though in the intensity of the light and in its quiescent nature it resembles that feature more than the often brilliant and active aurora.

Recognition of these night sky illuminations is assisted by their position. Auroral displays occur in two zones, one in the northern and the other in the southern hemisphere. The zones are rings, girdling the Earth at about  $22^\circ$  from the magnetic poles. The zodiacal light, as its name implies, is to be looked for amongst the zodiacal constellations or in their neighbourhood, and it does not, like the aurora, wander from its base over the whole sky. Further aids to the recognition of the nature of night illumination are found in the character of its form and behaviour, which we will now consider.



## THE AURORA

The name Aurora, given to the lights that are associated with the Earth's magnetic field, describes the initial stage of the phenomenon on the horizon. Aurora is the Latin name for dawn, and the light that spreads along the horizon over the region of magnetic north in a distant display, or in early stages of a major one, bears a remarkable resemblance to the spreading of the first light of dawn.

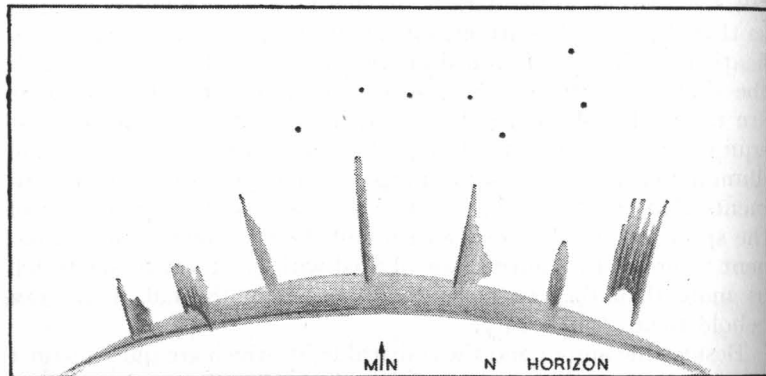

FIG. 95  
NORMAL AURORA: RAYED ARC

This is the feature known as the Glow. It is segmental in form with a base that may cover  $60^\circ$  or more, and the apex may be about  $15^\circ$  in altitude, the light being of a golden or a greenish-primrose tint. On the extension of the base to a quadrant or more of the horizon, there usually emerges the feature called the Homogeneous Arc. This is in the form of a flat bow that may have its sharply defined underside from  $5^\circ$  to  $20^\circ$  or more in altitude on the magnetic meridian, where the crown of the arch may be from  $3^\circ$  to  $10^\circ$  in depth, and tapering to the horizon at each flank. When the arc is low a dense blackness is often seen below it, but this is the clear sky in which a star, if present, can be seen shining brightly. This arc is a portion of a vast luminous ring that encircles, or partly encircles, the auroral zone of the polar regions. The further development of the homogeneous arc results in the production of the auroral form called Rays, Beams, or Streamers.

Rays of light in shafts of varying width may radiate from the magnetic north above, below, or across the face of the arc. These may appear as slender as a spear or as broad as a searchlight beam, singly or in groups, short, or shooting up to  $50^\circ$  towards the zenith. They may appear when no arc is visible. If associated with an arc the whole formation is called a Rayed Arc, and is an active phase usually of short duration compared to the homogeneous arc that may remain quiet and unmoved for an hour or so. When rays group together another auroral form called Draperies is produced. These beautiful formations closely resemble curtains of exquisitely fine material, fluted and folded as they hang suspended in the sky, swaying as if in a breeze, coloured red, white, or green.

The formation of draperies frequently precedes the climax of an aurora, especially when they rise higher and higher and the observer becomes aware that they are surrounding and pointing towards a definite point in the sky, which is at or near the magnetic zenith. If the aurora is one of the first magnitude—a great display—at this stage streamers may arise from all points of the horizon and converge to this point, giving the observer the impression of being beneath a huge canopy of coloured light. Besides the coloured streamers, large regions of sky may be coloured, here a deep crimson, there a very vivid green. This auroral climax is called the Corona, the crown of glory of the polar skies, the most beautiful sight man can see between twilight and dawn, rivalling the finest daylight glories produced by sunshine and clouds, yet without sunshine at dead of night, and far beyond the clouds.

About the climax stage of an aurora another form emerges called Flaming Aurora. From various points of the horizon vast filmy sheets of pale light are seen to flash upwards, converging towards the focal point near the zenith, as if still further to emphasize the fact that this region is the controlling centre of the display.

The seven auroral forms described above are the main features of the aurora, the Glow, Homogeneous Arc, Rays, Rayed Arc, Draperies, Flaming, and Corona. They may occur in the succession in which they have been described, when a great aurora takes a normal course, or they may be observed irregularly, and one stage may not develop further. After the corona has faded there may be a complete disappearance of all other features, or just a return to the magnetic horizon and a glow, and another climax may occur

later on. Besides the forms described above, there are others not so commonly seen but which are definitely connected with auroral activity. Pulsating Arcs in isolated areas and Pulsating Surfaces are seen at times to appear and disappear, or to increase and decrease in luminosity in irregular periods, the intervals being sometimes of minutes in duration. Flashing Aurora is a type that appears as arcs or patches of light that flare up and go out in very brief intervals. Diffuse Surfaces is the name given to quiescent, cloud-like forms of aurora, that may be comparable in luminosity to the Galaxy and cover a large area of the sky. Arcs with ray structure are a rare and beautiful form, in which a long arc is composed of short rays giving it a ribbon or comb-like appearance.

There is yet another form which the regular observer will see in due time but at rare intervals—a form that may be looked for after a great aurora has subsided. When the glory has departed a faint arc may be seen to span the sky, often at great altitude and a few degrees in width. It is like another galaxy, quiescent, and sometimes far from the usual region of the glow, in a perfectly dark sky, and resembling a ghost of the departed aurora.

On occasion an arc of the ordinary type may become distorted and twist about in the sky, or it may suddenly terminate midway in its length; concentric arcs may form one over the other; tandem arcs appear beside each other; one arc may form, partly overlapping one already there. In short, you can never guess what the aurora is going to do next, and there is a great charm in watching the vagaries of a long display. The arc, it has been stated, is usually clear cut below and diffuse above, but just the opposite has been seen. Beams may radiate from magnetic north, or they may have another point of origin. They may move either to east or to west with plainly visible motion, or slowly in the course of many minutes.

Colours in the aurora are often very beautiful, and this beauty is all the more remarkable by the fact of their glowing in a clear black starry sky. The horizon glow and the low arc are not usually coloured other than the pale primrose or green shade that generally characterizes their presence. A low homogeneous arc in strong moonlight is recognized by its greenish tint on the light sky. In moonlight a glow is not usually detected without a spectroscope, but a great aurora is always visible though moonlight detracts from its glory according to the phase and altitude of the Moon. When

the aurora reaches the corona stage on a clear moonless night, then the fortunate watcher may see the brighter colours of a great display in all their glory. A deep blood-red crimson, a bright vivid green, and a brilliant creamy white are the main colours which may tint the streamers and draperies, and in the case of the red and green, may floodlight a large area of the starry sky. Many other shades of colour are undoubtedly seen, and some observers have noted blue, but the colours named above are those usually displayed.

Having observed the forms, the movements, and the colours of the aurora, one naturally becomes interested to know what it is and whence it came, and how far away those lights are kindled. The movements being frequently rapid, we know it must be near as an astronomical object, just as we know that shooting stars cannot be stars at all on account of the swift movements seen across the sky. We can also observe that it is above the highest mountains and clouds. The answer to the question of its height above the surface has been given by ordinary trigonometrical survey, that is, by observing the displacement of points photographed against the stars from the ends of a measured base. This is not so simple an operation as it sounds, but the many difficulties have been overcome, and in auroral countries, notably in southern Norway, connected stations have obtained many thousands of calculated positions of the arcs, beams, draperies, and coronae. It has been found that the underside of the homogeneous arc is at a fairly constant level, having a mean value of about 70 miles. This is of interest to the ordinary observer seeing the arc at a certain altitude in degrees above the horizon, for by a simple calculation or a still simpler graph on paper, he can plot its position on the assumption that it is 70 miles up, and he then knows how far away it is overhead in the sky and its geographical position. The ghost arcs mentioned above have been found to be about double this height; beams and streamers may begin at the 70-mile level and soar to immense heights, even to over 600 miles, so that their summits lie outside the Earth's shadow to become bathed in full sunlight.

While we know these details regarding the height of the aurora, we also want to know where on the Earth we must be to see it best, for there are vast regions where it is never seen, and large populations know nothing of its glories.

Although the aurora encircles the polar regions, the pole of

rotation is not the focus or centre of the auroral zone. The Earth, in fact, has six poles, when the aurora and magnetism are taken into consideration; three in the north and three in the south.

The auroral zone surrounds all three, north and south, the pole of rotation, the geomagnetic pole, and the magnetic pole. It is the geomagnetic pole that is the controlling centre of the magnetism that, in conjunction with other factors, is responsible for the aurora. On certain occasions the Sun expels corpuscles<sup>1</sup>—ions and electrons with very high speeds, and these collide with the rarefied gases in the Earth's upper atmosphere, disrupting the atoms and causing a glow. The nature of the glow depends on the degree of ionization of the atoms; it has been already shown<sup>2</sup> that atoms can be singly, doubly, trebly, etc., ionized, in the Sun, and this can also take place under other conditions. The corpuscles move in spiral paths along lines of force in the Earth's magnetic field, and it is interesting to know that Störmer, a Norwegian mathematician and geophysicist, calculated the possible trajectories of electrified particles shot from the Sun in the direction of the Earth. Previous to this Birkeland, a Norwegian physicist, using a magnetized model of the Earth in a vacuum tube, and exposing it to cathode rays, obtained luminous electrical effects round its poles which explained in a fairly satisfactory manner magnetic storms and the aurorae. There are, however, a number of problems connected with the aurora which are still unsolved.

At either magnetic pole the magnetic field of the Earth is perpendicular to its surface. In the north the axis pole is in the Arctic Ocean, the geomagnetic pole in north-west Greenland, the magnetic pole in Boothia, and the zone of maximum auroral frequency sweeps around them on top of the earth in a figure somewhat egg-shaped, skirting southern Greenland, northern Canada, and northern Siberia. Frequency in this zone is about every other night, decreasing continuously northward and southward, being about twenty-five nights per annum at Edinburgh, ten in England, one in ten years in north Mediterranean lands, but never overhead in these lowest latitudes. The red light that illuminates the loftiest regions, when an overhead display has come unusually far from its normal zone, as it does in sunspot maximum periods, has been seen northwards and low on the horizon from places two or three degrees

<sup>1</sup> See page 70.

<sup>2</sup> See page 14.

north of the tropic of Cancer, and southwards from similar positions south of the tropic of Capricorn.

Reference has been made to particles streaming towards the Earth from the Sun, which are drawn towards the geomagnetic poles and excited to luminosity in the upper atmosphere. Observation has established the fact that there is a very noticeable relation between the occurrence of increased sunspot activity and unusual auroral frequency and strength—a relation too consistent to be fortuitous, although subject to variations and exceptions. A large sunspot group may continue in being for one or two rotations of the Sun, and these rotations occupy a time interval of about 27 days. When crossing the Sun's central meridian, and the group of spots is pointing earthward, if it is emitting such a stream of particles an auroral display may be expected after an interval the length of which will depend on the speed of the particles. It is observed that a display frequently occurs about 27 hours after such a situation, which gives a speed of about 1,000 miles per second for the stream, and also that a similar display often occurs 27 days later after one complete rotation of the spot group. The relation between sunspot activity and the aurora is further revealed in the period of about 11 years in which our Sun passes through a well-marked cycle of spot appearances. The period is not exact, but from records extending over more than 200 years a mean of just over 11 years has been established during which the Sun passes from a state of very rare spottedness through a condition of large and frequent spot groups appearing on its surface to minimum again. From minimum spots to maximum about  $4\frac{1}{2}$  years may pass, and then comes a slower decline to the minimum of about  $6\frac{1}{2}$  years. Graphic curves based on spot numbers for each year show clearly the rhythm of this cycle, and since auroral records have been plotted in a similar way, the parallelism of the curves proves the connection beyond possibility of doubt. The two latest periods have been shorter than the 11-year mean; probably this will be balanced in future by longer periods. The last minimum was early in 1944.

In consequence of the great height of the aurora we should not expect to hear sounds if any were produced, or could be produced, in such a rarefied atmosphere. If there were such sounds from even the lowest arcs, then at least four minutes must elapse before they reached our ears. However, there are instances of the most



experienced observers in very lonely stations at the height of a major display, hearing a noise like the burning of grass or the hissing of spraying water, and this seemed to vary in its intensity with the pulsations of the lights. The possibility of sympathetic electric disturbance at ground level is here suggested.

What is the intensity of the light of a great auroral display? It is inferior to full moonlight, although a low altitude Moon, even nearly full, is outclassed by a brilliant aurora, as occurred in 1940 March 24. The beams and draperies have been successfully photographed in the strong dawn at Professor Störmer's stations in Norway when the centre of the Sun was only  $8^\circ$  below the horizon. No aurora can overcome full daylight, but beams seen in the dark from the Earth's surface may, when of great length, out-pass the Earth's shadow and be actually in full sunlight. A big aurora on a moonless night lights up the landscape with sufficient illumination to show landmarks as distinctly as in moonlight.

#### THE ZODIACAL LIGHT

The zodiacal light is very different in character from the aurora. It is no rival to moonlight and the man in the street never sees it shining overhead as he sees the aurora. We have referred to it as forming a cone in the clear dark sky, and this is the most easily seen and the brightest aspect of it. Following the Sun down, or preceding the Sun up, evening and morning, this cone tapers away from the Sun along the ecliptic, appearing as a glimmering shape very distinct from twilight or dawn. Unless, however, the ecliptic is steeply inclined to the horizon, the cone, lying at a small angle, will be so intermingled with haze that it will not be traceable. The vernal equinox, therefore, in temperate zones, is the best time to see the evening cone about two hours after sunset; and the autumnal equinox is the best time to see the morning cone before dawn. In the tropics the cone is well seen evening or morning at any season, and the base of the cone at the horizon there is usually about  $30^\circ$  or less, with its apex  $50^\circ$  above the horizon, or  $70^\circ$  from the Sun's position. In temperate areas the greater inclination gives a wider base, the upper or poleward boundary being less sharply defined than the lower and shorter side. In all latitudes except the very high ones the cones may be seen; and sometimes a faint band of

light several degrees wide, always near the limit of human vision, may be traced passing upward beyond the apex to cross the sky or

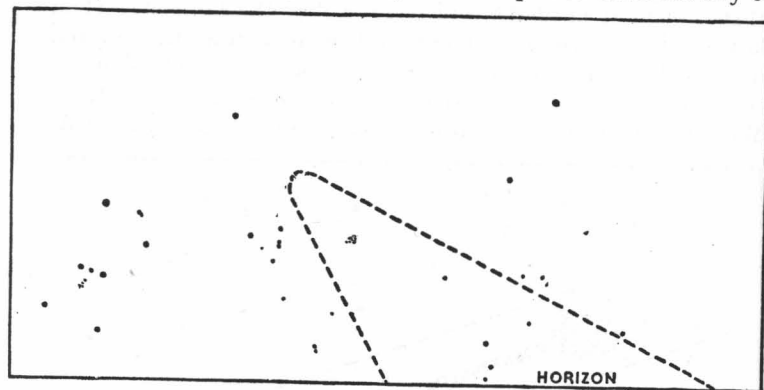

FIG. 96  
ZODIACAL LIGHT BOUNDARIES, APRIL EVENING

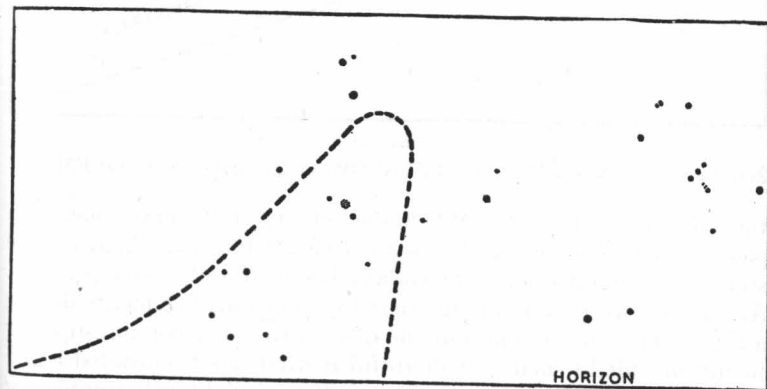

FIG. 97  
ZODIACAL LIGHT BOUNDARIES, SEPTEMBER MORNING

to become lost in the Galaxy where it intervenes. This is called the *Zodiacal Band*.

There is an opposition aspect of the zodiacal light, called the *Counter glow*, sometimes seen at the anti-solar point of the ecliptic in the form of an oval patch somewhat brighter than the band,

though exceedingly elusive. The nearest point to the Sun where we can see the zodiacal light is limited by the refraction of light that drowns it until the Sun is  $18^\circ$  below the horizon. Then the last effects of daylight fade out, and the light from the Sun reaches us only by reflection from the tiny particles in planetary space surrounding the Sun. No doubt we should see it gloriously on the Moon the moment after sunset, and the full extent of its width at

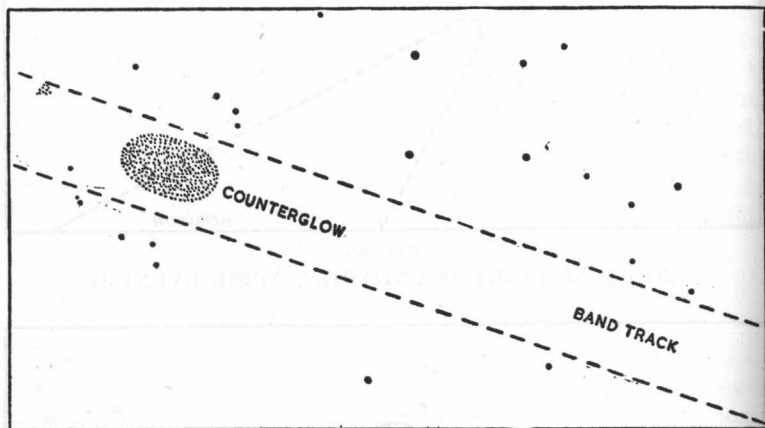

FIG. 98

## ZODIACAL BAND AND COUNTERGLOW, OCTOBER AND NOVEMBER

the Sun could be seen. When the Sun is at its lower meridian passage and some degrees below the twilight limit, the light can be seen in segmental form if the Galaxy is not over the solar position. Attempts have been made to see it by special arrangements during a total eclipse of the Sun, but the light of the solar corona, superior to full moonlight, makes it doubtful if what has been noted could be true zodiacal light, which even half moonlight will completely obliterate. The width of the band has been variously given as being from  $8^\circ$  to  $30^\circ$ . The normal width of base of cone on the horizon being about  $30^\circ$ , the maximum width of  $30^\circ$  for the band may give us a clue to their being part of the same object—a belt of meteoric dust surrounding the Sun and reaching beyond the orbit of the Earth. A common dimension assigned to the counter glow is some  $10^\circ$  long and  $7^\circ$  wide. Although the counter glow and band

are seldom seen, and at times the cones have been reported missing, there is probably an atmospheric explanation of their absence, and when conditions allow they are always visible. The counter glow is often referred to by its German name *gegenschlein*.

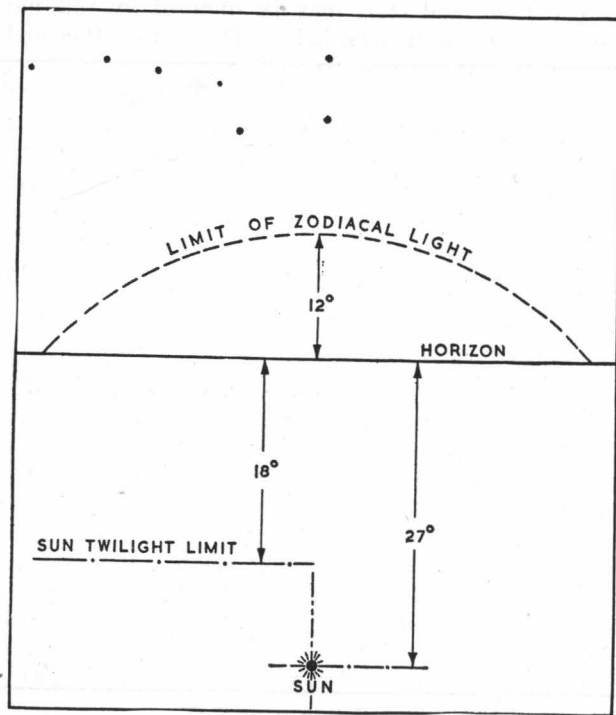

FIG. 99

POLAR GLOW, 1st SEPTEMBER, MIDNIGHT IN LAT.  $55^\circ$  N.

The colour of the zodiacal light is white; the cones near the horizon may be tinged with a suspicion of redness. The brightest region is the centre of the cone just clear of the haze belt, which varies in depth with the weather. This may be two or three times as bright as the Galaxy in Cygnus or Sagittarius. The light, however, lacks the glitter of the Galaxy, being reflected from tiny bodies while the Galaxy consists of myriads of suns radiating their light.

## LUMINOUS SKY

A cloudless night sky varies greatly in its appearance. Without a visible cloud there may nevertheless be much suspended material which we call haze, and stars may be dimmed by this medium, which does not shine by its own light. Then on another night the

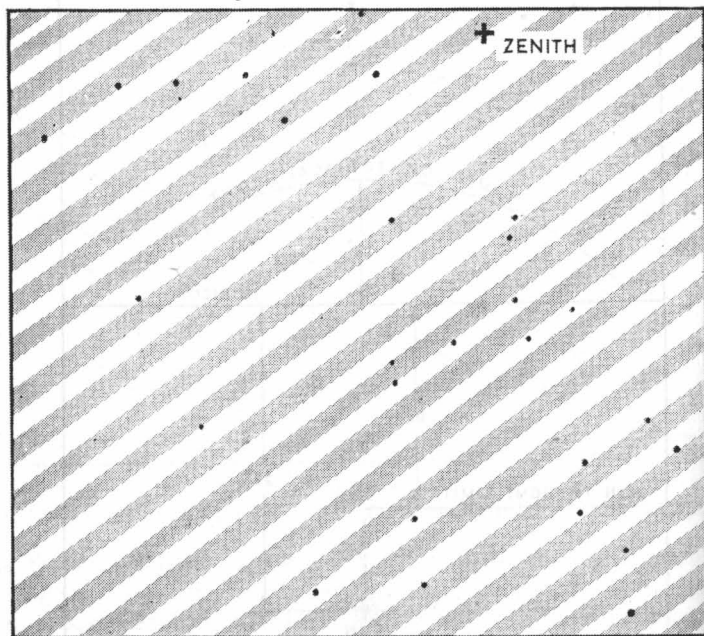

FIG. 100

LUMINOUS BANDS ON January 31, 1922, at 00.45 hrs. U.T., IN CUMBERLAND

sky may be almost entirely free from such material and appear black with stars visible down to the sixth magnitude, the Galaxy stretching its silver light across it, and the zodiacal band running its tributary stream into it. Again, on another still moonless night the sky may be crystal clear, yet we are surprised to find that the Galaxy which is overhead can hardly be seen at all, sixth magnitude stars are invisible, and only with difficulty can we see those of the

fifth magnitude. The reason for this is that the sky is filled with a mysterious luminosity without any concentration into shapes or forms, and this overpowers the light of the fainter features. On yet another occasion the clear sky is seen to be brightly luminous, but a most striking development has occurred. All the light is concentrated into bands or bars one or two degrees wide with similar width between; these run north and south, or east and west, or with some other orientation, and may cover the whole sky or only a part of it. They are pale white, no brighter than the Galaxy, but in the mass they give a strong illumination over the night scene; usually they are quite motionless. Cloud-like masses of luminous mist and curved beams have also been seen, apparently belonging to this class of nocturnal light.

## OBSERVING NOTES

The scientific observation of these various phenomena of the night skies is a spare-time activity that will appeal to nature lovers and all who find a health-giving tonic in the pure night air. A knowledge of the stars, an atlas of the heavens, and some ready means of determining measurements in degrees, are all required. Knowledge of the stars comes quickly after a few observing periods and comparison of the sky with the atlas. As the annual cycle progresses and new stars and the planets appear in their turns, the sky as a background of reference for recording the lights of which we have been speaking is found to be of the greatest use and also of the most absorbing interest. Equipped with knowledge that makes the sky scene familiar at all seasons, the night watcher with a drawing-paper block, pencil, and red electric torch, will be able to record, in a continuous uninterrupted period without any necessity to go frequently indoors, a great deal about the night sky illumination. With red light the eye will not be dazzled in writing notes, and a non-luminous watch is best for timing, as luminous watches have not the minutes illuminated, and the minutes are important, even sometimes to fractions. In any astronomical record time is the first information required, and to-day accurate time is available to every one. It should be recorded in Greenwich Mean Time, or else the standard zone time for the observer's station, the zone to be clearly indicated at the head of the records. Civil



summertime, used in some latitudes and places for seasonal convenience, should be absolutely disregarded. The most convenient and quickest way of recording time is the four-figure symbol on the 24-hour clock. For example, in dating an auroral incident by the figures, 1948-9-30-01.30, we record briefly that the time was half-past one in the morning of 1948 September 30.

Useful scientific information against the time would be the altitude and orientation of the auroral arc, the focal point of the auroral corona, the elongation of the apex of the zodiacal cone, the width of its horizon base, the orientation and position of luminous bands, or any other details that are obviously of an astronomical nature. Any general description of unusual phenomena should be left over for a more convenient time and should not interfere with the making of accurate positional observations.

The following hints on how to take notes are supplied by Mr. James Paton, M.A., B.Sc., F.R.S.E., Department of Natural Philosophy, University of Edinburgh.

## NOTES ON ENTRIES

Completion of columns A and B alone will be most valuable. C, D, and E need be completed only if you have sufficient time to make the necessary extra observations.

*Date Column.* The date 7, for example, refers to the night 7th to 8th.

*Column A.* Enter  $x$  for a definite occurrence of aurora.

Enter  $o$  for a definite non-occurrence.

Enter ? for a doubtful occurrence, e.g. when it is difficult to be certain because of bright moon or cloud.

Enter *N.O.M.* for no observation made, e.g. because you are otherwise engaged, away from home, etc.

Enter *N.O.P.* for no observation possible because of cloud or fog or some other obscuring factor.

*Column B.* Enter time or period of time to which your observation refers in G.M.T., e.g. 20.10-20.25. If you observe aurora after having earlier on the same night noted its absence from the sky, make two entries,  $o/x$ , with the appropriate times.

*Column C.* The abbreviations for the various forms are:

<i>Without Ray Structure</i>		<i>With Ray Structure</i>		<i>Flaming</i>	
HA	Homogeneous Arc	RA	Rayed Arc	F	Waves of
HB	Homogeneous Band	RB	Rayed Band		light surging
PA	Pulsating Arc	R	Rays		to the zenith
DS	Diffuse Surface (like a cloud)	C	Corona		
G	Glow on the N. horizon		(Converging of rays overhead)		

*Column D.* The intensity numbers are:

1. Weak—same as Milky Way.
2. Moderate—like cirrus cloud in moonlight.
3. Bright—like cumulus cloud in moonlight.
4. Very bright.

*Column E.* Express in degrees from 0 to 180 *or* with reference to stars, e.g. 'reaching up to the Pole Star' (from N. Horizon).

Further notes referring to a particular display, its colour, and development, etc., would be welcome.

The regular observer will undoubtedly keep his records in a system of filing as substantial and convenient as he can manage, and will get in touch with some society and procure suitable literature dealing with the subject. There is great encouragement in co-operating with others in all scientific work, and very much additional knowledge is gained by communicating with them.

## NOTES ON THE ILLUSTRATIONS

*Fig. 95.* This figure shows the form of the auroral arc when seen low in the sky; it is the commonest auroral form seen in the British Isles. From being a homogeneous arc it has just reached a minor climax, when short streamers are seen brightening and fading all along its length, without the arc actually dissolving. The star background of the Dipper shows midnight at the autumnal equinox in the north temperate zone, the arc is normal with the sharp boundary below, diffuse above, and between the horizon and the arc there often appears a sky of intense blackness.

*Fig. 96.* The dotted outline encloses the western cone of the zodiacal light amongst the bright assemblage of spring stars, as seen in Britain in early April. Orion and Taurus are on the left, the Pleiades and Aries in the cone, Perseus and Andromeda over the north base extension.

*Fig. 97.* This is the corresponding morning aspect of the cone seen in the autumn. The front of Leo, Cancer with Praesepe, are in the cone, Castor and Pollux above the apex, Procyon, Sirius, and Orion

on the right. Again the northward extension of the base is very noticeable.

*Fig. 98.* On a November night in Britain we shall find a region of the ecliptic fairly well placed for a search for the zodiacal band and counter-glow. Either or even both may be detected in a perfect sky. Here the track of the band, if seen, will lie between the dotted lines, with Aries and Pegasus above and Cetus below. The counter-glow's position will follow the anti-solar point along this track.

*Fig. 99.* In Britain we can still see the glimmer of zodiacal light hovering over the Sun's midnight position after twilight ends until early September. The boundary on the first of that month is seen marked by dotted lines below the Dipper, the Galaxy being just clear of the area and to the right. In these figures (96-9) the dotted boundaries of the light areas are, of course, approximate, because no sharp boundary line is seen in the zodiacal light as it is in the aurora or luminous sky.

*Fig. 100.* This figure shows a portion of the most extraordinary display of nocturnal luminosity ever seen by the writer. Pale white bands over the whole sky brightened the scene below, shining motionless for hours in the clearest sky in which light clouds of sea fog drifted rapidly from the south, but never in quantity sufficient to interfere with observation. At one time there was crimson light in areas that shifted, the bands remaining white. The map of the overhead scene is shown in the figure.

*Plate XX.* The three displays of aurora, chosen for special illustration of this account, occurred during a most remarkable succession of superb displays from 1937 January 7 to 1941 October 31. The drawing shows the climax of a great aurora on 1937 April 26; already in that year three major displays had been seen. Just before midnight a great magnetic storm reached a very marked maximum, and coinciding to the minute with this magnetic climax, the beautiful scene illustrated in the plate was watched in Cumberland. This was a remarkable concentration of creamy-white draperies surrounding Castor and Pollux, low in the north-west, with three broad beams radiating equidistant from the centre. This display was the more extraordinary in that this corona-like activity was far from the usual location at the magnetic zenith.

*Plate XXI.* On 1940 March 24 at 21.00 hours a most magnificent corona formed as the auroral arc passed overhead to the southern sky. The illustration shows the scene around the magnetic zenith, and some conception of its grandeur may be formed from the fact



J. R. Bell

## PLATE XX

Curtains and rays in Cancer and Gemini, 1937 April 26, at 23.45 hrs. U.T.

that all the streamers shown meeting here in the Cumberland sky arose from every point on the horizon, and were finely coloured in crimson, green, and white. The almost full moon in the low south-east sky, surrounded by the aurora, passed quite unnoticed. The impression of the watcher was that of being in a vast celestial brightly coloured tent. Streamers were in hundreds, and the corona stage lasted twenty-five minutes. The magnetic storm accompanying this display was said by the Rev. J. P. Rowland of Stonyhurst Observatory to be one of the greatest he had ever seen.

*Plate XXII.* The remarkable form shown in this picture occurred during what proved to be the last of the great series of great aurorae in this very active cycle, mentioned above. An active display was

\* K

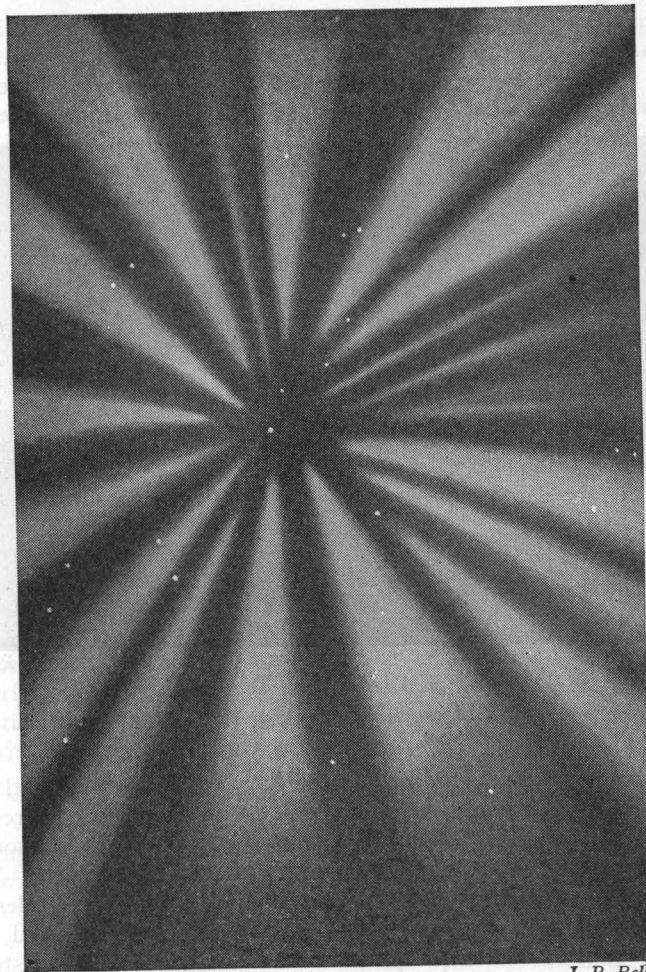

PLATE XXI

*J. R. Bell*

Corona in Lynx, 1940 March 24, at 21.00 hrs. U.T.

being watched from Cumberland over the south coast of Scotland on 1941 October 31, in a hazy sky fairly strongly illumined by a three-quarter moon rather high in the south-west. Suddenly all the

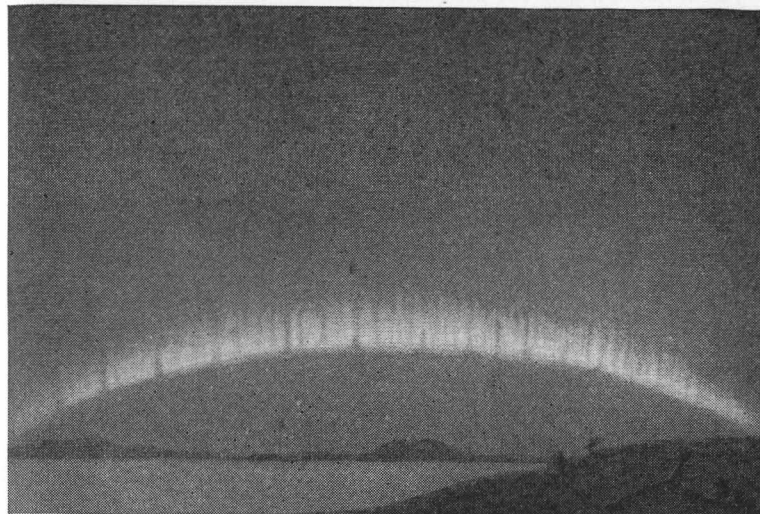

PLATE XXII

*J. R. Bell*

Arc with ray structure, 1941 October 31, at 23.25 hrs. U.T.

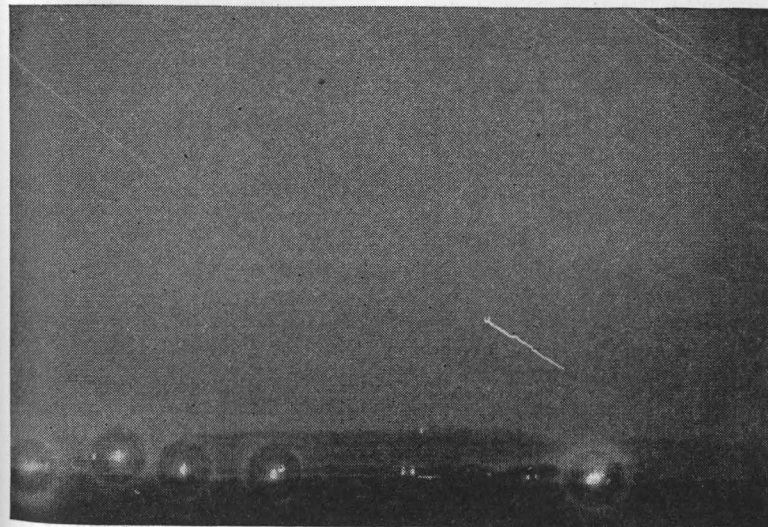

PLATE XXIII

*W. B. Housman*

Zodiacal light over the Solway, 1927 March 30, evening cone



auroral activity ceased, the green and crimson glows were extinguished, and there was flung across the sky in the north-west at an altitude of  $16^\circ$  the most beautiful arc about  $2\frac{1}{2}^\circ$  wide, like a ribbon extending for  $70^\circ$  over the Solway Firth, and composed of hundreds of



*J. Paton*

PLATE XXIV

Corona at Abernethy, 1949 January 25, at 01.45 hrs. U.T.

very short streamers or rays, that gave it its ribbon-like appearance. For three minutes this arc reigned supreme and alone. Then again, it was a case of 'On with the dance!' and the arc dissolved, curtains waved in the northern sky, and the 'Merry Dancers' of Scotland continued their Hallowe'en revels. Those who watch the Northern Lights can never guess what they will see next of this beautiful phenomenon.

The three plates are from drawings made by the artist-astronomer, J. R. Bell, F.R.A.S., of Newcastle-upon-Tyne, from information and sketches supplied by the writer, who observed these auroral

displays in very perfect conditions of weather and outlook, and who can present these plates as being very accurate representations of the auroral forms he witnessed.

PHOTOGRAPHS

The zodiacal light over the Solway (*Plate XXIII*) was taken with 40 minutes exposure at F/2 aperture by the writer on a clear



*D. A. Thomson*

PLATE XXV

Multiple arc, Newburgh-on-Tay, 1947 April 17, at 22.55 hrs. U.T.

night, with a north-west wind blowing strongly, and the view includes industrial shore lights, the water dark against the zodiacal light and the Ross Light in Scotland, which was 20 miles away. The planet setting was Venus.

The corona from Abernethy (*Plate XXIV*), photographed by J. Paton, was one climax in a great display at the magnetic zenith.

The western end of the multiple arc (*Plate XXV*) was photographed by D. A. Thomson at Newburgh-on-Tay. *Plate XXVI*

shows the eastern end of a rayed arc at Abernethy. The photographs were taken using an auroral camera F/1.25, focal length 5 cm.

The photograph of the auroral arc above noctilucent cloud (Plate XXVII) is rightly described by Mr. Paton, who obtained it in the course of his research work, as a 'rare coincidence.' Noctilucent clouds are not to be confused with the luminous sky referred to previously. At a height of some 50 miles or so minute particles are illuminated by arctic sunlight and reflect bluish rays into lower latitudes. They are a rare and beautiful sight in the summer sky, when the aurora, which emits its own light, is seldom able to overcome the twilight.

#### NOTE ON AURORA SURVEY

By JAMES PATON, M.A., B.Sc., F.R.S.E., *Director of the Aurora and Zodiacal Light Section, British Astronomical Association.*

The observation of the aurora offers an excellent opportunity to the keen amateur observer of supplying information likely to be of value to the theoretical worker. Since there is no instrument that can automatically provide a complete record of auroral forms and their changes in place and time, the only method of securing reasonably complete information is by an organized survey of auroral occurrences, i.e. by assembling the observations of a wide and close network of observers on land, sea, and in the air. Such a network, covering the regions from Iceland and the British Isles to the Atlantic coasts of North America, is now being established. Land observers must, of course, be so situated that there is no town to the north whose smoke and artificial lighting will obscure auroral glows. Suitably placed observers are invited to write for particulars to Aurora Survey, Department of Natural Philosophy, the University, Edinburgh, 8.

#### BIBLIOGRAPHY

- L. Harang: *The Aurorae*, Chapman & Hall.  
*Photographic Atlas of Auroral Forms, and Supplement*, published by the International Geodetical and Geophysical Union, Oslo, 1951.  
 Professor C. Störmer's great work in Southern Norway may be followed by reading the following well-illustrated numbers of Geophysical Publications, Oslo.  
 Vol. iv, No. 7. *Results of Photographic Measurements, 1911-22.*  
 Vol. xi, No. 3. *Measurements with Long Base Lines, 1935.*  
 Vol. xi, No. 5. *Remarkable Forms, 1935.*  
 Vol. xi, No. 12. *Remarkable Forms, 1936.*  
 Vol. xii, No. 7. *Height and Spectra, 1936.*  
 Vol. xiii, No. 7. *Remarkable Forms, 1942.*  
 The Dano-Norwegian Greenland Auroral Expedition, 1938-9, is well described and illustrated with figures and plates by Professor C. Störmer, published in Copenhagen by C. A. Reitzels Forlag, 1947.  
 Professor Störmer has completed a book *The Polar Aurora* which is shortly to be published by Oxford University Press.



J. Paton

#### PLATE XXVI

Eastern end of rayed arc, Abernethy, 1949 March 17, at 23.17 hrs. U.T.



J. Paton

#### PLATE XXVII

Auroral arc over noctilucent cloud, Abernethy, 1950 July 24, at 23.56 hrs. U.T.

## EXPLANATION OF STELLAR MAGNITUDE

When a number of children enter for an examination and the results are known, the children are sometimes classified into first, second, third, etc., and in these circumstances the 'brighter' children are always classified as first, those less bright as second, and so on. Now astronomers have adopted almost a similar method when dealing with the stars, but in this case they do not speak of the 'class' of a star when describing its brightness but of its *magnitude*. Thus if they want to give an indication of the way in which a bright star impresses them they describe it as a star of about magnitude 1, and a star which is not so bright—say less than half as bright—they describe as magnitude 2, and so on. It will assist in understanding what magnitudes mean if you remember the simple rules given below.

Look at the heavens on a clear moonless night and you will see a few stars that are just visible to the naked eye, or, if you would like to hold a competition with some of your friends who, you suspect, are not so keen-sighted as you are, challenge them to spot a star that you can just see. Perhaps some of them will declare that they can see it quite easily and others will not only declare that they cannot see it, but may even charge you with deception! If they do you can invite them to look at Mizar in the Plough<sup>1</sup> and ask them whether they can see a companion very close to it. Perhaps some will still assert that you are deceiving them, and if so the best procedure is to make them look through a pair of binoculars or even the smallest hand telescope. They will then admit that they have made false accusations against you. A good test for a keen-sighted person is to ask him to count the number of stars in the Pleiades.<sup>2</sup> If he says there are only six, or perhaps seven, you can assure him that his sight is only average; if he can see more than seven you can reassure him that he can be classified amongst 'keen-eyed' observers.

Now any stars which are just on the verge of visibility to the naked eye can be accepted as magnitude 6 and may be likened to those children who are classified as 'sixth' in an examination (if such a low classification is ever given). Fainter than a sixth magnitude star is a seventh, and fainter still an eighth, and so on,

<sup>1</sup> See Star Maps.<sup>2</sup> See Star Maps.

## CHAPTER VIII

## THE STARS

P. DOIG, F.R.A.S.

*Author of 'An Outline of Stellar Astronomy'**Editor, 'The Journal of the British Astronomical Association'*

**B**EFORE reading this chapter it is advisable that the Introduction should be re-read and thoroughly understood. This will assist very considerably in following certain more difficult portions dealing with the constellations and stars, their movements, sizes, distances, etc.

It was pointed out in the Introduction that the Sun is just one star out of thousands of millions that compose the Galaxy, and that all the stars that we see—a minute fraction of those that are invisible—are in the Galaxy. This in its turn is merely one out of hundreds of millions of similar galaxies scattered throughout the remote depths of space.

Later on a number of star maps are given which will enable the reader to find some of the more important stars, but even without studying these maps it is only necessary to look at the heavens on a clear moonless night, to see that the stars differ very much in brightness. While this may not seem a very important matter it may be stated at this stage that astronomers attach the utmost importance to this difference and, as will appear later, from it they are able to deduce a number of conclusions regarding the distances and sizes of the stars.

It will simplify much of what follows if at this stage an explanation of the *magnitude* of a star is given, and we shall start with a very simple comparison which should make the subject clear to every one.



but these can be seen only with some form of optical aid, and when you come down to a twenty-second magnitude star this requires the very largest telescope to detect its existence by photography.

Having set a standard for a sixth magnitude star—one near the limit of naked-eye visibility—you can make a rough estimate of the magnitudes of others by remembering the following method that astronomers have adopted for describing the brightness of a star.

A star of magnitude 5 is two and a half times as bright as a star of magnitude 6, and hence on a clear moonless night you should have no trouble in seeing a fifth magnitude star. A star of magnitude 4 is two and a half times as bright as one of magnitude 5, and a star of magnitude 3 is two and a half times as bright as one of magnitude 4, and so on. By following out this scheme it is easily found that a first magnitude star is exactly a hundred times as bright as a sixth magnitude star, forty times as bright as a fifth magnitude star, sixteen times as bright as a fourth magnitude star, about six and a quarter times as bright as a third magnitude star, and two and a half times as bright as a second magnitude star. When a star is brighter than third magnitude and fainter than second magnitude its real magnitude is expressed by some number intermediate between 2 and 3, and so on for other magnitudes. Thus the pole star, which every one should know, is not so bright as a star of magnitude 2 but brighter than one of magnitude 3, and its actual magnitude has been fixed as  $2\frac{1}{10}$  or 2.1, as it is usually expressed. Readers need not trouble much at present about these fractional magnitudes, and it will be sufficient for them to take the nearest whole number as the magnitude until they have had more experience in estimating stellar brightness. The magnitudes of some of the more important stars are given on page 491.

#### NUMBER OF STARS VISIBLE

The faintest star visible to ordinary vision on a clear moonless night is one between sixth and seventh magnitude. Throughout the whole sky there are about 7,000 stars brighter than this limit, and hence in theory an observer should be able to see about 7,000 stars with the naked eye. This, of course, assumes that he could view not only those in our northern skies but also those in the southern skies by visiting some country in the southern hemisphere,

such as Australia, New Zealand, or South Africa. But stars low down in the sky are difficult to see because the atmosphere in that direction absorbs a lot of their light, and so on an ordinary night it is doubtful whether the keenest eye could detect in its sky more than about 2,000 stars; of course, the presence of moonlight would considerably reduce this number.

The immense number of stars fainter than those that can be seen with unaided vision may be gathered from the fact that, over the whole sky, a 3-inch aperture telescope would show about 2 million stars, a 12-inch aperture would show about 25 million, while the new 200-inch telescope on Mount Palomar, California, would reveal not far short of 2,000 million. Astronomers estimate that the total number in our Galaxy alone is probably fifty times this last number. It may be pointed out at this stage that, though hundreds of millions of extra-galactic nebulae—those outside our Galaxy—can be photographed with the 200-inch telescope, individual stars cannot be detected in them except in the case of bright Cepheid variables, novae or supernovae, of the nearer galaxies.

#### WHY STARS DIFFER IN BRIGHTNESS

It is obvious that some stars appear to be much brighter than others because they are nearer to us, but of course there is another explanation. If one looks at a number of electric bulbs, say 60-, 100-, and 150-watt lamps, all at twenty feet distance, the 150-watt would, as is to be expected, appear the brightest under these conditions. But now alter the conditions by viewing the 150-watt bulb at a distance of, say, a hundred feet. You will, of course, find that it appears much fainter than any of the others, this falling off in brightness being due to its greater distance. The law connecting brightness and distance is given and illustrated in Chapter IX, and it is unnecessary to say anything further on this matter. When, therefore, you see a very bright star like Sirius—the brightest star in the heavens—you must not think that if some of the fainter stars could be placed at the same distance as Sirius they would necessarily appear less bright than Sirius; many of them would look brighter, and obviously the most reasonable way for deciding on the real brightness of stars would be to reckon how bright they would look if they were all placed at the same distance from us. But

how can this be done? The astronomer cannot move a star just where he pleases to see how bright it looks. He can, however, do something almost as effective and that is, knowing how bright a star is and also knowing how far away it is (the method for finding its distance will be explained later), he can compute quite easily how bright it would look if placed at any chosen distance from the earth.

#### ABSOLUTE MAGNITUDES OF STARS

Let us take Aldebaran as an illustration. This is a well-known reddish star in the constellation of Taurus, the Bull (see page 326), and its magnitude is almost exactly 1. The light from this star requires about 58 years to reach the Earth, or, in other words, its distance from us is 58 light-years. Now if we want to know how bright this star would look if it were at a distance of 32.6 light-years, that is, at only 0.56 of what it actually is, we proceed as described on page 294, that is, we multiply 0.56 by 0.56, thus obtaining 0.314. Hence Aldebaran looks only 0.314 times as bright as it would if it were 32.6 light-years from the earth, and from this it is easy to find the corresponding change in magnitude, knowing that a change of one magnitude in a star corresponds to a change of brightness of  $2\frac{1}{2}$ .

When the apparent magnitude of a star is known and also its distance (or parallax) it is easy to compute the apparent magnitude of the star if it were at some accepted standard distance. The standard distance used is 32.6 light-years, corresponding to a parallax of  $0''.1$ , and the magnitude a star would have at this distance is known as its *absolute magnitude*. The absolute magnitudes of a large number of stars have been computed in this way, and it is surprising to know how many apparently faint stars would appear very bright at a distance of 32.6 light-years and how many apparently bright stars would appear faint at this distance. As one instance we may refer to our Sun, the brightness of which *appears* to be more than 100,000 million times that of Aldebaran. But this brightness is only due to proximity because the absolute magnitude of the Sun, that is, its apparent magnitude at a distance of 32.6 light-years, is only 4.8, so that it would be a little brighter than a fifth magnitude star and visible, but not very much more, to an ordinary sighted person. At the same distance Aldebaran

would look a whole magnitude brighter than a first magnitude star! This confirms some of our previous observations on the insignificance of our Sun in comparison with many other stars.

#### MEASURING THE DISTANCES OF STARS

We shall now describe how the distances of the stars are measured; it has been assumed up to the present that these distances were known when the absolute magnitudes of stars were determined, but the distances of the stars are known only after certain computations have been made. In connection with these computations it is important to bear in mind what was previously hinted at, i.e. that many stars are faint merely because they are far away and not because they are small. Generally speaking, the fainter stars are farther away from us than the brighter ones, and although there are many exceptions, this rule may be adopted in one out of several approximate methods for finding stellar distances. We shall illustrate the method by taking a simple terrestrial example.

Let us suppose that an object  $O$ , say a church steeple, is far away from a surveyor and that local conditions prevent him from approaching it very closely (Fig. 101). He wants to find out how far it is from him and to do so he measures a distance  $AB$  in such a direction that  $AB$  is athwart the line from  $O$  to his position, not running to any extent towards it. Thus it would be incorrect to measure  $AB$  in the direction  $A'B'$ , because the latter line runs too much towards  $O$ . Now if the surveyor can only measure the angle  $AOB$ , then, knowing the length of  $AB$ , he can find how far away  $O$  is. But how is he to measure the angle  $AOB$ ? He can proceed as follows, when the angle  $AOB$  is small.<sup>1</sup>

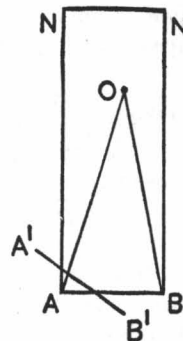

FIG. 101

If he has a prismatic compass he knows that the magnetic needle will point to the magnetic north at  $A$ , and this direction is shown by the line  $AN$ . In the same way when he places the prismatic compass at  $B$  he knows that the needle will still point to the

<sup>1</sup> While this method could be used, in actual practice a surveyor would adopt a different procedure which, however, could not be employed in measuring stellar distances. For this latter reason the method applicable for celestial purposes is explained.

magnetic north, the direction being shown by the line  $BN$ . At  $A$  he can easily measure the angle  $OAN$  and at  $B$  he can measure the angle  $OBN$ ; the angle  $AOB$  is the sum of these two and so is easily found. Notice that the application of the method depends on the fact that the magnetic north, shown as  $N$ , is so far away that the two lines  $AN$  and  $BN$  are practically parallel, that is, they do not meet except at a very great distance from  $AB$ . All this is elementary geometry to some readers, but if there are any who are not conversant with these simple principles they will accept them as they have been stated without asking for a proof.

The following example will illustrate the method.

If the angle  $AOB$  is 400 seconds of arc (although such a small angle could not be measured very accurately with ordinary surveying instruments, it can be used merely as an illustration) and the distance  $AB$  is 100 feet, then the distance of  $O$  from  $A$  or  $B$  is found by multiplying a definite number 206,265 by 100 and dividing the result by 400. As this gives us 51,566 feet or just over  $9\frac{3}{4}$  miles, this is the distance of the church. (The number 206,265 is used for all similar cases, terrestrial and celestial. It is the length of each side of an isosceles triangle, having an angle of one second at its apex, in terms of the length of its base.)

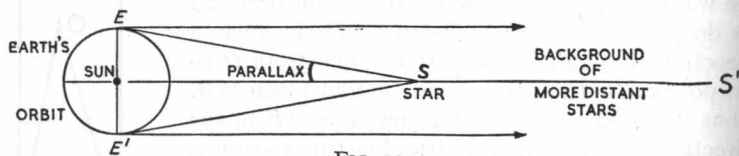

FIG. 102

Now the astronomer adopts precisely the same *principle* but his base line  $AB$  is more than 100 feet. It is the diameter of the Earth's orbit, 186,000,000 miles,<sup>1</sup> and even this is too small as a base line to determine accurately the distances of the stars except those that are comparatively close to us. Let us see how the astronomer makes use of his base line and a faint, presumably remote, star which serves the same purpose as the magnetic north.

In Fig. 102  $E$  and  $E'$  represent the Earth at two positions in its orbit after an interval of six months, the line joining the points  $E$  and  $E'$  passing through the Sun;  $EE'$  corresponds to  $AB$  in Fig. 102.

<sup>1</sup> See page 9.

Suppose the astronomer wants to find the distance of a star  $S$  which corresponds to  $O$  in Fig. 101, he uses a faint star  $S'$ —so faint that he assumes it must be very much farther away than the star  $S$ —and finds the angles  $SES'$  and  $SE'S'$ . Of course, he must wait six months before he can make the second observation from  $E'$ , but six months is a short interval for an astronomer to wait for his observations. From these two angles he finds the angle  $ESE'$ , just as he found the angle  $AOB$  in his terrestrial experiment. Notice the use of the faint star  $S'$ . It serves the same purpose as the magnetic north in the terrestrial experiment, in other words, it is so far away that lines drawn to it from  $E$  and  $E'$  are almost parallel, and indeed in the diagram these lines  $ES'$  and  $E'S'$  are shown as parallel.

A specific example will show how the above rule works in the case of stars.

It was found in one case that the angle  $ESE'$  was 1.566 seconds of arc. How far away was the brighter star  $S$ ? (The fainter star  $S'$  is assumed to be very far away—as if it were at an infinite distance.)

Multiplying 206,265 by 186,000,000 and dividing by 1.566, the result is 25 million million miles, in round numbers. The star  $S$  in this case was the star known as Proxima Centauri—the nearest star to the Earth—and light would require over four years to travel this distance. Hence we usually describe this star as over four light-years distant. By way of contrast it may be noticed that the light from the Sun requires 500 seconds or a little over eight minutes to reach the Earth. In actual practice the parallax angle used is that corresponding to the *radius* of the earth's orbit, which is  $0''.783$  for Proxima Centauri. Astronomers have used this method to find the distances of several thousand stars, but there are limits to its application. It becomes less accurate the greater the distance of the star, and the reason for this is that the small angle  $ESE'$ —only 1.566 seconds for the nearest star—becomes less as the star's distance increases, until finally it is too small to determine with sufficient accuracy. An angle of 1.566 seconds is the angle that a halfpenny would subtend at the eye if it were placed about two miles away. One can get some idea of what this means by placing a halfpenny at a small distance away—say fifty feet—and noticing how small is the angle at the eye made by two lines drawn from two points on the rim of the halfpenny, these points being on



opposite sides of the centre of the coin. Yet this angle is more than two hundred times as great as the angle subtended by the halfpenny two miles away!

There is another way for finding the distances of the stars, which can be used for those so far away that we cannot apply the *trigonometrical method* just described. To understand this other method let us return to the illustration of the bulbs of different luminosities, from 60 watts upwards.

#### ANOTHER METHOD FOR DETERMINING STELLAR DISTANCES

Suppose we knew that one bulb was a 75-watt and another a 300-watt and that the lamps were placed at different distances from us, then from what is said on pages 289-90 about the way in which luminosities fall off with increasing distances, we could give some idea of the relation between the distances of the bulbs from us by comparing their luminosities, even judging this by the eye without any astronomical equipment. Imagine that we were able to measure the distance of the 75-watt bulb and found it to be 100 feet, but that the 300-watt bulb was placed on the far side of an obstacle which prevented us from directly measuring its distance. However, by careful observation we conclude that the two lamps appear just the same in brightness, and in these circumstances we have all that is necessary to find the distance of the 300-watt lamp. The method for doing this is as follows.

We have assumed that we know the luminosity of each lamp, and for the present we need not concern ourselves with how this is known. The larger lamp should, therefore, be four times as bright as the smaller one, provided each is placed at the same distance from our eye, but we find that it appears just the same brightness. Obviously this shows that it is twice as far from us as is the smaller lamp because, as is pointed out elsewhere,<sup>1</sup> luminosity falls off inversely as the square of the distance, that is, a luminous body which seemed to be, say, 20 candle-power at a distance of 60 feet, would appear to be only 5 candle-power at a distance of 120 feet, and would appear to be 80 candle-power at a distance of 30 feet, and so on. Notice that when we double the distance, that is, multiply it by 2, we then square the 2 and *divide* the result, which is 4, into 20, giving us 5.

<sup>1</sup> See page 361.

When we halve the distance, that is divide it by 2, we square the 2 and then *multiply* the result by 20, which gives 80. From this it will be seen that the larger lamp in the first instance must have been twice as far away as the smaller one, and as the latter was found to be 100 feet, the 300-watt globe must have been 200 feet away.

The same principle is used in finding the distances of the stars. Let us assume that the astronomer has measured the distance of a fairly close star by the method first explained, and that he wants to find the distance of another very faint star which, he suspects, is so far away that the angle *ESE'* in Fig. 102 would be very small, and that therefore its accurate determination would be open to serious doubt. In this case all that he requires to do is to find out the real luminosity of each star (just as the real luminosity of each globe was known in the experiment described) and the distance of the brighter star. Suppose that he found the distance of the brighter and closer star to be 9 light-years, and that he also found its luminosity to be 2,500 times that of the fainter star, he then knows that this fainter star is 50 times as far away as the brighter one ( $50 \times 9 = 450$ ), and so its distance is 450 light-years.

All this seems simple enough, but there is one important point that has not yet been explained—how does the astronomer know the real luminosity of a star? We know the real luminosity of an electric bulb because it is labelled and no matter how far off the bulb is shining, and however feeble it may appear owing to its distance, if it has 300 watts on it and we can see this, or any distinguishing mark on it—say a red cross which denotes 300 watts—we have definite information on which we can work. Can the astronomer see labels or some characteristic marks on the stars which inform him about their real luminosities? The answer—and some may find it very difficult to believe—is that he can and does, but the nature of these labels cannot be explained at this stage. We shall deal with them later in the chapter. (See pages 316-20.)

#### OTHER METHODS FOR DETERMINING STELLAR DISTANCES

Several other methods are used for finding the distances of the stars, but it will be better to defer explanations of these until we deal with other points connected with stars, such as double stars,

stellar motions, the use of the spectroscope on stars, etc. It may be stated now, however, that the different methods show a good agreement and that the enormous distances separating us from the stars have been calculated and are still being calculated with a considerable amount of accuracy.

#### PROPER MOTIONS OF STARS

Although people often speak about the 'fixed stars' to emphasize the difference between a star and a planet,<sup>1</sup> it is not strictly correct to do so. For more than 200 years it has been known that the stars are in motion, but because changes in position due to such motions appear very small and in fact are usually inappreciable to the naked eye even in the course of hundreds of years, the term 'fixed' as applied to the stars is not altogether inappropriate. To give some idea of the amount of the stars' changes in position in the heavens it will be best if we take the one which has the greatest change or *proper motion*, as it is called. In this case it has been found that the star moves about the width of the Moon in 190 years, and it might be thought that change in position due to such a movement would be easily obvious to the naked eye even in the course of a few years, but this is not so. The width of the Moon is rather deceptive, as the following simple experiment will show.

Measure a distance of 9 feet and look at a halfpenny set at this point. Its width corresponds to the apparent distance that the star just mentioned would move in 190 years, and if you think you could detect a space of one-twentieth of the diameter of the halfpenny at this distance, which corresponds to the proper motion of the star in about one-eighth of your lifetime, you must consider your vision to be very acute and accurate!

As a result of the proper motions of the stars the shapes of the constellations on the sky change so much in the course of thousands of years that we might have some difficulty in recognizing maps of the heavens compiled by men of the Stone Age (though it is fairly certain that these men did not draw maps of the heavens!). However, we need not go back so far in history as this; even from the days when the Chaldeans studied the stars many of the constellations have changed their shapes and the well-known stars in the Plough

<sup>1</sup> See pages 1-2.

(see Fig. 103) will have altered their positions so much in the course of thousands of years that if an astronomer of to-day returned then to Earth he would scarcely recognize this well-defined portion of the Great Bear. In connection with the Plough the following interesting fact should be noticed.

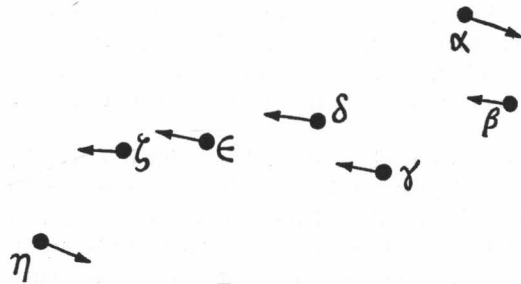

FIG. 103

PROPER MOTION OF STARS IN THE PLOUGH  
The length of the arrows shows motion in 80,000 years.

The stars in any constellation are not necessarily moving in the same direction, and such stars as may seem to be connected in some way because they appear in the same group, have often no connection between themselves, though in some cases there is a decided connection in a common motion and also in other ways. For instance, the first and last stars in the Plough are moving in one direction, and the intermediate five stars are moving in a different direction. (See Fig. 103.) The five stars are part of what is known as a 'moving cluster'; of these there are a number of groups, such as that in the constellation of Taurus, the well-known cluster known as the Pleiades, and the Beehive Cluster known to the ancients as Praesepe—a name still used to describe this cluster.

#### THE SUN'S JOURNEY AMONGST THE STARS

The Sun, like the other stars, has its own spatial motion, the discovery of which was made by Sir William Herschel. By a study of proper motions he noticed that from a spot in the constellation of Hercules, not far from the bright star Vega, the stars appeared to be opening out on the sky, while towards a place in the heavens exactly opposite to this they seemed to be closing in. This effect,

specially noticeable for the naked-eye stars, was apparent only after comparisons of positions in the sky over many years, and even then it was very small, but sufficient for Herschel to give the correct explanation in 1783. He realized that this tendency might be due to the actual movements of the stars or it might be due to another cause—the movement of the Sun which, of course, would carry the planets, including the Earth, along with it. If this were so, then observations of the stars which were made from the Earth would show an effect that is often observed when you walk through a wood.

Suppose you are walking towards a point in a wood in which the trees are spaced more or less evenly, and from time to time you look towards the point and also in the opposite direction. You will observe that the trees appear to open out in front of you and to close in behind you, this appearance being due entirely to your own movement. The same thing applies in the case of the stars, which appear to open out in the direction in which the Sun is moving and to close in behind this direction. It should be noticed that, although the stars used by Herschel in his investigation had all their own individual proper motions, yet on the average these motions cancelled out, as they were in various directions, so that the stars might be considered to be on the average motionless so far as the movement of the Sun and its planets amongst them was concerned.

When you next look at the beautiful star Vega remember that the Sun and all its attendant planets, satellites, minor planets, and comets are drifting towards it with a speed of more than 12 miles a second. You need not fear a collision with Vega; before the Sun has reached the place where Vega is now that star's proper motion will have carried it far away from its present position. In addition, the time that the Sun, moving with a speed of 12 miles a second, would take to reach Vega would be about 400,000 years, so if Vega were sufficiently obliging to remain in its present position for the collision, this need not disconcert the present generation.

SUN'S MOTION USED TO FIND THE AVERAGE DISTANCES  
OF CLASSES OF STARS

As the Sun's journey carries it nearly 400 million miles each year,

this affords astronomers a much longer base line than the diameter of the earth's orbit, 186 million miles, especially as they can wait as many years as they please to secure as long a base line as they require. Hence with such a long base line reaching thousands of millions of miles, greater accuracy might be expected in finding the distances of the stars, but unfortunately their proper motions make the method untrustworthy for any particular star. On the other hand, assuming that the motions of the stars are random, that is that they move indifferently in all directions, it is possible to obtain average distances for *classes* of stars. To understand this point, which is very important, let us revert to the method that can be used for finding the distance of the church (see page 291), but we shall now imagine that no such landmark is visible.

Instead of the church spire let us take the problem of finding the distance of a large field in which there are hundreds of people moving about in every direction. In these circumstances a surveyor would find it difficult to take his angles very accurately, owing to the motions of the people. However, if he has time and patience he can concentrate his attention, now on one person, now on another, and so on, and find the distances of a dozen or more people in the field. He knows that if he depends on any one person he will possibly be a long way out in his reckoning, and probably the faster any one is moving the greater will be his error. But he bases his final results on the view that, on the whole, the people are moving about impartially—having no definite goal in the field—and that if he took the average for a large number he would find that they are moving just as much in any one direction as they are in another. Hence he can take an average of his calculated distances and can then say, without involving any serious error, that the people in the field, or to be more correct the field itself, is so many miles away. (Although the illustration is crude it will serve its purpose in simplifying the problem.) In just the same way the astronomer can say, in spite of the proper motions of the stars, that certain classes are, on the average, so many light-years distant from the Earth. This is a third method used for finding stellar distances, and it has been employed quite successfully.



## LINE OF SIGHT (OR RADIAL) MOTIONS OF STARS

Up to the present readers may have thought that 'proper motion' described the entire motion of a star, and it would perhaps not be surprising if they entertained this view. But the observed proper motion of a star, which must be kept under observation for many years for this purpose (as the proper motion in one year is usually very small), may be, and often is, the effect of a very small part of its actual motion. To explain this by a simple illustration, let us look again at the people in the field who are walking about in all directions.

In this case we shall imagine that there are a few landmarks, such as trees, in the field, and then an observer can see the people (with the aid of a small telescope, if required) and compare their positions at times with the trees. He can then say that he has discovered certain interesting facts about them, for instance, that some appear to move much faster than others, from which he might conclude that there is a collection of both young and old people in the field. Incidentally it may be remarked that the astronomer often deduces a number of very important facts—much more important than the ages of the people in the field—from far less data than this. In addition to noticing the different speeds with which the people move about, the observer also notices that quite a number of them do not seem to move at all, and this presents a problem. He will suspect, on reflection, that while some of those who do not appear to move are actually standing still, yet others may be moving quite quickly, but in such a manner that he cannot detect the motion. How is this possible?

Imagine someone is walking in the direction of the observer, who, we have supposed, is very far off from the field; the observer will be unable to see any change in his position with reference to a tree in the background. The same thing applies if he is walking directly away from the observer, and it is only when people are moving athwart the line from the field to the observer that their movements can be seen. A very good illustration of this important fact is found in the case of a motor-car travelling at night. An observer standing on a long straight road along which the car is moving cannot tell that it is approaching. He sees its headlights but they appear just the same as if the car were standing still. The same

applies if the car is moving away from the observer; he sees its rear light but this does not tell him that the car is moving away; it might be standing still or even backing towards him. Of course, we assume a fairly good distance between observer and car, and also exclude any judgment regarding its motion from the sound of the engine. Now suppose the car is moving athwart the line of sight, say at cross-roads, the observer can tell immediately that the car is moving, and it need not do so absolutely athwart the line of sight. It may be moving partly to or from him and partly athwart the line of sight, and the latter, however small it may be within reasonable limits, will soon show the car's proper motion. In fact, its motion athwart the line of sight corresponds to a star's proper motion, and its other movement towards or away corresponds to another motion known as a star's 'line of sight' or 'radial motion.'

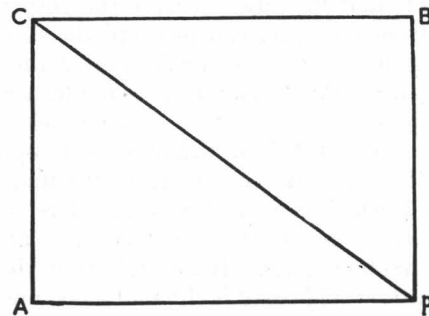

FIG. 104

In Fig. 104, suppose the car's movement  $CP$  brings it nearer by a distance  $CA$  equal to 30 feet in a second and a distance corresponding to  $AP$  athwart the line of sight equal to 40 feet in a second, the observer will be able to judge the latter distance only. So far as the distance  $CA$  is concerned he will know nothing, and he would feel disposed to say that the car was moving rather slowly at a speed of 40 feet a second, which is less than 27 miles an hour. But if he had any means for measuring the distance  $CA$  and found it to be 30 feet he would say that, in addition to the motion of the car with a speed of 40 feet a second or nearly 27 miles an hour in the direction  $CB$  or  $AP$ , it had another speed of 30 feet a second, or nearly 20 miles an hour towards him. If it is known how to,

combine these two speeds it will be discovered that the speed of the car was actually 50 feet a second or over 34 miles an hour in the direction *CP*. One does not need to find how the astronomer combines these two speeds to find the real speed; it is really quite a simple problem and probably many readers are conversant with the method. (See note 1, page 357.)

Returning to the people in the field we can imagine that any one of them corresponds to the headlights of a car, and that, although his actual motion is in the direction *CP*, an observer from afar would be aware of one motion only—that in a direction *AP*. He could not measure the other distance *CA* by ordinary methods, and indeed would not be aware of it unless the person walked for quite a long time in the same direction and showed which way he was going by change in apparent size.

It is remarkable that the observer is, in this respect, much worse off than the astronomer, who can measure the distance *CA* with greater accuracy and in a very much shorter time than he can measure the distance *AP*. In fact, he does not measure the distance *CA* at all, but does something better still—he measures the *speed* of the star in the direction *CA*, or it may be in the opposite direction *AC*, by means of the spectroscope.<sup>1</sup> Having found its speed—say 10 miles a second, which is a reasonable radial velocity—he knows that in a year this will be about 320 million miles and in five years it will be 1,600 million miles. If he finds that the star's proper motion in five years would carry it through 2,000 million miles then he can easily calculate that its real speed, or its 'space velocity,' as it is usually called, is nearly 2,560 million miles in five years or 512 million miles a year, which is  $16\frac{1}{2}$  miles a second. (See note above.)

There is no necessity to know the distance of the star to find its radial velocity. It makes no difference whether it is ten or a hundred light-years distant; the spectroscope works just as well for one as for the other, provided the star gives enough light for the purpose. On the other hand, it is necessary to know the distance of the star to find its 'transverse' velocity, that is, its velocity athwart the line of sight. To show how its transverse velocity—usually given in miles or kilometres a second—is determined, we shall use some simple examples, but readers must remember that the method is somewhat more difficult for celestial than it is for

<sup>1</sup> See pages 16-17.

terrestrial purposes. However, the *principle* is precisely the same, and as few readers will possess astronomical instruments which are capable of measuring accurately the small angles that astronomers measure, they must be content with understanding the *principle* involved.

It has been shown on pages 291-2 that the distance of an inaccessible object can be found when the angle that a base line subtends at it is determined, the length of this base line being known. The method is applicable only when the angle is small—and in measuring stellar distances this is always the case. Conversely, if the distance of an inaccessible object is known and the angle that it subtends at the eye of an observer is measured, its size can be easily calculated. As an example of the method take the case of an object 51,566 feet from an observer who measures the angle that it subtends at his eye (the assumption is made, as before, that the object lies athwart his line of sight) and finds it to be 400 seconds. Multiplying 51,566 by 400 and dividing by 206,265, the result is 100 feet, the length of the object.

Apply the principle to Barnard's star which has a large proper motion—10.3 seconds a year. The distance of this star is 6 light-years, corresponding to a parallax of 0.54 seconds of arc. Hence the transverse component of the star's annual movement is  $10.3/0.54$ , or approximately nineteen times the radius of the Earth's orbit round the Sun. This can be simplified if we want to find its transverse velocity in miles a second, and after a few transformations the following rule can always be used to find this transverse velocity.

Multiply the star's proper motion in seconds by 2.94 and divide by its parallax, and the result will give its transverse velocity in miles a second. In the above example this gives  $10.3 \times 2.94 / 0.54 = 56$  miles a second.

The method described has another important application in finding the distances between double stars and more especially between binaries. This subject will now be dealt with.

#### DOUBLE STARS AND BINARIES

The telescope shows that a considerable proportion of the stars which appear single to the naked eye are double, being made up of two stars close together in the sky. In a few cases it is possible

to see double stars which are widely spaced, without the assistance of the telescope, such as the companion to Mizar ( $\zeta$  of Fig. 103), known as Alcor. The Arabs referred to this pair as a test of vision—rather surprisingly because Alcor is easily seen with the naked eye by any one with normal sight. Two stars near Aldebaran,  $\theta^1$  and  $\theta^2$  Tauri, and also the bright stars  $\alpha^1$  and  $\alpha^2$  Capricorni, form close couples. A third pair,  $\epsilon^1$  and  $\epsilon^2$  Lyrae, are still closer together and really do form some test of acuteness of sight as they are less than one-third as far apart on the sky as are the two stars just referred to in the Plough. They form a remarkable system because the telescope shows each of the naked-eye stars to be itself double, the system being, therefore, a 'double double' or quadruple.

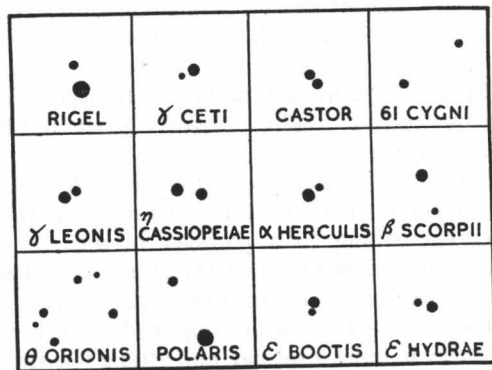

FIG. 105

Some double and multiple Stars. Telescopic views

In double star catalogues naked-eye pairs are not usually classified as doubles; the term is generally restricted to those visible as double only with telescopic assistance, and these are formed of components separated by a fraction of a second of arc up to less than a minute (60 seconds). A few well-known pairs are shown in their telescopic aspect, that is, inverted when an astronomical telescope is used to observe them, in Fig. 105.

There is often a considerable diversity in the colours of the components, and this is more marked when there is a difference in brightness between the two stars. In this case, however, it is very often a subjective physiological effect due to contrast.

The question which immediately suggests itself is whether there is any real connection between the two stars in such pairs, or whether they only appear to be close to each other through being nearly in the same line of vision from the Earth, but actually situated at greatly differing distances away. If two cyclists rode along a straight road at night, one some hundreds of yards behind the other, a pedestrian on the road in front of them might think they were riding abreast, or he might even mistake their lights for the sidelights of a motor-car. In the latter case, if they were the lights of a motor-car, there would be a physical connection between them, as one could not move independently of the other, and this is like double stars which are physically connected by their gravitational attraction. In the former case each cyclist rides independently of the other, and this is similar to two stars nearly in the same line of sight but separated by a great distance, perhaps many scores of light-years. Stars complying with these conditions are known as 'optical doubles' and are not so interesting to the astronomer as those physically connected, which are known as 'binaries.' By far the larger number of double stars are binaries and it has been estimated that, of all the stars brighter than the ninth magnitude, at least one in every eighteen appears as a visual binary.<sup>1</sup> These stars are known to be binaries for several reasons, one of which is that observations conducted over a period of time, the length of which depends on circumstances to be explained later, show that each of the components of the binary system is moving with reference to the other. To understand how one component moves with respect to the other, or to be more exact, how each moves round a point between them, a simple piece of apparatus will prove useful.

Fig. 106 shows two spheres, one weighing three times as much as the other, connected by a light rigid rod. To balance the system it is necessary to place a pivot  $P$  underneath the connecting rod at a point three times as far from the centre  $O'$  of the lighter sphere as it is from the centre  $O$  of the heavier sphere. For instance, if the distance between the centres of the spheres is 12 inches, the pivot should be placed 3 inches from the centre of the heavier sphere and 9 inches from the centre of the lighter one. If this is done it is possible to make the whole system of spheres and connecting rod revolve on the pivot, and the point on the rod around

<sup>1</sup> A visual binary is a pair that the telescope will separate.



which revolution takes place is known as the centre of gravity of the system. Almost the same thing occurs in the case of the components of a binary system.

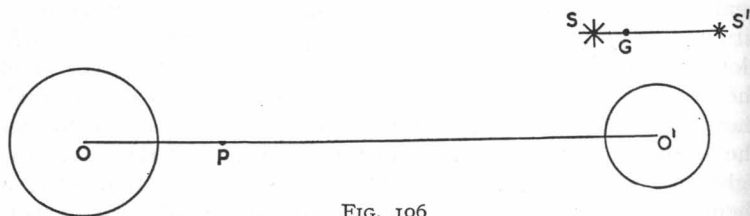

FIG. 106

Illustration of the motion of a binary system around its centre of gravity

In Chapter I it was shown that the Earth and the other planets revolve round the Sun and, while this is almost correct for all practical purposes, it is not absolutely true. If we take the case of the Sun and the Earth it is more correct to say that each body is revolving round the centre of gravity of the system. As the Sun weighs more than 330,000 times as much as the Earth it is obvious that the centre of gravity of the Earth-Sun system is close to the centre of the Sun. The same thing applies to many of the planets, though with the massive planets the centre of gravity of the Sun and planet is some distance from the centre of the Sun, and in the case of Jupiter lies outside the Sun, between it and the planet. If we fix our attention for the moment on the Earth-Sun system we can say with scientific accuracy that each body is revolving round the centre of gravity of the system of two bodies, and that this centre of gravity lies on the line joining the centres of the Earth and Sun, and at a point about 280 miles from the centre of the Sun.

In the case of stars known to be binaries there is never very much difference between the masses of the bodies. One may be two, three, or four times as massive as the other, but this is very small compared with 330,000, and hence the centre of gravity of many binaries lies outside and between both stars, just as it does in the case of the two spheres which were taken as an illustration.

How fast do the stars move in their revolution round their common centre of gravity? This depends upon certain conditions. First of all, it depends upon how far apart the two stars are; the closer they are the more rapid is their motion. Then it depends

on the masses of the stars; the more massive they are, the greater the speed of motion, other things being equal. If the stars are very far apart the astronomer must keep them under observation for many years before he can measure how much each one has moved, and in many cases astronomers of one generation find it necessary, for accurate work, to compare their results with those obtained by astronomers of a preceding generation. Sir William Herschel was the first to show, by visual observations, towards the end of the eighteenth century, that such binary motions existed.

Binaries are specially useful because they provide astronomers with all the necessary evidence to weigh them—determining their masses is the more correct term. Many readers may have thought it impossible to weigh the stars, but it is not so difficult as it seems, especially in the case of the binaries, and we shall now give an indication of how this is effected.

#### WEIGHING BINARY STARS

First of all, the distance of the system must be found, but this is not nowadays a serious difficulty, and those who have studied the previous pages should understand the methods employed for determining stellar distances. When the distance of the system has been found, the angle which the line joining the two stars subtends at the Earth (or the eye of the observer, which is the same thing) is then determined. As the stars revolve round their common centre of gravity this angle will vary in the course of time, and so it is measured at a number of intervals. Suppose Fig. 106 represents two stars  $S$  and  $S'$  revolving round  $G$ , their common centre of gravity, and to simplify the problem to the utmost, we shall take it that the plane in which the two bodies move is at right angles to the line drawn from the Earth to the system. To illustrate this in a simpler fashion, set up a piece of cardboard more or less circular in shape on a stand the height of your eye, and turn it flat towards you. Imagine one of the components of the binary is moving along the edge of the cardboard and the other component along another portion of the cardboard, on the other side of its centre but nearer that centre, and you have a representation of the motions of the stars composing the binary system. The cardboard should not be quite circular as this might prove misleading because few

binaries move in circular paths. They are generally oval-shaped or elliptical, as the orbit is described, and hence the stars will not always be at the same distance apart. This is shown by the variations in the angle which they subtend at the eye of the observer.

By measuring the angles between the two stars of a system the distance of which from the Earth is known, the distances between the stars can be calculated at various times. In addition, the time to complete a revolution can be determined because it is observed how much of the arc of the orbit is traversed in a given time, and from this the time required to complete the whole circuit is easily deduced. One important distance must be found from the observations—the mean distance between the stars—but this is done without difficulty. For instance, in the case of the Earth and Sun the mean distance is the average of the two distances of the Earth from the Sun on 4th January and 4th July, when it is at its least and greatest distances. Something similar can be calculated for the components of a binary system.

To show how the knowledge so far obtained can be used to weigh the stars in the system we shall first take an imaginary case.

If it was found that the mean distance between the two stars is 93 million miles and the time required to complete a revolution is one year, then, as these are the corresponding values for the Earth-Sun system, we can be certain that the total mass of both stars is the same as the total mass of the Earth and Sun—or, what is almost the same thing—as the mass of the Sun because that of the Earth can be neglected, being extremely small compared with the mass of the Sun. Notice that it is the *combined* mass of the two stars that is thus determined, not the mass of each star separately. This latter can, however, be found by careful observation, and to show how it is done let us revert to the model of two spheres attached to a rigid rod.

Suppose someone holds this model in his hand, while the two spheres are rotating round the pivot, and then carries it in a straight line across a room. When you observe it carefully it will be noticed that, while the pivot moves in a straight line, the same is not true of either sphere. In fact, if you could trace out the path of each sphere it will be found that, during the motion of the whole system, neither path would be straight nor circular, with reference to any object in the room. Each path would be curved

and one would differ from the other. If each sphere were exactly the same weight each curved path would be identical, but when their weights are different, and as a consequence the heavier one is moving round the pivot in a smaller circle than the lighter one, the curved paths with respect to some object in the neighbourhood differ. If one could trace out these curved paths one could tell how many times heavier one sphere is than the other.

The movement of the spheres as they are carried across the room represents the pair's proper motion, and the rotation round the pivot represents the revolution of each component of a binary round the common centre of gravity. The astronomer is able to determine the curved path across the sky of each component of a binary system after years of careful observation, and thus to deduce the ratio of their masses. If he finds that their combined mass is four times that of the Sun and that the curves traced out by each component show that one is three times as heavy as the other, then it is easy to deduce that the heavier one is three times the mass of the Sun and the lighter one has the same mass as the Sun.

This explanation has simplified matters to the utmost. The great majority of binaries are not so sufficiently obliging as to move in orbits whose planes are at right angles to the line from the Earth to the system; but when they move otherwise the astronomer can make allowance for the tilt of the plane. In addition, it is not to be expected that many systems comply with the conditions of a separation equal to that of Earth and Sun, and the possession of a period of revolution of a year. When the period is different and also the distance between the components differs from an astronomical unit (i.e. the distance between the Sun and the Earth), allowance can easily be made for these as the following examples will show.

Let us assume the mean distance between the components to be one astronomical unit but the period only six months. In this case the total mass of the system is four times the mass of the Sun. If the distance is 2 astronomical units and the period is a year, the mass is eight times that of the Sun. If the period is 3 months and the distance is one-half of an astronomical unit the total mass is twice that of the Sun. The calculations are very simple, but readers need not trouble themselves about the method for carrying them out. (See note 2, page 357.)

Calculations have been made for several hundred systems and their combined masses have been determined. It has been found that these masses range from values less than that of the Sun to about ten times that of the Sun, according to the type of stars. (See pages 329-30.) Fig. 107 shows the apparent orbit of the companion of Sirius around the latter star, the period being about 50 years.

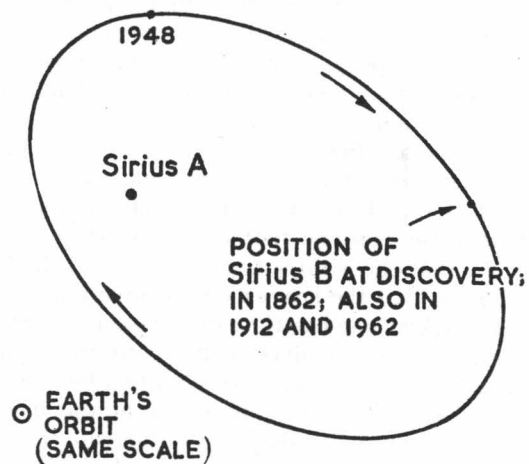

FIG. 107  
RELATIVE ORBIT OF SIRIUS B  
Period 50 years

Binaries are not the only kind of stellar system in existence; triple, quadruple, or even more complex systems, are also known and the companion stars are frequently of much smaller mass or luminosity than the principal star. The movements of three or more bodies round their common centre of gravity is a most complicated problem which mathematicians have never been fully able to solve, although it is known that many stars perform these movements. One interesting point in connection with the movements of the components of a binary system should be noticed. Although the smaller and fainter companion may be invisible even in large telescopes, nevertheless its presence is sometimes suspected from the irregular movements of the brighter star. This happened in the case of the faint companion to Sirius; it was suspected that it was

there because Sirius had a certain 'waviness' in its proper motion, which could be explained only on the theory that it had a companion and that both bodies were moving round the common centre of gravity of the system. Twenty years after Bessel, a famous German astronomer, had made this prediction, the companion was detected by Alvan G. Clark, an American telescope maker, while testing a large instrument on the star in 1862.

In recent times similar movements of two binary stars, 61 Cygni and 70 Ophiuchi, have led astronomers to the conclusion that they have each a third companion too faint or too small to be seen, but their masses have been deduced. From the calculations it appears that these companions are not really stars but very massive planetary bodies, about twenty times as massive as the giant planet Jupiter.<sup>1</sup> If planets much less massive attended these stars they would have so little influence on their motions that the effects could not be observed. There seems some justification for the view that some of the stars may have planets, just as our Sun has, but they are too small to be discovered by their influence on the motions of the stars round which they revolve, and as they do not shine by their own light, but by the small amount of the light received from the star, part of which they reflect, they cannot be seen even with the most powerful telescopes.

#### SPECTROSCOPIC BINARIES

In many cases the components of a binary system are so close together that the largest telescopes are unable to show them separately; they merely appear as a single star. Although the telescope fails to detect each star the spectroscope comes to the rescue of the astronomer and supplies him with sufficient information to enable him to calculate the masses of these systems, their times of revolution, and other interesting facts. It has been shown how the velocity of a star to or from the observer can be found by means of the spectroscope,<sup>2</sup> and this principle is used in finding how these binaries—known as 'spectroscopic binaries'—behave. It has been shown that in the case of an approaching star the lines of its spectrum are displaced towards the blue end of its spectrum and if the star is receding they are displaced towards the red end. When a

<sup>1</sup> See page 148.

<sup>2</sup> See page 302.



spectroscopic binary is observed with the spectroscope, one component may be approaching us and the other receding, and in this case there would be a duplication of the lines of the spectrum or a single set of lines oscillating to and fro, if the companion is too faint to show a spectrum. Plate XXVIII shows a photograph of the doubling of lines in the spectrum of the star  $\beta$  Aurigae. The components,

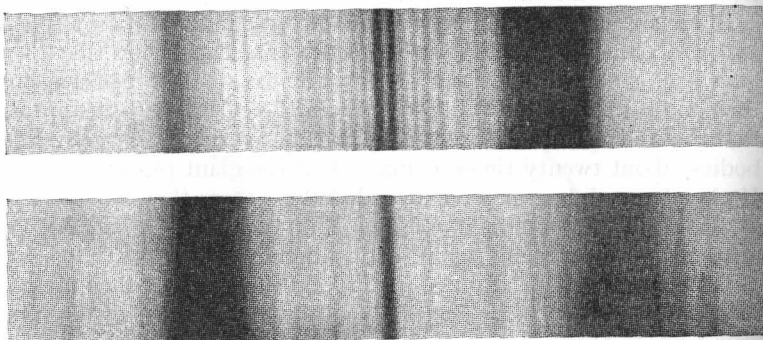

PLATE XXVIII

The spectrum of  $\beta$  Aurigae, showing the K line single and double.  
(From a photograph taken at Harvard.)

revolving round their common centre of gravity, are moving at regular intervals, one towards and one away from the Earth. This is because the plane in which they move passes nearly through the Earth. If this plane were broadside to the Earth, as illustrated by the cardboard model (see page 169), neither component would approach or recede from the Earth, each always remaining the same distance away.

## ECLIPSING BINARIES

When the planes of the orbits in which binaries move pass through or nearly through the Earth, each of the stars may partly or totally eclipse the other at regular intervals. Many such cases are known and one of the most interesting and easiest to observe is the star  $\beta$  Persei, known also by its Arabic name of Algol or the Demon. The Arabians probably called it by this name because there seemed

something almost diabolical about a star which could grow bright and then become faint in the course of a few days, pursuing such remarkable antics year after year without any apparent change in habit. Fig. 108 shows what happens in another star of the kind,

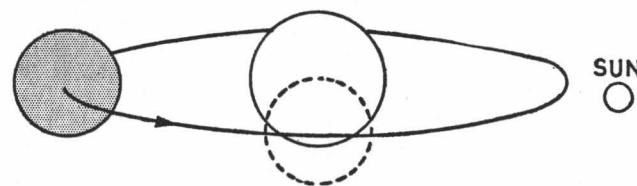
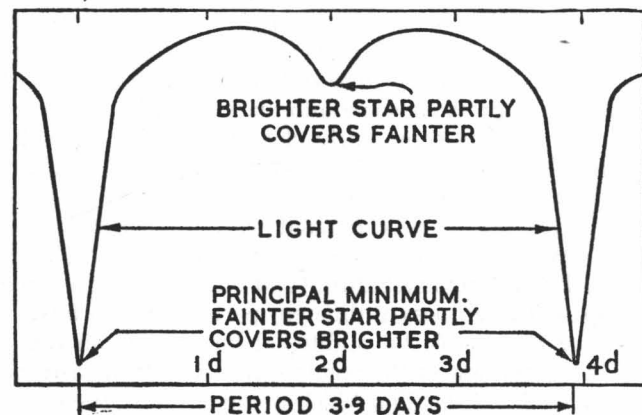

FIG. 108

ECLIPSING VARIABLE, PERIOD 3.9 DAYS  
Variation about one stellar magnitude

$\lambda$  Tauri. At the principal minimum the brighter star has almost passed behind the darker one, which thus cuts off most of its light from an observer on the Earth which is supposed to be above the diagram as you look down on it from above.

Astronomers do not rest contented with merely observing these 'eclipsing variables,' as they are called; they want to know something about them, their sizes, distances apart, densities, etc. It would be beyond our scope to go into details regarding the methods

adopted for finding these, but the following brief outline will show the main principles which are used in the investigations.

The duration of the eclipse depends partly on the speed with which one body is moving round the other, and this, as already shown (see page 306), depends on their distance apart and their combined mass. But this is not all; if the star lying between the Earth and the other star which moves behind it happens to be very large, we should expect the eclipse to last longer. Hence the duration of the eclipse provides some information on the sizes of stars. Again, when two stars come fairly close to each other, each produces great tides or bulges in the other, just as the Sun and Moon do in the case of the waters of the oceans, but in this case the bulges are extremely small compared with those caused by two close stars. When such bulges are produced the stars are flattened at their poles like Jupiter and Saturn,<sup>1</sup> and this may make a difference to their apparent brightness at different parts of their orbits. This latter may be responsible for additional fluctuations in the light-curve. These are a few of the points which supply the astronomer with very valuable information which would not have been so easily obtained if there were no eclipsing binaries. There is considerable variation in the periods of the eclipsing binaries; one, UX Ursae Majoris, has a period of only  $4\frac{3}{4}$  hours; Algol's period is just under 3 days; and the periods vary from these short intervals up to as much as 200 years in the case of a faint star in the southern sky.

The stars so far considered are variable only through the fact that they are doubles and that the planes of their orbits pass through or nearly through the Earth. If the latter condition were not fulfilled they would not appear to be variable, and the inhabitants of some planets belonging to other stars (assuming that there are such inhabitants) would be unable to see the variations in certain stars that we note, because the planes of their orbits would be inclined at a great angle to the line drawn from such planets to the binary systems.

#### OTHER TYPES OF VARIABLE STARS

There are thousands of other stars which are observed to be variables and which would also appear variables to the inhabitants of other planets, wherever they were situated. In the cases of

<sup>1</sup> See pages 150 and 175.

these stars the fluctuations in brightness are due to something inherent in the stars themselves and not to another star interposing between them and us. Out of about every thirty naked-eye stars one is known to vary in some way, some very slightly and others considerably. One class of stars, of which something more will be said later, seems to have a natural tendency to variation; this is the class of red giants, and the larger or redder the star the greater is the tendency to variation. Of the twenty thousand or more variable stars known at present, most have been discovered by photography, not by ordinary observations with the naked eye or with a telescope. They can be divided into three main classes: the Cepheids, the Long-period Variables, and the Irregular Variables, but a new class of very remarkable variable has been discovered within the past year or two. This is the red dwarf flare star (for red dwarf see page 329). Although only seven or so are known, they are so frequent among the faint red stars in the Sun's vicinity as to suggest strongly that they are really very common in space generally—in fact that they are perhaps the most numerous type of variable star, not yet known in great numbers because of their faintness. They exhibit very sudden outbursts of high temperature radiation, lasting only a matter of minutes, cooling quietly down to average conditions, the total energy radiated seeming to be about equivalent to that of some of the solar flares referred to earlier. The total output of radiation of these stars is small compared with that of a star like the Sun, and the outburst increases their smaller brightness very much more in proportion than does a solar flare in the case of the Sun. It certainly seems possible that all or most of the red dwarfs are thus affected.

#### CEPHEID VARIABLES

The Cepheids take their name from the naked-eye star,  $\delta$  Cephei, the first and best known of this type. Over 1,200 of this class have been catalogued, their periods of variation ranging from  $1\frac{3}{4}$  hours to 50 days. Some of these giant stars have been found outside our Galaxy in the extra-galactic nebulae (see page 349), and they have been a wonderful assistance to the astronomer in finding how far away these nebulae are. This is an extraordinarily interesting story and we shall deal more fully with it later. (See page 320.)

The light-curve of  $\delta$  Cephei is shown in Fig. 109, from which it will be seen that the increase in brightness, indicated by the steepness of the curve between days two and three, takes place in about one-third of the time that the decrease in brightness occurs. This latter is shown by the more sloping curve between days three and seven. This curve is typical for a period of light variation of several days, but for other periods the curve is not quite similar.

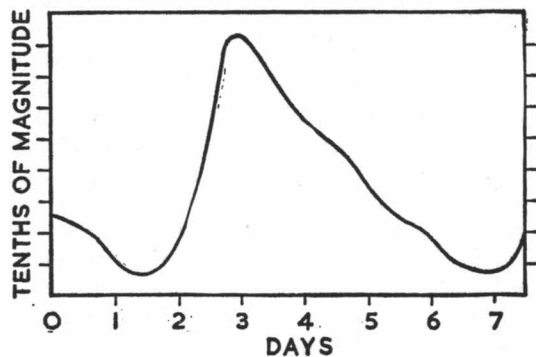

FIG. 109  
LIGHT-CURVE OF  $\delta$  CEPHEI  
Period 5.4 days

When these stars were first studied with the spectroscope it was believed that they consisted of binary systems because some of the results obtained were similar to those referred to earlier in the study of binaries. Later investigations showed that they could not be binaries, and various theories were advanced to explain their variations. The generally accepted theory now is that they expand and contract rhythmically, with an accompanying variation in brightness and temperature. Some varying internal forces in these stars are responsible for the fluctuations with the consequent changes in brightness.

#### THE USE OF CEPHEID VARIABLES IN ESTIMATING GREAT DISTANCES

The story of how astronomers have been able to use the Cepheid variables to find their distances and, of course, the distances of any

clusters or external galaxies in which they are situated may now be told.

In 1912 Miss Henrietta S. Leavitt, an astronomer at the Harvard College Observatory, was studying the photographs of the smaller Magellanic Cloud, a stellar system which is not visible in the British Isles but which is well seen with the naked eye in the southern hemisphere. She found that there were many Cepheid variables in this cloud and, of course, the photographs, taken at various times, showed the fluctuations in the brightness of the stars. She noticed that the brighter a star the longer it took to go through its changes in magnitude. This discovery was attended with most important consequences for the following reasons.

This Magellanic Cloud is so far away from the Earth that we may regard all the stars in it as at practically the same distance, in spite of the fact that the cloud is large. As an illustration, imagine someone is looking at a field in which there is a football match and that he is a good distance from the field—say a mile. He could see individual footballers at this distance, but if asked by someone how far away each player was he would probably reply that it was not worth the trouble to find out, but that the field was about a mile distant. He would not be concerned with the part of the field that was referred to as it would make little difference in comparison with a mile. The same thing applies to the smaller Magellanic Cloud, which is 82,000 light-years from the Earth and the diameter of which, excluding the outlying part, is about one-tenth of this. This would correspond on a reduced scale to a field 180 yards in diameter if seen from a distance of a mile, so if all the stars in the cloud were assumed to be practically at the same distance from us, the error would not be very serious.

Now suppose that someone in the field wants to make signals by night and that he has a number of globes, in different parts of the field, ranging in luminosity from 25 watts up to, say, 300 watts. An observer a mile away would notice very little difference in the luminosity of a 100-watt lamp, or any other lamp, whether it was placed on the side of the field nearest to him or on the other side, or in the centre of the field. Hence, although the various lamps would look very different in luminosities, the observer would know quite well that such differences could not be due to the different distances of the lamps. The differences would be due almost entirely to



something inherent in the lamps themselves—in other words, they consume different amounts of current. This first point must be understood before proceeding to the next point, which is equally important.

Imagine that the lamps are marked 300 watts, 100 watts, etc., for 200 volts, that the supply is at 200 volts, and also that each lamp is provided with a variable resistance so that the current can be decreased and increased at intervals. The manipulator of these resistances has decided to work on a fixed principle from which he never deviates, this principle being that the brighter the lamp the more slowly does he change the resistance. In these circumstances an observer at a distance would notice the following phenomenon which might puzzle him for a time until he discovered that it could be reduced to a very simple law. (It is, of course, assumed that the observer had previous knowledge of the luminosities of the various lamps.)

He would notice that the brightness of the lights fluctuated and that the stronger the light the more slowly did it perform its cycle of changes. Thus, the brightest light of all, that from the 300-watt globe, would decrease in its candle-power, and when it had reached its minimum brightness it would slowly increase again, attaining its original luminosity in, say, 2 minutes. This would continue repeatedly and the observer would know what to expect as the period from maximum to minimum and back again to maximum would always remain 2 minutes. In the case of the 100-watt globes he would notice that the cycle occupied only 1 minute, and the 75-watt globe required only 40 seconds, and so on, the period of fluctuation decreasing as the candle-power of the globe decreased. The manipulator of the apparatus would be merely imitating on a small scale what the Cepheids are continually doing. The greater the luminosity or candle-power of the Cepheid the longer is its period of fluctuation, and the smaller its luminosity or candle-power the shorter is its period. It may be pointed out that twice or three times the period does not imply twice or three times the candle-power; the law connecting the period and brightness, though well known, is not so simple as this.

The observer a mile away studies these lamps twinkling by night, and after a few nights he discovers the principle on which they are worked. He is so confident that the manipulator will adhere to his

schedule that if he times a number of lamps and finds that their period is 2 minutes he is certain that they are 300-watt lamps. If he times another lot and finds that their period is 40 seconds, he knows that they are 75-watt lamps, and so on. Up to the present this is the extent of his knowledge except that he also knows the lamps are a mile from his place of observation.

After some weeks a similar procedure is adopted in another field the distance of which is unknown to the observer. He does not know whether it is more than a mile away or less, and he has no means of measuring its distance. In fact, he is aware of its existence only by the varying lights each night, but he is determined to find out how far away it is, and so he adopts the following method.

He assumes that whoever is responsible for these nocturnal displays has a definite principle on which he works. Hence, by merely timing some of the lights he can tell something about the distance of the field. For example, he finds that a number of these lights have a period of exactly a minute, from which he concludes that they are 100-watt lamps because from his previous observations he found this was the period of these lamps. But at first he is puzzled when he notices that they do not look 100-watt lamps but more like 25-watt lamps. Then he discovers the reason for this. He is convinced that they are 100-watt lamps but that they are so far away that they *appear* only a quarter as luminous as the 100-watt lamps that he observed a mile away. Knowing that luminosity falls off inversely as the square of the distance of the luminous object, he feels confident that the field with its lamps must be 2 miles away from him. Since the square of 2 is 4, a lamp 2 miles distant would look only one-quarter as luminous as a lamp a mile off, and the observer congratulates himself on his important discovery. Of course, if he has the true scientific spirit he will not be content with deducing the distance of the field merely from observing the light-changes in the period of a minute. He will keep observation on the other lamps as well to confirm his discovery. For instance, he will watch the lamps of 2-minute period and determine their apparent brightness either by naked-eye observations or, if he does not trust these, by using some of the apparatus employed for comparing luminosities.<sup>1</sup> He will expect to find such lamps fulfilling the requirements if they are a mile away, that is, they

<sup>1</sup> See pages 399 ff.

should shine with the luminosity of 300-watt lamps. He finds that they appear merely as 75-watt lamps, thus confirming his previous deduction that they are 2 miles away because at this distance a 300-watt lamp would look as bright as a 75-watt lamp 1 mile away.

In this illustration each lamp can be taken to represent some particular luminosity of a Cepheid, its luminosity being determined from the period of light fluctuation. The lamps in the field a mile away will then represent a number of Cepheids twinkling out their message at a *known* distance and we need not repeat the methods by which astronomers find this distance. The lamps in the other field, the distance of which is unknown, represent Cepheids so far away that their distances cannot be found by the ordinary astronomical methods, but the new method is used which determines their distances from their known luminosity and their apparent luminosity at the place at which they are sending out their signals. A curve has been drawn showing the relation between the period of a Cepheid and its absolute magnitude (see page 290), the luminosity being deduced from the absolute magnitude by a simple computation.<sup>1</sup> One example will show how the distance of a faint Cepheid is determined.

The astronomer has photographed a number of Cepheids in the Great Nebula in Andromeda, which is one of the nearest extra-galactic nebulae. Photographs taken from time to time have been examined and have shown that these are Cepheids of relatively long period and therefore of great luminosity or candle-power. To illustrate their employment in estimating great distances, one of them, of 20 days period, may be used. (From study of the relation between period and luminosity it is known that such a Cepheid is nearly 1,000 times brighter than the Sun.) Now its brightness, measured by the size of its images on photographs of the nebula, is found to be only of the nineteenth magnitude. This is nearly twenty-two magnitudes less bright—or 630 million times as faint—as it would appear at the standard distance of 32.6 light-years.<sup>1</sup>

The astronomer knows that the feebleness of the light received from this far-away star is due to its distance, which may be found to be 25,000 times as great as the standard 32.6 light-years, for if 25,000 is squared, that is, multiplied by itself, the result is nearly 630 million. This method is in accordance with the falling off in luminosity with distance, as previously explained. The distance of

<sup>1</sup> See Appendix VI.

the Cepheid and of the Great Nebula in Andromeda to which it belongs, would be found from this example to be, therefore, about  $32.6 \times 25,000 = 815,000$  light-years. (See however, page 446.)

It will be seen that by observing the rate of variation of the Cepheids and also their apparent magnitudes, their distances can be computed, and hence a fair estimate can be made of the distances of extra-galactic nebulae in which Cepheids are discovered. The period-luminosity law for Cepheids is of the utmost importance to astronomers, enabling them to measure distances up to a million or more light-years.

#### LONG-PERIOD VARIABLES

The long-period variables, of which 1,300 are known, are diffuse giants, red-coloured, and with comparatively low temperatures. As with the Cepheids, the light-changes are probably due to some form of expansion and contraction, accompanied by changes in temperature and brightness of surfaces. Their periods, which are not quite regular, range from about a hundred to more than six hundred days, with a large proportion between two and four hundred days. The changes in their light from maximum to minimum average to over a hundredfold, but the range is very wide—from twentyfold to over a thousandfold. It is remarkable that, while there appears to be a rough relationship between their periods and their luminosities, this is opposite to that in the Cepheids, the longer periods being found with the less luminous stars.

Fig. III shows an average light-curve for Mira Ceti, the first and best known long-period star. Observations of the light-changes of this class of variables are carried out chiefly by amateur astronomers in all parts of the world, but the other two types referred to earlier, the eclipsing variables and the Cepheids, are observed by professionals with their more precise and special photometric equipment.

#### IRREGULAR VARIABLES

The irregular variables are also believed to be, for the most part, diffuse giant stars, some of which show a rough approximation to a definite period. For instance, the super-giant Betelgeuse appears to have a chief period of about  $5\frac{1}{2}$  years with an irregular period

mixed up with it. The interferometer<sup>1</sup> reveals changes in its diameter which correspond roughly with variations in its light. Most of this class of stars are, however, more irregular. There are, in addition, some stars not actually variable in themselves but

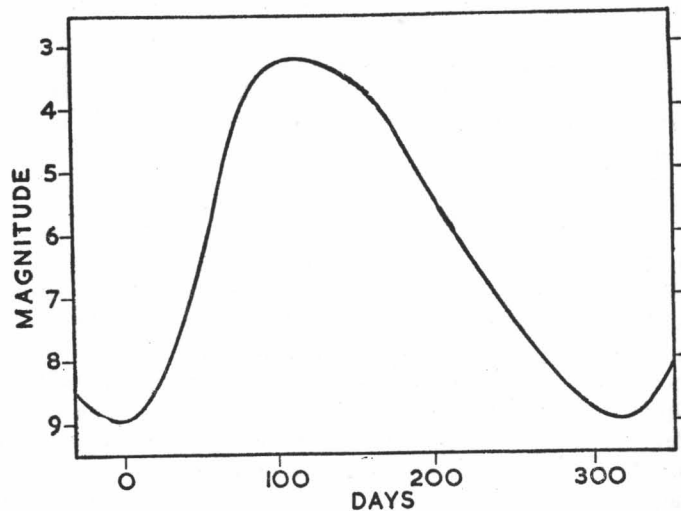

FIG. 110  
LIGHT-CURVE OF MIRA CETI

The period averages about 331 days. The maxima and minima are not always the same in this type.

which appear variable because some intervening clouds of gas and dust particles move from time to time between them and the solar system. When this occurs it is like a cloud of dust on a road which partly conceals our view of objects beyond it, but these interstellar clouds, although of enormous extent, have a much less dimming effect than the terrestrial clouds of dust.

#### NOVAE

New or temporary stars can be classified as the extreme case of a variable, and this group is the most spectacular of all stars which

<sup>1</sup> See pages 403-4.

change in their emission of light. They are not really new or 'novae,' to give them their usual title, because a star was there before a nova became conspicuous, though in many cases it was so faint that it had not been noticed. But their appearance is so dramatically sudden and the stars from which they have been developed are relatively so faint, that the name nova seemed appropriate at one time and has been retained.

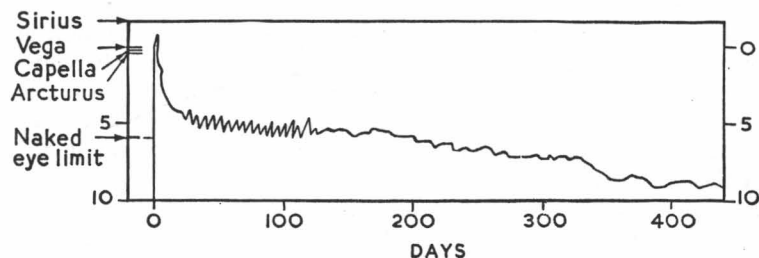

FIG. 111  
LIGHT-CURVE OF A NOVA

The positions on the magnitude scale of the four brightest stars visible in northern latitude are shown.

The phenomenon is not, therefore, the creation of a new star but an outburst of an explosive kind from one previously existing. The first bright nova of this century was discovered by an amateur astronomer, T. D. Anderson of Edinburgh, on February 22, 1901, and its rapid rise to brilliance is shown by the fact that on photographs of the part of the sky where it appeared, taken three nights previously, no star in the position of the nova could be found. Stars down to thirteenth magnitude were visible on the plates and at discovery the nova was brighter than a first magnitude star, and hence it must have increased in brightness a hundred thousand times in three days. (See page 333.) It diminished in brightness very rapidly and within 100 days it was just within the range of naked-eye visibility. In about a year it had sunk beneath this range and can be seen now only with the aid of a telescope. (See Fig. 111.)

There are two general classes of temporary stars. The much more frequent one is the ordinary nova whose luminosity averages about 50,000 times that of the Sun; the other—the supernova—has an average luminosity very much higher—about 100 million



times that of the Sun. Their great brightness renders them visible in the far-off depths of space, and taking their average luminosity as given above, it is then possible to determine their average distances. Although this method is not applicable with great accuracy to individual supernovae, nevertheless it can be used statistically in the same way as it is applied to find stellar distances (see page 294). This is one of several methods for determining the distances of supernovae.

In our own Milky Way system more than a score of novae are believed to appear annually, but the supernova is seen only once in several hundred years. The great temporary stars of 1054, 1572 (Tycho's), and 1604 were supernovae, and a number have been seen in extra-galactic universes, the first of these appearing in 1885 in the great Andromeda nebula.

Various theories have been advanced to account for novae, but it is now thought by many that they are due to the sudden development or release of sub-atomic energy causing a violent expansion of the star. It has also been suggested that the explosive outburst of a supernova may be the result of a nuclear chain reaction similar to what occurs in the case of an atomic bomb, but on an incomparably greater scale. Whether this is the real cause or not, the explosive expansion theory is well supported by the spectra of these bodies. The surface layers of a nova seem to swell outwards in all directions, and the light which reaches us comes from all parts of the disk which is thus formed by the partially transparent shell of gas. The portion of the shell nearest to us is expanding towards us, and that on the far side away from us, and those portions at the edge are neither moving towards nor from us, but athwart our line of sight. The observed spectra appear to correspond well to such movements.

Another recent theory of the origin of novae is that they are the result of disruption of a star which has collapsed owing to internal changes following the using up of its hydrogen.<sup>1</sup> Such a collapse would necessarily be followed by increased velocity of rotation (a rotating body which collapses must rotate more quickly), and by an ejection of matter from its surface, which would produce spectroscopic phenomena similar to those of expanding shells of material.

The observation of intermittent action on the part of some novae

<sup>1</sup> See page 22.

has led to the suggestion that all novae may be recurrent outbursts in the life of a star at intervals which may extend in extreme cases into thousands of years.

#### COLOURS AND TEMPERATURES OF THE STARS

Up to the present nothing has been said about the physical conditions existing in the stars and no indication has been given regarding the differences in the luminosities of the various types of stars, if they were viewed at the same distance. We have seen that if the Sun and Aldebaran were observed at the same distance the Sun would look very faint in comparison with Aldebaran, and the same thing applies to thousands of other stars. Why do some stars look much brighter than others, irrespective of their distances, and why do some look red, others yellow, others blue, and so on? A full explanation of this subject would fill many pages, and readers must be content with a brief outline; they should also remember that there is still a very great amount of uncertainty about the origin, development, internal physical conditions, etc., of the stars.

The colour of a star depends on its surface temperature, and from the colours of different stars it is possible to obtain some idea of their temperatures. There is nothing surprising in this. A blacksmith could do the same with a piece of iron which he is heating. As its temperature is raised its colour passes from a dull red to red, then to yellow, and finally to white, and an experienced blacksmith could make a good guess at the relative temperatures of the iron from its colours. The astronomer can do even better; when he uses the spectroscope there is very little guessing on his part, and from a study of the spectra of stars he can give a very close estimate of their temperatures. In all cases, when the spectra of two or more stars are similar he knows that their temperatures are also similar, and the nature of the spectra has nothing to do with the distances of the stars. For instance, the white stars Vega and Sirius show similar spectra and hence they are nearly at the same temperature. It makes no difference that Vega is about three times as far away as Sirius, and the fact that Sirius normally looks brighter than Vega has no effect on its observed colour. Readers could arrive at the same conclusion without the astronomer's equipment; careful observation of Vega and Sirius shows that they are the same colour,

though the eye cannot judge the fine distinctions in colour that the astronomer's apparatus is capable of doing. Each of the stars just mentioned has a surface temperature of about  $11,000^{\circ}\text{C}$ . Two much cooler stars are Aldebaran and Antares, each a red colour, as any one can see by looking at them, and their temperatures are nearly but not quite the same, that of Aldebaran being about  $3,500^{\circ}\text{C}$ . and that of Antares  $400^{\circ}$  less.

We have seen that stars are classified according to their magnitudes, the higher the magnitude (arithmetically) the fainter the star, but this is only one way of classifying them, and while invaluable for the astronomer for many purposes, it tells us nothing about the temperatures or physical conditions existing on the stars. There is another method for classifying the stars which is quite independent of their magnitudes, and in this method letters are used instead of numbers.

#### CLASSIFICATION OF STARS

According to their temperatures and colours, stars are divided into the classes O, B, A, F, G, K, M, R, N, S. Stars of class O are bluish and very hot, with temperatures in some cases as high as  $50,000^{\circ}\text{C}$ ., though they are often much less than this. Next there are the bluish-white B stars with temperatures of  $20,000^{\circ}$ , and then the A stars, like Vega and Sirius, with temperatures in the neighbourhood of  $10,000^{\circ}\text{C}$ . After them come the F stars which are yellowish-white, the temperatures of which are about  $7,000^{\circ}\text{C}$ .; the well-known star Procyon belongs to this class. Class G is interesting because our Sun belongs to it. It has been shown<sup>1</sup> that the surface temperature of the Sun is about  $6,000^{\circ}\text{C}$ ., and this can be taken as near the temperature of the G class of stars. One bright star, Capella, belongs to this class, and you will easily recognize its colour as a pale yellow which is characteristic of this class. In class K, the orange stars, the temperatures are about  $4,000^{\circ}\text{C}$ ., and two well-known stars, Arcturus and Aldebaran are included in this class. The last class that will be considered is the M class in which the stars are coloured orange and red, and have temperatures of about  $3,000^{\circ}\text{C}$ . To this class belong Betelgeuse and Antares. These seven classes are all that we need consider; the other three

<sup>1</sup> See page 25.

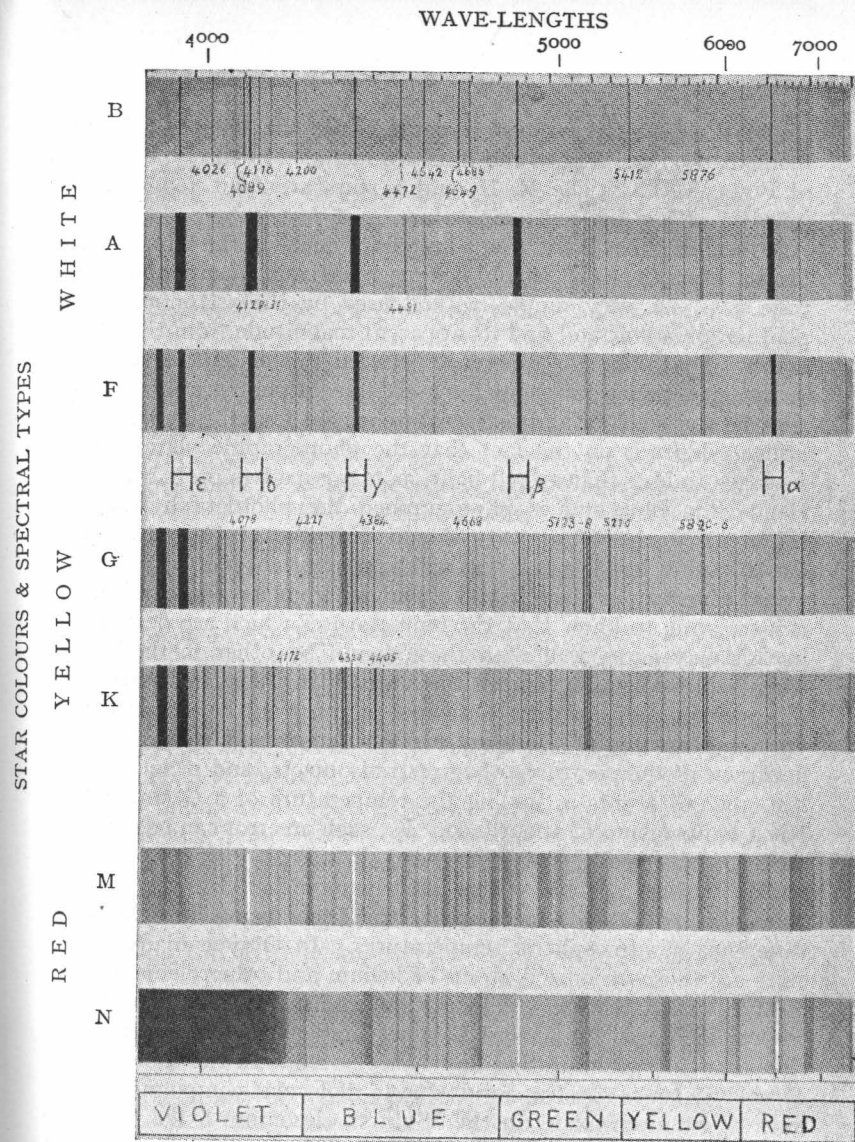

PLATE XXIX  
SPECTRAL TYPES

The numbers along the top indicate wave-lengths in Angstrom units (each equal to a ten-millionth of a millimetre). The letters H $\alpha$ , H $\beta$ , H $\gamma$ , H $\delta$ , H $\epsilon$  below the F-type spectrum are due to hydrogen. The extents of the spectral band colours are approximately as shown at the bottom.

(From *Journal of the British Astronomical Association*, drawn by P. M. Rykes, F.R.A.S.)

classes are not of very great importance for our purpose. In fact, more than 99 per cent of the stars are included in the types B to N of Plate XXIX. The R, N, and S stars are faint red variables (mostly) of low surface temperature.

Several methods have been adopted for deriving the temperatures of the stars, one of which has been already mentioned. (See page 325.) A very simple method used by the astronomer is to photograph a star and find its apparent magnitude from the photograph. By taking the difference between this magnitude and that determined visually without the assistance of photographic apparatus, the star's colour and temperature can be found. The principle utilized depends on the fact that the photographic plate is more sensitive to blue than to red light, as many readers probably know. Hence if a blue star is photographed the photograph will look brighter than the star appears when its brightness is judged visually. On the other hand, a red star will appear brighter if judged from visual observation than it will if judged from its photograph. It is interesting to know that the temperatures which are determined in this way agree well with those found by other methods, and when tables of stellar temperatures are given they can be accepted as approximately correct. Of course, it must not be expected that the temperatures of the stars can be determined with the same accuracy as temperatures of terrestrial objects, and if an error of, say,  $100^{\circ}$  C. occurs in finding the temperature of a G star, which has a temperature of about  $6,000^{\circ}$  K., such an error can be regarded as relatively small.

The various spectral types are distinguished by the relative strengths of the lines in their spectra, these being due chiefly to difference in atmospheric temperatures. In O type many of the lines are those of ionized atoms of helium and other elements. In B and A stars there is less ionization, and in these stars hydrogen is prominent, and in F and G types lines of un-ionized (neutral) atoms of calcium and other metals are noted. In the cooler M, R, N, and S classes spectra, bands due to molecular compounds occur, such as titanium oxide (in the M stars), zirconium oxide (in the S type), carbon compounds (in the R and N types), with lines of neutral atoms very strong.

The temperatures of stars do not depend on their sizes; in many cases stars which differ very greatly in size have the same tempera-

ture, and some very interesting points connected with the red stars will now be dealt with.

#### SIZES, MASSES, AND DENSITIES OF STARS

In 1905 Hertzsprung, a Danish astronomer, made a very important discovery. From studies based on measurements of stellar brightness and distance, he found that the redder stars could be divided into two classes, one of great luminosity and the other relatively faint. The two classes had practically the same spectra and therefore, presumably, the same temperature. (See pages 325-6.) Now if two similar bodies have the same temperature and they are exactly the same size we should expect them to look about the same brightness if viewed at the same distance. If one is farther away than the other, then, knowing their distances, we can make allowance for the greater brightness of the nearer one. This was, of course, done for the red stars; their distances were known, and when allowances had been made for these it was obvious that some of them had luminosities, or candle-powers, thousands of times those of others. There was only one conclusion—that these stars with such great luminosities must be thousands of times as large as those that had small luminosities. To have made any other assumption would have implied that a red object *A* can be thousands of times as luminous as another red object *B* of the same size and with the same temperature—an assumption that physicists would not be prepared to entertain. The conclusion then is that there are two kinds of red stars, some smaller than the Sun in size and the others extremely large. The former are known as the red dwarfs and the latter as the red giants. (See Appendix XIII.)

Now if one body is thousands of times as large as another we might expect it to be thousands of times as heavy, but this is not necessarily so. For instance, if two spheres are seen a few yards away, both painted the same colour and apparently the same in every respect, any one might be disposed to estimate their weights as the same or almost the same. If you approached and picked one up in each hand you might then discover your mistake; one sphere might be made of lead and the other of wood, so their weights would differ considerably. The wooden sphere might be made very much larger than the sphere of lead and yet their weights might not



differ very much. But if their relative weights were judged by the amount of light that each, painted the same colour, reflected towards the eye, you would be badly in error because you would think that the larger and brighter one would be the heavier of the two, whereas it might really be the lighter.

It is noteworthy that, while there is an enormous range in the candle-power or luminosities of stars, there is not a corresponding range in their masses. In fact, by far the greater majority of stars have masses lying between one-tenth and ten times the mass of the Sun, though there are a few exceptional cases where masses of a hundred or more times that of the Sun occur, but these are very few. When one reads about giant stars, therefore, it has to be remembered that the word applies to their sizes—that is, to their diameters or volumes, and not to their masses. It should be mentioned that Russell, a famous American astronomer, not only confirmed the conclusions of Hertzsprung, but showed that the division into dwarfs and giants extended to stars of other colours than red, though not to such a great extent. The following figures will show that the red stars are the most conspicuous for this division.

The diameters of most frequent occurrences range, on the average, in the case of giants, from roughly 80 times the Sun's diameter, in the orange M type, to about 8 or 10 times that diameter in the yellow F or G types, and to 6 or 7 for the bluish-white B stars. In the white A dwarf type the average figures are  $2\frac{1}{2}$  times the Sun's diameter; in the yellow G dwarf type the diameter is equal to the Sun's diameter, and in the red M dwarf type it is less than half the Sun's diameter.

It is scarcely necessary to point out that a star with a diameter 10 times that of another has 1,000 times its volume, as the volume of a sphere varies as the cube of its diameter, and the cube of 10 is 1,000; and so for other diameters. Hence, although a star with a diameter 80 times that of the Sun may not appear to be a 'giant,' nevertheless when we remember that this implies a volume 512,000 times that of the Sun, we feel that the star is really worthy of the title bestowed on it.

If some stars are so very large and yet do not weigh very much more than the Sun (perhaps 10 or 20 times as much) they must be composed of very light material. We might compare some of them to a child's balloon, the Sun being a sphere of dense wood and

much smaller than the balloon, say like a large pellet. In fact, in the case of some of the M types of stars, if an average specimen of the material composing it could be taken and formed into a sphere, and then compared with a rubber balloon of the same size filled with water, the latter would weigh a hundred thousand times as much as the material of the star. This is expressed in scientific language by saying that the average density of the star is a hundred thousandth that of water. The densities of the giant stars vary very much and the description of some of them as 'great gas bubbles' is very appropriate. Betelgeuse, already referred to (page 321), is so large that if we placed our Sun at its centre and the planet Mars as far from the Sun as it is now, the planet would be inside the outer atmosphere of Betelgeuse. Its diameter is 420 times that of the Sun or about 363 million miles, but this varies considerably, as the star contracts and expands, its least diameter being only about 210 times that of the Sun. It is worth remembering that although the spectral types of certain giant and dwarf stars are the same, the temperatures of the former are somewhat lower than those of the latter for identical spectral types. The figures given on page 326 refer to giants in the K and M types, and the dwarfs of these types are some hundreds of degrees higher in temperature.

#### ENERGY RADIATED BY SUN AND STARS

It was shown<sup>1</sup> that the Sun is always pouring out an enormous amount of energy, a minute fraction of which is caught by the Earth and stored up in various ways, in coal, peat, wood, etc., to be utilized a long time afterwards for the purposes of mankind. All the stars are pouring out energy in a similar way, but it must not be imagined that all the energy thus liberated appears in the form of visible light and heat. There are the invisible radiations of heat at the red end of the spectrum and the invisible ultra-violet radiations at the other end. In the hotter stars the greater proportion of the energy emitted lies within the range of visibility, but in the cooler stars the major portion of the radiant energy consists of heat radiation with wave-length greater than that of visible light. Astronomers can use the spectroscope to find out how much of the energy radiated by stars belongs to different parts of the

<sup>1</sup> See page 23.

spectrum, and the calculations made on the basis of certain laws of radiation are easily performed. It will be seen from this that it would be incorrect to judge of the output of energy of a star merely from its appearance; certain computations must be made to allow for the invisible radiation, and then it is possible to say what the emission of energy is in so many millions of horse-power. Of course, it is assumed that the distance of the star has been found first of all to determine its absolute magnitude (see page 290), which indicates its luminosity or candle-power. After finding the total output of energy the diameter of a star can then be found as follows.

As readers will readily see, the total outpouring of energy from a star depends on two things: (1) its temperature; (2) its size. For instance, if two iron spheres are heated in a fire to different temperatures, then, assuming that the spheres are of the same size, the hotter one will emit more energy than the cooler one. But if one sphere has ten times the surface of the other, then, although its temperature may be lower, it can emit a greater amount of energy than the hotter sphere. The same thing applies to the stars. A red giant may be very much cooler than a smaller star of a different spectral type, but nevertheless it may emit far more energy than the smaller star. Perhaps it might be thought that if one star is twice as hot as another it will emit twice as much energy, the stars being the same size, but this is incorrect; it actually emits sixteen times as much. This is obtained by raising 2 to the fourth power, in other words, by working the simple problem  $2 \times 2 \times 2 \times 2 = 16$ . Similarly, a star that has three times the temperature of another emits  $3 \times 3 \times 3 \times 3 = 81$  times as much energy, and so on. Hence, when the surface temperature of a star has been deduced from the evidence of the spectroscope, the astronomer can find out how much energy it emits. (Absolute temperatures are used in the above computations.)

Although the output of energy of a star can be thus computed from its temperature it must be remembered that this output *refers to any selected amount of area of its surface*: a square inch, a square foot, or any other convenient unit. The temperature does not supply the astronomer with the output of energy *from the whole surface*; this depends on the total area of the surface. Hence we arrive at the following summary of the method.

Knowing a star's distance and apparent brightness its absolute

magnitude can be found, and from this its total output of energy. Knowing its temperature, its output of energy per square foot (or any other unit adopted) can also be found, and obviously if we divide the total output of energy by the output per square foot, we obtain the number of square feet on the surface of the star. From this the diameter of the star is easily found.

One illustration will suffice to show the application of the method. From this it will be seen that the area of the Sun's surface and its luminosity are taken as the units—not square feet or candle-power.

The surface temperature of Sirius is known to be about  $11,200^\circ \text{K}$ ., which may be taken as approximately 1.9 times the temperature of the Sun, so Sirius emits  $1.9 \times 1.9 \times 1.9 \times 1.9 = 13$  times as much energy per square foot as the Sun does. Its absolute magnitude, computed from its distance of about 9 light-years,<sup>1</sup> is 1.3, and that of the Sun, computed in the same way, is 4.8, the difference being 3.5. From this difference in the absolute magnitude it is easily found that the luminosity or candle-power of Sirius is about 25 times that of the Sun.<sup>1</sup> Dividing 25 by 13 we find that the surface area of Sirius, emitting radiation 25 times that emitted by the surface area of the Sun, is 1.9 times that of the Sun. This shows that the diameter of Sirius is about 1.4 times the Sun's diameter, because the surfaces of spheres vary as the squares of their diameters and  $1.4$  squared is about 1.9. The same method can be applied to various other stars, and it is remarkable that the majority of stars are found to be smaller and also cooler and fainter than the Sun. When we use the word 'fainter' it will, of course, be understood that the selected stars and the Sun are supposed to be viewed at the same distance. On the other hand, there are many stars (but they are in the minority) which are very much more luminous than the Sun. The brightest known star is S Doradus, which has a luminosity equal to 300,000 suns like ours! This star is not visible in the northern hemisphere and is so far away that it looks a faint star. At the other end are the stars with extremely small luminosity, like Wolf 359, a red star which emits about one fifty-thousandth of the light emitted by the Sun! As pointed out above, although there are these enormous ranges in the luminosities of stars, and also very large ranges in their sizes, the range in masses is comparatively small.

<sup>1</sup> See Appendix VII.

## CONDITIONS IN THE INTERIORS OF STARS

By means of the spectroscope astronomers have obtained a direct knowledge of the chemical composition, temperatures, pressures, etc., at the stars' outer regions. But information for the interior of a star cannot be gained directly. It is the result of calculations based on the laws of gravitation, radiation, and properties of gases. Since there must be very high temperatures in the interiors of the stars, the atoms, as a result, are all moving about at very high speeds. The consequence is that they are mostly stripped by collisions of the electrons which normally circulate round their nuclei.<sup>1</sup> The interior then behaves as a perfectly gaseous medium, the average weight of all the particles, nuclei, and free electrons being much less than the atomic weights of all but the hydrogen atom.

The chief element in the stars is certainly hydrogen, helium coming next, and up till recently it was believed that hydrogen constituted between 30 and 40 per cent of the mass of a star. Within recent times, however, reasons have been advanced which suggest that hydrogen may be present in stars to the extent of 99 per cent or even more. It has been calculated for the densities and pressures which must exist in stellar interiors, that temperatures require to be very high, at the centre millions of degrees, becoming lower as the surfaces are approached, down to the figures mentioned earlier. (See page 326.)

The densities and pressures at various points in the interiors can also be estimated, allowing for the fact that radiation itself exerts pressure. Although this is insensible at ordinary temperatures, it becomes very great indeed inside a star, and has been estimated to be about  $2\frac{1}{2}$  million tons per square inch at the Sun's centre, where the temperature is calculated to be some 20 million degrees.

The densities of the stars must increase very rapidly towards their centres. In the Sun, the average density<sup>2</sup> of which is 1.4, the value at the centre is probably nearly a hundred. Certain stars have been discovered with average densities thousands of times as high, such fantastic figures being possible because of the stripped condition of the atoms, already mentioned, a condition which, of course, allows a very much closer packing. These abnormally dense

<sup>1</sup> See page 21.

<sup>2</sup> The density of water is taken as the unit.

stars are referred to as the white dwarfs (to distinguish them from the ordinary red dwarfs), and more than 100 of them are now known. Being faint and not readily discoverable in space, they are very probably really quite numerous. The first to be discovered was the companion to Sirius. (See page 311.)

## ORIGIN OF RADIATION ENERGY

In the chapter on the Sun the question of the origin of its radiation was discussed, and it was shown that this was very probably the energy set free by a process of transformation of hydrogen into helium by what is known as the carbon-nitrogen cycle. This process is believed to be responsible for the radiation of many stars like the Sun where the central temperature is about 20 million degrees. But for red giant type stars (see page 329) several other atomic nuclear reactions, suitable for the lower temperatures of these stars, have been suggested. Simply expressed, these reactions are as follows: the Deuterium Reaction, the Lithium Reaction, the Beryllium Reaction, and the Boron Reaction. In each of these the process would take place between a nucleus of the atom of the element mentioned and a proton, i.e. a hydrogen nucleus. The temperatures involved range from about half a million to 15 million degrees.

Very recently it has been suggested that a process known as the proton-proton reaction may be of even more importance than the carbon-nitrogen cycle, at from 10 to 15 million degrees central temperatures, in dwarf stars. In this process the first stage is the combination of two protons to form a 'heavy' hydrogen atom nucleus. By capture of another proton a nucleus of a 'light' helium atom (atomic weight 3) results, and then two of these combine to form a nucleus of helium (atomic weight 4) and two protons. Release of energy occurs during the process here described, as in the carbon cycle.

Although it must be admitted that there is as yet no satisfactory theory of the evolutionary course of the life of a star, it may be said that the origin is quite probably from clouds of dust such as are seen in the dark obscuring patches in the sky (see page 343), through condensations caused by gravitational attraction, helped by the pressure of intense radiation from pre-existing surrounding



stars the first of which must have originated by gravitational attraction only. The temperature of such a condensation will increase, and when it reaches about half a million degrees at its centre the Deuterium Reaction sets in, followed by the other types of reaction appropriate to higher temperatures. When the Boron Reaction has consumed all the boron present, the carbon-nitrogen cycle operates, and after an increase in temperature and luminosity, and when all the hydrogen has been transformed into helium, the star contracts under gravity in a catastrophic manner, a nova, and later a dense white dwarf resulting. (See above.)

Although the hypothesis of the evolutionary course of the stars, briefly outlined above, receives a certain amount of confirmation from laboratory experiments, it cannot be too strongly impressed that it is not universally accepted and that there is no really satisfactory theory so far.

Variable stars of long period (see page 321) may occur when stars are between the Deuterium and Lithium Reactions, and the Cepheids (see page 315) may appear between the Beryllium and Boron processes. In each case a phase of unstable light might be expected while the star was becoming adjusted to the higher temperature reaction.

#### ORIGIN OF BINARIES

Several suggestions have been made as to the formation of binary or multiple systems of stars. The chief of these are: the 'capture' theory, the division of a single star by fission into two, and condensation round two or more centres in a parent dust cloud. In the first of these a pair is supposed to have been formed by the chance meeting of two stars, but there is more than one difficulty in the way of acceptance of the idea. The most important of these difficulties is that, owing to the enormous distances separating the stars, the number of pairs formed in this way should be much smaller than what is seen. The fission theory has been thought to be particularly suitable for the close binary systems discovered by the spectroscope. (See page 311.) In the third method—concentrations in the material—there is the difficulty of explaining how the revolution about the common centres of gravity of the bodies has come about.

There is thus, as with the evolution of the stars in general, no satisfactory theory for the origin of binaries. Perhaps some theory of a catastrophic nature may be found to satisfy the requirements. If it is true that a star finally collapses into a dense state (see page 336) there may be fission, with a resulting binary system. Such a theory would almost seem to be necessary to explain the Sirius system, which is composed of a normal star and a white dwarf.

#### GALACTIC CLUSTERS AND GLOBULAR CLUSTERS

In or near the Milky Way zone more than 300 clusters of stars are found, ranging in apparent size and brightness from the Pleiades cluster, well known to every one, even if only a naked-eye observer, to small faint groups made up of a few stars which are visible through the telescope. The distances of these known clusters vary from 500 light-years or less (for the Pleiades) to about 10,000 light-years, and their diameters range between 5 and 25 light-years. Although the stars in these clusters are much closer together than are the stars in the neighbourhood of the Sun, yet the average spacing is very much greater than the interplanetary distances in our solar system. Plate XXX is a photograph of a fine galactic cluster in the constellation of Auriga, the light from which takes about 2,700 years to reach us. The diameter of this cluster is about 20 light-years.

An examination of the photograph might lead some readers to imagine that the sizes of the stars can be inferred from their sizes in the photograph, but this view is incorrect. These photographic images, when magnified, may be seen to be clusters of silver grains, each of which is very much larger than the actual stellar disks would appear if they could be recorded accurately on a photographic plate.

Galactic clusters may be regarded as local concentrations among the stars of the Milky Way zone, but there is another class of clusters which are found scattered over the sky except in the Milky Way region. They are not distributed uniformly but are strongly concentrated towards that half of the sky which contains the brightest star clouds in the constellation of Sagittarius. They are known as the Globular Clusters.

A globular cluster contains many more stars than a galactic



PLATE XXX

*I. Roberts.*

## GALACTIC CLUSTER

Distance about 2,700 light-years.

cluster and is also larger. Plate XXXI shows one of these clusters just visible to the naked eye as a hazy spot in the constellation of Hercules. It contains more than 50,000 stars and its diameter is 160 light-years, from which it is inferred that the stars in it are, on the average, several times as densely spaced as are the stars in the neighbourhood of the Sun. Near its centre the density is many times greater, but the average separation is probably even then much greater than interplanetary distances in our solar system.

*Mt. Wilson Obs. (60-inch)*

PLATE XXXI

## GLOBULAR CLUSTER. MESSIER 13

The short line in the centre represents the distance between the Sun and  $\alpha$  Centauri.

It is now known that the globular clusters are equally distributed on each side of the Milky Way stratum of stars, thus forming an enormous flattened spheroidal group more than 150,000 light-years in diameter and 120,000 light-years deep. The centre of the group is not near the Sun but is in the direction of Sagittarius, about 33,000 light-years from us, and this fact gives them the appearance of being concentrated in this direction. If one stands towards the edge of and inside a large circular plantation of trees which are arranged symmetrically around the centre of the circle and looks towards this centre, it will be imagined that the trees are more concentrated in that direction than they are directly behind. Although few globular clusters are found within 5,000 light-years from the Milky Way stratum, there is evidence that some may be concealed behind certain light-absorbing clouds. (See page 343.) The distances of the globular clusters vary from several thousand to more than 100,000 light-years, and the brighter among them present a wonderful sight when viewed through a telescope of some power.

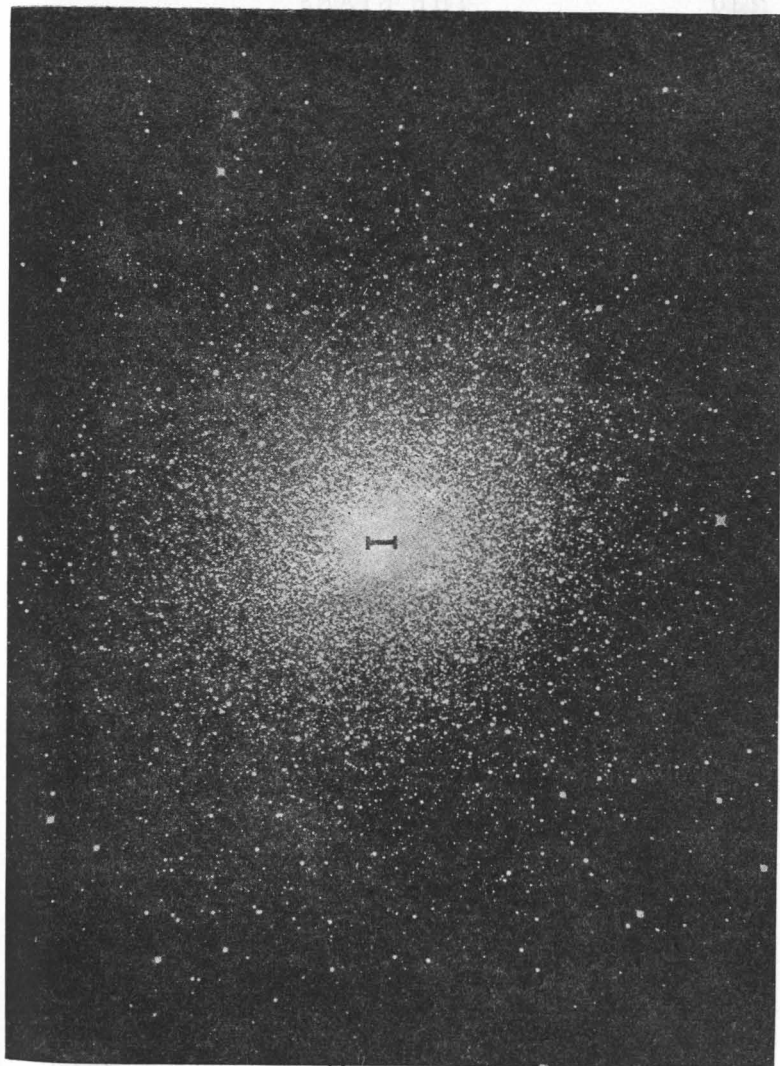
#### GASEOUS NEBULAE

In our Galaxy there are many objects termed nebulae which look like hazy clouds of light, sometimes of great extent but frequently so small that they look like faint hazy stars. Some are visible to the naked eye, but the majority are so small and faint that they can be studied effectively only by photography.

Amongst the galactic nebulae are included the planetary nebulae, of which some 340 are known. They appear as round or oval disks of faint nebulosity, resembling feebly lit planetary disks in a small telescope, and hence their name. There is often a faint central star and a considerable amount of detail on photographs. (See Plate XXXII.) The central stars are very faint and more so visually than photographically because they are very hot and bluish in colour, the blue end of the spectrum affecting photographic plates more than the red end. The distances of the known planetary nebulae vary between 1,500 and 50,000 light-years, the majority being from 3,000 to 30,000 light-years away from us, and their diameters are of the order of a light-year.

The spectroscope shows that many of these objects are rotating, and from the speed of rotation and the dimensions of the nebulae it



*Mt. Wilson Obs.*

#### PLATE XXXII

#### PLANETARY NEBULA IN CAMELOPARDUS

is possible to calculate their masses. These have been found to be small—only a few times that of the Sun—and hence, with diameters one-third of a light-year their density must be very small. It has been calculated that it cannot be much greater in most cases than that of a cubic inch of ordinary air expanded to fill a cubic mile!

Their luminosity is believed to be produced by a process akin to fluorescence, the high-temperature ultra-violet radiation of the central star being absorbed by the atoms of the gaseous nebulosity, and then re-emitted in longer wave-lengths which can be seen or photographed.



The Diffuse Nebulae are more common than the planetary type. They are irregular in shape and are found in forms ranging from small wisps, which can be detected only by long-exposure photographs, to extended objects like that in Orion. (See Plate XXXIII.)



*Mt. Wilson Obs.*

PLATE XXXIII  
THE NEBULA IN ORION. MESSIER 42

Some of them have spectra which suggest that their particles receive light from nearby stars, which they then reflect, similar to the reflection of the light of the Sun by the planets. In other cases where the associated stars are found to be of the O and B type with high temperatures the spectra reveal, not reflected light, but glowing gas as in the Great Nebula in Orion. The manner in which these

very hot stars act on the dust and gases in nebulae and cause them to glow has been explained on the atomic theory of protons and electrons, but its discussion is outside the scope of this book. It may be accepted, however, that ultra-violet radiation in sufficient quantity is one essential, and this is supplied by the O and B type stars, and in addition, the density and pressure in the nebulae must be extremely low, a condition which is frequently fulfilled.

It has not been found possible to make accurate direct measurements of the distances of these objects, but the distances of stars or clusters of stars connected with them can be measured, and in some cases the distances and dimensions of the diffuse nebulae have thus been ascertained. These show great remoteness and large extent; thus, the Great Nebula in Orion, a comparatively near object of this class, is nearly 1,000 light-years away and its brightest part is about 15 light-years in diameter.

#### DARK NEBULAE

The Dark Nebulae which show as dark streaks, spots, and patches on photographs were once thought to be vacancies in the sky where no stars existed, but are now known to be immense clouds of dust which prevent us from seeing most of the stars beyond them. When stars are seen apparently on these dark nebulae they are generally between us and the dust clouds. A well-known dark nebula is that object known as the Coal Sack near the Southern Cross (not visible in our northern latitudes). The absorption of the light by these objects is thought to be mainly due to the dust in the clouds of dust and gases scattered through space, as a comparatively thin layer of dust has a considerable effect in rendering the environment opaque. There are many small objects of this kind (see Plate XXXIV) as well as long lanes and broader patches (see Plate XXXV), and their dimensions range from a fraction of a light-year to hundreds of light-years. Just as comets are held together by the gravitational attraction of the whole mass, so these clouds of gases and dust are held together in the same way.

As it is impossible to determine their distances by the ordinary methods, indirect means are employed. One of the most useful of these is to count the number of stars of different magnitudes in these obscured regions and also in the surrounding unobscured

\* M

regions. The approximate distance of stars of a particular magnitude in an unobscured region being known, the distance of the cloud causing the deficiency in the observed stars can then be estimated. In this way the Coal Sack has been found to be 300 light-years away, while the long system of dark clouds producing

*Lick*

PLATE XXXIV  
DARK NEBULA IN SAGITTARIUS

the division in the Milky Way from Cygnus to Centaurus is probably more than 1,000 light-years and the clouds in Taurus 500 light-years from us. (See Plate XXXV.)

#### INTERSTELLAR LIGHT ABSORPTION

Apart from these clouds there is evidence of a general scattering and absorption of light in space, by both gas and dust. One effect is to modify estimates of distances of stars or star clusters which are based on known luminosities of certain types of stars, such as

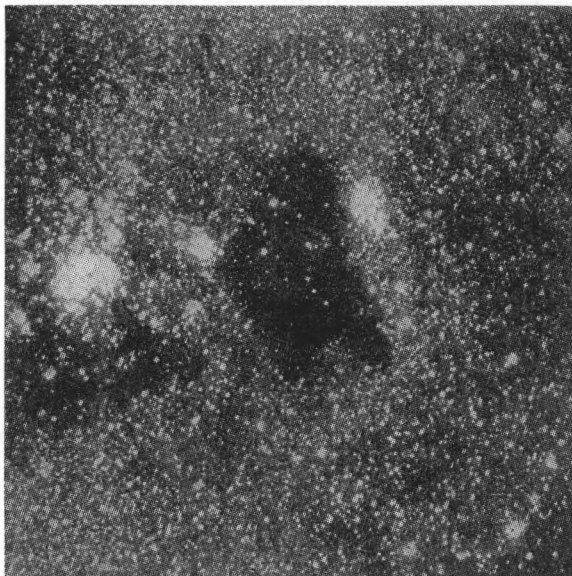
*Barnard*

PLATE XXXV  
EXTENSIVE DARK NEBULAE IN TAURUS

the Cepheids. A star of known luminosity seen through a light-absorbing material will obviously appear less bright than it should do, and if estimates of its distance are made on the assumption that there is no loss of light, such estimates will place the star too far away. By various methods the proportion of light that is lost has been calculated and it is found that beyond about a thousand light-years the correction usually becomes serious, and that with an

apparent distance ten times as great as that it may become as great as 40 per cent or even more. These remarks apply to objects situated in the Milky Way stratum (to which, apparently, the absorbing medium is mainly confined) or in its general direction.

Photographic studies of the colours of stars of the B type, and other types bright enough to study at great distances, show that they appear redder than stars of the same type that are nearer to us. This is due to the absorbing action of the dust clouds and is similar to the reddening of the Sun seen through a hazy or dusty atmosphere.

In addition to the dust clouds it is known that interstellar space contains many atoms and molecules of gas which have little dimming effect, although their aggregate mass is probably even greater than that of the dust particles.

#### FORM AND SIZE OF OUR GALAXY

The form of the Milky Way system has been referred to earlier as a stratum, although at first consideration of the subject it might seem that a ring of stars, with the Sun in its relatively vacant centre, might explain the appearance of the zone encircling the sky. But all methods of investigation lead to the same conclusion—that we are in a stratum or flattened disk, shaped like a thin watch, extending much farther in the galactic plane than perpendicularly to it. The intense concentration towards this plane of the stars generally and of other objects such as diffuse and planetary nebulae, novae, and other highly luminous stars, also statistical studies based on the numbers of stars between different limits of brightness, all point to this as the correct shape of our stellar system. Fig. 112 (page 349) shows in an over-simplified way what are the generally accepted ideas.

By a number of considerations, the centre of the disk is shown to lie in the direction of the constellation Sagittarius. The greatest richness of the star clouds (see Plate XXXVI), the globular clusters' preference (as mentioned on page 340), and the high frequency in that direction of several kinds of stars of high luminosity that can be seen at great distance, such as novae and long-period variables, all support this conclusion. The Sun is considered to be situated two-thirds of the semi-diameter, or about 33,000 light-years from



*Barnard*

PLATE XXXVI  
STAR CLOUDS IN SAGITTARIUS

this centre, and the centre of the globular clusters as a system surrounding the disk has been determined to be at the same distance from us. The simple circular outline and the definite edges of the figure are certainly not exact representations of reality, and many astronomers think that the Galaxy will be found to be a spiral like



one of the systems described elsewhere (page 350), but the ascertainment of the true shape is a task for the future.

We may therefore summarize present ideas on the subject by stating that the main structure of the Galaxy is generally believed to be of a flattened disk or biscuit, about 100,000 light-years in diameter and 20,000 light-years in maximum thickness at its centre, tapering towards the rim.

The true distribution of stars within this galactic disk is still uncertain. Our lack of knowledge on this important subject is due less to inadequate instrumental equipment than to the interference of the layer of dust and gas lying along the galactic plane. The absorptive effect is of little importance for short distances, but for very great remoteness is so large that even the most luminous stars cannot be seen or photographed with our largest telescopes.

#### ROTATION OF THE GALAXY

As might have been expected, the flattened form of the system has suggested to many that it is in rotation in its own plane. Conjectures have been made as a consequence of the disk shape and also in connection with the motion of the solar system (see page 297), which was at one time surmised (wrongly) by some to be an orbital motion round a centre.

If a rotation exists which is mainly controlled by a concentration of mass at the centre, the speeds of the stars revolving round this centre get less with increased distance from it, similar to what is found in the solar system where, nearly all the mass being in the Sun, the orbital motion of the planets is faster for those nearer to it. The closer a body is to a centre of attraction like the Sun, the faster it must move to maintain its distance, so to speak, against the increased attraction.

Evidence for or against rotation may be sought in the very small changes of position occurring slowly among the stars and in the differences of velocities in the line of sight connecting the star and the observer. If the stellar system rotates more or less as one body so that the stars, apart from smaller motions among themselves, keep on the average the same positions relative to each other, there will be no possibility of discovering rotation of the system by means of changes of relative position or differences in line of sight

movements. It is clear that there are then no observable changes inside the system from which rotation can be detected. To use a simple illustration: if a number of people were attached to the spokes of a large rotating wheel at various distances from its axis, there would be no change of apparent position to be seen among themselves which would indicate rotation. But if the rotational velocities decreased from the centre outwards, like what is observed in the planets of the solar system, then from cross motions and the line of sight movements rotation could be discovered and its speed be ascertained.

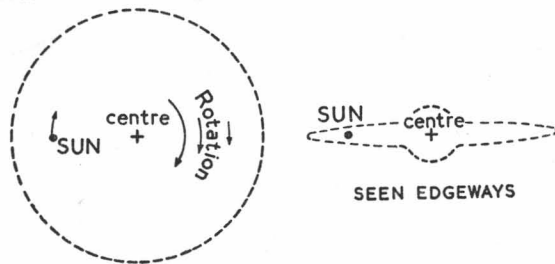

FIG. 112

#### SIMPLIFIED DIAGRAM OF SHAPE OF GALAXY

One of the most remarkable of the astronomical discoveries of the twentieth century has been a demonstration by these methods of a galactic rotation of this description. The motions of certain types of very distant stars and of planetary nebulae, have been studied by special investigation and results obtained which show that the Galaxy is rotating in its plane with great velocity, the speeds of the stars decreasing from the centre outwards (see Fig. 112), the centre being that towards Sagittarius indicated by the distribution of stars and other objects as already referred to. In the Sun's vicinity the velocity of the stars is about 150 miles per second with a period of 200 million years, which requires a controlling mass of the order of 200,000 million times the Sun's mass, which is believed to be about the total mass of the galactic system.

#### EXTERNAL GALAXIES

Earlier in this chapter mention has been made of the Andromeda nebula which is referred to as one of the nearest 'extra-galactic

nebulae,' a method of ascertaining its distance being described. (See page 320.) For many years a number of such stellar systems have been known, and they have been believed to be probably distinct from, and really similar to, our Galaxy. Among these may be mentioned the two Magellanic Clouds, the beautiful spiral in the Hunting Dogs, the first noted visually (by Lord Rosse) to be of that shape (see Plate XXXVII for a similar one), the spiral in the constellation of the Triangle, and other well-known telescopic objects, but all requiring large apertures to be well seen.

When, however, photographs are taken with the largest telescopes hundreds of thousands of small nebulous images, distinct from those of faint stars, are found, more numerous in the sky areas away from the Milky Way zone where their presence is hidden by the dust and gas clouds belonging to our system. (See page 343.) The work of the past twenty or so years has definitely established that these nebulous images represent stellar systems outside our own Galaxy and situated at enormous distances.

Sky surveys have been, and are still being, undertaken with the object of ascertaining the details of distribution in space of these external systems. The surveys are being made in such a way as to result in a gradual advance into the depths of space as larger and more powerful types of instruments are brought to bear. And, simultaneously, the structure of the larger specimens has been studied by means of photographs taken with the giant telescopes now to be found in all civilized countries.

Before describing the results of these surveys and detailed researches, the methods by which the distances and dimensions and the nature of these objects have been determined will be briefly dealt with.

#### DETERMINATION OF DISTANCES AND SIZES

The first indication that the distances would prove to be very great was derived from the observed occurrence of novae (see page 324) in some of the largest systems. This showed, from the known luminosities of novae in our own system, that the nearer systems are probably several hundred times as far away as the average nova in our own Galaxy, itself a very distant kind of star. Then followed the detection of types of highly luminous non-variable

stars and, later, Cepheid variables, in several of the nearer systems, thus providing a means of more accurate distance determination. These highly luminous stars (brighter than the most luminous Cepheid) were detected in a few apparently more remote objects, and from their known luminosity, about that of an average nova, distances greater than that determinable by the use of Cepheids, of several million light-years, were reached. The next step outwards in space was achieved by studies of the brightness of the individual members in clusters of these systems, such being systems which were apparently physically connected. Some of these aggregations had one or two objects in them containing highly luminous stars, and this provided the distances of the clusters and hence the average luminosity of their members; this was found to be equal to about 100 million Suns, being about the same from one cluster to another. Using this figure for the average object, distances of clusters, evidently as far away as a 100 million light-years, could be estimated. The astonishing result followed that the faintest small nebulous image on a plate taken by the 100-inch Mount Wilson reflector, if it is that of an average object of the kind, must be a picture of a system something like 500 million light-years away—a figure that has been doubled by the 200-inch Palomar giant!

It must be noted, however, that the distance of any very remote galaxy, too distant to show individual Cepheids, highly luminous stars or novae, cannot be separately determined with any accuracy by these methods. There is a considerable range in luminosity among individual galaxies, and therefore the assumption of an average luminosity of 100 million Suns renders a distance estimate for a particular galaxy liable to a considerable error, as there is no way of telling whether it is a small, normal, or large specimen.

The real size of the individual external galaxy can, of course, be estimated once its distance is known, as is the case for the comparatively nearby systems or for the members of clusters. It is found that the diameters range from about 2,500 light-years to as much as 100,000 light-years. But the majority appear to be close to a medium size of about 10,000 to 20,000 light-years. Our own Galaxy seems to be a giant one (see page 348), and the Andromeda nebula is of the same order of magnitude, especially when a surrounding outlying 'haze' of stars, photographed with long exposures,

is taken into account; its dimensions are then found to be about 60,000 light-years by 54,000 light-years. Along with the two Magellanic Clouds, which are small systems of an irregular type structure, it is the only 'external universe' visible to the naked eye; it is discernible as a hazy spot, passing overhead in November evenings in our latitude.

#### THE DIFFERENT TYPES OF EXTERNAL GALAXIES

Several classification schemes have been published. The one due to the American astronomer, E. Hubble, which is the best known, will be briefly described.

It is made up of three broad types—elliptical, spiral, and spiral with a bar crossing the central brighter nucleus and its surrounding disk of nebulous light. It may be indicated by a diagram of Y-shape. The bottom stem of the letter represents the elliptical series beginning at the bottom with those of circular outline and passing upwards through increasingly flattened elliptical shapes. One of the Y's branches is the spiral type (see Plate XXXVII); it contains a sequence, beginning with the more tightly coiled spirals, and continues with those having gradually opening out arms as in the ordinary spirals. The ellipticals are known as the E type—E<sub>0</sub> to E<sub>7</sub> as their outline becomes more flattened; the spirals are Sa, Sb, Sc, in loose structure progression; and the barred spirals, SBa, SBb, and Sbc, similarly. The E type are really ellipsoids or flattened spheres except the E<sub>0</sub>, which may be spherical or ellipsoids with their planes at right angles to the line of vision. They are actually that shape and not torpedo or cigar shape, which would be gravitationally unstable. It is not yet certain in the case of the spirals as to whether their rotation is causing them to close up or open out their arms, although it is more likely that they are closing up with the convex side of their arms on the direction of rotation. There is also a much less frequent type, the irregular, of which the Magellanic Clouds are the nearest specimens. Round the edges of the Sb and Sc types, a band of dark obscuring matter (dust and gas) is most clearly seen when the spiral is edge-on to us, or nearly so. (See Plate XXXVIII.) Judging by the numbers in the brightest thousand or so, the most frequent type is the spirals, normal ones being commoner than barred, the elliptical being a bad second, while the irregulars are scarce.



Mt. Wilson

PLATE XXXVIII

EDGE-ON SPIRAL. Sa CLASS  
Distance about 8,000,000 light-years

Mt. Wilson

PLATE XXXVII

SPIRAL. Sc CLASS  
Distance about 1,500,000 light-years



## EVOLUTION AND CONSTITUTION

It may be noted that Hubble's classification is not meant to mark an order of evolution, which seems just as likely to be from spirals to ellipticals as from ellipticals to spirals. On photographs taken with the largest reflectors there are indications that these galaxies are composed of stars and nebulosity, bright and dark, much as in our own Galaxy; and it appears likely that if instrumental means were adequate most if not all objects of the kind would be shown to be composed of such constituents. Their spectra seem to be compounded of the spectra of various types of stars and (to a small extent) of luminous nebulae. In general the spectra resemble that of the Sun or of somewhat lower temperature stars; but the spiral type are known to have in them stars of higher temperatures, this same type of Galaxy showing in some cases bright lines, no doubt due to gaseous nebulae. Our Galaxy's type is Sb or Sc and it (the Milky Way) shows a G- or F-type spectrum.

## CLUSTERS OF GALAXIES

The surveys mentioned in an earlier paragraph have shown the existence of many clusters of galaxies; the distribution on the sky is markedly non-uniform. Galaxies occur singly and in clustering aggregations numbering up to thousands of members. But when a large volume of space is considered this clustering gets smoothed out with an approach to a large-scale uniformity, although there is evidence of great groupings among even the faintest objects. As has been earlier remarked, there is a great range in apparent size and brightness among the individual galaxies, from the Magellanic Clouds and the Andromeda giant down to multitudes of small specks on the photographs taken with large reflectors or Schmidt cameras. In fact the Andromeda nebula is actually more than 10 million times as bright to us as one of these specks!

For some of the better known clusters, the constellations they are in and their estimated distances are as follows:

<i>Cluster</i>	<i>Distance, millions of light-years</i>	<i>Cluster</i>	<i>Distance, millions of light-years</i>
Virgo	7	Coma	45
Pegasus	24	Urs. Maj.	85
Hydra	24	Leo	117
Cancer	29	Corona Borealis	130
Perseus	34	Boötes	240

These clusters contain hundreds and even thousands of galaxies and their overall diameters are millions of light-years—a size which means that the distance of each member galaxy from its nearest neighbour is of the order of hundreds of thousands of light-years.

There appears to be a local group of galaxies of smaller dimensions, roughly 1,500,000 light-years' diameter. In it there are so far known to be about sixteen members. Of these our own Galaxy, the Andromeda nebula, the larger Magellanic Cloud, the spiral in the Triangle, and the smaller Magellanic Cloud are the largest. The others range down to several of the smallest class about 2,000 light-years in diameter.

Something may be said here of the number of these external galaxies and of their individual masses. As to the numbers, it appears certain that there are hundreds of millions accessible to the Palomar 200-inch. And the spectroscopic measurements of the internal rotations of some of the nearer ones indicate that the masses are of the order of hundreds of millions of times the Sun's and, in the larger, thousands of millions that unit.

## THE RED SHIFTS

There is a peculiar phenomenon noted in the spectra of the external galaxies. It has been found that the positions of lines in their spectra are shifted towards the red, i.e. shifts which might be taken to be an indication of motion away from us. (See page 311.) It was noted by Hubble that, knowing distances of galaxies by the methods above described, these shifts, assuming them to be the result of movement from us, increased uniformly by about 100 miles per second of velocity for each added million light-years of distance. In any case they could be, and were, used as criteria of distance or as checks on distances otherwise estimated.

At present there is no known physical cause for such a red-shift but receding motion, and most authorities consider that the real explanation is such a motion, indicating a general expansion whereby every galaxy, wherever situated, is increasing in distance from all the others. But some think that there may be another explanation which will, of course, involve some hitherto unknown process. For instance, a 'gravitational drag' and a slowing up of light as it passes matter in space, or a loss of energy through collisions between light

'photons,' both of which would be equivalent to a reduction in frequency of the light-vibrations, i.e. to reddening. Some are of the opinion that the observational researches so far seem to favour the idea of no motion, but most appear to hold the contrary view. It is interesting to learn that there is some reason to expect that the results of the work on the external galaxies with the new 200-inch at Mount Palomar may settle the question one way or the other.

## RADIO ASTRONOMY

Recent developments of a new and highly promising method of research must be described, although with brevity in a book of this sort. This has been given the name Radio Astronomy, dealing, as it does, with the detection and measurement of radio waves arriving from space. The existence of such radiation was first thought of by Sir Oliver Lodge nearly sixty years ago, but his efforts to detect it between 1897 and 1900 did not meet with any success. More than a quarter of a century later, however, an American physicist, Jansky, using a large paraboloid metallic reflector, secured evidence of the existence of radiation from outer space. At first he thought it was from the Sun (which has been found to radiate waves of the kind from sunspot areas at times of great solar activity), but he later demonstrated it to be coming from directions towards the zone of the Milky Way in the sky. Nothing further was done for some time until another American, Reber, using improved apparatus and a shorter wave-length (less than 2 metres), got much better results, which indicated a maximum from the centre of the Milky Way in the constellation Sagittarius and other maxima at different points in the galactic belt of the sky. Additional improvements gave more detail in researches made at Cambridge (England), at an experimental establishment of the Manchester University in Cheshire, and in Australia.

A development of the research work proved that the strongest sources of the radiation were of small angular diameter in the sky—probably less than a tenth of the Moon's diameter. The discovery of more than a hundred of such sources, distributed not only in the Milky Way regions but in other parts of the sky, has led to the idea that there may be a kind of 'radio star' which exists in great numbers in the Galaxy, the comparative smallness of the number

so far detected being due to the present limits in power of the radio equipment; and it is thought that, with sufficiently powerful means of detection, they would perhaps be found to be as numerous as the ordinary visible stars.

The nature of these sources is still unknown, but two ideas are that they may be stars of very low ordinary luminosity but possessed of peculiar powers of radio-wave emission, or that they are perhaps 'young' stars not yet hot enough to be emitting the very short-wave radiation by which they could be seen or photographed. And just recently it has been found that similar radiations are coming from the brighter and nearer galaxies (see pages 349-50), such as the one in Andromeda about 750,000 light-years away and several others three or four times as distant.

The potentialities of this radio astronomy appear to be immense, and it may quite possibly revolutionize the science in fundamental ways.

*Note 1 (page 302).* If  $u$  and  $v$  denote the speeds in the directions  $CB$  and  $CA$ , respectively, the velocity  $V$  in the direction  $CP$  is equal to  $\sqrt{(u^2+v^2)}$ . The same formula applies to the space velocity which, in millions of miles, is  $\sqrt{(1600^2+2000^2)}=2560$  millions of miles in 5 years.

*Note 2 (page 309).* If  $a$  denote the mean distance of the components expressed in astronomical units,  $P$  the period in sidereal years, and  $M$  the combined mass of the bodies, the Sun's mass being the unit, then  $M=a^3/P^2$ . If  $a$  is  $\frac{1}{2}$  and  $P$  is 3 months, that is,  $\frac{1}{4}$  year,  $M=(\frac{1}{2})^3/(\frac{1}{4})^2=2$ .

## BIBLIOGRAPHY

- R. G. Aitken: *The Binary Stars*, McGraw-Hill, New York, 1935.  
 E. Hubble: *The Realm of the Nebulae*, Oxford University Press, 1936.  
 L. Campbell and J. Jacchia: *The Story of the Variable Stars*, Harvard Books on Astronomy, Blakiston, 1941.  
 L. Goldberg and L. H. Aller, *Atoms, Stars, and Nebulae*, Harvard Books on Astronomy, Blakiston, 1943.  
 B. J. Bok and P. F. Bok: *The Milky Way*, Harvard Books on Astronomy, Churchill, 1946.  
 H. Shapley: *Galaxies*, Harvard Books on Astronomy, Churchill, 1947.  
 P. Doig: *An Outline of Stellar Astronomy*, Hutchinson, 1947.  
 G. J. Whitrow: *The Structure of the Universe*, Hutchinson, 1949.  
 W. H. McCrea: *Physics of the Sun and Stars*, Hutchinson, 1950.  
 W. M. Smart: *Some Famous Stars*, Longmans, 1950.  
 M. C. Johnson: *Astronomy of Stellar Energy and Decay*, Faber & Faber, 1950.  
 Otto Struve: *Stellar Evolution*, Oxford University Press, 1950.  
 M. Davidson: *From Atoms to Stars*, Hutchinson, third edition, 1952.  
 A. C. B. Lovell and J. A. Clegg: *Radio Astronomy*, Chapman & Hall Ltd., 1952.

## LIGHT AND INSTRUMENTS

E. G. MARTIN, F.R.A.S.

*Senior Experimental Officer, Royal Observatory, Greenwich*

## I. LIGHT

**A**STRONOMY is the study of the heavenly bodies and these are all at distances so great that up to the present time it has not been possible for man to transport himself to any of them. In consequence man has, until very recently, been limited in his study of these bodies to one of his senses, the sense of sight, and this sense is actuated by light. Therefore, as most of our knowledge of the objects in the sky is derived from the light they send us, it is very necessary to know something of the properties of light and the visible consequences of these properties. The reader will be asked to concern himself about the practical uses of light as a means to obtain knowledge of distant objects, not to attempt to understand the nature of light. Scientists have several theories of the nature of light but none is completely satisfactory, and just as we use electricity to operate mechanisms for our benefit without completely understanding its nature, so we may learn how light can be used to divulge knowledge of the stars without a satisfactory theory of its nature.

## MEDIA

When light strikes a substance such as glass, most of the light passes through and we say that glass is a transparent medium. If light strikes water, some of it passes through, but not so much as would pass through glass, so that water is a transparent medium also, but is not so transparent as glass. Substances which allow no

light (or almost no light) to pass are said to be opaque substances. Thus iron, wood, or coal are termed opaque media. There are, however, substances which are neither transparent nor opaque media, which allow some light to pass through them. Examples of such materials are wax, ground glass, and thin china, and these substances are stated to be translucent media.

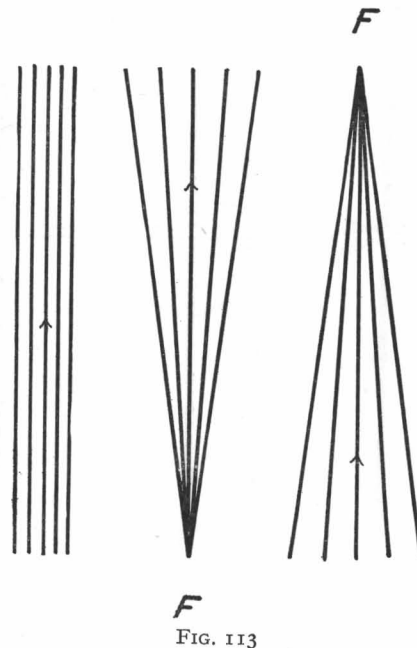

FIG. 113

## BEAMS AND PENCILS

Just as in geometry it is necessary to state what is meant by a line or a point, so we now need a definition of certain light terms. A beam is a bundle of light-rays and the beam may be parallel, divergent, or convergent as shown in Fig. 113. The central ray of the bundle is called the axis of the beam. If the beam diverges it does so from a point called the focus, but if the beam converges, it converges towards a focus. If a beam consists of a very small bundle of rays the term pencil of rays is preferable.



## STRAIGHT-LINE TRAVEL

Rays of light travel in straight lines provided they remain in a medium which is of the same density throughout. Fig. 114 illustrates one of the ways of testing this. If, however, the rays of light pass obliquely into another medium either less or more dense, then a refraction or bending takes place. For example, light may pass from air into water, or from oil into water, or even from air

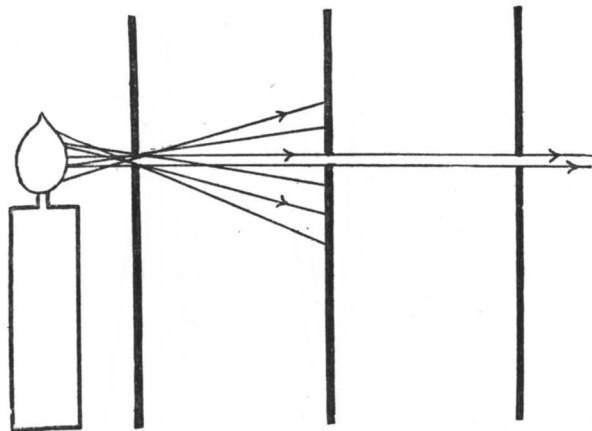

FIG. 114

which is rarefied into air which is very dense. The spoon in a cup of transparent tea is a good example of the refraction of light. If a dark box is constructed with a pinhole instead of a lens, an image of a candle, lamp, or sunlit landscape will be formed at the back of this camera box, where it can be seen on a screen (if suitably protected from strong light). Photographs have been taken in this way but the exposures are long, certainly much too long for portrait purposes. Such images are formed by the straight-line travel of light-rays, or, as more technically stated, by the rectilinear propagation of light. Another consequence of the straight-line transmission of light is the formation of shadows, for if a wide beam of light strikes a narrow object in its path, some of the rays are stopped and the insertion of a screen beyond the object shows an illuminated

screen with a shadow of the object upon it. Thus the Sun's rays shining upon a stretch of railings show the shadows of the railings upon the pavement beyond. Also, when the Moon comes between the Sun and the Earth, part or all of the Sun's light is cut off by the Moon and a shadow is thrown on the Earth, producing an eclipse of the Sun as shown in Fig. 115.

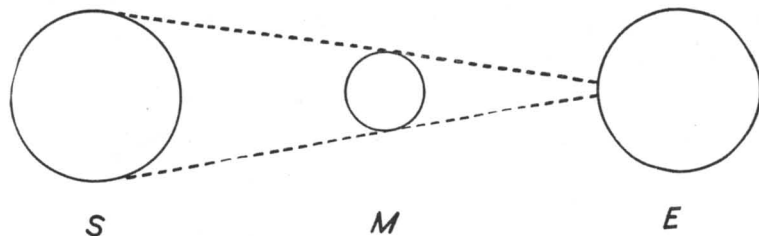

FIG. 115

## LIGHT-INTENSITY LAW

A source of light, such as a candle, lamp, or star, emits rays of light in all directions unless the source is shaded. Much of the Sun's light goes away into space; the proportion striking the Earth is a very small fraction of the total sunlight emitted. If a screen is placed one foot away from a candle, it can be said that the intensity of illumination of the screen is one foot-candle. Of course, candles differ in light production and a standard candle is defined as being made of sperm, six candles to the pound, the candle burning under certain steady conditions. However, if the same screen be now moved to a distance of 2 feet from the candle, the illumination is seen to be less. In fact, at double the distance the intensity of the light is not a half, but a quarter, at three times the distance not a third of the intensity but a ninth. This is a simple way of expressing the technical statement that the intensity is inversely proportional to the square of the distance. Thus, if the distance of the Earth from the Sun is called one, the distance of Neptune is thirty, it can be seen that Neptune would receive only one-thirtieth of one-thirtieth (one nine-hundredth) part of the sunlight received by the Earth on the same area. Measures of light intensity form a branch of astronomy known as photometry and contribute important knowledge of many heavenly bodies.

## LAW OF REFLECTION

If a ray of light strikes a flat silvered mirror (a plane reflector) most of the light is reflected back again. The ray striking the mirror is called the incident ray, while the ray leaving the mirror is called the reflected ray. From numberless experiments it has been found that the following law is obeyed, namely that the angles

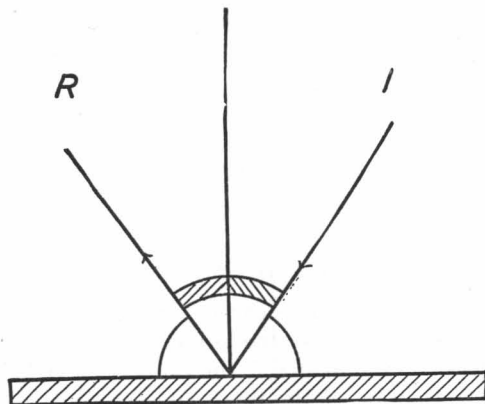

FIG. 116

of incidence and reflection are in the same plane and are equal to one another. (See Fig. 116.) In consequence, rays of light from an object are all reflected to form a faithful image of the object, which can be seen by the eye only if looking in the right direction. The image of the object appears to be as far behind the mirror as the object is in front. This fact is utilized by opticians when eye-testing in a short room by putting the patient alongside the test-board with a mirror at the end of the room, say 10 feet away. The patient sees the test-board in the mirror apparently 20 feet away.

## CURVED MIRRORS

Curved mirrors are often used in optical instruments and these may be of spherical or paraboloidal form. A spherical mirror is generally a small section of a sphere; it may be either convex or

concave. Fig. 117 depicts such mirrors with their principal axes. The points  $C, C'$  are called the centres of curvature and are distant from the mirrors by the lengths of the radii necessary to construct the sections of each sphere. If a parallel pencil of rays strikes such a

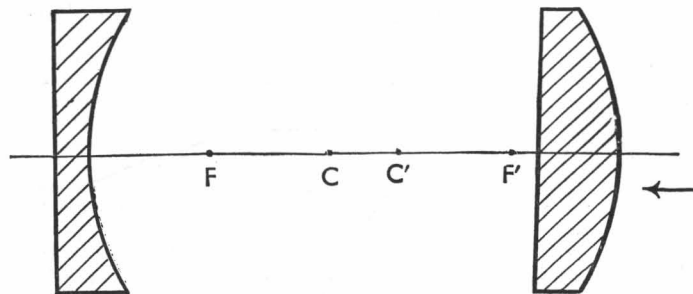

FIG. 117

curved mirror in a direction parallel to the principal axis, it will be reflected, apparently diverging from, or converging to, points  $F', F$ , called the principal foci. The distance between each  $F$  and the mirror is called the focal length of the mirror, and is easily shown to be

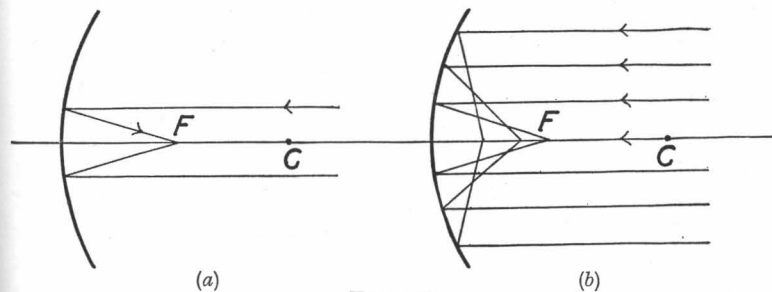

FIG. 118

equal to half the radius of curvature. Light from the stars reaches the earth in nearly parallel pencils, and if it is desired to have a telescope 7 feet long, the mirror must be constructed with a surface having a radius of curvature of 14 feet. The reader should notice that this bringing to focus at the point  $F$  applies only to narrow pencils of light; if the beam is large the intersection of the rays at  $F$  is not completely realized. Fig. 118 (b) shows the result of this defect known as spherical aberration. The defect can be removed by

replacing the spherical mirror by one having a paraboloidal form, as shown in Fig. 119.

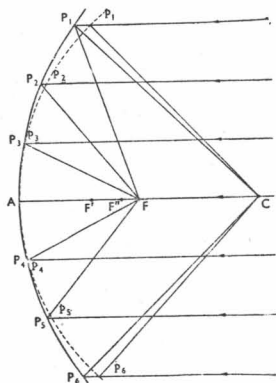

FIG. 119

The outer curve is a section of a paraboloid by a plane through its vertex  $A$  and focus  $F$ . Parallel rays of light falling on the mirror from the points  $P_1$  to  $P_6$ , including  $A$ , are reflected exactly to the focus  $F$ . The inner pecked curve is a circle whose centre is  $C$ , where  $FC = FA$ . This circle is the section of a sphere made by the same plane through  $A$  and  $F$ . Near  $A$  the circle and parabola (or sphere and paraboloid) almost coincide, but at some distance from  $A$  it is seen that they diverge, and  $F'$ ,  $F''$  are the points where parallel rays reflected from the circle at  $p_1$  or  $p_6$  and  $p_2$  or  $p_5$  intersect the principal axis  $AC$ .

## LENSES

While mirrors can be employed in some instruments for certain kinds of work, lenses are more frequently used to form the optical train, and the reader will now wish to understand the behaviour of light passing through the various types of lenses. Lenses, like

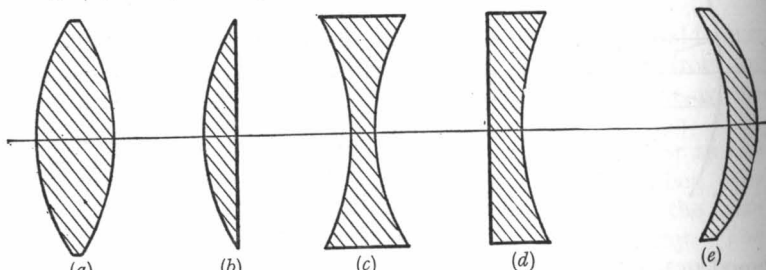

FIG. 120

mirrors, are generally made with surfaces which are portions of a sphere. Whereas, however, mirrors have a single surface, lenses have two and these may be plane, concave, or convex. Fig. 120 shows the various forms, which are described as follows: (a) double-convex; (b) plano-convex; (c) double-concave; (d) plano-concave; (e) concavo-convex.

In the case of a mirror, rays of light travelling in air strike the mirror, and if it is silvered on the front surface as in astronomical mirrors, the rays are at once reflected, and therefore remain in the same medium (air) throughout. But with lenses the rays of light travelling in air strike the lens, pass into a denser medium (glass), and emerge into a rarer medium (air). Now our teacup and spoon

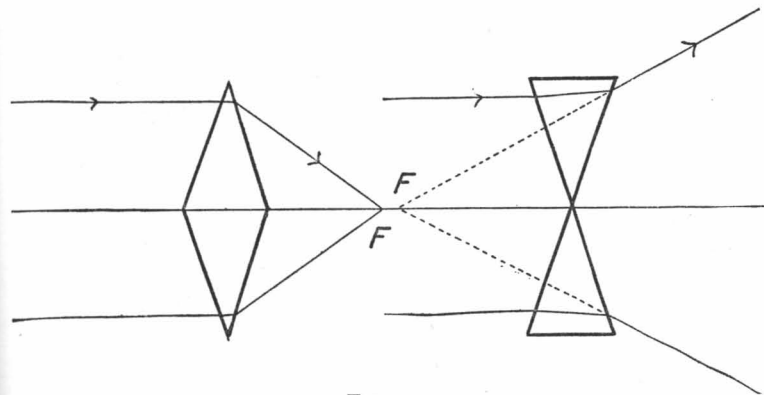

FIG. 121

observation mentioned earlier showed that a bending or refraction takes place when rays of light pass obliquely from one medium to another.

It is not easy for the ordinary reader to understand how light behaves in passing through the various types of lenses, and therefore any simplification of the explanation will be welcomed. Let us therefore take the two main types of lens shown in Fig. 120, namely (a) and (c), and modify them slightly, so that the double convex lens becomes two prisms, base to base, and the double concave lens becomes two prisms apex to apex, as shown in Fig. 121. The central line through each lens is the principal axis, as previously defined, and a ray of light passing along this axis passes straight through and suffers no refraction. Other rays suffer refraction on entering the lens and again on leaving the lens. In the case of the first lens the rays forming the beam converge to a focus  $F$ , but in the case of the second lens it diverges as if from a focus  $F$ . The defect found when using a broad beam with spherical mirror is



also present in lenses. This error (spherical aberration) is depicted in Fig. 122. In the case of mirrors this defect can be removed, as already pointed out, by making the mirror paraboloidal. As only one surface has to be figured this is not very difficult and this alteration can be readily checked by tests, but in the case of lenses each has two surfaces and the optician confines himself to spherical curves, reducing the spherical aberration by other means.

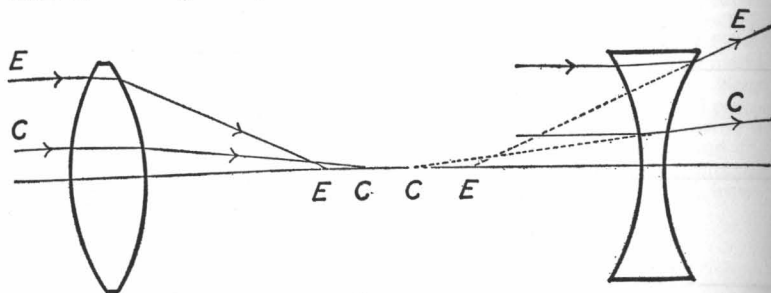

FIG. 122

Showing different foci *C* and *E* for rays passing through the centre and periphery of lenses.

## DISPERSION OF LIGHT

So far nothing has been said about the constitution of the rays of light refracted or reflected by lenses or mirrors. In fact, it has been assumed that all the rays of light studied are of the same wave-length—in other words, the light-rays so far described are monochromatic (one colour). This is, of course, not true in practice except to persons who suffer from colour blindness and many of these are not entirely blind to all colours.

The experiment made by Sir Isaac Newton about 1676, of passing sunlight through a prism, showed that sunlight is light composed of several colours. This important experiment was carried out by allowing sunlight to enter a shuttered window through a circular hole. The beam fell upon a prism of glass and on passing through was refracted to produce an image on the wall opposite the window. (See Fig. 123.) Now if sunlight was monochromatic (one colour) the image would have been a single image, but as sunlight is made up of several colours, the image obtained by Newton was a number of overlapping circles, each one a separate colour. The light had

not only been refracted by the prism but had also been dispersed. It is stated that Newton saw seven colours, but actually what is seen is a band of colour slowly varying from one end to the other, containing a large number of shades of colour which merge into each other. Along this band of colour it is possible to select certain definite colours such as blue, green, yellow, etc. This band of

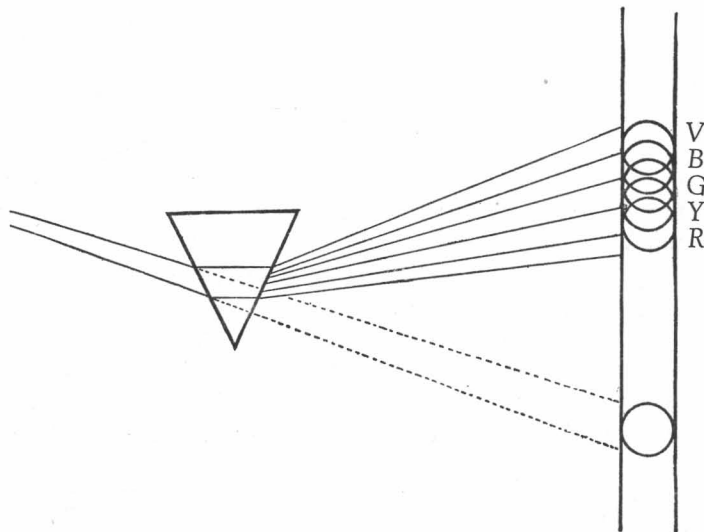

FIG. 123

colour is called a spectrum, and if it is produced from sunlight is a solar spectrum, if from the light of a star a stellar spectrum, while if it is produced from incandescent iron it is an iron spectrum, and so on.

The spectrum of sunlight as seen by the naked eye extends from violet at one end to red at the other, the violet light-waves being shorter than the red light-waves. Just as it is possible to measure the distance between the peaks of ocean waves so it is possible to measure the much shorter distances between the peaks of light-waves of various colours. Fig. 124 shows, in an exaggerated manner, the kind of difference in wave-length between the light-waves of three colours. From the peak of one wave to the peak of the next

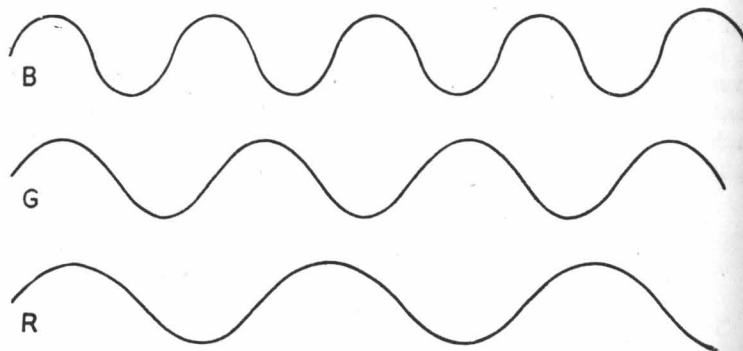

FIG. 124

is defined as a wave-length, and the accepted values for the generally recognized colours are:

Violet	0.00040 mm. or 0.000016 in.
Blue	0.00045    "    0.000018    "
Green	0.00050    "    0.000020    "
Yellow	0.00058    "    0.000023    "
Red	0.00065    "    0.000026    "

It must be borne in mind that the spectrum extends far beyond

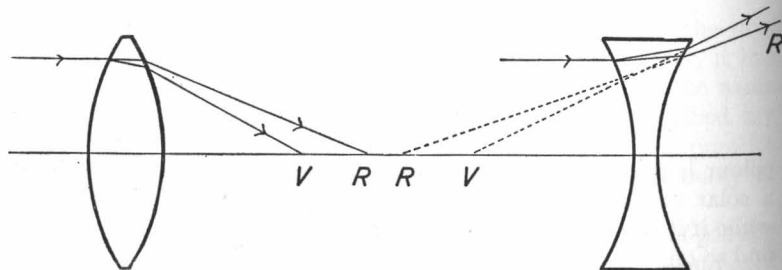

FIG. 125

Lenses bend rays of various colours through different angles. *V* and *R* denote the positions for violet and red in each case.

these limits on both sides, but is no longer visible to the eye. It can, however, be recorded by suitable photographic plates beyond the visible violet (for example, X-ray photographs), and beyond the visible red, firstly, by infra-red plates, and secondly by heat-registering instruments.

In consequence of the spreading out or dispersion effect of a glass prism, the dispersion of rays of different colours passing through a convex lens is similar. It can readily be seen that the effect is opposite for a double-concave lens. The double-convex lens bends the violet rays inwards too much while the double-concave lens bends the same colour outwards too much. This effect is known as chromatic aberration, and it is possible to combine two lenses of different dispersive powers to compensate almost exactly for the colour defect. Such a combination of lenses is called achromatic.

Instead of a prism a diffraction grating can be used.<sup>1</sup>

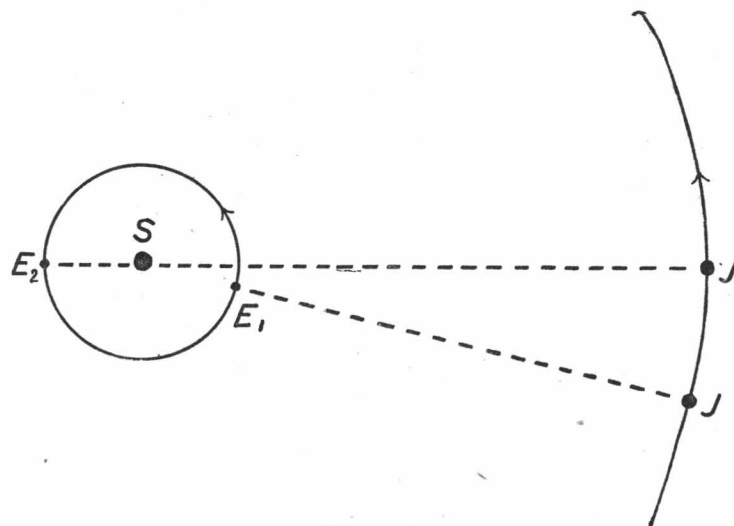

FIG. 126

## VELOCITY OF LIGHT

The speed or velocity of light is very great and varies according to the medium in which the light travels. The velocity has, of course, been measured, generally in air, but having done this it is quite simple to calculate the velocity in a vacuum, and this is the velocity which is accepted as the standard. The first discovery that light possessed a measurable velocity was made by Roemer in

<sup>1</sup> See page 67.

1675. While observing one of the moons or satellites of Jupiter he found that there was a discrepancy between the observed time of its disappearance behind Jupiter and the calculated time.

Firstly, when the Earth was approaching Jupiter the interval between the eclipses of the particular satellite became shorter; when receding the intervals grew longer. Secondly, there was a lag between the predicted and observed times depending on whether the Earth was at  $E_1$  or  $E_2$  (Fig. 126). Roemer put forward the idea, which was only accepted much later, that this was due to the fact that light did not travel at an infinite speed but took a time which could be measured if the light travelled a great distance. By analysing his observations he concluded that light took 22 minutes to travel across the diameter of the orbit of the earth. It is now known that the correct figure is  $16\frac{1}{2}$  minutes, the difference being due to an insufficient number of observations available to Roemer.

Many measurements by other methods have since been made and the most recent value of the velocity *in vacuo* is 186,283 miles per second. This value is unlikely to be in error by as much as 10 miles per second.

#### THE EYE

A brief mention should be made of the human eye which contains a crystalline lens. The lens is movable in its socket and has an iris in front of the lens just as is found in a camera lens, so that the opening can be reduced if the light entering the eye is too bright. The lens of the eye is a double-convex lens with a screen or retina behind it to receive the images. The human eye in nearly all young persons can adjust itself to bring to focus objects at a distance, or as near as 10 inches, but as people grow older the eye lens becomes less elastic and this power of accommodation becomes much less. In consequence, elderly people provide themselves with glasses, which are additional convex lenses to enable them to continue to do near work without strain. Young persons suffering from a defect in the eye lens known as short sight are provided with suitable concave lenses, but often they are able to use weaker lenses as their eyes become more normal with increasing years. The human eye can move about  $60^\circ$  from its normal position, and each eye records on its screen a separate picture which the brain blends into one record. This enables us to appreciate the solidity

of objects, which is the chief advantage of binocular vision. It may be of interest to state that spectacles have been used for 650 years.

## 2. INSTRUMENTS

### HISTORICAL

The history of astronomical observation can be divided into three main periods. The first period, beginning before written history and extending until 1600, was one in which all observations were made with the naked eye with the aid of crude sighting devices. From 1609 to 1850 the eye had the increasing assistance of the telescope. The third period since 1850, covering a bare century, has given the astronomer the aid of the photographic plate and film, enabling him to multiply the harvest of observations. The accuracy of the observations has been greatly increased and it has been possible to obtain information about much fainter stars than the eye could see even with a large telescope. The limit of vision with the naked eye can be placed at sixth magnitude, on a scale where the brightest stars are called first magnitude and each succeeding magnitude is two and a half times fainter than the preceding one. With a large telescope the eye can be assisted to see stars of about the sixteenth magnitude, but stars have been photographically registered as faint as magnitude 21 with the 100-inch telescope, and while the advance beyond this will be slow, the limit has not yet been reached.

Astronomical observation has, for the past 300 years, been carried out by the use of instruments containing mirrors and lenses. Mirrors for toilet purposes or ornamentation date back to the remote past, the earlier examples being made of gold, silver, bronze, or steel. Speculum metal, which is an alloy of tin and copper, was used for many of the mirrors of telescopes, until it was displaced by glass coated with silver. The first telescope would seem to have been made with spectacle lenses by Lippershey, a Dutch spectacle-maker, in 1608, and probably magnified three or four diameters. The news of the discovery spread rapidly and in



1609 telescopes 'about a foot long' were offered for sale in Paris. In May 1609 Galileo, then visiting Venice, heard of the discovery, and the next day made a telescope from stock spectacle lenses which magnified three diameters. He then took up the grinding of his own lenses, finally producing an instrument magnifying about thirty times. Glass was, however, at this time of very poor quality, and this hampered the production of good lenses for at least a century. Even window glass was so rare and valuable that wealthy persons who moved from one house to another, transferred the glass in their windows as well as their furniture. Moreover, the image of the object viewed by these telescopes was formed by a single lens which gave a coloured fringe around the image. As the only known way of reducing this defect was to make the focal length greater, telescopes of 2 inches in diameter but 6 feet long were soon made; by 1659 one was constructed which had a length of 23 feet. This extension in length continued until glasses of 200 feet focal length were produced, necessitating a scaffold to support the lens. These long-focus telescopes proved so unwieldy that very little useful work was done with them.

These difficulties caused a number of scientific men to attempt to devise optical systems which would give a well-defined image in an instrument of reasonable size. In 1663 James Gregory published his book on optics containing the plan of the Gregorian reflector, but its construction proved a failure owing to the inability of the optician employed to give the correct shape to the mirrors. But in 1674 Robert Hooke appears to have made a telescope on this plan without any remarkable results. At the same time, however, Sir Isaac Newton was experimenting with prisms of glass, and by an error (only realized much later) concluded that the lens type of telescope could never be perfected, thus delaying for seventy years the production of the two-lens colour-correcting object glass. Newton therefore transferred his attention to the reflecting type of telescope, and in 1672 presented a small model to the Royal Society on a plan known as the Newtonian. The mirror was 1 inch in diameter with a focal length of 6 inches. In the same year Cassegrain, a French sculptor, produced a telescope on yet another plan. But in 1723 James Hadley made a reflector of 62 inches focal length, which was tested by Bradley and Pound alongside an object glass of 123 feet focus and proved to be its equal in definition.

Henceforward the reflecting telescope was constructed in ever larger dimensions, culminating in the great 48-inch of Herschel in 1789 and Lord Rosse's 72-inch in 1845.

Passing from the great instruments which are now historical to those constructed during the last half-century, we note the 60-inch reflector at Mount Wilson, a number of 72-inch and 74-inch reflectors in Canada and South Africa, an 82-inch in Texas, and the 100-inch and 200-inch at Mount Wilson and Mount Palomar respectively. All these instruments are reflectors used photographically.

The rejection by Newton of the lens type of telescope was, however, overcome when Chester More Hall had the first two-lens achromatic telescope constructed for him about 1733. No particular notice was taken of this, but in 1758 John Dollond patented the method of producing an object glass corrected for colour, composed of crown and flint glass lenses, and his son Peter Dollond in 1765 made a three-lens objective. The way was now open to produce lenses corrected for colour as soon as it was possible to procure larger pieces of good glass.

#### OPTICAL SYSTEMS—REFRACTOR AND REFLECTOR

The optical systems of the main forms of telescope, the refractor and the reflector, must now be described. It will be assumed that the reader has studied the earlier section on light and its behaviour when passing through lenses or on striking mirrors. In the refractor the object glass brings the light to focus by refraction, while in the reflector the light is received on a concave mirror and reflected back up the tube to a focus. When the light has been focused, it is then possible either to magnify the image produced, by an eyepiece, or to insert a photographic plate to record the image. Additional auxiliary mirrors and lenses are often inserted in the optical path to bring the image to a position which is convenient to the observer. Fig. 127 shows the optical system of the general two-lens refractor, consisting of a double-convex lens of crown glass in front of a plano-concave or double-concave lens of denser flint glass. This combination, which largely corrects the chromatic and spherical aberration, makes it possible to design object glasses of required focal lengths which shall give good definition over a certain range of colour, but not over the whole range. If the object glass

is for eye observation, i.e. for visual work, it is designed to correct for light-rays on each side of the yellow rays of wave-length 0.00058 mm., these being the rays to which the eye is most sensitive. But if the lens is intended for photographic work it will generally be corrected for light-rays on each side of the blue rays of wave-length 0.00045 mm. Certain conveniences of construction are also

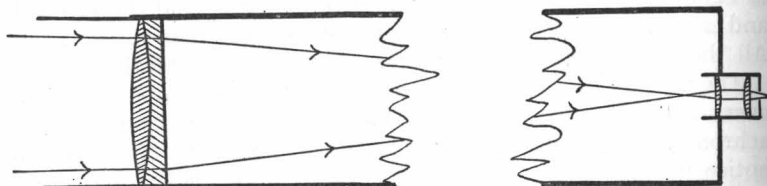

FIG. 127

considered, so that object glasses generally consist of a crown lens with surfaces of equal curvature. The flint glass then has one surface concave, of equal or nearly equal curvature to that of the crown lens, while the other surface is plane or nearly so. The resulting form is as shown in Fig. 128, the two lenses being (in small object glasses) often cemented together with Canada balsam to

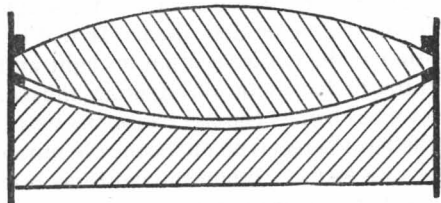

FIG. 128

avoid reflections from the inner surfaces. This form covers nine-tenths of the object glasses constructed, but in the remaining tenth many varieties for special reasons have been tried.

The largest telescopes in the world are reflectors. The main mirror, formerly made of speculum metal, is, in modern telescopes, made of glass, sometimes of low expansion glass such as pyrex or even of quartz. As the glass is only a foundation to support a film of silver, or more recently aluminium, the quality of the glass is not so important as that of a lens, where the light is transmitted

through its substance. In consequence, high-quality glass cannot be produced in such large pieces as for mirrors, and while the largest lens (cast in 1892) is 40 inches in diameter, the largest mirror is 200 inches across, and is of very recent construction. Readers should discount press reports, particularly from the American continent, of future constructions of lenses of 100 inches

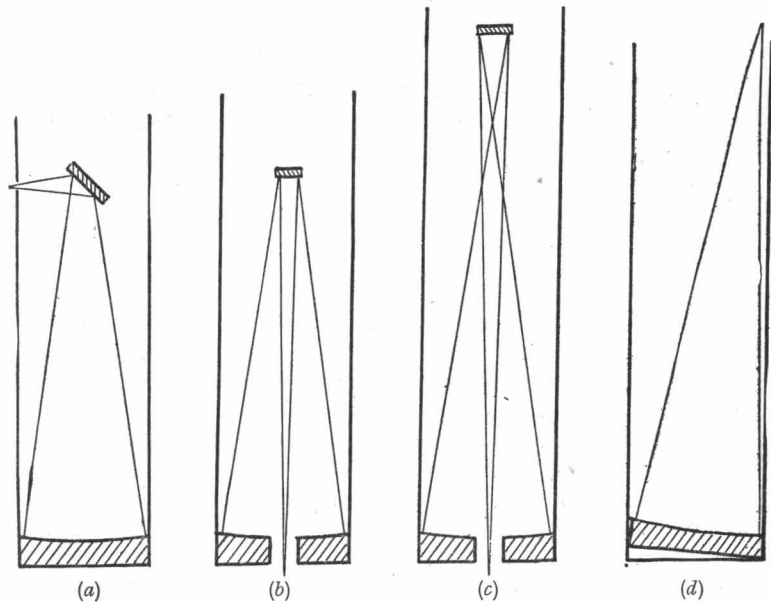

FIG. 129

diameter or greater, when the reporter is, in fact, writing about a mirror. The optical designs of the various types of reflector are shown in Fig. 129.

The Gregorian form (c) and the Cassegrain (b) have main mirrors with a hole through the centre, the eyepiece being behind the main mirror; the Newtonian type (a) has a plane diagonal mirror to pass the light to the eyepiece at the side of the tube, while in (d) the main mirror is tilted to bring the light to the eyepiece at the side of the tube at its upper end. This type was due to Herschel and is sometimes known as the 'front view reflector.'

The main mirror of the early reflectors was made to a spherical

curvature, but the definition of these mirrors was poor, and when Hadley produced a paraboloidal mirror the improvement was profound. The latter type of mirror brings a bundle of rays of all colours to focus, providing they are moving parallel to the axis of the mirror. But obliquely entering rays, i.e. off-axis, are slightly out of focus, and this defect, known as coma, limits the field of good definition. Away from the centre of the field the images have a comet-shaped appearance and this type of image could not be accepted for certain kinds of astronomical work. In consequence, good definition in many reflectors extends over rather less than a degree. Now astronomers desire, in studying certain problems, to photograph large regions of the sky on one plate, say  $15^\circ$  or  $20^\circ$ , and much thought has been given to improving the normal reflector to produce round images over a large field.

#### SCHMIDT REFLECTOR

In 1930 Bernard Schmidt, an astronomer at Bergedorf near Hamburg, published a design for a reflector giving good images over a large field. Instead of the main mirror being paraboloidal, it was to revert to the spherical form. It has always been claimed that the spherical form is the easiest to produce, but this is doubtful. There is no doubt, however, that it is the easiest to test. The failure of the spherical mirror to focus accurately to a point is described in the section on light, and to overcome this the new design by Schmidt consisted in the insertion of a thin plate of glass *S* at the centre of curvature of the main mirror *M* (see Fig. 130). The plate was to be shaped or figured by very small amounts, in such a way that light passing through it and striking the main mirror converged to a sharp focus. In fact, the figuring which took place in making the former spherical mirror into a paraboloid was now to be done on a thin glass plate, which would be placed at the mouth of the telescope tube. The result was to give small round images over a much larger field, but the large field had one disadvantage in that it was curved instead of flat. The curve was convex towards the main mirror, and the difficulty was met by pressing the plate *P*, or preferably film, against a former or moulded surface of the correct curvature. Another disadvantage was that in order to carry the figured glass plate at the mouth of

the telescope, the tube had to be longer than heretofore and, moreover, the making of the glass plate is a very skilled operation.

As the main mirror has to collect and focus not only axis rays but also obliquely entering rays, it has to be larger than the figured plate. The ratio of figured plate to mirror is in general two-thirds. Examples of this are the Case School instrument with plate 24 inches in diameter and main mirror 36 inches, and that recently installed at Mount Palomar with plate 48 inches and main mirror 72 inches.

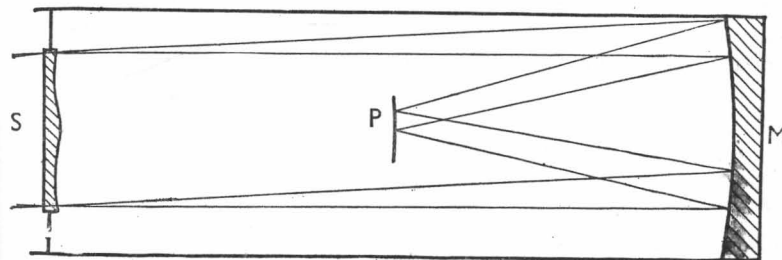

FIG. 130

More recently further designs of the Schmidt type have appeared and there is now a complete family of such types; moreover improved types with an additional mirror have been produced which give a flat field instead of a curved field.

#### SHORT-FOCUS OBJECTIVES

While the first photograph of a star was secured at Harvard in 1850 with a long-focus telescope, the earliest photograph of a large field of stars was obtained in 1882 when Sir David Gill at the Cape Observatory called in a local photographer, who strapped his portrait lens to a telescope to get a picture of a bright comet. The photograph was successful, but, more important still, it showed a large number of star images upon it. Since that time larger and improved lenses have been designed to secure accurate representation of large areas of the sky on one plate. The famous Cooke lens had three components to obtain good definition over a large field, i.e. a flatter field, and more recently four component systems consisting of two pairs have been designed by the American astronomer Ross. This system is sometimes called an astrographic lens, but



it must not be confused with the astrographic telescope, a two-lens object glass of the normal type, which was used for the eighteen telescopes placed around the world to photograph the whole sky for the astrographic chart. To produce a wide-angle flat field lens the design has been pushed so far as to include six components; such extreme designs are very expensive. The main disadvantage of these lenses is the difficulty of keeping all the components in accurate alignment, and in many cases the ventilation of such large pieces of glass in order to keep the temperature steady is not an easy matter. Such short-focus lenses are usually carried on the mounting of a much larger telescope to secure stability.

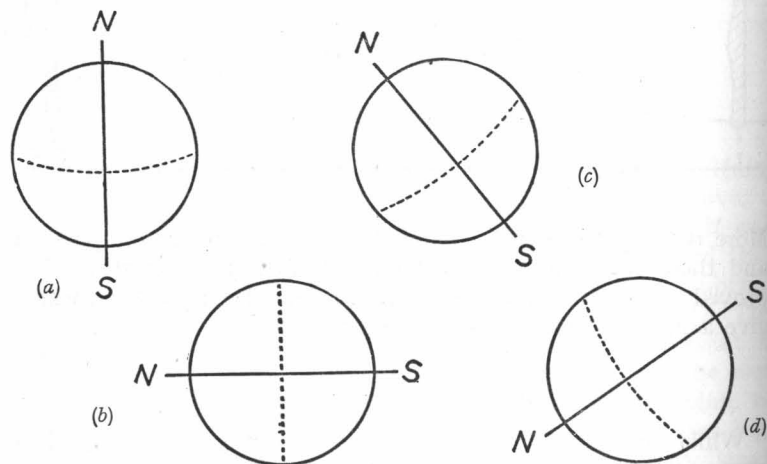

FIG. 131

## MOUNTINGS

Very small telescopes can be directed to the sky when held in the hands, but directly the magnification becomes greater than six or eight times, it is no longer possible to keep the telescope sufficiently steady and a support is necessary. For instruments of from 2 to 6 inches diameter, a three-legged tripod is used, the telescope being movable in azimuth, i.e. in a plane parallel to the horizon, and in altitude, i.e. in a plane at right angles to the horizon. When directed to a moving object, slow motions are usually provided

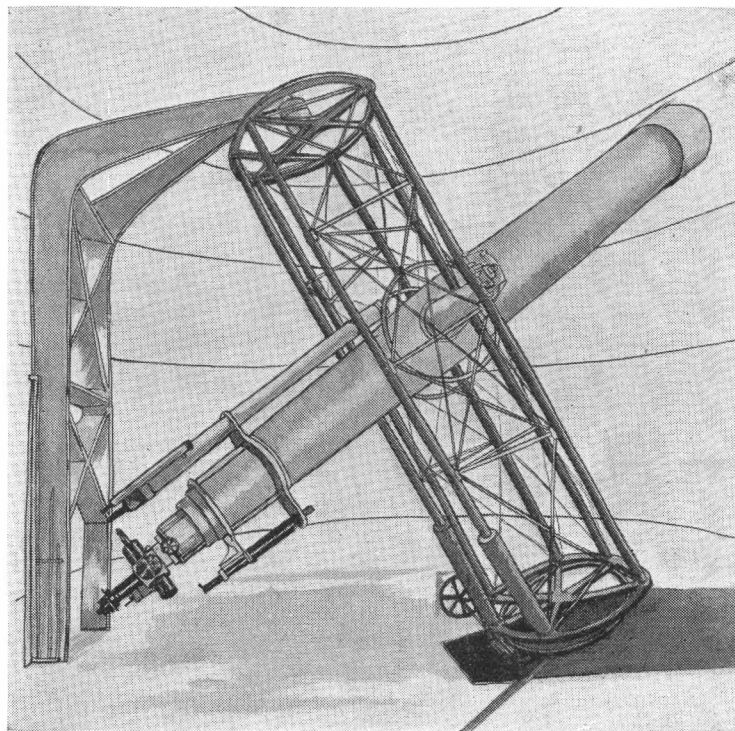

FIG. 132

to allow the object to be followed. But with larger telescopes, having higher magnification, the movement of the object makes it necessary that the instrument shall move easily and smoothly, and for long-exposure photography a clockwork drive is essential.

Now the motion of the stars from east to west is not real but apparent, and is due to the earth turning in the opposite direction. The motion takes place about an axis passing through the north and south poles of the earth, and if a telescope is set up on an axis parallel to that of the earth, it can be driven by clockwork at a slow speed sufficient to counteract the Earth's motion and thus make the star appear on inspection to be stationary. But we live on different portions of a globe, and the axis passing through the poles

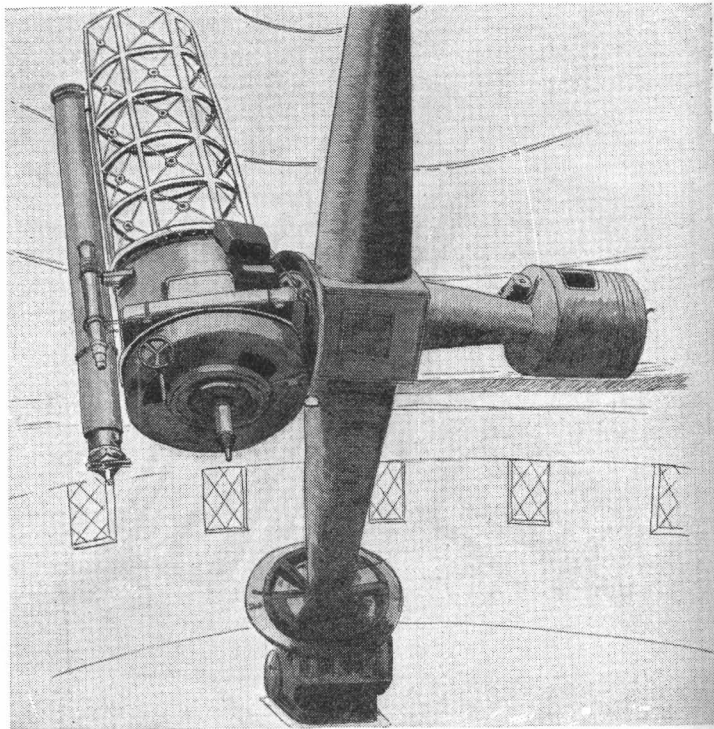

FIG. 133

of the heavens is at an angle depending on our location on that globe. If we lived at the north pole the axis would be vertical, while at the equator it is horizontal; in fact, the axis of the telescope would alter its angle as depicted in Fig. 131 (see Appendix IX). Therefore the telescope has to revolve about an axis which is at various angles to the horizon at various places on the Earth, and so we present the engineer with a problem: to make a mounting to carry the instrument so that it can revolve and yet be firm and steady, so that the star shall not move while an exposure of perhaps three hours is being made. The answer of the engineer is to offer a choice of several types which have evolved and been improved upon. Some are suitable in one part of the Earth and unsuitable for other parts, while some

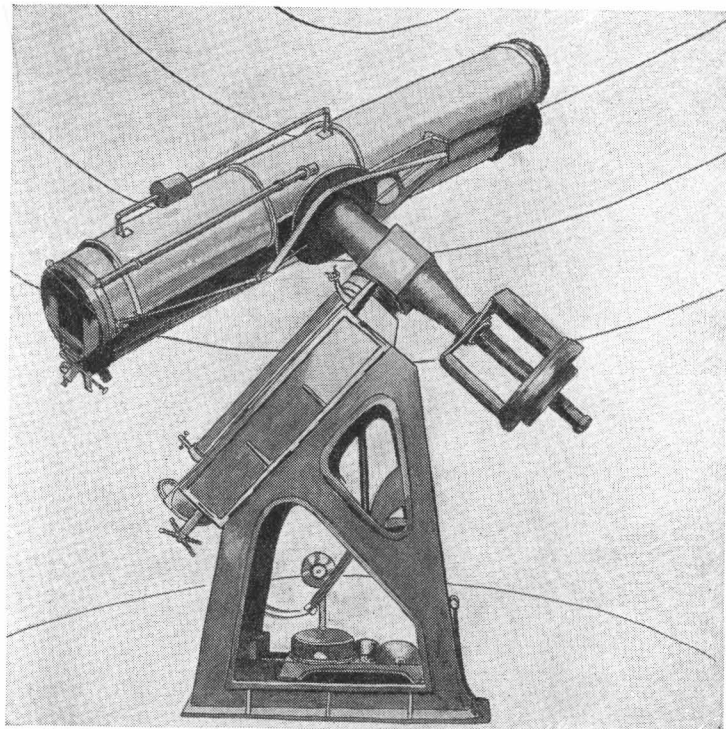

FIG. 134

are limited in being unable to point to certain parts of the sky. The main types number six and may be briefly described as follows:

Fig. 132 is the early English mounting with the polar axis supported at each end and the telescope slung within the axis. The great defect of this type is that it is impossible to observe the pole itself, and for certain kinds of work this is essential as the stars near the north pole of the sky were adopted as brightness and colour standards. The sketch represents the 28-inch telescope at Greenwich.

Fig. 133 shows the modified English mounting which enables the region of the pole to be observed. This is done by bringing the telescope outside the polar axis, which can now be closed up nearly

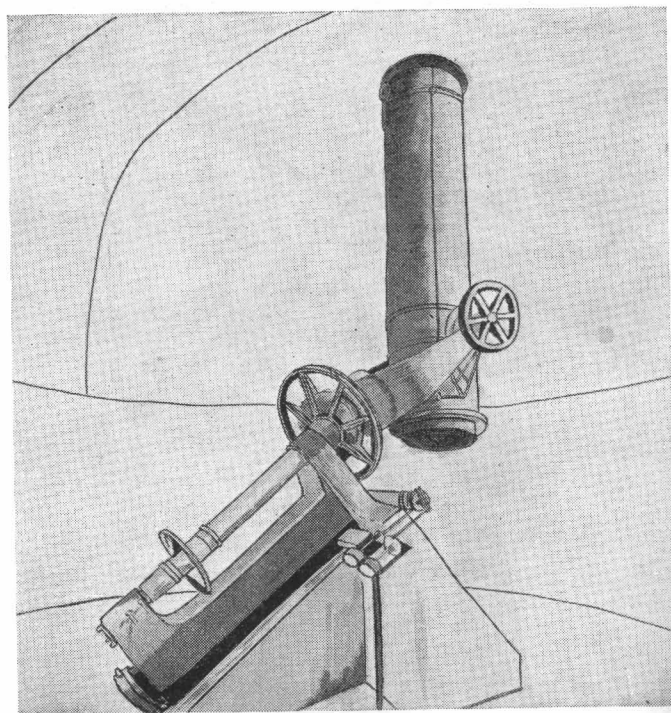

FIG. 135

solid; a counterbalance on the opposite side restores the equilibrium. The instrument depicted is the 36-inch Yapp reflector at Greenwich.

Fig. 134 gives an idea of the German form of mounting where the polar axis is short, carrying at its upper end another axis at right angles. This form gives an uninterrupted circuit of the pole of the sky. The sketch shows one of the eighteen astrographic telescopes used in the International Chart of the Sky.

Fig. 135 shows the 24-inch Harvard reflector, which is of the Fork type. The polar axis is short and a heavy fork is fastened to the upper end; the telescope swings on trunnions in this fork.

Fig. 136 shows a peculiar French design, known as the Coudé type, because of its likeness to an elbow. The light from the object

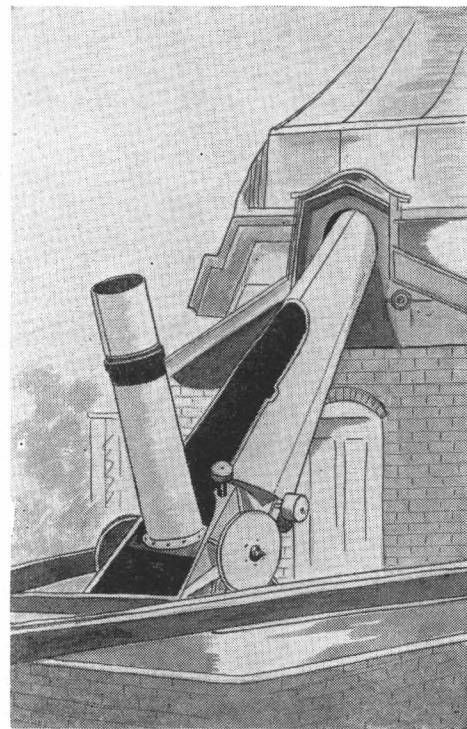

FIG. 136

observed is received by the objective which moves on a shorter arm, passes down to a flat mirror, and is reflected up the longer arm (which is its own polar axis) to the eyepiece at the upper end. Further, as the tube simply revolves about the optical axis the eyepiece can be brought into a room where the observer has comfortable temperature conditions. A large telescope of this type was made for the Paris Observatory, but the sketch shows the Sheepshanks telescope of the Cambridge Observatory.

Fig. 137 represents the polar telescope at Harvard Observatory, in which the telescope is its own polar axis with the object glass at the lower end. Light from the object observed is reflected into the object glass by a flat mirror outside the telescope; the eyepiece



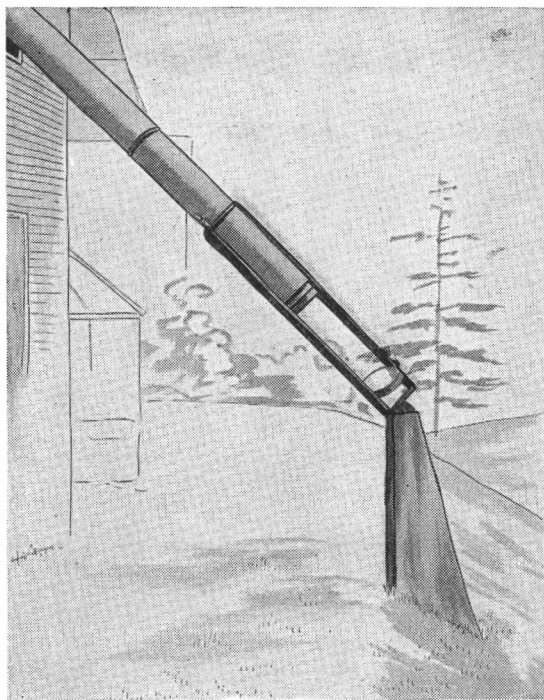

FIG. 137

is again to be found inside the building at the upper end of the telescope.

Many peculiar designs have been worked out and constructed to satisfy certain requirements. In some of the largest telescopes, which are reflectors, the work of the main mirror is to collect a large amount of light to form a bright image for examination by a spectroscope or other optical apparatus. As this auxiliary apparatus is heavy and needs steady temperature conditions, it is often placed underground where such conditions are easier to maintain. The light from the main mirror is therefore reflected by secondary mirrors down through the concrete pier supporting the telescope to a chamber below ground.

In order to give satisfactory images, the object glass of a refractor or the mirror of a reflector must be properly supported. For small telescopes the objective is enclosed in a metal cell which screws into the tube; as it is adjusted by the makers it should not be tampered with by a novice. In large telescopes the objective cell is bolted to the tube by three threaded bolts, and these are usually capable of adjustment to 'square on' the combination, so that it is at right angles to the axis of the tube. For very large refractors the crown and flint lenses are placed in separate cells so that it is possible to centre and tilt one on the other, and also to 'square on' the combination. The weight is then often so great (several hundred pounds) that six holding bolts are necessary, and frequent tests must be made to see that the lenses do not move out of adjustment. It is much more difficult to hold a large lens in adjustment than a mirror of the same size because a lens is only supported around the edge, whereas a mirror can be supported over the larger portion of the back surface. It is, of course, possible to hold a lens down so hard that it is unlikely to move, but in so doing it is easy to pinch and strain the glass, thereby distorting the optical image; moreover, under extreme pressure the strain can damage the lens permanently.

Mirrors for astronomical use should not be thinner than one-sixth or one-seventh of their diameter. Thus a 12-inch mirror should be 2 inches thick, while a 36-inch mirror should be at least 6 inches thick. If mirrors are thinner than this they tend to bend under their own weight, and as the surface is accurately shaped to support a reflecting film, any flexure will spoil the optical image. As the diameter of a mirror doubles the area is multiplied by four, and the increased thickness makes the weight increase eightfold. In consequence it is necessary to devise mechanical support for large mirrors. Fig. 138 shows the arrangement for a medium-sized mirror, consisting of a primary three-point bearing (not shown in the figure), each of which has three freely supported pads, on which the mirror rests. For a larger mirror the number of supporting pads would be correspondingly increased. Moreover it is necessary to support the edge of the mirror to relieve the strain imposed upon it when the telescope is tilted towards a horizontal position. This is often done by placing around the edge of the mirror a fibre band having a number of metal projections which are pierced to go over counterweights around the edge of the cell. The small secondary

mirrors are held in the tube by three or four strip metal supports placed edgewise to the light passing down the tube. The final adjustment of a refractor or reflector is done by an examination of the disk presented by a star image just inside and outside the focal point, but space does not permit a description of this delicate operation.

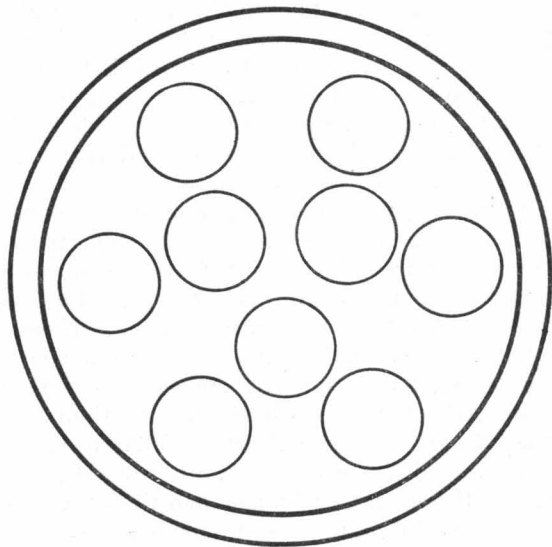

FIG. 138

Medium-sized or large telescopes are supplied with two graduated circles for use in pointing the telescope to a star when the two co-ordinates are known; these setting circles are essential for locating faint objects.

## EYEPIECES

The production of images by the optical systems of refractors and reflectors has been described, but if the image is to be viewed by the eye an eyepiece is necessary. Two main forms of eyepiece are to be found: (1) the type used by Huyghens, known as the Huyghenian eyepiece, and (2) the form known as the Ramsden eyepiece, which is thus named after its inventor. Both types consist of two

lenses, the one nearer the object glass or mirror being known as the field lens, while the other lens close to the eye is called the eye lens. In the Huyghenian eyepiece the lenses are plano-convex with the convex sides towards the objective. The field lens has to be placed inside the focus of the objective, the focused image being between the two lenses of the eyepiece. This is a negative form of eyepiece,

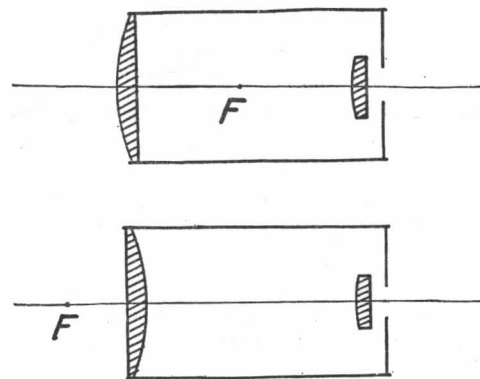

FIG. 139

Huyghenian and Ramsden eyepieces, top and bottom, respectively.

and its great disadvantage is that it is inconvenient for use with wire systems or graticules which would have to be situated between the lenses. The Ramsden eyepiece consists of similar lenses to the Huyghenian, but placed with their convex sides facing each other. The field lens is placed beyond the focus of the objective or mirror, and this permits the placing of wire systems or graticules in front of the eyepiece. It is a positive eyepiece, of which there are many other forms, some consisting of more than two lenses.

The designing of eyepieces is a very skilled art, and any kind of eyepiece will not necessarily give the best result with a particular telescope. No object glass is perfect, but a slightly imperfect one can often be improved as regards its spherical or chromatic aberrations by the use of a specially designed eyepiece which compensates the error remaining in the object glass.

Amateurs often wish to use their telescopes for viewing the landscape, and as astronomical telescopes produce inverted views it is

necessary to apply a re-inverting or terrestrial eyepiece. This is generally a combination of Ramsden and Huyghenian eyepieces, which is, in consequence, considerably longer than either eyepiece separately. Most eyepieces have a stop at the point nearest to the eye, which limits the light coming out of the eyepiece; the stop is about the same size as the pupil of the eye, which can seldom be larger than one-third of an inch in diameter. This size of pupil exists only when the eye has been 'dark adapted.'

The magnification produced in a telescope is measured by the ratio  $F/f$  where  $F$  is the focal length of the object glass or mirror and  $f$  is the focal length of the eyepiece, both measured in the same unit. It is often supposed that a greater magnification must give an improved result, but this is not true beyond a certain point, the main limitation being imposed by the unsteadiness of the atmosphere through which a star or other object has to be viewed. It is found from long experience that it is rarely possible to use a higher magnification than 50 per inch, i.e. for a 6-inch telescope  $50 \times 6$ , or 300. Indeed, better results are often obtained by using less than this, particularly in examining the surfaces of the planets.

#### DOMES AND HOUSES

Very small telescopes can be removed from their stands and taken indoors, but most amateurs look forward to the time when they can have a permanent covering for their instrument. The main forms of dome are the cylindrical drum and the hemispherical dome, and these are constructed of a metal framework filled in with boards of some light material, often compressed papier mâché. More recently an outer layer of thin copper sheeting is placed over interior layers of felt or asbestos. Telescope houses with a conical dome have been designed, while a much less costly form is that in which a flat roof can be rolled back clear of the instrument or even the whole house rolled away on rails. These latter methods eliminate the necessity for a shutter opening which should be from one-sixth to one-quarter of a hemisphere and which must be free to roll aside. A dome must be capable of turning through a complete revolution unless it is used solely for observations of the Sun. The dome for a large telescope involves a costly outlay and is an engineering feat in itself.

#### THE TRANSIT CIRCLE

When a telescope which is mounted so as to follow the stars across the sky, i.e. an equatorial, is used to obtain positions of the stars, the results are only relative to certain stars whose positions are already known. The latter are known as reference stars or standard stars and their positions must be determined by an instrument specially designed for such work. The position of a star in the sky is defined by two co-ordinates, Right Ascension and Declination. (See Appendix VIII.) The first of these used to be observed with a transit instrument while the second was obtained from observations with a circle instrument. This meant that two instruments involving two observers had to be employed to obtain the position of a star, and in 1851 when designing a new instrument, Sir George Airy, then Astronomer Royal at Greenwich, combined the two instruments forming what is now known as a transit circle or meridian circle. It will be desirable to describe the two instruments separately, although they are now amalgamated.

The transit portion of the instrument is a refractor which may be anything from 2 to 9 inches in diameter. The refractor is very stoutly constructed, having two pivots, one at each end of an axis at right angles to the telescope; these pivots rest in supports known as Y's, and the instrument can revolve only in the plane of the meridian. (See page 455.) Fig. 140 gives a diagram of the layout of such an instrument. Upon setting the instrument at the correct altitude of a star, the observer can, at the right moment, see the star pass across the field of view which is astride the meridian. The observation consists in accurately recording the time of the event. In the field of view a system of wires or threads is inserted, consisting of five or more vertical lines and one horizontal one; these wires are usually spider threads which have great strength for their small diameter. The distances apart or intervals of these wires have to be accurately determined by repeated observation. When a transit instrument is set up it is placed as nearly as possible on the meridian running through that place, but this cannot be done as accurately as the astronomer desires. Moreover, owing to changes of temperature and movements of the ground due to the absorption and evaporation of water, or even of earth tremors or traffic vibrations, a transit instrument if placed in the meridian



would not remain so indefinitely. Means are therefore provided to observe the errors of the instrument, of which the most important are (a) collimation error, (b) level error, and (c) azimuth error. The error (a) is due to any deviation from a right angle of the optical line from object glass to eyepiece with the line joining the pivots.

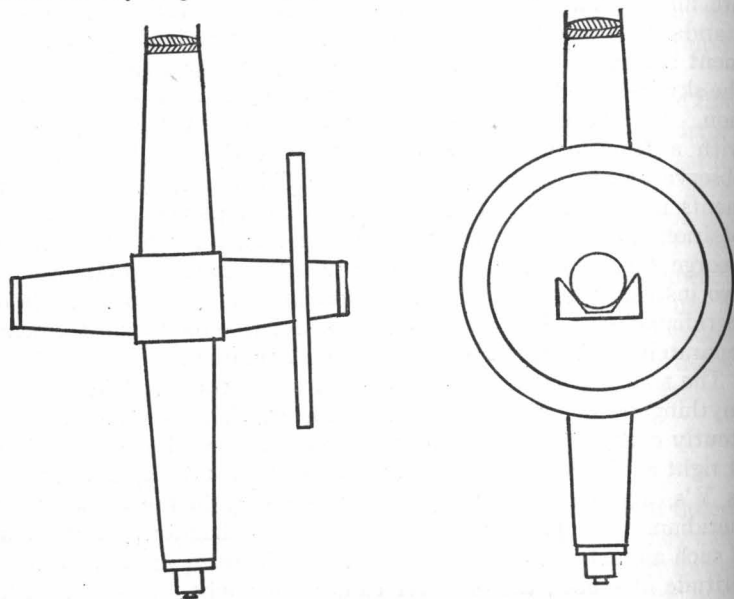

FIG. 140

The error (b) is due to the fact that the pivots may not be truly horizontal, while the error (c) is due to the fact that the line joining the pivots may not be truly east and west. These errors can be deduced from the observations themselves, but can be checked by optical and mechanical means; they must be determined every time a group of stars is observed, and if they remain constant for long periods the stability of the instrument is verified. The pivots of the instrument must be as truly circular as possible, and as the accuracy required for first-class instruments is very high, it is often necessary to polish the pivots and test their circularity at the observatory after delivery by the maker. Moreover, after the operation is completed it is necessary to determine the small

deviations from circularity which remain and to allow for them in the star observations. The larger the transit instrument, the heavier its construction and therefore the greater the wear on the pivots, and to relieve this wear the downward thrust of the pivots is reduced to a large extent by counterweights over pulleys which are attached to each pivot. These counterweights leave only a few pounds downward thrust on each pivot, but if the relief is overdone the pivots are no longer accurately seated in the Y's, and on turning the instrument the pivots tend to climb up the inclined sides of these bearings.

The circle portion of the instrument is a strongly constructed circle which is rigidly attached to the transit instrument, so that the line joining the centres of the pivots will pass through the centre of the circle. The circle is accurately divided into degrees and subdivided into one-twelfth of a degree, or five-minute-of-arc intervals. The divisions are often ruled upon a silver band let into the circle, but in the course of years the rulings tend to be rubbed away through the necessary cleaning of the circle. Accordingly, in the latest transit circle at Greenwich the circles are of glass, the divisions being etched rulings, and the circles are completely enclosed except at the points where the microscopes for reading the circles view them. As it is impossible to subdivide a circle without errors arising, it is necessary to measure and determine the errors of each division before serious observing can begin, and this preliminary work is considerable. The circles are read usually by four or six microscopes placed equidistant around the circumference of the circle and are therefore  $90^\circ$  or  $60^\circ$  apart respectively. By taking the average of the readings the errors of the divisions tend to be eliminated. When the star passes through the field of view, not only is the time recorded but it is also bisected on the horizontal wire. Then the circle is read, which gives the angle of altitude, and this can be converted into declination when the altitude of the pole (which is the latitude of the place) is known.

It has been stated that the transit observation consists in noting the time of the passing of the star across certain wires, one of which is very close to the meridian. At first this was done by listening to a clock beating seconds and estimating the moment (to a tenth of a second) when the star passed over each wire. This method was known as the 'eye and ear' method, and it put a great strain on the

observer's powers of estimation and memory, and later a simpler method of recording was brought into use. The observer was provided with an electric tapper, and as the star passed over the wires the observer recorded the exact moment of passing by tapping; this sent an electric impulse which actuated a pen tracing a line on a revolving drum of paper. On the same drum of paper the seconds of a standard clock were also automatically recorded, and thus it was possible to determine the moment of transit of the star. The operation of reading off the paper recordings need not be done immediately, which interrupts observation, but can be left until the following day. The recording paper drum is known as a chronograph, and was an improvement on the 'eye and ear' method. But no two observers send their signals in exactly the same way, and each person has a different time lag between seeing the star on the wire and tapping to show he has seen it; moreover, the same person records in a different way for bright stars as compared with faint stars. This lag is known as personal equation and at first the difference, which can amount to nearly a second of time, was not recognized as a personal error. In fact, Maskelyne in 1796 'parted with' his assistant because of a difference between them in recording the times of transits. Nowadays such differences between observers are realized, and if possible are measured. But early in this century a method was found which improved the agreement between observers; this is called the impersonal micrometer. The observer no longer times his observations by the fixed wires; instead he slowly but smoothly turns a wheel which moves a wire across the field of view, keeping the star bisected by the wire as it moves. The wire as it moves passes over contacts, which record the exact moment automatically on a chronograph. Now a star takes over a minute to pass across the field of view, and it is not really necessary for the observer to concentrate the whole time; he really needs only to bisect the star when the wire is nearing the contact. In consequence, the most modern method employed is this: the moving wire is smoothly driven across the field of view by a small electric motor, but a little slower than the true speed. The observer receives a warning pip on a loud-speaker when the wire nears a contact, and he then concentrates on bisecting the star. He then relaxes for a few seconds until the next warning pip. At the end of the transit the wire is rapidly turned back.

The transit circle is the most important instrument in any observatory which is making time observations or is constructing a grid of positions of standard stars. If certain experiments now being carried out are successful, the transit circle may be superseded for time determinations, but there will be a considerable

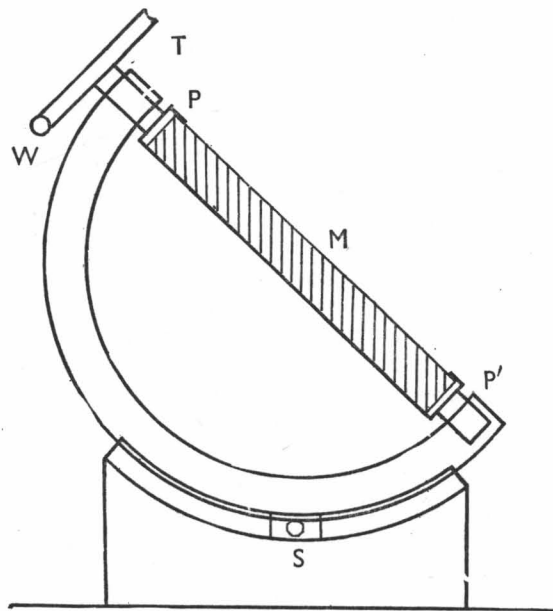

FIG. 141

The mirror *M* can be turned on the axis *PP'* by the toothed wheel *T* operated by the worm *W*. The apparatus can be rotated and secured by the screw *S* for different sites.

amount of work still left for such an instrument. For three hundred years there has been a continuous battle between the astronomer and the clockmaker. When the astronomer began to make more accurate observations he demanded better clocks, and when the clockmaker improved his clocks he also clamoured for better observations by which to test his clocks. This led to improvements in the astronomer's instruments, and so each of the rivals in turn jumped ahead of the other in his struggle for greater accuracy. At the moment the most modern clocks are so good that the astronomer

has some difficulty in checking them by his observations, but both the contestants are improving their equipment.

#### COELOSTAT

It is sometimes inconvenient to point a telescope to the sky and to follow the object during the observation. The reader has seen that a complicated and expensive mounting with clock-drive and a dome is necessary for a telescope. Further, it is sometimes desirable that the observer should remain in a fixed position, and in eclipse work, at a site away from transport and lifting facilities, it is easier to use the telescope unmounted in a horizontal position. If a telescope is to remain in a fixed position while observing a moving object, it must clearly be fed by a moving reflector in front of the object glass. Such an instrument exists in the coelostat, a name derived from two Latin words meaning a sky which is stationary. The name was suggested by Lippman of Paris in 1895, and this form of instrument has been widely used for solar work. (See Chapter II.) The instrument (see Fig. 141) consists of a mirror  $M$ , generally circular but sometimes elliptical, which can rotate about an axis  $P$ ,  $P^1$  in its plane and parallel to the Earth's axis. The mirror must rotate once in two days, for as the mirror rotates through  $180^\circ$  the reflected beam rotates through  $360^\circ$ . When the coelostat is moved to a new site a theodolite (small telescope with circles) is provided to set up the angle of the mirror correctly, so as to be parallel to the axis of the Earth. If the instrument is to be used to study the Sun at all seasons of the year, the change in the altitude of the Sun from summer to winter makes it impossible to throw the beam into a fixed horizontal telescope at all times. This is overcome by reflecting the beam from the coelostat into another plane mirror (adjustable in altitude) and thence into the telescope. Whereas in the polar telescope (see Fig. 137, page 384) the field which is viewed rotates, in the coelostat the field is fixed.

The largest fixed telescope is the 150-foot telescope at Mount Wilson Observatory. At the top of a tower there is a small dome containing the coelostat equatorially mounted, as already described, and driven by clockwork. With the aid of another mirror near it the sunlight is reflected vertically downwards to an objective just below them with a focal length of 150 feet. This objective forms

an image of the Sun in the laboratory at the base of the tower. A well 80 feet deep lies underneath the laboratory and contains a grating upon which the sunlight is directed and then returned by the grating to the laboratory, dispersed into spectra.

Several other fixed solar telescopes in various parts of the world are in use, two of which are also at Mount Wilson. One of these is on a 60-foot tower and another, known as the Snow telescope, is horizontal. The Astrophysical Observatory at Arcetri, Italy, is used by Dr. Abetti to study the solar atmosphere, and a 50-foot Einstein tower, of a similar type to the others, is used at the Astrophysical Observatory in Potsdam. Telescopes working on the same principle are installed at Oxford and Dunsink observatories.

These telescopes are not like the usual telescopes which require elaborate tubes or frames for holding the optical parts and also massive mountings, and in many respects are much simpler.

#### AUXILIARY APPARATUS

The reader can now visualize the construction of the main instruments used by astronomers. When most of the work at the telescope was done by eye, little additional apparatus was necessary. But in recent years great advances have been made in the knowledge of the physical state of the heavenly bodies, and this has only been made possible by the use of apparatus which is attached to the telescope or is operated by light collected by it. It is therefore necessary to give some account of this auxiliary apparatus, leaving the results of its use to appear in the appropriate chapters of the book.

#### SPECTROSCOPE AND SPECTROGRAPH

These two instruments have been the most powerful means of increasing our knowledge of the physical state of the stars and planets. In the section on light the experiment made by Newton with the prism has been described, and he obtained a spectrum composed of overlapping circular images, or in other words an impure spectrum. The purity of the spectrum was greatly improved by the suggestion of Wollaston in 1802 to substitute a narrow slit for the round hole used by Newton to throw a beam of sunlight on the prism, and in 1814 Fraunhofer saw that sunlight



was not only split up into a spectrum extending from violet to red, but that the spectrum was crossed by fine dark lines. These dark lines were due to darkness where there should have been light; in fact, at these points in the spectrum the light of that particular shade or wave-length was missing. Fig. 142 gives an idea in black and white of the spectrum of sunlight as first seen. The chief lines

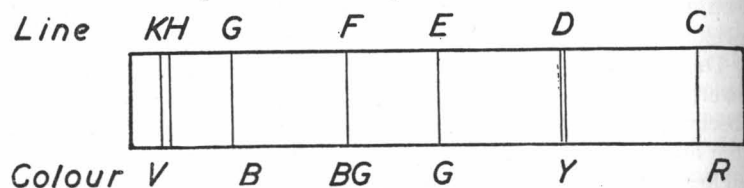

FIG. 142

seen by Fraunhofer were given letters in alphabetical order, working from the red end of the spectrum towards the violet. It is now known that:

The line C in the red is due to hydrogen.
"    D    "    yellow    "    sodium.
"    F    "    blue-green    "    hydrogen.
"    H    "    violet    "    calcium.

These experiments on sunlight, coupled with experiments on glowing gases in the laboratory, opened up the study of the spectrum, creating a new subject—spectroscopy.

The spectroscope as shown in Fig. 143 consists of one or more prisms, generally of glass, though for certain work in the infra-red special rock-salt prisms are used. The greater the number of prisms the more the light is dispersed, giving a larger scale to the spectrum. The gain in increased scale by dispersion is lost by decreased light, for the same amount of light is spread over a greater length. The light falling on the prism must be a parallel beam, and this is secured by an object glass placed before the prism or prisms, while the light leaving the prism must be focused by another generally similar object glass. Further, the light under examination must first pass through a narrow slit.

In astronomical work the spectroscope is firmly bolted to the telescope, which collects a large amount of light from the object under observation. This light is focused on the slit which is placed

at the focus of the collimating object glass, thus producing the parallel beam. After dispersion by the prism the spectrum is focused by the second object glass, which is part of the viewing

FIG. 143

Light entering through a slit *S* falls on the collimator *C*—a convex lens whose focus is at *S*. The parallel rays emerging from *C* fall on a prism or a series of prisms *P*, by which the light is dispersed, and then passes through the object glass *O*. This focuses it on the screen *H* and the spectrum can then be photographed. The small telescope *T* is used by the observer to keep the star image on the slit during the exposure. The band of colours is shown in Fig. 123, page 367, but to avoid overcrowding of lines the light in Fig. 143 is shown as monochromatic.

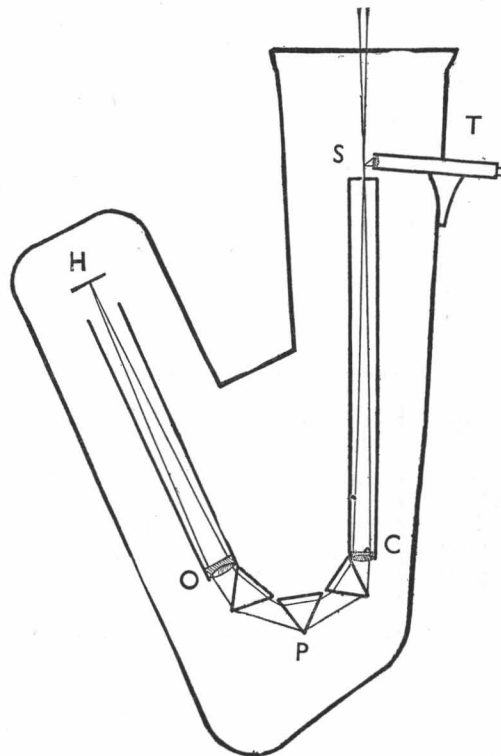

telescope used by the observer. Now just as much astronomical work formerly done by eye at the telescope is to-day replaced by photography, so has much visual spectroscopic work given way to photographic recording. By replacing the eyepiece by a camera, the spectroscope becomes a spectrograph. It may photograph in black and white the whole range of the spectrum from blue to red if suitable plates are used, but if the dispersion is large it may be necessary to photograph the spectrum in sections, say, from blue

to blue-green, blue-green to yellow, then yellow to red. In order to compare the spectrum observed with that of some known substance, it is arranged to be able to photograph a comparison spectrum on the same plate. This spectrum may be that given by an electric arc using iron, carbon, copper, or other metal poles or an incandescent gas such as hydrogen, helium, neon, or mercury vapour.

When the spectrograph is in operation for long exposures it is necessary to keep the temperature the same to secure constant dispersion, and to effect this the spectrograph is enclosed in an outer case which is electrically heated and thermostatically controlled at a temperature which can be set beforehand. For work in the ultra-violet the spectrograph must have the air removed by pumping to create a vacuum.

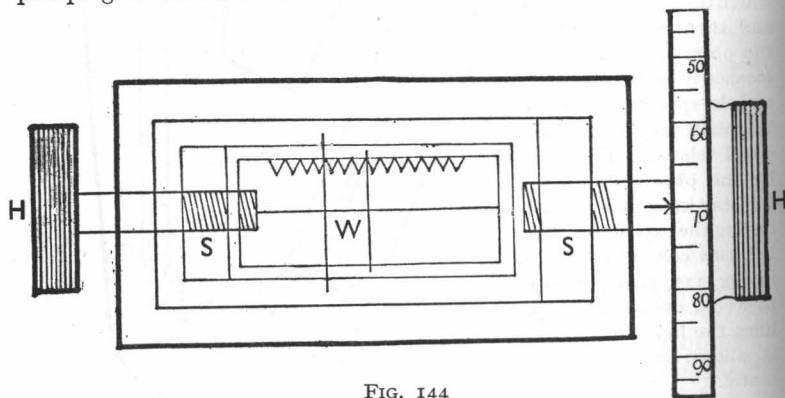

FIG. 144

## MICROMETER

One of the oldest pieces of auxiliary apparatus attached to telescopes is the micrometer. Used only in visual work, it is placed at the focus of the object glass to enable accurate measures of small angles to be made. These measures may give the distances (in seconds of arc) between close pairs of stars (generally double stars) or distances between a planet or comet and stars. The micrometer consists of a flat metal box containing one or sometimes two accurate screws *S*, which can move frames carrying spider threads or wires *W*.

The screws are turned by graduated heads *H*, upon which can be read the amount of turning which has taken place. When it is necessary to move the threads or wires over several revolutions of the screw, the whole number of revolutions is usually read by means of a comb, visible in the eyepiece itself, while the fractional portion of the revolution is read on the graduated heads. Micrometers generally have a horizontal wire as well as the vertical wires, and if the whole micrometer is to be rotated through an angle, this angle is read off on a position circle. Such a micrometer is shown schematically in Fig. 144, but many forms of micrometer other than this type are to be found.

## PHOTOMETERS

One of the chief branches of astronomy is that known as photometry. This deals with the intensity of light (see page 361), particularly the brightness of stars and planets, and the intensities of the light received are measured by some form of apparatus called a photometer. There are two main groups of photometers, the first type which measures the intensity of the object at the telescope, while the second measures the intensity, in the laboratory and at leisure, of the photographs taken earlier at a telescope. These latter can be dealt with at a later stage and the visual type of telescope photometer is considered immediately.

The human eye is able to make very accurate observations of the point at which two light sources are equalized, and most photometers depend upon the principle of varying one source so as to produce equality of intensity with the other source. Thus an astronomer observes two stars in the telescope and can see clearly that they differ in intensity; the photometer enables him to measure by how much they differ. This is done by having a series of filters (non-coloured) which vary in the amount of light they would stop if inserted between the star and the eye. The series must increase in density by small steps, so that the observer can easily decide when any of these steps produces equality when placed in the beam of one of the stars. Now a series of steps is useful but is not ideal, and what is really needed is a very large series of very small light steps. This is available in the wedge, which is a long filter varying slowly from no density at one end to a high density at the other, and this can be slowly slid along its length over a star. As it is

difficult always to find two stars close together in a telescope so as to compare one with the other, an artificial star is employed as one of the sources. This consists of a small illuminated hole which can be viewed at the same time as the star to be compared. Then the star can be reduced to equality with the artificial star (or vice versa) by the use of the wedge, and the amount of the reduction can be read off the attached scale. The accuracy and slope of density of the wedge can be first determined by measuring a number of stars of known brightness, and such a check is carried out frequently. It can also be checked by tests in the laboratory.

The second type, for measuring photographic plates in the laboratory, is somewhat similar in principle but utilizes measures of the photographic blackening on the plate. Again the comparison is an equalization, but this time it is of the amount of light which will pass through the photographic record as compared with the artificial source having constant intensity. The wedge reading gives the reduction which has been used, and this may be read by a measurer or may be recorded photographically on a drum of prepared paper.

#### PHOTO-ELECTRIC CELLS

The photo-electric cell is a device for the measurement of light, and is a recent development. It is more sensitive than the human eye to small differences of intensity, and provided certain precautions are taken is rapid in its action. These cells operate because light falling on certain metals, principally caesium, sodium, and potassium, causes an electrical change in the atoms of these metals. In fact, electrons are freed from the metal and generate a small current, which can be measured; the greater the light intensity, the greater the current generated. The cells are made of glass, coated internally with the desired metal and either evacuated of air or filled with an inert gas. Such cells have come into wide use for sound recording on motion-picture film.

For astronomical work the light from a star is collected by the telescope and allowed to fall on the cell. The response of the cell is electrically recorded and then the light from some standard source is also recorded, giving a comparison between the two. The cells vary in sensitivity according to the colour of the light they have to record; the potassium cell is most suitable for blue light,

the sodium for ultra-violet light, while the caesium cell has a large range from yellow into the infra-red. When in use the cells must be enclosed in a light-tight box to exclude stray light, and they work better at low temperatures so that they are usually packed around with solid carbon dioxide ('dry ice'). These cells provide yet a new form of photometer which can be used both at the telescope and in the laboratory.

#### PHOTO-ELECTRON MULTIPLIER

The principle of the photo-multiplier tube is as follows: the action of light on a photo-sensitive surface releases primary electrons, which are focused to fall upon a second sensitive surface which releases further electrons more in number. These are focused upon a third sensitive surface where further multiplication takes place. A multiplier tube may have ten such surfaces, and the result is a greatly amplified current reaching the collector and recorder. (See Fig. 145.)

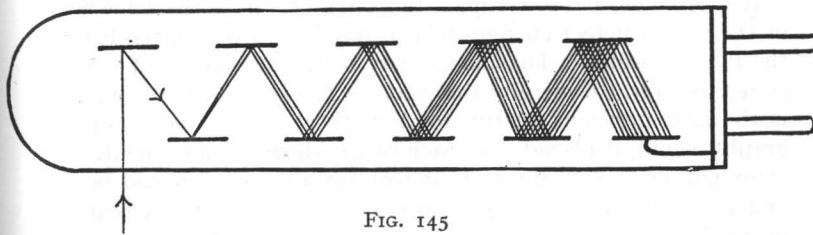

FIG. 145

#### DENSITOMETER

When the astronomer desires to measure the brightness of stars recorded photographically, he must have a scale of photographic blackening or density to interpret his measures and such a scale must be impressed on every plate. It is generally believed by the man in the street that photography is an accurate scientific tool, but this is only true if many precautions are taken as to the range of exposure times, care in development and drying of plates and films and accurate scaling of them. In order to impress a scale of blackening on the plate a device known as a densitometer is used. It consists of a box containing a number of tubes, all of the



same size and blackened internally. At one end of the box the photographic plate covers the ends of all the tubes, while at the other end a metal plate covers all the tubes. This metal plate is pierced opposite each tube by holes varying in sizes, which are calculated in advance to give the desired steps in density. When the pierced plate is evenly illuminated, each tube transmits to the photographic plate its appropriate amount of light, and the result is a scale of density patches imprinted on the plate at a single exposure.

Sometimes it is necessary to have a scale of blackening in light of several colours, and then the densitometer becomes more complicated. The scale can be secured, however, by passing the light simultaneously through a series of slits of known width (say 1, 2, 4, 8, 16, 32) and then transmitting the whole series through a prism, thus producing graduated density spectra. Thus a scale of density can be derived from the plate for all colours from blue to red.

#### BLINK MICROSCOPE

It is often desired to compare two photographs of the same region of the sky to detect changes which may have taken place between the two exposures. The change may be the movement of a planet, comet, or star. Generally the whole of the stars in the sky remain in the same positions relative to each other; in that case two photographs would, if placed over each other, show no movement. The examination of each image to detect any difference would be slow and laborious, and the blink microscope enables such a search to be made more easily and rapidly. The two plates are mounted side by side, and each is viewed by a low-power microscope. The two microscopes move together over the plates, and when the two photographs are properly adjusted each microscope views the stars in the same portion of each photograph. The eyepieces of the two microscopes are brought together so that they can be viewed, one by each eye. Now if the measurer blinks his eyes rapidly, shutting first one and then the other, any difference in the position of a star would appear as a jump. As blinking the eyes is inconvenient it is done for the measurer by having a shutter which rapidly cuts off first one microscope and then the other. By means of such a device movements amongst stars can be detected and measured very rapidly.

#### OBJECTIVE PRISM

Most of the apparatus described above is attached to the eye end of a telescope. Two pieces remain to be described which are fitted to the upper end, the first being the objective prism.

A spectrograph can only collect light from the one star (or perhaps two if they are very close together) whose light enters the slit of the instrument. It is often desired to study the spectra of a number of stars in an area of the sky; this is more rapid and in the nature of mass examination. It can be done by the use of the objective prism, which consists of a large piece of optically worked glass, prismatic in section but circular in plan, placed in front of the object glass. The angle is usually much smaller than the angle of the prisms in a spectrograph, ranging from  $5^\circ$  to  $10^\circ$ , and therefore the dispersion is small. Such prisms produce short spectra of all the brighter stars over an area of the sky. The objective prism operates successfully because light from the stars is for practical purposes a parallel beam, and as the stars are point sources they need no slit. The spectra produced by the prism are then brought to focus by the object glass on a photographic plate.

#### STELLAR INTERFEROMETER

The stars are points of light so distant that even the greatest magnification will not produce a real visible disk. Optically, however, the best telescope shows these point source stars as disks consisting of a central disk surrounded by several rings which become fainter as we pass outwards from the centre. This disk and ring system can only be seen in a good telescope under steady conditions of the atmosphere. The angular diameter of this spurious disk can be calculated and measured, and perfect agreement between the two results is found to exist. In consequence, if two stars are very close together, the two disks will overlap in the telescope and the observer will see one star only, though perhaps elongated. Higher magnification will not separate the two disks, for the disks will only be enlarged and still overlap; separation can only be secured by enlarging the telescope lens.

The stellar interferometer invented by Michelson is a device which overcomes this difficulty. The object glass is masked so that

only two portions of it are used to transmit light. (See Fig. 146.) The apertures remaining are on a diameter of the lens and equidistant from the centre. The result is that the optical disk which would be a normal disk and ring system if produced by one aperture, is seen when two apertures are used, to be crossed by equidistant parallel dark fringes, and these fringes are at right angles to the

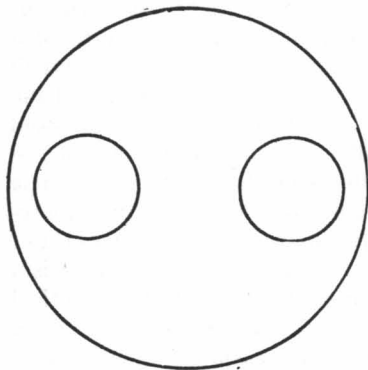

FIG. 146

line joining the two apertures. The fringes are produced by the interference of light from one aperture with that from the other aperture. It is found that by altering the distance apart of the two apertures, the fringes can be made to vary, and by a suitable adjustment of these distances the fringes can be made to overlap, bright on dark and dark on bright, so that the disk appears to be evenly illuminated. When this takes place it is possible to calculate the angular separation

of the two stars by means of the distance between the two apertures, the focal length of the lens and the wave-length of the light used being known.

The stellar interferometer has been used to solve another problem, the actual angular diameter of the largest stars. As before, if a star is observed by two apertures of a lens, the disk is seen to be crossed by fringes. If the star is really very large, by increasing the distance apart of the apertures the fringes should disappear. Having, from other data, some idea of the size of the largest stars, it was clear to astronomers that the apertures would have to be separated so far that even the 100-inch reflector was not large enough for the experiment. So they had the idea of spreading the apertures 20 feet apart by placing a long girder *GG* across the top of the 100-inch reflector with mirrors *M* at the ends to collect the light and to send it down the great telescope for examination. The mirrors could be moved apart along the girder until the fringes disappeared. (See Fig. 147.) The remarkable results of these measurements will be found in the chapter on the stars (page 286).

The instruments described above form the most common apparatus used by the astronomer. Some of it is now used less than heretofore because it is being superseded by new methods involving newly created apparatus. The optician and the astronomer co-operate in devising and designing new apparatus, and are more and more calling on the electronic engineer to assist them. The astronomer is always demanding greater accuracy in his measurements, and this involves the optician, the mechanical and electronic engineer, and the photographic research chemist.

Astronomy is a pure science, but the modern astronomer must draw upon ideas from the applied sciences around him to provide him with the more powerful tools needed to extend his researches to ever fainter and more distant objects in the sky.

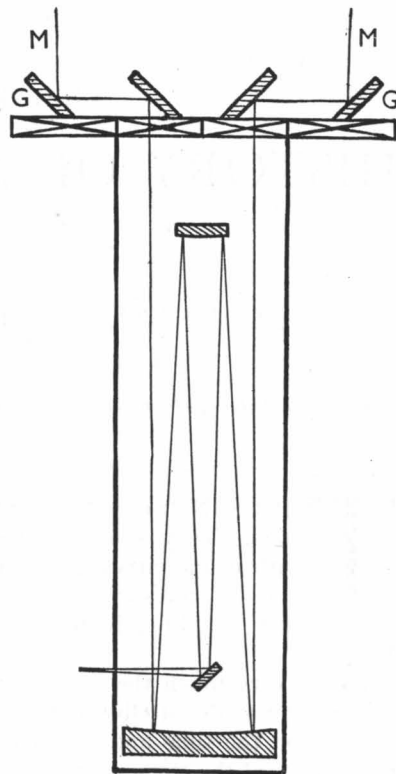

FIG. 147

## BIBLIOGRAPHY

*Light.*

- R. A. Houstoun: *Treatise on Light*, Longmans, Green, 1927.  
E. F. Edser: *Light for Students*, Macmillan, 1931.

*Instruments.*

- L. Bell: *The Telescope*, McGraw-Hill, New York, 1922.  
A. G. Ingalls: *Amateur Telescope Making*, Scientific American Publication, 1933.  
A. G. Ingalls: *Amateur Telescope Making (Advanced)*, Scientific American Publication, 1937.  
Dimitroff & Baker: *Telescopes and Accessories*, Churchill, 1946.

## CHAPTER X

## HISTORY OF ASTRONOMY

## I. FROM EARLIEST TIMES TO FLAMSTEED

H. L. KELLY, F.R.I.B.A., F.R.A.S.

*Director of Historical Section, British Astronomical Association*

## ANCIENT ASTRONOMY

**T**HOUSANDS of years ago men watched and marvelled at the stars. They thought that the stars were gods endowed with magic gifts and supernatural powers, and when they found it necessary to keep a record of the time and of the seasons they sought guidance from the stars, the Sun, and the Moon.

We do very much the same sort of thing to-day, for the astronomers at the Royal Observatory and at other observatories keep a check on the time and the calendar by observing the apparent movements of the stars. At present clocks and calendars are taken very much for granted, and the calendar hanging on the wall is not considered a very important document. Nevertheless, in certain ways it is the hub of modern society, for we live by the calendar just as did the ancient civilizations, but their calendars were difficult to hang on the wall and were not compiled so easily or unobtrusively as calendars to-day, nor were they so accurate.

From the time when people first settled in communities and discovered the value of the rotation of the crops, their continued prosperity depended on seasonal sowing and harvesting, both of which were impossible without some means of recording the passage of time. Hence the Egyptians made a calendar from the apparent movement of the Sun and kept a record of dates on stone tablets.

As far back as 2800 B.C. they recorded twelve months and three seasons on a stone stele. They observed the stars and built temples to indicate their apparent movements which foretold the coming of spring. Of course, the Egyptians were not the only ancient people who studied the stars. According to the historian Schlegel, the Chinese mapped the sky into divisions as early as 15,400 B.C., but no one now accepts this story, except perhaps a few Chinese. Coming to more reliable sources of information, we know that the Chinese in more recent times compiled a calendar based upon the apparent movements of the Moon, and they got into difficulties because the Moon is rather erratic in its movements. This made it necessary to check and adjust the calendar very frequently by watching the stars and planets. Consequently the Chinese evolved a very complex system which some people believe was used as early as 2637 B.C. It is more than probable, however, that their first calendar was not made until some hundreds of years later.

While the Egyptians and Chinese were struggling to regularize their calendars the Babylonians were doing the same. People in those days were more naïve than they are to-day and their interpretation of the starry heavens developed into astrology by which they tried to forecast the future. The Babylonians especially indulged in this, and in addition to keeping a calendar they made records of the stars and planets to assist in their astrological fortune-telling. Some of these records, made on stone tablets, have been found and deciphered, and indicate that an eclipse of the Sun was observed on March 8, 2283 B.C.

## GREEK ASTRONOMY

A number of similar Babylonian records of dated observations have been discovered, commencing from about 747 B.C. These were very important to the ancient Greeks when that nation eventually dominated the world and also needed calendars, but the Greeks were different from their predecessors, because they sought an explanation of the heavenly bodies and all that they implied. One of the first of these inquiring Greeks was Pythagoras, who has become immortalized in text-books by his theories and in particular by his triangles. He was also very interested in the nature of the universe and is often claimed as the first to have asserted that the



Earth was spherical and not flat. He also studied the planets, and his activities were possibly the most influential in the development of science because they were typical of an intellectual movement which started in the eastern Greek colonies—Ionia in particular—between 600 and 500 B.C. People like Pythagoras gave vigour to the rise of true knowledge which was just beginning to appear out of the morass of Babylonian astrological myth and fancy.

Amongst other Greek thinkers influential in encouraging this growth of reason were Thales (624–545 B.C.), Anaxagoras (500–428 B.C.), Aristotle (384–323 B.C.), and later Aristarchus (310–230 B.C.), Eratosthenes of Cyrene (276–195 B.C.), Hipparchus (190–120 B.C.), and finally Ptolemy (c. A.D. 140). A very brief summary of the work of each of these follows.

Thales lived at Miletus some time between 624 B.C. and 545 B.C. and was a pioneer of Greek geometry. He is credited with predicting the eclipse of the Sun in May 585 B.C., but there is no evidence that he predicted the place where totality would occur nor is there any evidence that he predicted the month or the date. He urged Greek navigators to follow the example of the Phoenicians in steering their boats by the stars in the Little Bear—not by those in the Great Bear as Greek mariners had been accustomed to do. In cosmogony he was not far in advance of the Egyptians and Babylonians; he thought that the Earth was a disk floating on water—a view held by the Egyptians and also found in Babylonian cosmogony.

A zeal for scientific knowledge was further inspired by Anaxagoras between 500 and 428 B.C. Some of the views which he is alleged to have held have probably been distorted—such as the view that the Sun was a great red-hot stone and was prevented from advancing beyond the tropics by a dense atmosphere which forced it back. We must give him credit for explaining the true nature of eclipses and also for the discovery that the Moon receives its light from the Sun, not shining by its own light.

About a hundred years after Anaxagoras a school was established at Athens by Aristotle whose teaching and writing covered an immense field—including biology, philosophy, and other branches; but we are concerned only with his astronomical views which, unfortunately, had a profound influence on European thought for a thousand years and in many ways retarded the advance of the

science. One example will be given (and many more could be cited). He held tenaciously to the view that the circle was the 'perfect figure,' and for many centuries astronomers were so obsessed with this doctrine that even in the days of Kepler circular motion of the planets was regarded as the only possible one. Many of his views on such matters as the distances of the Sun, Moon, and stars, the nature of comets, of the Milky Way, etc., were of no real value, and his original contributions to astronomy were very much inferior to those he made to natural history.

Aristarchus of Samos taught at the Academy at Alexandria, which had been founded about 314 B.C. He was a skilled astronomical observer and attempted to find the distances of the Sun and Moon from the Earth, as a result of which he concluded that the Sun was between eighteen and nineteen times as far away as the Moon. Although his method was sound in principle the error was very large, and this was due to the fact that he found it difficult to determine the exact time when the Moon was half full. From the apparently equal sizes of the Sun and Moon he deduced that their diameters were proportional to their distances from the Earth. From eclipse observations he inferred that the Moon's diameter was about one-third that of the Earth's. He anticipated Copernicus by eighteen centuries in his view that the Earth revolved around the Sun and also rotated on its axis, but such an outstanding pronouncement at that time was so much in conflict with the philosophy of Aristotle that very few supported the view.

Eratosthenes of Cyrene is noted more especially for his attempt to measure the size of the Earth. Some have thought that his results were remarkably accurate, considering the crude instruments at his disposal compared with those possessed by the modern astronomer, but the accuracy is doubtful as there is some uncertainty about the length of the stadium that he used. He also measured the obliquity of the ecliptic, that is, its inclination to the equator, and obtained a result only seven minutes of arc in error.

These and others provided the material upon which Hipparchus founded his theory of the universe. Sometimes called the 'father of astronomy,' he laid the foundations of modern astronomy and has been described by Delambre as 'one of the most astonishing men of antiquity.' He made a catalogue of the stars containing 1,080 stars which were grouped in 48 constellations and,

on comparing the positions of the stars with those given by earlier astronomers, was led to the discovery of the precession of the equinoxes.<sup>1</sup> He determined the length of the tropical year, verified the obliquity of the ecliptic determined by Eratosthenes, discovered the eccentricity of the then 'solar' orbit (in his days it was believed that the Sun moved round the Earth), and also of the Moon's orbit and the inclination of this orbit to the plane of the ecliptic. He deduced that the greatest and least distances of the Moon from the Earth were respectively 78 and 67 times the Earth's radius, results not very far from the actual values. He was the first to advocate the location of places on the Earth's surface by their latitudes and longitudes, and he even determined longitudes by eclipses of the Moon. He also classified naked-eye stars into magnitudes according to their apparent brightness.

The last great Greek astronomer was Claudius Ptolemaeus—generally known as Ptolemy—who lived in Alexandria about the middle of the second century A.D. His work at Alexandria is immortalized in his written record known by the Arabic name *Almagest*, which summarizes the work of Hipparchus in particular, but also that of some other astronomers. Although he contributed little of his own original work to the *Almagest* one important item must be mentioned because it was accepted for many centuries after his time.

Ptolemy taught that the Earth was the immovable centre of the universe, the Sun, Moon, and the entire heavens completing a revolution round it in twenty-four hours, but his theory was largely an elaboration of what Hipparchus expounded. Astronomers had noticed that the planets seemed to move in the same direction for a time and then they would appear to stand still with reference to the stars, after which their movements would be in the opposite direction. Ptolemy taught that each planet moved in the circumference of a small circle, called the *epicycle*, the centre of which described a circle, called the *deferent*, round the Earth. This very ingenious system could explain the peculiar and puzzling direct and retrograde movements of the planets, and for many centuries it remained unchallenged. By means of this scheme astronomers were able to predict with some approach to accuracy the positions of the planets, but when the discrepancies between predicted and

<sup>1</sup> See Appendix VIII.

observed places became too great revisions had to be made. In consequence epicycles had to be increased time after time until the whole arrangement became extremely cumbersome and also ineffective. It was superseded by the Copernican system in the fifteenth century when a new era in astronomy was inaugurated. The Ptolemaic system satisfied the theology of the day and also agreed with the philosophy of Aristotle who, as has been seen, taught that the circle was the perfect figure. Men could still believe that their little Earth was the centre of creation and their planetary system a very important part of the universe. The scheme worked with a fair degree of satisfaction, so why doubt it?

After the days of Ptolemy the history of Greek astronomy practically ceased. The scientific world was dominated by the Romans, who were not very interested in astronomy, though we must give them credit for the reform of the calendar in 46 B.C. At that time the calendar was so disorganized that the vernal equinox fell in December, and with the advice of the Alexandrian astronomer, Sosigenes, Julius Caesar carried out the reform of the calendar to which the name 'Julian Calendar' was given, but a discussion of this is outside the scope of this book.

#### MOHAMMEDAN ASTRONOMY

For nearly five centuries after the death of Ptolemy astronomy in Europe made practically no progress, and after that there was almost a complete blank for several centuries. This did not apply to the East where there had come a dramatic upheaval through the spectacular rise of Mohammed the prophet, the founder of Islam, whose flight to Medina in A.D. 622 has been chosen as the epoch of the Moslem era. His fanatical followers, spreading like a plague of locusts, carried their new faith westwards from Mecca, subjugating Syria, Egypt and North Africa, Spain, Sicily, Turkey, and eastwards Persia and India. Although destruction and devastation accompanied the followers of the prophet it would be a mistake to regard them as marauders devoid of all higher ideals. They discovered Greek astronomy and for centuries cultivated the science when interest in it had ceased amongst other nations.

In Bagdad, the capital of the Mohammedan empire, the caliphs had the writings of a Syrian monk translated into Arabic, and a

school for translation was established by Caliph Al-Mamun. Here Hanian Ibn Ishaq, a learned philosopher, assisted by pupils, translated the writings of Aristotle and Ptolemy into Arabic. An observatory was built and equipped in A.D. 829, and astronomical instruments, including sun-dials and astrolabes, were made. Development in astronomy is very limited without mathematics, and up to the period under consideration not only had arithmetic been a difficult subject, but mathematics in general was cumbersome because there was no flexible system of numbers. Multiplication and division are wellnigh impossible with Roman numerals, and a decimal system or any other precise method of calculation was impracticable. The system of numbers lacked one very important detail—there was no zero. Without a cipher for zero mathematics was very circumscribed and astronomy could get nowhere, because the essential complicated calculations could not be worked out. Fortunately the Arabs filled the gap.

In the early part of the ninth century Al-Kharizmi, a Persian, introduced a numerical system, now called Arabic; this system, discovered in India, includes a zero amongst its numbers, and with the greater flexibility of numbers mathematicians developed algebra and trigonometry from the ideas recorded by the Greeks. Simple as such subjects may seem to us to-day, they were an innovation of the utmost importance, laying the foundations for the future development of mathematics of a flexibility undreamt of in the days of the Mohammedan ascendancy, thus enabling the modern astronomer to attack abstruse problems which, only a few centuries ago, were utterly beyond the reach of even the most famous mathematicians.

The observatory at Bagdad was followed by others, and at one at Raqqa, about a hundred years later, Al-Battani (A.D. 850–929), one of the greatest of Arabic astronomers, made many observations. He computed tables of the Sun and Moon, and made estimates of the values of the obliquity of the ecliptic and the positions of the equinoxes, which were more accurate than those of Ptolemy. He introduced sines into trigonometry, and published a record of his astronomical observations which proved of great value to astronomers centuries later.

Another publication that proved very valuable was one by Al-Hazen (A.D. 955–1038), who was very interested in optics. His

book on the subject gave remarkably accurate values of refractions of various materials, and these proved very useful to the celebrated Johann Kepler in the seventeenth century. As these contributions from various fields of scientific investigation added to the store of astronomical knowledge, Mohammedan imperialism widened the sphere of scientific interest.

During the eighth century the Mohammedans acquired Spain and in A.D. 970 they established a library and an academy at Cordova which rivalled Bagdad as a centre of learning. Other establishments were founded elsewhere—including Toledo—and Arab astronomy spread all over Europe. Thus stars became known by Arabic names and Arab astronomers attracted the attention of scholars from far afield. Accurate tables of positions of stars and planets were prepared by a Toledan astronomer called Arzachel (A.D. 1028–87), and Al-Bitruqi wrote a text-book on astronomy.

In the tenth century a Persian astronomer, Al-Sufi, published a catalogue with lists of star magnitudes and some of the earliest known maps, with figures of the constellations. The magnitudes of the stars given by Al-Sufi were used by another astronomer, Ulugh Beigh (A.D. 1393–1449). He built an observatory near Samarkand and also founded a school of astronomy and compiled a star catalogue and planetary tables. His facility for astrological predictions proved fatal, for his eldest son was so perturbed by the horoscope cast for him by his father that he killed him. The tables prepared by these astronomers were called 'almanaca'—a word used by Roger Bacon and later despised by Johann Müller, but restored to astronomical prestige in modern times.

#### MEDIEVAL ASTRONOMY

There was a certain amount of infiltration of ideas across the borders of the neighbouring strongholds of Christian and Arabic learning. Thus Gerbert, afterwards Pope Sylvester II from A.D. 999 to A.D. 1003, had taught at Rheims before he was raised to the papal chair, and had published translations of Arabic works about the Hindu numerals, the abacus, and the astrolabe. This was the beginning of the translation by the west of the science of the east, and it increased until Gerard translated into Latin more than



ninety Arabic works. Gerard, who came from Cremona, studied Arabic at Toledo and flourished between 1114 and 1187. Amongst the works that he translated were those of Aristotle, Euclid, Ptolemy, Alfragani, and of others.

About this time religious bodies founded by Charlemagne in southern France had developed into great monastic organizations and seats of learning. From one of these came St. Thomas Aquinas, a Dominican monk, who taught a theology based upon Aristotle's philosophy and conception of the universe. He prepared the way in England and elsewhere for a ready acceptance of the Ptolemaic system. A Franciscan monk, Roger Bacon (1214-1294), who taught at Paris and later at Oxford, where the first school of astronomy in this country was established about 1330, advocated a new method of scientific approach. Contrary to the method of St. Thomas who depended largely on reason and revelation—the latter being the more important—and presenting men with mysteries to be believed even if they cannot be understood—Roger Bacon taught that knowledge should be obtained by interrogating Nature, that is, by observation and experiment, rather than by accepting irrational dogma. He performed a number of experiments with optical instruments, and is believed to have been the first to use spectacle lenses. From some of his writings it would seem that he had some ideas about telescopes, although his own story that Caesar used a telescope before the invasion of Britain to survey the country from the shores of Gaul, detracts from this view. Whether he knew the principles of the telescope or not, it is certain that he had many advanced views in various spheres of science and incurred the wrath of his superiors, finally suffering imprisonment.

At this time the Jews in Toledo were crystallizing their astronomy under the patronage of King Alphonso. At his instigation they collected available astronomical data and calculated and published in 1252 a new set of data which contained information about the positions of the planets and forthcoming eclipses. Data for regulating the calendar were also included, together with details of the length of the year and constants for astrological predictions. These tables superseded those by Arzachel at Toledo and were accepted as the most authoritative in Europe for the next three hundred years. A book, *Libros de Saber*, which was an astronomical encyclopedia,

was also compiled under Alphonso from information obtained from the Arabs. The preparation of astronomical catalogues and tables played an important part in the development of astronomy.

Johann Müller, commonly known as Regiomontanus, was a Bavarian who published an Ephemerides in 1471 in which he referred to previous publications of a similar nature as 'vulgarly called almanacs.' His Ephemerides is considered the first of its kind, contained tables of astronomical data prepared for navigation and other scientific purposes, and it condemned astrological and other prognostic publications. He also assisted with the revision of the Alphonsine Tables, and constructed in Nuremberg the first modern observatory. He set up a printing press, thereby establishing another milestone in the history of science. The advent of printing revolutionized means of communicating ideas and accelerated the rapid spread of knowledge. At this stage of human history there were many revolutionary phases in various branches of knowledge.

The renaissance of learning was spreading from Florence across Europe. In Florence flourished Leonardo da Vinci, that amazing genius whose versatility is the supreme example of the intellectual ascendancy engendered by the Renaissance.

Leonardo da Vinci was an artist, philosopher, and scientist, who lived from 1452 to 1519. Like Roger Bacon, he despised dogma and believed in seeking knowledge by observation and experiment. At his death he left about one hundred and twenty books of notes describing his experiments and researches in which he covered the whole field of science from mathematics to physiology. Unfortunately his notes were written in a code which was not deciphered until 1797—too late then to have any material effect on scientific development.

The peak of the Renaissance creative expansion was reached by Leonardo da Vinci, and a new era of adventure in art, literature, and science was gathering momentum. It was accelerated by the activities of a navigator in Portugal who never made one notable voyage, but instigated navigational feats by others with far-reaching results. This was Prince Henry, son of King John I of Portugal, who built an observatory in the year 1420 or thereabouts, where he set up a school of seamanship. For forty years he (Prince Henry) studied navigation, organizing sea expeditions, and investigating and improving navigational methods. Like

Alphonso, he gathered together Jewish astronomers and Arabic map makers to prepare charts and tables for use by his seamen. To Henry can be attributed the great voyages of Bartholemew Dias, Vasco da Gama, Cabot, Magellan, and Columbus.

*Nicholas Copernicus.* While Columbus was at sea in 1493 he tried to find his longitude by taking observations of Jupiter and the Moon, and lost his way. Other navigators doing the same kind of thing, by basing their calculations on the information given in the tables prepared by Johann Müller and others, also lost themselves. Never before had so many seamen tried to travel so far beyond the sight of land, and now mathematicians became disturbed by the navigators' problems and sought a solution by a revision of the planetary tables, but in so doing they disagreed among themselves. This proved very disconcerting to an astronomer in Poland—Nicholas Copernicus (or Kopernik, as his father was called), who was born at Thorn in 1473. He was so disturbed by the difficulties confronting navigators that he decided to seek a new theory of the movements of the heavenly bodies.

In the sanctity of his study Copernicus investigated the astronomy of the ancient Greeks. In addition, he made twenty-seven observations of Saturn, Jupiter, Mars, and Venus, and for more than twenty-five years he studied the problem of the motions of the heavenly bodies, finally recording his theories and conclusions in a book, *De Revolutionibus Orbium Coelestium*. The manuscript of this was finished about 1529, but the book was not published until May 23, 1543, the day before he died. At first the book caused little excitement, but later, when its full implications were appreciated, the more thoughtful astronomers realized that Copernicus had solved the major problem of the movements of the planets.

Copernicus said that the Sun—not the Earth—was the centre of the planetary system, and that the Earth not only moved around the Sun, completing its circuit in a year, but also had a rotation in twenty-four hours, thus causing the phenomenon of the succession of day and night, and also of the *apparent movement* of the stars round the celestial sphere in the same time. From the days of ancient Greece astronomers, with very few exceptions, had believed that the Earth was stationary, and for various reasons the new theory was not acceptable to every one, though there were a number of astronomers who eagerly adopted it. Amongst these may be

noticed Reinhold (1511–53), senior professor at the Protestant University of Wittenberg, who made use of the Copernican theory as the basis for compiling a new set of planetary tables which he published in 1551: they were called the *Prutenic Tables* because the printing was paid for by the Duke of Prussia. These tables were more accurate than any that had been previously published and remained in use until they were superseded by others compiled on the basis of Kepler's work, which marks another landmark in the progress of astronomy. Before dealing with his work it is necessary to consider that of Tycho Brahe, whose observations provided Kepler with the data which enabled him finally to enunciate his three famous laws.

*Tycho Brahe.* Tycho Brahe, born on December 14, 1546, at Knudstrup, in the south of Sweden, which was then Danish territory, came from an aristocratic family. In his earlier years he displayed a great interest in astronomy, but we can pass over his career until 1576 when King Frederick II of Denmark offered him the small island of Hveen in the Sound, where he could pursue his astronomical work. Tycho erected an observatory on the island, and there he carried out his astronomical observations for twenty years. In planetary observations especially he attained great fame, and he knew that it was only by amassing such observations that the question regarding the system of the universe could be settled. While recognizing the great advantages of the Copernican system in providing more accurate data for the positions of the planets, he sought another system that would possess these advantages without violating the authority of Scripture by postulating a moving Earth. In 1577 he promulgated the 'Tyconic system,' which retained the Earth as the centre of the universe but not the centre of the orbits of the planets; the Sun was their centre and, like the Moon, revolved round the Earth.

Although Tycho established no permanent system of astronomy his observational data were invaluable in the hands of Kepler. It is worthy of notice that he expressed the hope that Kepler would prove the truth of the Tyconic system, and within eight years of this Kepler had shown that the system was false.

*Kepler.* Copernicus left much unexplained in his theory. He still believed that the planets moved in circular orbits and epicycles, but Kepler simplified the system still further and announced his

three fundamental laws which explained the behaviour of the planets and also provided a reliable basis for future calculations of planetary motion.

Kepler's three laws, enunciated in 1609 and 1618, are as follows:

1. The orbit of each planet is an ellipse with the Sun in one focus.
2. The radius vector joining the Sun to a planet sweeps out equal areas in equal times.
3. The squares of the periodic times for any two planets are in the same proportion as the cubes of their mean distances from the Sun.

The discovery of these laws greatly simplified the mechanism of the solar system, epicycles and other fantastic circles disappearing from the explanation of planetary motions. The Copernican doctrine that the Sun was the centre of the solar system was now placed on a firm basis. It may be added that Kepler saw that the third law applied to the satellites of Jupiter as well as to the planets, and he confesses to the wonderful exultation he experienced at the discovery of this law in 1618, nine years after his announcement of the first two laws.

*Galileo.* Galileo de Galilei was born at Pisa on February 15, 1564. His opposition to the philosophy of Aristotle resulted in his dismissal from his professorship of mathematics at Pisa University. In 1592 he went to Padua as professor of mathematics, and while there heard of an unusual instrument constructed by Lippershey, an expert Dutch workman. This was the telescope, about which there was so much rumour that Galileo was incited to make one for himself. Although others have claimed to have been the first to construct and use the telescope, including John Baptist Della Porta, a prominent scientist from Naples, there is no doubt that Galileo improved the instrument. In addition, he was the first to bring it into prominence by his astronomical observations described in his famous book, *Sidereal Messenger*.

His observations finally confirmed the accuracy of the fundamental principles of the Copernican theory, though many still refused to accept his views and even rejected the evidence brought to light by the telescope. Galileo saw four moons encircling the planet Jupiter, thus observing a system that was a small replica of our Sun and its planets. He also discovered the mountains and plains on the surface of the Moon, and observed the phases of Venus, thus providing

another proof, if such were needed, that this planet revolves around the Sun. With these and other discoveries Galileo publicly advocated the adoption of the Copernican theory, thereby incurring the displeasure of the Church. On June 22, 1633, he was compelled by the Inquisition to abjure his errors and heresies, and was also condemned to the formal prison of the Holy Office during the pleasure of the judges. The pope commuted this latter sentence to confinement at a country house near Rome, but later he was allowed to return to his own country house at Arcetri.

In his later years failing eyesight prevented him from making many observations, nevertheless he was able to devote himself to dynamical problems in which he had been interested many years previously. In 1638 his *Dialogues on the Two New Sciences* appeared; this gave a summary of his work on motion, acceleration, and gravity, and it is interesting to know that Newton's three laws of motion enunciated in 1687 were largely based on the work of Galileo. He died on January 8, 1642, in his seventy-eighth year, and his books remained on the *Index of Prohibited Books* for nearly two hundred years. They were not omitted from the list until the appearance of the 1835 edition, and they have never been listed since.

*Hevelius and Horrocks.* The further improvement of telescopes now occupied the attention of astronomers. Hevelius, an astronomer educated at Danzig and Leyden University, established the best equipped observatory in Europe, and his telescopes were the wonder of the age. One of these was 150 feet long, because in his days it was essential that the object glass should have a very long focal length in comparison with its aperture. Only by such means was it possible to overcome the difficulty of chromatic aberration.<sup>1</sup> His *Selenographia*, published in 1647, described and gave names to a number of mountains, craters, and seas on the Moon. He also wrote other books giving an account of comets observed in the past, and carried out observations of the five known planets and some of the brighter nebulae. Although one of his observatories was destroyed by fire in 1679 he built and equipped another where he made a catalogue of 1,500 stars, for which he used only naked-eye observations.

In this country Jeremiah Horrocks, a young astronomical genius,

<sup>1</sup> See page 369.



very handicapped by poverty, made great improvements in the theory of the Moon's motion and also showed that the periodic irregularities which he observed in the motions of Jupiter and Saturn were caused by their mutual perturbations. He is noted for his prediction of the transit of Venus on November 24 (Old Style), 1639, which he observed, achieving fame as the first person who had ever observed a transit of the planet.

Astronomers using the new telescopes, were, however, faced with a difficulty which they could not at first overcome. They could not see very clear images because a halo of coloured light obscured the detail.<sup>1</sup> The single object glass bent the red and blue rays of light unevenly so that a coloured fringe surrounded the image, and a solution to the problem was not found until Sir Isaac Newton introduced an entirely new kind of telescope.

*Isaac Newton.* Newton's advent into the history of astronomy marks the beginning of the climax of an epoch and the dawn of a new outlook. From his birthplace at Woolsthorpe, near Grantham, Lincolnshire, he went to Cambridge University where he graduated in 1665. From his early days he had been interested in gravitation, and for many years had studied optics as well. He experimented with a glass prism, and noticing how sunlight was dispersed into a rainbow, discovered the compound nature of white light. This gave him the idea for his new type of telescopes.

The trouble with telescopes of Galileo and the others in which the light passed through a glass lens, the object glass, was the coloured fringe, similar to the effect of the prism. So Newton contrived an instrument which collected and reflected the light from the heavenly bodies instead of refracting it, and in 1668 made the first reflecting telescope, which was 6 inches long and 1 inch in aperture. A similar idea had been described in a book by James Gregory, another astronomer, who sent a manuscript to London for publication in 1663. Gregory described a type of reflecting telescope known as the 'Gregorian.'<sup>2</sup>

Newton's invention, however, was made quite independently of Gregory, and by 1671 he had constructed a second telescope which the Royal Society asked him to send to London, and as a result of the inspection of the instrument he was elected a Fellow of the Society in 1672. The telescope is still preserved in the library of

<sup>1</sup> See pages 373-4.

<sup>2</sup> See page 375.

the society. Probably very few in Newton's days realized the far-reaching possibilities in this type of instrument.

Newton's law of gravitation, which had exercised his mind for many years, can be stated as follows:

'Every particle in the universe attracts every other particle with a force varying directly as the product of their masses and inversely as the square of the distance between them.' In the case of a spherical body Newton showed that its attraction on a particle outside the sphere was the same as if the entire mass of the body were concentrated at its centre. Newton spent some years in proving this last principle, and it is believed that his delay in verifying the law of gravitation from the motion of the Moon around the Earth was due to the difficulty in proving that a body like the Earth attracted another spherical body as if all the matter in each were concentrated at their centres. The story that at first he used a wrong value for the radius of the Earth and did not use Picard's more correct value, thus causing the delay referred to, is now discredited.

Newton had many scientific friends amongst whom was Sir Christopher Wren, the architect of St. Paul's Cathedral. Wren was an astronomer before he became an architect, and in 1660, at the age of 28, was appointed Savilian Professor of Astronomy at Oxford. He was also one of the founder members of the Royal Society in 1664-5, and his association with other founder members brought him into contact with Halley and Hooke, both well-known scientists.

At this time Kepler's theory about elliptical orbits for the planets was the subject of much discussion and argument amongst scientists. No one had yet succeeded in explaining why the orbits were elliptical. At a meeting between Wren, Halley, and Hooke, Wren offered a prize to Hooke or Halley if either could supply a convincing explanation. Halley travelled in haste to consult Newton at Cambridge, and he supplied the explanation, later in the same year sending calculations to prove this. These calculations were contained in a paper, *De Motu*, which was sent to the Royal Society, and formed the germ of an even more historic publication by Newton, the *Principia*, which was published in July 1687, at the instigation of Halley.

In the *Principia* Newton described his great law of gravitation,

and finally closed the chapter of doubt and uncertainty which surrounded ideas of the universe and planetary motion since the dawn of astronomy.

Gravitation was not the only subject described by Newton in his *Principia*. He gave explanations of the tides, wrote extensively on optics, mathematics, and other subjects, and late in his career even displayed a great interest in theology; but as this is a history of astronomy it is outside the scope of the chapter to deal with these other subjects.

In a brief historical survey it is impossible to describe adequately all the amazing discoveries and developments that now took place. Seeds of knowledge which had been sown in the preceding centuries were now bearing fruit abundantly. Astronomers had convincing laws to explain their observations, and they had a mathematical equipment to further their investigations.

The story of the discovery by Olaus Roemer (1644-1710) of the progressive movement of light is related elsewhere,<sup>1</sup> and need not be further referred to here, but we shall take a glance at the work of three other outstanding astronomers of the time.

Jean Dominique Cassini (1675-1712), the first of the famous astronomers of that name, originally a professor of astronomy at Bologna, Italy, carried out many telescopic observations of the planets, though he did not limit his activities to study of these bodies. He noted the rotation of Mars and of Jupiter, and later, when at the Paris Observatory, discovered four new satellites of Saturn and also the principal division (known by his name) in the ring of that planet. He organized observations by himself and others of the planet Mars in order to find the parallax of the Sun, from which he derived a distance of 86 million miles.

At about the same time a Dutch astronomer, Christian Huyghens (1629-95), was using the telescope effectively and introducing an improved eyepiece.<sup>2</sup> He discovered the brightest one of Saturn's satellites, and explained the mysterious appendages of that planet, first noted by Galileo, as due to a flat ring surrounding it. He is also famous as a strong advocate of the undulatory theory of light.

The short survey just given brings us to the middle and later part of the seventeenth century, a period marked by the setting up of several great national observatories: Copenhagen (1631-56);

<sup>1</sup> See page 370.

<sup>2</sup> See pages 387-8.

Paris (1667-71); and Greenwich (1675), where John Flamsteed (1646-1720) was appointed as Astronomical Observer, later Astronomer Royal. From about this time astronomy may be said to have entered into the modern phase of investigation and discovery. Flamsteed did much notable work at Greenwich Observatory (which incidentally was designed by Christopher Wren), particularly in the production of a catalogue of positions of previously unheard-of accuracy of nearly 3,000 stars, and a reliable star atlas.

## 2. FROM FLAMSTEED TO MODERN TIMES

P. DOIG, F.R.A.S.

*Author of 'A Concise History of Astronomy'*

For this brief account of the progress of astronomy during a period of more than two centuries only a summarized sketch is possible in the available space. Some of the discoveries mentioned are, however, referred to, occasionally in more detail, in the various descriptive chapters of the book. A division into sections, rather than discursive treatment, is here chosen as more suitable for the purpose contemplated, namely, a concise statement of the principal results, and brief mention of some of the astronomers to whom they are chiefly due.

We begin with:

### INSTRUMENTS

The principal astronomical instrument is the telescope, by which light for the purpose of the study of the objects from which it comes can be collected in vastly larger amounts than pass through the pupil of the human eye. Prior to the period dealt with in this chapter, the best astronomical lenses were of small dimensions and comparatively poor defining powers. Beginning in the early seventeenth century with the 'opera-glass' type used by Galileo, whose most powerful instrument was far from equal in performance to a good modern hand telescope, the progress was mainly through non-achromatic types of great focal length, the long focal length counteracting to some extent the lack of achromatism, to small achromatic

refractors as invented and manufactured by John Dollond (1706-1761) and his successors, and to instruments of the metallic mirror type. The improvement of refracting telescopes with the essential step of combining crown glass and flint glass to bring the different coloured rays to the same focus, was first achieved by an English amateur, Chester More Hall, but the practical discovery and development was that of Dollond in the middle of the eighteenth century. A great handicap was the excise duty on glass, only removed in 1845, and the real rise to ultimate perfection was initiated by a Swiss artisan, Guinand, who mastered the difficulties of optical glass-making, and by the talents of a Bavarian, Joseph Fraunhofer (1787-1826), in using the glass thus produced. The reflecting telescope, which, of course, is achromatic, is almost entirely a British product, invented by Newton and by Gregory; it was improved by Hadley (1692-1744) and developed by James Short (1710-68), an Edinburgh optician, and by others, although little or nothing was achieved by the use of this form of telescope until the appearance of Frederic William Herschel (1738-1822).

This great astronomer was originally a Hanoverian musician who had come to England as a youth, prospering here as a music teacher and conductor, and becoming the organist of the Octagon Chapel at Bath, as well as concert manager there. Some time before this he determined to try to make and develop the reflecting telescope which he also intended to use in a thorough study of the objects of the sky. He became proficient both as a maker and user, and constructed many reflecting telescopes with metallic mirrors ranging from about 6 inches in aperture to a giant 4-foot one constructed with financial support from George III. This followed earlier benefactions by the king, who granted him a pension after his discovery of Uranus in 1781.<sup>1</sup> Subsequent makers of large telescopes were the Earl of Rosse (1800-67), who made a 3-foot and a 6-foot aperture telescope, and William Lassell (1800-81), who constructed a 2-foot and a 4-foot one. All these astronomers made important discoveries with their instruments. Another large telescope of the metallic reflector type, and about the last of the kind, was the 4-foot instrument constructed in 1870 for the Melbourne Observatory.

The next notable step was the use of glass, with a silver layer

<sup>1</sup> See pages 184 ff.

chemically deposited on it, for the mirrors. These were considerably more reflective, and when fifty or so years later an aluminium film took the place of the silver one, still more reflectivity for certain colours, and more permanence than with silver, were secured.

In the year 1918 the 100-inch reflector at Mount Wilson, California, was completed, and this was followed in 1928 by a project for a 200-inch one—the Hale telescope—now at Mount Palomar, but it took over twenty years to complete, partly owing to the war. Various other giants are now in operation, or in the course of construction, the latter including a 120-inch for the Lick Observatory and a 98-inch for the Royal Greenwich Observatory at Herstmonceux. The latter is to be of a type similar to that invented in 1930 by Bernhard Schmidt, who demonstrated that a large field of good definition—much larger than with the ordinary type—may be obtained by using a spherical mirror in combination with a glass plate shaped to correct the errors due to the use of a spherical instead of a paraboloidal mirror.<sup>1</sup> A number of Schmidt telescopes are now in operation, ranging up to one of 48-inch diameter at Mount Palomar. They are well adapted to the photography of large fields of stars and of external galaxies<sup>2</sup> and in other important researches.

Before the advent of the silver-on-glass reflector the difficulties due to the casting of large metallic mirrors, and their rapid deterioration, led to them being supplanted for a time by the refractor. This type advanced steadily in size, reaching its maximum towards the end of the nineteenth century with the 36-inch Lick and the 40-inch Yerkes refractors, the latter being still the biggest of the type. Star cameras with special constructions of lenses to secure larger fields were developed up to 20-inch and 24-inch apertures, while the ordinary long-focus refractor was adapted to photography by appropriate shaping of the lenses of its object glass, thus securing large-scale pictures for measurement.

The rapidity of progress has been much increased since the adoption of photography more than a hundred years ago, the first stellar photographs having been taken at Harvard in 1850. But the invention of the dry plate, introduced in 1880, instead of the wet collodion plate, led to a greater acceleration. Gradually all celestial objects—the Sun, the Moon, comets, meteors, planets, star

<sup>1</sup> See pages 376-7.

<sup>2</sup> See pages 349 ff.



fields and formations, and nebulae—were included, photography taking the place of the former laborious charting and drawing by eye, with the capacity for revealing faint objects by the cumulative effect of long exposures. Improvements in plate emulsions, shortening the times of exposure, or enabling photographs to be taken in red light, have recently been of the greatest importance. In addition, the modern application of photo-electric methods of observation has made possible the effective use of many telescopes of medium size in dealing with measurements of brightness of faint and distant stars.

The discovery of the compound nature of white light, and of the solar spectrum, by Newton is described in another chapter.<sup>1</sup> Subsequent experiments in 1752 by T. Melvil (1726–53) showed that light from flames tinged with metals or salts gave characteristic combinations of separate colours, and in 1823 Sir John Herschel suggested that this fact might be used to test for the presence of the substances concerned. W. H. Wollaston (1766–1828), using a narrow slit in front of the prism, observed seven dark lines in the solar spectrum in 1802, and in 1814–15 Fraunhofer studied the spectrum so thoroughly that he found 600, and mapped the positions of 324. Fraunhofer also examined the spectrum of the Moon, Venus, and Mars and several of the fixed stars. When artificial lights were similarly examined it was noticed that incandescent solids or liquids and (later) dense gases, gave a continuous spectrum, while incandescent gases of low density gave bright lines; it was also found that dark lines could be produced in continuous spectra by passing the light through various substances or through gases. Various explanations were advanced for this, but the first satisfactory one to be published was by G. A. Kirchhoff (1824–87) in 1859, who explained a prominent dark line (Fraunhofer's D) as due to absorption by sodium vapour, and hence deduced that this element was present in the Sun's atmosphere. Subsequently many lines of the solar spectrum were thus identified, nearly 70 of the 92 known elements being thus known to be present in the Sun.

In this way the science of astrophysics was begun, and in 1842 C. Doppler (1803–53) pointed out that the displacement of these spectral lines from their normal positions might be explained as due to movements of the body in whose spectrum they are found.<sup>2</sup>

<sup>1</sup> See pages 366–7.

<sup>2</sup> See pages 16–17.

In consequence an instrument was thus provided, not only for analysis, at a distance, of the chemical constitution of the atmospheres of celestial bodies, but also for measuring velocities in the line of sight.<sup>1</sup> The elaborate large spectrographs attached to our most powerful telescopes to-day are direct descendants of Newton's small glass prism.

Other descendants are to be found in the spectroheliograph and spectrohelioscope, instruments whereby studies of the Sun in light of any desired wave-length can be carried out by photography or vision, respectively.<sup>2</sup> These instruments were invented, the first by G. E. Hale and by H. A. Deslandres independently in 1891, the other (following an earlier suggestion by C. A. Young) by Hale in 1924. Motion pictures of solar phenomena of considerable value have been obtained by the application of cinema technique to the spectroheliograph.

Another type of instrument which may be mentioned is the Tower telescope for solar photography. The highest of these towers on which the object glass is mounted is 150 feet, and a full description of the instrument is given in Chapter IX, under the Coelostat.<sup>3</sup>

Many attempts to see or photograph the Sun's corona were made during the past sixty or seventy years, but no success was achieved until 1931 when Bernard Lyot of the Meudon Observatory, France, devised the coronagraph.<sup>4</sup> It is essential that this instrument should be used in the dust-free atmosphere of a high mountain.

There are other forms of instruments used in the measurement of positions of stars and other celestial objects, and of ingenious auxiliary aids which improve the results or make easier the work of the astronomer. For a description and history of development of these and of the various types of mounting of telescopes, special books on the subject should be consulted.

A recent development of fundamental importance, for the study of radio waves received from the Sun and from space generally, has been given the name radio astronomy;<sup>5</sup> and the technique of radar is now being applied to meteor research with most promising results.<sup>6</sup>

<sup>1</sup> See page 311.

<sup>4</sup> See page 68.

<sup>2</sup> See page 53.

<sup>5</sup> See pages 71, 356.

<sup>3</sup> See page 394.

<sup>6</sup> See pages 249–50.

## THE SOLAR SYSTEM

Under this heading it is proposed to deal very briefly with the major gravitational results. The appearance in 1687 of Newton's *Principia* indicated a completely new advance in knowledge. Galileo's discoveries in mechanics had made Newton's task a clear one, and planets and satellites could be treated as ordinary moving bodies. Newton's gravitational law is itself very simple, but its consequences are often highly complex and can be dealt with only by advanced mathematics, such as he had devised. Accordingly there was much in the movements in the solar system which required elucidation after Newton. His direct followers in this country did not develop his results to any great extent, mainly because of the difficult mathematical methods that he employed. New and more readily used analytical methods were devised on the Continent, largely by Leibnitz and the Bernouillis; and what Newton had begun L. Euler (1701-83), A. C. Clairaut (1713-65), J. D'Alembert (1717-83), J. L. Lagrange (1736-1813), and P. S. Laplace (1749-1827) carried out by showing the sufficiency of a single law to account for practically all the deviations of planetary or lunar motion from a simple ellipse.

Although repeatedly it almost seemed as if the law of gravitation was not correct, these mathematicians were always able to retrieve the position. Among the problems dealt with were the motion of Halley's Comet by Clairaut in 1758, the 'long inequality' of Jupiter and Saturn, shown to be due to their mutual disturbance, by Laplace in 1787, the Moon's acceleration, or slow quickening of its speed in its orbit round the Earth (first noted by Halley), demonstrated to be the result of a diminution of the eccentricity of the Earth's orbit (Laplace, 1787), and the essential stability of the planetary system (Lagrange and Laplace). These are only a few of the results which were embodied in Laplace's great work, *Mécanique céleste*, published 1799-1805. Since that time the work has been continued by many eminent mathematicians, amongst whom may be specially mentioned C. F. Gauss (1777-1855), U. J. J. Le Verrier (1811-77), J. C. Adams (1819-92), P. A. Hansen (1795-1864), S. Newcomb (1835-1909), G. W. Hill (1838-1914), E. W. Brown (1866-1938). What has been described as the 'crowning

distinction' of gravitational astronomy was the discovery of Neptune from the calculations of Adams and Le Verrier,<sup>1</sup> but there were many other important results, e.g. the connection of cometary orbits with those of some periodic meteors, the discovery of the slowing up of the Earth's rotation due to tidal action, values of the solar parallax from variations in the lunar motions, etc. During the present century much modification of physical theory has resulted from the theory of relativity first put forward by A. Einstein in 1905. There are astronomical consequences affecting the planetary motions, for according to the theory, the orbit of a planet, if not disturbed by other planets' attractions, will be strictly elliptical with the centre of gravity of the Sun and planetary system in one of the foci. But one effect of Einstein's theory is that this ellipse has a very slow rotation—the rate of rotation depending on the planet's distance from the Sun, which determines its orbital speed, and on the velocity of light. This effect is detectable only for Mercury because of its high orbital speed and the comparatively high eccentricity of its orbit—two conditions which are not fulfilled by any of the other planets. The amount of the rotation of Mercury's orbit has been found to be conformable to the theory of relativity.

The discovery of Pluto in 1930<sup>2</sup> as a consequence of a photographic search based on calculations by P. Lowell (1855-1916), using irregularities in the movements of Uranus, has been considered to have been the result of an extraordinary coincidence rather than of accuracy in computation. Recently, however, reasons have been advanced against the idea that the planet was found by 'pure chance,' and these call for suspended judgment on the matter.

## THE SUN

The first systematic observation of the Sun was probably made by C. Scheiner (1573-1650), half a century before the period considered in this chapter. Sunspots were known to the ancient Chinese as naked-eye objects, and were realized to be surface markings on the Sun after Galileo's time. But really serious and sustained solar observation does not seem to have been common until much later, except perhaps by Hevelius and J. D. Cassini;

<sup>1</sup> See pages 195 ff.<sup>2</sup> See pages 200-1.

and there was no general agreement as to the physical explanation of any of the phenomena noted. W. Herschel paid considerable attention to the Sun and developed a theory of its constitution similar to that advanced by A. Wilson (1714-86), professor of astronomy at Glasgow University. Wilson thought that 'the body of the Sun is made up of two kinds of matter, very different in their realities; and that by far the greater part is solid and dark with a thin covering of that resplendent substance from which the Sun would seem to derive the whole of his revivifying heat and energy.' Herschel agreed with this view; the spots were depressions below the general solar surface and cavities in the glowing 'photosphere' through which a darker, cool, solid globe is seen. These ideas certainly appear peculiar to modern astronomers, but we must not overlook the fact that Herschel's reasoning in this instance was based on ideas not unacceptable to contemporary scientists. He thought that the Sun's rays caused heat only by 'uniting with the matter of fire which is contained in the substances that are heated,' the matter of the Sun being 'of such a nature as not to be capable of any excessive affection from its own rays.' This peculiar view of the Sun's constitution held the field for nearly half a century before being dispelled by the result of the work of the spectroscope which showed its impossibility. Observations of eclipses of the Sun, up to well on in the nineteenth century, had been used chiefly for corrections to the movements of the Sun and Moon; but from the eclipse of July 8, 1842, the appearances surrounding the Sun—the 'corona' and the 'prominences'—began to be studied at all eclipses. At first many considered these to be lunar clouds lit up by the Sun, but before long it became clear that they were solar appendages. At about this time an epoch-making discovery was made by H. Schwabe (1789-1875) from a daily observation of sunspots for many years. He tabulated the number of spots and found by 1851 that there was strong evidence of a periodic cycle of approximately ten years, which examination of records and later observations increased to an average of 11.1 years. A similar period for the Earth's magnetic variations was noted by J. Lamont (1805-79) and by several others independently. The granulated structure of the Sun's surface seems to have been first detected in 1748 by J. Short, the optician, and it has been carefully studied by many workers since Herschel also noticed it at the end of the eighteenth century.

The earliest determination of the strength of solar radiation was made by John Herschel in 1837 and by the French physicist Pouillet in the same year. They got similar results, showing that the vertical rays of the Sun on each square centimetre of the Earth's surface raise the temperature of 1.76 grams of water through 1° C. per minute. The modern value for this 'solar constant' is about 10 per cent greater.

Solar research has been particularly active during the past three-quarters of a century in expeditions to observe eclipses and by day-to-day photography of the Sun's surface, while latterly the spectrograph and spectrohelioscope have been continuously in use to study the prominence phenomena and also the behaviour of clouds of luminous gas over the Sun's disk. Several important discoveries were made, notably by G. E. Hale, who found in 1908 that sunspots had magnetic fields. Other discoveries previously made were that the coronae visible at eclipses had a periodical change in form, with the same interval as the sunspots, the corona when spots were at a maximum being more evenly disposed around the disk. The bright streaks noticed on the face of the Sun, first seen by Scheiner and given the name 'faculae,' and the 'prominences,' have also an eleven-year period. The spots themselves were found by F. W. G. Spoerer (1822-95) to break out mostly at higher solar latitudes at the beginning of a cycle, tending to appear nearer and nearer to the solar equator as the cycle goes on; the cycles overlap to some extent, the new cycle commencing before the expiring one has completed its course. In 1912 Hale found the high latitude spots of the new cycle had magnetic polarities opposite to those of the low latitude spots of the previous cycle, and this was found to recur in the subsequent cycle. No completely satisfactory theory of sunspots and their cause has as yet been put forward.

A remarkable solar phenomenon was observed in 1859 by R. C. Carrington (1826-75) when he noted the outburst of two patches of intense light near some sunspots and lasting five minutes. This was accompanied by a disturbance of the Earth's magnetic forces and by auroral displays. Similar outbursts have been seen since. Recently, by means of the spectrohelioscope, such 'flares,' as they are called, have been found to be frequent, and a new branch of astronomy has been formed to study the accompanying electromagnetic disturbances on the Sun, which is then found to be sending



out radiation of a few centimetres to about 15 metres in wavelength. Apart from the intrinsic interest as physical phenomena, this study is important from the effects on radio transmission involved. Radio waves, which are reflected back to the Earth by the 'ionosphere,' are believed to be absorbed at the time of a flare, the ionized layer having been lowered by the increase in solar ultra-violet emission. The auroral displays are thought to be caused by the action of electrically charged particles shot out from the Sun at about 1,000 miles a second and coming into the Earth's magnetic field.

#### THE MOON

Among the earliest telescopic observers of the Moon were Hevelius, J. D. Cassini, and J. P. Riccioli (1598-1661). Hevelius wrote what was the first complete book on the Moon (1647), with drawings and maps, and he gave names to some of the lunar features, calling them after terrestrial seas, continents, capes, islands, and mountains, where he thought there was a resemblance. Langrenus (1600-75), a Belgian engineer, made a map of the Moon (1645), the earliest to show names of formations on it; but there were quite a number of more or less crude maps published in the seventeenth century, beginning with that of Galileo in 1610. Riccioli published a map, without names, with Grimaldi (1651), and he also printed a similar map with all the features on it named—over 200 of these names are still in use. He followed Hevelius in naming lunar mountains after terrestrial ones, and he gave the dark areas names, as seas, drawn from influences which the Moon was popularly supposed to have upon the Earth, those on the west side having suggestions of peaceful, clear weather, while those on the east referred to storms and rain. Like Langrenus, however, he gave the names of astronomers and other learned men to the craters, the ancients at the north, the moderns towards the south, grouping together as far as possible those whose studies had been similar or who had been active about the same epoch. Later 'selenographers' have usually followed the general scheme of Riccioli but have not always preserved the historical arrangement. More than a century afterwards J. H. Schröter (1745-1816) was the originator of systematic study of the Moon's physical features. He continuously observed and

charted the Moon's surface from 1785 to 1813, using telescopes of considerable power, while Herschel paid some attention to lunar formations and tried to make some measurements of the heights of some mountains.

Galileo had long before endeavoured to ascertain lunar heights by the observed distances between their lit-up summits and the 'terminator' where the Sun's rays just touched the more or less level surface. Herschel once thought that he had seen on the Moon's dark side lunar volcanoes actually in eruption, but this was certainly an observation of particularly bright spots illuminated by 'earthshine.' Later specialists in lunar work were W. G. Lohrmann (1796-1840), M. Beer (1797-1850), and J. H. von Mädler (1794-1874). Lohrmann was the first to measure heights of lunar mountains by the lengths of their shadows. In this he was followed by Beer and Mädler, working in conjunction, who determined positions and heights of more than a thousand mountains, four of which they found to be more than 20,000 feet high. The next outstanding selenographer was J. Schmidt (1825-84), who published in 1879 a large map 75 inches in diameter, showing 30,000 craters of all sizes. Among more modern lunar workers may be mentioned W. R. Birt (1804-81), E. Neison (1849-1940), T. G. Elger (1838-1897), L. Weinek (1848-1913), and W. Goodacre (1856-1938). All of these published drawings and maps, the last mentioned issuing in 1910 a map 77 inches in diameter, while H. P. Wilkins, an active selenographer of the present date, published a 200-inch map in 1932, and is now engaged in issuing a 300-inch one in sections. The Lunar Section of the British Astronomical Association, started by Elger and directed for many years by Goodacre, is now under Wilkins's leadership.

All authorities are agreed that the Moon possesses little or no atmosphere and that changes on its surface, if any, must be very slight. There is no general agreement, however, as to the origin of the various formations, particularly the craters, opinion being divided between various forms of volcanic origin and that they are the result of explosive impact of meteors. Mention should be made of the great assistance in lunar study provided by the magnificent photographs taken with large instruments at Lick, Paris, and Mount Wilson Observatories, and elsewhere, during the past sixty years or so.

## MERCURY

Observations of this planet other than of positions in the sky, for calculating a correct orbit, were not very frequent, owing to its unfavourable positions—never very far from the Sun. Schröter thought he found evidence of a considerable atmosphere and some high mountains; but neither of these results has been supported by any other observer. He believed the rotation period to be about the same as the Earth's, but Herschel found no such features and later observers recorded results similar to Herschel's. Nothing definite about its rotation period was known until 1882 when G. Schiaparelli (1835–1910), observing Mercury in daylight to reduce the atmospheric disturbance, inseparable from a low altitude of the planet, found a period of rotation of 88 days, i.e. the same as its period of revolution round the Sun. This has been supported by Lowell and by E. M. Antoniadi (1870–1944), using large refractors, and is now generally accepted. Mercury's mass is not very well known, being ascertained by its disturbing effects on the motion of certain comets. The temperature of its sunlit side has been found to be about 400° C.—hot enough to melt lead.

## VENUS

The disk markings being very vague and apparently changeable, rotation period results have been discordant. These have ranged from 23 hours to 225 days, the latter being the planet's period of revolution round the Sun. The shorter periods were obtained by Cassini (1668), Schröter (about 1800), E. de Vico (1841), Denning (1882), and others, the longest by Lowell. A period of a number of days is probable, judging by spectroscopic attempts to measure the line-of-sight velocities of the edges of the disk. Schröter thought he found evidence of high mountains, but this has not been supported by subsequent observers. The spectroscope has shown that the atmosphere of Venus has very little oxygen or water vapour, but in 1932 evidence of a considerable amount of carbon dioxide was found by Adams and Dunham at Mount Wilson, more than a hundred times the amount that exists in the Earth's atmosphere. The surface temperature of the part of the planet where the Sun is in the zenith has been estimated to be perhaps as high as 100° C.,

from the measurements by the thermocouple of Coblentz and Lamp-land, Nicholson and Pettit. The planet's mass has been estimated from its disturbing effect on Mercury, on the Earth, and on Mars.

## MARS

The markings on the disk were seen as far back as 1636 by Fontana of Naples and he suspected rotation. In 1666 R. Hooke (1635–1703) occasionally saw spots and inferred from their returns to visibility that the period was either 12 or 24 hours. At about the same time J. D. Cassini, and in 1704 G. F. Maraldi, obtained about 24 $\frac{2}{3}$  hours, which is very close to the truth. Herschel's observations began the modern telescopic study of the planet. In 1777–9 he noted the white polar caps, seen earlier by Maraldi, and their expansion in each Martian hemisphere's winter and contraction in summer, and inferred that they were snowy deposits 'from a considerable though moderate atmosphere.' He satisfied himself of the general permanence of the dark markings, in opposition to the rather surprising conclusions of Schröter that they were drifting clouds. This permanence was definitely established by Beer and Mädler from observations between 1830 and 1833. Prominent among active observers of Mars during the nineteenth century were W. R. Dawes (1799–1868), F. Kaiser (1808–72), J. N. Lockyer (1836–1920), and later G. Schiaparelli, P. Lowell, W. H. Pickering (1858–1938), E. M. Antoniadi (1870–1944), and T. E. R. Phillips (1868–1942). In 1877 Schiaparelli began an intensive study of the planet which lasted over thirteen years. In the first year he found that the brighter so-called continental areas were crossed by dark linear markings which he called 'canali' or channels, perhaps unfortunately translated as 'canals.' A few of these had been seen earlier by some of the observers mentioned above, but were then regarded only as straits. In 1879 and 1882 Schiaparelli noted the double appearance of some of them, and in 1892 Pickering found that the 'canals' crossed the dark areas as well as the bright parts, and consequently inferred that these dark areas could not be water. The objective existence of narrow linear canals is doubted by many, who consider that they are probably the visual impression given by more intricate details. It now appears that the problem is not likely to be solved by direct visual observation, and that perhaps

photographs with the very largest telescopes situated on high mountains (like the Mount Palomar 200-inch) will have to be employed. Recent spectroscopic work has shown that in the somewhat thin atmosphere which the planet undoubtedly possesses, where cloud-like forms are often visible, oxygen and water are scarce but carbon dioxide plentiful, and that the dark areas are possibly vegetation and the lighter parts desert. The noon surface temperatures at the equator of Mars are believed to reach  $10^{\circ}$  to  $20^{\circ}$  C. ( $50^{\circ}$  to  $68^{\circ}$  F.), but at the poles they may fall as low as  $-70^{\circ}$  C.

The two small satellites were discovered visually in 1877 by A. Hall (1829-1907) with a 26-inch aperture telescope, at Washington Observatory, U.S.A.

#### MINOR PLANETS

The chief events in planetary discovery in the past two hundred years have been the addition of Uranus, Neptune, and Pluto to the solar system. Other discoveries of planets of a much smaller size during the period are perhaps of equal importance with respect to theories of the origin of our solar system. The first of these finds was purely accidental when in January 1801 G. Piazzi (1746-1826) noted an eighth magnitude star in Taurus while making an observation in connection with an error he had found in a star catalogue. Its position was noted several times and he found it had moved among the stars, but as he fell ill shortly afterwards he did not get much information for the mathematicians to use in calculating an orbit. However, Gauss was equal to the task and, devising a method of computing an orbit from three observed positions, he found that the new planetoid moved in the space between Mars and Jupiter, which had been thought to be abnormally large since Kepler's time, and where a planet or planets might be expected to move according to an empirical law (Bode's law<sup>1</sup>), known to astronomers. A search had been organized by some German astronomers, but before the scheme had had any success Piazzi's new planet had been announced. Nine other similar bodies were discovered before 1850. By 1870 110 had been detected and 559 by 1900, the number being rapidly added to after photography was

<sup>1</sup> See pages 6-7.

introduced in 1891 as a means of detection. The diameters of the four brightest, Ceres, Pallas, Vesta, and Juno, measured in 1894-5 by Barnard with 36-inch and 40-inch telescopes, were found to range from 120 to 477 miles. The most useful of these bodies has quite recently proved to be small in size; this is Eros, which approaches the Earth close enough to be used in the determination of the solar parallax.<sup>1</sup> Several thousand are now known and many more are believed to exist. Some of them (Eros is one) give evidence of irregular shape, by variation in their light. The vast majority are very small, astronomically speaking, probably only a few miles or less in diameter.

#### JUPITER

The belt markings on this planet were evidently beyond the power of Galileo's telescope, but they were seen by N. Zucchi (1586-1670) and G. P. Zupi (1590-1650) about 1630. The planet's rotation and its greater rapidity at the equator were first noted by J. D. Cassini about 1665, and the ellipticity of its disk in 1691. Along with Hooke, Cassini was probably the first to observe the Red Spot,<sup>2</sup> which was closely observed during the past century, although sometimes disappearing. The different rates of rotation of the planet in latitudes, corresponding to high-velocity surface currents, and the changes in the surface markings, have been systematically recorded by a number of observers, among whom A. S. Williams (1861-1938) and T. E. R. Phillips and the amateurs of the Jupiter Section of the British Astronomical Association have been prominent, while a good beginning has been made in photography of the planet at Lick, Mount Wilson, and other observatories. For many years Jupiter was believed to have a comparatively high surface temperature, but radiometric measurements by Coblentz in 1914 and 1922 gave  $140^{\circ}$  C. below zero, which is about what would obtain with only solar radiation acting. The interpretation of the spectrum of the planet, with its bands in the orange and red, was given by R. Wildt in 1932, who showed that they are due to methane and ammonia. According to his theoretical work the internal constitution is a rocky metallic core with ice above

<sup>1</sup> See pages 5, 72, footnote.

<sup>2</sup> See page 153.



it, and above that again a layer of compressed hydrogen (chiefly), helium, and other gases,<sup>1</sup> which is, of course, all rather speculative. The planet's known satellites number twelve, the first four found by Galileo, the fifth in 1892 by E. E. Barnard (1857-1923), sixth and seventh by Perrine in 1904 and 1905, eighth in 1908 by P. J. Melotte, ninth, tenth, and eleventh (1914-38) by Nicholson, sixth, seventh, and ninth at Lick Observatory, eighth at Greenwich, and tenth and eleventh at Mount Wilson. All eleven have been seen with the largest telescopes, except the tenth; only the first five were discovered visually, the others by photographs with large instruments. A twelfth has recently been found by Nicholson from photographs with the 100-inch telescope at Mount Wilson.

## SATURN

With his imperfect telescope Galileo was never able to solve the problem of the mysterious appendages which at one time made Saturn look like three bodies joined together, while at another these appendages disappeared and it became one body. In 1656 C. Huyghens (1629-95), with better optical assistance, found them to be really a flat ring surrounding the planet, in which J. D. Cassini discovered (1675) the division known by his name. The latter astronomer was the first to note the belts on the ball of the planet, from markings on which Herschel, about a hundred years later, discovered the period of rotation to be about  $10\frac{1}{4}$  hours. An interior dusky ring was probably noted where it crossed the ball, by Cassini and others, but it was definitely discovered by Galle in 1838 and rediscovered by Lassell, W. C. Bond, and Dawes in 1850. In 1837 J. F. Encke (1791-1865) drew attention to a division or marking on the outer ring which, like several others noted at various times, seems to vary in distinctness. The constitution of these rings was, in 1857, proved mathematically by J. C. Maxwell (1831-79) to be of innumerable small bodies revolving in independent orbits round Saturn, a conclusion confirmed by J. E. Keeler's spectroscopic measurements of the line-of-sight velocities of the rings' different parts. Since 1900 observations by Barnard, Denning, Phillips, and others have shown that, as in Jupiter, Saturn's rotational periods increase with latitude. The planet's surface temperature, as

<sup>1</sup> See page 149 for a different view expressed quite recently.

measured by Coblentz, is  $150^{\circ}$  C. below zero and the spectrum shows a greater amount of methane than in Jupiter. The interior constitution has been calculated by Wildt to be similar to that of Jupiter. Of the nine satellites the largest was discovered by Huyghens in 1655, J. D. Cassini found four, Herschel two, and W. C. Bond and W. H. Pickering one each, only the last satellite mentioned having been discovered photographically.

## URANUS

The discovery of this planet by Herschel in 1781 is referred to elsewhere.<sup>1</sup> On its small elliptical bluish disk, belt markings have occasionally been seen. The period of rotation has been found spectrographically (Lowell, 1912, and Moore and Menzel, 1930) and also from its variation in light, caused by uneven surface brightness (Campbell, 1917). Its surface temperature is very low, the spectrum is like Jupiter's and Saturn's with stronger absorption, and its interior constitution is probably similar to that of these planets. There are five satellites, two found by Herschel (who thought he had seen six), two by Lassell, and one in 1948, photographed by G. P. Kuiper.

## NEPTUNE

Reference to discovery will be found elsewhere.<sup>2</sup> Its disk is also bluish in colour and belts on it have been reported but not confirmed. The period of rotation, about 16 hours, has been found spectroscopically (Moore and Menzel), and variability in its light has been thought to confirm the result. The spectrum is similar to that of the other giant planets with even stronger bands than in Uranus. The surface temperature is believed to be very low, probably lower than  $200^{\circ}$  C. below zero, and the internal constitution to be as in Jupiter, Saturn, and Uranus. There are two satellites, one discovered by Lassell, the other photographically in 1949 by Kuiper.

## PLUTO

After the discovery of Neptune by the calculations of Adams and Le Verrier, several astronomers made attempts to find still more

<sup>1</sup> See pages 184-5.

<sup>2</sup> See pages 194 ff.

remote planets. The discovery of Pluto was the results of calculations by P. H. Lowell, which had some support from work by W. H. Pickering. The actual finding is described elsewhere.<sup>1</sup> The angular diameter of its tiny disk was measured in 1950 by Kuiper, using the Hale 200-inch Mount Palomar reflector. The linear diameter corresponding to the angle measured is 3,600 miles, and if the mass were about that of the Earth the mean density would come out at nearly sixty times that of water—a most disconcerting result. A more probable value for the density would make the mass considerably less than that of the Earth.<sup>2</sup>

#### COMETS AND METEORS

Prior to the astronomical use of the telescope in the early part of the seventeenth century about 400 comets were recorded, but many more were found with optical aid some time afterwards, about one per year being discovered towards the end of the eighteenth century. After that about two per year were seen until the mid-nineteenth century; and since then the numbers detected have been greater with better telescopic assistance, and latterly with photography, so that more than 200 were found in the second half of the last century and a similar number in the following forty years. About one in five or six are bright enough to be naked-eye objects, but a much smaller proportion—perhaps one in fifty—becomes conspicuous.

The earliest telescopic observation of a comet seems to have been that of Cysatus (1588–1657) in 1618, and the first photograph was taken in 1881; but the first *discovery* of one by photography was by Barnard in 1892. In 1864 G. Donati (1826–73) was the pioneer of spectroscopic observation of a comet. A number of astronomers made 'comet hunting' a practice, notably Pons, Messier, Brooks, Barnard, Perrine, Swift, and Denning, whose discovery careers

<sup>1</sup> See page 201.

<sup>2</sup> The investigations of Brouwer and Wylie suggest that the mass of Pluto is about that of the Earth, but further evidence is necessary before any definite pronouncement can be made on the subject.

Quite recently it has been suggested that the real disk of Pluto may not be seen, but only 'specular' reflection from a frozen surface with diameter less than the actual diameter. If this should prove correct the real diameter of Pluto may be large enough to give a more normal density value. (See also page 203.)

spread over more than a hundred years, beginning near the end of the eighteenth century. In the chapter on Comets references will be found to other noteworthy workers and to the more remarkable comets. It was E. Halley (1656–1742) who first demonstrated the periodic nature of the appearance of some comets when he predicted the return in about 76 years of a bright one visible in 1682 (Halley's Comet).

Until about the nineteenth century the common idea about meteors was that they were meteorological in origin and due to ignition of atmospheric vapour. Halley's view was that they came from outside the Earth, but probably very few shared that idea. In 1794 the physicist E. F. Chladni (1756–1827) published the opinion that meteors come from outer space, becoming visible through incandescence on passing at high speed into the Earth's atmosphere. He got two students of Göttingen University, Brandes and Benzenberg, to observe some meteors at the same time from separate stations, and by means of the base line provided in this way, it was calculated that meteors appear at great heights, moving with high velocity. Some astronomers followed Laplace who, in 1802, published the opinion that meteors probably come from lunar craters, but after the extraordinary meteor shower of 1833, when large numbers appeared to radiate from a point in the constellation Leo, it was soon the accepted view that such meteors appeared moving in parallel paths round the Sun, their divergent tracks in the sky being the result of perspective. Later investigations showed that there are periodic streams of meteors which move in orbits around the Sun,<sup>1</sup> coming into view as showers from definite 'radiants' on particular dates, and that there are also meteors of a sporadic nature with no definite radiant points or dates for their appearance. Some of these periodic showers have been shown to have orbits the same as particular comets, a fact that was first demonstrated by Schiaparelli in 1866. Among prominent meteor investigators a few may be mentioned: E. Heis (1806–77), A. S. Herschel (1836–1907), W. F. Denning (1848–1931), and at present C. P. Olivier, F. L. Whipple, P. H. Millman, and J. P. M. Prentice. The application of radar technique by A. C. B. Lovell of Manchester University and his colleagues, and other groups of workers, has already been noticed.<sup>2</sup>

<sup>1</sup> See page 246 ff.

<sup>2</sup> See pages 249–50.

## THE STELLAR UNIVERSE

To astronomers like J. Flamsteed (1646-1720) and some of his contemporaries, the measurement of positions of stars for purposes of navigation and for fixing the places of the Sun, Moon, and planets with reference to them, with a view to determine accurate orbits in the solar system, was the principal task. To Flamsteed's successor as Astronomer Royal, Halley, there was rather more to be investigated than that, and to him we owe several discoveries and ideas of much value; e.g. the discovery of proper motions in the sky, suggested by changes in the positions of Sirius, Procyon, and Arcturus since Greek times, the observation of the globular clusters in Hercules and Centaurus, and the idea that nebulae, like the one in Orion, are composed of 'a lucid medium shining with its own proper lustre' and 'filling spaces immensely great.' These all formed points of departure towards modern knowledge. The third Astronomer Royal, J. Bradley (1693-1762), known for his great discoveries of the 'Aberration of Light' and the 'Nutation of the Earth's Axis,'<sup>1</sup> is also celebrated as the compiler of the material for a catalogue of accurate positions of 3,220 stars which, when published more than half a century later by F. W. Bessel (1784-1846) with the appreciative title *Fundamenta Astronomiae*, provided the necessary data for the advance of knowledge of the motions of the stars in the sky. An astronomer of a different type, John Michell (1724-93), was an amateur of strikingly original theoretical views. From considerations of mathematical probability he demonstrated that large numbers of double and multiple systems of stars would sooner or later be found to be physically connected, that stellar parallaxes must be generally much less than a second of arc, and he predicted values for angular diameters of stars of the order found by actual interferometer measurement<sup>2</sup> a century and a half later.

The work of Herschel in sidereal astronomy comes next for brief consideration. This astronomer, whose chief objective was an exploration or 'review of the heavens' as thorough as possible, actually completely reviewed the northern skies four times with reflectors of his own construction up to 18 inches aperture. He thus gathered materials for the publication of catalogues of star

<sup>1</sup> See page 445 and Appendix VIII.

<sup>2</sup> See pages 403-4.

clusters and nebulae, taking the place of the small catalogue of C. Messier (1730-1817), and forming the foundation of modern catalogues, and for lists of double stars which similarly made the basis of later ones. The outcome of this long-sustained work was epoch-making. Relative motion was noted, which proved beyond doubt the existence of many double and multiple physically connected star systems. By counting the number of stars in the field of his telescope pointed to different parts of the sky, and assuming greater extension in the direction of the richer fields of stars, he obtained the first rough idea of the shape of our Galaxy; and he also made correct speculations on the nature of the nebulae. In addition, by forming sequences of brightness of the naked-eye stars, he made a good attempt to establish a photometric system.

In the following century Bessel made (1838) the first reliable measurement of the parallax of a star,<sup>1</sup> a fifth magnitude one in the constellation of Cygnus, with a great proper motion that suggested proximity; other parallaxes were shortly afterwards obtained for  $\alpha$  Centauri (the nearest star) by T. Henderson (1798-1844), and for Vega by F. G. W. Struve (1793-1864). These small beginnings were not very rapidly followed up, only about 20 reliable parallaxes being known in 1880 and about 60 in 1900, although photography had been used from about 1886. By 1915 nearly 200 had been determined, by 1925 close on 2,000, and by 1950 about 10,000; so that progress has become much accelerated. After 1914 great additions to knowledge of stellar distances were made in consequence of the discovery by W. S. Adams and A. Kohlschütter, that certain lines in stellar spectra vary with a star's luminosity,<sup>2</sup> thus providing a means of measurement of the distances of many stars from their apparent brightness and real luminosity.

The application of the spectroscope to numbers of stars by W. Huggins (1824-1910), A. Secchi (1818-78), H. C. Vogel (1842-1907), and others, led to the classification systems which have resulted in the adoption of the one due to Harvard College Observatory<sup>3</sup> under the direction of E. C. Pickering (1846-1919).

With the information for luminosity of many stars and their spectral types thus obtained, the Giant and Dwarf classification was discovered by Russell and E. Hertzsprung, and the chemical composition and physical condition at the stars' surfaces, to be inferred

<sup>1</sup> See page 293.

<sup>2</sup> See pages 325 ff.

<sup>3</sup> See page 326.



from their spectra, were utilized to assist in theoretical work as to their interiors and on the generation of the energy radiated; also on speculation regarding stellar evolution.<sup>1</sup> Many physicists and mathematicians have been concerned with these problems, amongst whom we may mention A. S. Eddington (1882-1944), J. H. Jeans (1877-1946), K. Schwarzschild (1873-1916), E. A. Milne (1896-1950), H. A. Bethe, C. F. von Weizsäcker, G. Gamow—but there have been, of course, many others who have made material contributions.

The chief founders of double-star astronomy were the Herschels and F. G. W. Struve, others prominent in this branch being O. Struve (1819-1905), E. Dembowski (1815-81), S. W. Burnham (1838-1921), and R. G. Aitken, to name only a few. The systematic study of variable stars may be said to have been initiated by F. W. A. Argelander (1799-1875), and E. C. Pickering was perhaps his modern equivalent. Societies such as the British Astronomical Association and the American Association of Variable Star Observers have organized the eye-estimate work of amateurs on the long-period type stars; the other types have been more the province of the professional with his photometric equipment.

The derivation theoretically by Eddington about twenty-five years ago of a relation between mass and luminosity, and its agreement with known masses and luminosities, was of special importance, and it has a bearing on the question of the age of stars. Before then this age was believed to be of the order of billions of years, being based on the complete radiation of a star's mass, and not on the consumption of its hydrogen in the process now thought to produce stellar energy.<sup>2</sup> This latter would entail ages a thousand times as short, i.e. of the order of the thousands of millions of years found by geologists and physicists for the Earth.

The gaseous nature of the diffuse nebulae<sup>3</sup> was first definitely indicated by Huggins's spectroscopic examination of a number of specimens about 1864; but an acceptable explanation of their spectra was not forthcoming until I. S. Bowen showed in 1927 that the unidentified substances in the spectrum were due to atoms of familiar elements acting as is possible only in the extremely low densities prevalent in the nebulae.

The discovery during the present century that the dark clouds

<sup>1</sup> See pages 335-6.

<sup>2</sup> See pages 22-3, 335.

<sup>3</sup> See page 340 ff.

chiefly found in the Milky Way regions<sup>1</sup> are not vacuities among the stars but absorbing clouds of dust and gas, and later the demonstration by Trumpler and others that there is a general absorption of light in space, were of great practical importance in studies of the origin of stars and also of estimates of stellar distances.<sup>2</sup> The recent theories of L. Spitzer and B. J. Bok, that stars may originate from dust clouds, are worthy of the most careful consideration.

The ideas of extent and shape of our galactic system now current are ultimately based largely on the studies of J. C. Kapteyn (1851-1922) and H. Shapley, and the accepted theory of galactic rotation<sup>3</sup> is chiefly due to J. H. Oort and B. Lindblad, although, of course, many workers have been active in both subjects. This rotational movement is not to be confused with the solar motion in relation to the average of its neighbouring stars, first found by Herschel.<sup>4</sup>

The method of finding the distances of the nearer galaxies outside our own Galaxy by the use of the properties of Cepheid variables, first noted about 1910 by Miss Leavitt, has formed the foundation of the means of ascertaining still greater distances;<sup>5</sup> and the observed shift of lines to the red in the spectra of these external systems, which appears to be proportional to distance, and the assumption of an average luminosity of about 100 million Suns for each of them, have been useful in this connection. Among the chief workers in this field have been E. Hubble, H. Shapley, V. M. Slipher, and M. L. Humason. It is thought that the doubt as to whether the 'red shift'<sup>6</sup> is due to receding velocities or to the uniform increase in the wave-length of light through loss of energy in its path through space, may be resolvable by means of the results from the Hale 200-inch reflector at Mount Palomar.

*Note on Aberration (page 442).* This phenomenon is due to the fact that the speed of light is finite—about 186,283 miles per second. The orbital speed of the Earth is nearly 18.5 miles per second and in consequence of the combination of these two speeds the stars are apparently displaced towards the direction of the Earth's motion at any instant. A simple illustration is the necessity to hold an umbrella sloped towards the direction in which we are walking, even if the rain is falling vertically. It *appears* to fall in a slanting direction, and the faster we walk the greater appears the angle between the

<sup>1</sup> See page 343.

<sup>2</sup> See page 351.

<sup>3</sup> See page 348.

<sup>4</sup> See page 297.

<sup>5</sup> See page 317.

<sup>6</sup> See page 355.

direction of the rain and the vertical. The maximum value of the effect is about 20.5 seconds of arc, and when the star lies in front of or behind the direction of the Earth's motion it is zero. Aberration must be taken into consideration when accurate positions of the stars are required.

## HISTORY OF ASTRONOMY

- R. Grant: *A History of Physical Astronomy*, 1852.  
 A. Berry: *A Short History of Astronomy*, Murray, 1899.  
 Agnes Clerke: *A Popular History of Astronomy during the Nineteenth Century*, Black, fourth edition, 1902.  
 W. W. Bryant: *A History of Astronomy*, Methuen, 1907.  
 Sir T. Heath: *A History of Greek Astronomy to Aristarchus*, Clarendon Press, 1913.  
 R. L. Waterfield: *A Hundred Years of Astronomy*, Duckworth, 1938.  
 P. Doig: *A Concise History of Astronomy*, Chapman & Hall, 1950.  
 A. Armitage: *A Century of Astronomy*, Low, Marston & Co., 1950.

## BIOGRAPHICAL

- J. L. E. Dreyer: *Tycho Brahe*, Black, 1890.  
 R. S. Ball: *Great Astronomers*, Isbister, 1895.  
 Agnes Clerke: *The Herschels and Modern Astronomy*, Cassell, 1895.  
 J. J. Fahie: *Galileo, His Life and Work*, Murray, 1903.  
 H. C. Macpherson: *Makers of Astronomy* (Makers of Science Series), Oxford University Press, 1933.  
 L. T. More: *Isaac Newton: a Biography*, Scribner, 1934.  
 A. L. Lowell: *Biography of Percival Lowell*, Macmillan, 1936.

## NOTE ON THE CEPHEID VARIABLES

The current unit of distance based on Cepheid variables was calibrated about 35 years ago by H. Shapley from the study of Cepheid variables in our Galaxy. Within the last few years the work of Dr. W. Baade and his colleagues at Mount Wilson Observatory has shown that this unit is not accurate. Although its value is not yet exactly determined it is fairly certain that it must be increased by 60 to 100 per cent, and if the latter figure—believed to be nearer the true result—is accepted, the distances generally adopted for the external nebulae (see page 349) must be doubled. Thus the Great Nebula in Andromeda, the distance of which has been accepted as 815,000 light-years (see page 321), may be 1,630,000 light-years distant, and the computed distances of the others must be similarly doubled.

Another matter of special interest to the cosmologist arises—the age of the universe—which many believed to be a little less than 2,000 million years. If Baade's results are accepted—and it seems very probable that they will be—the age of the universe must be a little less than 4,000 million years.

## CHAPTER XI

## NAVIGATION

J. B. PARKER, M.A.,  
 and W. A. SCOTT, B.S.C., F.R.A.S.  
 (Member of the staff of H.M. Nautical Almanac Office)

## INTRODUCTION

NAVIGATION may be said to be the art of directing the course and fixing the position of a ship or aeroplane at any time throughout a voyage.

Prior to the fifteenth century astronomy as a navigational aid was chiefly a directional guide; in fact, the navigator 'steered by the stars,' but was unable to determine his position until he made a landfall.

Latitude could be determined roughly by taking observations of the pole star with a cross-staff, since the altitude of Polaris above the horizon is approximately equal to the latitude. A cross-staff (Fig. 148) consisted of a wooden staff  $AB$ , with a movable cross-piece  $CD$ ; it was used by moving  $CD$  along  $AB$  until, when sighting from  $A$ , the direction  $AD$  pointed to the horizon beneath Polaris and  $AC$  pointed to Polaris itself. The altitude of the star was then indicated at  $E$ .<sup>1</sup> Corrections to the observed altitude to give latitude were obtained by using a nocturnal (Fig. 149), which usually consisted of a disk on a handle, with a pointer capable of being rotated about the centre of the disk, a small hole being pierced through the centre; Polaris was sighted through the centre hole and the pointer rotated until a selected bright star, such as Kochab, appeared to lie on the edge of the pointer; the correction could then be read from the disk where it was crossed by the pointer.

<sup>1</sup> This is done on a scale graduated on  $AB$ , not shown in the diagram.

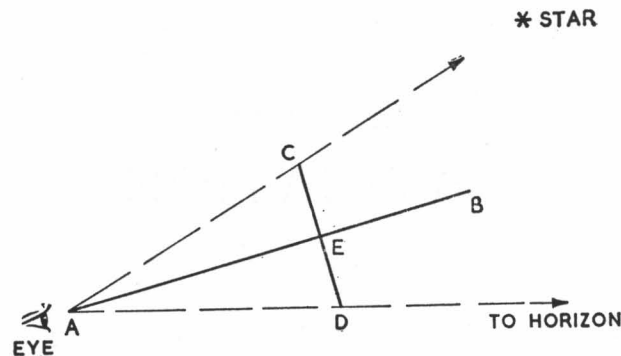

FIG. 148

With the advent of the great voyages of discovery, a method by which the navigator could fix his position on the surface of the

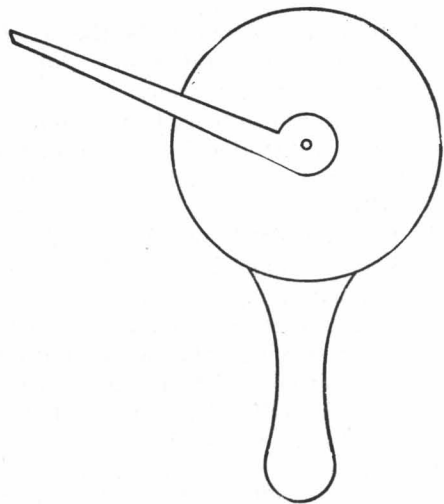

FIG. 149

Earth, when out of sight of land, became a real necessity. Prizes were offered in a number of countries for such methods and in Britain a Board of Longitude was established to examine all methods and suggestions for the improvement of navigation.

As early as 1474 Regiomontanus had suggested a method by which the longitude might be determined from observations of the angular distance of the Moon from fixed stars (lunar distances). The Moon, being comparatively close to the Earth and revolving round it in one month, moves approximately  $13^\circ$  per day across the background of fixed stars. The position of the Moon with respect to the stars therefore acts as a clock to indicate the time and a knowledge of the time enables the longitude to be determined. This method, however, requires the positions of the Moon and stars to be known very exactly. Unfortunately these were not known with sufficient accuracy at that time to be of real use.

In order to improve the knowledge of the positions of the heavenly bodies, the Royal Observatory at Greenwich was founded in 1675 by order of King Charles II; observations could then be made and the theory of the motions of the heavenly bodies examined to provide better tables for the prediction of future positions.

The invention in the middle of the eighteenth century of the sextant, by which altitudes could be more easily measured, of the chronometer, for the accurate measurement of time, and the publication of tables of the Moon (based on observations made at Greenwich), together with the introduction of the *Nautical Almanac*, gave the navigator the tools necessary to determine his position from astronomical observations.

It was the discovery by Captain Sumner in 1837, that a single observation of the altitude of a heavenly body would give a position line, that forms the basis of modern navigation. Sumner showed that in order to be able to observe a star at a given altitude, the position of the observer, at the time of observation, must be on a fixed circle (position circle); in practice the radius of this circle is generally so large that the relevant portion of it can be plotted on the chart as a straight line (position line). The observation of a second star gives a second position line and the intersection of these two position lines fixes the position of the observer.

The methods of reducing the observations used in Sumner's method were rather lengthy, and in 1875 a method was suggested by Marcq St. Hilaire which was gradually to become standard and is the main method in use to-day.



## AIMS

There are many methods that the modern navigator can adopt in order to make good a track between two points on the Earth's surface. Celestial navigation is only one such method; in certain circumstances, as in a flight within visual sight of the ground, it would not be used. Nevertheless, the occasions when astronomical methods are of value (sometimes, in fact, no other aids to navigation are available) are so frequent that every navigator, by sea or by air, has a working knowledge of the principles involved.

The aim of navigation can be regarded as the successful direction of a vessel towards its destination in the teeth of elements whose effects on the vessel's motion must be continually determined. In sea navigation these elements are tide and wind; in air navigation wind is the only extraneous force which must be estimated by the navigator in order to make good his destination.

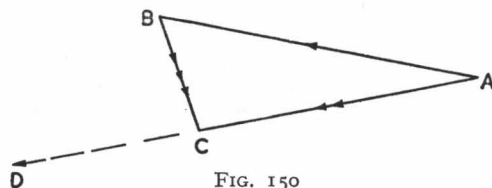

FIG. 150

A navigator calculates a course to steer in order that the vessel should track along a given route; it will clearly not suffice simply to head the bows of the vessel (ship or aircraft) towards the destination, unless the tide, current, or wind is acting directly against, or directly behind, the vessel. The problem can in fact be summarized by drawing the *vector triangle ABC* (Fig. 150). Here *A* is the vessel's point of departure, and *AD* the required track, *D* being the destination. *C* is taken to be that point on *AD* which would, provided the correct course and speed were maintained, be the vessel's position after an hour's voyaging. In the absence of any wind, current, or other influence, the vessel would have been at *B* after an hour; the line *BC* therefore represents the magnitude and direction of the influence at work. The vessel, in order to make good the track *AD*, must be headed in the direction of *B*; the offset angle, or, as it is more properly called, the *drift* must be calculated and applied to the known direction *AD* (which can be measured

on a chart). The angle of drift can be determined (if the effect of the influence in magnitude and direction is known) either by plotting, by trigonometry, or by a special instrument (computer) designed to solve the problem.

The essence of navigation is the determination of the magnitude and direction of *BC*. At the start of a voyage the navigator sets course on an assumed value of this vector, but whenever he establishes his position he can test this assumed value by comparing his determined position with what it would be if no outside effect were present (this latter position, a 'still-conditions' position, can be continuously and automatically recorded, or alternatively simply calculated from a knowledge of the vessel's speed and course). The difference between these two positions measures the size and direction of the outside effect; if it is quite different from that forecast an alteration of course may be necessary in order to attain the destination.

At any time a navigator can calculate his *D.R. position* (*D.R.* = 'dead,' or deduced, reckoning), which is his best possible estimate of the vessel's position. To do this he finds, first, the 'still-conditions' position, using his last reliable independently found position, or *fix*, as origin (the point corresponding to *A* in Fig. 150); next the effect of the outside influence, as estimated by the navigator from his last *fix* (or otherwise), is laid off for the appropriate time. The resulting position is called the *D.R. position*. Clearly the accuracy of such a position will deteriorate as the time since the last independently established position (*fix*) increases. Thus fixing is of vital importance, not only to check whether or not the vessel is maintaining its correct track, but more exactly for framing conclusions about the nature of the wind or current affecting the vessel's motion. Such conclusions are drawn by the conscientious navigator at every opportunity.

This, the problem of position finding, or fixing, is the main navigational problem to which astronomical methods are applied. The observer selects two or more suitable stars and measures their *altitudes* (angular heights as measured from the horizontal) by means of a sextant. The times of these measurements are noted to the nearest second and, after some calculations, the position of the observer is found. On occasions, as when the vessel's compass is suspect, or when navigating in polar regions where the horizontal

component of the Earth's magnetic field is so weak that the magnetic compass is unsuitable for navigation, use is made of the known bearing of a heavenly body in order to check the vessel's course. To illustrate the role of astronomy in navigation, the basic elements will be reviewed in the next section.

#### PRINCIPLES OF ASTRONOMICAL NAVIGATION

To an observer viewing the heavens on a cloudless night, it will appear that the sky resembles a vast hemisphere studded by the celestial bodies. As time progresses the stars will appear to move their positions, and the effect is as if the sphere is continuously but slowly rotating. This conception, the *celestial sphere*, is of great importance in astronomy. For navigational purposes it is convenient to regard the centre of the sphere as situated at the *centre* of the Earth, but to the observer it appears as if he himself is at the centre. By adopting the centre of the Earth as the centre of the celestial sphere in astronomical navigation problems, the difficulty of different spheres existing for each observer is removed; and since in general the heavenly bodies are at such vast distances from the Earth, the altitude of a body as viewed from the surface

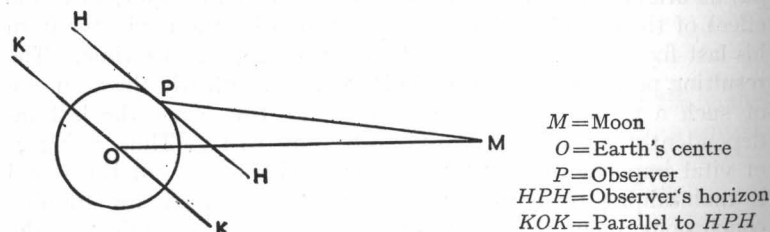

Difference in altitudes is  $\widehat{MOK} - \widehat{MPH} = \widehat{PMO}$ , Parallax in Altitude

FIG. 151

of the Earth is quite accurate enough. The exception is the Moon, whose distance from the Earth is relatively small; here separate corrections must be made to allow for the difference between the altitude as found by the observer and that which would be obtained at the centre of the Earth. This correction is known as the *Moon's Parallax in Altitude* and is shown diagrammatically in Fig. 151.

With this one exception, the concept of the celestial sphere is a

convenient one for purposes of navigation. As the night draws on the sphere can be regarded as rotating about an axis, or, equivalently, the sphere can be imagined as a fixture, while the Earth rotates inside it. At a given instant of time there is a correspondence between the points on the Earth's surface and those on the surface of the celestial sphere, points on a given radius corresponding to each other.

Fig. 152 represents the celestial sphere.  $Z$  is the observer's zenith, the point in the sky directly overhead. The line joining  $O$ , the Earth's centre, to the observer's position will meet the celestial sphere at  $Z$ , so that the observer's position and  $Z$  are corresponding points in the sense defined above.  $X$  represents the position of a heavenly body, while  $P$  is the pole, or extremity of the axis of rotation, nearer  $Z$ .

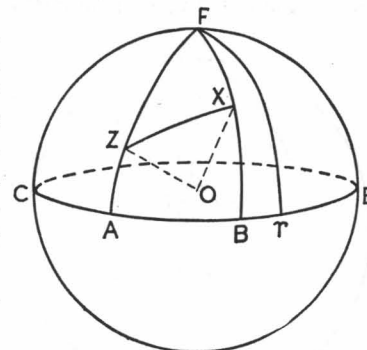

FIG. 152

The three points  $P, Z, X$ , form a triangle on the surface of the sphere (a *spherical triangle*). Just as, on a plane, the shortest distance between two points is a straight line, so on a sphere the shortest distance is along the arc of the circle whose centre is that of the sphere, and which passes through each of the two points. Such a circle is called a *great circle*; it can be regarded as the intersection of the sphere with a plane drawn through the sphere's centre. Distances along a great circle are measured by the angle that the extremities of the arc subtend at the centre; thus the distance  $PZ$  in Fig. 152 is measured by the angle  $POZ$ . The angle at the vertex of a triangle is defined as the angle between the tangents to the two great circle arcs intersecting at that vertex. The sides of a spherical triangle are great circle arcs.

As in plane geometry, trigonometrical formulae can be developed enabling the relationship between any four of the six elements of the triangle (the three sides and the three angles) to be obtained. In spherical geometry, however, all distances are measured in angles; a further difference is that the three angles in a spherical triangle no longer add up to two right angles.

To the triangle  $PZX$  on the celestial sphere there will correspond a precisely similar triangle on the Earth's surface (Fig. 153).  $P'$  will be the pole nearer the observer,  $Z'$  the observer's position, while  $X'$  is the point vertically underneath the celestial body (*substellar point*).

All the six elements of the triangle  $P'Z'X'$  are equal to those of the triangle  $PZX$ , and navigational problems can be visualized in terms of either triangle.

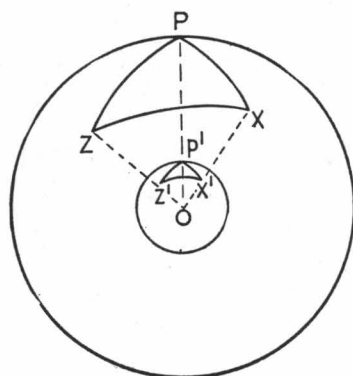

FIG. 153

In Fig. 152  $CE$  is the *celestial equator* (the great circle corresponding to the equator on the Earth's surface). The great circle arcs  $PZ$  and  $PX$  will, when produced, cut the celestial equator in two points,  $A$  and  $B$  respectively. Remembering that to every point on the celestial sphere there is a corresponding point on the Earth's surface, it is not difficult to see that the arc  $AZ$  is the observer's latitude, while  $BX$  is the latitude of the substellar point.

The following are the elements of the triangle  $PZX$ , which plays as basic a part in astronomical navigation as the vector triangle in Fig. 150 plays in the theory of dead reckoning:

$$\begin{aligned} PZ &= \text{colatitude} = 90^\circ - \text{latitude} && = 90^\circ - \phi \\ PX &= \text{codeclination} = 90^\circ - \text{dec.} && = 90^\circ - \delta \\ ZX &= \text{zenith distance (or coaltitude)} = 90^\circ - \text{alt.} = 90^\circ - H \\ 360^\circ - \widehat{ZPX} &= \text{local hour angle} && = h \\ \widehat{PZX} &= \text{azimuth} && = A \\ \widehat{PXZ} &= \text{parallactic angle} \end{aligned}$$

*The Colatitude.* The latitude of the observer,  $\phi$ , is represented by  $AZ$  in Fig. 152. Since  $CE$  is the celestial equator,  $\widehat{POA}$  is a right angle, so that  $PZ = 90^\circ - AZ = 90^\circ - \phi$ .

*The Codeclination.* The latitude of the body's substellar point is

equal to  $XB$ . This angle is known as the declination of the body;  $PB$  is  $90^\circ$ , so that  $PX = 90^\circ - XB = 90^\circ - \delta$ .

*The Zenith Distance.* The zenith distance of a body is the angle between its direction (as viewed by an observer on the Earth's surface) and the observer's zenith. It is  $90^\circ$  minus the altitude (the angle measured by the navigator after correction).

*The Local Hour Angle.* Hour angle is the generic name given to the angle at the pole between the *meridian* of a body (i.e. the great circle through the body and the two poles) and a datum meridian. If this datum is the observer's meridian, the angle is called the local hour angle. Hour angles are measured through  $360^\circ$ , positively to the west of the datum meridian; thus in Fig. 153,  $\widehat{ZPX} = 360^\circ - \text{hour angle } (h)$ .

*The Azimuth.* The azimuth is the direction of the heavenly body when referred to the observer's meridian as datum. It is measured in a clockwise direction through  $360^\circ$  from the observer's true north.

*The Parallactic Angle* is the third angle of the spherical triangle  $PZX$  but is seldom used in navigational work.

The description of the component parts of the spherical triangle has introduced the terms *declination* and *hour angle*, positional co-ordinates which are applied to a celestial body in much the same way as latitude and longitude are applied to the position of an observer on the Earth's surface. In fact, the declination is another name for the latitude of the star's substellar point, while the hour angle is equal to the longitude of the star's substellar point if the datum meridian is taken to be the meridian of Greenwich (in this case, the hour angle is known as the *Greenwich hour angle*). On the Earth it is customary to work with a fixed datum, that of Greenwich, but on the celestial sphere it would for many purposes be unsuitable to use a datum whose position was changing continuously as the Earth rotates. For this reason it is convenient to define a new datum, *fixed in the celestial sphere*. This datum is the hour circle of the *first point of Aries* ( $\gamma$ ), which is a fixed point on the celestial equator (Fig. 152). All hour angles when measured from this datum are known as *sidereal hour angles* (Latin, *sidus* = a star).



Evidently it would not be practicable to use this datum for measuring position on the Earth; for since the Earth rotates relative to the celestial sphere, the sidereal hour angle of an observer at a fixed point on the Earth's surface is continuously changing. On the celestial sphere, however, the meridian of  $\varphi$  and the celestial equator provide a framework whereby the positions of all fixed stars can be measured. The declinations and sidereal hour angles of heavenly bodies can be tabulated and, for the stars, remain virtually unchanged over long periods of time; long-term effects, due to precession and nutation,<sup>1</sup> do, however, cause small alterations in both the declinations and the sidereal hour angles of the stars. The planets, Sun, and Moon do not fall under the category of fixed stars and must be considered separately.

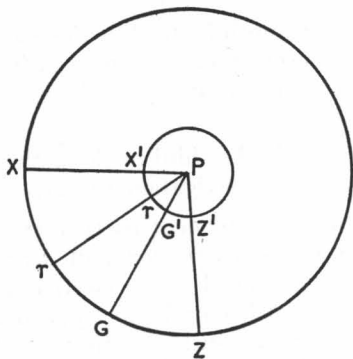

FIG. 154

From the remarks above it appears that there is an intimate relation between hour angle, longitude, and the Earth's rotation (or, its equivalent, time). This relationship is illustrated in Fig. 154.

In this diagram the inner circle represents the Earth's equator, the centre point,  $P$ , being the pole; it is as if an observer were looking down at the Earth's pole from a very great distance. The outer circle represents the celestial equator, and all unprimed letters refer to the celestial sphere. All lines radiating from  $P$  are meridians (or, alternatively, hour circles).

On the celestial sphere  $X$  is the point where the star's vertical

<sup>1</sup> See Appendix VIII.

circle cuts the celestial equator (the point  $B$  of Fig. 152).  $\varphi$  is the First Point of Aries, and  $G$  the projection of the point on the Earth whose latitude and longitude are zero;  $Z$  is the intersection of the observer's hour circle with the celestial equator.

By definition, Sidereal hour angle of  $X = \widehat{XP\varphi}$

Greenwich hour angle of  $X = \widehat{XPG}$   
 $= \widehat{X'PG'}$ , the longitude (measured westwards) of the substellar point  $X'$

Local hour angle of  $X = \widehat{XPZ}$

Greenwich hour angle of  $\varphi = \widehat{\varphi PG}$

Longitude of  $Z'$  (East)  $= \widehat{G'PZ'} = \widehat{GPZ} = 360^\circ -$   
 Greenwich hour angle of  $Z$ .

The Earth rotates once per day, or  $15^\circ$  per hour, so that the relative positions of these points do not all remain fixed.  $X$  and  $\varphi$  are, of course, fixed points on the celestial sphere, but both  $G$  and  $Z$  rotate with the Earth. The angle  $\varphi PG$  in fact measures the Earth's rotation, for  $\varphi$  is a fixed reference point on the celestial sphere, while  $G'$  is a fixed reference point on the Earth's surface.

The angle of interest to the navigator is the angle  $ZPX$  in the spherical triangle (Fig. 152); this is the local hour angle of the body. It is convenient to divide it into three parts, one of which is the sidereal hour angle of  $X$ , and is that part of the angle which is fixed

on the celestial sphere; the second part is  $\widehat{\varphi PG}$ , the Greenwich hour angle of  $\varphi$ , which is that part of the angle due to the rotation of the Earth; while the third part,  $\widehat{GPZ}$ , is the observer's longitude, or that part of the angle that is fixed on the Earth. Algebraically:

$$\text{L.H.A. } X = \text{S.H.A. } X + \text{G.H.A. } \varphi + \text{Long. (East)}$$

$$\widehat{ZPX} = \widehat{\varphi PX} + \widehat{GP\varphi} + \widehat{ZPG}$$

$$= \text{G.H.A. } X + \widehat{ZPG}$$

Note that East longitudes must be *added* to G.H.A.  $X$  to get L.H.A.  $X$ ; West longitudes are *subtracted*.

For a fixed star the first part of the required angle is known; the second part can be tabulated against time. The third part is simply the longitude of the observer.

For bodies which are not fixed on the celestial sphere, the sidereal hour angles are no longer fixed quantities. Now there is no advantage in resolving the required angle into three parts, two of which are variable; instead the two variable parts are taken together (to form the Greenwich hour angle) and tabulated. The determination of local hour angle therefore requires only one appeal to navigational tables in any case.

The *Abridged Nautical Almanac* (see page 474), which is published each year (and its air counterpart, the *Air Almanac* (see page 476)), tabulates these quantities required in navigation. For the fixed stars, sidereal hour angle and declination are given; these change so slowly that they need only be quoted monthly (once in four months for the *Air Almanac*). The positions of the Sun, Moon, and planets are also given; since these are not fixed stars, their *Greenwich* (not *sidereal*) hour angles are tabulated at frequent intervals, together with their declinations. The interval of tabulation is one hour for the *Abridged Nautical Almanac* (*A.N.A.*) and ten minutes for the *Air Almanac* (*A.A.*). Both almanacs also contain tables of G.H.A.  $\varphi$ , at the same tabular intervals, for use with the fixed stars. As has been noted, this angle moves through about  $15^\circ$  per hour, or one minute of arc every four seconds of time. Hence an error of four seconds results in an error in hour angle of one minute of arc, which can cause the position line to be in error by one nautical mile. The importance of accurate timekeeping cannot be too strongly stressed. Other information, of a miscellaneous nature, is also included; for example, the times of sunset and sunrise, refraction corrections, and interpolation tables are all of assistance to the navigator. The Moon's parallax in altitude is also listed in these almanacs.

Returning to Fig. 152, it has been shown how the navigator, with the aid of the almanac, can determine the position of the heavenly body  $X$ . Measurement of the altitude by means of a sextant establishes the distance  $ZX$ , and the hour angle,  $\widehat{ZPX}$ , is obtained from the appropriate almanac.

The following formula of spherical trigonometry connects the

observer's latitude ( $\phi$ ) with hour angle ( $h$ ), the declination ( $\delta$ ) of the body and its observed altitude ( $H$ ):

$$\sin H = \sin \phi \sin \delta + \cos \phi \cos \delta \cos h.$$

To obtain positional information, the observer could *assume* a longitude which would enable the local hour angle,  $h$ , to be calculated. Knowing  $\delta$ , the declination (which is tabulated), and  $H$  (which is given by the sextant), this equation would yield  $\phi$ , the latitude. By repeating the process for different assumed longitudes, the navigator could establish his position as being somewhere on a curve. (This curve would, in fact, be a circle drawn on the surface of the celestial sphere, whose radius is the measured distance  $ZX$ .) The measurement of the altitude of a second star would yield a second curve, so that a fix could be obtained where the two curves intersect.

In practice the method of solution does not follow quite these lines. Instead the procedure is reversed; a *position* (i.e. both latitude and longitude) is assumed, and the value of  $H$  corresponding to this position is obtained (either by direct computation using the above or a similar formula, or by recourse to special tables). This value of  $H$  is compared with that actually observed; any difference is due to the navigator not being at the assumed position. This difference (called the *intercept*), and the star's azimuth ( $A$ ), which may be found from tables or by means of a second trigonometrical formula:

$$\cot A \sin h = \tan \delta \cos \phi - \cos h \sin \phi$$

are used to plot what is known as the *position line*. This is a straight line drawn on the navigator's chart and is, in effect, an approximation to an arc of the circle, centre  $X$  and radius  $ZX$ , the arc being near the position of the observer.

Both at sea and in the air it is usual for the navigator to be provided with tables as well as with an almanac. There are many such tables extant based on several different principles; in many of these an assumed position is adopted by the navigator, the latitude of which is the whole degree nearest his D.R. latitude. The longitude is so chosen that the local hour angle adds up to a whole degree, consistent with the assumed longitude being as near as possible to the D.R. longitude.

The tables (known as *Sight Reduction Tables*) are then entered. These tables contain values of altitude and azimuth as functions of latitude, declination, and hour angle (local or Greenwich hour angle can be employed); part of a specimen page of H.O. 214 is reproduced on page 478. This table is designed for the reduction of celestial observations made at sea. For air navigation H.O. 249 (page 479) can be used for stellar observations; it gives the best selection of six stars arranged in order of azimuth and tabulates, for each degree of latitude and of L.H.A.  $\varphi$  ( $=G.H.A. \varphi + E$  longitude), the altitude and azimuth for each selected star. L.H.A.  $\varphi$  can be used as argument, as the S.H.A. and declination of the stars remain sensibly constant for a few years.

Having obtained the altitude and azimuth of the heavenly body appropriate to his assumed position, the navigator proceeds to plot his position line. The following method, due to Marcq St. Hilaire, is nowadays in practically universal use.

From the assumed position on the chart,  $P$ , draw a line  $PX$ , in the direction of the star  $X$ . This is done by making the angle  $NPX$  equal to the azimuth of the body as found from the tables. Next find the intercept, the difference between the observed altitude and that given by the tables; if this is positive measure this distance,  $PI$ , in nautical miles (1 nautical mile = 1 minute of latitude) along  $PX$  towards  $X$ . The position line is then a line through  $I$  perpendicular to  $PX$  (Fig. 155). If the intercept were negative the distance would be measured from  $P$  away from  $X$ .

In Fig. 155  $PX$  is the 'tabulated zenith-distance,' i.e.  $90^\circ$  minus the altitude found from the tables and  $IX$  ( $=PX - PI$ ) is the observed zenith-distance. The position line therefore represents the circle, centre  $X$  and radius  $XZ$  (Fig. 152) as a straight line through  $I$ , whose distance from  $X$  is  $90^\circ$  minus the observed altitude. This attempt to represent a circle by the tangent at a point on it is accurate enough for navigational purposes in the vicinity of the point itself, provided that the distance  $IX$  is large and the true position lies not far from the point  $I$ ; the error introduced will depend not only on this distance but also upon the type and scale of chart employed.

Having obtained a position line, the navigator may make an observation on a different star, thereby determining a second position line. The intersection of these two is not the true position

since some allowance must be made for the travel of the vessel between the two times at which observations were taken. In

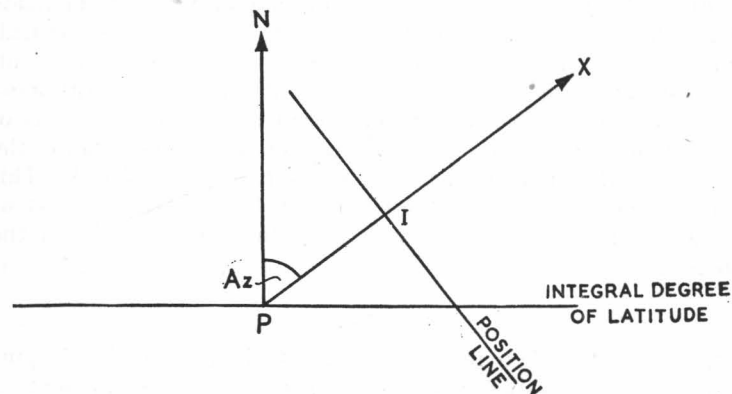

FIG. 155

practice this can be done, if the speed and track of the vessel are roughly known, by moving the earlier position line parallel to itself so that the portion of the track between the two parallel position

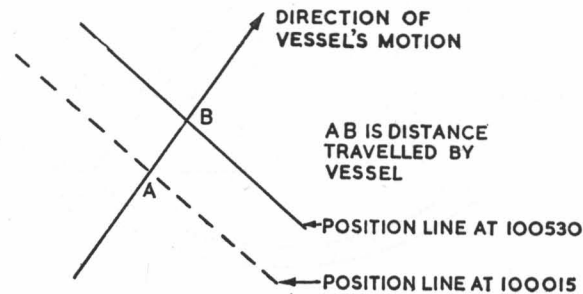

FIG. 156

lines is equal to the distance travelled in the time between the sights. (See Fig. 156.) Thus if the pecked line represents the position line near ten o'clock, the time of the first observation, the position line at just over five minutes past ten is obtained by displacing it at a distance  $AB$  along the direction of the vessel's



motion corresponding to the mileage made good in that difference in time.

Other adjustments of a minor nature may also have to be made (particularly in the air) before an accurate position is established. Refraction of light-rays through the air (or through the glass of an astrodome) must be taken into account, particularly at low altitudes; and for fast moving vessels, such as aircraft, the combined effect of the motion of the observer and the rotation of the Earth causes the vertical, as determined by the air sextant, to be displaced. This displacement, known as the *Coriolis* effect, is equivalent to an error in the observed altitude, and its magnitude is tabulated in the *Air Almanac*.

## EQUIPMENT

In order to be able to make astronomical observations for the purpose of fixing position a navigator needs certain equipment—a sextant with which to measure the altitudes of the heavenly bodies

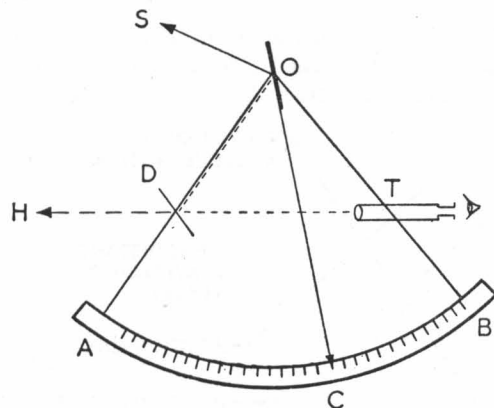

FIG. 157

and a chronometer or timepiece in order to be able to determine accurately the time at which the observations are made.

The sextant used on board ships, termed a marine sextant, consists of a frame  $OAB$ ,  $AB$  being the arc of a circle centred at  $O$ ; a telescope  $T$ , and a fixed mirror  $D$ , are mounted on the frame and an arm,  $OC$ , carries a second mirror at  $O$ . The telescope and mirrors

are so adjusted that a ray of light from a star falling on  $O$  can, by altering the position of the arm  $OC$ , be reflected on to the mirror  $D$  which in turn reflects the light into the telescope. (See Fig. 157.)

The mirror  $D$  is only silvered over one half of its surface, so that on looking through the telescope some rays of light are allowed to pass through it, permitting observation through  $D$  of the distant horizon and at the same time of a star by reflection from  $O$  and  $D$ . An observation of altitude consists of observing when the reflected image of the star appears level with the direct image of the horizon (Fig. 158); the altitude can then be read by the indication of  $C$  on the arc  $AB$ . A marine sextant can usually be read to about one-tenth of a minute of arc.

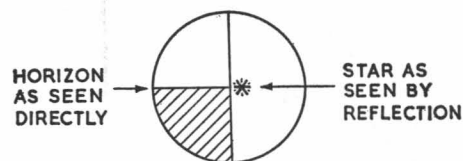

FIG. 158

Unfortunately the altitude measured with a sextant needs the following corrections:

- The correction for index error; this is usually a small correction and is due to slight imperfections in the manufacture of the instrument, or wear.
- The correction for dip; this is necessary because the observations are made at a height above sea level and therefore the observer does not view the horizon in a truly horizontal direction, but his line of sight is slightly downwards; the observed altitude is too great and the correction has to be subtracted.
- The refraction correction, due to the fact that the observations are made through the Earth's atmosphere, which bends the light so that objects appear at a greater altitude than they really are; this correction must also be subtracted from the observed altitude.
- The correction for semi-diameter when observations are made of the upper or lower limb (edge) of the Sun or the Moon.
- The correction for parallax—this has already been explained and must be added to the observed altitude (Moon sights only).

For observing the altitudes of celestial bodies from aircraft a bubble sextant is generally used; this uses the principle of the spirit-level to determine the horizontal plane from which to measure the altitudes. On looking through the bubble *A* (Fig. 159), the reflection of the light from the star *S* can be observed if the mirror *B* is correctly tilted; a graduated scale at *B* will then permit the altitude

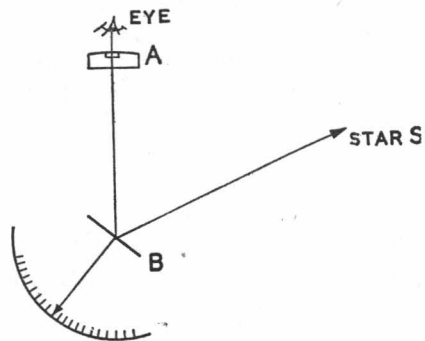

FIG. 159

of the star to be measured. In actual construction the bubble sextant is quite complicated and the observer is able to look into the instrument in a horizontal direction. Bubble sextants are made to record the mean reading of the altitude over a period of one or two minutes in order to average out some of the effects due to the accelerations of the aircraft.

Observations made with a bubble sextant do not need correction for dip, as the natural horizon is not used, nor for semi-diameter as the centre of the object is generally centred on the bubble image, but the extra correction for the Coriolis effect is necessary if the observations are made from an aeroplane.

A chronometer is a specially designed timepiece, usually mounted in gimbals so that it keeps in a horizontal position in spite of the movement of the ship. Chronometers are rated very accurately and checked frequently by radio time signals so that the error on Greenwich Mean Time (G.M.T.) can be determined at the time of observation.

An astro-compass is an instrument used in aircraft for checking course by sighting on celestial objects; it has scales on which latitude,

local hour angle, and declination may be set, and by bringing the sights to bear on the object, the true north is indicated on the bearing plate. It is also used for steering a course, identifying stars, and checking bearings from ground objects.

The following example shows the working necessary to reduce two sights to obtain a fix, using the *Abridged Nautical Almanac* and H.O. 214.

On 1952 January 6 from a ship in the Atlantic Ocean (D.R. position N.  $18^{\circ} 35'$  W.  $50^{\circ} 42'$  at  $16^{\text{h}} 50^{\text{m}}$ ) on a D.R. track  $040^{\circ}$  true, at 12 knots, the altitude of the Sun's lower limb is observed to be  $43^{\circ} 15' \cdot 2$  at G.M.T.  $16^{\text{h}} 55^{\text{m}} 32^{\text{s}}$  and the upper limb of the Moon is observed to be  $8^{\circ} 37' \cdot 6$  at G.M.T.  $17^{\text{h}} 15^{\text{m}} 43^{\text{s}}$ . The observations are taken from a height of 35 feet and the index error of the sextant is  $+2' \cdot 0$ .

Sun observation		Using 'Abridged Nautical Almanac' (pages 21 and xxix)	
Obs. alt.	$43^{\circ} 15' \cdot 2$	G.M.T. $16^{\text{h}}$ G.H.A. = $58^{\circ} 35' \cdot 4$	Dec. = S. $22^{\circ} 34' \cdot 2$ $d = 0' \cdot 3$
Index error	$+2 \cdot 0$	$55^{\text{m}} 32^{\text{s}}$ Inc.	$13 \ 53 \cdot 0$
Dip*	$-5 \cdot 8$	$16^{\text{h}} 55^{\text{m}} 32^{\text{s}}$	$72 \ 28 \cdot 4$
Correction*	$+15 \cdot 2$	Assumed long. (W.)	$-50 \ 28 \cdot 4$
True alt.	$43 \ 26 \cdot 6$	L.H.A. Sun	$22 \ -$
Calc. alt.	$43 \ 12 \cdot 4$	Using H.O. 214; Lat. $19^{\circ}$ , H.A. $22^{\circ}$	
Intercept	$14 \cdot 2$	Dec. $22^{\circ} 30'$ (CONTRARY) Alt. = $43^{\circ} 15' \cdot 8$ $\Delta d = 87$ Az. = $151^{\circ} \cdot 6$	
(Towards)		$\Delta d$ corr <sup>n</sup> (back cover)	$-3 \cdot 4$
			Alt. = $43 \ 12 \cdot 4$ True Az. = $208^{\circ}$

Moon observation		Using 'Abridged Nautical Almanac' (pages 21 and ix)	
Obs. alt.	$8^{\circ} 37' \cdot 6$	G.M.T. $17^{\text{h}}$ G.H.A. = $319^{\circ} 26' \cdot 8$ $v = 12' \cdot 2$ Dec. = N. $20^{\circ} 58' \cdot 2$	$d = 10' \cdot 1$
Index error	$+2 \cdot 0$	$15^{\text{m}} 43^{\text{s}}$ Inc.	$3 \ 45 \cdot 0$
Dip†	$-5 \cdot 8$	$v$ or $d$ corr <sup>n</sup>	$+3 \cdot 2$
App. alt.	$8 \ 33 \cdot 8$	$17^{\text{h}} 15^{\text{m}} 43^{\text{s}}$	$323 \ 15 \cdot 0$
Main			$N. \ 21 \ 00 \cdot 8$
corr <sup>n</sup> †	$+61 \cdot 7$	Assumed long. (W.)	$-50 \ 15 \cdot 0$
U corr <sup>n</sup> †	$+1 \cdot 8$	L.H.A. Moon	$273 \ -$
Sub. $30'$			Moon's H.P. = $55' \cdot 3$
for U†	$-30 \cdot 0$	Using H.O. 214; Lat. $19^{\circ}$ , H.A. $87^{\circ}$ (= $360^{\circ} - 273^{\circ}$ )	
True alt.	$9 \ 07 \cdot 3$	Dec. $21^{\circ}$ (SAME) Alt. = $9^{\circ} 22' \cdot 4$ $\Delta d = 29$ Az. = $70^{\circ} \cdot 9$	
Calc. alt.	$9 \ 22 \cdot 6$	$\Delta d$ corr <sup>n</sup> (back cover)	$+0 \cdot 2$
Intercept	$15 \cdot 3$	Alt.	$= 9 \ 22 \cdot 6$ True Az. = $71^{\circ}$
(away)			

\* Inside front cover of *Abridged Nautical Almanac*.  
 † Inside back cover of *Abridged Nautical Almanac*.

Fig. 160 shows the plotting necessary. *A* is the D.R. position at G.M.T. 16<sup>h</sup> 50<sup>m</sup> and *AB* the course. *C* is the assumed position (N. 19°, W. 50° 28'.4) from which the intercept for the Sun is plotted; *CE* is the intercept and *EG* the Sun position line at 16<sup>h</sup> 55<sup>m</sup> 32<sup>s</sup>. *D* is the assumed position (N. 19°, W. 50° 15'.0) from which the Moon is plotted, *DF* being the intercept and *FH* the Moon

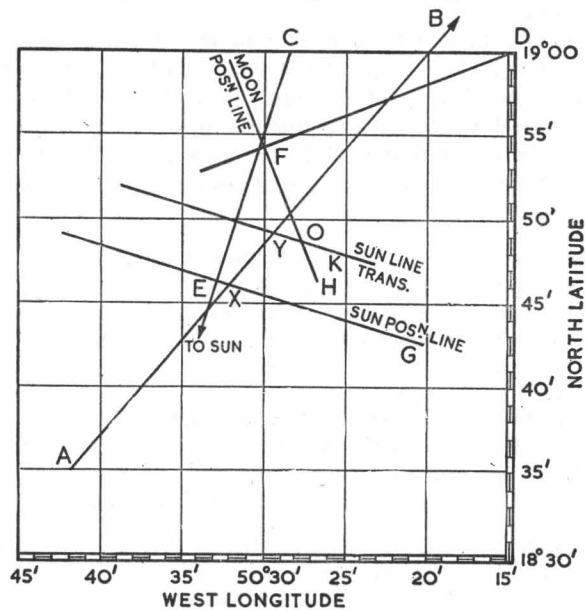

FIG. 160

position line at 17<sup>h</sup> 15<sup>m</sup> 43<sup>s</sup>. *XY* is the distance the ship would run on its course from 16<sup>h</sup> 55<sup>m</sup> to 17<sup>h</sup> 16<sup>m</sup>, so that *YK* is the Sun position line transferred to the time of Moon observation, *YK* being parallel to *EG*. The intersection, *O*, of *YK* and *FH* is the fix at 17<sup>h</sup> 15<sup>m</sup> 43<sup>s</sup> (N. 18° 48'.5, W. 50° 27'.6).

The following example shows the working necessary when fixing position by two observations made from an aircraft, using the *Air Almanac* and H.O. 249.

On 1953 April 22, on a flight over Greenland, the following observations are made: the altitude of Vega at G.M.T. 02<sup>h</sup> 03<sup>m</sup> 32<sup>s</sup>

is observed with a bubble sextant to be 44° 13' and the altitude of Arcturus at 02<sup>h</sup> 08<sup>m</sup> 57<sup>s</sup> is found to be 41° 20'. The D.R. position at G.M.T. 02<sup>h</sup> 00<sup>m</sup> is N. 67° 55', W. 28° 46', altitude 12,000 feet, speed 320 knots, D.R. track 265° true, index error of bubble sextant +1' (sextant correction).

Vega		Arcturus		For Vega		For Arcturus	
Obs. alt.	44° 13'	41° 20'	G.H.A. $\gamma$	02 <sup>h</sup> 239° 50'	02 <sup>h</sup> 239° 50'		
Index error	+1	+1	03 <sup>m</sup> 32 <sup>s</sup>	0 53	08 <sup>m</sup> 57 <sup>s</sup>	2 14	
Dome ref <sup>n</sup>	-5	-5	G.H.A. $\gamma$	240 43	G.H.A. $\gamma$	242 04	
True alt.	44 09	41 16	Assumed long.	-28 43	long.	-29 04	
Calc. alt.	44 04	41 28	L.H.A. $\gamma$	212 —	L.H.A. $\gamma$	213 —	

5 T. 12 A.

Using H.O. 249,<sup>1</sup> Lat. N. 68°Vega, L.H.A.  $\gamma$  212° Alt. = 44° 04' Az. = 094°Coriolis corr<sup>n</sup> 8' to starboard. Arcturus, L.H.A.  $\gamma$  213° Alt. = 41° 28' Az. = 180°

FIG. 161

Fig. 161 shows the plotting necessary; *A* is the D.R. position at G.M.T. 02<sup>h</sup>, *B* the assumed position when Vega was observed, and

<sup>1</sup> Preliminary edition, 1947.

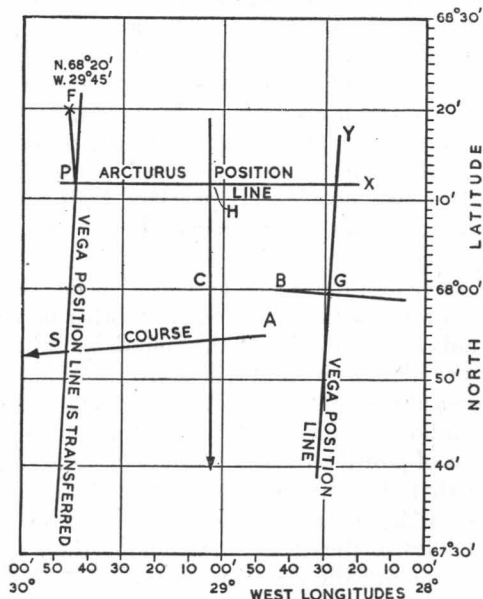

$C$  the assumed position when Arcturus was observed.  $BG$  is the intercept and  $GY$  the position line at the time of the Vega observation,  $CH$  the intercept and  $HX$  the position line at the time of the Arcturus observation.  $PS$  is the Vega position line transferred parallel to  $GY$ , a distance equal to the distance travelled between the two observations.  $F$  is obtained by shifting  $P$  ( $8'$  to starboard for Coriolis correction), so that  $F$  is the *fix* at G.M.T.  $02^h 09^m$  (N.  $68^\circ 20'$ , W.  $29^\circ 45'$ ).

## TECHNIQUES

Although navigation by astronomy has been largely reduced to a science, there will always be room for a certain amount of personal judgment—sometimes amounting to 'flair'—if the observer is going to make the best use of the heavenly bodies available. His technique will naturally depend on his medium; if he is a sea navigator, he will take pains to get an accurate sight, and will use highly accurate tables to effect a resolution. In the air, however, the time factor is more important, and the result of the observation should be available on the chart as soon as possible after taking it. So the air navigator will deliberately sacrifice high accuracy in the interests of speed; simpler and less accurate reduction methods are therefore employed.

Again the navigator's technique will depend on how many heavenly bodies are available, and whether other non-astronomical navigational aids can be used. If the ship or aircraft is in an area of good radio or radar coverage it will probably be best not to make use of astronomical methods at all; on other occasions, as when one, and only one, radio transmitting station happens to be within range, a determination of position by astronomy and radio can be effected. Remembering that the astronomical position line is really the arc of a very large circle, centred at the substellar point (and is therefore at right angles to the great circle joining the vessel's position to the substellar point), the good navigator will choose his star(s) in such a manner that a good intersection with his radio position line will be made; in this case the direction of the star(s) should be roughly towards, or directly away from, the radio transmitter.

The importance of angle of cut can be appreciated by referring to Fig. 162 facing. Assuming that the small but inevitable

errors of observation can be represented by a 'band of error,'<sup>1</sup> it is seen that the region of uncertainty is larger when the angle of cut is small. The best configuration to choose, for two position lines, is a right-angled cut.

When conditions are favourable three or more position lines can be used to find a position. Obviously the more the better, but in

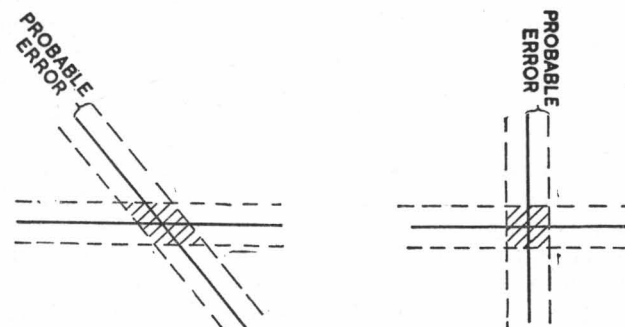

FIG. 162

practice time is the limiting factor, particularly in air work. At sea four or even more astronomical position lines may be used; these will define a small polygon on the chart (ideally they should all intersect at a point, but errors of observation may cause the position lines to be displaced from their true location), and the navigator chooses the central point as his fix. In the air the position is somewhat different; firstly time rarely permits more than three observations to be made, and secondly the chance of a blunder, as distinct from a small observational error, is considerably greater (owing, in the main, to the difficulties of working in the air). If only two position lines are available, a blunder in observation or calculation cannot be identified; but if three are taken the navigator will be warned that something has gone wrong if his 'cocked hat' (or triangle of intersection) is too large. In this case he can

<sup>1</sup> Errors of observation are not, of course, constant, but behave randomly. In practice there is a well-defined 'law of errors,' which states that small errors are more probable than large ones, and that errors of opposite sign are equally likely. The width of the 'band of error' is sometimes taken as the size of the 'probable error': in this case the chance of the true position line lying within this band of error is 50 per cent.

either recheck his calculations or, if this reveals no error, take a further observation or observations.

As before small angles of cut should be avoided in the three-star case, the ideal configuration being an equilateral triangle on the chart. The navigator will therefore choose his stars roughly either  $60^\circ$  or  $120^\circ$  apart from one another in the sky.

For astronomical fixing, particularly in the air, a good navigational 'drill' is recommended. This drill will naturally depend on the amount of other navigational assistance available, the state of the weather, the time of the day, and on other factors. In the absence of other navigational aids, it is a good plan for the air navigator to take at least one three-star fix every hour; good navigators can take observations, resolve them, and plot them, at the rate of one three-star fix every half-hour. At sea sights on heavenly bodies are often taken at morning and evening twilight, since at that time the brighter stars are visible, and the horizon, which provides a datum for the marine sextant, is still visible.

Lastly there are occasions when astronomical methods can be used to provide only one position line. Such is the case, for example, when sailing or flying by day over the sea and only the Sun is observable. Here no fix can be obtained, but a knowledge of the vessel's dead-reckoning position can be used in conjunction with the position line to estimate a 'most probable position' intermediate between the two.

The navigator improves his technique only through experience, and the remarks above provide only the barest guide as to how to make optimum use of the stars available. They do, however, illustrate the point that astronomical navigation is no routine, but an art where skill and sense are as fundamental as book learning.

#### FUTURE TRENDS

The development of navigation at sea has taken place slowly over a period of centuries; its problems have attracted many first-class minds, with the result that astronomical navigation in this medium has reached such a stage that few fundamental improvements can be foreseen. Instrumental developments will no doubt continue to take place as simpler and more accurate sextants are invented; but, by and large, sea navigators are satisfied with astronomical methods

in their present form, and there seems no reason why progress in this field should not continue in a slow and steady manner.

In the air the situation is quite different. The rapid development of aircraft has confronted the navigator with a host of problems, whose complexity is being increased as aircraft speeds become faster and faster. Instrumental problems are raised; the performance of hitherto reliable equipments such as the air-speed indicator and the magnetic compass will probably deteriorate as aircraft speeds and operational heights increase; and small random accelerations in a fast-flying aircraft will make the determination of the vertical less accurate than it is at present.

All this has repercussions on astronomical navigation. Errors in determining the vertical which correspond, in effect, to errors in finding the point *Z* of the *PZX* triangle, will naturally introduce additional errors in astronomical work. High speeds necessitate a quicker determination of position; a fix which requires fifteen minutes to compute will only give the navigator information about his position some 150 miles behind the aircraft.

The higher operational performance of aircraft is not the only factor which will have a vital effect on the role of astronomical navigation. Among others is the continuous development of radio and radar aids. In general these permit of a far quicker and more accurate determination of position, and the future will bring a far keener competition between the two techniques. Where it is practicable and economical to install ground radio stations, it is probable that astronomical methods will fall out of use, but in unfrequented areas of the Earth's surface, and over the great sea masses, more developments in radio techniques are required before astronomical navigation yields its pride of place. In particular, military operations demand navigational methods which cannot be tampered with by a potential enemy; man has not yet found a means of jamming the navigational aids that Nature provides.

The mention of unfrequented parts of the Earth's surface brings us face to face with the problem of navigating in polar regions; here the navigator's present armoury is insufficient. The standard Mercator chart cannot be used, whilst the magnetic compass becomes ever less sensitive as the magnetic poles are approached. The extension of air operations to such areas is a matter only of time. Here, however, astronomical methods are likely to come into their

own; the heavenly bodies may replace the compass as a directional datum, and the degenerate nature of the *PZX* triangle (*Z*, the observer's zenith, approaches *P* in polar regions) enables special methods of sight reduction to be employed.

Summing up, it appears that modern developments in the aircraft industry, and the opening up of hitherto undeveloped routes, will have important repercussions on astronomical navigation, not all of which are unfavourable. Firstly, and most important, some method of cutting down the delays in observation and sight reduction will be required. A sextant which, after being pre-set, automatically and continuously measures the altitudes of selected heavenly bodies and, in conjunction with a time-keeping device, resolves the observations, presenting the position in latitude and longitude to the navigator, would appear an ideal towards which to strive. Secondly, a more accurate determination of the observer's zenith is required if the precision achieved in the past is to be maintained—though it should be remarked that high positional accuracy is not necessarily a navigational requirement for *en route* flying over thinly developed territories; and, lastly, the extension of air operations to the polar areas will require a modification of astronomical methods, particularly in the field of sight reduction.

To conclude, it should be mentioned that the next fifty years are likely to see the development of space-ships operating outside the Earth's atmosphere. How are these craft to be navigated? It is doubtful if any form of terrestrial control, such as radar, could be maintained over such vast distances in space, and astronomical methods provide the only possible solution. The ground will be cut from underneath the foundations of classical methods; the *PZX* triangle, a terrestrial conception, must be abandoned in favour of a larger framework. That time-honoured datum, the observer's vertical, can no longer be determined when the ship is outside the Earth's gravitational influence. The problem of astronomical navigation, even for high-flying aircraft, has always been a two-dimensional one, but in the vaster field of stellar operations the relative directions, and possibly the gravitational fields, of the Sun, planets, and stars must be so utilized to yield three-dimensional fixes. A method that has been suggested is the use of stellar distances from the Sun (solars); outside the Earth's atmosphere the 'sky' will be black and stars will be visible at small angular distances

from the Sun. These 'star solars' will enable the direction in space from the Sun to be determined and, for interplanetary travel, the distance from the Sun can be found from 'planet solars,' i.e. angular distances of one or more planets from the Sun. Whatever methods of navigation are employed it is certain that they will be complicated; and the need for elaborate flight planning on the Earth before the voyage is made cannot be too strongly stressed.

#### SOME RECENT NAVIGATIONAL BOOKS

*Admiralty Manual of Navigation* (3 vols.), H.M. Stationery Office, London, 1938.

Weems, P. V. H.: *Marine Navigation* (Van Nostrand, New York, 1940); *Air Navigation* (McGraw-Hill Book Co., New York, 1943).

Smart, W. M.: *Foundations of Astronomy; Astronomical Navigation; A Handbook for Aviators; Introduction to Sea and Air Navigation*. Longmans, London, 1942.

Royal Air Force: *Air Navigation*, vol. i, H.M. Stationery Office, London, 1944.

Bok, Wright: *Basic Marine Navigation*, Houghton Mifflin, Cambridge, U.S.A., 1944.

Blackburn, E. F.: *Basic Air Navigation*, Mc. Graw-Hill Book Co., New York, 1944.

U.S. Hydrographic Office, Publication H.O. No. 214: *Tables of Computed Altitude and Azimuth* (9 vols.), Government Printing Office, Washington, D.C., 1936.

U.S. Hydrographic Office, Publication H.O. No. 249: *Star Tables for Air Navigation* (Preliminary Edition), Government Printing Office, Washington, D.C., 1947. The new edition (3 vols.) entitled *Sight Reduction Tables for Air Navigation* (H.O. No. 249), in press, 1952.

Anderson, E. W.: *The Principles of Air Navigation*, Methuen, London, 1951



1952 January 6, Sunday

Lat.	Sunset		Twilight		G.M.T.	SUN		ARIES		VENUS		MARS		+1 <sup>h</sup> 2	
	h	m	h	m		G.H.A.	Dec.	G.H.A.	Dec.	G.H.A.	Dec.	G.H.A.	Dec.		
N. 72	17 08	39 09	S.	22 38 5	178	39 9	S.	22 38 8	104	31 7	222	15 2	262	23 3	S. 7 20 0
N. 70	19 31	39 06	01	22 38 5	193	39 6	01	22 38 5	119	34 2	237	14 6	277	24 6	7 20 4
66	20 08	39 03	02	22 38 2	208	39 3	02	22 38 2	134	30 6	252	14 0	292	25 8	7 20 9
64	22 23	39 00	03	22 37 9	223	39 0	03	22 37 9	149	29 1	267	13 4	307	27 1	7 21 3
62	23 38	38 57	04	22 37 7	238	38 7	04	22 37 7	164	21 6	282	12 8	322	28 4	7 21 8
N. 60	25 33	38 5	05	22 37 4	253	38 5	05	22 37 4	179	14 0	297	12 1	337	29 7	S. 7 22 2
58	26 28	38 2	06	22 37 1	268	38 2	06	22 37 1	194	40 5	312	11 5	352	31 0	7 22 7
56	28 3	37 9	07	22 36 8	283	37 9	07	22 36 8	209	49 0	327	10 9	377	33 3	7 23 1
54	29 8	37 6	08	22 36 5	298	37 6	08	22 36 5	224	51 4	342	10 3	402	35 6	7 23 6
52	31 3	37 3	09	22 36 2	313	37 3	09	22 36 2	239	53 9	357	09 6	437	38 8	7 24 0
N. 50	32 8	37 1	10	22 36 0	328	37 1	10	22 36 0	254	56 3	372	09 0	462	41 1	S. 7 24 5
45	34 3	36 8	11	22 35 7	343	36 8	11	22 35 7	269	58 8	387	08 4	477	43 8	7 24 9
40	35 8	36 5	12	22 35 4	358	36 5	12	22 35 4	285	01 3	402	07 8	492	46 6	7 25 4
35	37 3	36 2	13	22 35 1	373	36 2	13	22 35 1	300	03 7	417	07 1	507	49 4	7 25 8
30	38 8	36 0	14	22 34 8	388	36 0	14	22 34 8	315	06 2	432	06 5	522	52 2	7 26 3
N. 20	43 3	35 7	15	22 34 5	403	35 7	15	22 34 5	330	08 7	447	05 9	537	55 0	S. 7 26 7
N. 10	48 8	35 4	16	22 34 2	418	35 4	16	22 34 2	345	11 1	462	05 3	552	57 8	7 27 2
0	53 3	35 1	17	22 33 9	433	35 1	17	22 33 9	360	13 6	477	04 6	567	60 6	7 27 6
S. 10	58 8	34 8	18	22 33 7	448	34 8	18	22 33 7	375	16 1	492	04 0	582	63 4	7 28 1
20	63 3	34 6	19	22 33 4	463	34 6	19	22 33 4	390	18 5	507	03 4	597	66 2	7 28 5
S. 30	68 8	34 3	20	22 33 1	478	34 3	20	22 33 1	405	21 0	522	02 7	612	69 0	S. 7 29 0
35	73 3	34 0	21	22 32 8	493	34 0	21	22 32 8	420	23 5	537	02 1	627	71 8	7 29 4
40	78 8	33 7	22	22 32 5	508	33 7	22	22 32 5	435	25 9	552	01 5	642	74 6	7 29 9
45	83 3	33 5	23	22 32 2	523	33 5	23	22 32 2	450	28 4	567	00 9	657	77 4	7 30 3
50	88 8	33 5	24	22 32 0	538	33 5	24	22 32 0	465	30 8	582	00 3	672	80 2	7 30 7
55	93 3	33 5	25	22 31 8	553	33 5	25	22 31 8	480	33 2	597	00 0	687	83 0	7 31 1
S. 55	98 8	33 5	26	22 31 6	568	33 5	26	22 31 6	495	35 6	612	00 0	702	85 8	7 31 5
$T = 12^h 06^m$ $d = 0 3$ $T = 16^h 59^m$ $d = 0 6$															

Lat.	Moon-rise		Moon-set	Age 8d 5	MOON		S.D. 15' 2	JUPITER		SATURN					
	h	m			G.H.A.	Dec.		G.H.A.	Dec.	G.H.A.	Dec.				
N. 72	08 4	06 0	14	00	72	30 4	12 9	N.	17 51 9	98	03 2	270	05 4	S.	3 32 8
N. 70	09 4	05 1	11	01	87	02 3	12 9	18	03 6	113	05 4	285	07 8	3	32 9
66	09 9	04 6	11	02	101	34 2	12 8	18	15 2	128	07 6	300	10 1	3	32 9
64	10 3	04 2	9	03	116	06 0	12 8	18	26 8	143	09 8	315	12 5	3	32 9
62	10 7	03 9	8	04	130	37 8	12 7	18	38 2	158	12 0	330	14 9	3	32 9
N. 60	10 9	03 6	8	05	145	09 5	12 7	N.	18 49 6	173	14 2	345	17 3	S.	3 32 9
58	11 2	03 4	7	06	159	41 2	12 6	19	00 8	188	16 4	360	19 7	3	33 0
56	11 4	03 2	7	07	174	12 8	12 6	19	12 0	203	18 6	375	22 1	3	33 0
54	11 5	03 1	7	08	188	44 4	12 6	19	23 0	218	20 8	390	24 4	3	33 0
52	11 7	02 9	6	09	203	16 0	12 5	19	34 0	233	23 0	405	26 8	3	33 0
N. 50	11 8	02 8	6	10	217	47 5	12 5	N.	19 44 9	248	25 2	420	29 2	S.	3 33 0
45	12 1	02 5	6	11	232	19 0	12 4	19	55 7	263	27 4	435	31 6	3	33 1
40	12 4	02 3	5	12	246	50 4	12 4	20	06 3	278	29 5	450	34 0	3	33 1
35	12 6	02 1	5	13	261	21 8	12 3	20	16 9	293	31 7	465	36 4	3	33 1
30	12 8	01 9	5	14	275	53 1	12 3	20	27 4	308	33 9	480	38 7	3	33 1
N. 20	13 1	01 7	4	15	290	24 4	12 2	N.	20 37 8	323	36 1	495	41 1	S.	3 33 1
N. 10	13 3	01 4	4	16	304	55 6	12 2	20	48 0	338	38 3	510	43 5	3	33 2
0	13 6	01 2	4	17	319	26 8	12 2	20	58 2	353	40 5	525	45 9	3	33 2
S. 10	13 9	01 0	3	18	333	58 0	12 1	21	08 3	368	42 7	540	48 3	3	33 2
20	14 1	00 7	3	19	348	29 1	12 0	21	18 2	383	44 9	555	50 7	3	33 2
S. 30	14 5	00 4	3	20	3	00 1	12 0	N.	21 28 1	398	47 1	570	53 1	S.	3 33 2
35	14 6	00 3	2	21	17	31 1	12 0	21	37 8	413	49 3	585	55 4	3	33 3
40	14 9	00 1	2	22	32	02 1	11 9	21	47 5	428	51 5	600	57 8	3	33 3
45	15 1	00 0	2	23	46	33 0	11 9	21	57 0	443	53 7	615	60 2	3	33 3
50	15 5	00 0	2	24	60	44 0	11 9	22	06 5	458	55 9	630	62 6	3	33 3
55	15 9	00 0	1	25	74	55 0	11 9	22	16 4	473	58 1	645	65 0	3	33 3
S. 55	16 3	00 0	1	26	88	6 0	11 9	22	26 3	488	60 3	660	67 4	3	33 3
$H.P. 4^h, 55' 7; 12^h, 55' 5; 20^h, 55' 3$ $v = 2 2$ $d = 0 1$ $v = 1 3$ $d = 0 5$															

GREENWICH A. M. 1953 APRIL 22 (WEDNESDAY)

GREENWICH P. M. 1953 APRIL 22 (WEDNESDAY)

GMT	SUN		ARIES		VENUS-3.5		JUPITER-1.6		SATURN 0.5		MOON		Moon's P. in A.
	GHA	Dec.	GHA	Dec.	GHA	Dec.	GHA	Dec.	GHA	Dec.	GHA	Dec.	
00 00	180 21	N12 02	208 45	195 07	N11 57	185 58	N18 34	7 06	S 6 30	75 06	N16 47		0 0
10	182 51		212 16	197 37		158 28		9 36		77 31	45		
20	185 21		214 46	200 08		160 58		12 07		79 57	44		
30	187 51		217 17	202 39		163 28		14 37		82 23	42		
40	190 21		219 47	205 09		165 59		17 07		84 48	40		
50	192 51		222 17	207 40		168 29		19 38		87 14	38		
01 00	195 21	N12 03	224 48	210 10	N11 56	170 59	N18 34	22 08	S 6 30	89 39	N16 36		0 0
10	197 51		227 18	212 41		173 30		24 39		92 05	34		
20	200 21		229 49	215 11		176 00		27 09		94 30	33		
30	202 51		232 19	217 42		178 30		29 40		96 56	31		
40	205 21		234 49	220 12		181 01		32 10		99 22	29		
50	207 51		237 20	222 43		183 31		34 40		101 47	27		
02 00	210 21	N12 04	239 50	225 14	N11 55	186 01	N18 34	37 11	S 6 30	104 13	N16 25		0 0
10	212 51		242 21	227 44		188 32		39 41		106 38	22		
20	215 21		244 51	230 15		191 02		42 12		109 04	24		
30	217 51		247 21	232 45		193 32		44 42		111 30	20		
40	220 21		249 52	235 16		196 03		47 13		113 55	18		
50	222 51		252 22	237 46		198 33		49 43		116 21	16		
03 00	225 21	N12 04	254 53	240 17	N11 54	201 03	N18 34	52 14	S 6 30	118 46	N16 14		0 0
10	227 51		257 23	242 47		203 34		54 44		121 12	13		
20	230 21		259 54	245 18		206 04		57 14		123 37	11		
30	232 51		262 24	247 49		208 34		59 45		126 03	09		
40	235 21		264 54	250 19		211 04		62 15		128 29	07		
50	237 51		267 25	252 50		213 35		64 46		130 54	05		
04 00	240 21	N12 05	269 55	255 20	N11 53	216 05	N18 35	67 16	S 6 30	133 20	N16 03		0 0
10	242 51		272 26	257 51		218 35		69 47		135 45	01		
20	245 21		274 56	260 21		221 06		72 17		138 11	16		
30	247 51		277 26	262 52		223 36		74 48		140 37	15		
40	250 21		279 57	265 23		226 06		77 18		143 02	56		
50	252 51		282 27	267 53		228 37		79 48		145 28	54		
05 00	255 21	N12 06	284 58	270 24	N11 52	231 07	N18 35	82 19	S 6 30	147 53	N15 52		0 0
10	257 51		287 28	272 54		233 37		84 49		150 19	50		
20	260 21		289 58	275 25		236 08		87 20		152 45	48		
30	262 51		292 29	277 55		238 38		89 50		155 10	46		
40	265 21		294 59	280 26		241 08		92 21		157 36	45		
50	267 51		297 30	282 56		243 38		94 51		160 02	43		
06 00	270 21	N12 07	300 00	285 27	N11 51	244 09	N18 35	97 22	S 6 30	162 27	N15 41		0 0
10	272 51		302 31	287 58		248 39		99 52		164 53	39		
20	275 21		305 01	290 28		251 09		102 22		167 18	37		
30	277 51		307 32	292 59		253 39		104 53		169 44	35		
40	280 22		310 02	295 29		255 10		107 23		172 10	33		
50	282 52		312 32	298 00		256 40		109 54		174 35	32		
07 00	285 22	N12 08	315 03	300 30	N11 50	261 11	N18 35	112 24	S 6 30	177 01	N15 30		0 0
10	287 52		317 33	303 01		263 41		114 55		179 27	28		
20	290 22		320 03	305 31		266 11		117 25		181 52	26		
30	292 52		322 34	308 02		268 42		119 55		184 18	24		
40	295 22		325 04	310 33		271 12		122 26		186 43	22		
50	297 52		327 35	313 03		273 42		124 56		189 09	20		
08 00	300 22	N12 09	330 05	315 34	N11 49	276 13	N18 35	127 27	S 6 30	191 35	N15 18		0 0
10	302 52		332 35	318 04		278 43		129 57		194 00	16		
20	305 22		335 06	320 35		281 13		132 28		196 26	15		
30	307 52		337 36	323 05		283 44		134 58		198 52	13		
40	310 22		340 07	325 36		286 14		137 29		201 17	11		
50	312 52		342 37	328 06		288 44		139 59		203 43	09		
09 00	315 22	N12 09	345 08	330 37	N11 48	291 15	N18 35	142 29	S 6 30	206 09	N15 07		0 0
10	317 52		347 38	333 08		293 45		145 00		208 34	05		
20	320 22		350 08	335 38		296 15		147 30		211 00	03		
30	322 52		352 39	338 09		298 45		150 01		213 26	15		
40	325 22		355 09	340 39		301 16		152 31		215 51	14		
50	327 52		357 40	343 10		303 46		155 02		218 17	57		
10 00	330 22	N12 10	0 10	345 40	N11 47	306 16	N18 35	157 32	S 6 30	220 43	N14 56		0 0
10	332 52		2 40	348 11		308 47		160 02		223 08	54		
20	335 22		5 11	350 42		311 17		162 33		225 34	52		
30	337 52		7 41	353 12		313 47		165 03		228 00	50		
40	340 22		10 12	355 43		316 18		167 34		230 25	48		
50	342 52		12 42	358 13		318 48		170 04		232 51	46		
11 00	345 22	N12 11	15 12	0 44	N11 46	321 18	N18 36	172 35	S 6 30	235 17	N14 44		0 0
10	347 52		17 43	3 14		323 49		175 05		237 42	42		
20	350 22		20 13	5 45		326 19		177 36		240 08	40		
30	352 52		22 44	8 15		328 49		180 06		242 34	38		
40	355 22		25 14	10 46		331 20		182 36		244 59	36		
50	357 52		27 44	13 16		333 50		185 07		247 25	34		

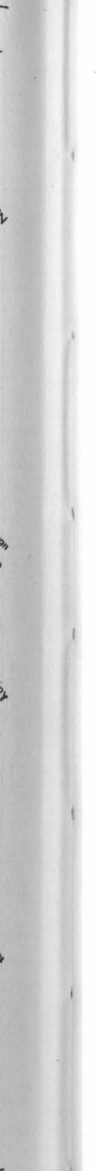

GMT	SUN		ARIES		VENUS-3.5		JUPITER-1.6		SATURN 0.5		MOON		Lat.	Sun-rise	Twilight	Moon-rise	Diff.
	GHA	Dec.	GHA	Dec.	GHA	Dec.	GHA	Dec.	GHA	Dec.	GHA	Dec.					
12 00	0 22	N12 12	30 15	15 47	N11 45	336 20	N18 36	187 37	S 6 29	249 51	N14 33		N				
10	2 52		32 45	18 18		338 51		190 08		252 17	31		h m	m	h m	m	
20	5 22		35 16	20 48		341 21		192 38		254 42	29		72	02 58	100	09 36	*
30	7 52		37 46	23 19		343 51		195 09		257 08	27		70	03 22	100	10 11	73
40	10 22		40 17	25 49		346 21		197 39		259 34	25		68	03 39	79	10 36	59
50	12 52		42 47	28 20		348 52		200 10		261 59	23		66	04 54	66	10 55	52
13 00	15 22	N12 13	45 17	30 50	N11 44	351 22	N18 36	202 40	S 6 29	264 25	N14 21		62	04 15	53	11 22	45
10	17 52		47 48	33 21		353 52		205 10		266 51	19		60	04 24	49	11 33	42
20	20 22		50 18	35 52		356 23		207 41		269 16	17		58	04 31	45	11 42	40
30	22 52		52 49	38 22		358 53		210 11		271 42	15		56	04 38	42	11 50	39
40	25 22		55 19	40 53		361 24		212 42		274 08	13		54	04 44	39	11 57	37
50	27 52		57 49	43 23		363 54		215 12		276 33	11		52	04 49	37	12 04	36
14 00	30 22	N12 14	60 20	45 54	N11 44	6 24	N18 36	217 43	S 6 29	278 59	N14 09		50	04 54	35	12 10	35
1																	

## DECLINATION SAME NAME AS LATITUDE

Lat. 19°	20° 00'			20° 30'			21° 00'			22
	H.A. °	Alt. °	Az. °	Alt. °	Az. °	Alt. °	Az. °	Alt. °	Az. °	
00	89 00-0	10 37 00-0	88 30-0	88 30-0	...	...	...	...	...	...
1	...	...	...	...	...	...	...	...	...	...
2	...	...	...	...	...	...	...	...	...	...
...	...	...	...	...	...	...	...	...	...	...
80	15 24-3	26 91 73-7	15 32-0	26 90 73-2	15 39-7	25 90 72-7	15 47-3	25 90	15 47-3	25 90
1	14 29-9	26 91 73-5	14 37-7	26 90 73-0	14 45-6	26 90 72-5	14 53-3	26 90	14 53-3	26 90
2	13 35-5	27 90 73-2	13 43-5	27 90 72-7	13 51-5	26 90 72-2	13	27 90	13	27 90
3	12 41-2	27 90 72-9	12 49-4	27 90 72-5	12 57-5	27 90 72-0		27 90		27 90
4	11 47-0	28 90 72-7	11 55-4	28 90 72-2	12 03-6	27 90 71-7		27 90		27 90
5	10 52-9	28 90 72-4	11 01-4	28 90 71-9	11 09-8	28 90 71-4		28 90		28 90
6	9 58-9	29 90 72-1	10 07-5	29 90 71-7	10 16-1	28 90 71-2		28 90		28 90
7	9 04-9	29 90 71-9	9 13-7	29 90 71-4	9 22-4	29 89 70-9		29 89		29 89
8	8 11-1	30 90 71-6	8 20-0	30 89 71-1	8 28-9	30 89 70-6		30 89		30 89
9	7 17-3	30 90 71-3	7 26-3	30 89 70-8	7 35-4	30 89 70-3		30 89		30 89
90	6 23-6	31 89 71-0	6 32-8	31 89 70-5	6 42-0	31 89 70-1		31 89		31 89

Portion of page 246 of vol. ii of H.O. 214 (by permission of U.S. Hydrographic Office)

## Lat. 68° N

LHA γ	DENEBO		VEGA		DENEBO		VEGA		ARCTURUS		ARCTURUS		REGULUS		REGULUS		POLLUX		POLLUX		CAPELLA		CAPELLA		LHA γ		
	Hc	Zn	Hc	Zn	Hc	Zn	Hc	Zn	Hc	Zn	Hc	Zn	Hc	Zn	Hc	Zn	Hc	Zn	Hc	Zn	Hc	Zn	Hc	Zn	Hc	Zn	
180	29-10	038	32-24	066	...	...	...	...	...	...	...	...	...	...	...	...	...	...	...	...	...	...	...	...	270	271	
181	...	...	...	...	...	...	...	...	...	...	...	...	...	...	...	...	...	...	...	...	...	...	...	...	272	...	
182	...	...	...	...	...	...	...	...	...	...	...	...	...	...	...	...	...	...	...	...	...	...	...	...	...	...	
...	...	...	...	...	...	...	...	...	...	...	...	...	...	...	...	...	...	...	...	...	...	...	...	...	...	...	
...	...	...	...	...	...	...	...	...	...	...	...	...	...	...	...	...	...	...	...	...	...	...	...	...	...	...	
210	39-01	010	37-42	061	43-19	092	38-02	062	43-42	093	41-27	177	23-59	286	24-21	285	29-33	323	29-20	324	29-07	325	28-12	032	300	301	
211	39-05	011	38-02	062	38-21	063	44-04	094	41-28	178	23-37	287	23-16	288	22-55	289	28-54	326	28-42	326	28-42	326	28-24	032	302	302	
212	39-10	012	38-42	064	44-26	095	39-02	065	44-49	096	41-28	181	41-27	182	22-33	290	28-29	327	28-29	327	28-29	327	28-36	033	303	303	
213	39-14	012	39-02	065	45-11	097	...	...	...	...	...	...	...	...	...	...	...	...	...	...	...	...	...	28-49	034	304	304
214	39-19	013	...	...	...	...	...	...	...	...	...	...	...	...	...	...	...	...	...	...	...	...	...	...	...	...	...
215	39-24	014	...	...	...	...	...	...	...	...	...	...	...	...	...	...	...	...	...	...	...	...	...	...	...	...	...
216	...	...	...	...	...	...	...	...	...	...	...	...	...	...	...	...	...	...	...	...	...	...	...	...	...	...	...
217	...	...	...	...	...	...	...	...	...	...	...	...	...	...	...	...	...	...	...	...	...	...	...	...	...	...	...
...	...	...	...	...	...	...	...	...	...	...	...	...	...	...	...	...	...	...	...	...	...	...	...	...	...	...	...
...	...	...	...	...	...	...	...	...	...	...	...	...	...	...	...	...	...	...	...	...	...	...	...	...	...	...	...

Portion of page 25 of H.O. 249 (by permission of U.S. Hydrographic Office)



## CHAPTER XII

THE ROAD TO THE  
PLANETS

ARTHUR C. CLARKE, B.S.C., F.R.A.S.

*Chairman of the British Interplanetary Society**Author of 'Interplanetary Flight,' 'The Exploration of Space,' etc.*

THE idea of travelling to other planets is a good deal older than most people imagine: indeed the first of the countless fantastic romances on this theme was written as long ago as A.D. 160! Only in the last half-century, however, has the subject of interplanetary flight become a matter of serious scientific concern—and only in the last decade has it approached the stage of engineering achievement.

This, of course, is a consequence of the extraordinary advances in rocket propulsion during the war. In 1940 no rocket had risen more than a few miles above the Earth or achieved speeds much greater than that of sound. To-day missiles exist which can carry loads of one ton to altitudes of a hundred miles—and the records for height and speed are 250 miles and 5,000 miles an hour. It is hardly surprising, therefore, that the research establishments of at least one government are seriously investigating designs for man-carrying space-ships. At present such studies are based on a large amount of soundly established theory and a small but steadily increasing body of practical experience. In this respect it is perhaps not inaccurate to compare the state of 'astronautics' to-day with that of aviation at the close of the nineteenth century.

The problem of manned space flight falls into two sections. First there is the provision of a suitable method of propulsion and sufficient

fuel for the journey envisaged. This, of course, arises whether the rocket carries men or merely automatic recording instruments. Once these difficulties have been solved a whole host of secondary problems arises, such as the maintenance of suitable living conditions in the cabin, steering and navigation, radio communication, provision of food, physiological hazards, the landing and take-off on another planet, and so on. Solutions for many of these problems already exist, and the rest can undoubtedly be dealt with once the fundamental questions of power and propulsion are settled. However, their existence makes it fairly certain that the first flights into space will be carried out by automatic machines radioing information back to Earth. The manned spaceships, just like airships, will follow perhaps a decade later.

As is now generally realized, the rocket is the only method of propulsion which will operate in airless space. It is completely independent of a surrounding medium for support, reaction, or oxygen. Those who find it difficult to understand how any thrust can be obtained in a vacuum should consider the fact that a V2 motor ejects a ton of matter every six seconds, at a speed of 5,000 miles an hour. Clearly an enormous recoil must be produced *inside the motor itself*, and once the burnt gases leave the rocket it makes little difference whether they expand into vacuum or atmosphere. In fact there is a slight *increase* of thrust (about 10 per cent) when a rocket motor operates in a vacuum and it is only under these conditions that it can work at maximum efficiency.

There is another fundamental difference between a rocket and any other form of propulsion. Aeroplanes, motor-cars, and ships have to keep their engines running for the whole duration of their journeys. Not so the rocket: it builds up its maximum speed in a few seconds or minutes, and that speed must be sufficient for it to 'coast' like a projectile without further power until its destination is reached. The motors will never operate for more than a very small fraction of the total time of flight: while the rocket is in the vacuum of space it can lose none of its speed through air resistance, and under the right conditions could keep on travelling for ever.

According to a well-known saying: 'What goes up must come down.' This, like most proverbs, is only partly true. Indeed the astronomer, looking at the moons and planets turning endlessly in their orbits, might be tempted to say: 'What goes up *never* comes down!'

The law is true enough for most ordinary purposes. Even the  $V_2$ , which attained a speed of a mile a second, could only rise a hundred miles before falling back to Earth. But, owing to the manner in which gravity weakens with distance, there is a limiting velocity—25,000 miles an hour—beyond which a body would never return to the Earth but would go on rising indefinitely. Though the Earth's gravitational pull would always be slowing it down, so that its initial velocity would be quickly reduced, our planet could never recapture it. Any spaceship must, therefore, be capable of reaching at least this speed merely to leave the Earth. Though in theory it would be possible to travel out into space as slowly as one wished so long as the rockets kept operating, this procedure would be so wasteful of fuel that only the first method is practicable—and even that involves enormous difficulties with the rocket fuels available at the present time.

The first interplanetary voyage will almost certainly be the journey from Earth to Moon and back. The voyage would be divided up into the following stages: (1) *Escape from Earth*. This part of the journey could last about five minutes and would cover less than 2,000 miles. The crew would feel three or four times normal weight while the motors were thrusting, but this acceleration is quite tolerable in the 'lying prone' position. (2) *Period of free flight*. This would begin as soon as the ship had reached escape velocity and the rockets were shut down. It would last for 99.9 per cent of the voyage—until the time came to make the landing in fact. If the correct flight path had been followed during the period of acceleration, the ship would travel towards the Moon, slowly losing speed until it reached the point where the gravities of Earth and Moon exactly balanced. At this point, about 24,000 miles from the Moon, it might be travelling at only a few hundred miles an hour, but it would then begin to speed up as it fell towards the Moon. The whole journey would last not more than five days, and quite possibly as little as two. During this time the ship and its contents would appear to be 'weightless'—a state of affairs which never exists on Earth and which would enable the crew to levitate themselves around the cabin in the manner so often described in the literature of space flight. (3) *The landing on the Moon*. If unchecked the spaceship would crash into the Moon at about 5,000 miles an hour, and throughout its descent it would

be necessary to swing it round so that the rockets pointed in the direction of fall. This could be done by small steering jets or by gyroscopes. When the ship was less than a hundred miles above the Moon, the rockets would be fired for about a minute to check its rate of descent and to bring it to rest within a few feet of the surface. It would then 'touch down' on a system of shock-absorbing legs.

Although this manœuvre may sound extremely hazardous, it should be explained that the steering mechanisms already used in giant rockets perform basically similar feats, and the lunar landing would probably be carried out by an automatic pilot working in conjunction with a radar altimeter. The Moon's low gravity—one-sixth of the Earth's—would greatly simplify the operation.

The take-off and return to Earth would be very similar to the outward voyage, though the presence of the Earth's atmosphere means that the final landing might be carried out by wings or parachute.

When one calculates the amount of fuel needed for such a mission as that described above it appears that it is quite out of the question to design rockets capable of meeting the specifications. The matter would be different, however, if the voyage could be split up into separate stages *and the ship refuelled between each*. Although this idea seems at first sight absurd, it is now generally believed to be the key to the whole problem of space flight.

In practice refuelling could be carried out by sending a number of rockets up into the same circular orbit around the Earth. Once they had attained the correct speed (about 18,000 miles per hour at a height of say 200 miles) they could never fall down, and on shutting off their motors would move freely in space, apparently weightless. Transfer of fuel from one to the other would then be a purely technical problem, obviously soluble in principle. More elaborate variations of this scheme have been worked out for refuelling spaceships orbiting the Moon.

It is a somewhat curious fact that journeys to the nearer planets require little more energy than the voyage to the Moon. The time of flight is, of course, longer (roughly five months to Venus, eight to Mars), but it seems likely that the landing on the Moon will be followed relatively quickly by the exploration of more interesting worlds.

As long as chemical fuels of the type known to-day are employed, interplanetary travel will be an extremely difficult and expensive enterprise, of very great scientific interest, but having no large-scale practical applications. If, however, atomic energy can be harnessed for propulsion—as many believe will be the case—the situation would be transformed. Permanent bases and observatories could then be established on most of the planets and satellites, and the psychological consequences of this would be almost as profound as the scientific repercussions. Looking still further ahead it is by no means impossible that after some centuries the distribution of the human race would be appreciably affected—as it was by the opening up of the New World 500 years ago. Such a development would require the invention of techniques for controlling planetary environments over large regions, but even these are foreshadowed by present-day science.

Whatever the future may bring—provided only that scientific progress continues—the exploration of space, on the larger or smaller scale, is an inevitable next stage in human history, and it is impossible to set any limits to its ultimate consequences.

#### BIBLIOGRAPHY

##### Popular Books

- Willy Ley: *Rockets and Space Travel*, Chapman & Hall, 1949.  
 P. E. Cleator: *Rockets through Space*, George Allen & Unwin, 1936.  
 G. Edward Pendray: *The Coming Age of Rocket Power*, Harper & Bros., New York, 1947.  
 Harry Harper: *Dawn of the Space Age*, Sampson Low, Marston & Co., 1947.  
 Willy Ley; paintings by Chesley Bonestell: *The Conquest of Space*, Sidgwick & Jackson.

##### Classic Works

- Hermann Oberth: *Wege zur Raumschiffahrt*, Edwards Bros., Michigan, U.S.A., 1945.  
 Dr. Robert H. Goddard: *Rockets*, American Rocket Society, New York, 1946.

##### Technical Books

- Ir. Dr. J. M. J. Kooy and Prof. Dr. Ir. J. W. H. Uytendogaart, *Ballistics of the Future*, The Technical Publishing Co., Haarlem, 1946.  
 G. P. Sutton, *Rocket Propulsion Elements*, John Wiley & Sons Inc., New York, 1949.  
 A. C. Clarke: *Interplanetary Flight*, Temple Press Ltd., 1950.

#### Miscellaneous Technical Publications

Dr. Frank J. Malina: 'Characteristics of the Rocket Motor Unit based on the Theory of Perfect Gases,' *Journal of the Franklin Institute*, Philadelphia, Pa., U.S.A., October 1940.

W. G. A. Perring: 'A Critical Review of German Long-range Rocket Development,' *Journal of the Royal Aeronautical Society*, London, July 1946.

Dr. W. H. Wheeler, H. Whittaker, and Dr. H. M. Pike: *Solid and Liquid Propellants*, The Institute of Fuel, 18 Devonshire Street, London, W.1.

H. S. Siefert, M. W. Mills, and M. Summerfield: 'The Physics of Rockets,' *American Journal of Physics*, Nos. 1, 2, and 3 of vol. xv, 1947.

Dr. F. J. Malina and M. Summerfield: 'The Problem of Escape from the Earth by Rocket,' *Journal of the Aeronautical Sciences*, New York, August 1947.

Howard E. Roberts: 'The Earth's Atmosphere,' *Aeronautical Review*, New York, October 1949.

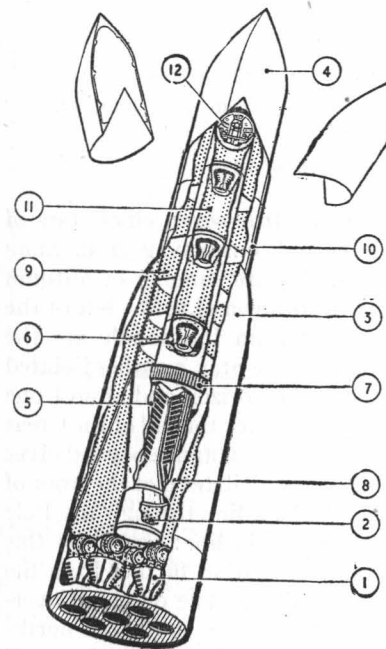

#### Key to Principal Features:

- (1) Chemical booster—seven motors of 450 tons thrust, using liquid oxygen/liquid hydrogen. (2) Fuel for booster pumps. (3, 4) Expendable tanks for chemical booster. (5) Atomic reactor: 1,100 tons thrust, using ammonia propellant. Weight, 40 tons. (6) Turbo-pump feed to reactor. (7) Energy shielding—weight, 20 tons; density, 1 ton per metre. (8) Gyro-regulated steering jets, incorporating steam exhaust from turbo-pumps. (9) Expendable tanks for atomic propulsor. (10) Jointed main longerons. (11) Three-step chemical crew rocket, using liquid oxygen/liquid hydrogen. Weight, 60 tons, all-up. (Serving also as health shielding during operation of atomic reactor—density, 6.25 tons per metre.) (12) Pressurized crew chamber. Weight, 1.4 tons, including crew, instrumentation, provisions, etc.

FIG. 163

#### EXPENDABLE TANK CIRCUMLUNAR ROCKET

Reproduced from *Interplanetary Flight*, by A. C. Clarke (Temple Press). Design, K. W. Gatland and A. M. Kunesch, 1949.



CHAPTER XIII

# NOTES ON IDENTIFICATION

E. O. TANCOCK, B.A., F.R.A.S.

*Author of 'Starting Astronomy,' Editor of Philips' 'Chart of the Stars,' etc.*

## THE NORTHERN POLAR STARS

**I**N the latitude of London the Plough (the seven chief stars of Ursa Major) never sets. It is a large and conspicuous group more than a hand-span at arm's length. In late summer or autumn evenings it is in the north-west, thus below and to the left of the Pole (Fig. 164). The two stars furthest from the handle are the Pointers, giving a line nearly dead on the Pole Star, a rather isolated second-magnitude star about  $50^\circ$  above the horizon and almost one degree from the Pole. A line from the handle (or the tail of the Great Bear) through the Pole and produced the same distance beyond gives the W of Cassiopeia, about the size of the quadrilateral of the front of the Plough. It is in the Milky Way. Take a line through the Pole at right angles to this Ursa Major-Cassiopeia line: nearly on this line are two of the brightest northern stars rather further from the Pole than the tip of the Great Bear's tail is. The one high overhead is Vega or Alpha Lyrae: the other, not far above the north-eastern horizon, is Capella the Goat, Alpha Aurigae, with the small triangle of the Kids near by, helpful for identification. These four landmarks (or sky-marks) roughly  $90^\circ$  apart make a framework to which the observer may add his further knowledge of the northern

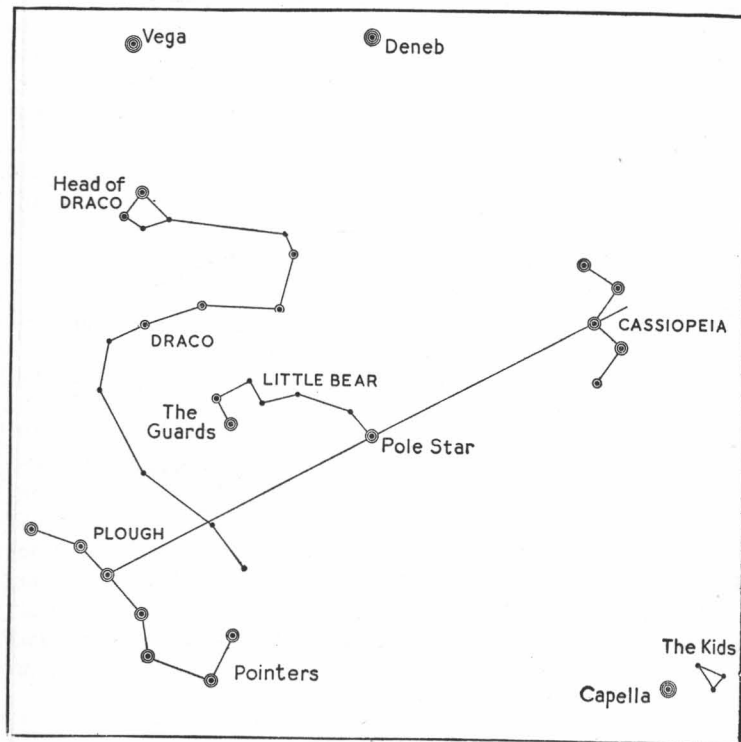

FIG. 164  
North Polar Stars

stars. Culminating about two hours after Vega and rather nearer the Pole is the first-magnitude star Deneb or Alpha Cygni, marking the tail of the Swan: the line from head to tail, bigger than Cassiopeia, lies along the Milky Way. Return to Polaris: this is the end of the Little Bear's tail. There are only two other bright stars in this constellation, the Guards, between Polaris and the tip of the Great Bear's tail. Draco, with no brilliant star, winds between the Bears. The moderately bright star between the Guards and the end of the tail of Ursa Major is Alpha Draconis which was the Pole star when the pyramids were built.

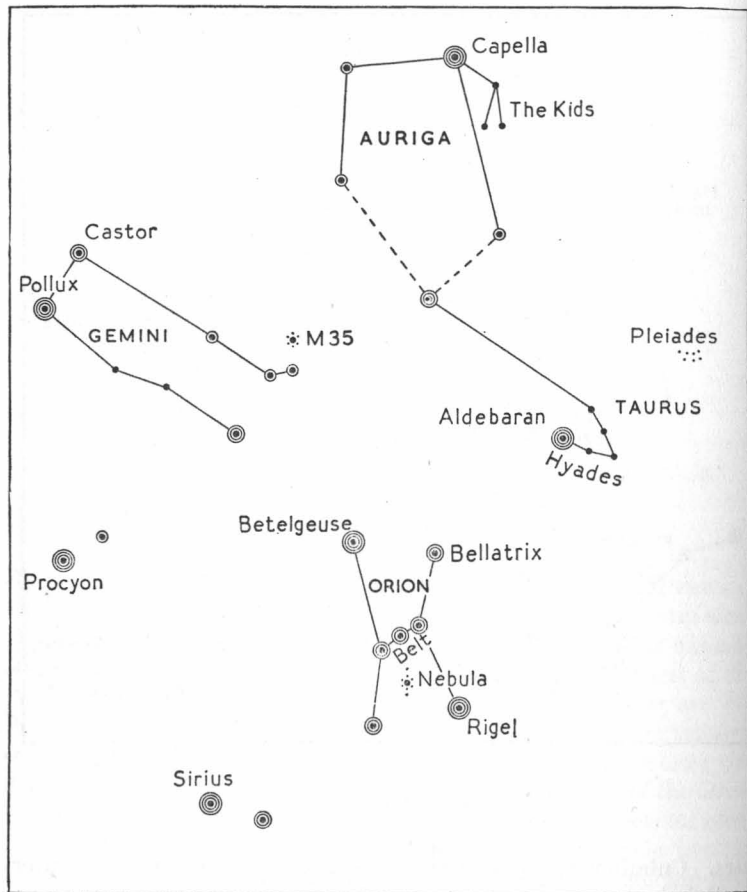

FIG. 165  
Stars of Winter

#### THE STARS OF WINTER

We look towards the south (because stars not near the Pole are at their highest when south) at about 9 p.m. in late January. The three second-magnitude stars of Orion's belt, nearly in a perfect straight line and equally spaced, are unmistakable. Fig. 165 shows red Betelgeuse, Orion's right arm (on the observer's left

as Orion is facing you), Bellatrix, nearly magnitude 1, his left arm, and brilliant white Rigel his left foot. Pointing downwards from the belt are three stars which represent the sword: the middle one marks the Great Orion Nebula, well worth observing in a 3-inch glass. This is a grand constellation. The belt aligns downwards to Sirius the Dog Star, the brightest of all stars, in Canis Major, and upwards to red Aldebaran, the eye of the Bull in the Hyades cluster. Further north on the same line are the Pleiades, also in Taurus, the most conspicuous cluster in the sky. High above Orion is Capella with the Kids. Capella is at the top of the great pentagon of Auriga, though the southernmost star belongs to Taurus, being at the tip of one of the horns. The V of the Hyades represents the Bull's head bent down in act to charge Orion. Two hours to the east of Orion, and slightly further north than his belt, is Alpha of Canis Minor, the first-magnitude Procyon, rather isolated except for the Beta further north and west. North of Procyon are the Twin stars, Castor the more northerly and Pollux. Castor is the Alpha, though less bright than Pollux (magnitude 1) the Beta. Castor is a splendid double for a small telescope. Two lines of stars from Castor and Pollux south-eastwards mark the Twins lying side by side. Two stars close together mark Castor's feet. Very near by is the cluster M 35 Geminorum, visible to the naked eye and worth examination with field-glasses.

#### THE STARS OF SPRING

In mid April at nine o'clock the Lion dominates the southern sky (Fig. 166). It is some  $15^\circ$  nearer the Pole than Orion is. As with Orion, the arrangement of stars bears some resemblance to the object named, which cannot be said of most of the constellations. The beast is regarded as facing eastwards with Regulus, the faintest of the 20 first-magnitude stars, marking the fore-paws, while the breast and head form a curve known as the Sickle of Leo. Gamma, lettered in the map, is a good double for a 3-inch. Two bright stars further west mark the body, while second-magnitude Denebola, nearly two hours further east than Regulus, marks the tail. The faint naked-eye cluster Praesepe in Cancer precedes the Sickle by an hour and a half. In the south-west the Twins are still visible on account of their high north declination, but Orion has rapidly gone out of

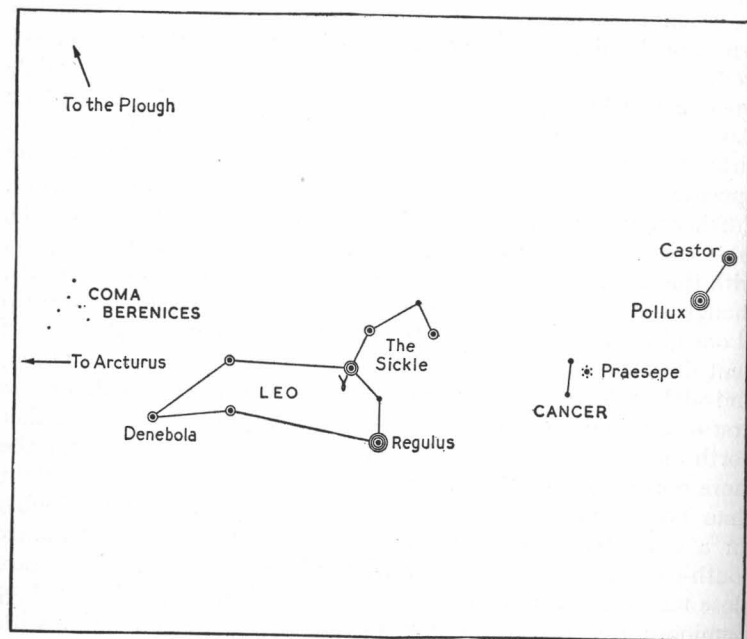

FIG. 166  
Stars of Spring

season with the westward movement of the Sun and the lengthening of daylight. The quadrilateral of the head of Draco is east of the Pole Star. If we produce the curve of the Plough handle backwards we find the very bright Arcturus, Alpha of Boötes, a star which though not circumpolar is never out of our night skies though it disappears from our evening skies early in December. Continue this curve still further to find first-magnitude Spica—Alpha Virginis. The region between Denebola and Arcturus but slightly further north is rich in small stars and is well worth examination with a field-glass. It is the constellation of Coma Berenices. Not far from the centre of the arc from which the Great Bear's tail is struck is a rather lone star Cor Caroli, Alpha of Canes Venatici the Hunting Dogs. It is an interesting double in a 3-inch glass.

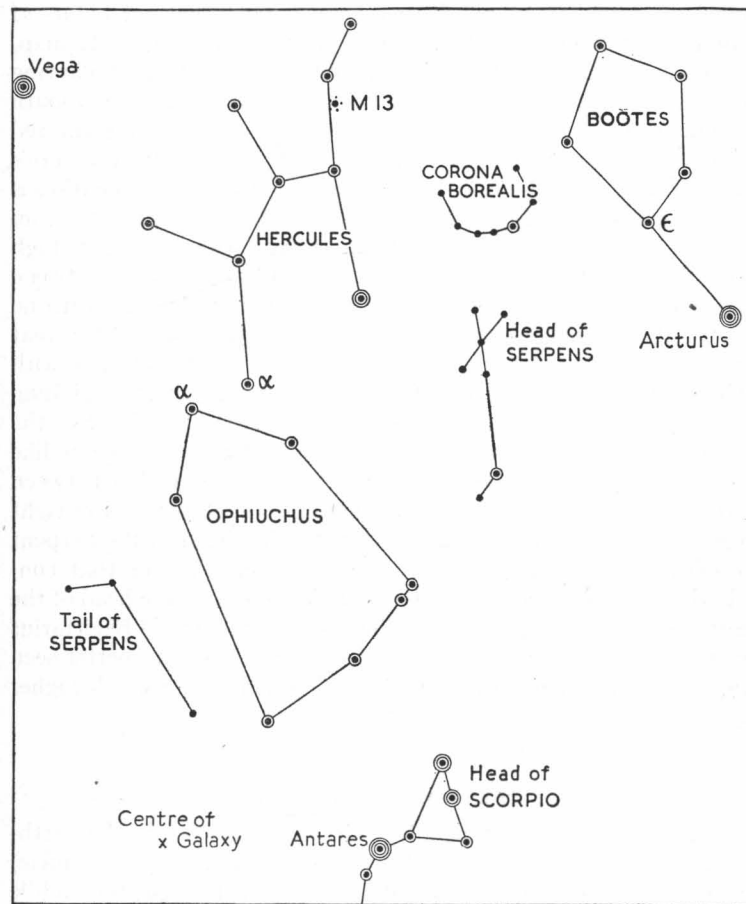

FIG. 167  
Stars of Summer

#### THE STARS OF SUMMER

As twilight lasts all night for some weeks on either side of the summer solstice, even in the south of England, we shall not see the summer stars in June against a really dark sky. If we face south at ten o'clock in the latter part of June we shall find that Arcturus has



passed the meridian by nearly two hours. The other chief stars of Boötes form a great letter P (Fig. 167). Epsilon, marked on the map, is not an easy double for a 3-inch but worth trying. Following Boötes is the conspicuous semicircle of Corona Borealis. Due south but low on the horizon is the head of Scorpio. Preceding the red giant Antares are three stars well spread out marking the creature's head. But most of the long tail of this magnificent constellation is within the invisible circle of London and will not be seen well from latitudes higher than that of southern Italy. Brilliant Vega is high in the south-east and will culminate in about two hours. Between Vega and Boötes is the straggling constellation of Hercules with no very bright stars. The map shows the position of M 13, the great globular cluster on the line joining Eta and Zeta. It is visible with difficulty to the naked eye, a fuzzy star in field-glasses, beginning to be resolved in a 4-inch and a great sight in a 7-inch. See the wonderful photograph on page 339 but do not expect to see it like this in any telescope. Ophiuchus the Serpent-Bearer lies between Hercules and the tail of Scorpio and has approximately the same right ascension so they all culminate together. The head of the Serpent precedes Ophiuchus: the tail is on the eastern side of that constellation. The richest part of the Milky Way follows the head of the Scorpion about an hour later. The great starclouds of Sagittarius (see page 347) hide the centre of the Galaxy. They are better seen from the southern hemisphere where they culminate much higher and are seen in the dark nights of winter.

#### THE STARS OF AUTUMN

At eight o'clock in mid October Arcturus is setting in the north-west: Vega is high in the south-west with Altair (Alpha Aquilae) below it, easily identified as a white first-magnitude star, the middle of three in a straight line but not of equal magnitude like those of Orion's belt (Fig. 168). The little diamond of the Dolphin with one more for the tail follows Altair by about an hour. Approaching the meridian and half-way up the sky is the Great Square of Pegasus, a good 15° square of second-magnitude stars with remarkably few stars inside it. The top left-hand corner is Alpha Andromedae. The great line of stars at intervals of about an hour formed by the top of the Square with Beta and Gamma Andromedae and Alpha Persei, leading

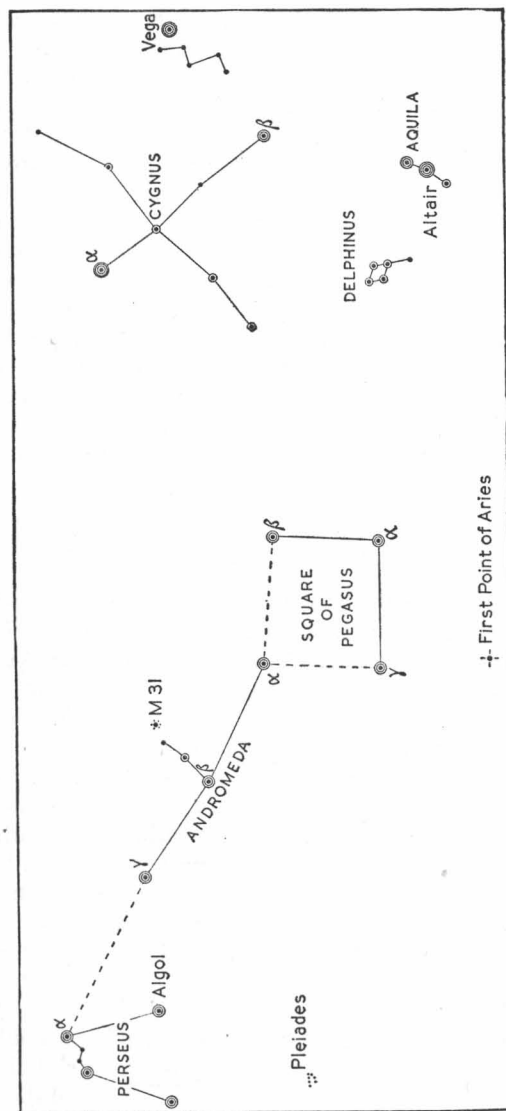

FIG. 168  
Stars of Autumn

on with a bigger gap to bright Capella, will be easily found and remembered. The line is nearly parallel to the horizon but will look very different in February evenings when the Square is setting and that line points up towards the zenith. This great line of stars is clearly seen on the map. A line perpendicular to it from Beta Andromedae leads northwards about  $8^\circ$  to a misty patch clearly seen on moonless nights, M 31, the Great Spiral Nebula in Andromeda, the only extragalactic object visible to the naked eye from high northern latitudes. Below Alpha Persei is Beta Algol, the well-known eclipsing variable (see pages 312-14). When the right or west side of the Square is near the meridian we may produce the line  $3\frac{1}{2}$  times its length to find first-magnitude Fomalhaut Alpha Piscis Australis, the most southerly first-magnitude star visible from Britain. The sides of the Square run almost on the lines of right ascension and declination, the east side being nearly on R.A. 0 hours, so if we produce this side its own length southwards we nearly locate the First Point of Aries.

#### THE SOUTHERN POLAR STARS

An observer at Dunedin has a circumpolar circle which is not very different from the London circle of invisibility and he will not see the London circumpolar stars. As he faces north the sky will appear to rotate from right to left with stars reaching their maximum altitude due north. The observer of the circumpolar sky at 10 p.m. at the end of April when the summer is over will find the Southern Cross above the Pole  $15^\circ$  south of the zenith (Fig. 169). The four chief stars are lettered on the end-paper map, Alpha, first magnitude, being the nearest to the Pole. Partly within the south-eastern section of the Cross is the Coal sack, the darkest patch in the Milky Way. Alpha Crucis is a fine triple. The long piece of the Cross is aligned roughly on the Pole at a distance of four or five times its length but there is no bright star near the Pole. Two hours later Crux is followed by the two brilliants Alpha and Beta Centauri, Beta preceding. There is no other example in the sky of two first-magnitude stars so close together. Alpha is a magnificent double for a small telescope. About  $12^\circ$  north of Beta is the great globular cluster Omega Centauri, just visible to the naked eye. West of the Pole and at about the same altitude is Canopus, Alpha Argus, excelled in

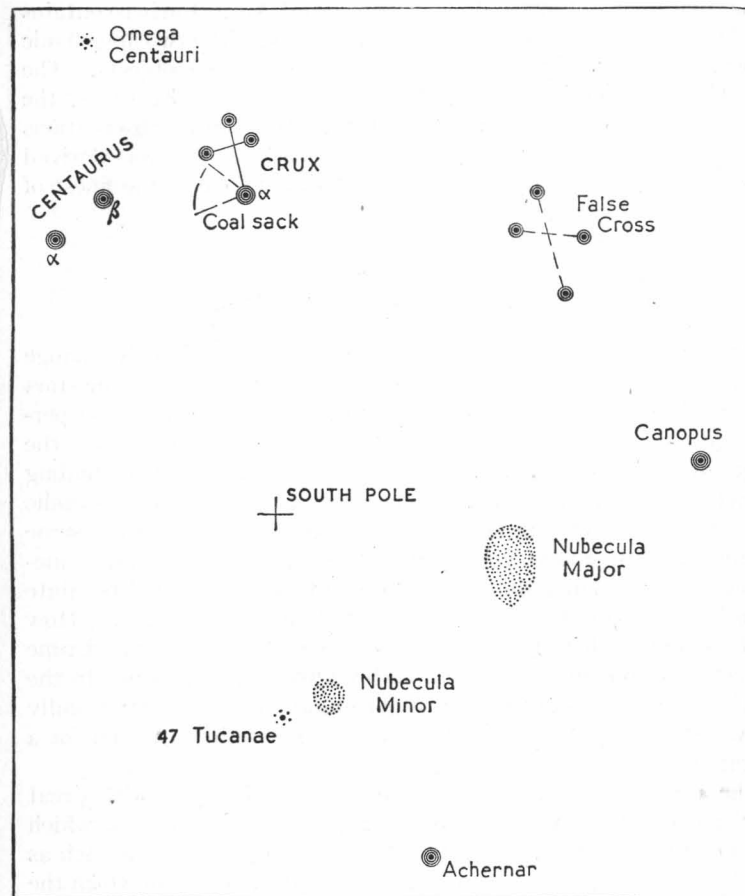

FIG. 169  
Southern Polar Stars

brightness by Sirius alone. A line from Beta Centauri to the as yet vaguely located Pole and produced the same distance beyond finds Achernar—Alpha Eridani, nearly as bright as Procyon. This line Beta Centauri—Achernar bisected nearly locates the Pole in Octans. The vast constellation of Argo lies in the area between Sirius and Crux.

It is divided into Carina, Vela, Puppis, and Ara. Carina contains the False Cross, occasionally mistaken for Crux. The two Magellanic Clouds (see page 350) are conspicuous naked-eye objects. The Greater is half-way between Achernar and the False Cross, the Lesser almost on the line Achernar-Pole. It was from observations of stars in this cloud that the Cepheid Variable law was derived (see page 317). Very near to it is 47 Tucanae, one of the finest of the globular clusters.

#### THE PLANETS IN FUTURE YEARS

As the planets revolve round the Sun they continually change their apparent positions as seen against the background of the stars on the Celestial Sphere. So they can no more be printed on permanent maps and astronomical charts than ships can be found in the maps of a terrestrial atlas. Nor can we draw up rules for finding planets at a certain particular time of year, for since the periodic times of the planets are all different, no planet will be in the same position this time next year as it is in now. In fact we can sometimes say of a planet that if it is brilliant to-night it will be quite invisible this time next year. The question therefore arises, How shall we know where to find any particular planet at a stated time in the years to come? This is a doubly important question. In the first place we may want to identify or observe that planet; secondly we want to be quite sure that we are not mistaking a planet for a bright star.

The positions of the planets have been calculated with great precision for many years to come, and we may use a book which gives this information. Then there are annual publications such as *Whitaker's Almanack*, which mention the constellations in which the planets are to be found month by month, and give their R.A. and Dec. for every few days. The possessor of a map or chart can thus locate them. Some daily papers give this kind of information at the beginning of each month, e.g. *The Times*, the *Manchester Guardian*, and the *Scotsman*. Scientific journals such as *Nature*, *Discovery*, *Sky and Telescope*, keep their readers posted in the same way. The *Journal of the British Astronomical Association* and the annual *Handbook* of the same Association can also be consulted.

But for the sake of those who want particulars in book form we give some notes on how to find the planets in forthcoming years.

First we shall need to explain some technical terms. These are serviceable rather than strictly accurate definitions. When an exterior planet is on the far side of the Sun from the Earth it is said to be in *Conjunction* (with the Sun). When the Earth is between a planet and the Sun the planet is in *Opposition*: the planet will then be due south at about midnight. Of course, an interior planet (Mercury or Venus) cannot be in opposition. When an interior planet is in line with the Sun on the far side of the Sun it is in *Superior Conjunction*; when on the near side of the Sun it is in *Inferior Conjunction*. When an interior planet is at its widest angle from the Sun as seen from the Earth it is at *Greatest Elongation*—not the widest angle it can ever reach, but the widest it is reaching in the movement applying to a particular month or two. When a planet in such a position is on the left or east of the Sun it is at *Greatest Elongation East*; when on the right or west of the Sun it is at *Greatest Elongation West*. Note that a planet at eastern elongation will be visible in the western sky and vice versa.

*Mercury.* Mercury is always 'near the Sun' as seen in the sky. Its elongations cannot exceed  $29^\circ$ . There are always a few evenings every spring and a few mornings every autumn when it can be seen in fairly high latitudes, and better still in low latitudes. The dates vary from year to year and are to be found in the journals we have mentioned. It is not much use to look for Mercury at an eastern elongation in autumn because the Zodiac at that time of the year in the western evening sky is below the equator, and therefore the planet, although relatively far from the Sun, is at low altitude, lost in the mists of the horizon. But in spring evenings the Zodiac in the west is above the equator, so the planet will be much higher in the sky. It should then be observable for several evenings before and shortly after greatest elongation. In tropical latitudes, where the Zodiac is much steeper to the horizon at east and west, the planet can be much more often seen. Corresponding morning conditions account for the good appearance of the planet at western elongations in autumn. The same sort of phenomenon is much more easily seen in the visibility of the young moon. A four-day-old moon at sunset is much higher in the sky in spring than in autumn.



*Venus.* The movements of Venus are explained in Chapter IV and its great brilliance accounted for. But when it is an evening star in autumn it can be by no means conspicuous, it is so low in the sky. For many weeks about the time of spring eastern elongations (evening star) and autumn western ones (morning star) it is far more conspicuous than any other planet. From the following table it will be seen that conditions repeat themselves almost exactly, every eight years. The months are those during which the planet can be observed. After the evening apparition the planet rapidly moves through inferior conjunction to become a morning star. The period of invisibility as it passes through superior conjunction is much longer.

## VENUS

Year	Evening Star	Morning Star	Year	Evening Star	Morning Star
1952	Sept. — Dec.	Jan. — Mar.	1962	April — Oct.	Nov. — Dec.
53	Jan. — Mar.	May — Oct.	63	Nov. — Dec.	Jan. — June
54	April — Oct.	Dec.	64	Jan. — May	July — Dec.
55	Nov. — Dec.	Jan. — June	65	June — Dec.	Jan.
56	Jan. — May	July — Dec.	66	—	Feb. — Aug.
57	June — Dec.	Jan.	67	Feb. — Aug.	Sept. — Dec.
58	Jan.	Feb. — Aug.	68	Sept. — Dec.	Jan. — Mar.
59	Feb. — Aug.	Sept. — Dec.	69	Jan. — Mar.	April — Oct.
60	Sept. — Dec.	Jan. — Mar.	1970	April — Oct.	Nov. — Dec.
1961	Jan. — Mar.	April — Oct.			

*Mars.* The observer is especially interested in any exterior planet in the few weeks just before and after opposition, because at that time the Earth and the planet are comparatively close together. The varying Earth-Mars distance at opposition, according to the time of year in which the opposition takes place, is explained in Chapter IV. The closest opposition for many years is that of 1956 when the planet will be moderately high in the sky for observers in either hemisphere. Possibly northern observers will prefer the opposition of 1958 when the planet will be further away but a good deal higher in the sky.

*Jupiter.* This planet takes about twelve years to go round the Sun, or, as we see it, to work its way through the Zodiac, never far from the Ecliptic. Zodiacal constellations vary in size but on the average Jupiter will move through a constellation a year. Oppositions will take place at intervals of about thirteen months; the oppo-

sition of 1952 was on Nov. 8. In that year it moved from Pisces into Aries so is getting well into north dec. In 1954-6 it will move through Taurus, Gemini, and Cancer—great years for northern observers. Oppositions, of course, will then be in winter when the Sun is in Sagittarius, Capricornus, and Aquarius. Observers in South Africa, Australia, and New Zealand will have the planet low in the sky. By 1960 and 1961 Jupiter will be at the most southerly part of the Zodiac, so conditions will be reversed. By 1964 it will again be back in Pisces or Aries, and by about 1969 crossing the equator again going south.

*Saturn.* Saturn makes a  $29\frac{1}{2}$ -year journey round the Sun or through the Zodiac so oppositions occur about a fortnight later each successive year. That of 1952 was on April 1. It will average the passage of rather less than half a zodiacal constellation a year. Saturn crossed the equator going south in September 1951, and from 1956 to 1964 will pass through the most southerly part of the Zodiac, being in Scorpio and Sagittarius, and will not cross the equator again till 1966.

But the pleasure of observing Saturn depends very much on the phase of the rings. They were closed in 1950: they will be open at their widest in 1958 and closed again in 1966, as described in more detail in Chapter IV. The planet is noticeably brighter when the rings are open.

*Uranus.* This sixth-magnitude planet is just visible to the naked eye. Oppositions occur about four days later each successive year. That of 1952 was on January 3 in Gemini, high in the north of the Zodiac. It will cross the equator going south in about 1980.

*Neptune* is eighth magnitude and therefore invisible except in a telescope. Oppositions are about two days later each successive year. The opposition of 1952 was on April 10 and not far from Spica. It crossed the equator going south in 1944 and will remain south of the equator till about 2028.

*Pluto*, fifteenth magnitude, is visible only in large telescopes. It was discovered in 1930 in Gemini and will be back in about the same place in 2177.

## APPENDICES

I-X BY M. DAVIDSON, B.A., D.SC., F.R.A.S.

### APPENDIX I. *Main Sequence Stars*

ON pages 329-31 reference is made to the work of Hertzsprung and Russell on giant and dwarf stars. If the absolute magnitudes of stars are plotted against their spectral types, taking the former along the ordinate and the latter along the abscissa, it is found that the majority of the points are arranged in a narrow band running diagonally from the top left-hand to the bottom right-hand. This band includes the *main sequence* stars, our Sun occupying an approximately mean position in it, and the stars which lie inside it have diameters comparable with that of the Sun—from about twenty times for the brightest to one-twentieth for the faintest. On the other hand there are red stars which do not lie inside this belt, like Betelgeuse, Antares, and many others; these are known as the giant stars and fall systematically above the main sequence belt. Others lying far below it towards the left-hand corner include the white dwarfs. The reference on page 23 to the Sun as 'still a G-type *main sequence* star not yet started on the dwarf stage of its existence' is to the possibility of the Sun retaining some of the liberated energy which would delay its degeneration into the red dwarf stage, in which case it must still be regarded as a G-type *main sequence* star.

### APPENDIX II. *Trigonometrical Method for finding the Distance of the Moon or a Minor Planet*

ON page 72 reference was made to the method for determining the distance of Eros from the Earth by the trigonometrical method. The principle of this is somewhat similar to that used for finding the distance of a star (see page 292), but instead of using a base line of 186 million miles the astronomer is limited to a base line which is the distance between two observatories on the Earth, separated as far as possible. This method is applied to determining the Moon's distance, the observatories being in the northern and southern hemispheres. Each observer  $O$  and  $O'$  finds the angle between his zenith (the point directly overhead) and a well-defined feature  $M$  on the Moon's surface, and from these the angles  $MOO'$  and  $MO'O$  are easily computed. Knowing the length of the chord  $OO'$  joining the two observatories, the distances  $OM$  and  $O'M$  are easily computed and hence the distance between the centres of the Earth and Moon. The distances between bodies in the solar system are measured from their centres, and in the case of a relatively close body like the Moon this is important because the distances from the Moon to different points on the Earth's surface vary considerably in comparison with the Moon's mean distance. The same thing applies to the planets and the Sun, but in a very much lesser degree, and in the case of the stars it makes no difference what part of the Earth the distance refers to.

While this method could be used for finding the Sun's distance, the results

would be very untrustworthy because the angle subtended by the Earth's diameter at the distance of the Sun is less than  $18''$  (it is about 400 times as great at the distance of the Moon) and small errors in measuring the angles corresponding to  $MOO'$  and  $MO'O$  would involve serious errors in determining the Sun's distance from the Earth. The Moon's horizontal parallax at its mean distance from the Earth is greater than  $57'$  (see page 72).

### APPENDIX III. *Note on the Relative Amounts of Light reflected by the Earth and Moon (page 77)*

THE Earth's diameter is about 3.676 that of the Moon and hence its superficial area is  $3.676^2 = 13.5$  that of the Moon. If therefore the reflecting powers of the Earth and Moon were the same, we should expect that the Earth would reflect 13.5 times as much light as the Moon, but the reflecting powers of the heavenly bodies vary considerably. The term *albedo* is used to denote the ratio of the total amount of radiation reflected to the amount that falls on the surface of a body, and in the case of the Moon this is 0.073. Taking the Earth's atmosphere and clouds as the reflecting surface, it is 0.37 for the Earth. The ratio between these two is 5.07, so that the total amount of radiation reflected from the Earth should be  $5.07 \times 13.5 = 68.4$  times that reflected by the Moon.

It has been estimated that over 460,000 full moons at mean distance would be required to produce an illumination equal to that of sunlight.

### APPENDIX IV. *Note on the Attraction of the Earth on Meteors*

IT was shown on page 243 that the attraction of the Earth increased the speed of meteors and that this increase was greatest with the slowest meteors, that is, those which were directly following the Earth in its orbital motion. A simple formula has been derived for determining this speed but the method for deriving it is beyond the scope of this work. Readers who wish to see the full mathematical treatment of the subject are referred to Charles P. Olivier's book, *Meteors*, Chapter XV, or J. G. Porter's recent book, *Comets and Meteor Streams*, pages 82 ff.

If  $V_1$  is the velocity of the meteor with respect to the Earth, the attraction of which is ignored, and  $V_2$  is its velocity when the acceleration effect of the Earth's attraction is taken into consideration, then

$$V_2^2 = V_1^2 + 48.23$$

where  $V$  in each case is expressed in miles per second.

The corresponding formula when  $V$  is expressed in kilometres per second is

$$V_2^2 = V_1^2 + 124.9.$$

If  $V_1$  is 7.5 miles per second, then  $V_2^2 = 104.5$  and  $V_2 = 10.2$  miles per second, as pointed out on page 243.

In addition to this effect in increasing the speed of the meteors there is a displacement of the radiant (determined from tracing back the apparent paths of the meteors) towards the zenith, and corrections must be made for this when accurate work is required, though in the case of the fastest meteors this correction is small. With the slow meteors it is considerable and must be taken into account.

APPENDIX V. *Note on determining Difference in the Luminosities of Stars from the Differences in their Magnitudes*

It is shown on page 288 that a star of magnitude  $m$  is 2.5 times as bright as a star of magnitude  $m+1$ , etc. Hence if  $m_a$  is the difference in the absolute magnitudes of two stars and  $l$  is the ratio of their luminosities, then  $2.5^{m_a} = l$ . The difference of the absolute magnitudes of the Sun and Sirius is  $4.8 - 1.3 = 3.5$ , and hence  $l = 2.5^{3.5}$ , or  $\log l = 3.5 \log 2.5 = 0.4 \times 3.5 = 1.4$ . Since  $\log l = 1.4$ ,  $l = 25$ . The absolute magnitude of the Sun is greater than that of Sirius, for which reason Sirius is the more luminous of the two, and hence  $l = 25$  is the ratio of the luminosity of Sirius to that of the Sun (see page 333).

On page 323, if the magnitude of the nova is taken as 0.5, this implies a change in magnitude of  $13 - 0.5 = 12.5$ , and by the method used above it is easily found that  $2.5^{12.5} = 100,000$ .

APPENDIX VI. *Note on determining the Distance of a Cepheid (page 320)*

THE curve showing the relation between the period of a Cepheid and its absolute magnitude has not been drawn, but the following figures from this curve, taken from Peter Doig's *An Outline of Stellar Astronomy* (page 51), can be used instead of the curve.

THE PERIOD-LUMINOSITY RELATION FOR CEPHEIDS

Period	Absolute Magnitude (photographic)	Period	Absolute Magnitude (photographic)
0.5 days	0.0	10 days	-1.9
1.0 "	-0.4	20 "	-2.6
5.0 "	-1.4	50 "	-3.5

The table shows that a Cepheid variable with a 20-day period has an absolute magnitude  $-2.6$ , and as the absolute magnitude of the Sun is  $4.85$ , the brightness of the Cepheid must be  $2.5^{7.45}$  ( $4.85 - (-2.6) = 7.45$ ) that of the Sun.

Since  $7.45 \log 2.5 = 2.98$  or practically 3.0, the Cepheid must be about a thousand times as bright as the Sun.

If the brightness of the Cepheid, measured by the size of its image on photographs, is about nineteenth magnitude—say twenty-two magnitudes less bright than it is at the standard distance of 32.6 light-years—this shows that it is  $2.5^{22} = 631,000,000$  times as faint as it would appear at 32.6 light-years ( $22 \log 2.5 = 8.8$ , the antilog of which is  $631 \times 10^6$ ).

Extracting the square root of  $631 \times 10^6$ , which is  $25.12 \times 10^3$  or about 25,000, this gives the distance of the Cepheid in terms of 32.6 light-years, or in other words its distance from us is about 800,000 light-years.

APPENDIX VII. *Note on page 333; Computation of a Star's Absolute Magnitude*

If  $l_1$  is the luminosity of a star at a distance of  $L$  light-years and  $l_2$  its luminosity at a distance of 32.6 light-years, then since luminosity is inversely proportional to the square of the distance, we have the simple relation  $(L/32.6)^2 = l_2/l_1$ . If  $m$  is the apparent magnitude of a star and  $m_a$  its absolute magnitude, the value of  $l_2/l_1$  is  $2.5^{12}$  ( $m - m_a$ ). Hence we have the simple expression

$$(L/32.6)^2 = 2.5^{12}(m - m_a).$$

Taking logarithms of both sides and remembering that  $\log 2.5 = 0.4$ , it follows that

$$2(\log L - \log 32.6) = 0.4(m - m_a).$$

Substituting 1.5132 for  $\log 32.6$  and simplifying, we obtain

$$m_a = m + 7.566 - 5 \log L.$$

Take the case of Sirius which is 8.78 light-years distant and whose apparent magnitude is  $-1.58$ . The above formula gives

$$m_a = -1.58 + 7.566 - 5 \log 8.78 = 5.986 - 5 \times 0.9435 = 1.27.$$

This is practically the same as the value given on page 333.

The apparent magnitude of the Sun is  $-26.72$  and its distance from the Earth is 500 seconds in light time or  $158 \times 10^{-7}$  light-years. Substituting this value for  $L$  in the above equation, then  $-5 \log 158 \times 10^{-7} = 24.0065$  and  $m_a = 4.85$ , which is the usually accepted value of the Sun's absolute magnitude.

APPENDIX VIII. *Precession of the Equinoxes*

ON page 410 it has been pointed out that this phenomenon was discovered by Hipparchus, though he did not know the explanation of it. A very good illustration of precession is found in the ordinary spinning-top when it slopes from the upright position and its head moves round approximately in a circle whose centre lies on the vertical drawn from the toe of the top. It has been shown on page 98 that the Earth's axis is inclined at an angle of about  $66\frac{1}{2}^\circ$  to the ecliptic, and we can take this axis as corresponding to the axis of the top, that is, the line drawn between the toe and the centre of the head. The vertical through the toe represents a line through the Earth's centre and passing through the pole of the ecliptic, so that precession is a conical movement of the Earth's axis round the pole of the ecliptic. It is caused by the attraction of the Sun and Moon—the Moon especially—on the protuberant portions of the Earth in equatorial regions, this attraction producing the conical movement very like that of a spinning-top, a complete revolution of the Earth's axis around the pole of the ecliptic taking place in about 26,000 years.

Nutation always occurs with precession and is similar to the nodding of a top when it is spinning, so that its head does not describe a perfect circle but a wavy curve in space. The same thing takes place during precession—the axis of the Earth approaching and receding from the pole of the ecliptic. The result of precession and nutation is that the points of intersection of the equator and the ecliptic move westward along the ecliptic at a mean rate of  $50''.26$  a year, but owing to nutation this rate is not uniform. The First Point of Aries ( $\gamma$ ) is the point on the celestial equator which the Sun's centre occupies when it is passing at the vernal equinox from the south to the north of the equator and is the zero point from which the right ascensions (R.A.) of the heavenly bodies are measured. Owing to the westward movement of this point the R.A. of the stars increases by more than  $50''$  a year and the combined effects of precession on the R.A. and declination (Dec.) of the heavenly bodies must be taken into consideration in accurate work. (See Chapter XI, pages 455-6.)

The terms Right Ascension and Declination have been mentioned in the



text, and readers who have access to a celestial globe will acquire from it much clearer conceptions of these and other terms than can be derived from mere descriptions. The Dec. of a heavenly body is its distance from the equator, measured by the arc of the great circle which passes through the body and the celestial pole. The R.A. is the arc of the equator intercepted between the First Point of Aries and the point where the Dec. circle meets the equator. It is measured eastward from  $\varphi$ , which is the zero point, through 24 h. or 360°. The similarity between celestial R.A. and Dec. and terrestrial longitude and latitude will be obvious.

APPENDIX IX. *Note on the Polar Axis of a Telescope* (pages 378-81)

The observer is supposed to be at the top of the four spheres shown on page 378, and hence the tangent plane at the top of each sphere represents his horizon. At any place on the Earth's surface a line from the observer to the pole of the heavens (the north pole and south pole in the northern and southern hemispheres respectively) makes an angle with his horizon equal to the latitude of the place. Thus in London a line drawn from an observer to the pole star would be inclined to his horizon at an angle of approximately  $51\frac{1}{2}^\circ$ . (It must be remembered that the pole star is not in the pole of the heavens but nearly a degree from it, and actually it appears to move round the pole of the heavens. A line from an observer to the *pole of the heavens*, however, makes an angle with the horizon equal to the observer's latitude.)

The polar axis of the telescope must be parallel to the Earth's axis, which points towards each celestial pole, N. and S., and hence in *a* where the observer is at the north pole, the polar axis, pointing towards the pole of the heavens, is inclined to the horizon at  $90^\circ$ , or in other words it is vertical. In *b*, where the observer is supposed to be at the equator, a line parallel to the Earth's axis *NS* must be horizontal, that is, its inclination to the horizon is zero. In the cases of *c* and *d* which show the observers at latitudes of about  $50^\circ$  N. and  $35^\circ$  S. respectively, the lines *NS* and *SN*, parallel to the polar axes of the telescopes, are inclined to the horizon at  $50^\circ$  in *a* and  $35^\circ$  in *b*.

APPENDIX X. *Observation of Celestial Objects*

GENERALLY speaking the brightest star in a constellation is denoted by 'Alpha' but there are a few exceptions; thus Alpha Gemminorum is not so bright as Beta. A list of the stars denoted by Alpha, their magnitudes and also their times of crossing the meridian, is given on page 491; the constellations have been selected from the Star Map of the Northern Skies, but some of these do not contain any very bright stars. All the stars in the first column, however, are visible to the naked eye.

Their times of crossing the meridian for other periods are easily found as follows. For each month after those given deduct 2 hours and for each month preceding those given add 2 hours to the times given. For each day allow 4 minutes. Thus on 1st January Betelgeuse crosses the meridian 2 hours earlier than on 1st December, that is at 23 h. 16 m., and on 1st November it crosses the meridian 2 hours later than on 1st December, or at 3 h. 16 m. The tabulated times are supposed to be local times which are obtained from Greenwich Mean Time by adding 4 minutes to it for each

degree of longitude E. and by deducting from it 4 minutes for each degree W. Thus if the G.M.T. is 22 h. (10 p.m.) at Liverpool, which is  $3^\circ$  W. longitude, the local time is 21 h. 48 m. Unless the place of observation is far E. or W. of Greenwich the correction need not be made as the tabulated times are not exact and vary slightly from year to year, but they are sufficiently accurate for all practical purposes.

TIMES WHEN CERTAIN STARS CROSS THE MERIDIAN

Star	Visual Magnitude	Local Time of Crossing the Meridian	
		h.	m.
Alpha Canis Majoris (Sirius)	-1.6	Jan. 1	00 04
„ Geminorum (Castor)	1.7		00 52
„ Canis Minoris (Procyon)	0.5		00 57
„ Leonis (Regulus)	1.3	Mar. 1	23 30
„ Ursae Majoris (Dubhe) U	2.0		00 29
„ Canum Venaticorum (Cor Caroli)	3.0	Apl. 1	00 19
„ Virginis (Spica)	1.2		00 48
„ Boötis (Arcturus)	0.2		01 39
„ Coronae Borealis	2.4	May 1	01 00
„ Serpentis	2.7		01 09
„ Scorpis (Antares)	1.2		01 54
„ Herculis	1.9	June 1	00 38
„ Ophiuchi	2.3		00 58
„ Lyrae (Vega)	0.1		02 01
„ Aquilae (Altair)	0.9	July 1	01 15
„ Cygni (Deneb) U	1.3		02 07
„ Cephei (U)	2.7		02 45
„ Aquarii	4.4	Sept. 1	23 22
„ Piscis Australis (Fomalhaut)	1.3		00 17
„ Pegasi	2.4		00 25
„ Andromedae	2.1	Oct. 1	23 26
„ Cassiopeiae (U) Variable: about	2.5		00 02
„ Arietis	2.2	Nov. 1	23 22
„ Ceti	2.7		00 29
„ Persei (U)	1.9	Dec. 1	22 40
„ Tauri (Aldebaran)	1.1		23 51
„ Aurigae (Capella) U	0.2		00 37
„ Orionis (Betelgeuse)	0.1 to 1.2		01 16

Where U follows the name of a star it implies that the time refers to its upper culmination. Stars with this letter do not set in the latitude of Greenwich, but appear to move round the pole of the heavens, as with the stars in Ursa Minor and many, but not all, in Ursa Major and various other constellations. When they appear on the meridian above the pole they have attained upper culmination and about twelve hours later they reach lower culmination, but the times refer to the former. It should be added that Summer Time is never used by astronomers and the necessary correction must be made for this.

These notes are merely intended to supplement Chapter XIII.

APPENDIX XI. *Supplement to Chapter IV. The Planets (2).*

By A. F. O'D. ALEXANDER, M.A., PH.D., F.R.A.S.

XI (1). *Mars—True Form of Canals (page 136).* An important step towards determining the true form of the canals has been taken by A. Dollfus who, observing with the Pic du Midi 24-inch refractor and a magnification of 900, has confirmed what Antoniadi had asserted, namely, that in perfect seeing (which continued sometimes for a whole evening at the Pic) even the narrowest canals appeared to be broken up into little irregular spots. Whenever the image became slightly less perfect, linear canals reappeared. Dollfus considers that the linear form is an over-simplified interpretation which the mechanism of the human eye naturally produces in dealing with a contrast that is either too slight or too brief in duration to be correctly detected and interpreted under ordinary good observing conditions. (See *L'Astronomie*, 1953 March, page 94 and Fig. 26.)

XI (2). *Mars—Plateaux and Mountains (page 137).* Although Dollfus, at the Pic du Midi, has so far failed to detect definite shadows along the terminator of Mars which would be direct evidence of high mountains, he infers from the patchy diminution of the north polar cap during the northern summer that there may well be plateaux in the vicinity of the pole with an altitude of about 3,000 feet. This is based on a calculation by Kuiper and Hess that on Mars a temperature difference (in the same latitude) of  $4^{\circ}$  would correspond to an altitude difference of 3,000 feet. It would also seem to follow from this that the persistent isolated white patches in the temperate zones indicate mountains much higher than 3,000 feet. Dollfus tentatively concludes that the Martian relief may be of a like order to terrestrial relief, allowing for the smaller size of Mars. (See *L'Astronomie*, 1953 March, page 101.)

XI (3). *Mars—Discovery of the Satellites (page 147).* The following is an abbreviated version of the account given of his discovery in a letter written by the American astronomer, Professor Asaph Hall, and dated December 28, 1877: Hall decided to search for possible satellites at the favourable opposition of 1877, as he found that no serious search had been made since Herschel's time except by D'Arrest in 1862. Search began early in August 1877. Attention was first directed at faint objects some distance from Mars; these proved to be fixed stars, so Hall examined the region close to the planet, keeping Mars just out of the field to reduce the glare. On August 11 he found a faint object following and a little north of the planet, but fog stopped observation and weather prevented serious resumption until August 16. Then the object was found again and seen to be moving with Mars. On August 17 while watching for this satellite (afterwards named Deimos), Hall discovered the inner one (Phobos), and the observations of August 17 and 18 showed them undoubtedly to be satellites. He made this comment: 'For several days the inner moon was a puzzle. It would appear on different sides of the planet on the same night, and at first I thought there were two or three inner moons, since it seemed very improbable to me, at that time, that a satellite should revolve around its primary in less time than that in which the primary rotates. To settle this point I watched this moon throughout the nights of August 20 and 21, and saw that there was, in fact, but one inner moon which made its

revolution around the primary in less than one-third the time of the primary's rotation, a case unique in our solar system.' (This letter was published in full in *M.N.R.A.S.* 38, 4, 205, February 1878.)

XI (4). *Jupiter—Dark South Tropical Streaks (page 156).* The Disturbance has not reappeared in recent years, but a prominent dark streak was seen in the south tropical zone in 1941-2 and a similar one lasted through most of the apparitions of 1946 and 1947. Though these Dark Streaks showed some similarity in development and rotation period to the former recurrent Disturbance they were never so extensive: the length did not grow to more than  $50^{\circ}$  even for the larger (1946) Streak. (See *32nd Jupiter Report of B.A.A.*, page 32, and *B.A.A. Journal* 63, No. 7, pages 252-3 and Pl. xvi.)

XI (5). *Jupiter—Possible Rotation Period of Solid Core (page 159).* By investigating the longitudes of the originating spots of the various upheavals on the south equatorial belt, E. J. Reese has been able to suggest two possible alternatives for the rotation period of the solid body of Jupiter, namely: 9 h. 55 m. 42.66 s. or 9 h. 54 m. 52.5 s. (See *B.A.A. Journal* 63, 6, 219.)

XI (6). *Jupiter—Surface Markings on Galilean Satellites (page 166).* Lyot's team of Pic du Midi observers continued their work of observing and charting the surface markings of the four Galilean satellites, in 1943-4 and 1945. They confirmed with many added details the maps of the satellites they had made in 1941, and also confirmed for each of the four the equality of the periods of rotation and revolution. (See *L'Astronomie*, 1953 January, pages 15-20 and Figs. 9-16.)

XI (7). *Saturn—Ring Divisions (page 180).* The careful observations of Lyot and his associate observers at the Pic du Midi in recent years seem to have definitely established a complex structure of faint divisions in Saturn's rings the objectivity of which had been previously in doubt. From measurements taken with a double-image micrometer Lyot charted the southern face of the rings and gave the following summary of their detailed structure, starting from the outer edge of Ring A:

1. At the outer edge of A a brilliant zone 0.4 sec. of arc wide;
2. a fine black line;
3. another narrow light zone;
4. a wide dusky region (probably Encke's division) in which three minima of light can be distinguished;
5. a quite narrow light zone bordering 6. Cassini's division.

*Ring B:*

7. a narrow bright zone;
8. a wider slightly dusky zone to the central line of the ring, where 9. there is a fairly sharp division dividing the ring into two almost equal parts;
10. a wide bright zone (the brightest in the ring);
11. a double division whose components, well defined, are  $\frac{1}{2}$  sec. of arc apart;
12. a division a little more than half the width of Cassini's separates Ring B from 13. Ring C. (See *L'Astronomie*, 1953 January, page 13 and Pl. 1(5).)

XI (8). *Saturn—Markings on the Satellite Titan (page 181).* Lyot, Bruch, Camichel, Dollfus, and Gentili, using a magnification of 1,250 with the Pic du Midi 24-inch refractor, detected the following markings on Titan: between certain longitudes a light central belt, sometimes oblique, sometimes parallel,

to the equator; between other longitudes a dark equatorial belt with the north polar region light. No definite conclusion as to the rotation period of Titan could be drawn. (See *L'Astronomie*, 1953 January, page 14 and Fig. 8.)

XI (9). *Neptune—Markings* (page 199). Bruch, Camichel, and Dollfus found in their 1948 observations from the Pic du Midi that Neptune shows regular surface markings which seem from the drawings not unlike the chief markings on Mars, and are quite different from the cloudy bands parallel to the equator exhibited by Jupiter and Saturn. (See *L'Astronomie*, 1953 January, page 12 and Pl. I(4).)

APPENDIX XII. *Note on the Nucleus of a Comet*

By M. DAVIDSON, B.A., D.SC., F.R.A.S.

The term 'nucleus' is more applicable in the case of bright comets than it is to the usual type of comets, the great majority of which are very faint. When the nucleus is visible its appearance is almost stellar but in most cases no nucleus is visible though there is frequently some 'central condensation' which is a better description than 'nucleus.' It is now believed that the diameters of the nuclei of comets have been considerably exaggerated and that the figures given for the nucleus of Halley's Comet are very excessive. This may be due to the failure of the observer to distinguish clearly the sharp nucleus from the central condensation of light. This subject was recently discussed by Dr. G. Merton. (See page 261, last reference in Bibliography, for further information on this subject.)

APPENDIX XIII. *Main Sequence Stars* (page 329 ff. and Appendix I).

By E. G. MARTIN, F.R.A.S.

The statement on page 329 and in Appendix I as to the existence of red giants and red dwarfs needs modification in the light of recent research. The data available to Hertzsprung and Russell (1913) consisted of bright stars, which are generally giant stars, and faint fast-moving stars, which are mainly dwarf stars. The latter are only seen at all if they are comparatively close to the solar system; if they were far away (and many are) they would be so much fainter (apparently) that we should not be able to record them. In recent years, however, further work has gone on in examining stars intermediate between bright stars and faint fast-moving stars, and it has been found that some of these are neither giants nor dwarfs in luminosity but between them. This was first discovered at Greenwich and Leander McCormick Observatory, University of Virginia, and has since been corroborated by work at the Cape of Good Hope. In fact red stars can now be graded in a descending scale of real luminosity as super giants, giants, sub giants, bright dwarfs, dwarfs, and faint dwarfs.

At present not many of the stars of intermediate luminosity are known, largely because they have not been searched for. In 1953 the Hertzsprung-Russell diagram consists not only of a horizontal band of giant stars and a diagonal band of main sequence stars—including the red dwarfs—but carrying in addition an ever-increasing number of intermediate red stars between the two main streams.

For further information on this very important discovery see J. Jackson, *The Observatory*, 66, 374 (1945). E. G. Martin, *The Observatory*, 66, 82 (1945). J. Vysotsky, *Ap. J.*, 97, 381 (1943); 104, 235 (1946); 116, 117 (1952).

APPENDIX XIV. *Note on the Spiral Structure of the Galaxy.*

By M. DAVIDSON, B.A., D.SC., F.R.A.S.

An account of the identification of two of the spiral arms of the Galaxy, by W. W. Morgan, of the Yerkes Observatory, was given by Otto Struve (*Astronomical Society of the Pacific*, Leaflet No. 285, 1953 January), just at the time of publication of the first edition of this book, and is as follows:

'The broad band of light of the Milky Way, north through Orion, Taurus, Auriga, Perseus, Cassiopeia, Cepheus, and Cygnus, is really produced by two bands seen superposed over each other. The nearer band is almost straight and extends to a distance of 3000 light-years in Monoceros. In the constellations of Taurus and Perseus this band almost envelops the Sun—the dark nebulae of Taurus are a part of this spiral band. The band then recedes and is more than 3000 years distant in Cygnus. The second spiral arm runs parallel to the first, at an average distance of 5000 or 6000 light-years from it.'

This important discovery by Morgan, to which other collaborators contributed, has been confirmed by several independent researches.



# INDEX

- ABERRATION, chromatic,** 369  
 —, spherical, 366  
 —, stellar, 442, 446  
 Abetti, G., 72, 395  
 Absolute temperature, xviii  
 Achromatic lenses, 369  
 Adams, J. C., 194 ff.  
 Adams, W. S., 434, 443  
 Aerolite, 251  
 Ainslie, M., 152, 181  
 Airy, G. R., 193 ff., 389  
 Albedo, 115, Appendix III  
 Almagest, 410  
 Alter, D., 203  
 Altitude, 451  
 Anaxagoras, 408  
 Anderson, T. D., 323  
 Anderson's rotating prisms, 63  
 Andromeda, great nebula  
   in, xvii, 320  
 Angstrom unit, 12  
 Antoniadi, E. M., 114, 125,  
   135-6, 166, 434-5  
 Aphelion, 221  
 Aquinas, Thomas, 414  
 Aristarchus, 409  
 Astronomical unit, xi, 4, 5,  
   72  
 Atomicity of matter, 10 ff.  
 Aurora, cause of, 268 ff.  
 Auroral forms, 265  
 Azimuth, 455  
  
 Baade, W., 213, 218  
 Bacon, Roger, 414  
 Baldet, F., 138  
 Ball, L. F., 182  
 Balmer series, 14  
 Barnard, E. E., 19, 160,  
   166, 345, 347, 438, 440  
 Barnard's star, 303  
 Bazin, J. R., 182  
 Beer, W., 131, 432, 435  
 Bell, J. R., 280-2  
 Bessel, F. W., 193, 311,  
   443  
 Bethe, H., 22  
 Bianchini, G. F., 120  
 Birkeland, K., 268  
 Birt, W. R., 433  
 'Black body' radiation, 25  
 Blink microscope, 402  
 Bobrovnikoff, N. T., 237  
 Bode, J. E., 6  
 Bode's law, 6  
 Bohr atom, 13  
 Bok, B. J., 445  
 Bolometer, 23  
 Bond, G., 175
- Bond, W. C., 171, 175, 438-  
   439  
 Bouvard, A., 193, 197  
 Bowen, I. S., 444  
 Bradley, J., 372, 442  
 Brooks, W. R., 440  
 Brouyer, D., 440  
 Brown, E. W., 216  
 Bunton, G. W., 203  
 Butterfly diagram, 42  
  
 Camichel, H., 137, 164-5,  
   175  
 Campani, G., 171  
 Campbell, L., 187  
 Canyon Diablo, 253  
 Cape, N. J., 187  
 Carrington, R. C., 431  
 Cassini, J. D., 120, 130,  
   149-50, 178  
 Cassini's division, 170 ff.  
 Challis, J., 194 ff.  
 Charlois, R. L. T., 212  
 Chladni, E. F. F., 441  
 Clark, A. G., 311  
 Clarkson, R. L. T., 182  
 Coblentz, W. W., 144  
 Codeclination, 454-5  
 Coelostat, 394  
 Colatitude, 4, 454  
 Comets:  
   Biela, 246-7  
   d'Arrest, 259  
   Delavan, *frontispiece*  
   Encke, 227, 233, 259-60  
   Giacobini-Zinner, 247,  
     250  
   Halley, 221, 233, 241  
   Pons-Winnecke, 231, 247  
   Schwassmann-Wachmann  
     I, 229  
   Tempel, 247  
   Wolf I, 259  
   1861 (i), 247  
   1862 (iii), 247  
   —, 220 ff., 440-1  
   — and meteor showers,  
     260  
   —, coma of, 226  
   —, composition of, 225 ff.  
   —, disintegration of,  
     239 ff.  
   —, ejection of, 224  
   —, masses of, 229  
   —, orbits of, 226 ff.  
   —, origin of, 233 ff.  
 Coney, E. P., 183  
 Conjunction, 3, 4, 12, 497  
 Copernicus, N., 416-17  
 Coriolis effect, 462, 464  
 Coronagraph, 68-9, 427
- Crommelin, A. C. D., 234  
 Cross-staff, 447  
 Culmination, 4  
 Cycles and epicycles, 4  
 Cyclotron, 21  
 Cysatus, 440  
  
 D'Alembert, J., 428  
 D'Arrest, H. I., 197  
 Dawes, W. R., 131, 171  
 Declination, 455, Appendix  
   VIII  
 Delporte, E., 214  
 Denning, W. F., 182, 255,  
   434, 438, 440-1  
 Densitometer, 401  
 Deslandres, H. A., 427  
 De Vaucouleurs, G., 136,  
   138, 140  
 De Vico, F., 120  
 Dichotomy, 120  
 Diffraction grating, 67  
 Dollfus, A., 115  
 Dollond, J., 373, 424  
 Donati, G., 440  
 Doppler effect, 16-17, 54,  
   426  
 Douglass, A. E., and tree  
   trunks, 69, 138  
 Dunham, T., 434  
  
 Earth shine, 77  
 Eccentricity of orbit, 5  
 Einstein, A., 429  
 Elger, T. G., 433  
 Elongation, 16, 497  
 Encke, J. F., 438  
 Encke's division, 178  
 Eratosthenes, 409-10  
 Eros, 4, 5, 72, 214  
 Evershed, J., 30, 47, 57  
 Evershed effect, 31  
 Eyepieces, 386 ff.  
  
 First point of Aries, 455  
 Flammarion, N. C., 100  
 Flamsteed, J., 185, 423  
 Fontana, F., 130, 435  
 Fournier, G., 138  
 Fox, W. E., 183  
 Franck, J., 142  
 Fraunhofer, J. von, 12, 45,  
   48  
 Fraunhofer's lines, 12, 396-  
   397  
  
 Galactic clusters, 337 ff.  
 Galaxies, external, 349 ff.  
 Galaxy, xv ff., 346 ff.  
 Galileo, 119, 130, 166, 372,  
   418-19, 438

- Galle, G. J., 196-7  
 Gamow, G., 22-3  
 Gassendi, P., 116  
 Gauss, K. F., 436  
 Gegenschein, 273  
 Gentili, M., 164-5  
 Geomagnetic pole, 268  
 Gerard, 413-14  
 Gerbert, 413  
 Gibbous, 120  
 Gill, D., 377  
 Gledhill, J., 154  
 Globular clusters, 337 ff.  
 Gore, J. Ellard, 100  
 Green, N. E., 131, 136  
 Gregory, J., 372, 420  
 Grimaldi, F. M., 432  
 Guinand, P. L., 424
- Haas, W. H., 183  
 Hadley, J., 169, 372  
 Hale, E. G., 431  
 Hale's spectrohelioscope, 62-5  
 Hall, A., 131, 147, 436  
 Hall, C. M., 373, 424  
 Halley, E., 3, 169, 442  
 Hare, E. E., 183  
 Hargreaves, F. J., 152  
 Harvard Observatory Expedition, 255 ff.  
 Hay, W., 182  
 Heath, M. B. B., 113, 116, 182  
 Heis, E., 441  
 Heliographic latitude and longitude, 35  
 Heneke, K. J., 210  
 Henderson, T., 443  
 Hepburn, P. H., 169, 180-1  
 Herschel, A. S., 441-2  
 Herschel, F. W., 88, 130-1, 170-1, 175, 184-5, 190-1, 297-8, 424  
 Herschel, John, 175, 426, 431  
 Hertzsprung, E., 329, 443  
 Hevelius, J., 419, 432  
 Hind, J. R., 211  
 Hipparchus, 409-10  
 Hirayama, K., 216-17  
 Hoffmeister, C., 254  
 Holden, E. S., 166  
 Hooke, R., 130, 153, 372, 437  
 Horrocks, J., 123, 419  
 Hour angle, 455  
 Hubble, E., 213, 445  
 Huggins, W., 443  
 Humason, M. L., 201, 203, 445  
 Huyghenian eyepiece, 386-387  
 Huyghens, C., 130, 166, 169, 422, 438, 439, 443  
 Hydrogen-helium cycle, 22
- Interferometer, 403-4  
 Interstellar matter, xvii, xviii, 343 ff.  
 Ionization, 14

- Jacchia, L. G., 257, 261  
 Jansky, K. G., 356  
 Janssen, J., 48  
 Jones, Sir Harold Spencer, 5, 72  
 Jupiter, 148 ff., 437-8.  
*See also* 206-9  
 —, atmosphere, 159 ff.  
 —, circulating current, 157  
 —, red spot, 153  
 —, satellites, 161 ff.  
 —, south tropical disturbance, 155 ff.  
 —, visibility and appearance, 151
- Kaiser, F., 131, 435  
 Kapteyn, J. C., 445  
 Keeler, J. E., 178, 438  
 Kepler, J., 4, 417  
 Kepler's laws, 418  
 Kirchoff, G. A., 426  
 Kirkwood, D., 179, 216  
 Knight, J., 181  
 Knobel, E. B., 155  
 Kohlschütter, A., 443  
 Kopal, Z., 257  
 Kuiper, G. P., 142, 144, 181, 191, 199, 200, 203, 219, 257  
 Kulik, L. A., 230
- Lagrange, 6  
 Lamont, J., 430  
 Lampland, C. O., 144, 435  
 Langley, S. P., 23-4  
 Langley's bolograph, 24  
 Langrenus, M. E., 432  
 Laplace, P., 178, 196, 441  
 Lassell, W., 171, 191, 199, 200, 424, 439  
 Leavitt, H. S., 317, 445  
 Le Monnier, P., 193  
 Leonardo da Vinci, 415  
 Leuschner, A. O., 219  
 Le Verrier, U. J. J., 195 ff., 439
- Libration, 98  
*Libros de Saber*, 414  
 Light, speed of, 11  
 Light-intensity law, 361  
 Light-year, 290  
 Lindblad, B., 445  
 Line shifter, 63, 66  
 Lippershey, H., 371  
 Lippmann, G., 394  
 Lockyer, J. N., 17, 48, 435  
 Lodge, O., 356  
 Lohrmann, W. G., 82, 433  
 Lovell, A. C. B., 249-50  
 Lovell, P., 124, 133 ff., 186, 201, 429, 435, 439-41  
 Luminous sky, 274  
 Lunar mountains, measuring heights of, 84  
 Lyot, B., 67-8, 115, 164-5, 427  
 Lyttleton, R. A., 235-7
- MacDonald, T. L., 86
- McIntosh, R. A., 159  
 McIntyre, D. G., 181  
 McKinley, D. W. R., 258  
 Mädler, J. H. von, 82, 131  
 Magellanic cloud, 317, 496  
 Magnetic field of sun, 18, 20, 42  
 —, pole, 268  
 —, storm, 70  
 Maraldi, G. F., 130, 170, 435  
 Marq St. Hilaire, 449, 460  
 Mars, 124 ff., 435 ff. *See also* 206-9  
 —, atmosphere, 142  
 —, canals, 133 ff.  
 —, deserts, 137  
 —, oppositions, 126  
 —, polar cap, 131 ff.  
 —, satellites, 147  
 —, seasons, 127  
 —, temperature, 144  
 —, visibility, 128  
 Maskelyne, N., 392  
 Maunder, E. W., 42-3  
 Maunder's butterfly diagram, 43  
 Maxwell, J. C., 178-9, 438  
 Méchain, P. F. A., 259  
 Melotte, P. J., 161, 197  
 Menzel, D. H., 30, 144, 199, 439
- Mercury, 110 ff., 434. *See also* 206-7  
 —, albedo, 115  
 —, atmosphere, 115  
 —, markings, 114 ff.  
 —, phases, 113-14  
 —, transits, 116  
 —, visibility, 119
- Meridian, 455  
 Messier, C., 440  
 Meteorites, 251 ff.  
 —, composition of, 251  
 —, Siberian, 230 ff.  
 —, Sikhote-Alinsk, 252  
 —, sizes and masses, 252 ff.
- Meteors, 241 ff., 440-1  
 —, heights of, 242  
 —, observations, 254 ff.  
 —, orbits, 242 ff.  
 —, radar and, 249 ff.  
 —, radiants, 244 ff.  
 —, real paths, 243 ff.  
 —, sizes and masses, 252 ff.
- , speeds, 242 ff.  
 Michell, J., 442  
 Michelson, A. A., 403-4  
 Micrometer, 398-9  
 Millman, P. M., 258, 441  
 Minor planets, 210 ff., 436-437  
 —, discoveries, 210 ff.  
 —, families of, 216 ff.  
 —, masses of, 218  
 —, number of, 213  
 —, orbits of, 218  
 —, origin, 219

- Mohammed, 411  
 Molesworth, P. B., 136-7, 152  
 Monochromator, 67  
 Moon, 73 ff., 432 ff.  
 —, a trip to, 91 ff.  
 —, measuring heights of mountains, 84 ff.  
 —, mountains and craters, 75 ff.  
 —, occultations by, 105 ff.  
 —, origin of, 104  
 —, surface features, 75 ff.  
 Moore, J. H., 199, 439  
 Müller, J., 115, 415  
 Murayama, S., 172, 176
- Nasmyth, J., 120  
 Nebulae, xvii  
 —, external, 349 ff.  
 —, galactic, 340 ff.  
 Neison, E., 433  
 Neptune, 192 ff., 439. *See also* 206-9  
 —, atmosphere, 199  
 —, discovery of, 196 ff.  
 —, satellites, 199-200  
 Newton, I., 366, 372, 395, 421  
 Newton's *Principia*, 421, 428  
 Nicholson, S. B., 144, 161, 435  
 Nicol prism, 60  
 Nutation, Appendix VIII
- Occultations, 105-7  
 Olbers, H. M. W., 210, 219  
 Olivier, C. P., 254-5, 441  
 Oort, J. H., 219, 237-8, 445
- Öpik, E. J., 142, 254-5  
 Opposition, 12, 497
- Palisa, 212  
 Parallax angle, 455  
 Paton, J., 276, 283-5  
 Peek, B. M., 152, 153, 157-9, 163-4  
 Penumbra, 29 ff.  
 Perihelion, 221  
 Perrine, C. D., 161, 440  
 Perrotin, H., 135  
 Perturbations, 3, 192, 200, 229
- Peters, C. H. F., 212  
 Pettit, E., 144, 435  
 Phillips, J., 138  
 Phillips, T. E. R., 137, 152, 159, 182, 435, 437  
 Photo-electric cells, 400-1  
 Photometer, 399  
 Photosphere, 26  
 Piazzi, G., 210, 436  
 Picard, J., 171  
 Pickering, W. H., 96, 166, 182, 435, 439-40  
 Planck, M., 13  
 Planck's constant, 13  
 Planetary data, 206-7

- Pluto, 200 ff., 439-40. *See also* 206-7  
 —, a trip to, 204  
 —, diameter, 203, 440  
 —, discovery, 200 ff.  
 Pons, J. L., 440  
 Porter, J. G., 213, 248-9, 254, 256, 260  
 Position line, 449, 460 ff.  
 Pound, J., 372  
 Precession, Appendix VIII  
 Prentice, J. P. M., 254, 256-7, 441  
 Proctor, R. A., 100, 131, 181, 234  
 Proton-proton reaction, 335  
 Prutenic Tables, 417  
 Ptolemy, 410-11  
 Pyrheliometer, 23  
 Pythagoras, 407-8
- Quantum, 13  
 —, mechanics, 21
- Radiation pressure, 15, 335  
 Radioactivity, 20  
 Ramsden eyepiece, 387  
 Ramsey, W. H., 149, 239  
 Red shifts, 355 ff.  
 Reese, E. J., 152, 180, 183  
 Reflection, law of, 362  
 Regiomontanus, 115, 415, 449. *See also* Müller, J.
- Reid, W., 181  
 Reinhold, E., 417  
 Reimuth, K., 212, 214, 216  
 Reversing layer, 45  
 Riccioli, J. P., 432  
 Right Ascension, Appendix VIII
- Roberts, I., 338  
 Roche's limit, 182, 219  
 Roemer, O., 162, 370, 422  
 Roques, P. E., 203  
 Ross, F. E., 144, 377  
 Rosse, Earl of, 373, 424  
 Rowland, J. B., 279  
 Russell, A. N., 175, 237, 330, 443  
 Rutherford, E., 21  
 Ryves, P. M., 327
- Satellite data, 208-9  
 Saturn, 166 ff., 438-9.  
*See also* 206-9  
 —, appearance and colour, 171 ff.  
 —, atmosphere, 177 ff.  
 —, Cassini's division, 170  
 —, imaginary visit to, 183-4  
 —, origin of satellites and rings, 182  
 —, rings, 166 ff.  
 —, satellites, 181  
 —, visibility, 173 ff.
- Scheiner, C., 429  
 Schiaparelli, G., 114, 122, 131, 133, 137-8, 150, 434-5
- Schmidt, B., 376-7  
 Schmidt reflector, 376-7  
 Schröter, J. H., 115, 120, 150, 175, 432-5  
 Schwabe, H., 39, 153, 430  
 Secchi, A., 132, 443  
 Sextant, 462 ff.  
 Shapley, H., 445  
 Short, J., 424, 430  
 Sidereal and synodic periods of planets, 206; of Sun's rotation, 16  
 Sidereal month, 92  
 Siderite, 251  
 Siderolite, 251  
 Slipper, V. H., 186, 445  
 Solar constant, 25  
 —, diagonal, 59  
 —, noises, 71  
 —, spectrum, 10-11
- Spectrograph, 397  
 Spectroheliograph, 53 ff., 61  
 Spectroheliograph, 62-3  
 Spectroscope, 61, 367, 396-397  
 Spitzer, L., 445  
 Spoerer, F. W. G., 431  
 Spoerer's law, 42  
 Stars, 286 ff., 442 ff.  
 —, absolute magnitude, 290  
 —, Cepheid variables, 315 ff.  
 —, classification, 326 ff.  
 —, colours and temperatures, 325 ff.  
 —, distances, 291 ff.  
 —, double and binaries, 303 ff.  
 —, dwarfs, 9, 326-9  
 —, eclipsing binaries, 312 ff.  
 —, energy radiated by, 331 ff.  
 —, giants, 329  
 —, irregular variables, 321 ff., 331 ff.  
 —, long period variables, 321  
 —, magnitudes, 287 ff.  
 —, main sequence, Appendices I and XIII  
 —, novae, 322 ff.  
 —, origin of binaries, 336  
 —, origin of radiation, 335  
 —, parallax, 293 ff.  
 —, proper motions, 300 ff.  
 —, sizes and masses, 329 ff.  
 —, spectroscopic binaries, 311  
 Stationary points, 3  
 Sumner, Captain, 449  
 Sun, 8 ff., 429 ff.  
 —, Absolute Magnitude, 9  
 —, chromosphere and prominences, 44 ff.  
 —, corona, 18 ff.

- Sun, energy, source of, 20  
 ff.  
 —, faculae, 37  
 —, flares, 55 ff.  
 —, pore, 31  
 —, spectrum, 11  
 —, structure and composition, 15  
 —, sunspots, 29 ff.  
 —, surface, 26  
 Swift, L., 440  
 Sylvester II, 413  
 Telescope, 371 ff.  
 —, construction of a simple, 108  
 —, Mount Palomar, xvii, 289, 440  
 Telescopic mountings, 378  
 ff.  
 Thales, 408  
 Thomson, H., 139  
 Thornton, F. H., 183  
 Titius, J. B., 6  
 Tombaugh, C., 201  
 Transit circle, 389 ff.  
 Trouvelot, E. L., 138  
 Tycho Brahe, 417  
 Ulugh Beigh, 413  
 Umbra, 29 ff.  
 Uranus, 184 ff., 439. *See*  
*also* 206-9  
 —, atmosphere, 187  
 —, discovery, 185-6  
 —, satellites, 190 ff.  
 —, tilt of axis, 189  
 —, visibility and appearance, 187  
 Van Biesbroeck, G., 200  
 Van den Bos, W. H., 214  
 Van Woerkom, A. F. F., 238  
 Venus, 117 ff., 434-5. *See*  
*also* 206-7  
 —, albedo, 120  
 —, atmosphere, 122  
 —, 'black drop,' 122  
 —, phases, 119  
 —, transits, 116  
 —, visibility, 119  
 Vogel, H. C., 443  
 Waterfield, R. L., 133, 135  
 Watson, F. G., 214, 218  
 Weber, A., 182  
 Weinek, L., 433  
 Weizsäcker, C. von, 22  
 Whipple, F. L., 255-9, 441  
 White, E. K., 182  
 Wildt, R., 122, 149, 153,  
 159, 177, 188, 437-8  
 Williams, A. S., 135, 152,  
 182, 437  
 Wilson, A., 430  
 Wilson effect, 37  
 Witt, G., 213  
 Wolf, Max, 212  
 Wolf, R., 39 ff.  
 Wolf relative numbers, 39 ff.  
 Wollaston, W. H., 395, 426  
 Wren, C., 421  
 Wright, T., 170  
 Wright, W. A., 144  
 Wylie, C. C., 440  
 Young, C. A., 427  
 Zeeman effect, 42  
 Zodiac, 2, 6  
 Zodiacal light, 270 ff.  
 Zöllner, C. F., 115  
 Zucchi, N., 437  
 Zupi, G. P., 437



### NORTHERN SKY

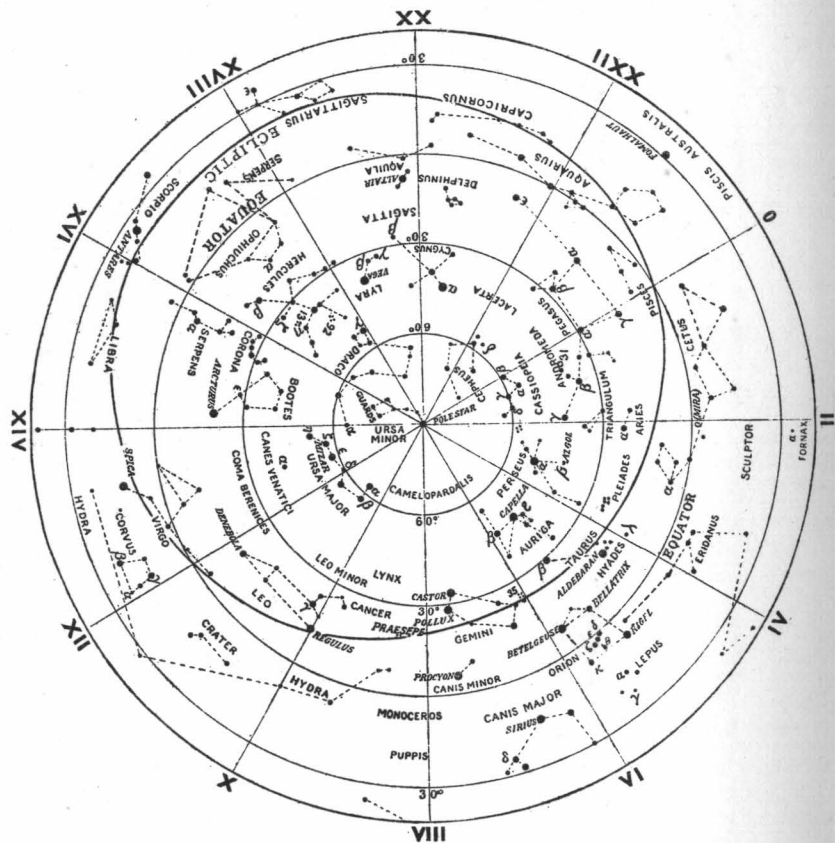

### SOUTHERN SKY

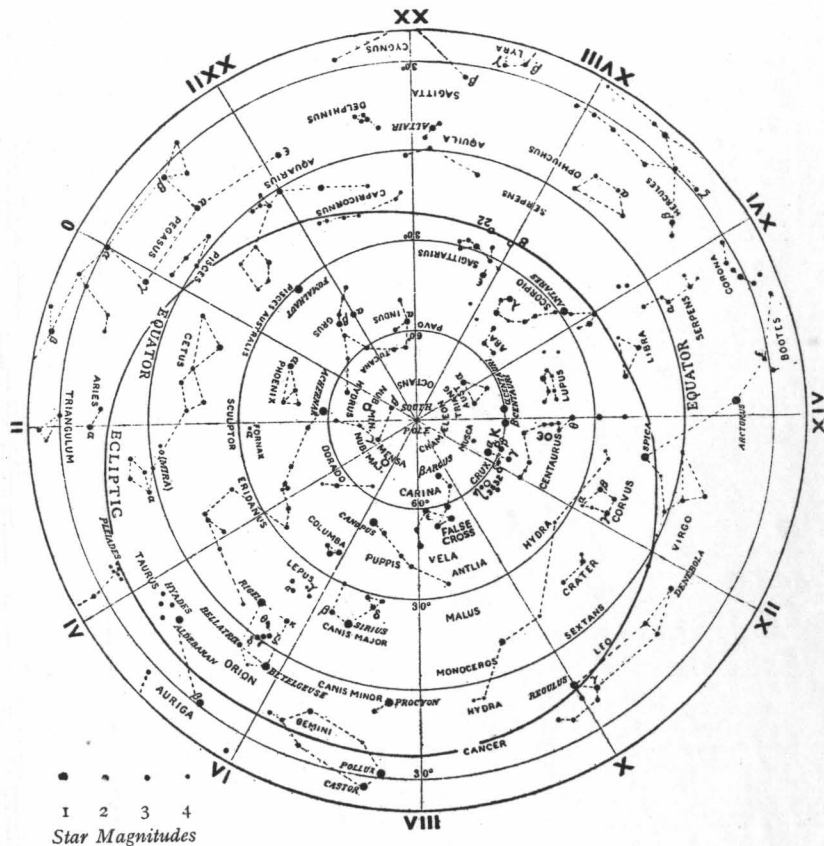

The northern and southern skies extended respectively to  $40^\circ$  south and  $40^\circ$  north of the equator. Stars up to magnitude 4 are shown.

The Roman numerals round the edge refer to Right Ascension, and the numbered circles to Declination, each circle being separated by  $30^\circ$ .

ASTRONOMY  
FOR  
EVERYMAN

EDITED BY  
M. DAVIDSON

DENT  
DUTTON



# ASTRONOMY FOR EVERYMAN

Edited by MARTIN DAVIDSON, B.A., D.SC., F.R.A.S.

## Contents and Contributors

### INTRODUCTION: A GENERAL VIEW OF THE UNIVERSE

By M. DAVIDSON, B.A., D.SC., F.R.A.S.  
President of the British Astronomical Association, 1936-8

### THE SOLAR SYSTEM

By M. B. B. HEATH, F.R.A.S.  
Director of Saturn Section, British Astronomical Association

### THE SUN

By F. J. SELLERS, M.I.MECH.E., F.R.A.S.  
Director of Solar Section, British Astronomical Association, 1937-51

### THE MOON

By Dr H. P. WILKINS, F.R.A.S.  
Director of Lunar Section, British Astronomical Association

### THE PLANETS

By M. B. B. HEATH, F.R.A.S.  
Director of Saturn Section, British Astronomical Association; and  
A. F. O'D. ALEXANDER, M.A., PH.D., F.R.A.S.  
Director of Jupiter Section, British Astronomical Association

### MINOR PLANETS

A. F. O'D. ALEXANDER, M.A., PH.D., F.R.A.S.

### COMETS, METEORS AND METEORITES

By M. DAVIDSON, B.A., D.SC., F.R.A.S.  
Formerly Director of Comet Section, British Astronomical Association

### THE AURORA AND ZODIACAL LIGHT

By W. B. HOUSMAN, F.R.A.S.  
Formerly Director of Aurora and Zodiacal Light Section,  
British Astronomical Association

### THE STARS

By P. DOIG, F.R.A.S.  
Editor of *The Journal of the British Astronomical Association*  
Author of *An Outline of Stellar Astronomy*

### LIGHT AND INSTRUMENTS

By E. G. MARTIN, F.R.A.S.  
Senior Experimental Officer, Royal Observatory, Greenwich

### HISTORY OF ASTRONOMY

By H. L. KELLY, F.R.I.B.A., F.R.A.S.  
Director of Historical Section, British Astronomical Association; and  
PETER DOIG, F.R.A.S.  
Author of *A Concise History of Astronomy*

### NAVIGATION

By J. B. PARKER, M.A., and  
W. A. SCOTT, B.SC., F.R.A.S.  
H.M. Nautical Almanac Office

### THE ROAD TO THE PLANETS

By A. C. CLARKE, B.SC., F.R.A.S.  
Chairman of the British Interplanetary Society.  
Author of *Interplanetary Flight, The Exploration of Space*, etc.

### NOTES ON IDENTIFICATION

By E. O. TANCOCK, B.A., F.R.A.S.  
Author of *Starting Astronomy, Philips's Chart of the Stars*, etc.

### APPENDICES

By M. DAVIDSON, B.A., D.SC., F.R.A.S.,  
A. F. O'D. ALEXANDER, M.A., PH.D., F.R.A.S.,  
and E. G. MARTIN, F.R.A.S.

532 pages. Over 200 line drawings,  
photographs, and diagrams

# ASTRONOMY

FOR

EVERYMAN



Edited by

DR M.

DAVIDSON



SOLAR SYSTEM

THE SUN

THE MOON

THE PLANETS

MINOR PLANETS

COMETS, METEORS

AURORA AND  
ZODIACAL LIGHT

THE STARS

LIGHT AND  
INSTRUMENTS

HISTORY OF  
ASTRONOMY

NAVIGATION

THE ROAD  
TO THE  
PLANETS

NOTES ON  
IDENTIFICATION



DENT