

EVELETH'S
SCHOOL HOUSE
ARCHITECTURE.

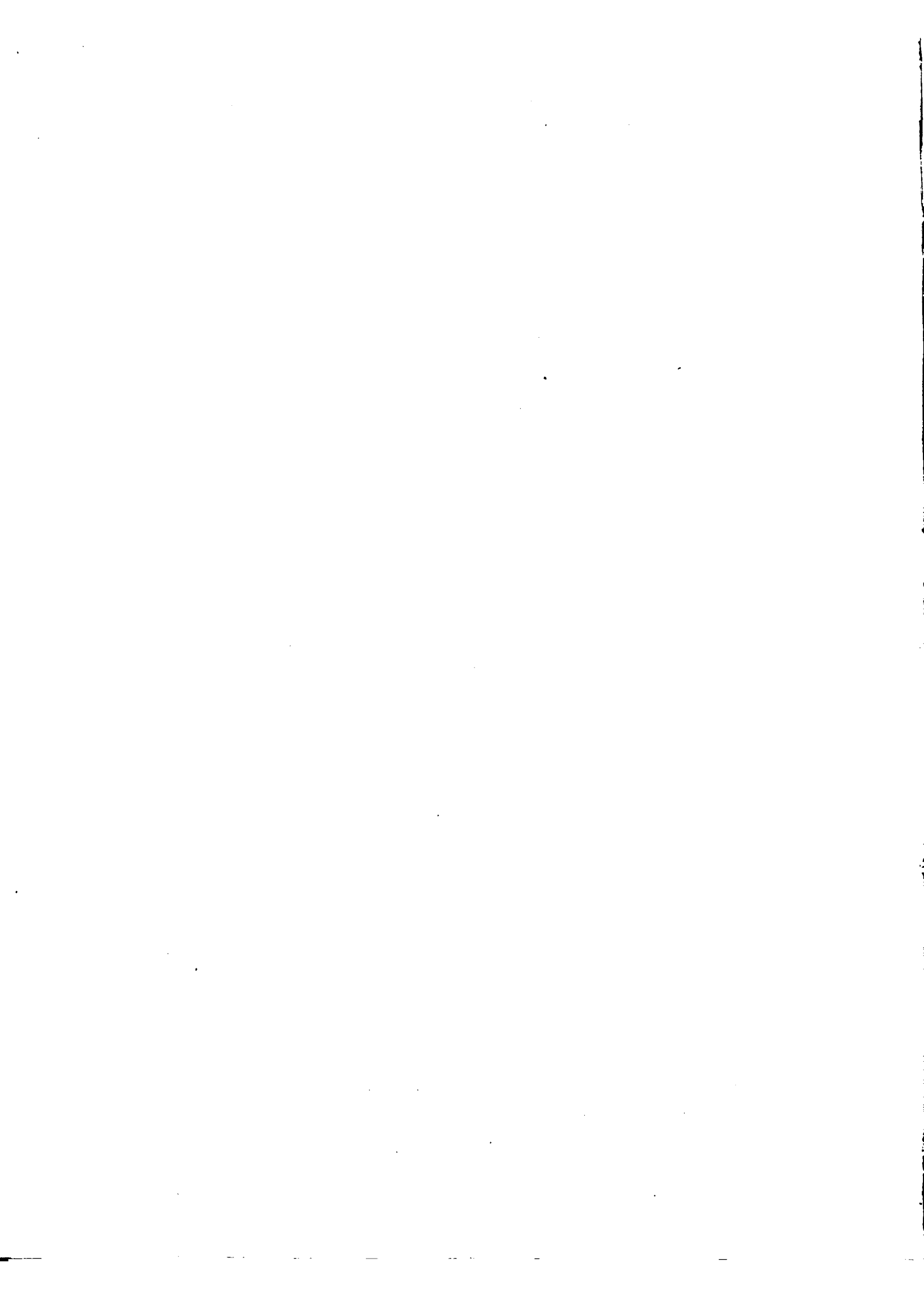

School House
ARCHITECTURE
BY

SAMUEL F. EYEBETH,
ARCHITECT.

(New York,)
Geo. E. Woodward.

Engraved & printed by KORFF BRO'S. New York.

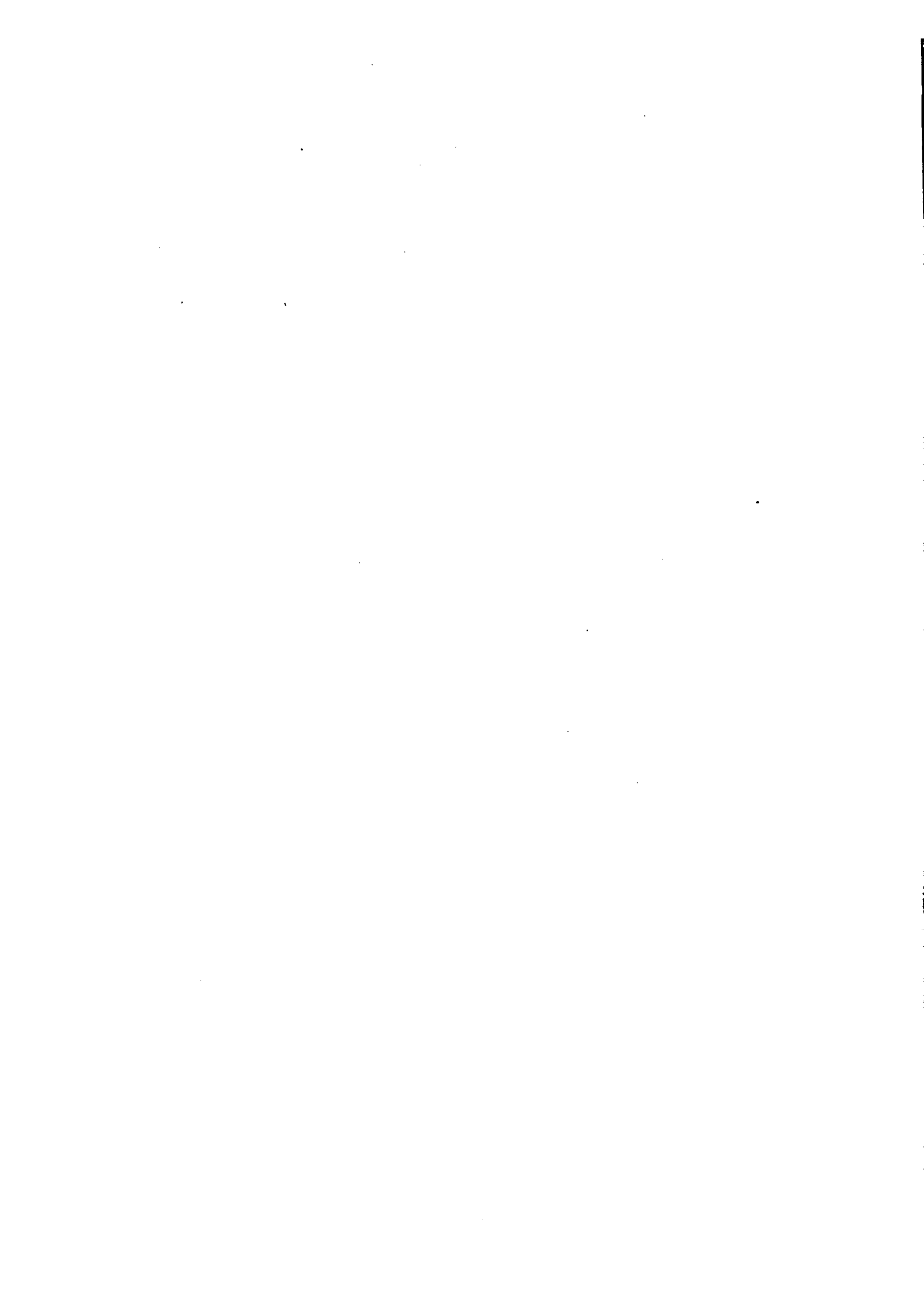

SCHOOL-HOUSE
ARCHITECTURE.

ILLUSTRATED IN

SEVENTEEN DESIGNS,
IN VARIOUS STYLES.

WITH FULL DESCRIPTIVE DRAWINGS IN PLAN, ELEVATION,
SECTION AND DETAIL.

BY

SAMUEL F. EVELETH, ARCHITECT,
NEW-YORK.

NEW YORK:
GEO. E. WOODWARD.

Entered according to Act of Congress in the year 1870, by
GEO. E. WOODWARD,
In the office of the Librarian of Congress, at Washington.

EDWARD O. JENKINS,
Printer and Stereotyper,
20 NORTH WILLIAM STREET.



CONTENTS.

DESIGN No. 1. A frame country School-House, with one room, for pupils of both sexes.
With specification.

Plate 1. Perspective view.

" 2. Front elevation, $\frac{1}{8}$ -inch to the foot, and floor plan, $\frac{1}{16}$ -inch to the foot.

" 3. End elevation and section, $\frac{1}{8}$ -inch to the foot.

" 4. Details, $\frac{1}{2}$ -inch to the foot.

DESIGN No. 2. A frame country School-House, with one room and large veranda.

Plate 5. Front elevation and ground plan, $\frac{3}{32}$ -inch to the foot.

" 6. Side and rear elevations, $\frac{3}{32}$ -inch to the foot.

" 7. Details, $\frac{1}{2}$ -inch to the foot.

DESIGN No. 3. A frame country School-House, with wings, containing one room.

Plate 8. Front elevation, and floor plan, $\frac{1}{8}$ -inch to the foot.

" 9 and 10. Elevations, $\frac{1}{8}$ -inch to the foot, and details, $\frac{1}{2}$ -inch to the foot.

DESIGN No. 4. A frame country School-House, with wings, containing one room, with alcoves.

Plate 11. Elevation and ground plan, $\frac{1}{8}$ -inch to the foot

" 12. Elevation, $\frac{1}{8}$ -inch to the foot, and details, $\frac{1}{2}$ -inch to the foot.

" 13. Details, $\frac{1}{2}$ -inch to the foot.

1-7-46. Margaret

NAG610
E939
EST
[Signature]

(RECAP)

DESIGN No. 5. A brick School-House, with tower, containing two octagonal rooms.

Plate 14. Elevation and floor plan, $\frac{1}{16}$ -inch to the foot.

“ 15. Elevation, $\frac{1}{16}$ -inch to the foot, and details, $\frac{1}{2}$ -inch to the foot.

“ 16. Details, $\frac{1}{2}$ -inch to the foot. Section, $\frac{1}{8}$ -inch to the foot.

DESIGN No. 6. A brick School-House, of Gothic expression, with two rooms.

Plate 17. Elevation and floor plan, $\frac{1}{16}$ -inch to the foot.

“ 18. Elevation, $\frac{1}{16}$ -inch to the foot, and details, $\frac{1}{2}$ -inch to the foot.

“ 19. Details, $\frac{1}{2}$ -inch and 1 inch to the foot.

DESIGN No. 7. A frame School-House of two stories, the upper one contained in a Mansard roof, with one room in each story, and two separate entrances.

Plates 20 and 21. Elevations and plans, $\frac{1}{8}$ -inch to the foot.

“ 22. Details, $\frac{1}{2}$ -inch to the foot.

DESIGN No. 8. A frame School-House, with steep roof and tower of two stories, with one room in each story.

Plate 23. Elevation and plan, $\frac{1}{8}$ -inch to the foot.

• “ 24. Elevation and plan, $\frac{1}{16}$ -inch to the foot, and details, $\frac{1}{2}$ -inch to the foot.

“ 25. Details, $\frac{1}{2}$ -inch to the foot.

DESIGN No. 9. A frame School-House, with steep roof and gables, of two stories, with one room in each story, and two separate entrances.

Plates 26 and 27. Elevations and plans, $\frac{8}{32}$ -inch to the foot.

“ 28. Section $\frac{8}{32}$ -inch to the foot, and details, $\frac{1}{2}$ -inch to the foot.

“ 29. Details, $\frac{1}{2}$ -inch to the foot.

DESIGN No. 10. A two story frame School-House, with one room upon each floor, and two entrances. (Two styles of elevations.)

Plate 30. Two elevations and two plans, $\frac{1}{16}$ -inch to the foot.

“ 31. Details, $\frac{1}{2}$ -inch to the foot.

“ 32. Section, $\frac{1}{8}$ -inch to the foot, and details, $\frac{1}{2}$ -inch to the foot.

“ 33. Alternate elevations, $\frac{1}{16}$ -inch to the foot, and details, $\frac{1}{2}$ -inch to the foot.

DESIGN No. 11. A frame School-House, two stories in height, with two entrances, and with one school-room and two class-rooms in each story.

Plate 34. Two elevations, and two plans, $\frac{1}{16}$ -inch to the foot.

“ 35. Details, $\frac{1}{2}$ -inch to the foot.

DESIGN No. 12. A frame School-House, two stories in height, with third story within a steep roof. The third story containing one large room, and the other two stories containing two separated rooms in each.

Plates 36, 37 and 38. Elevation and plans, $\frac{1}{16}$ -inch to the foot.

“ 39. Section, $\frac{1}{8}$ -inch to the foot, and details, $\frac{1}{2}$ -inch to the foot.

“ 40. Details, $\frac{1}{2}$ -inch to the foot.

DESIGN No. 13. A frame School-House, with Mansard (convex) roof, containing the same accommodation as the preceding, the two rooms upon each floor arranged so as to be thrown into one. With specification.

Plate 41. Perspective view.

“ 42 and 43. Plans and elevations, $\frac{1}{16}$ -inch to the foot.

“ 44. Two floor plans, $\frac{1}{16}$ -inch to the foot, and details, $\frac{1}{2}$ -inch to the foot.

“ 45 and 46. Details, to different scales.

DESIGN No. 14. A frame School-House, with veranda and bell-tower, and the same accommodation as the preceding design.

Plate 47. Two elevations, $\frac{1}{16}$ -inch to the foot.

“ 48. Three floor plans, $\frac{1}{16}$ -inch to the foot.

“ 49 and 50. Details, to different scales.

DESIGN No. 15. A brick School-House, adapted for two high schools, three stories in height, two stories containing one large room and two class-rooms each, and the third story containing one large lecture hall. Irregular steep roof. With specification.

Plates 51 and 52. Elevations and plans, $\frac{1}{16}$ -inch to the foot.

“ 53. Elevation, $\frac{1}{16}$ -inch to the foot, and details, $\frac{1}{2}$ -inch to the foot.

“ 54 and 55. Details, $\frac{1}{2}$ -inch to the foot.

DESIGN No. 16. A frame School-House, with two full stories, and Mansard roofs. Each story containing three connected school-rooms.

Plates 56 and 57. Elevations and plans, $\frac{1}{16}$ -inch to the foot.

“ 58. Two floor plans, $\frac{1}{16}$ -inch to the foot.

“ 59. Section, $\frac{1}{8}$ -inch to the foot.

“ 60. Details, $\frac{1}{2}$ -inch to the foot.

DESIGN No. 17. A brick School-House, three stories in height, with accommodation for four classes upon each floor.

Plate 61. Perspective view.

“ 62 and 63. Elevations and plans, $\frac{1}{16}$ -inch to the foot.

“ 64. Two floor plans, $\frac{1}{16}$ -inch to the foot.

“ 65. Section, $\frac{1}{8}$ -inch to the foot, and details, $\frac{1}{2}$ -inch to the foot.

“ 66. Details, $\frac{1}{2}$ -inch to the foot.

“ 67. Details of inside blinds and platform stairs to different scales.

DESIGN NO. 1.

SPECIFICATION.

MASON'S WORK.

EXCAVATION. Dig out the earth to the depth required on the sectional drawing, for the foundation walls and the piers, and to the depth of 3 feet for the drains.

Make level and solid the bottom of the trenches for the reception of the intended work.

Excavate also for the cess-pool hereinafter required, and for the water-closet vault.

When the several parts of the works for which excavation is required have been set, fill in the earth around and over them to the grade, and level off or cart away the remaining earth.

DRAINAGE. The drain-pipes required to be of the best quality of well burned earthenware pipe, with all required angles, properly laid, and cemented at the joints.

Set one 3-inch drain from the lower end of one of the rain-water leaders to the water-closet vault, and one 5-inch pipe from that vault to the cess-pool.

CESS-POOL. To be built with good building stone, laid without mortar. To be 5 feet in diameter, and 6 feet deep. Cover two feet below the grade with sound hemlock plank, three inches thick. Set the cess-pool at least 50 feet from the building.

- FOUNDATION WALLS.** Use good large-sized angular stones for the trench walls shown on the sectional drawing, and build them 20 inches in thickness, and 3 feet in height.
- Set stone foundations for the piers carrying the floor timbers, and for the steps.
- UNDERPINNING WALLS.** Build the underpinning walls $3\frac{1}{2}$ feet high, and 8 inches thick. Build the piers carrying the first floor 8 inches square, also two piers of the same size to carry each porch floor.
- All these piers to start at least 3 feet below the grade.
- Build the water closet vault as exhibited in detailed drawings for Design 3, Plate 10. Make the connections with the drains in the best manner, and give the interior two coats of cement.
- Leave an opening 2 feet wide in the underpinning, behind each set of door steps.
- CHIMNEY.** Build the chimney with one flue, 16 by 20 inches, pargetted throughout.
- Set, upon one side of the flue, a 6-inch earthen pipe, properly secured to the bricks by iron straps at the joints, and provided with branch for the stove pipe to enter.
- Provide two ventilating registers of ornamental pattern in japanned iron, provided with valves and all fittings required for working them, and set the same in the chimney, one at the bottom, and the other at the top of the room. The opening in each register to be equal to 12 by 18 inches.
- BRICKS.** All the bricks used in the above work to be of good quality, hard burned, and well formed. Lay those required for the underpinning, vault, piers, and chimney above the roof, with cement mixed with equal portions of clean, sharp sand. Lay the remainder of the bricks with good strong lime mortar.
- Finish the chimney top as required by the drawings.
- Select the best shaped and most uniformly colored bricks for those parts of the work exposed to view, and finish them with narrow and accurate joints.
- BRICK FILLING.** Line up the outer walls, as high as the ceilings, with good bricks set flush with the inner edge of the studding, and set on edge.

Furnish and put in grouting of coarse mortar between the beams in the floor.

LATHING AND
PLASTERING.

Lath the ceilings, and the partitions with good sound pine laths, free from bark, breaking joints at every sixth lath.

Plaster the walls, ceiling and partitions with two good coats. The first to be of hair mortar, well floated, and the second of clean, sharp sand, and plaster of Paris, trowelled down perfectly smooth, except so much as is included in the black-boards in the school-room, which is to be formed of a proper composition to finish black and with a proper surface for black-board use.

Run a stucco cornice at the angle of the school-room ceiling, of the size and pattern given on the detailed drawings.

Finish the recess for the stove with half domed top, and chamfer and bead at the outer angle.

CARPENTER'S WORK.

All timber required for the framing is to be sound and square edged, and of the sizes specified below.

Timber in the first floor, including the steps, to be of pine or chestnut; in the rest of the framing of spruce.

Sills to be 4 by 6 inches, halved together and well nailed at the angles.

Girders (4 in number), 6 by 9 inches.

Flooring 2 by 9 inches, set not more than 16 inches on centres, and bridged with 1 by 3 pieces, well nailed.

Sills for "Porches," 4 by 6 inches, and joists 2 by 6 inches.

Corner studs, 4 by 4 inches; window and door studs, 3 by 4 inches; and wall studs 2 by 4 inches; the last named set 16 inches apart.

Wall plates, 4 by 4 inches.

Rafters 2 by 9 inches, set 20 inches on centres.

Ceiling pieces, 2 by 8 inches.

Secure the lower ends of the rafters to the ceiling pieces, by two $\frac{3}{4}$ inch bolts at each end.

Suspension pieces, and braces shown in the section, 2 by 8 inches, well spiked to the rafters and the ceiling pieces.

Partition studs 2 by 4 inches, set 16 inches on centres, and bridged with herring-bone bridging. Nail the studding to the sills and the plates thoroughly, and execute all the framing in the best manner.

EXTERIOR-WALLS. Cover all the exterior vertical walls with pine sheathing, planed $\frac{3}{4}$ inches thick, matched, and put up in widths not exceeding 6 inches to each piece. Take pains to set this sheathing as close as possible, and nail with two 9d. nails to each bearing.

ROOF. Cover the roof with sound roofing boards of uniform thickness, set close and well nailed.

FINISH. Corner boards, window and door casings, and belt over windows to be $1\frac{1}{4}$ inches thick. Water table to project 2 inches, and that as well as the belt, to have a lipped top piece connecting with the sheathing.

Cornice as by the drawings, with chamfered facia. Brackets carrying door hoods of 5 by 6 inch timber chamfered, and filled with 1 inch thick scroll sawed work.

Corner brackets 4 inches thick and chamfered. Form a gutter in the cornice, as shown by the drawings. Finish the roof with roll and cresting, the latter two inches thick.

Build the belfry with 6 by 6 inch chamfered posts, starting from the bottom of the ceiling joists, and secured to them and to the rafters by 2 half inch bolts at each bearing.

Finish the belfry with finial, scroll sawed verge boards, 2 inches thick, and brackets 4 inches thick, as by the drawings, and put in a wooden tube $2\frac{1}{2}$ inches square to carry the bell rope through the roof and the ceiling of the piazza.

Finish the steps with 2 inch treads and platform, and $\frac{3}{4}$ -inch risers, and put up chamfered posts, buttresses, and balustrades as required by the design.

Floor to piazzas of $1\frac{1}{2}$ -inch plank, matched, and set with $\frac{1}{2}$ -inch pitch outward.

Paint the joints before setting, and have no piece in the flooring exceed 4 inches in width. Sheath up the ceilings of the piazzas with ma-

materials like those required for the vertical walls, and finish them with posts and balustrades, as required by the design.

MATERIALS.

All the materials required for the exterior finish to be of thoroughly seasoned pine, free from sap, shakes, and large, loose, or dead knots.

TINNING.

Cover the main roof and the roof of the belfry with best charcoal tin, of XX thickness.

Put the tin on with standing joints, and make the roofs weather proof.

Line the gutters in the cornice with tin as above, well soldered and secured, and fasten the fascia back with galvanized iron straps secured to the roof, and set not more than 3 feet apart.

Put up 4 leaders of 3 inches calibre, connecting with the gutters. To be of tin, of the quality required for the gutters. Connect one of them with the drain leading to the water closet vault, and secure them all to the walls with metallic fastenings. Terminate three of them with 8-inch elbows at the ground.

Paint all the tin work with 3 good coats of white lead paint, the last coat tinted slate color.

DOORS.

The entrance doors to be 2 inches thick, and of the size shown on the elevation. To be made in 8 panels, the two upper ones stationary, and the four central ones glazed with double thick glass, protected on the outside by ornamental iron screens. The rest of the doors, except those in the water closets to be 1½ inches thick. School-room doors 3½ by 8 feet, those connecting with piazzas, &c., 3 by 8 feet. All the above doors to be finished with raised mouldings.

Water closet doors 2½ by 6½ feet, 1¼ inches thick. The external openings on the rear (to water closets, and to fuel room) to be closed by doors 1½ inches thick, of lattice work made of 1 by 2 inch stuff.

Hang the last named doors with strong strap hinges, and put on large-sized rim locks. Hang all the other doors with 4½ by 4½ butt hinges, (3 to each of the entrance doors,) and put to all of them mortise locks and latches, with brass bolts and facings. The locks to be of approved "lever" pattern, and the handles of white "porcelain."

WINDOWS.

The windows in the gable ends to be finished with shades, as shown on the detailed drawings. Those connecting with the piazzas to be finished in the French manner. Sashes $1\frac{3}{4}$ inches thick, rebated and lipped at the centre joints, hung with butt hinges and fitted with latches, and bolts at top and bottom.

The sashes in the 3 front windows to be double hung with axle pulleys, iron weights, and best bleached sash cord, and fitted with spring centre fasts with white "porcelain" tips.

These sashes to be $1\frac{3}{4}$ inches thick and weather lipped at the meeting rail. Glass to be double thick, and of the best quality of English or French sheet.

BLINDS.

The three front windows to be fitted with outside blinds, $1\frac{1}{4}$ inches thick, to be made with 4 panels to the window, and swivel shades. Put on with most approved wrought iron hinges and fastenings.

All the doors, window sashes and blinds to be made of clear thoroughly seasoned, kiln-dried white pine.

FLOORS.

Cut in and fasten between the flooring joists, sound hemlock boards to carry the grouting required of the mason.

Lay the floor with thoroughly seasoned pine or spruce planks, 3 inches wide, and $1\frac{1}{4}$ inches thick, planed, matched, blind nailed, and smoothed off after laying. This flooring to be free from shakes, cracks, pitch, holes, and loose or rotten knots.

Make a trap door, 2 by 3 feet in the floor of the boys' entry, and fit it with 2 rings and staples. Also a trap door of the same size in the ceiling of the piazza, next the boys' entry.

Raise the teacher's platform 7 inches, and finish at the edge with scotia and torus.

Thresholds of Southern hard pine.

FURRING.

Cross-fur the ceilings throughout, except as otherwise provided for, with sound 1 by 3 inch spruce strips set 16 inches on centres.

Fur out with the rough brackets required for the cornice.

PARTITIONS.

Finish the recess for the stove with half-spherical top; the whole height

of the recess to be 10 feet. Form the partitions dividing the water closets of planed and matched 1 inch stuff, set vertically, capped at the top, and 8 feet high.

Sheath up the walls of the fuel room the entire height, and those of the entries and room containing the water closets to the height of 8 feet with materials similar to those specified for the external sheathing. Finish the 8 feet high sheathing with moulded cap.

The walls and partitions of the school-room to be sheathed up to the height of 3½ feet with pine sheathing 3½ inches wide, planed, matched, set vertically, blind nailed, and smoothed off after setting, with a hand plane.

Cap this sheathing with scotia and torus cap projecting 2 inches clear, and hollowed at the top.

Put a moulding 3 inches wide at the upper edge of the black-boards (6 feet from the floor). Leave the sheathing of the recess for the stove up 3 inches from the floor, and cover the opening thus made with fine wire netting. Also make an opening in the floor between every two of the partition-studs enclosing the recess, equal to 4 by 10 inches.

WINDOW AND DOOR FINISH.

All the windows and doors to finish on the inside with 1½-inch casings, 6 inches wide, chamfered as drawn on the sectional drawing.

Case up thirty boxes, 8 inches wide, 9 inches high, and 12 inches deep in each of the entries. These boxes to be set upon the floor and against the walls, to form two tiers; to be open in front, and to be covered with a wide shelf forming a seat. Put also thirty wrought-iron clothes hooks, of approved pattern, upon the walls of each of the entries, and put white metal numbers, from 1 to 30, to the boxes and the hooks.

Fit up the water-closet with risers, seats, and hinged flaps, complete.

Hang the doors with iron butts, and fit them with small iron bolts set on the inside.

PRIVY.

Build a privy for the boys' use, and set the same where directed. Plan, arrangement, and size, like that of the room containing the water-closets. Height of posts, 10 feet. Finish the walls with sheathing and corner-boards, as required for the school-house; give the cornice 18 inches

projection, and finish it with chamfered facia; tin the roof as specified for the school-house, and make all the interior finish to correspond with that of the room enclosing the water-closets.

Provide each division with movable vault of sound hemlock plank.

MATERIALS.

For all the interior finish, except as otherwise specified, use sound, thoroughly seasoned white pine lumber, free from shakes, pitch, and large or bad knots, selecting the best materials for the school-room.

PAINTING.

Paint all the interior wood-work with two good coats of best Union white lead and pure linseed oil. Grain all the wood-work in the school-room and the entries in imitation of oak.

Tint the walls of the school-room of a light blue, and the ceiling of a deeper blue.

Paint all the exterior wood-work three good coats, as required for the interior work.

Tint the last coat with burnt umber or Vandyke brown for the sheathing on the walls; with a deeper shade of the same for the corner-boards, window and door-casings, and other trimmings, and use a deep tint of burnt Sienna for all the chamfers.

Grain the outside doors in imitation of black walnut, and finish all grained work with one coat of varnish.

Do all the labor required to set 56 chairs and desks, to be furnished by those having charge of the work.

Furnish all materials required for the work, except as otherwise specified herein; and do, in the most workmanlike manner, all labor necessary to complete the building according to the evident intention of the design, as set forth in the drawings and in this specification.

Remove all rubbish from the building and premises at the completion of the work.

Design No. 1.

Plate No. 1.

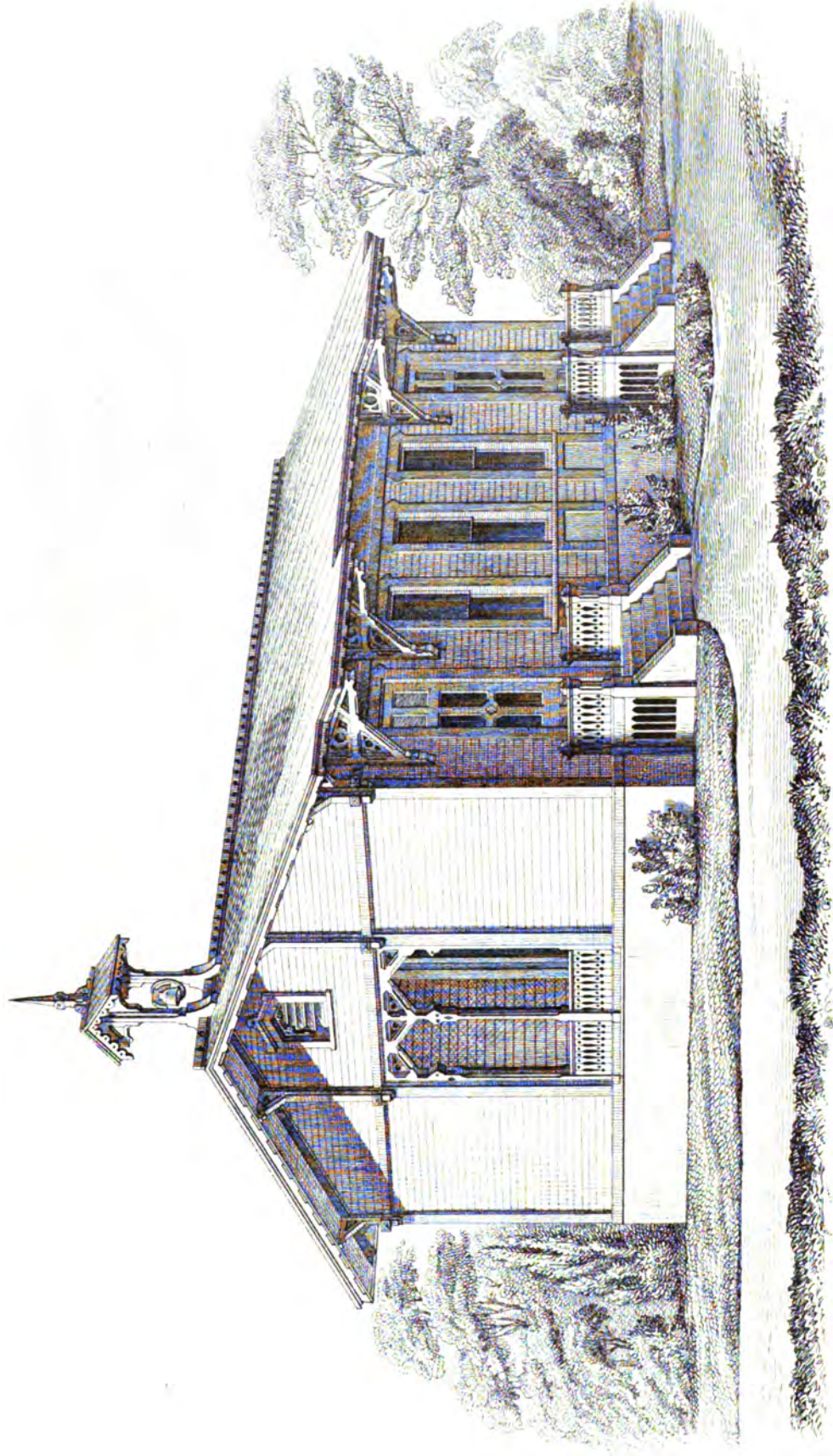

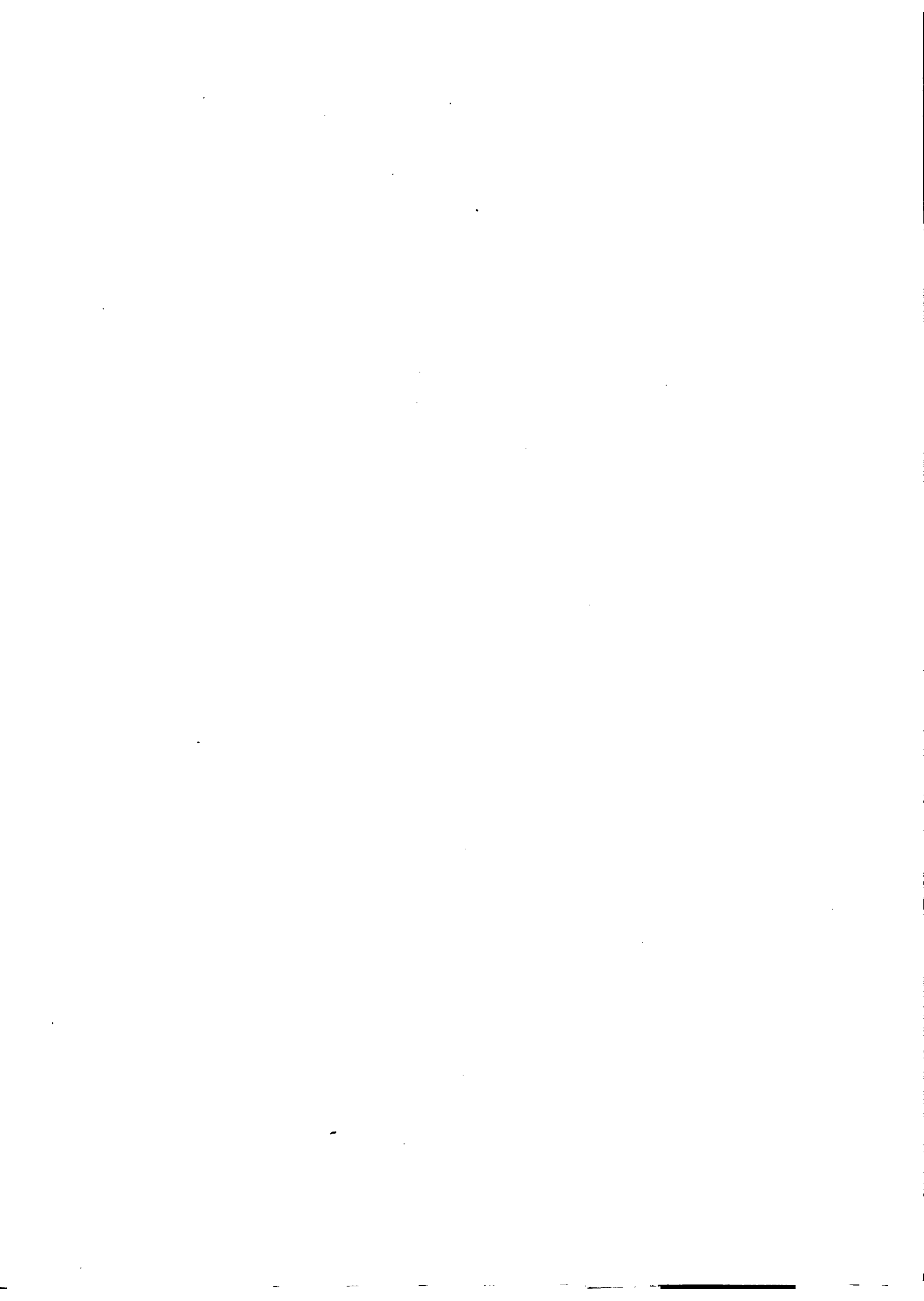

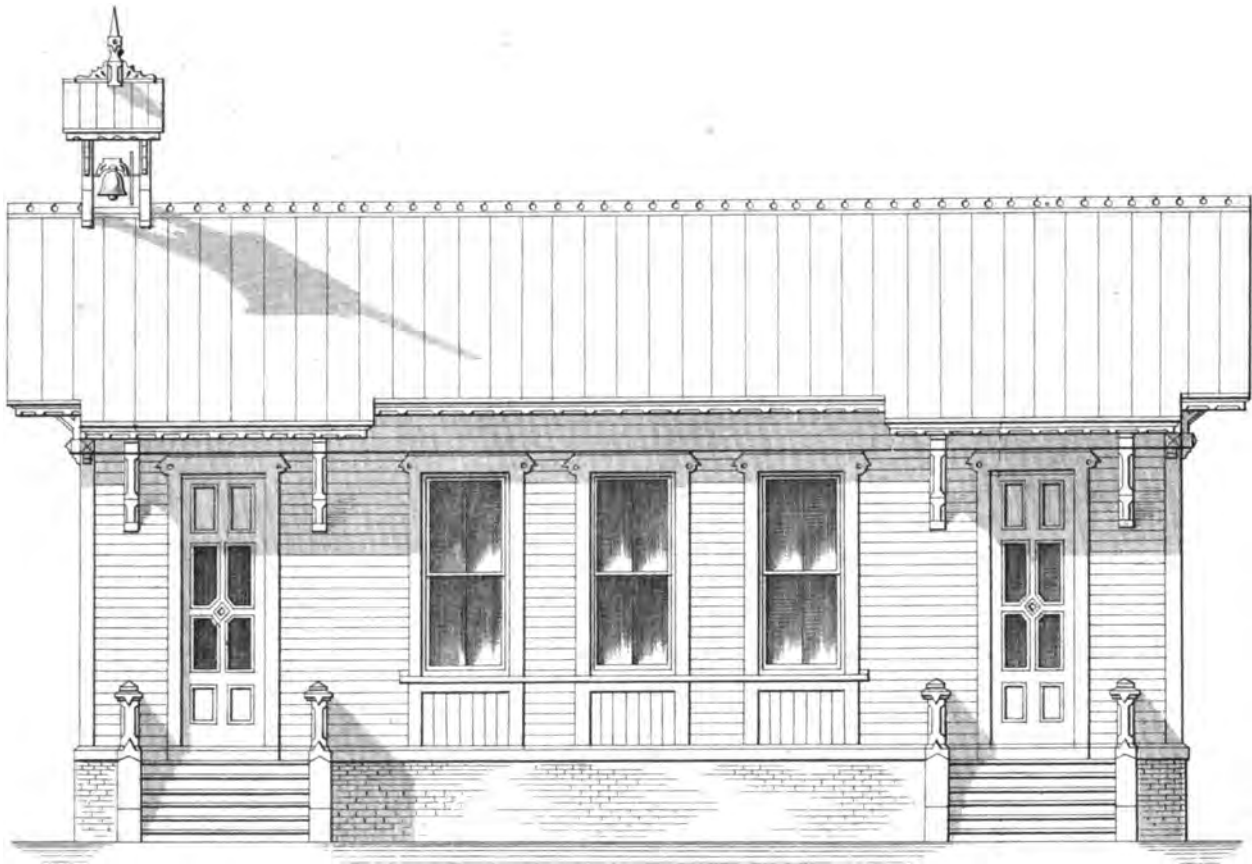

FRONT ELEVATION.

1/8 Inch to the foot

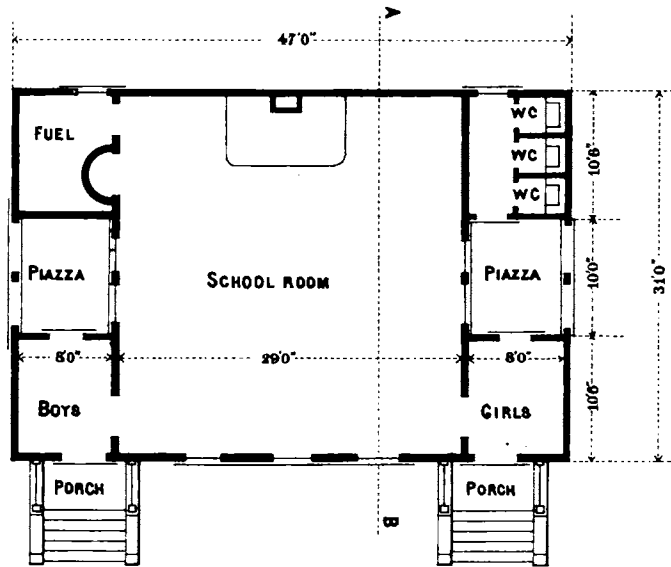

FLOOR PLAN.

1/16 Inch to the foot



Design No. 1.

Plate No. 3.

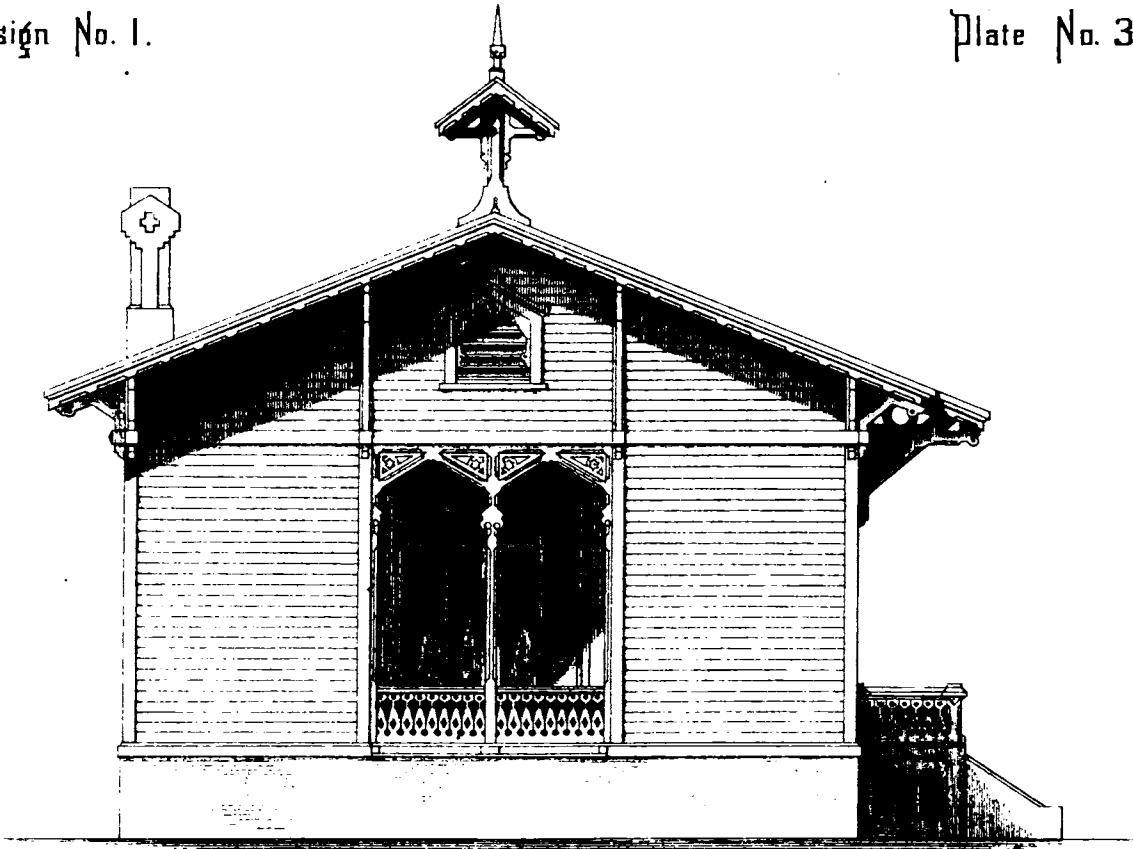

END ELEVATION

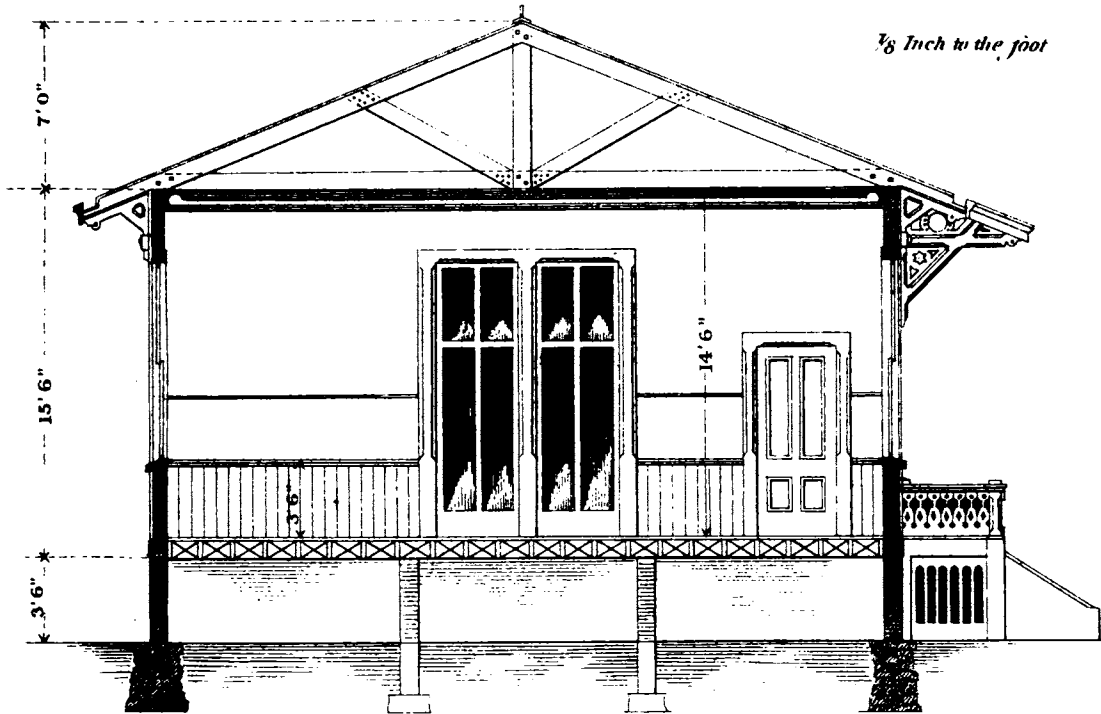

SECTION ON LINE A.B. IN FLOOR PLAN.



Design No. 1.

DETAILS

1/2 Inch to the foot

Plate No. 4.

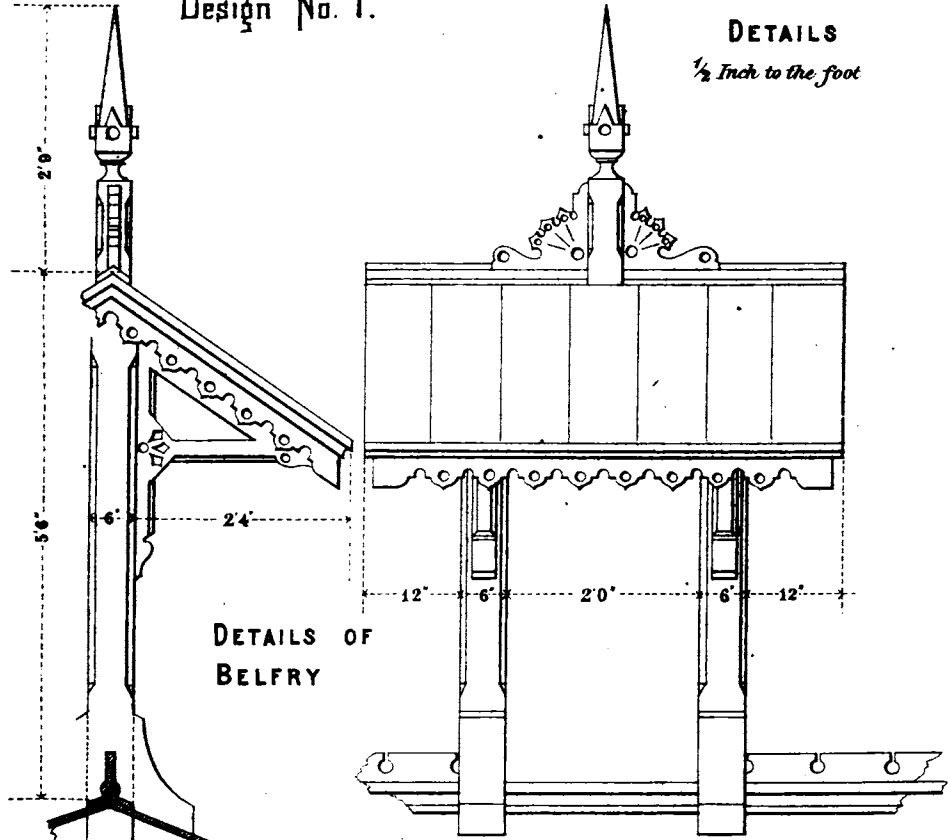

DETAILS OF BELFRY

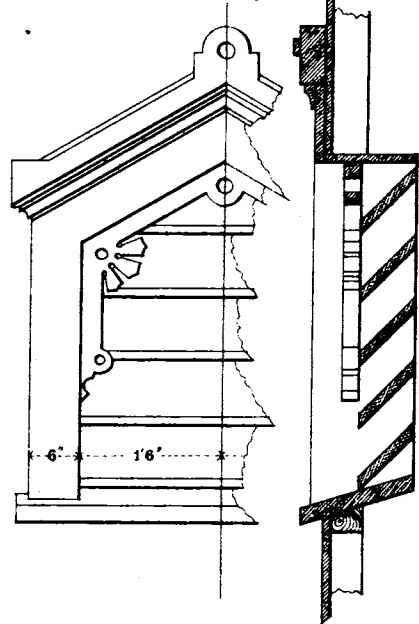

GABLE WINDOWS

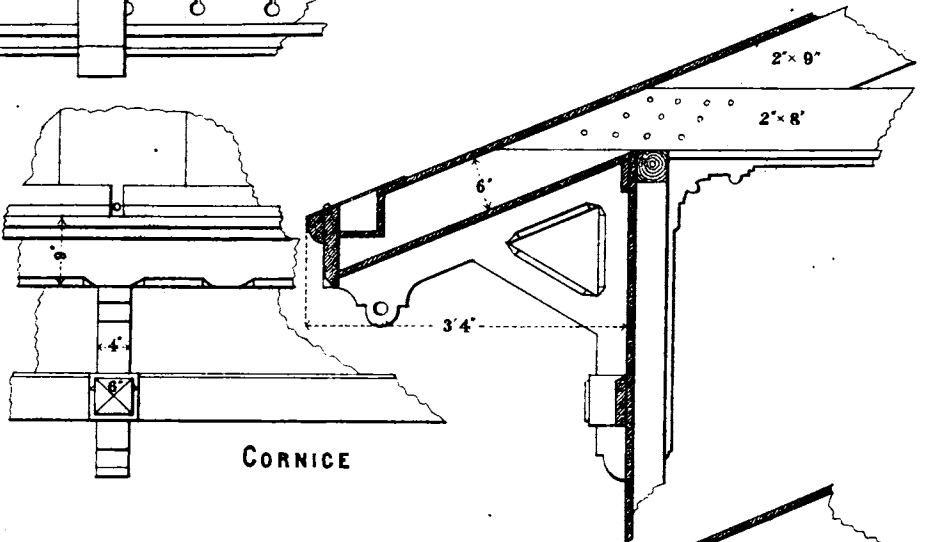

CORNICE

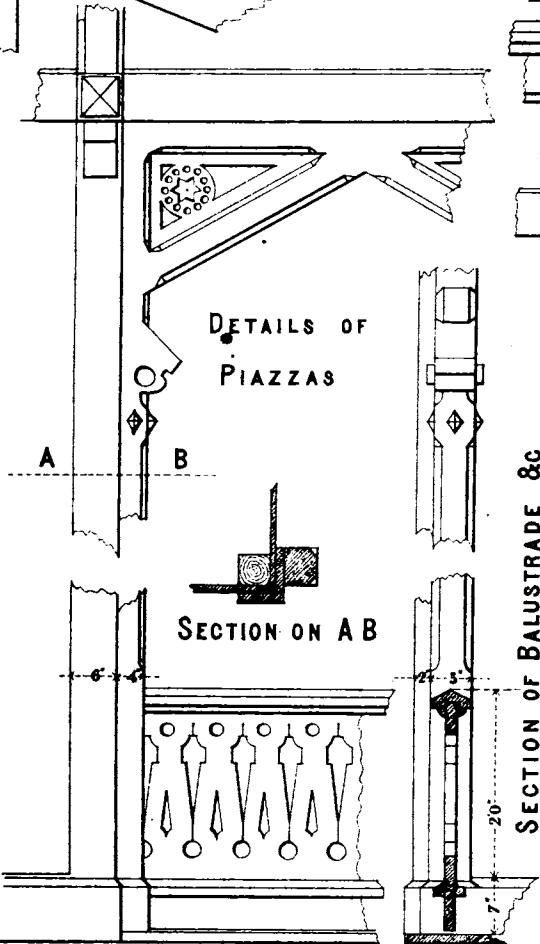

DETAILS OF PIAZZAS

SECTION ON A B

SECTION OF BALUSTRADE & C

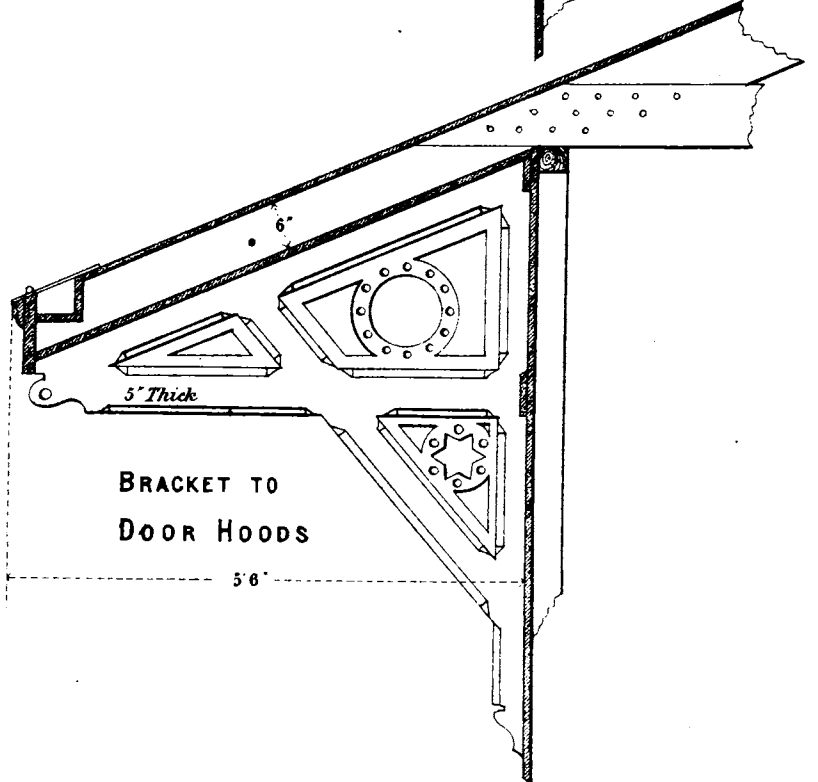

BRACKET TO DOOR HOODS



DESIGN NO. 2.

Plates Nos. 5, 6 and 7.

THIS design shows a primary School-house for pupils of either sex.

As will be observed, the foundation is of wood, consisting of large locust or red cedar posts, set in the ground.

The sheathing of the walls below the belt at the level of the window-sills is set vertically, and above that belt, horizontally. The roof is of tin, put on with raised joints.

It is believed that the veranda would prove a very useful feature in the design, affording a commodious and amply protected play-room for foul weather, a provision quite necessary in the case of young children.

The exterior should be painted with three tints of a warm brown color, using the lightest tint for the walls above the belt, the blinds, the under-side of the projecting roof, and the perforated work in the gables; the medium tint for the wall below the belt, and the darkest tint for the corner boards, veranda posts and rafters, and the window and door trimmings and belts.

The roof should be painted with two tints of a light slate color, laid upon the alternate strips of tin.

The cloak-room and fuel-room, should be sheathed up with narrow strips the whole height of the walls.

The walls and ceiling of the school-room should be tinted with pearl blue, or gray.



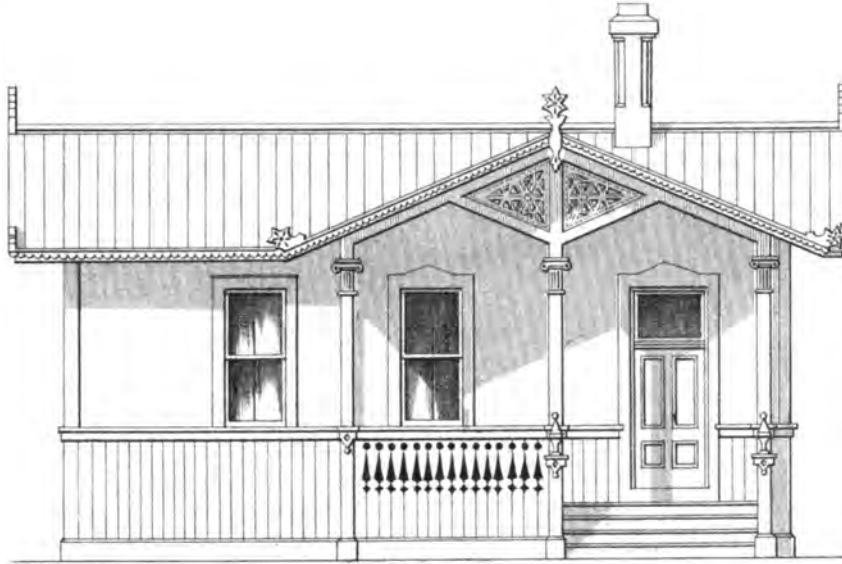

FRONT ELEVATION

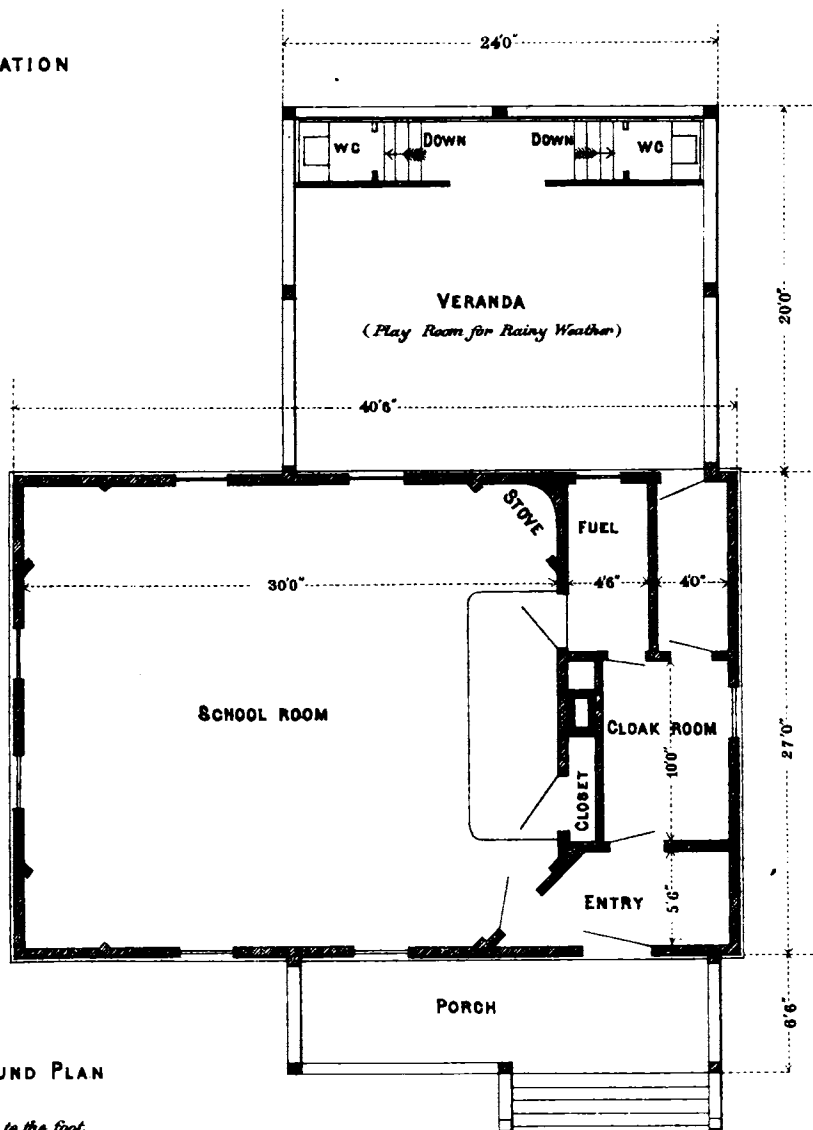

GROUND PLAN

$\frac{3}{32}$ inch to the foot



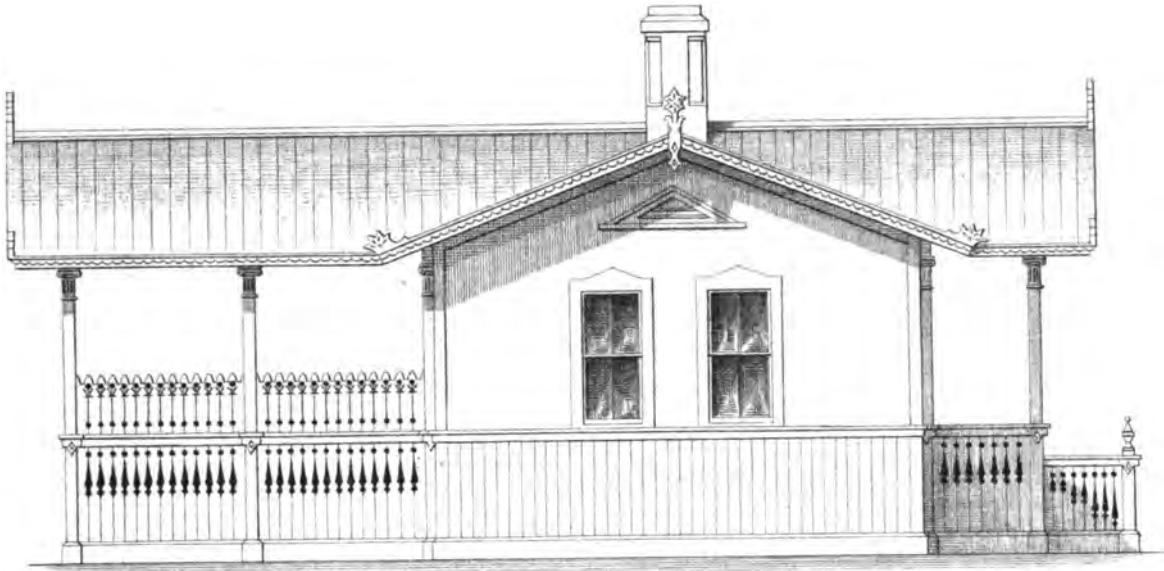

SIDE ELEVATION

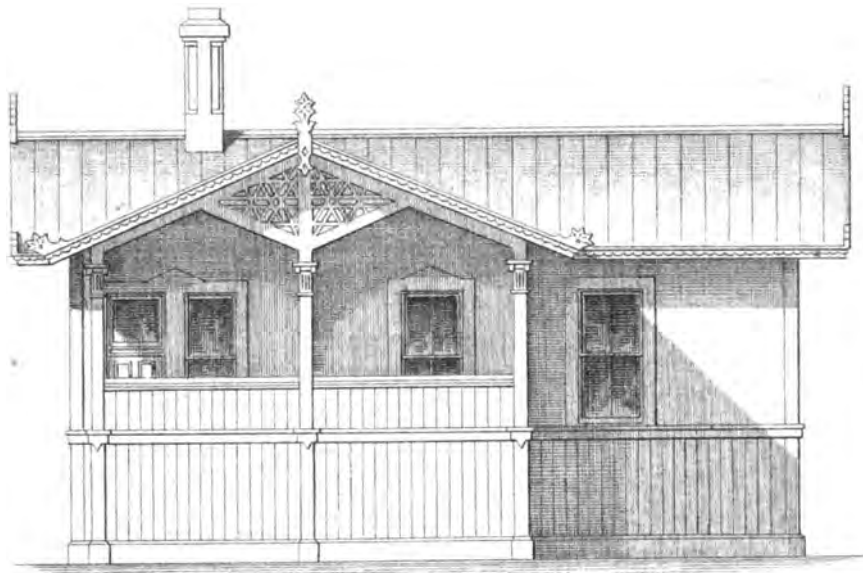

REAR ELEVATION

³/₃₂ inch to the foot

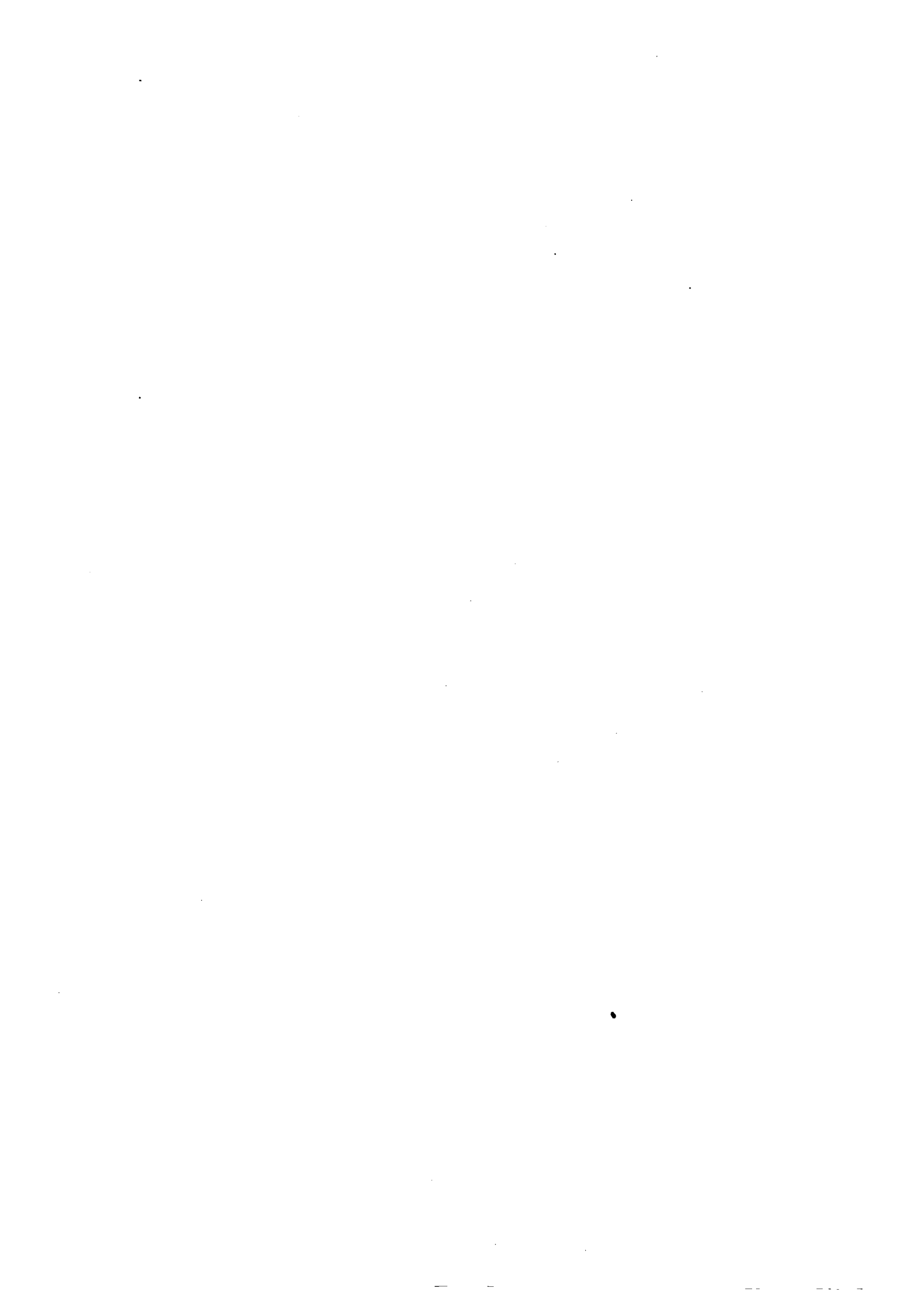

DETAILS $\frac{1}{2}$ Inch to the foot

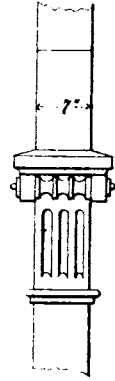
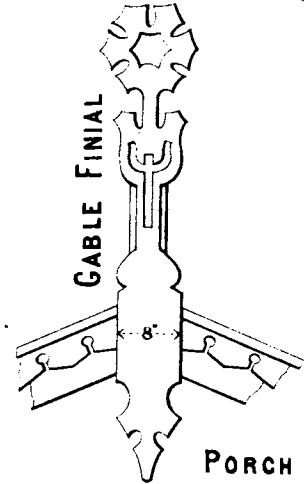
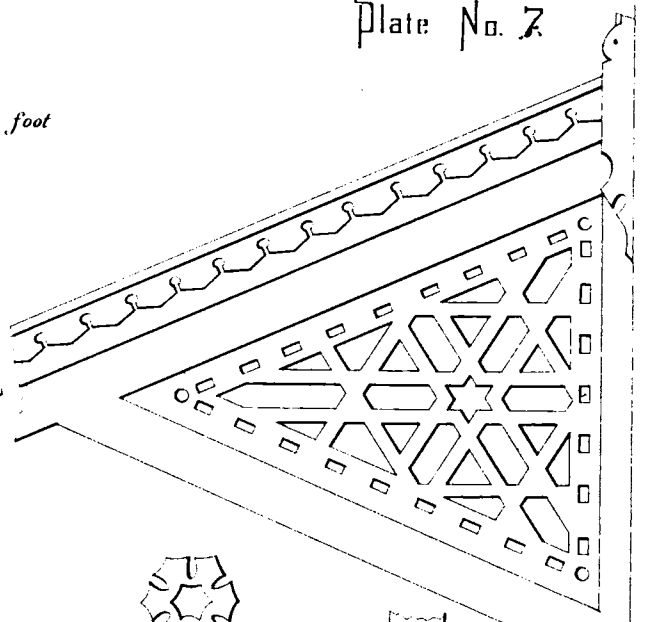
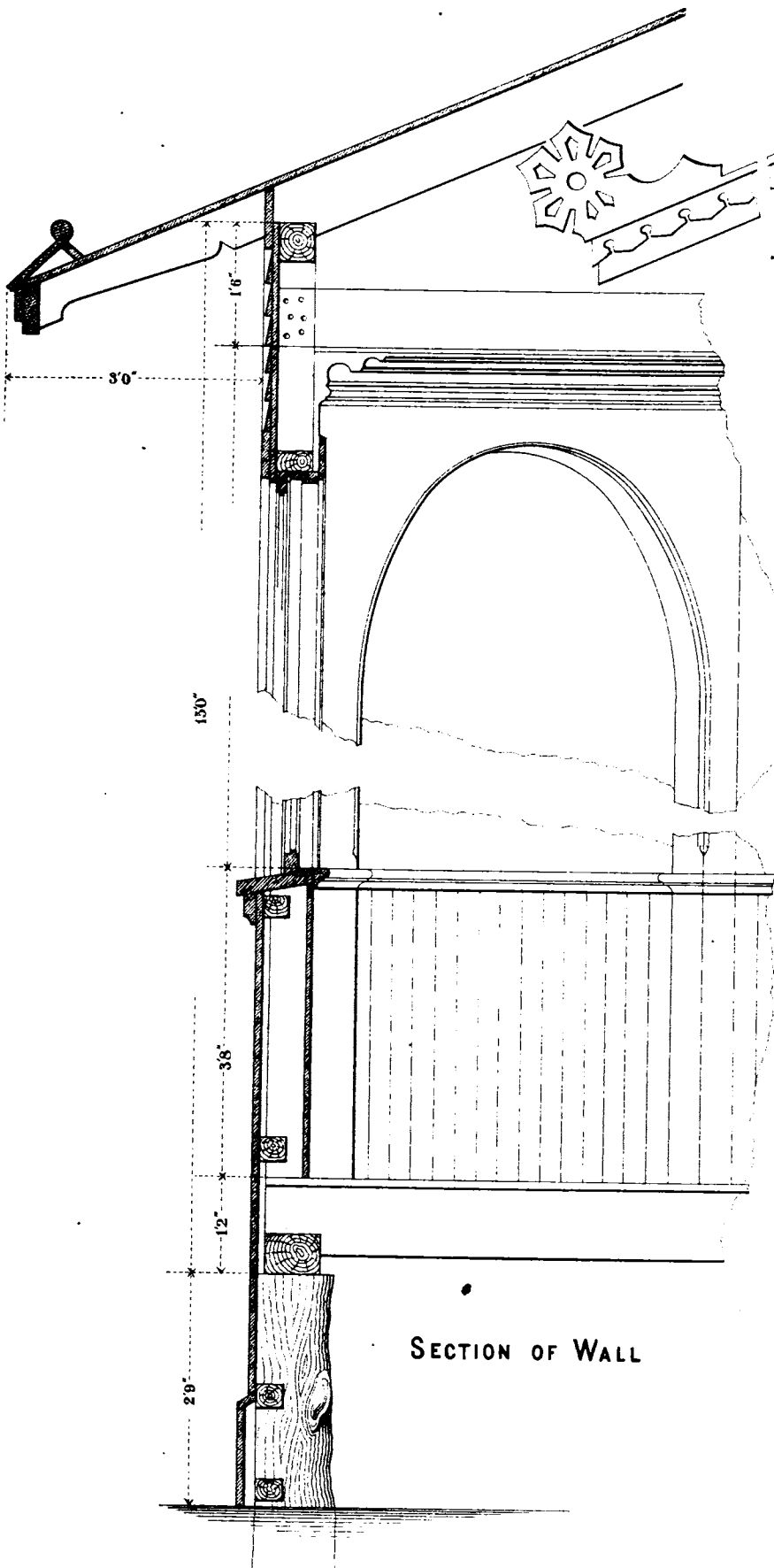

PORCH AND VERANDA FINISH

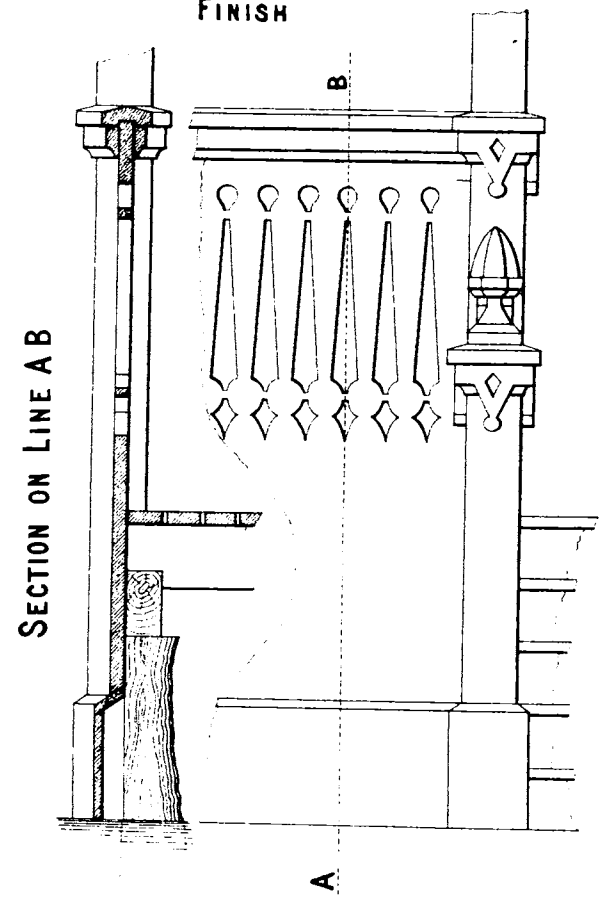



DESIGN NO. 3.

Plates Nos. 8, 9 and 10.

THE drawings in these plates represent a country School-house, adapted for pupils of one sex.

In this design, as in several others in this book, the chimney is used as the ventilating shaft. The foul air is taken from the bottom of the room through a wooden duct, as represented in Plate 8, and from the top of the room through a ventilating register set in the chimney. Wooden ventilating ducts are also required from the water-closets to the chimney.

The smoke flue should be an earthen pipe set in the chimney, and serving, when in use, to create an upward draft in the larger flue in which it is contained.

The walls may be covered either with narrow-matched weather boarding, or with clapboards put on over a wall lining.

If it were desired to accommodate pupils of both sexes, the "entry" would become the boys' entry, the "cloak-room" would serve for a fuel-room, and the "fuel-room" would be changed into a cloak-room for the girls' use; the water-closets for the boys being provided in an out-building.



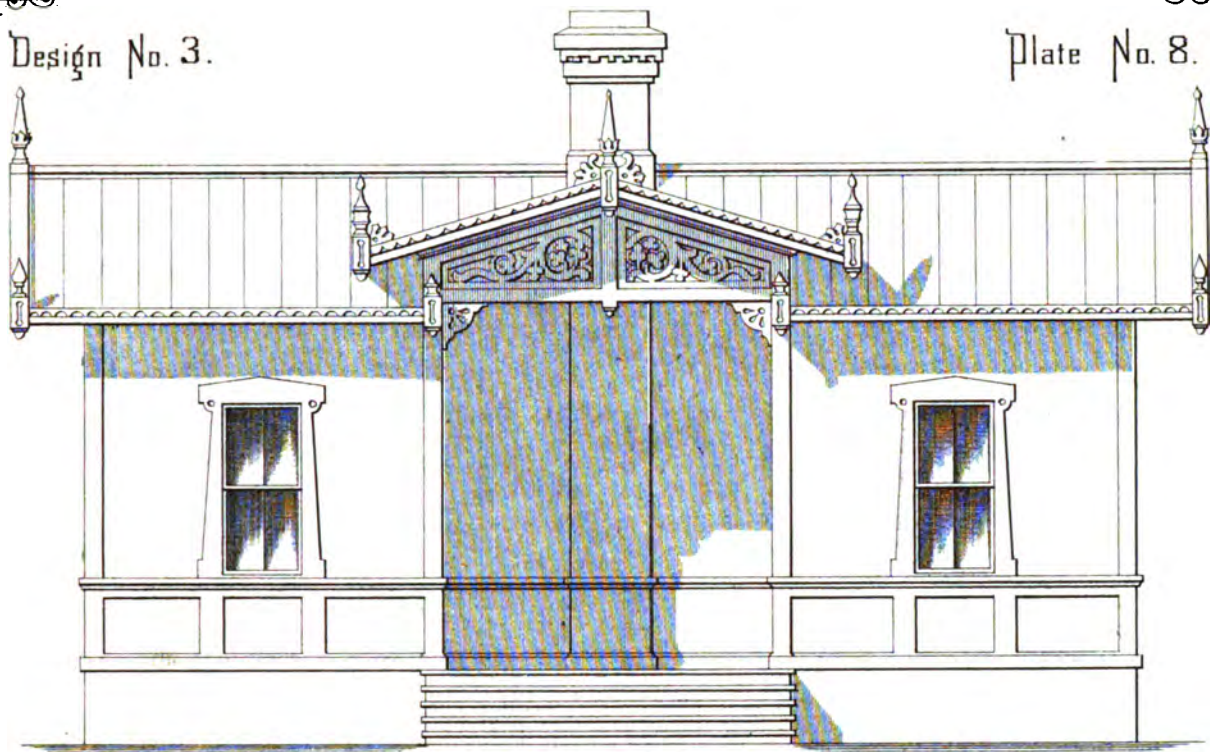

FRONT ELEVATION
AND
FLOOR PLAN

1/8 inch to the foot

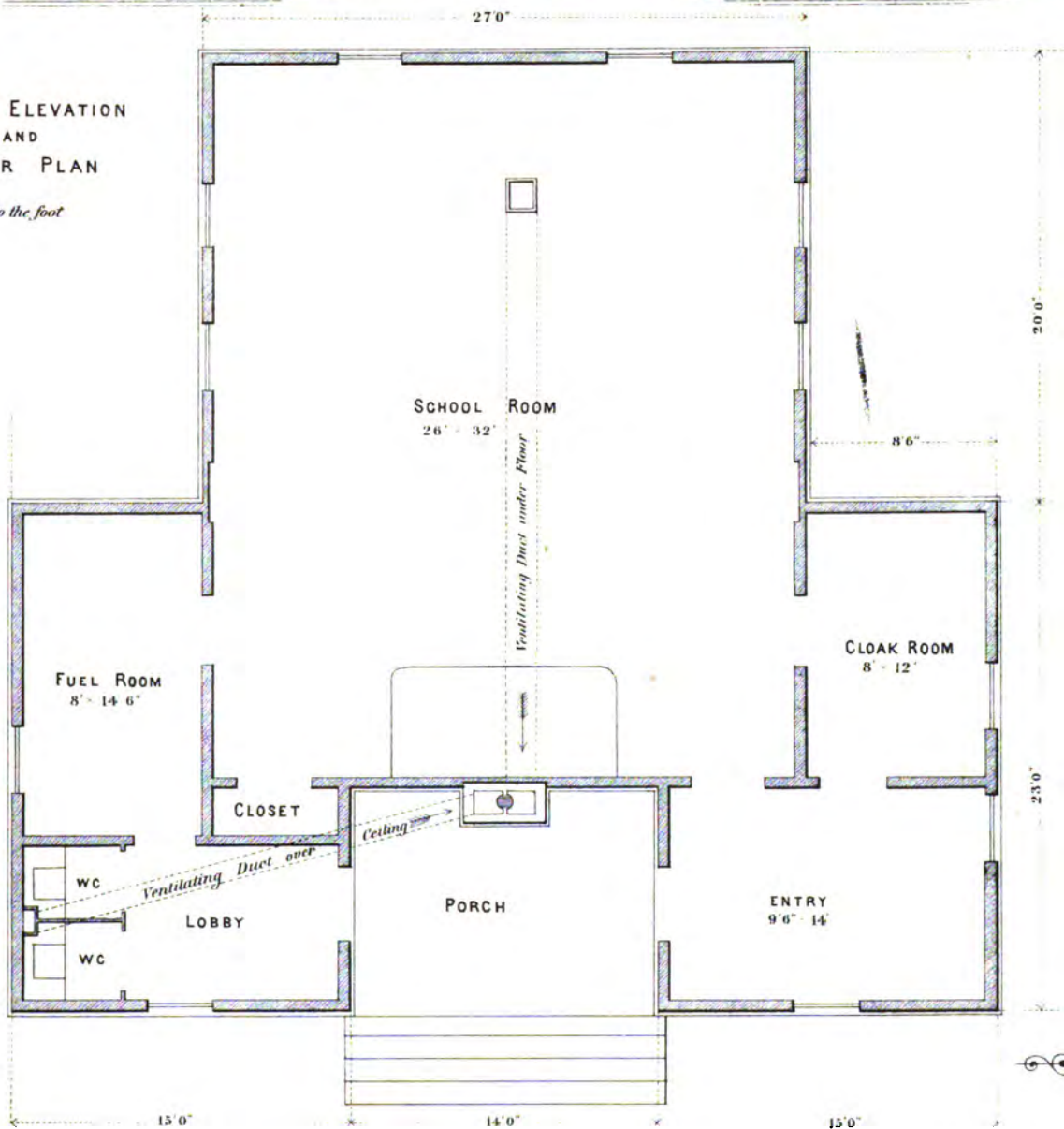



Design No. 3.

Plate No. 9.

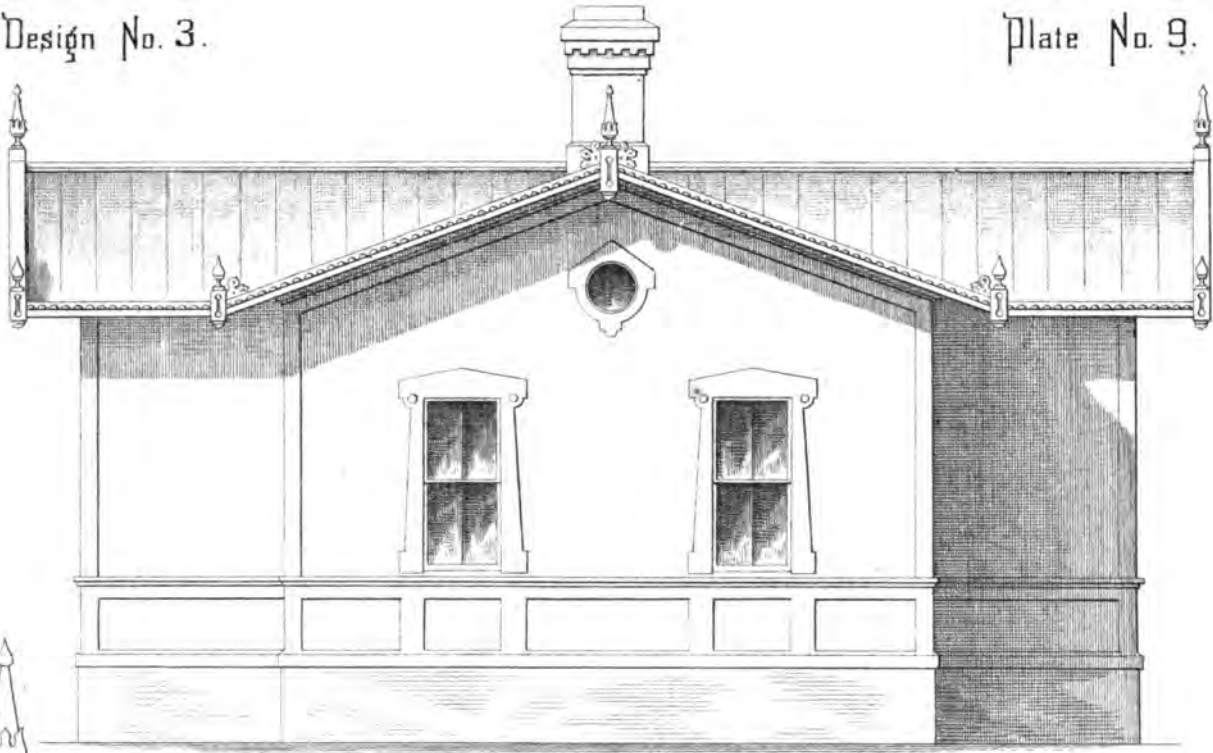

REAR ELEVATION

1/8 Inch to the foot

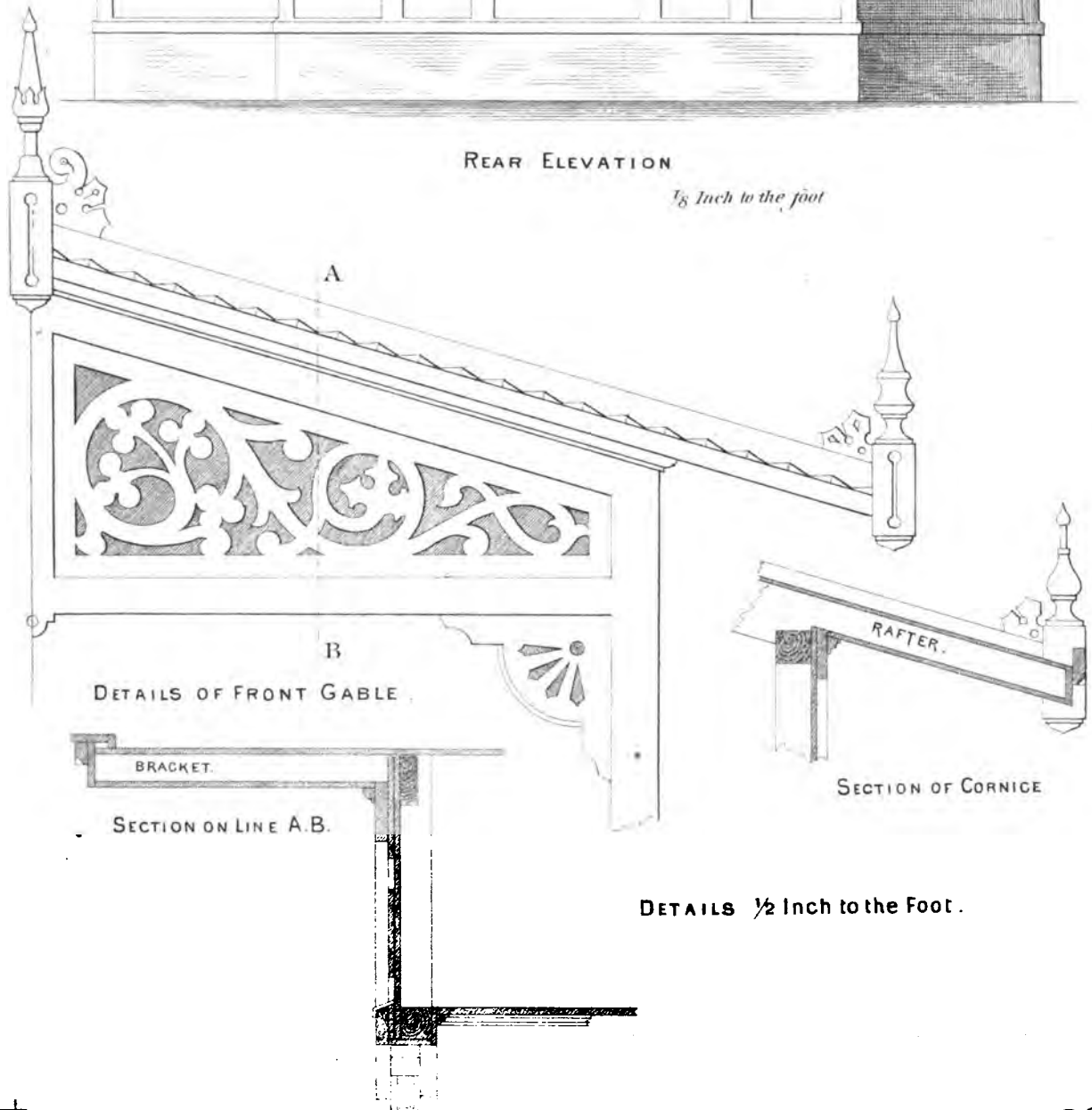

DETAILS OF FRONT GABLE

SECTION OF CORNICE

DETAILS $\frac{1}{2}$ Inch to the Foot.



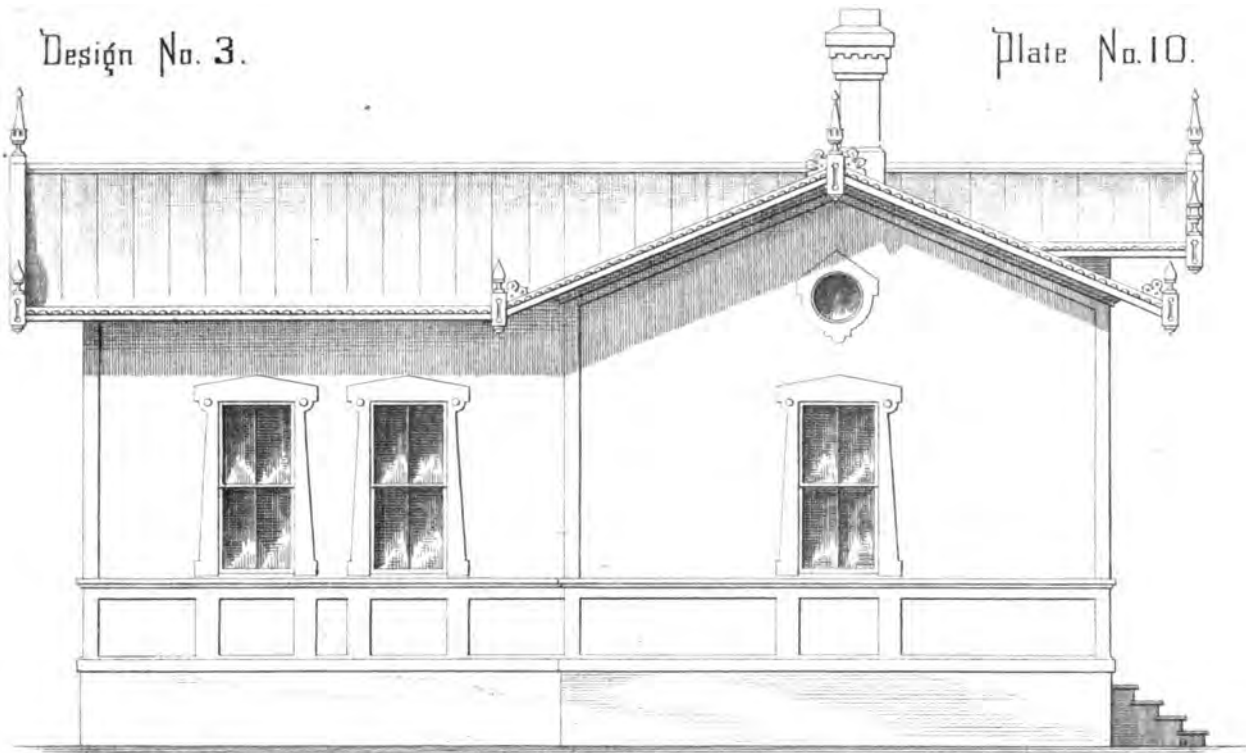

SIDE ELEVATION

1/8 Inch to the foot

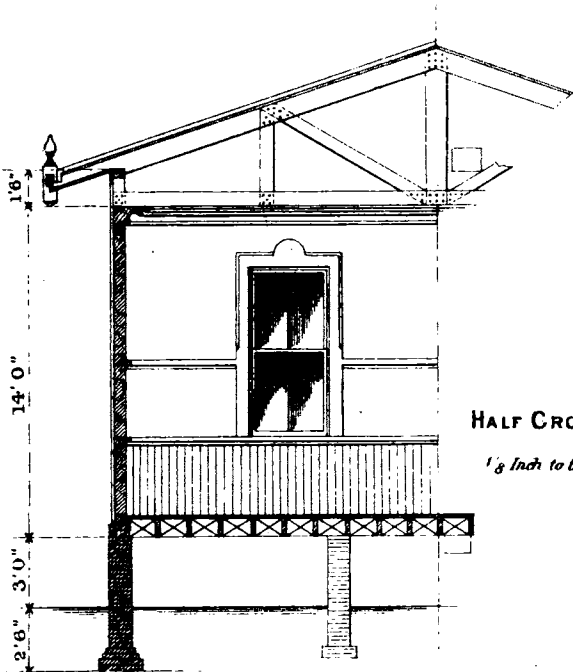

HALF CROSS SECTION.

1/8 Inch to the foot

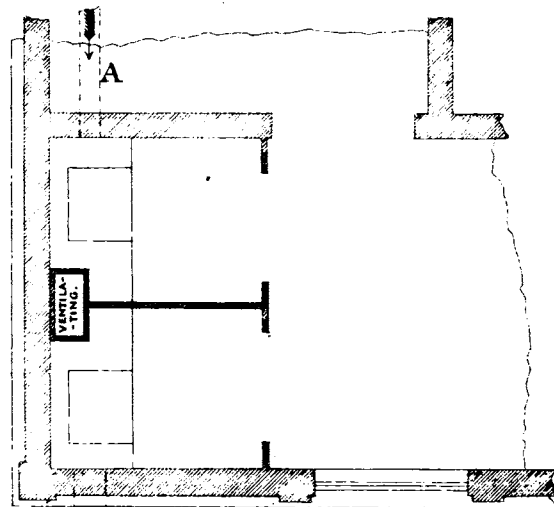

B

PLAN OF W. C.'S,
AND SECTION OF VAULT.

1/4 Inch to the foot

WINDOW FINISH

1/2 Inch to the foot

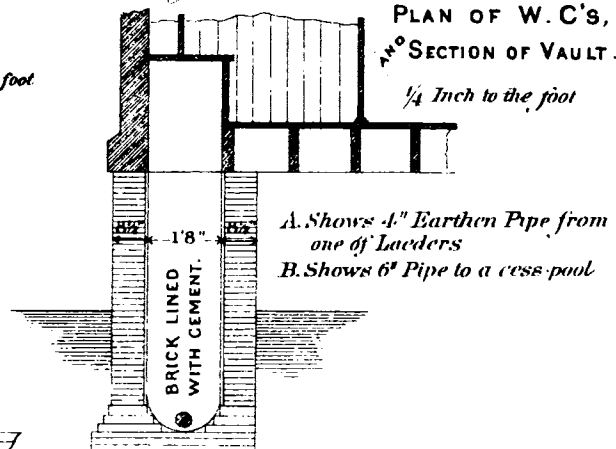
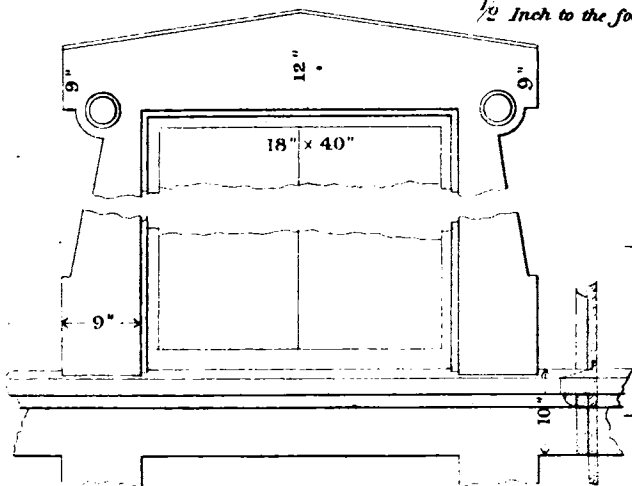

A. Shows 4" Earthen Pipe from
one of Ladders
B. Shows 6" Pipe to a cess-pool

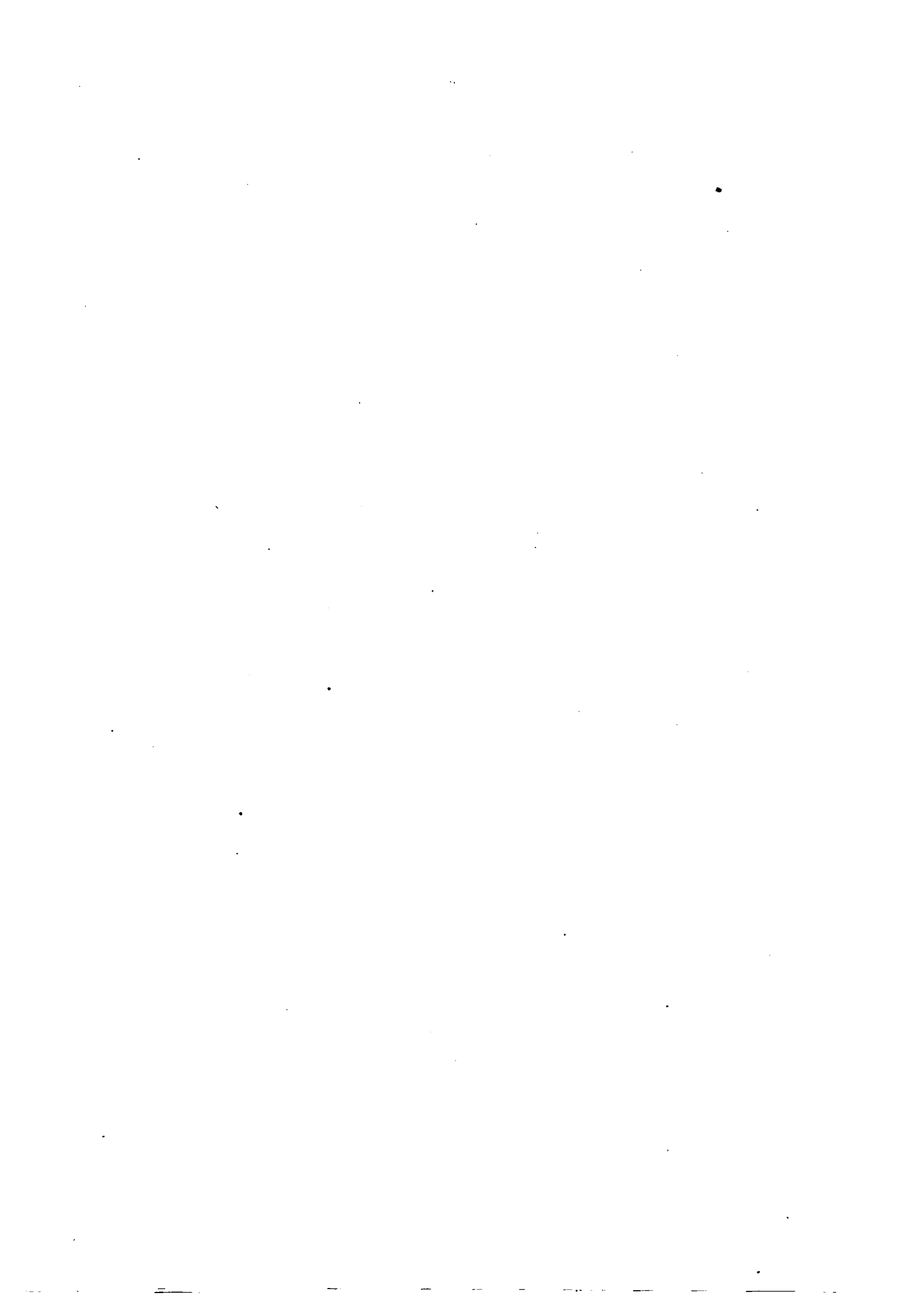

DESIGN NO. 4.

Plates Nos. 11, 12 and 13.

A PRIMARY School-house for pupils of both sexes, the cloak-room being used in common, and the boys' water-closets being in a detached building, is represented in the plates exhibiting this design.

No new features in construction, beyond what have already been described, are presented; and it is believed that, excepting the roof framing, the design is sufficiently explained in the drawings.

The rafters in the roof framing should span the entire depth of the building, and the partition dividing off the school-room should be carried up to the rafters, to serve as a support for them. The ceiling joists should span the school-room, and be laid at right angles to the partition named, being securely spiked to the partition and wall-studs; and a truss should be formed by nailing on pieces extending from the end of the ceiling-joist in the partition, up to the part of the rafter over the centre of the school-room, and from this last point suspension pieces should be carried to the centre of the ceiling-joists.

The ceiling of the alcoves at either side of the school-room, is meant to be level with the ceiling of the latter, but separated from it by segmental arches of about two feet rise.

The outer corners of these alcoves are represented as being truncated, and finished with niches.



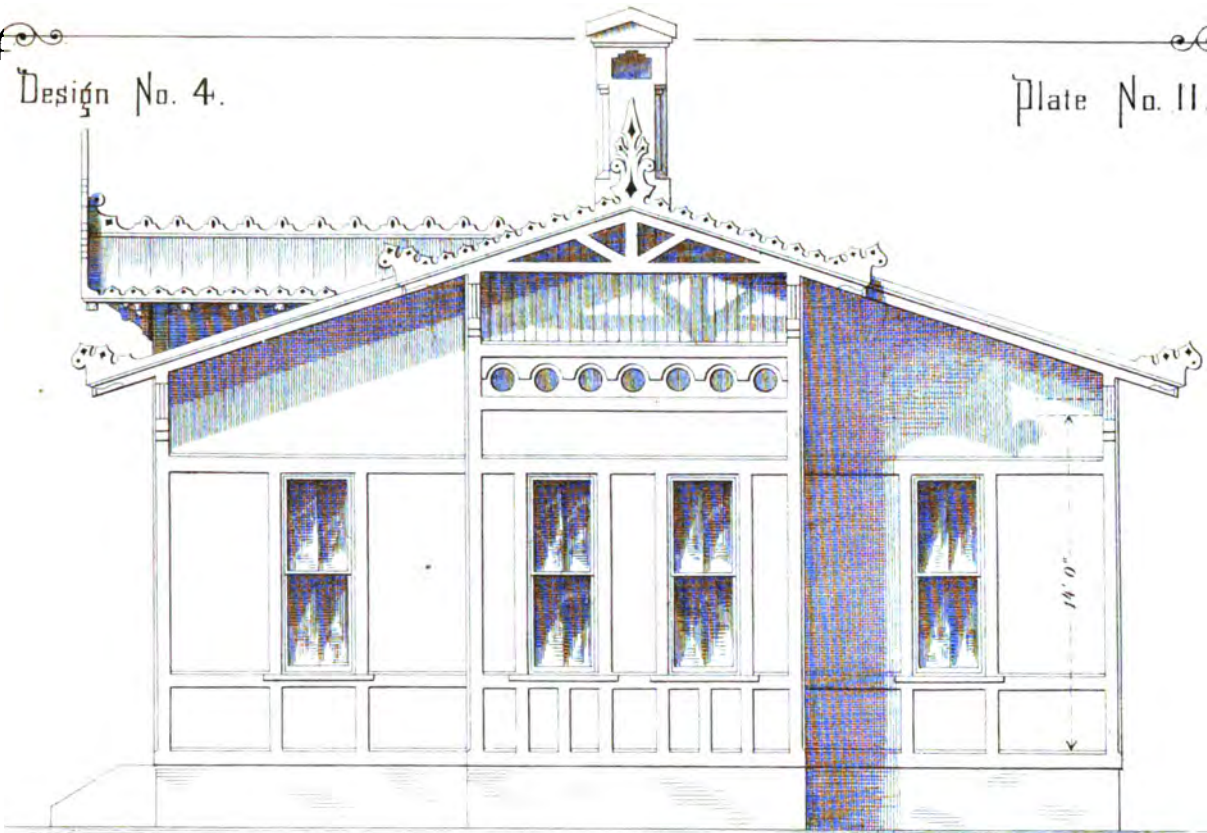

SIDE ELEVATION

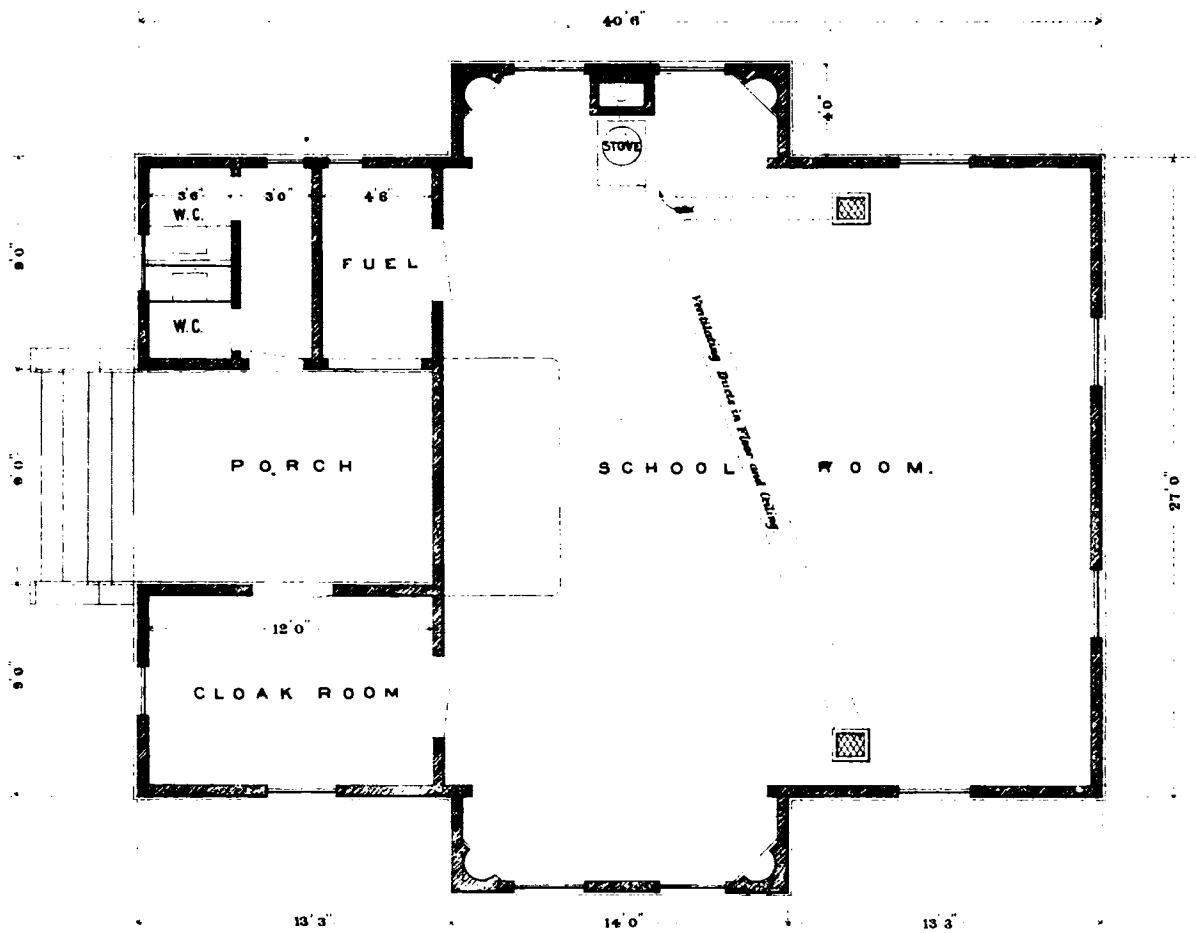

GROUND PLAN

1/8 inch to the foot

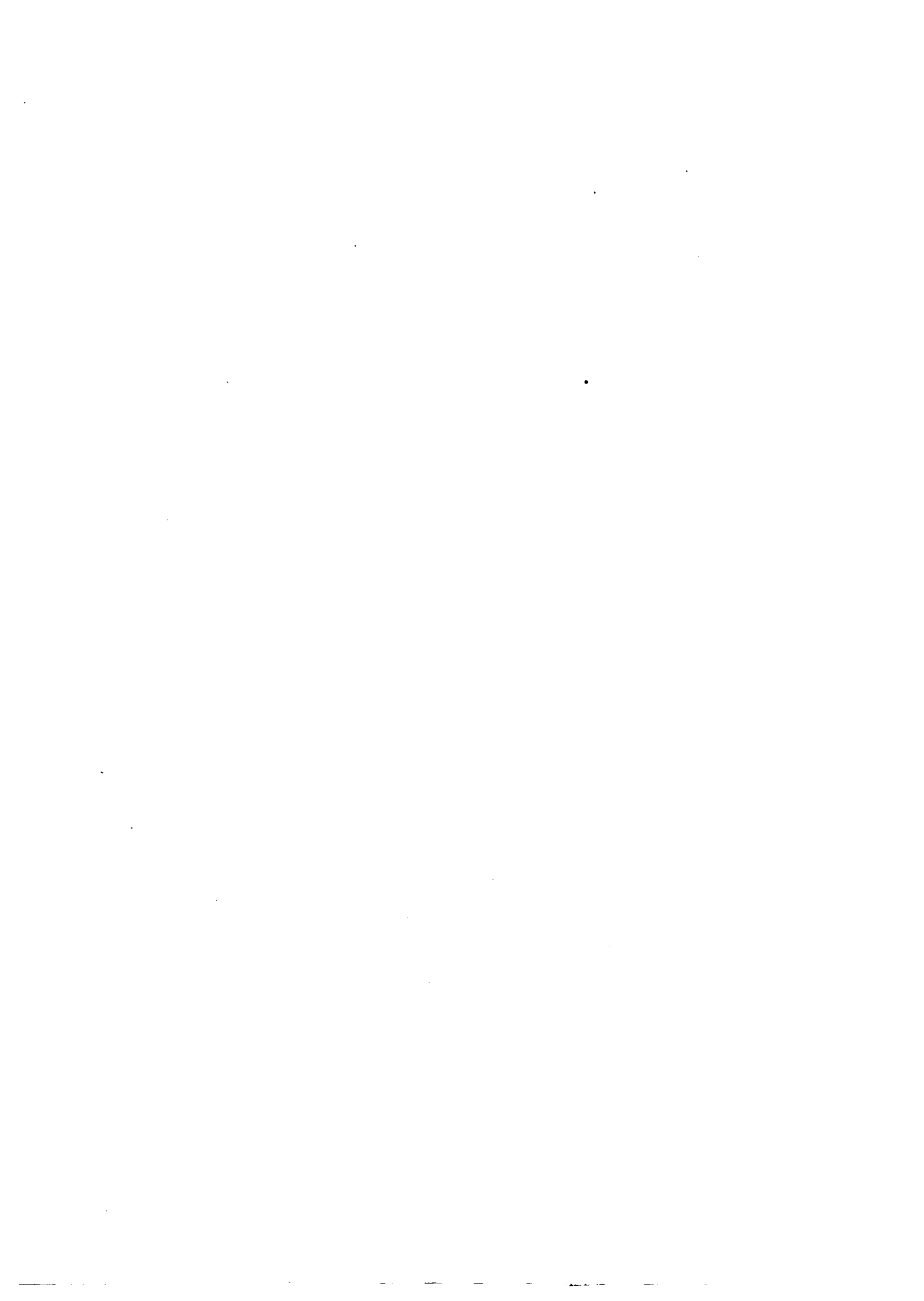

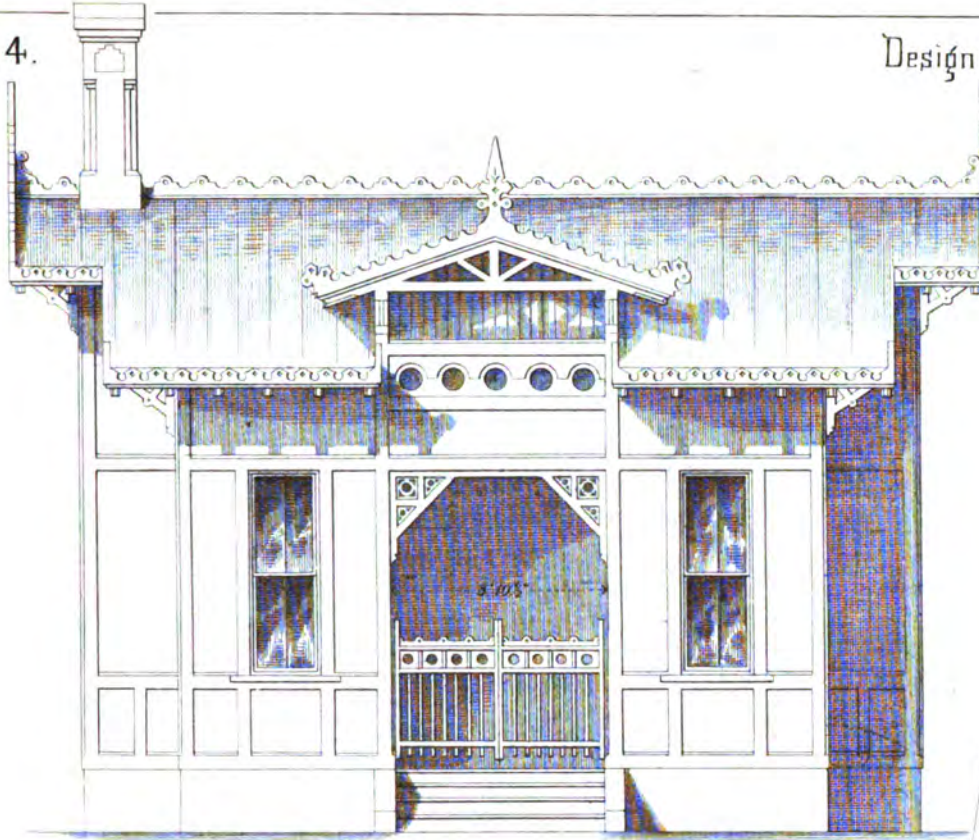

FRONT ELEVATION.

1/8 inch to the foot

DETAILS OF
FRONT GABLE.

1/2 inch to the foot

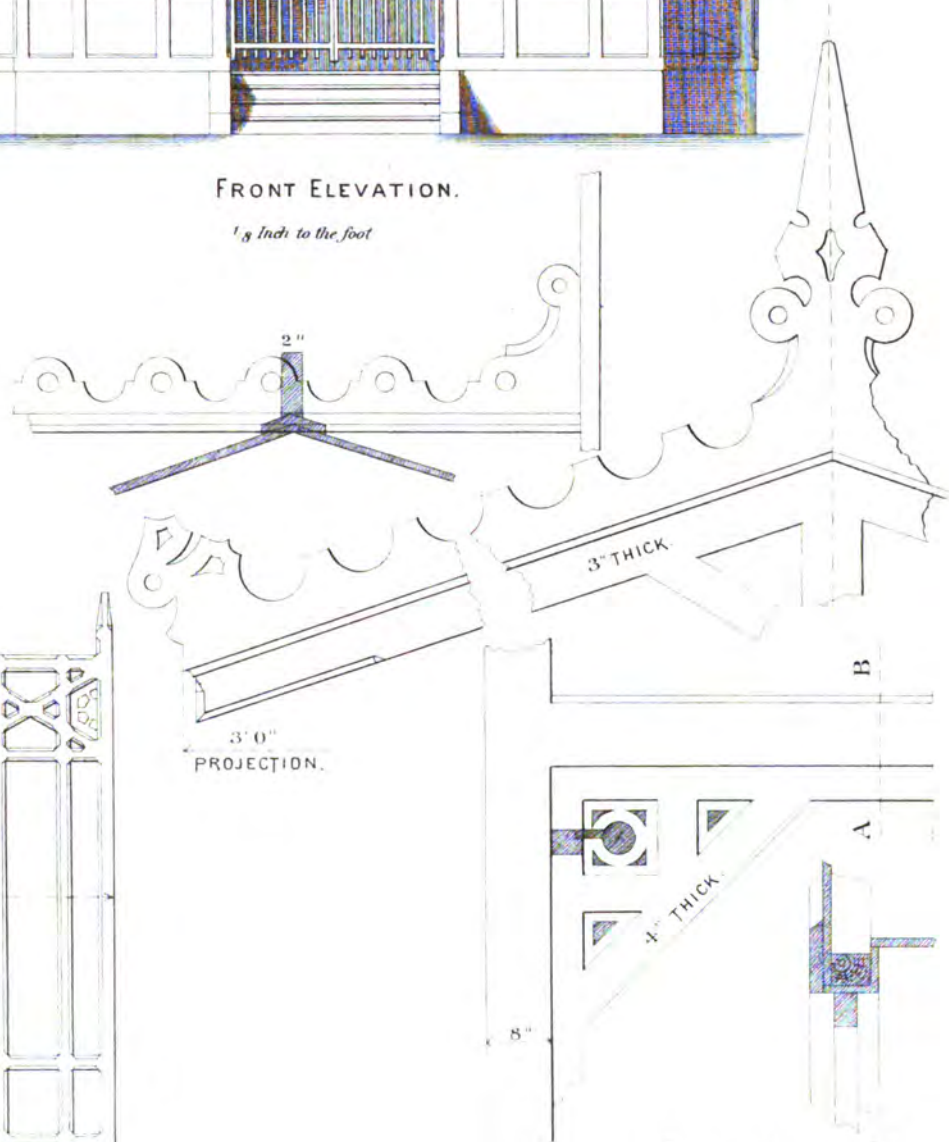
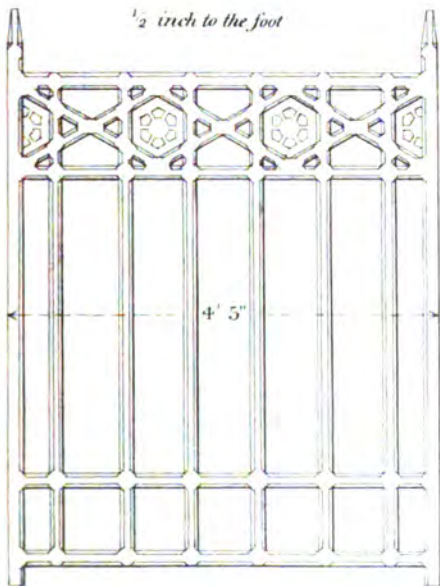

SECTION ON LINE A. B.



Design No. 4.

DETAILS - 1/2 INCH TO THE FOOT-

Plate No. 13.

HORIZONTAL CORNICE
ELEVATION AND SECTION

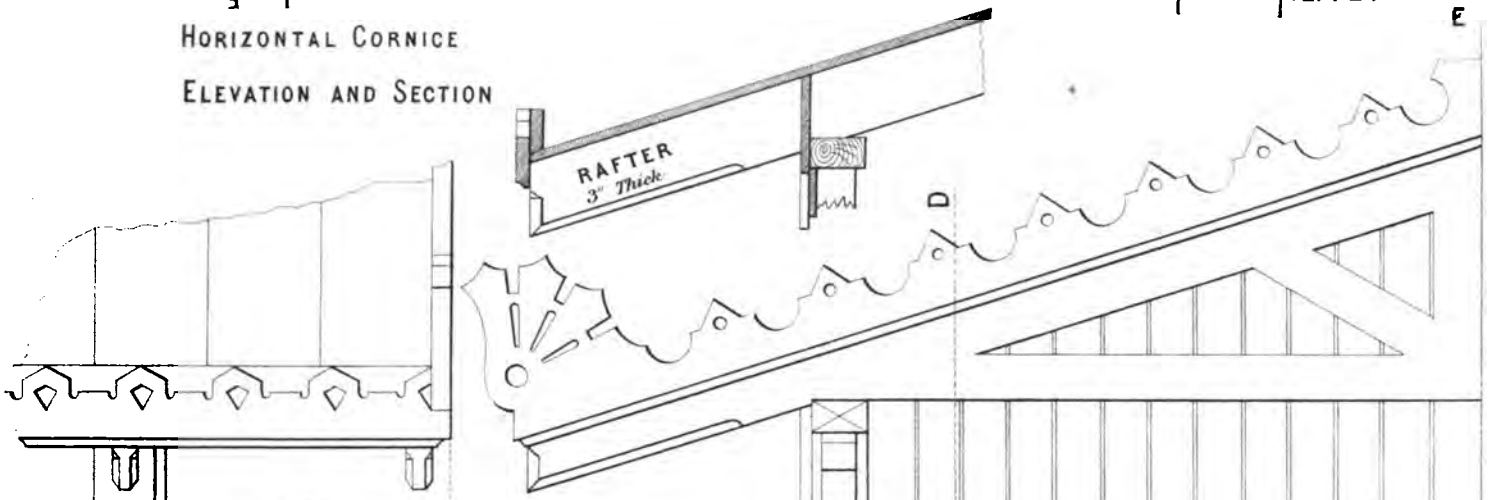

30"

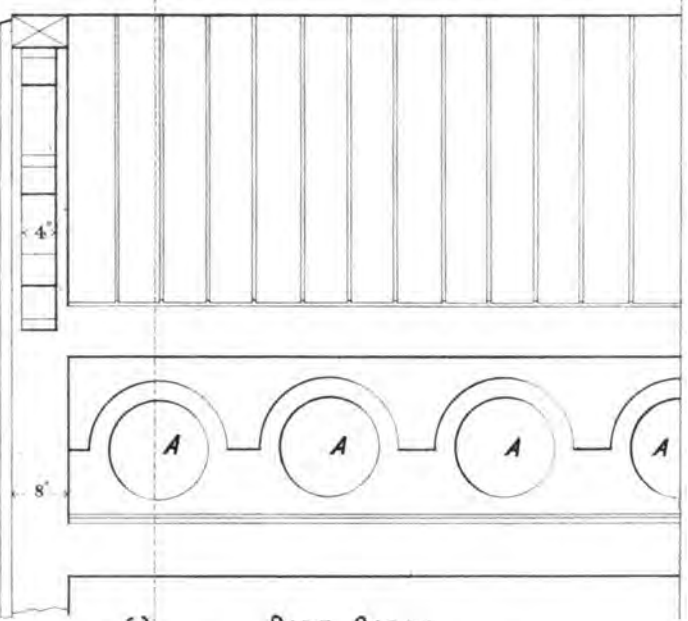
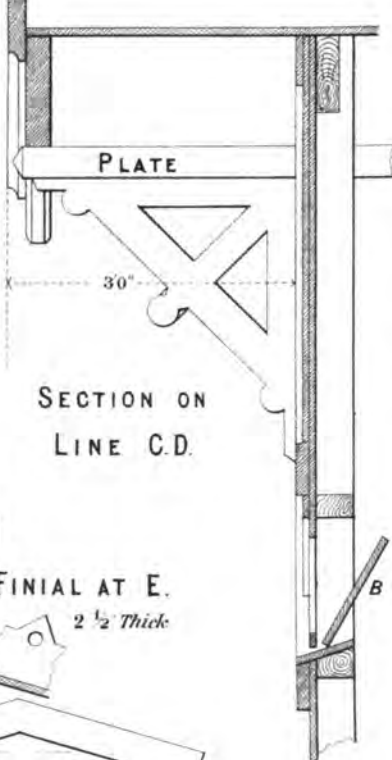

C
SIDE GABLE
A A A A, Show openings covered
by hinged Flap B.

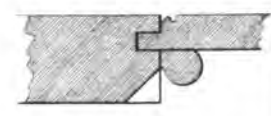
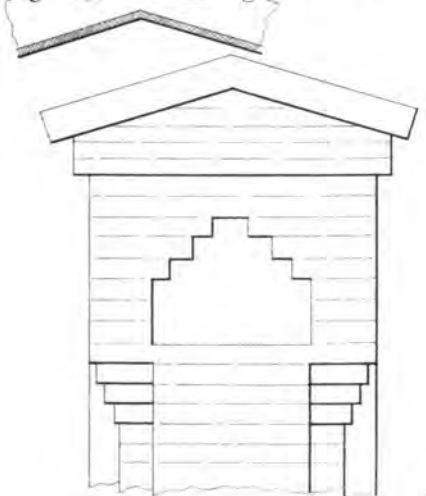

DOOR MOULDING &c
1/4 Full size

CHIMNEY TOP

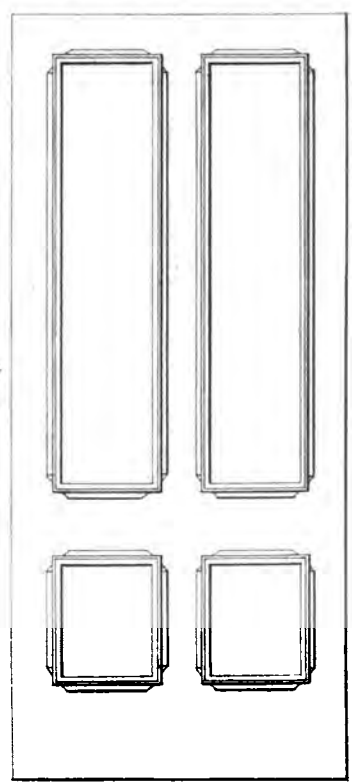
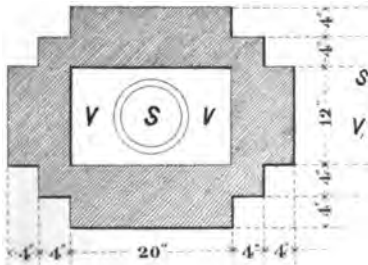

DOOR



DESIGN NO. 5.

Plates 14, 15 and 16.

THESE plates show a design for a brick school-house to accommodate one hundred pupils of both sexes, divided into two classes.

The octagonal form of the school-rooms, the principal feature of this design, is preserved in the ceiling of these rooms, the principal rafters starting from the angles of the octagon and meeting at the centre.

The wall plates are carried around upon the interior partitions, and, for the purpose of withstanding the thrust of the roof, they are bound together at each angle by iron straps extending in both directions, and bolted to each of the plates which meet at that angle.

The rafters are also bolted to the plates, and connected with the key-block at the centre of the ceiling by short tenons.

The connecting roof between the two octagonal roofs, is partly built upon these roofs, and partly supported by the central partition.

The lines surrounding the windows, etc., shown in the section, are designed to be executed in colors.

The walls and ceilings should also be tinted, and the panels formed by the timber work of the ceiling, should be finished with borders and angle ornaments in colors.

The rafters and purlins in the roof framing should be of well-seasoned timber.

The steps, the coping of the wall enclosing them, the window and door-sills, and the water-table, should be of stone, and the bricks forming the arched window and door lintels, should be carefully jointed.

The plan of the cellar would be the same as that of the principal floor, the partition walls being of brick.

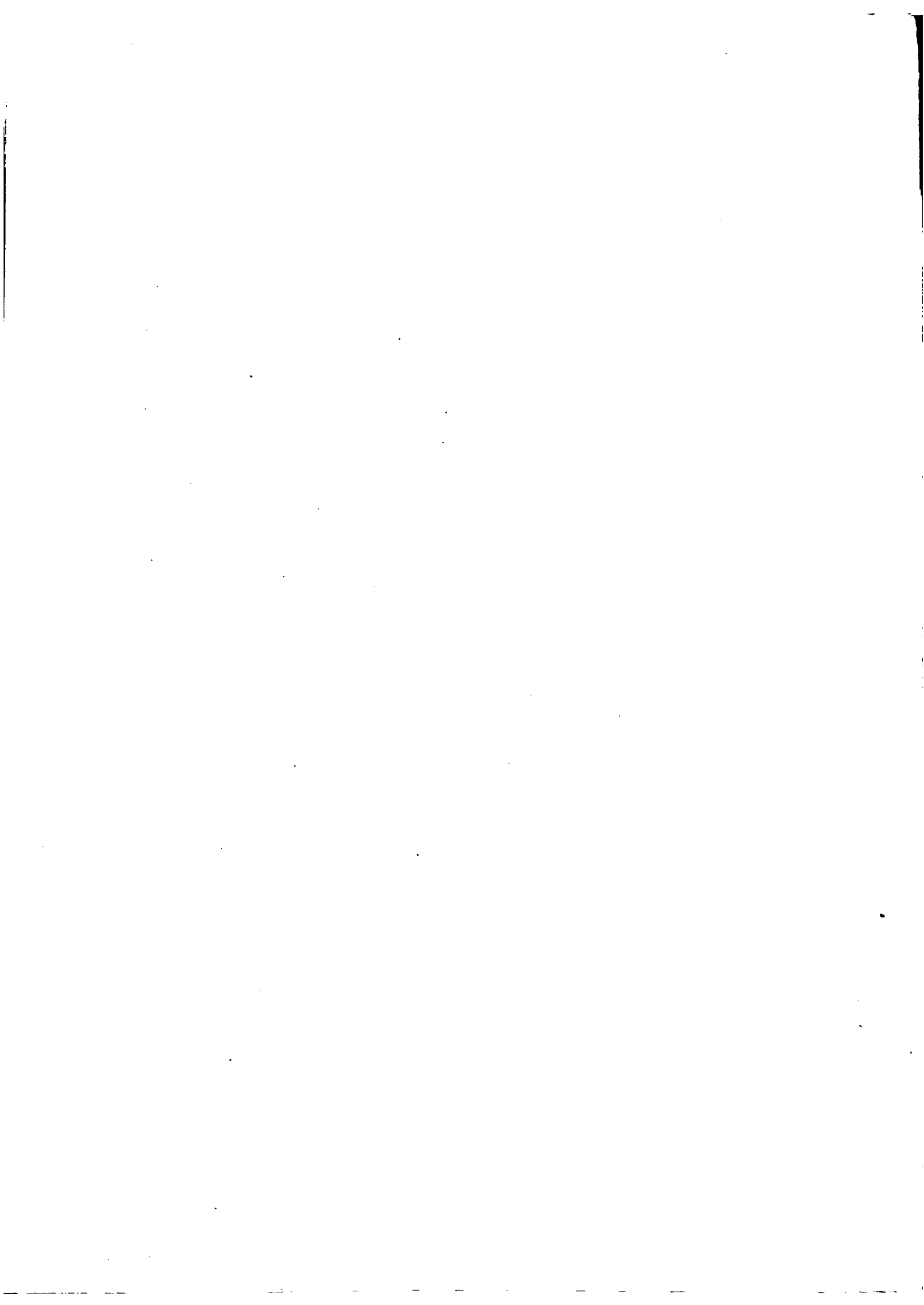

FRONT ELEVATION AND FLOOR PLAN

1/16 inch to the foot

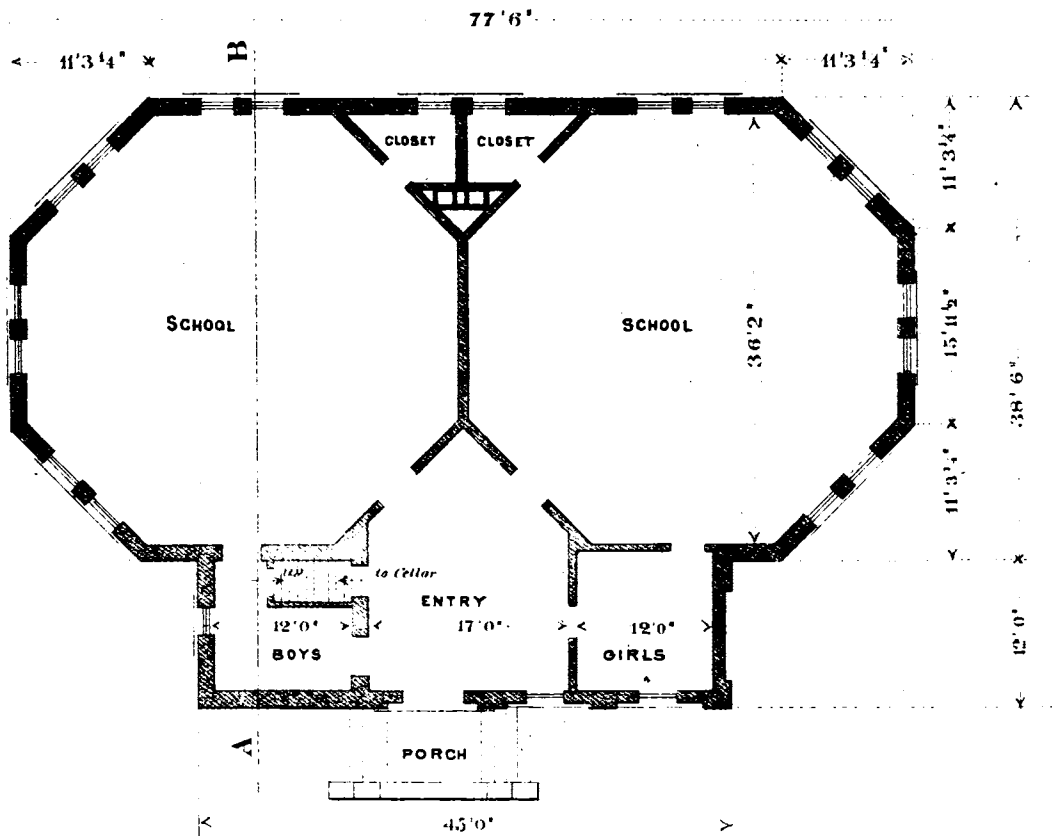
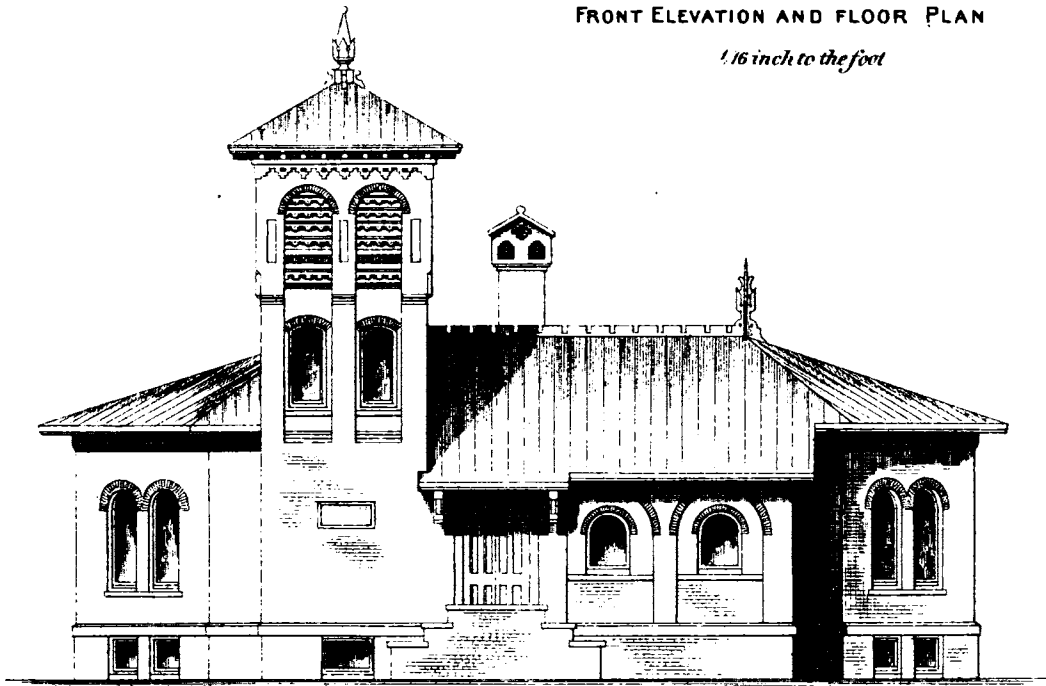



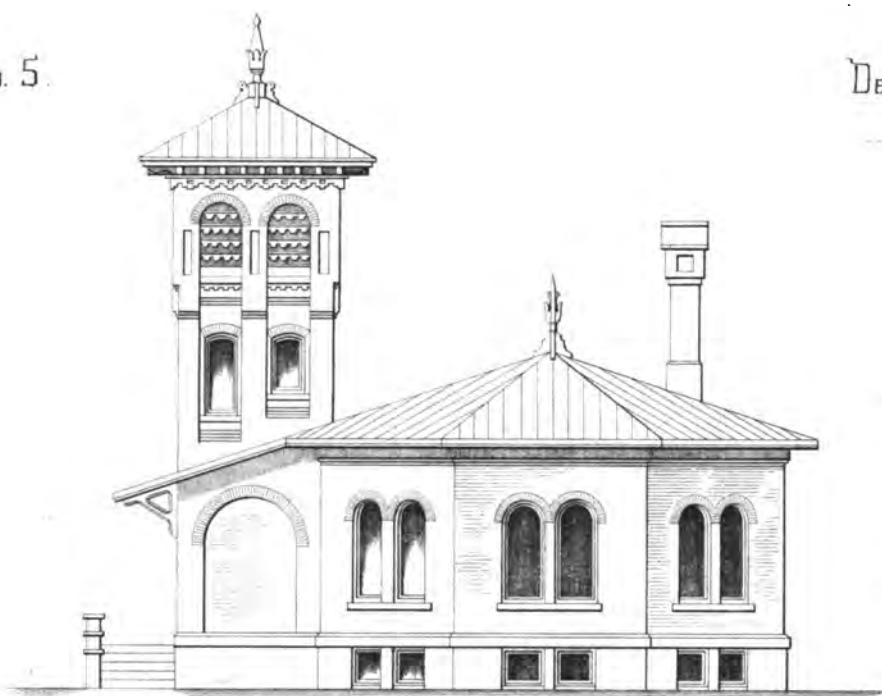

END ELEVATION $\frac{1}{16}$ inch to the foot

TOWER FINIAL

28'
7'
2'0"
12'
15'

DETAILS $\frac{1}{2}$ inch to the foot

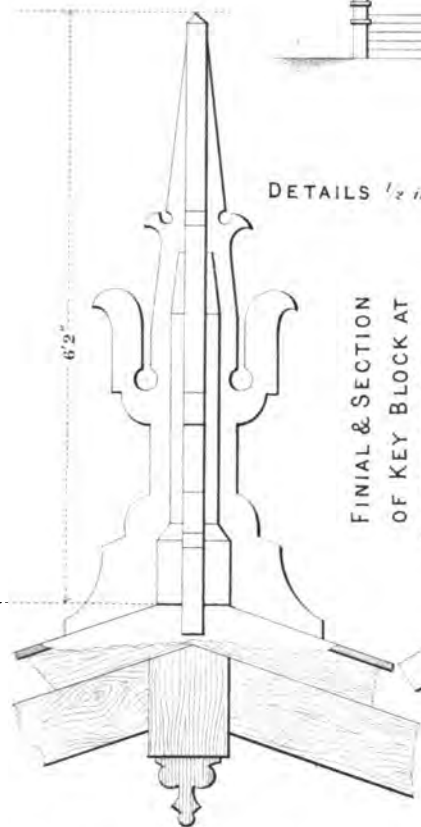

FINIAL & SECTION OF KEY BLOCK AT CENTRE OF CEILING

6'2"

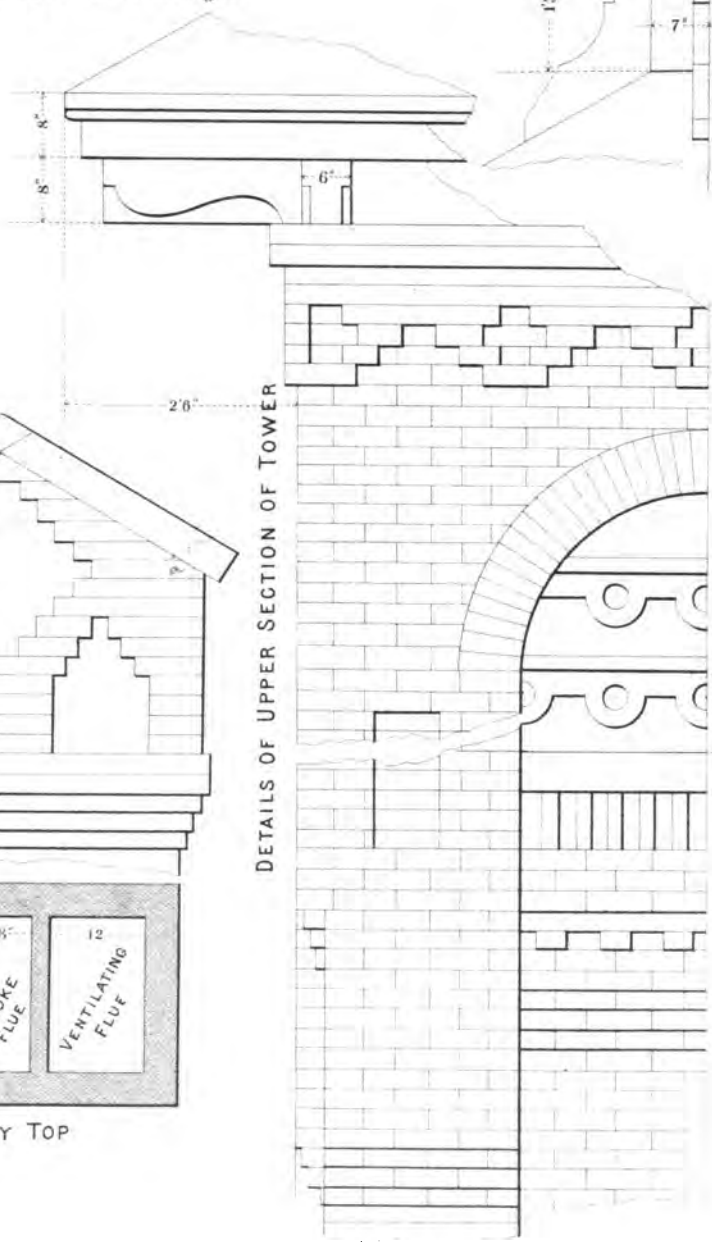

DETAILS OF UPPER SECTION OF TOWER

8"
8"
6"

2'6"

3'0"

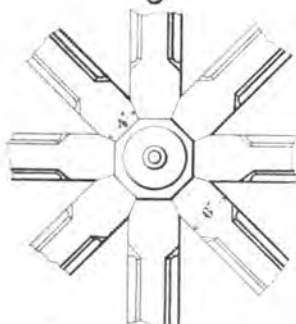

PLAN OF RAFTERS AND KEY BLOCK AT CENTRE OF CEILING

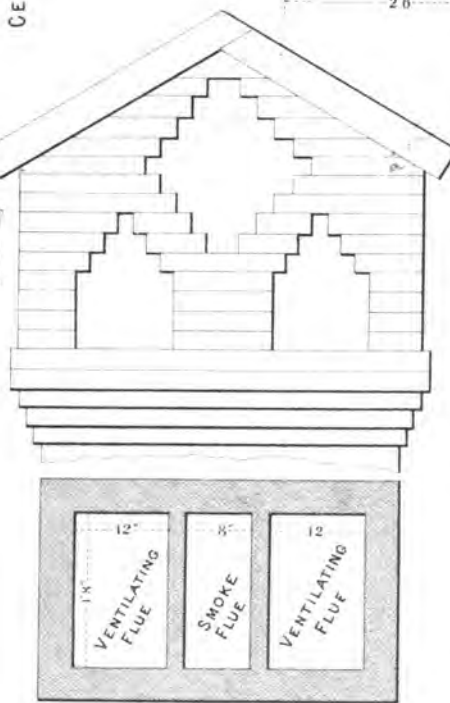

CHIMNEY TOP

12"
8"
12"
1'8"
VENTILATING FLUE
SMOKE FLUE
VENTILATING FLUE



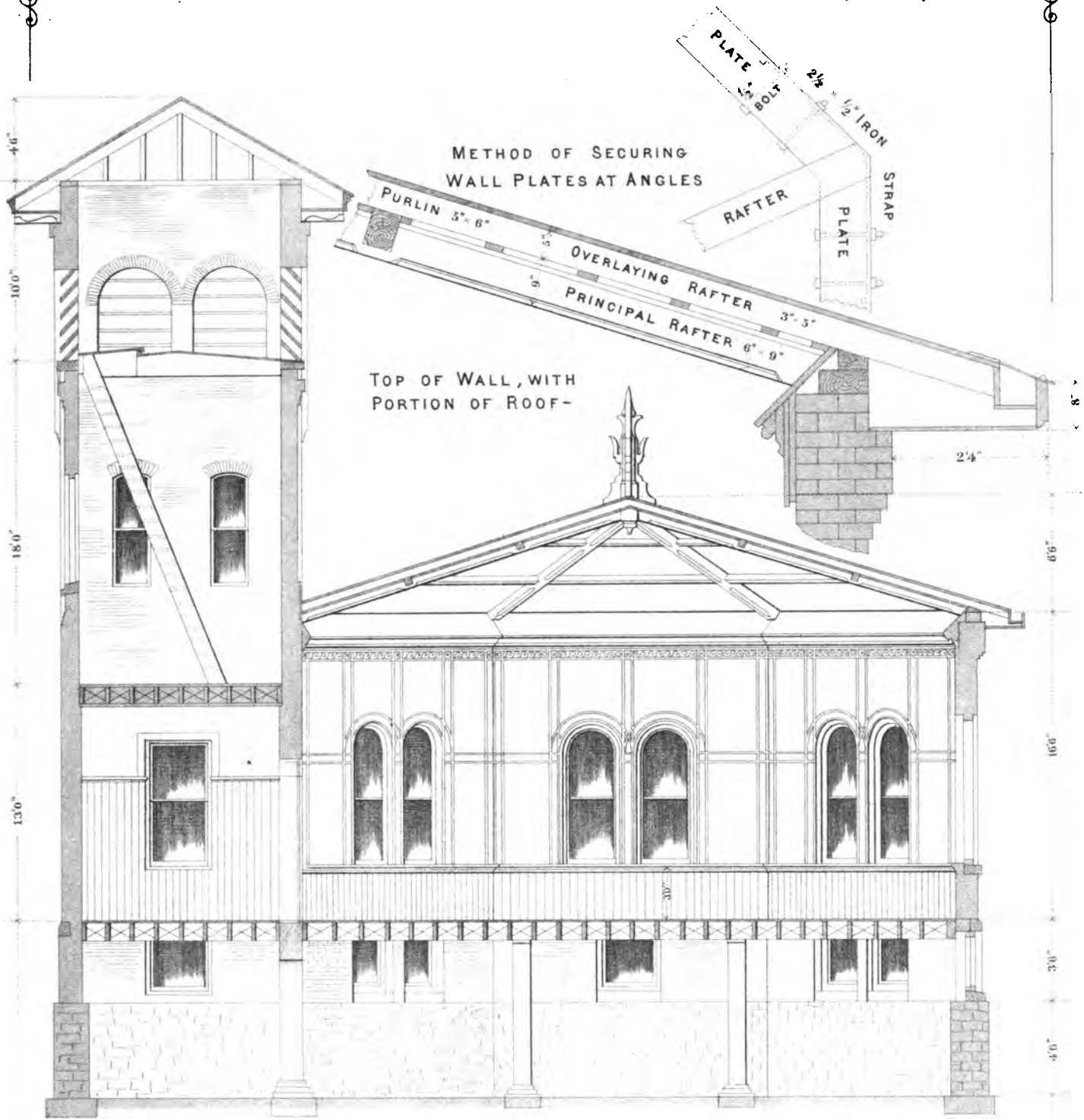

SECTION ON LINE A B *1/2 inch to the foot*

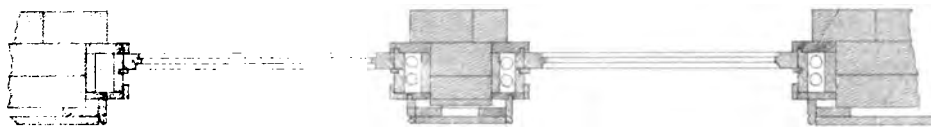

DETAILS *1/2 inch to the foot*

DESIGN NO. 6.

Plates 17, 18 and 19.

THIS design exhibits a brick school-house to accommodate two classes of pupils of both sexes, each class containing fifty-six pupils.

There is a separate entrance for the pupils of either sex, and a separate passage to the cellar or basement, which should be divided by two brick partitions directly under the cross partitions in the principal story. The central portion of the cellar furnishes room for the furnace and the storage of fuel, and the parts beneath the school-rooms serve as play-rooms during foul weather. The two chimney flues which appear on the plan are joined above, and are designed to be used to ventilate the lower part of the school-rooms, by the aid of the iron or earthen smoke-flue before described.

The upper part of the school-room is ventilated by means of openings into the space above, which communicates with the open air through the dormers and the shaded gable windows.

The walls, to the height of the plate, are 12 inches thick, and in the gables 8 inches thick, with buttresses in the latter flush with the wall below, the break in the wall being marked by a stone course.

The reveal of the windows is equal to the width of two bricks, and a rebate is formed in the jamb of the windows in the principal story, by setting back the outer course 4 inches from the line of the inner course, terminating the rebate with stone quoins.

The color of the exterior wood-work should resemble that of the stone used.

Two shades should be employed, one of them considerably darker than the other, the darker shade being used for the beads upon the rafters, the chamfered work, and similar parts.



ELEVATION AND FLOOR PLAN

1/10 inch to the foot

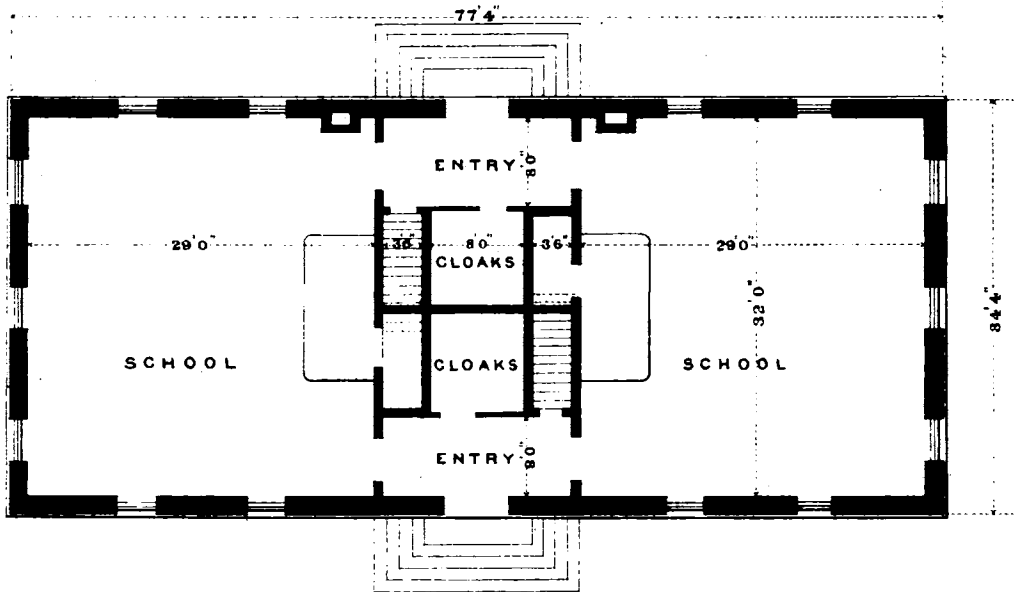
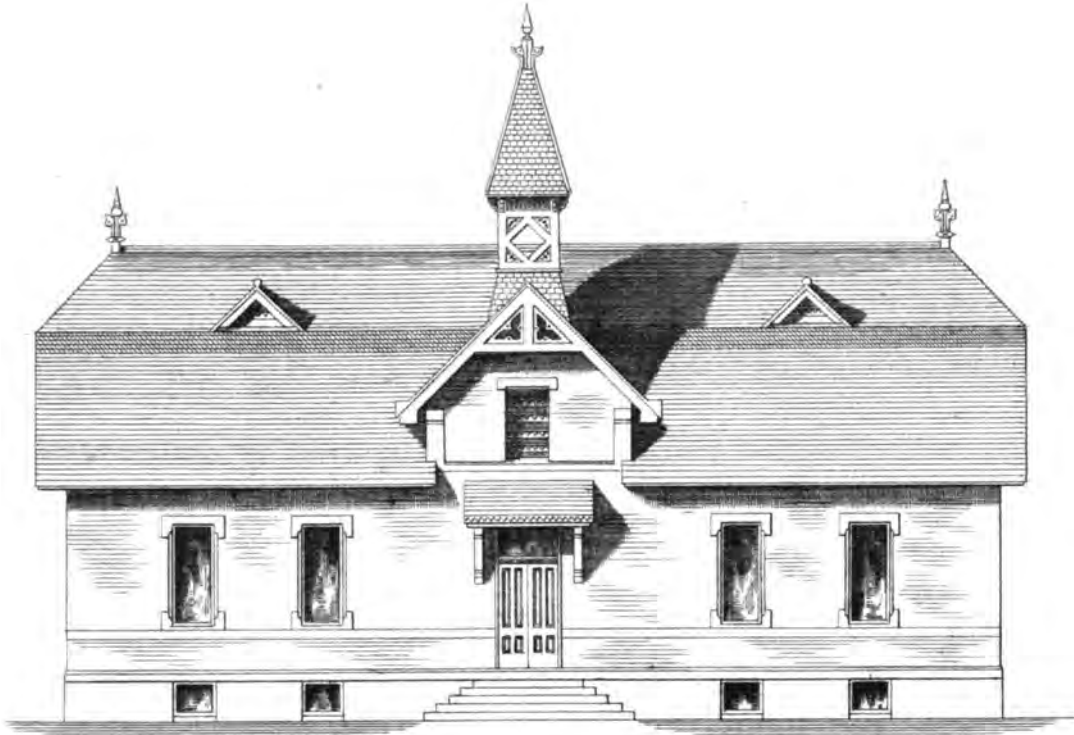

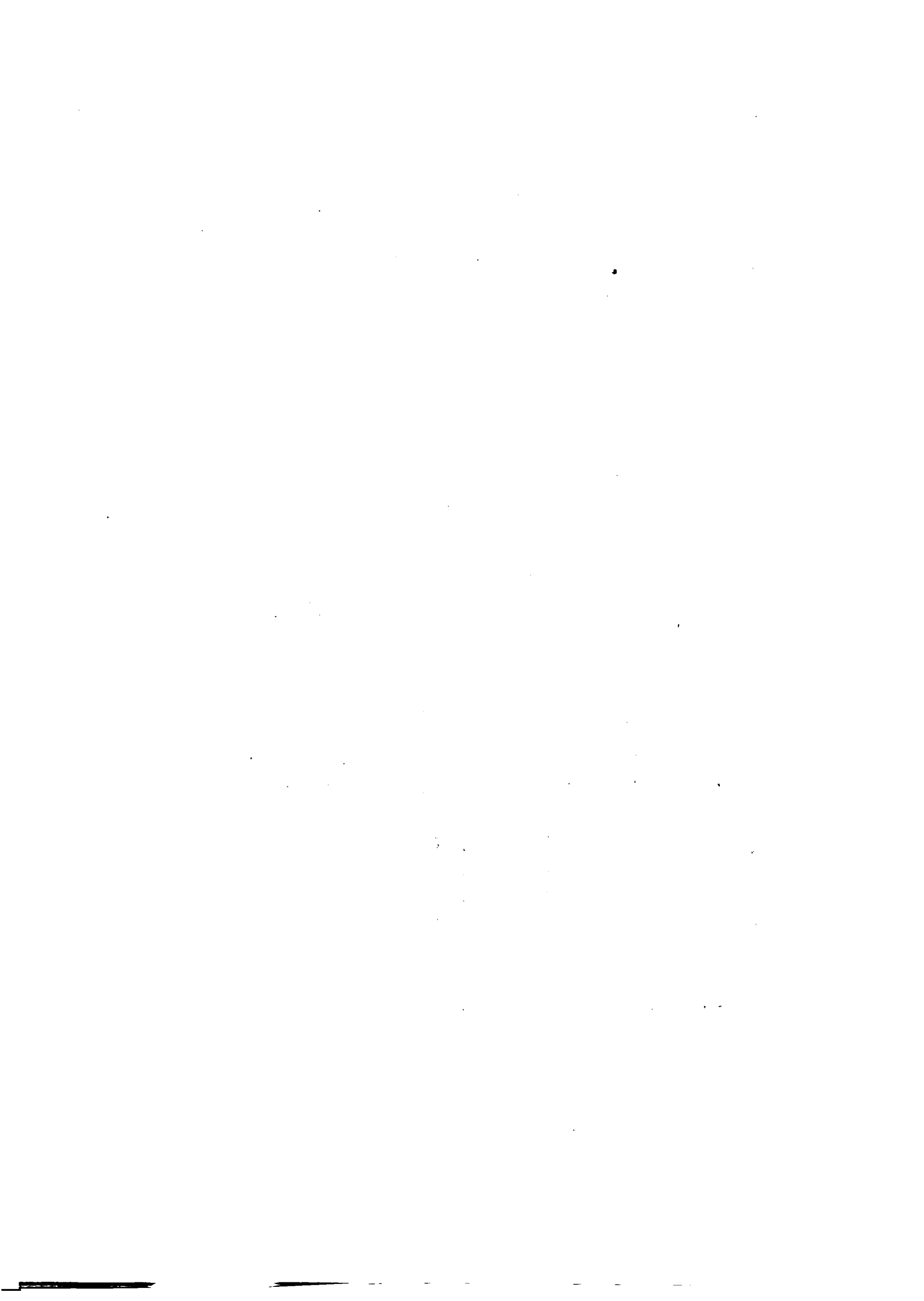

ELEVATION

1/16 inch to the foot

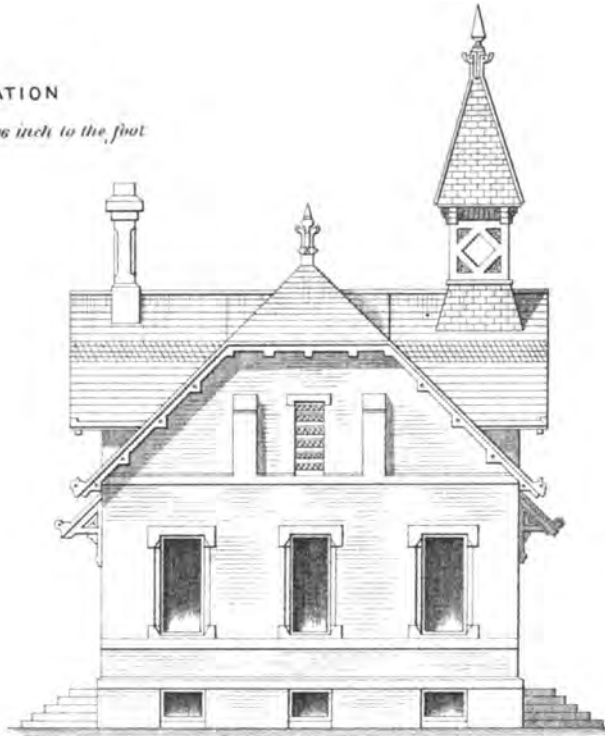

DETAILS

1/2 inch to the foot

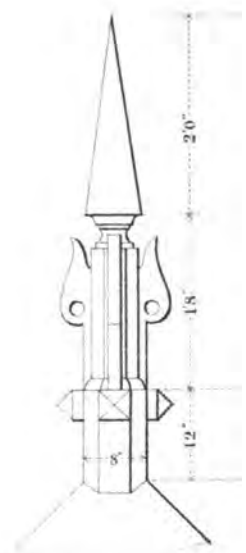
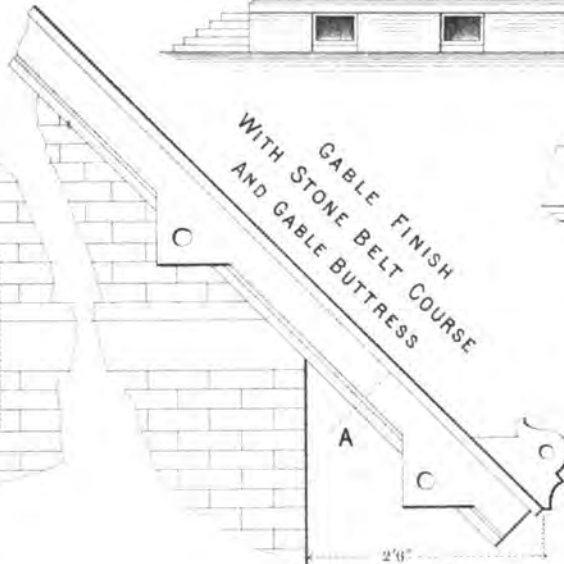
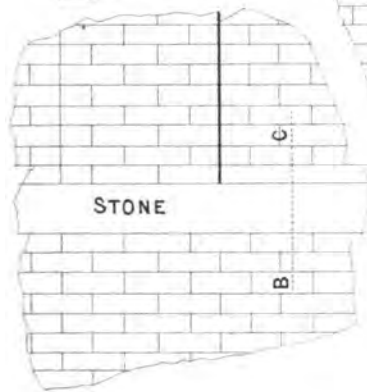

FINIAL

CORNICE & C



SECTION AT A

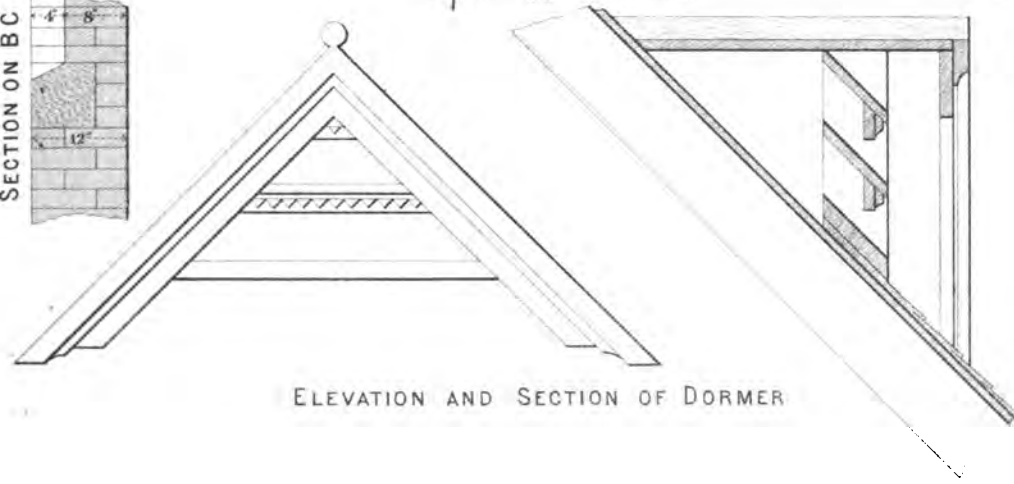

ELEVATION AND SECTION OF DORMER



Design No. 6.

DETAILS

1/2 inch to the foot

Plate No. 19.

SECTION ON A.B.

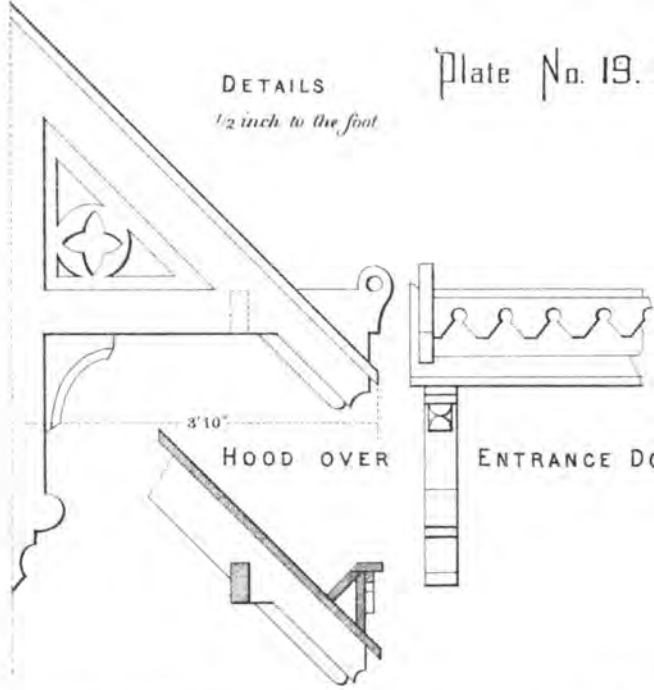
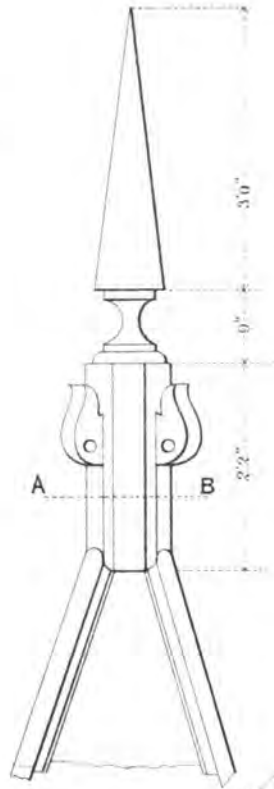

DETAILS OF BELL TOWER

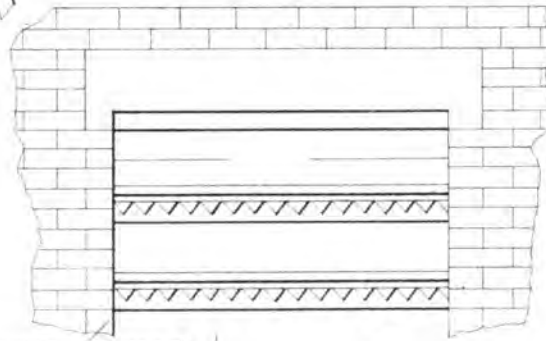
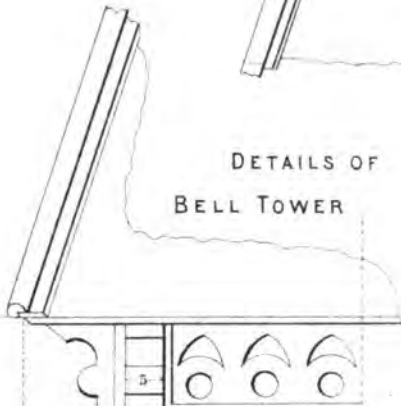

DETAILS OF GABLE WINDOWS

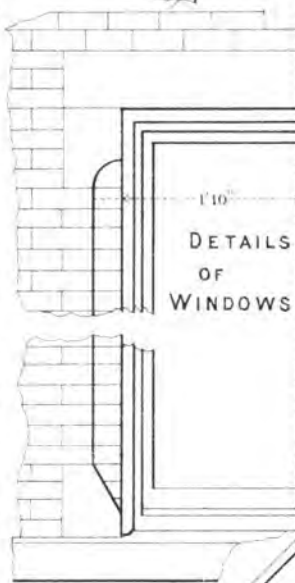
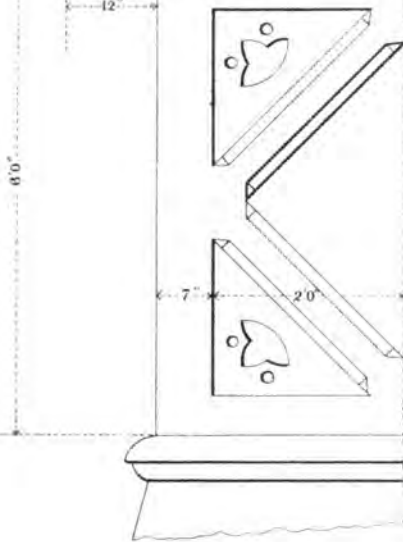

DETAILS OF WINDOWS

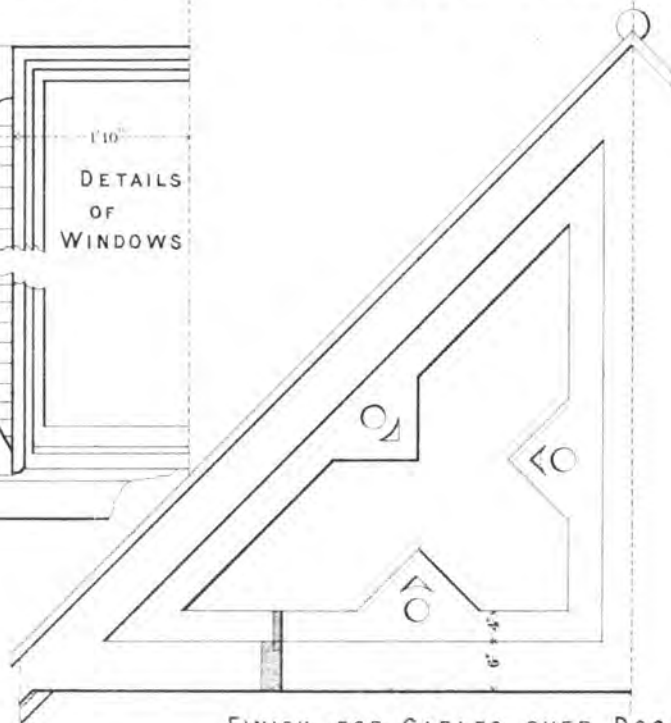

FINISH FOR GABLES OVER DOORS

SECTION OF WINDOW JAMB

1 inch to the foot

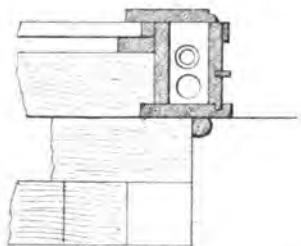

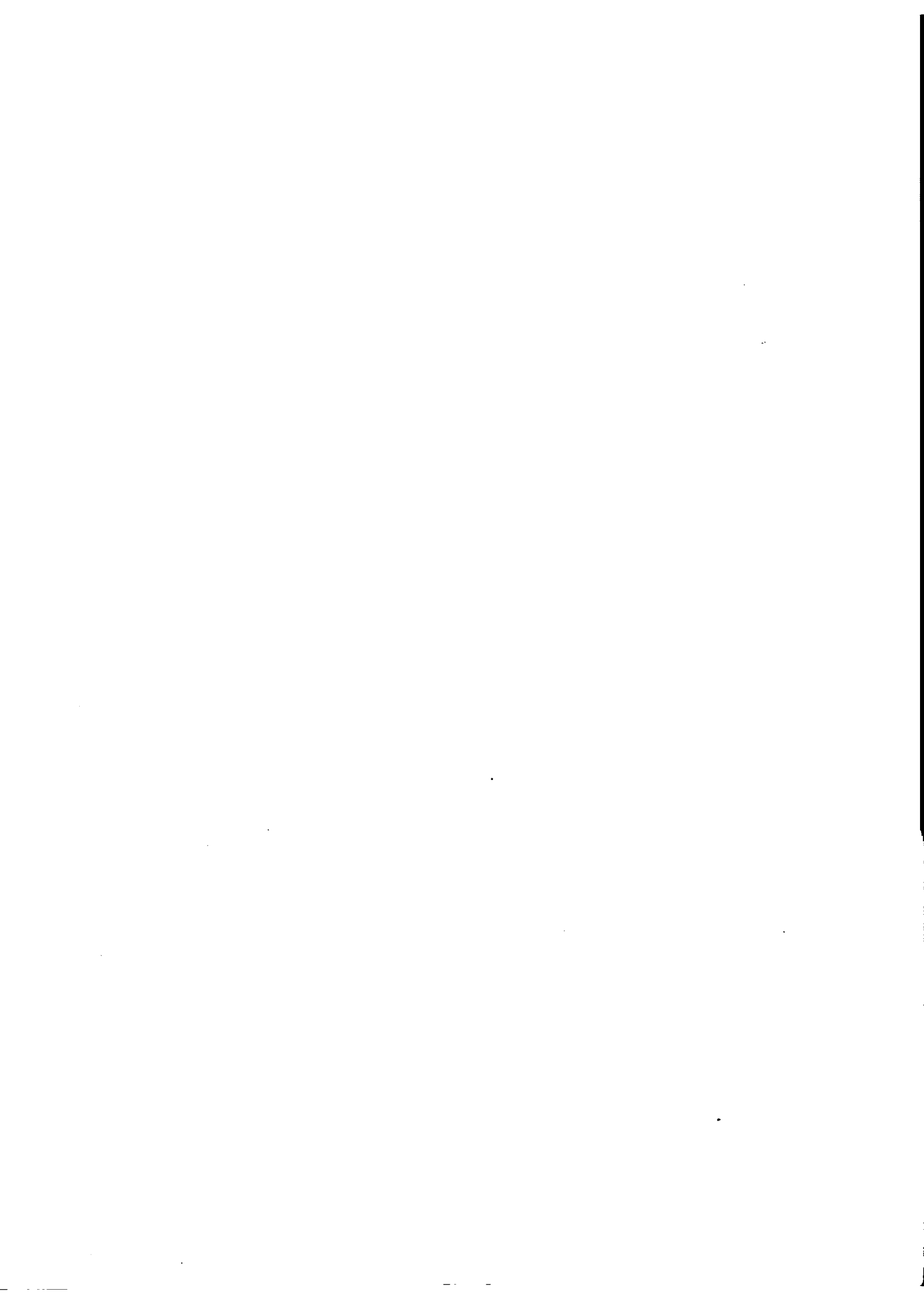

DESIGN NO. 7.

Plates 20, 21 and 22.

A VILLAGE School-house, for two schools or classes, composed of pupils of both sexes, with separate entrances for those of either sex.

The basement is designed to contain one large room under the school-room, also the hot-air furnace, fuel-room, and water or earth-closets for the teachers' use.

The registers admitting the heated air to the school-rooms, are set on the side of the rooms opposite that in which the ventilating registers are put.

It is believed that the construction is sufficiently explained in the drawings, without further description.

The hinging of blinds, either upon the outside or inside of double or triple windows, being attended with some practical difficulties, the arrangement shown in Plate No. 67 is recommended for such cases. Or inside blinds, suspended by cords, and raised or lowered by means of them, may be used.

Besides the method of making a blackboard surface described in the Specification for Design 13, and the use of slate in large slabs for that purpose, a preparation called "Liquid Slate," which may be applied to wood, paper, or plaster, is extensively used, and highly recommended.

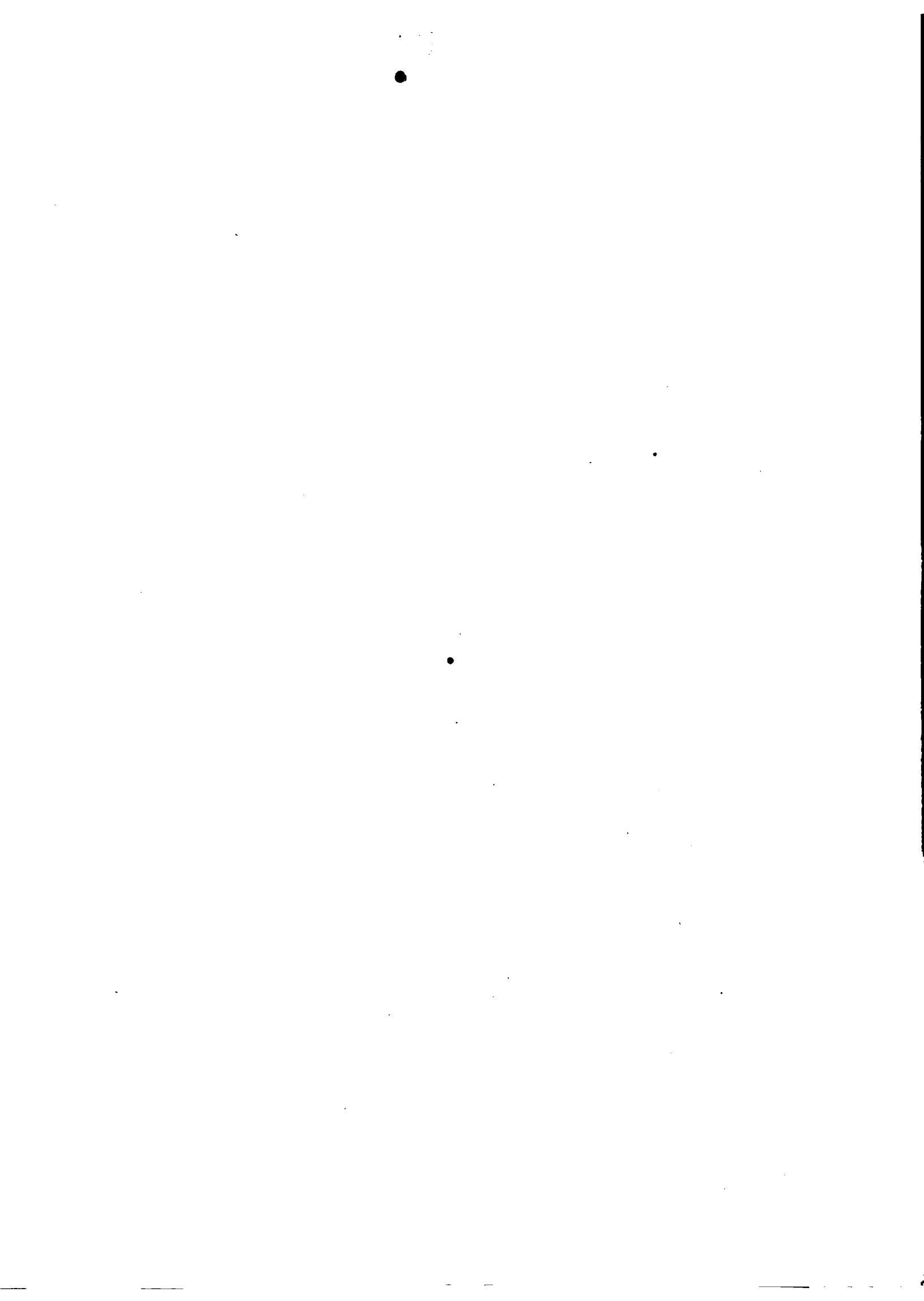

Design No. 7.

SIDE ELEVATION AND FIRST FLOOR PLAN

Plate No. 20.

1/8 inch to the foot

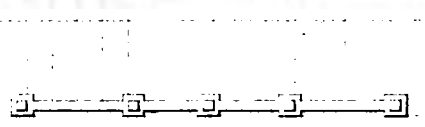
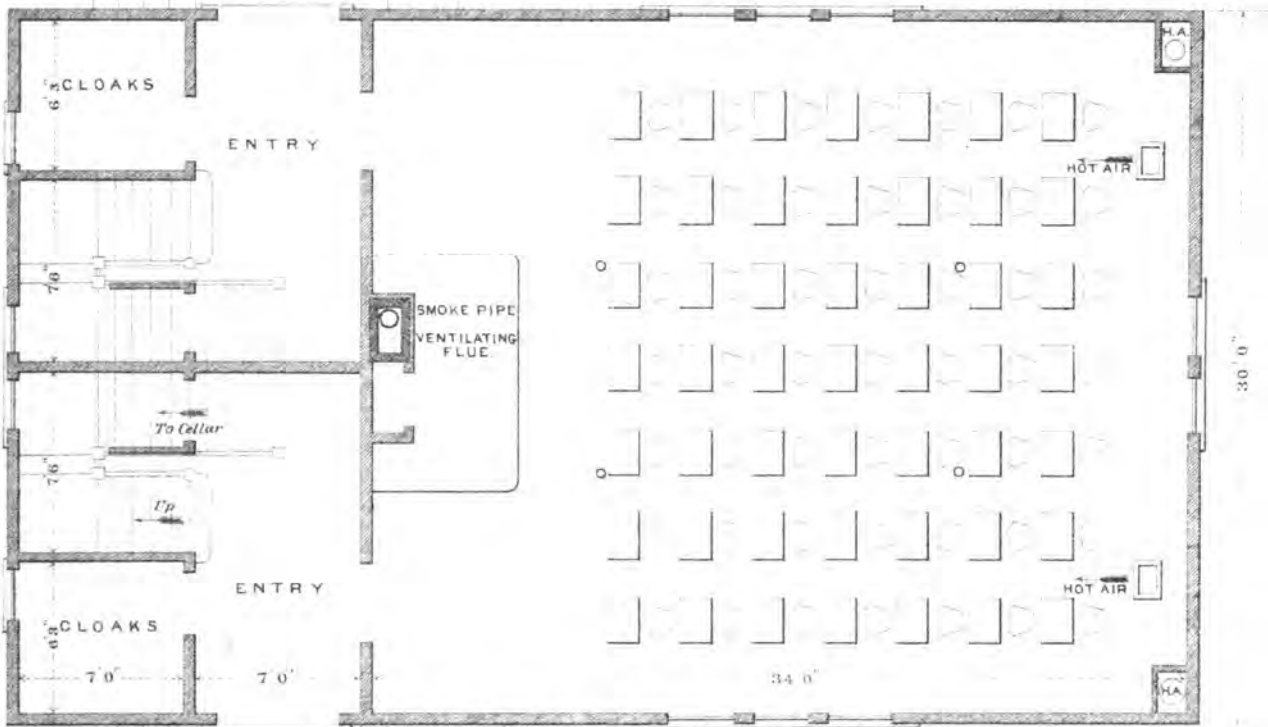
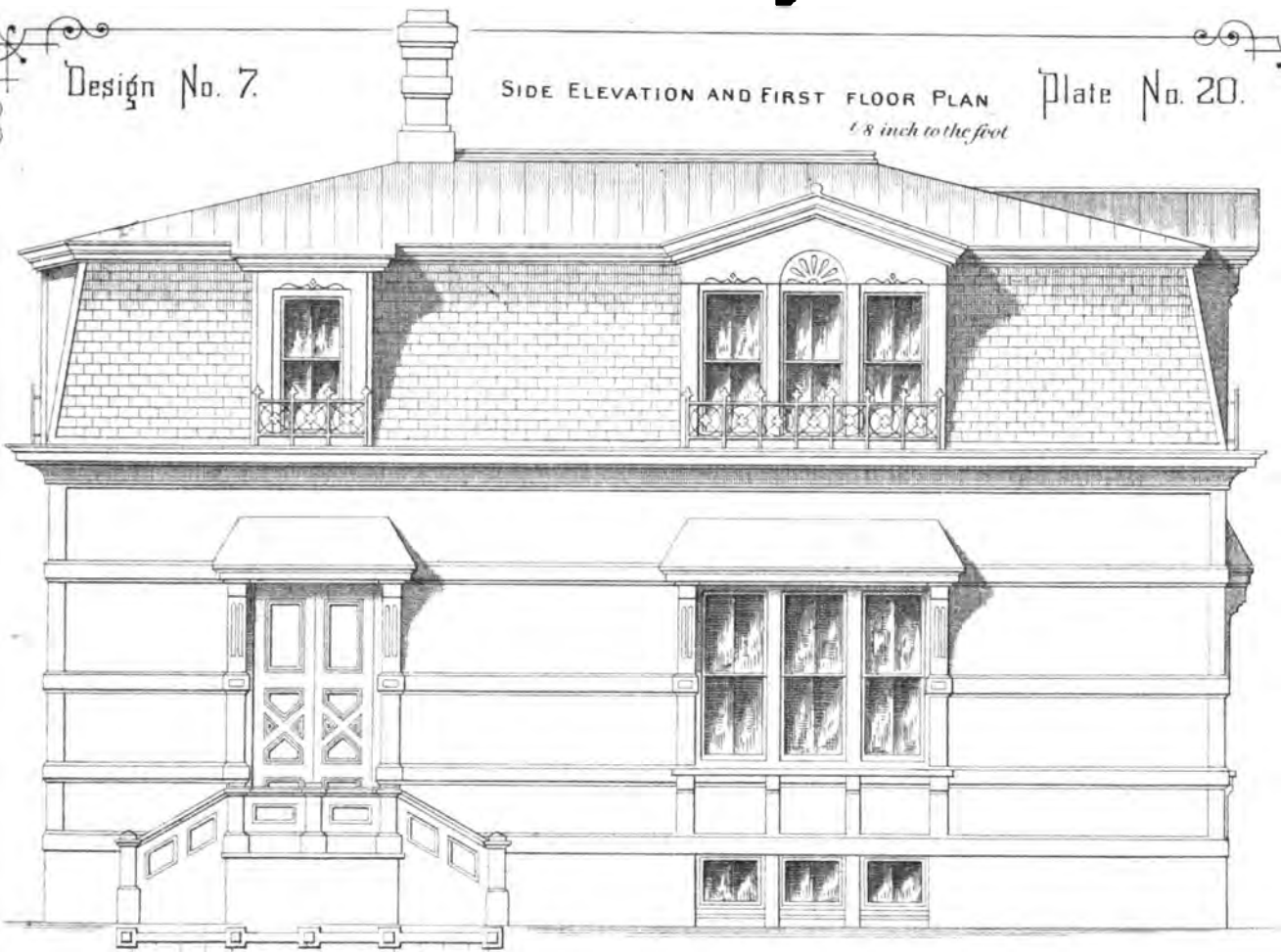



Design No. 7.

Plate No. 21.

END ELEVATION, SECOND STORY PLAN,
AND SECTION OF WALL.

1/8 inch to the foot

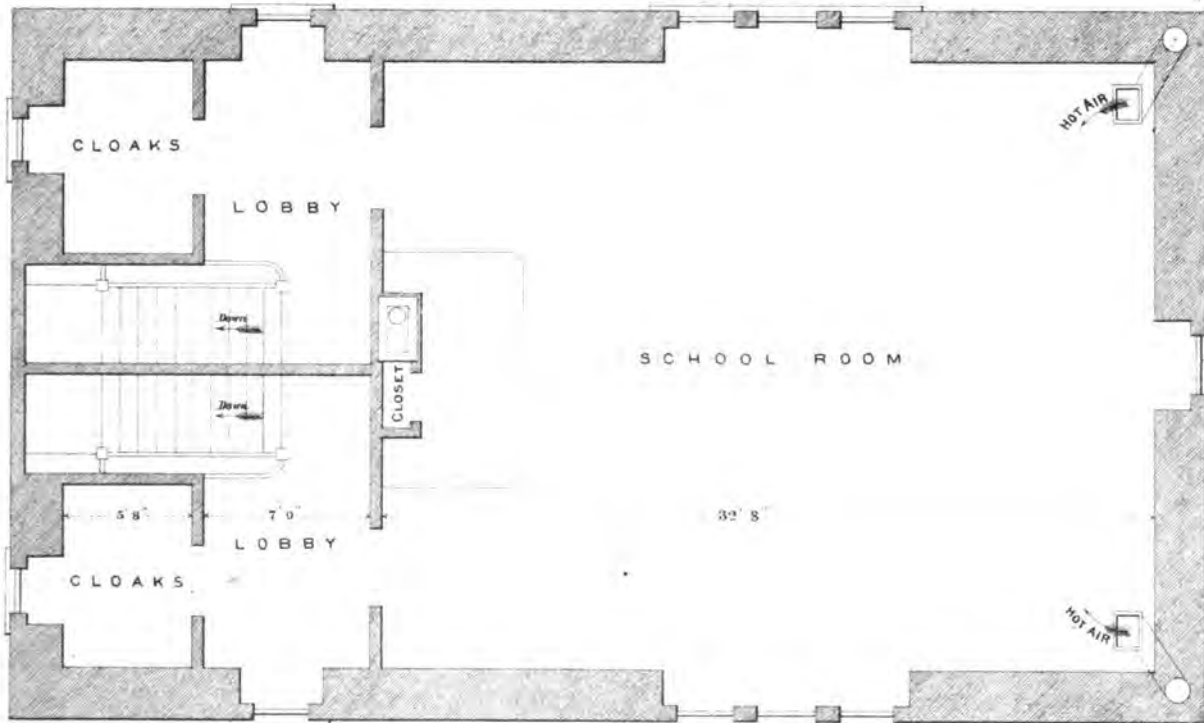
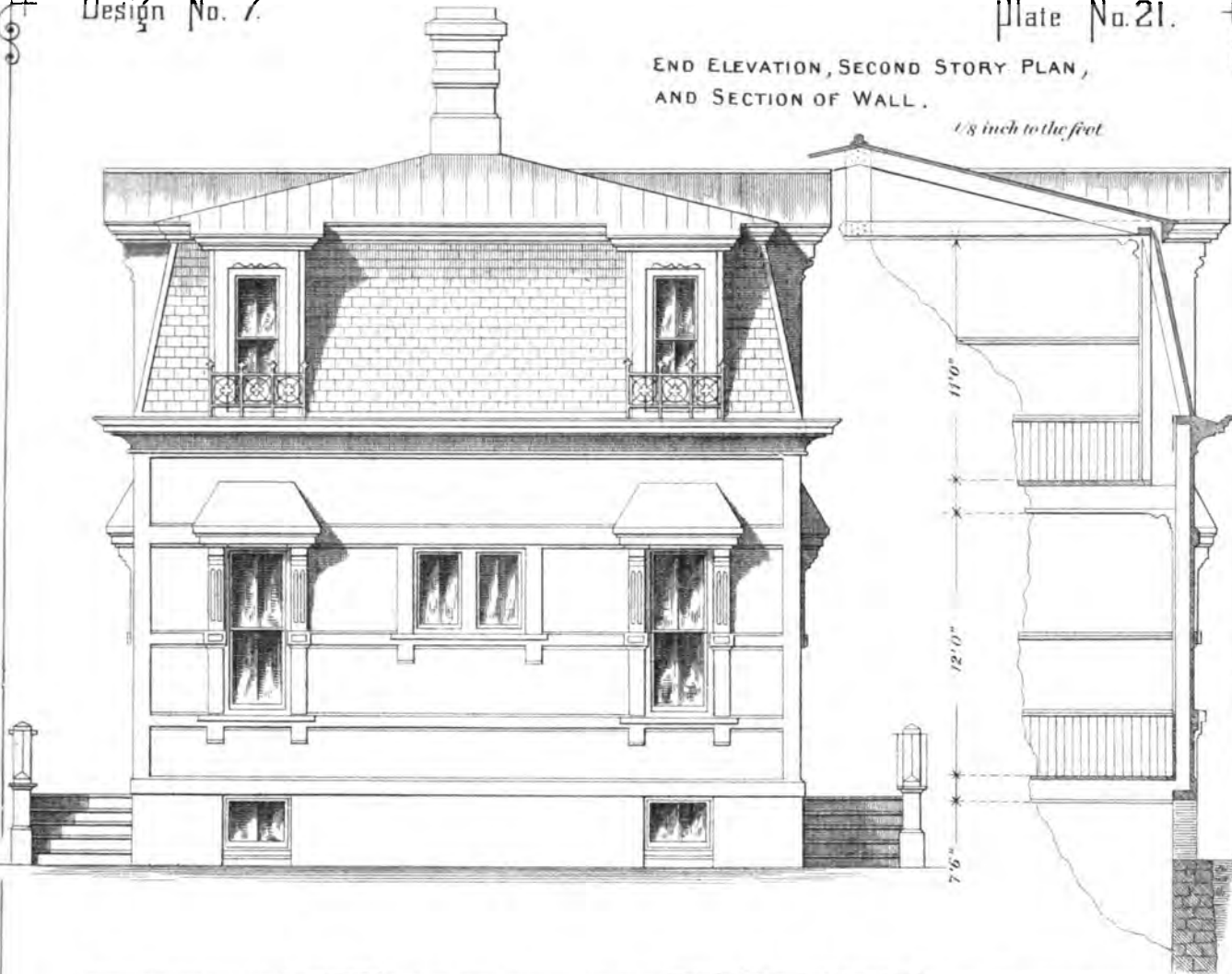

Design No. 7

DETAILS - Plate No. 22.
1/2 Inch to the foot

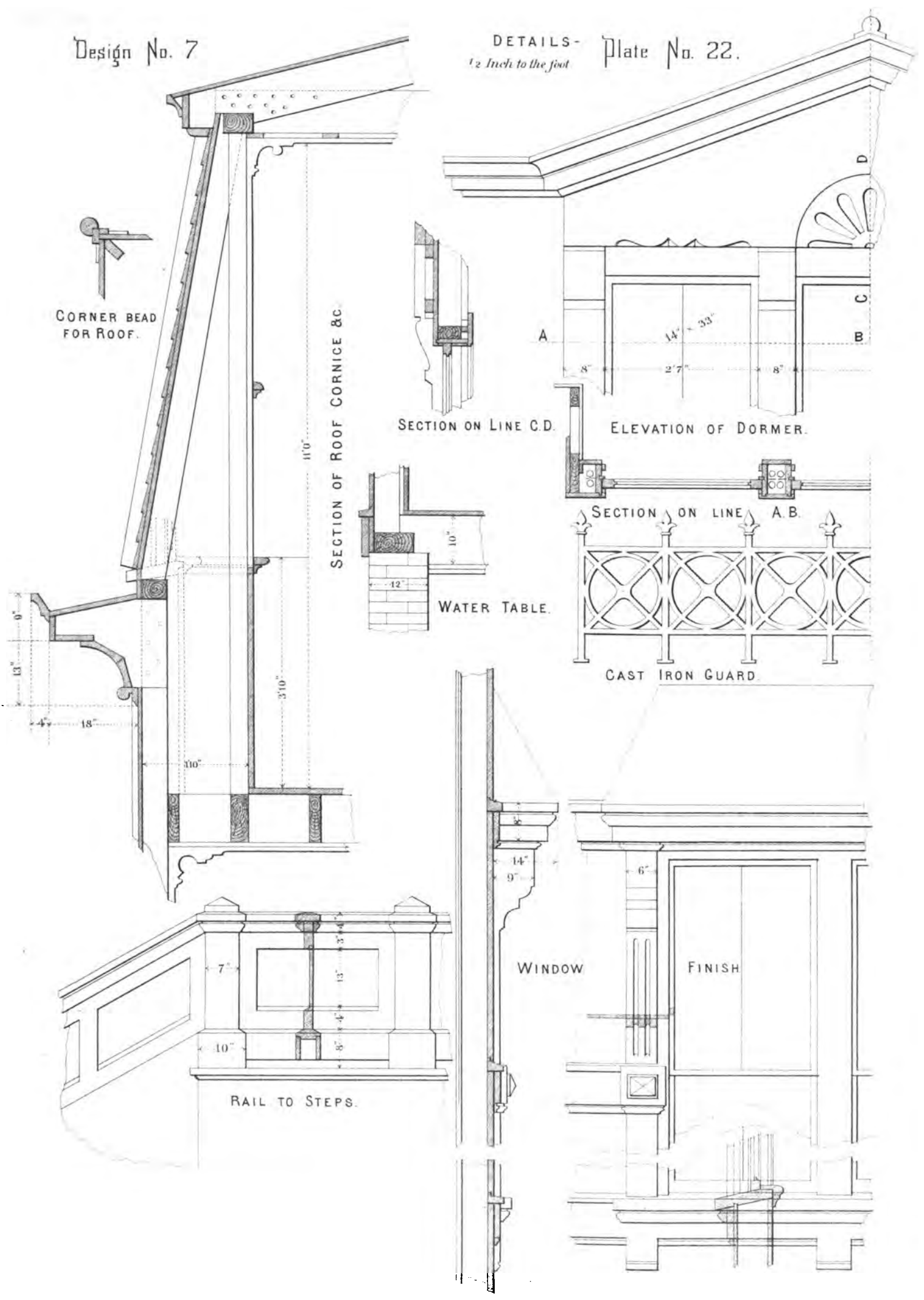

DESIGN NO. 8.

Plates 23, 24 and 25

A VILLAGE School-house, for the use of two schools.

The first story plan shows the arrangement of the single desks required for 56 pupils, with the width of aisles and outer passages usually allowed. Two feet is the common length of single desks for grammar schools, but for high schools they are more frequently 27 inches long. Double desks (for two pupils each) are three and one-half feet long, and two feet is the usual allowance for aisles.

It is believed that the construction of the roof is sufficiently explained in the plates, except that it ought to be added that the upper plate should be trussed over the window recesses.

The walls are finished with narrow-matched siding, the trimmings being $1\frac{1}{4}$ inches thick.

If slate is used for the steep roofs, small ornamental figures of different colored slates should be introduced, and if these roofs are covered with shingles, there should be a belt of six courses in the centre of the height, with half octagon, or pointed ends, and the shingles should be painted.

The flat roofs are covered with tin.

Two shades of color should be used in painting the wood-finish, and a tint considerably brighter than either of them should be applied to the chamfers, a narrow line of the same tint being drawn around the scroll-sawed figures shown in some parts of the design.

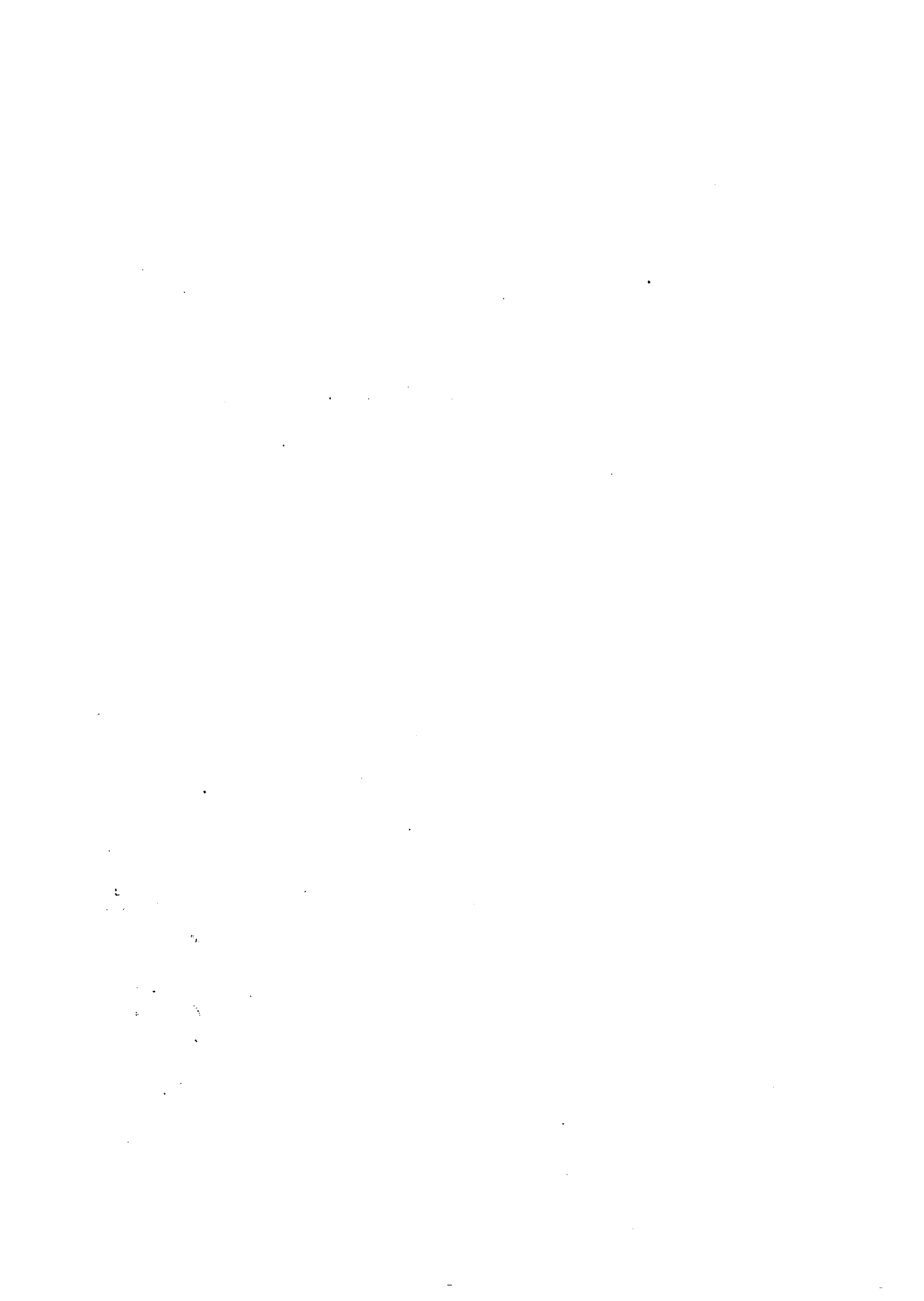

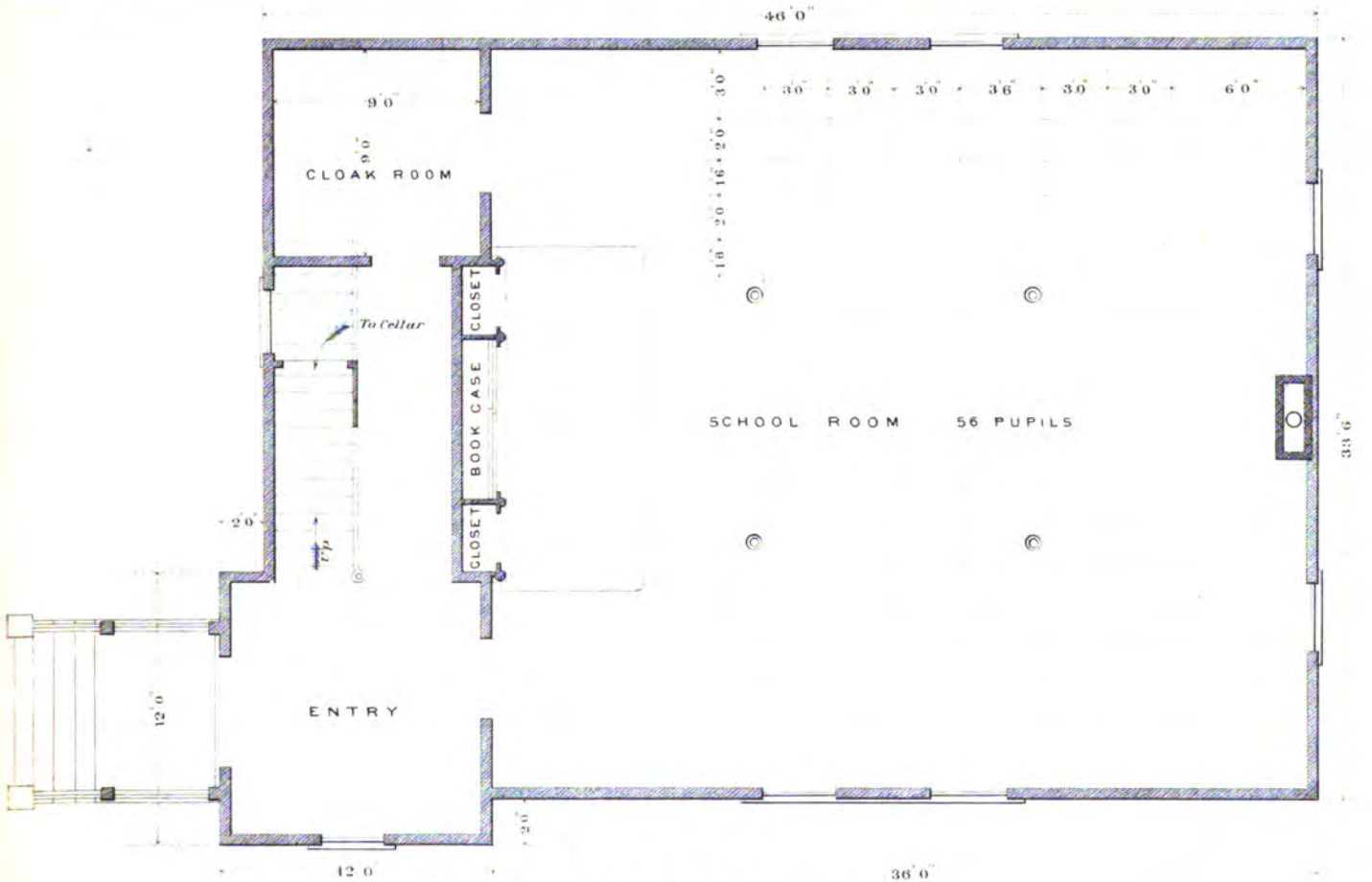
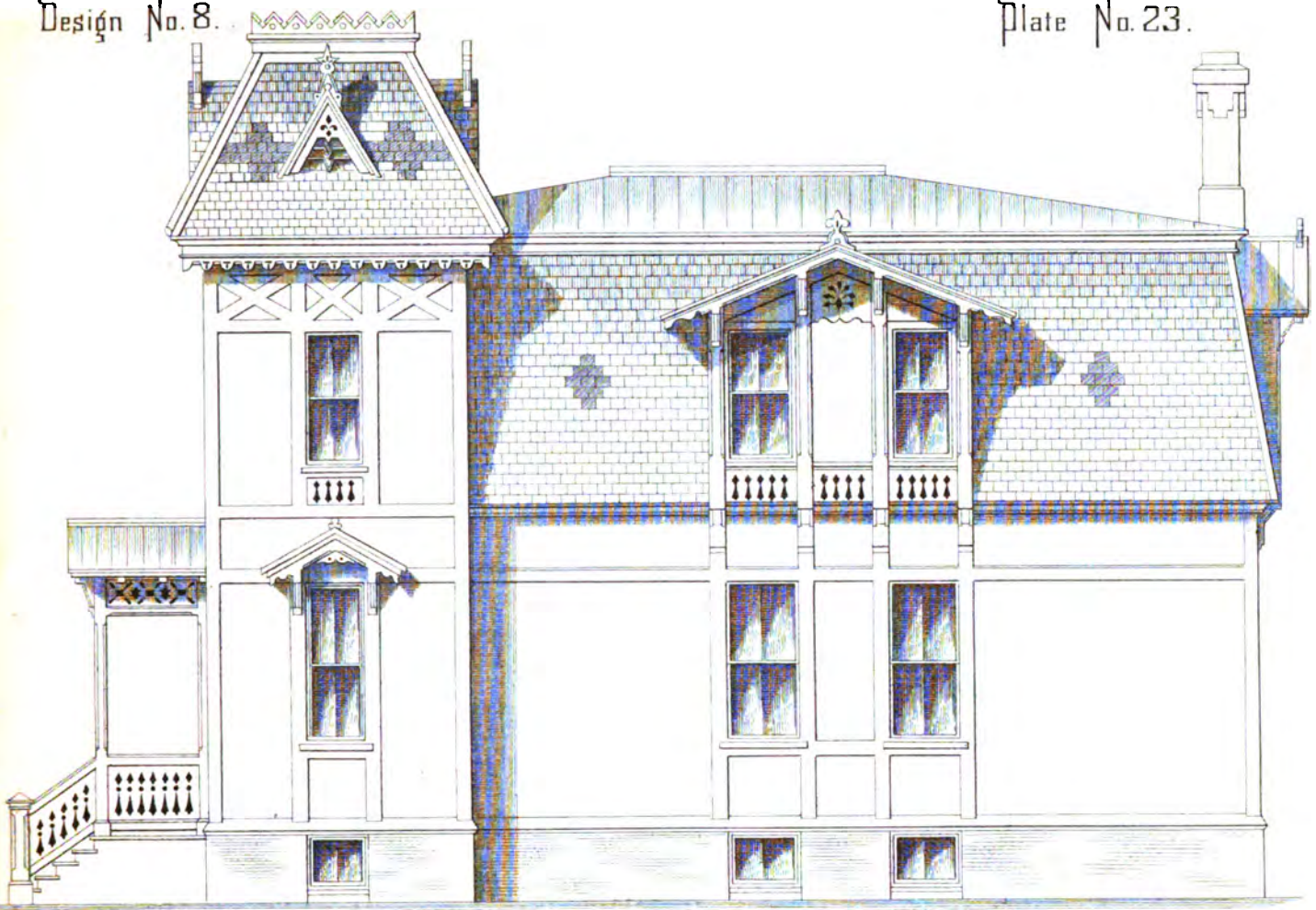

SIDE ELEVATION AND FIRST FLOOR PLAN
1/8 inch to the feet



FRONT ELEVATION AND SECOND FLOOR PLAN.

1/16 inch to the foot

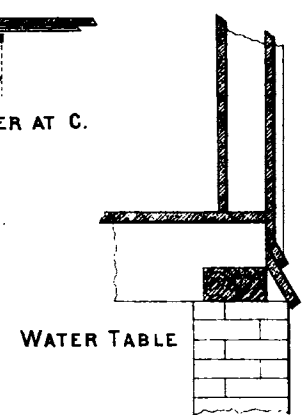
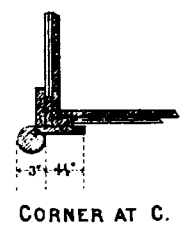
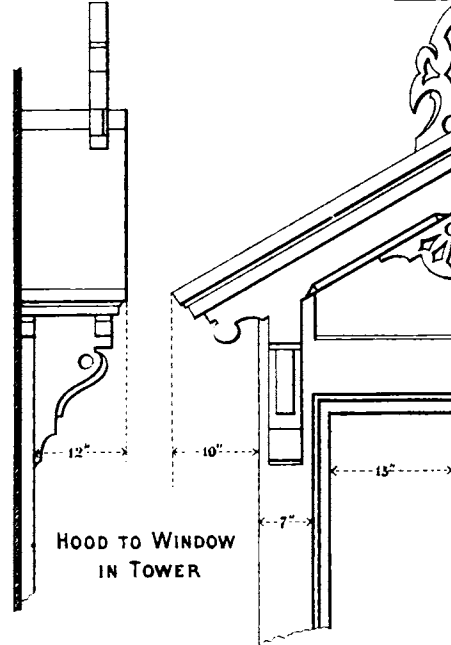
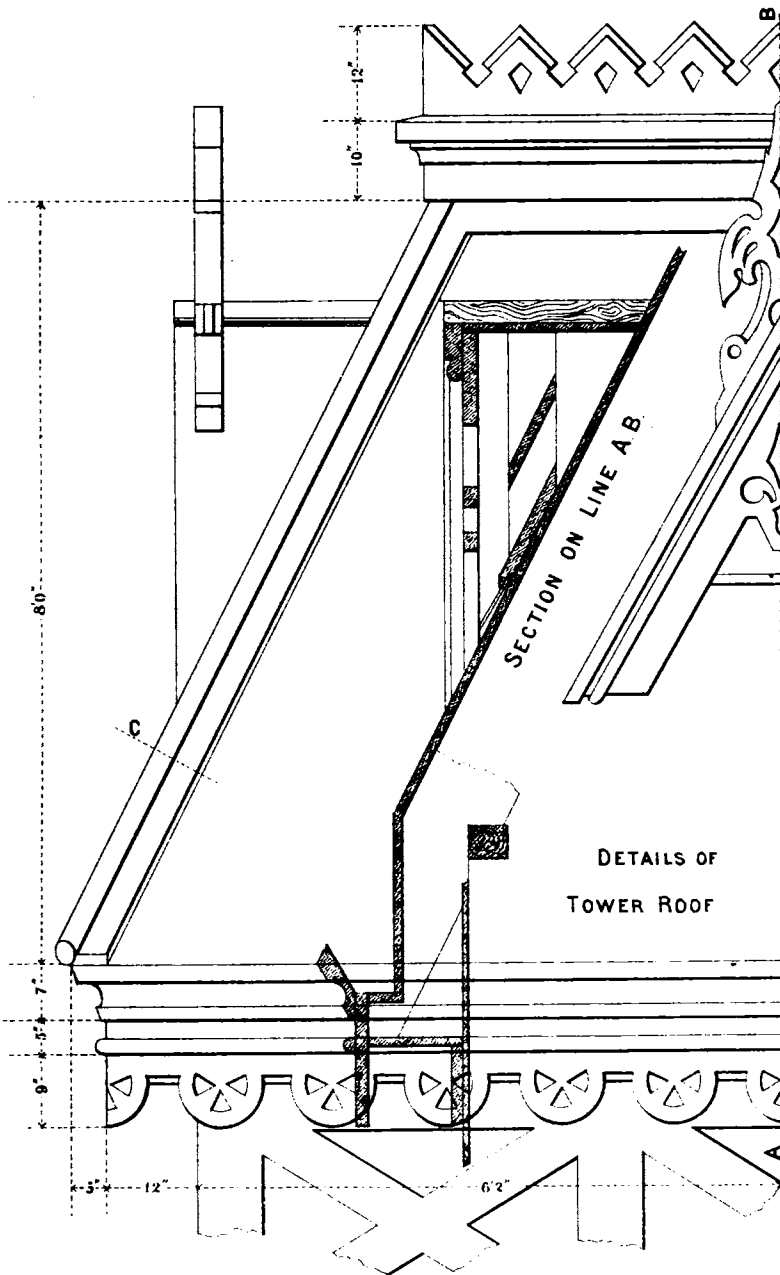
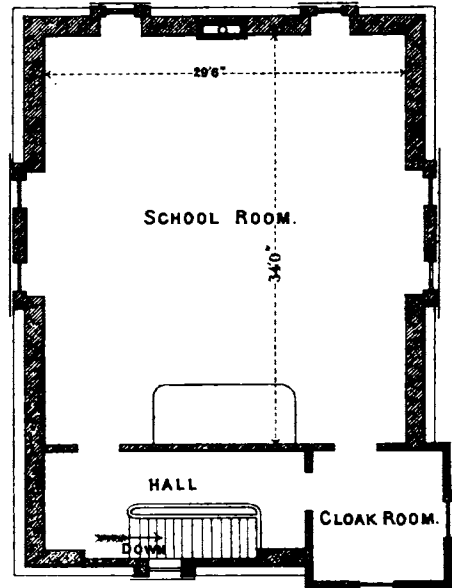
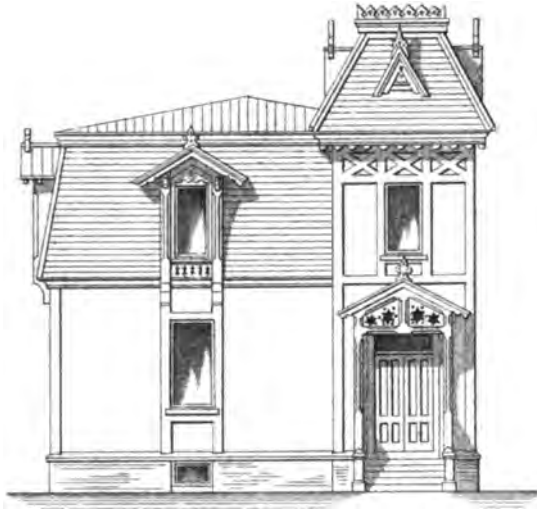

DETAILS *1/2 inch to the foot*

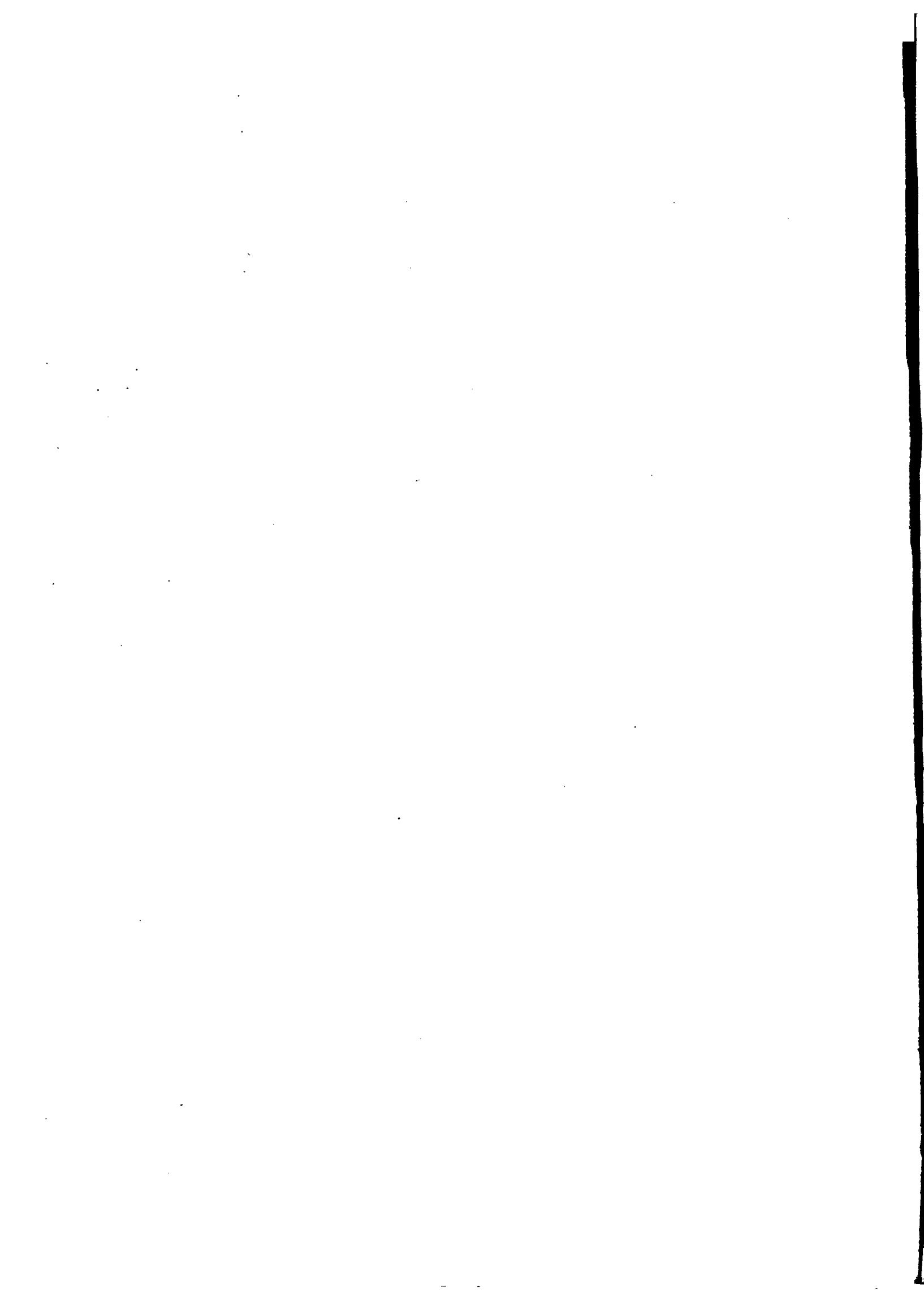

DETAILS OF ROOF AND DORMER WINDOWS

1/2 inch to the foot

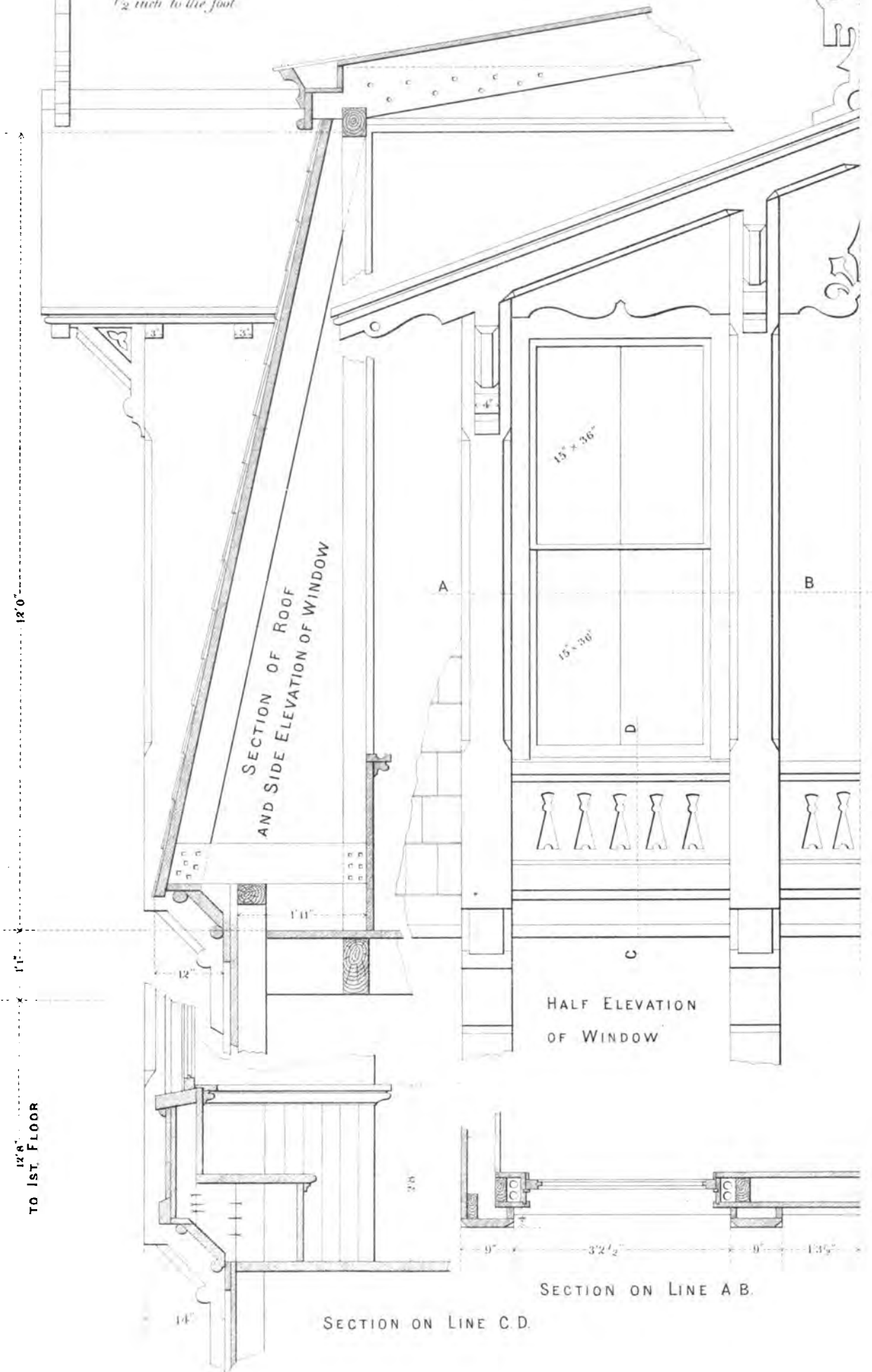

TO 1ST FLOOR

HALF ELEVATION OF WINDOW

SECTION ON LINE A.B.

SECTION ON LINE C.D.

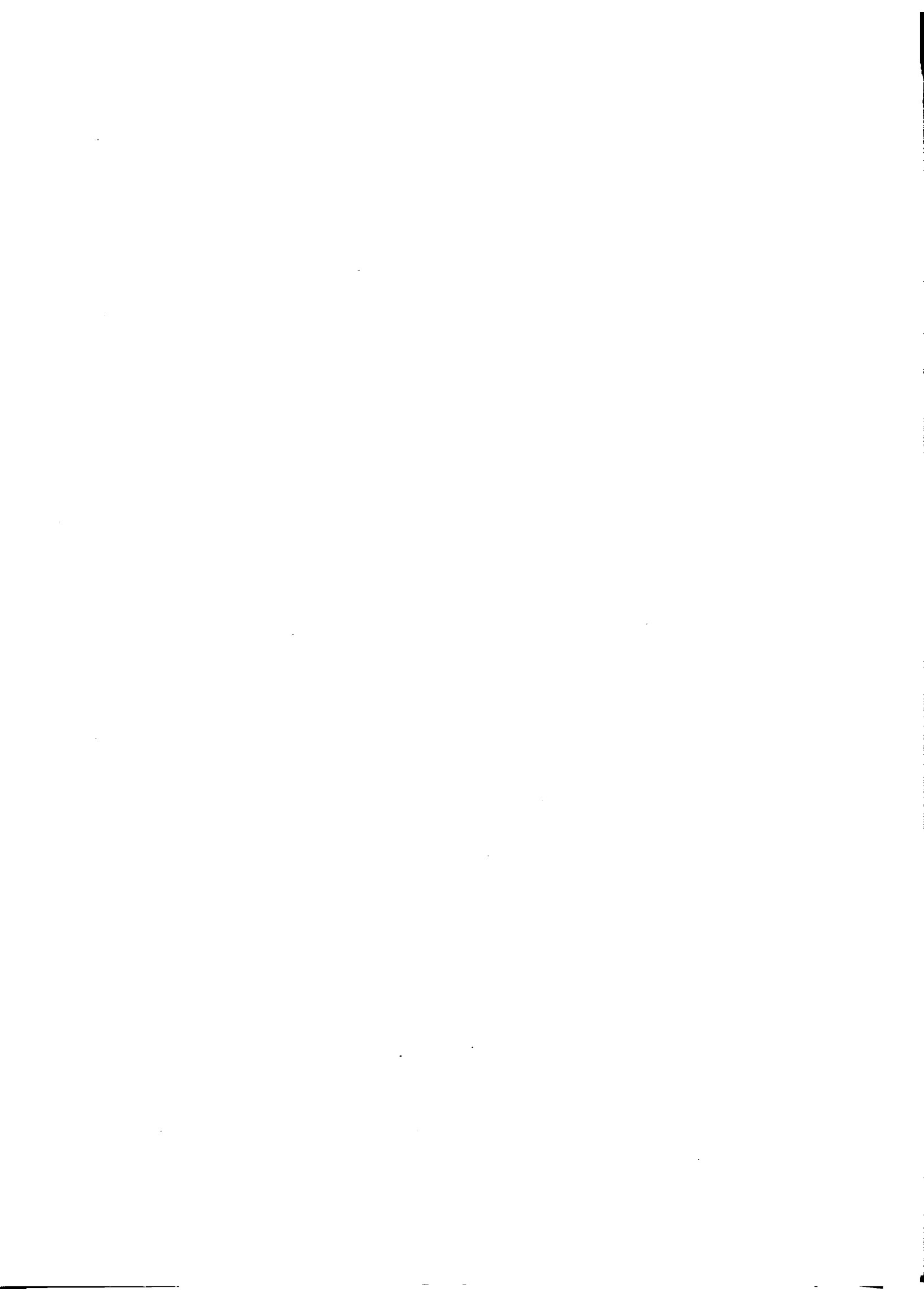

DESIGN NO. 9.

Plates 26, 27, 28 and 29.

THIS design exhibits an arrangement of two school-rooms and dependencies, to accommodate pupils of both sexes, each room being large enough for forty-eight pupils.

The framing of the roof consists of two principal rafters, set one on either side of the triple windows in the second story, these principals being more fully described in the sectional drawing. The gables over the triple windows permit the purlins spanning the space occupied by the windows to be trussed, and support for the end portions of the roof may be gained from the partitions at the ends of the school-room.

The vaults for the water-closets are built as shown in Plate No. 10, and the rain water from the roof is used for cleaning purposes, as there represented. Ventilation for these closets is secured by means of two latticed openings extending the whole height of the room enclosing them, the partitions dividing off the closets being only 7 feet high.

Access to the cellar is secured by flights of stairs under those shown on the plans, reached from the cloak-rooms.

The walls are covered with narrow tongued and grooved weather-boarding, the trimmings being $1\frac{1}{2}$ inches thick.

The main cornice is cased up on the slope of the rafters, with a gutter at the edge.

The gables and porches are finished with scantling and scroll-sawed plank, as represented in the plates.

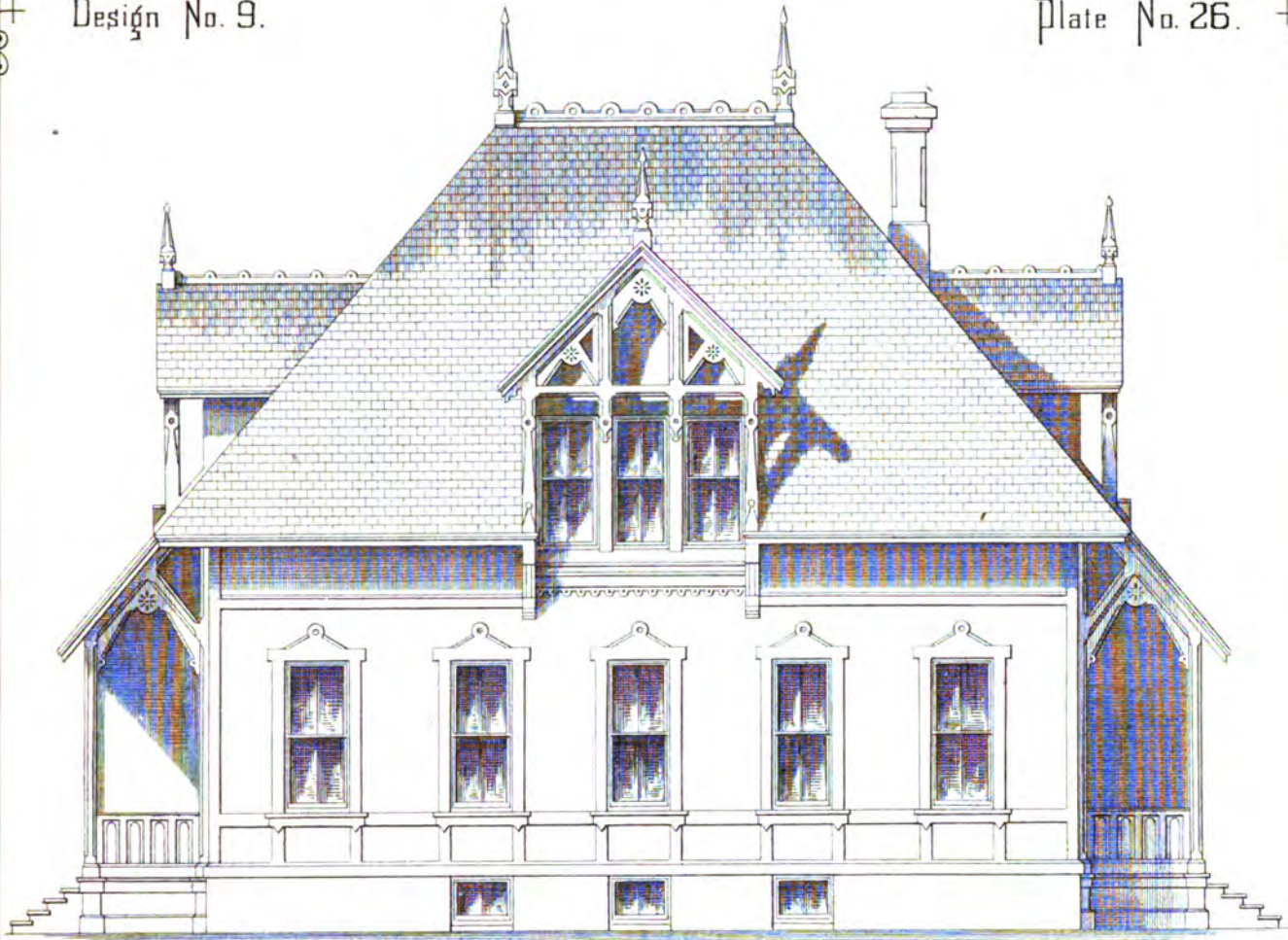

SIDE ELEVATION AND FIRST FLOOR PLAN
3/32 inch to the foot

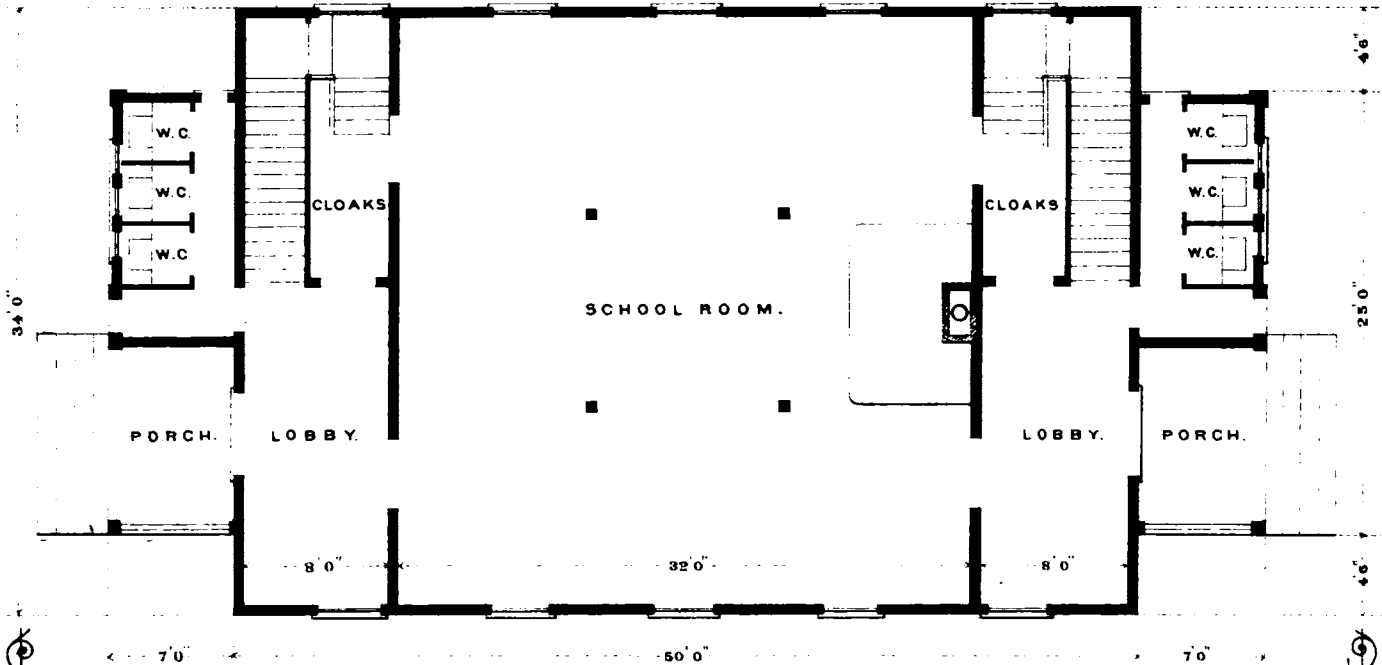



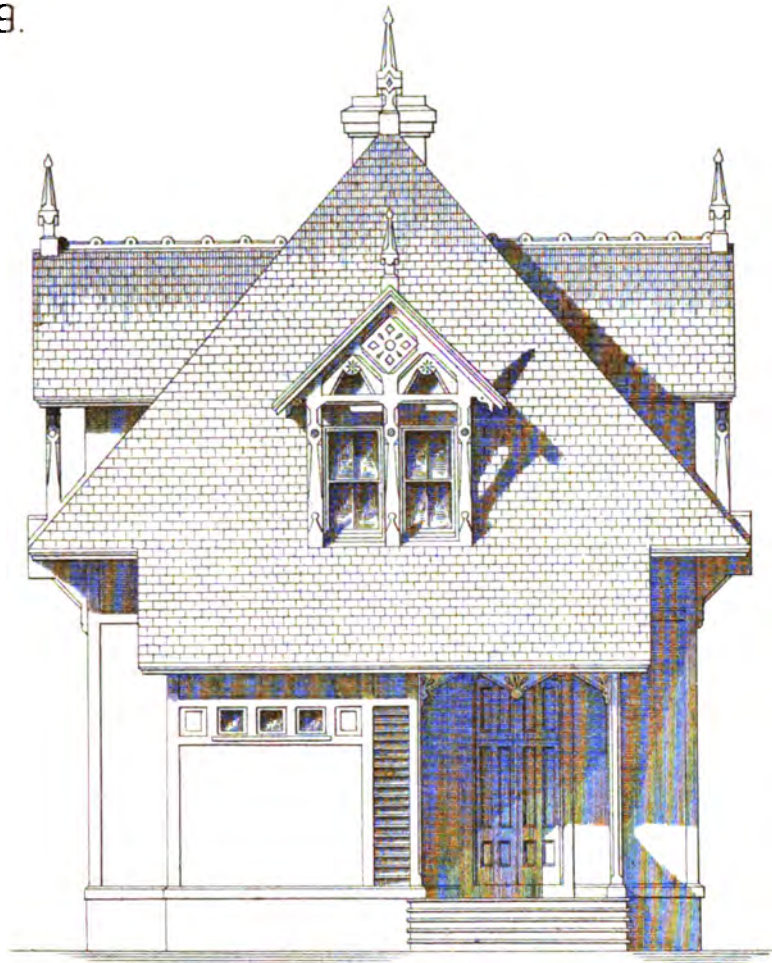

END ELEVATION AND SECOND FLOOR PLAN

3/32 inch to the foot

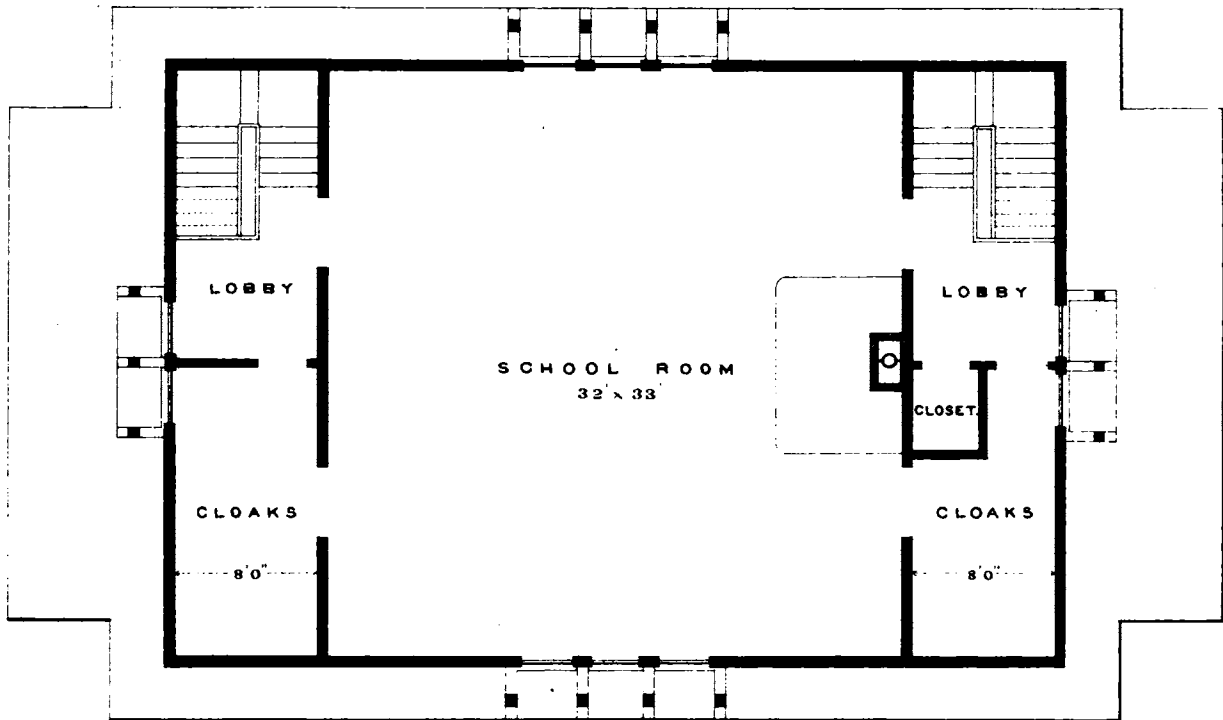



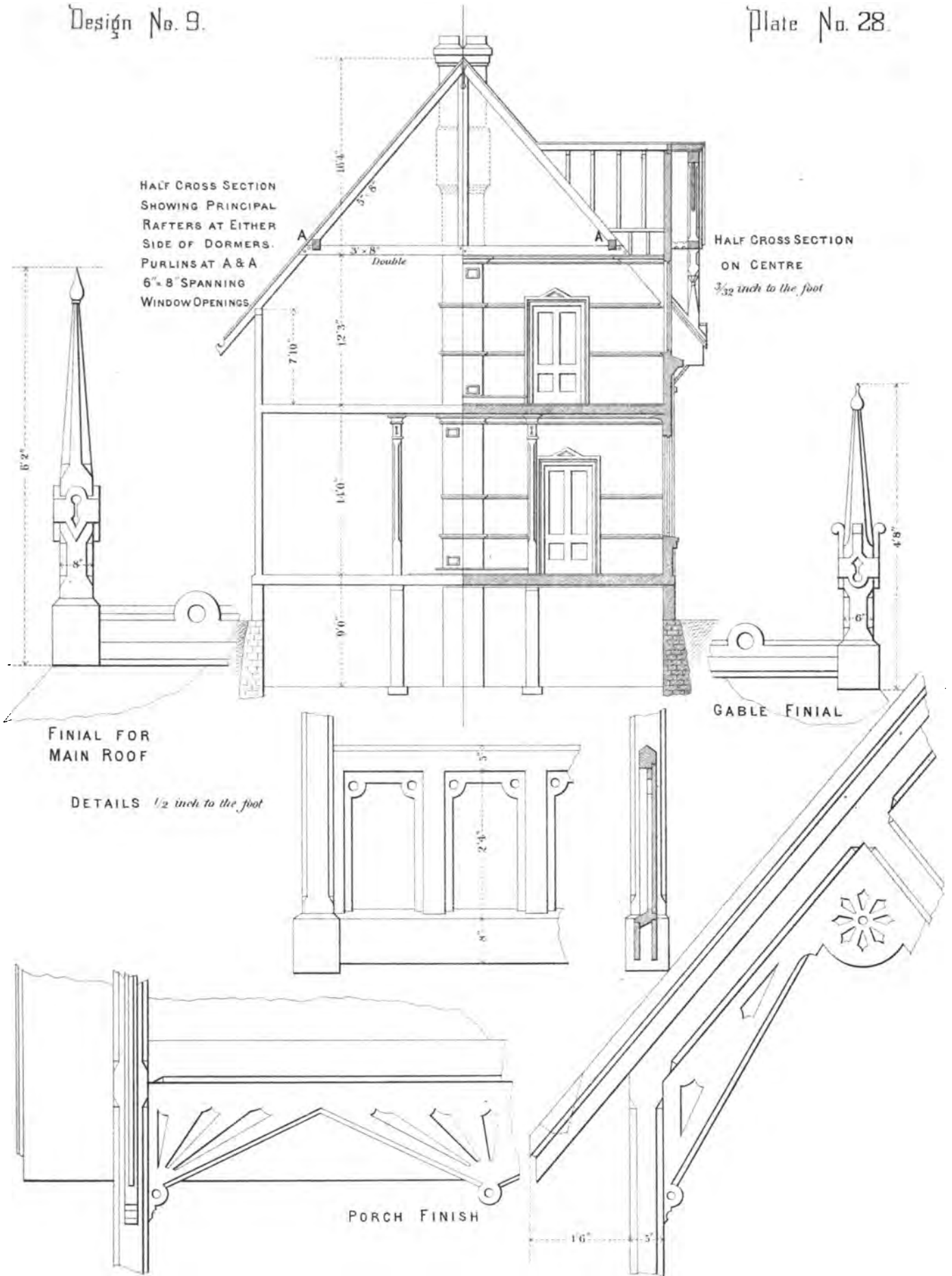



Design No. 9.

Plate No. 29

DORMER WINDOWS

HALF ELEVATION

DETAILS -

1/2 Inch to the foot

SECTION ON
LINE A.B.

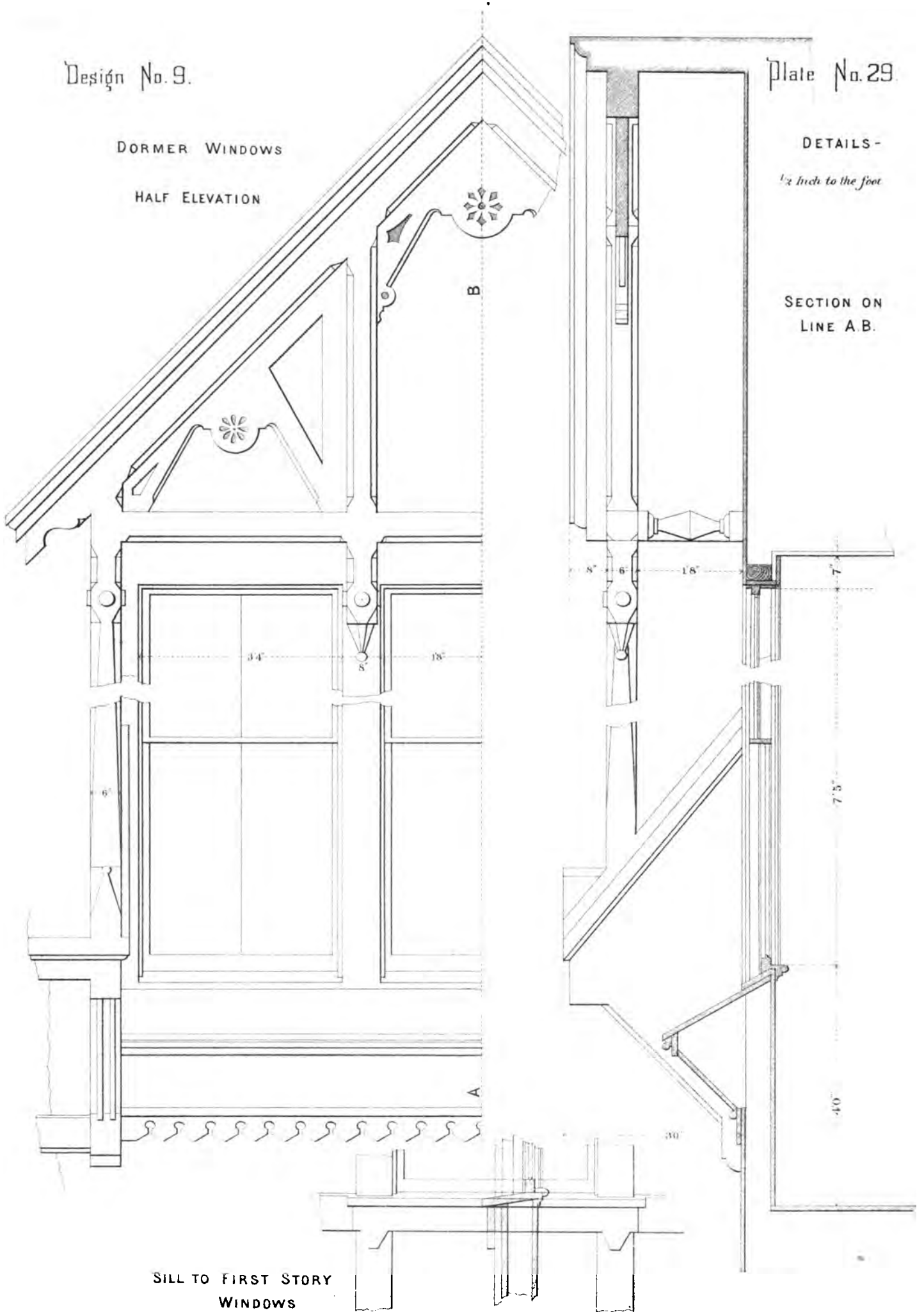



DESIGN NO. 10.

Plates Nos. 30, 31, 32 and 33.

DESIGN NO. 11.

Plates 34 and 35.

EACH of these designs embodies an arrangement of the interior which will very frequently be met with in some parts of the country. The design of the exterior finish, however, is put forth as a decided variation upon that usually found in connection with such plans.

Design No. 10 is only adapted to wood construction, but Design No. 11, though represented here as constructed of wood, might be built of brick, using the same wood gable finish shown in the plates.

Two sets of elevations are given for Design No. 10. The first (Plate No. 30) represents the sheathing of the first story as furred out the thickness of the corner boards in the story above, that in the second story being set upon the wall-studding.

The joints in the vertical sheathing in the gables should be chamfered, or rebated sufficiently to mark them.

In the exterior for Design No. 10, shown in the elevations on Plate No. 33, as well as in that for Design No. 11, the walls are finished with narrow-matched sheathing.

The school-rooms in both designs are large enough to accommodate 64 pupils each.

Each sex has a separate entrance and communication with the cellar, which last should be divided by a partition through the centre, in the direction of the length of the building.



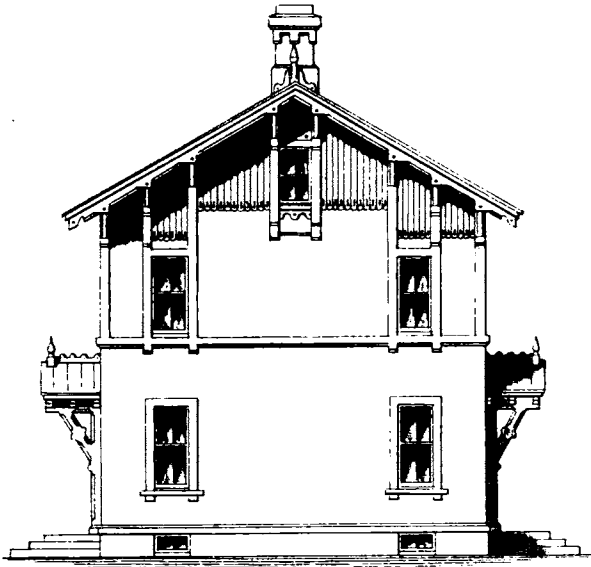

END ELEVATION

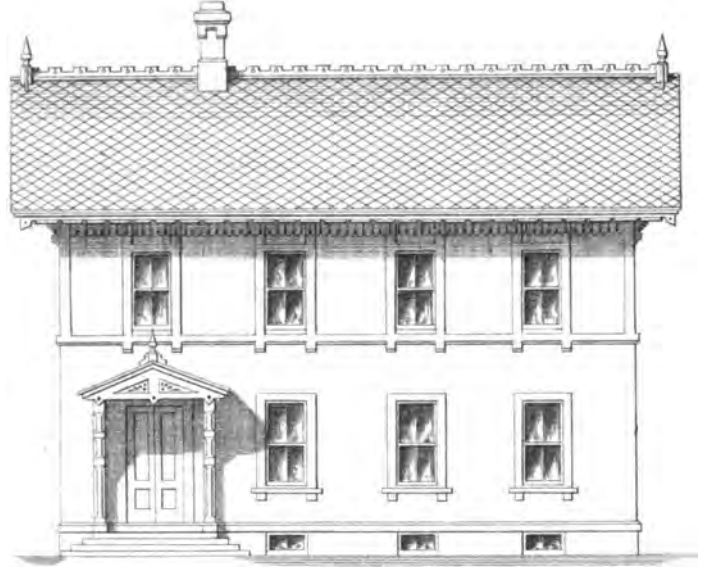

SIDE ELEVATION

1/16 inch to the foot

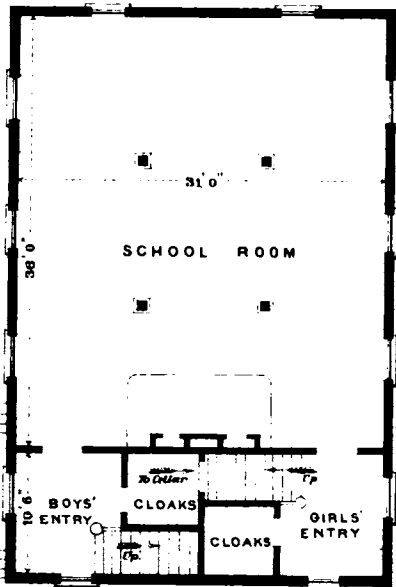

FIRST FLOOR PLAN

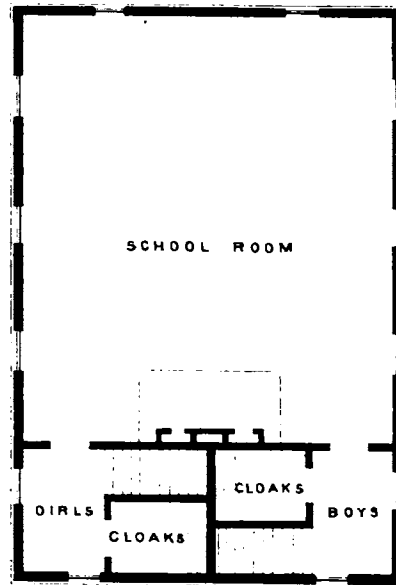

SECOND FLOOR PLAN



DETAILS
1/2 Inch to the foot

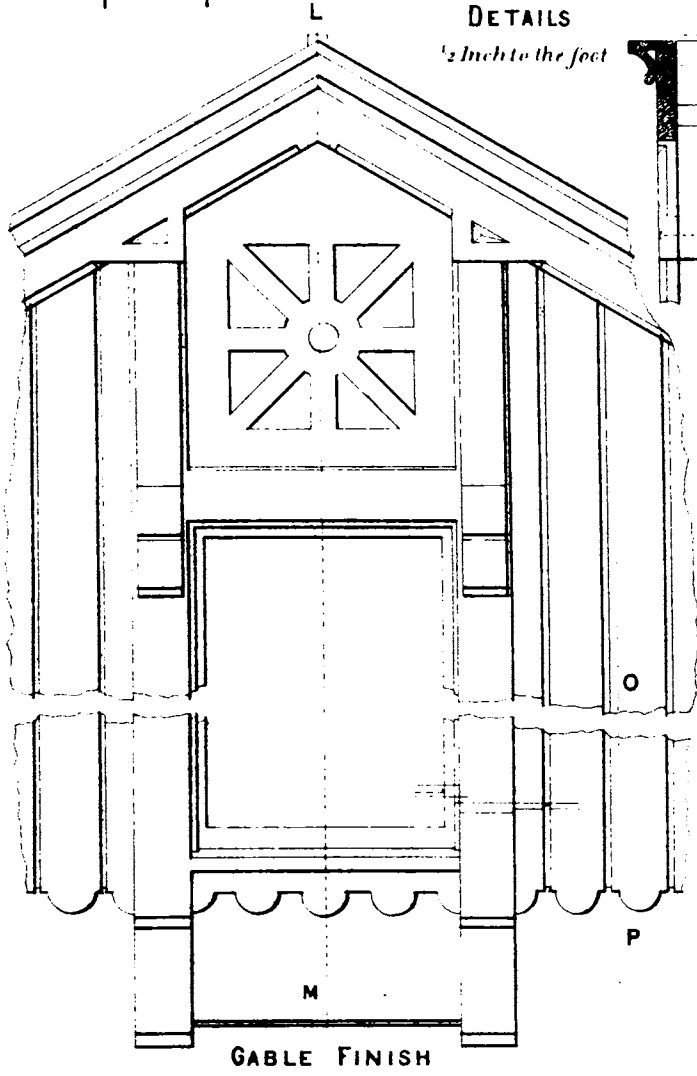

GABLE FINISH

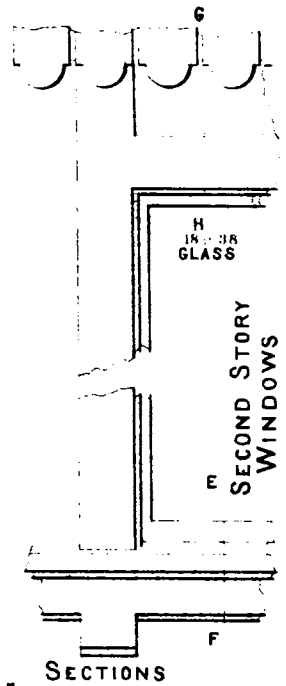
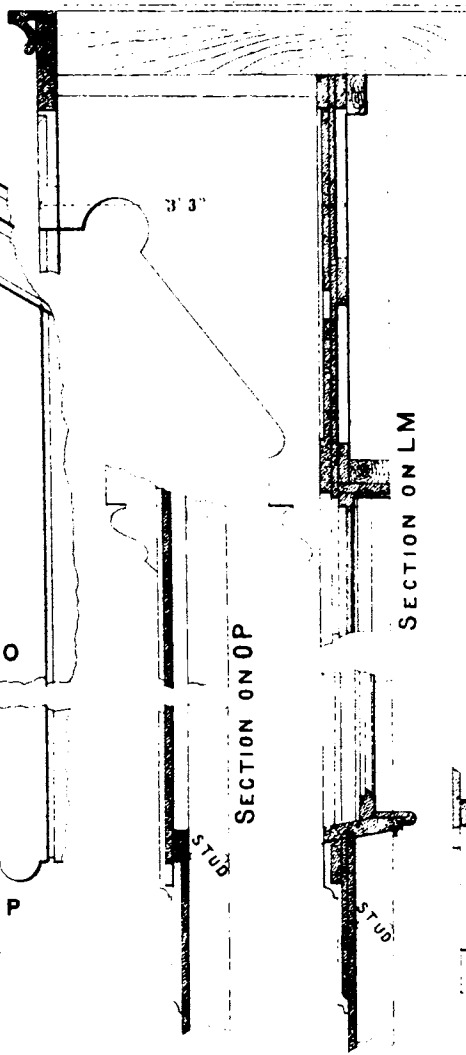

SECTIONS

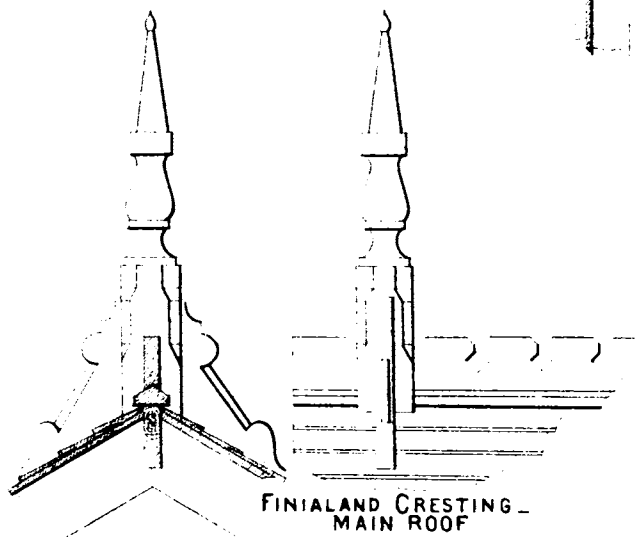
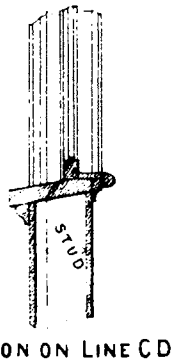
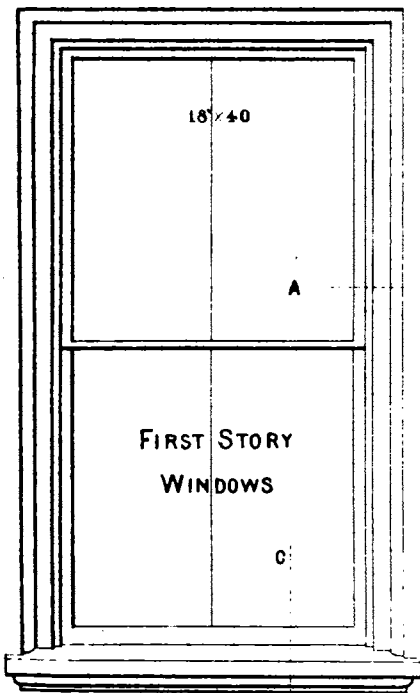
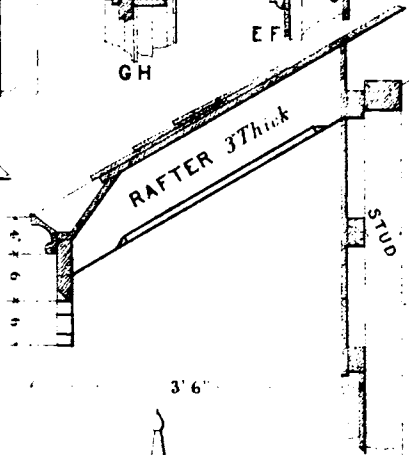
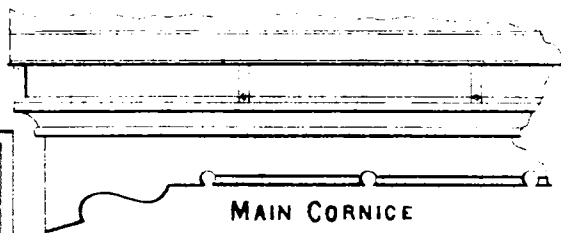
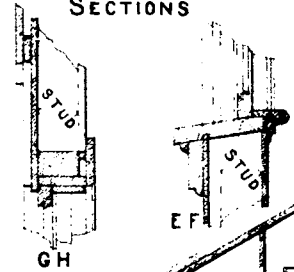



HOOD TO ENTRANCE DOORS.

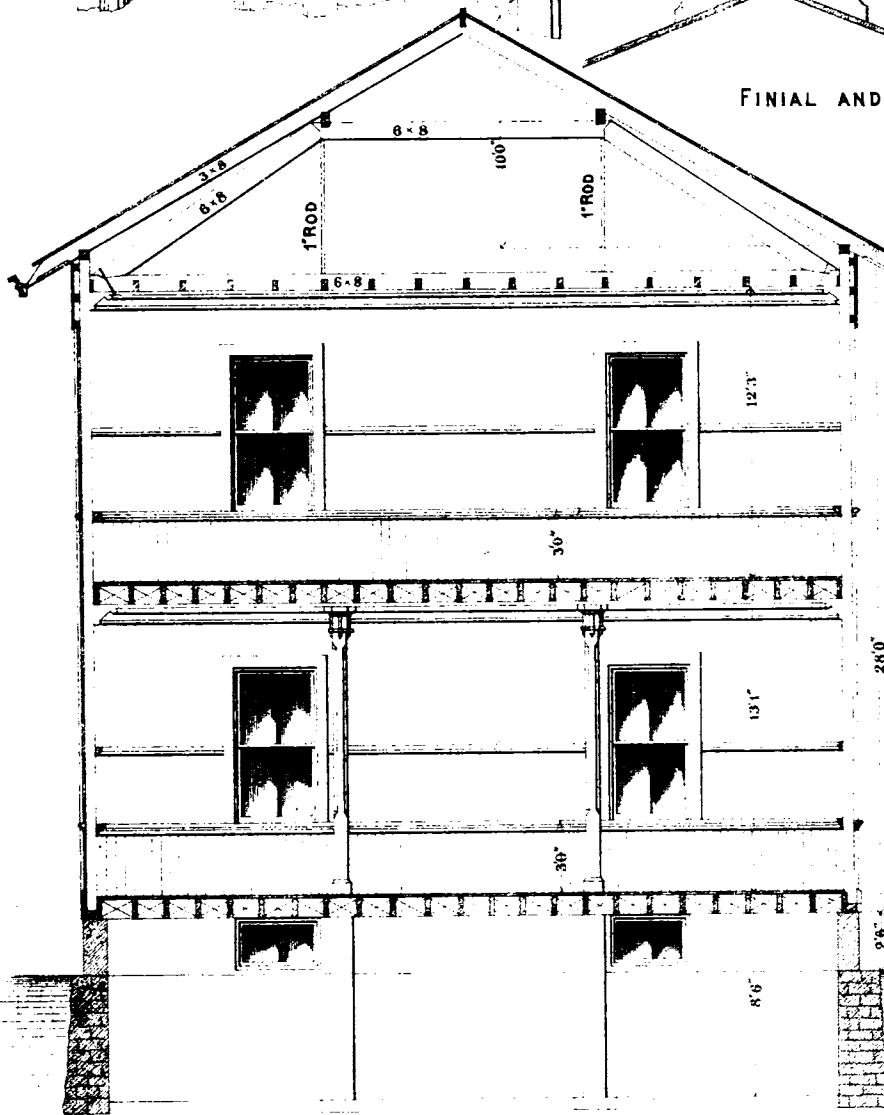
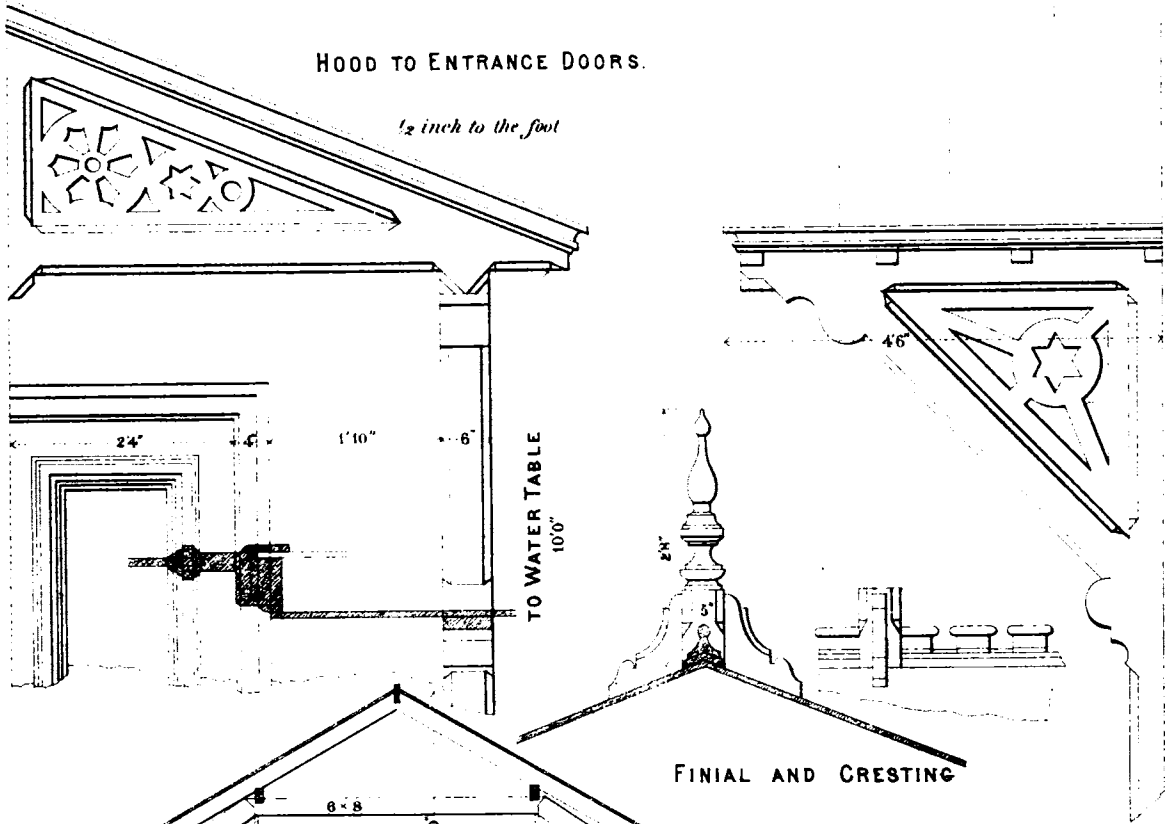

CROSS SECTION
1/8 inch to the foot

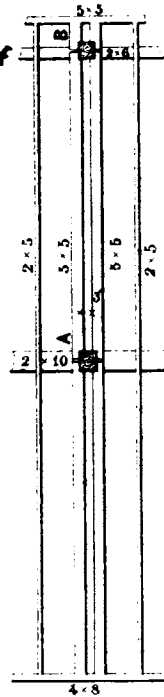

METHOD OF FRAMING GIRDERS TO POSTS.
GIRDER AT A 6" x 10", AT B 8" x 8", 3/4 INCH BOLT AT END OF EACH

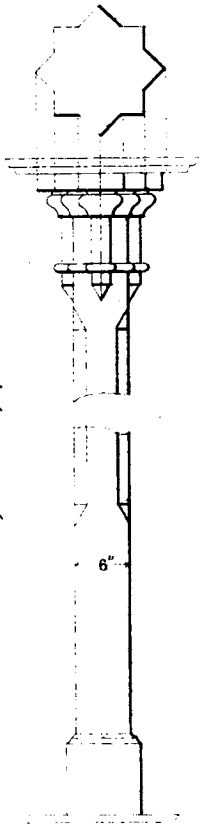

POST SUPPORTING
SECOND FLOOR



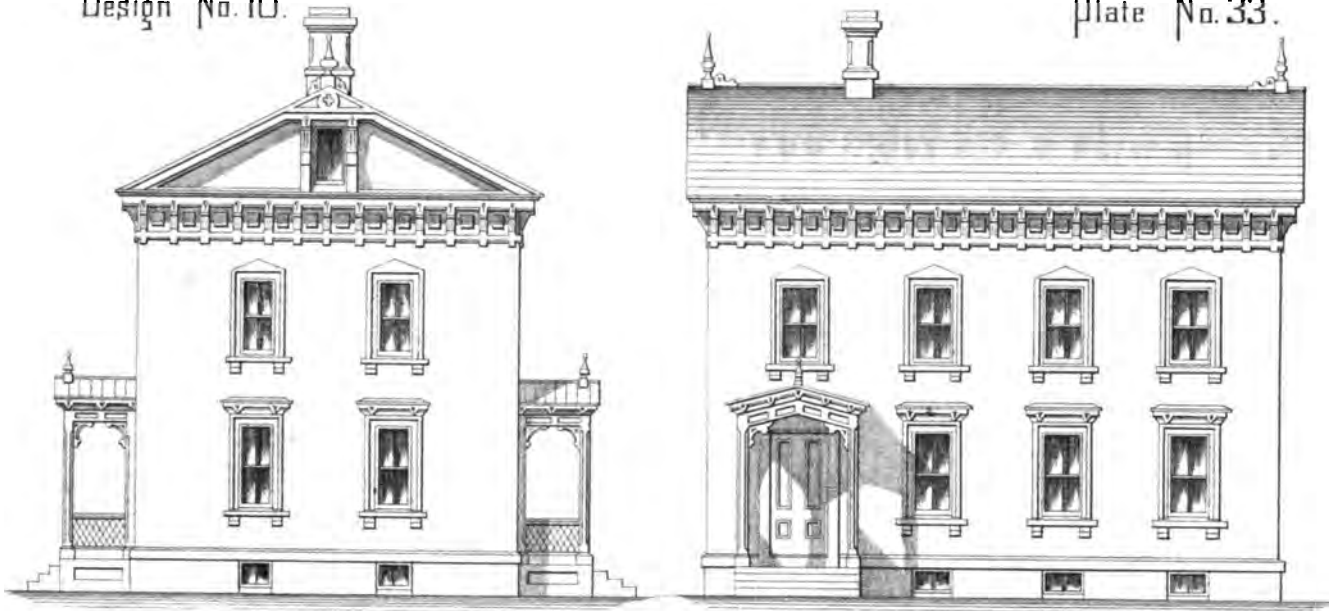

FRONT AND SIDE ELEVATIONS - N° 2 -
1/16 inch to the foot

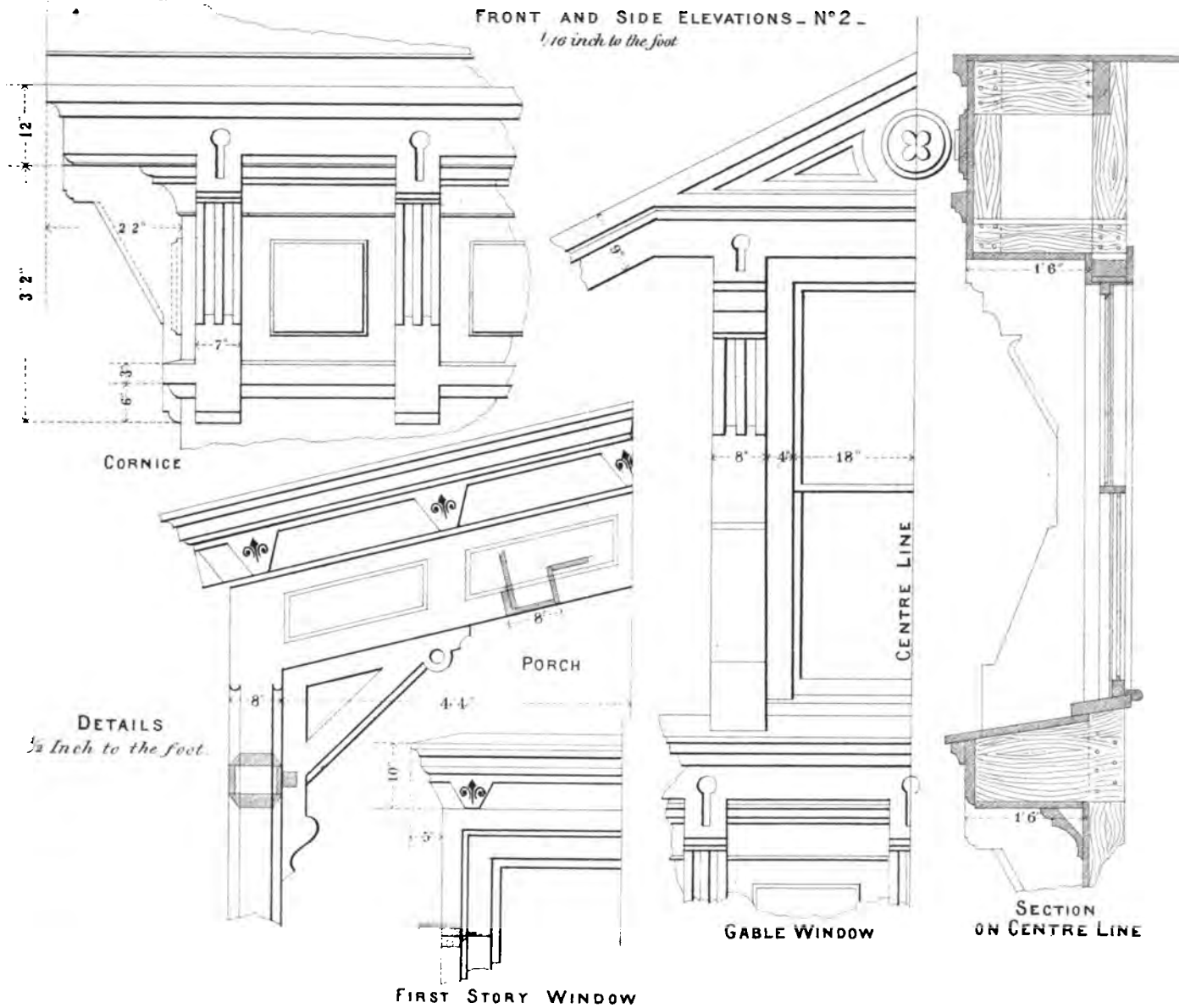

CORNICE

DETAILS

1/2 Inch to the foot.

PORCH

FIRST STORY WINDOW

GABLE WINDOW

CENTRE LINE

SECTION ON CENTRE LINE

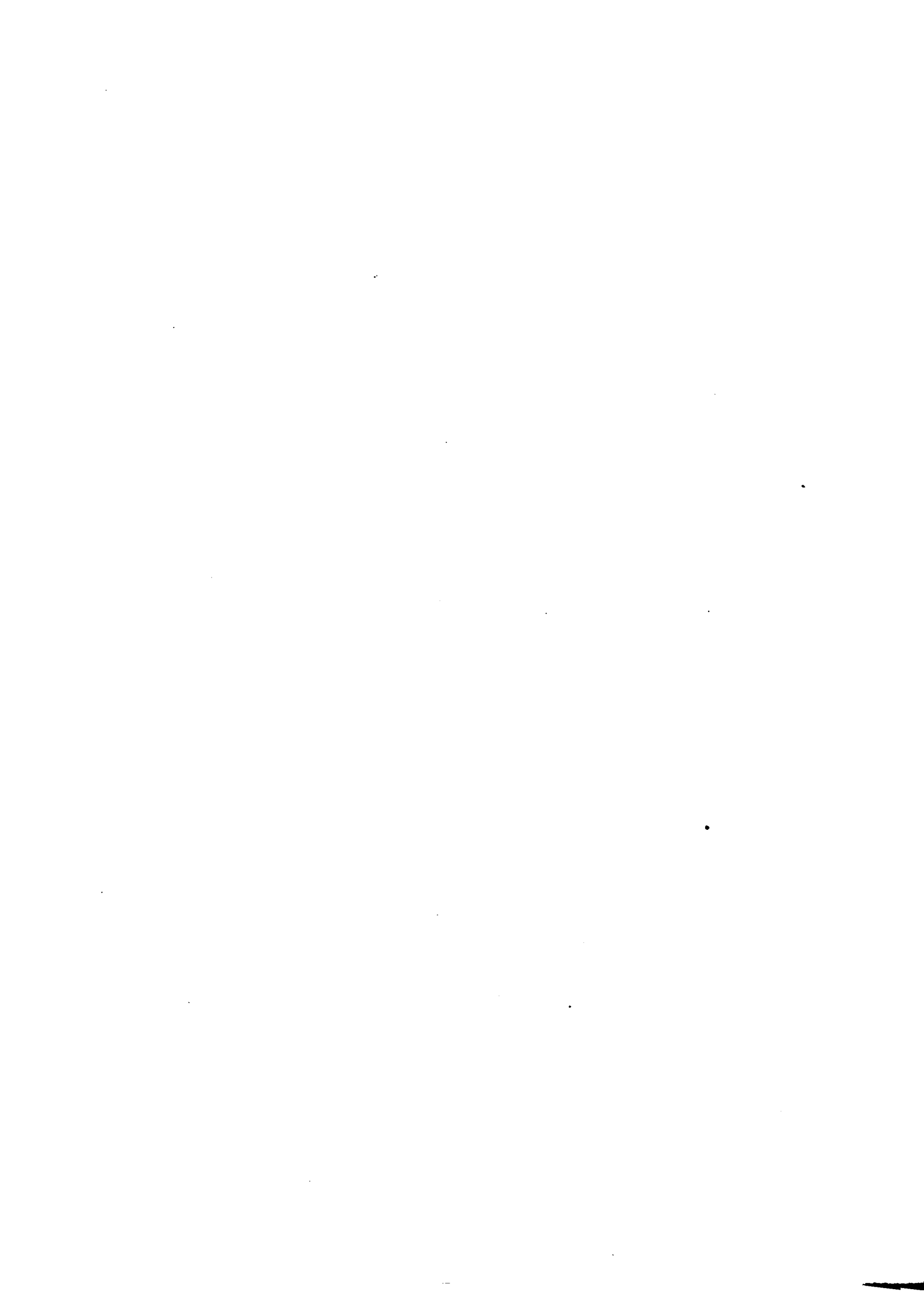

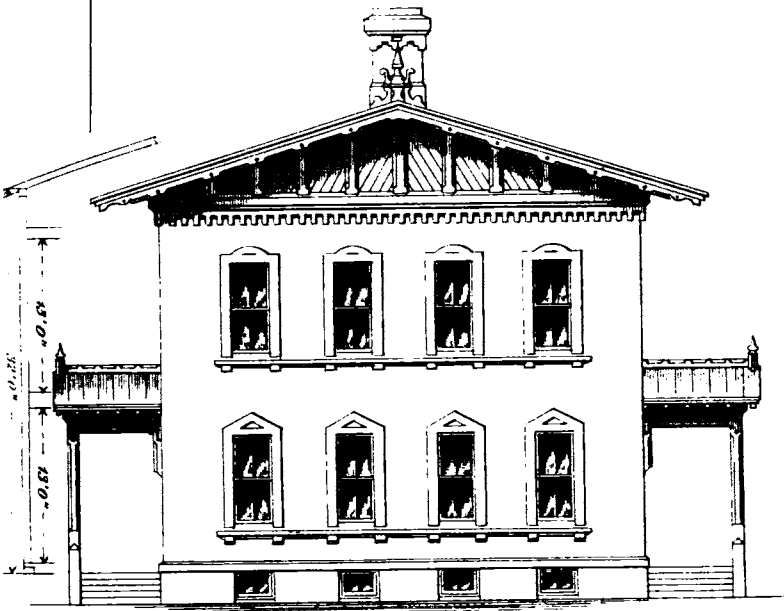

FRONT ELEVATION.

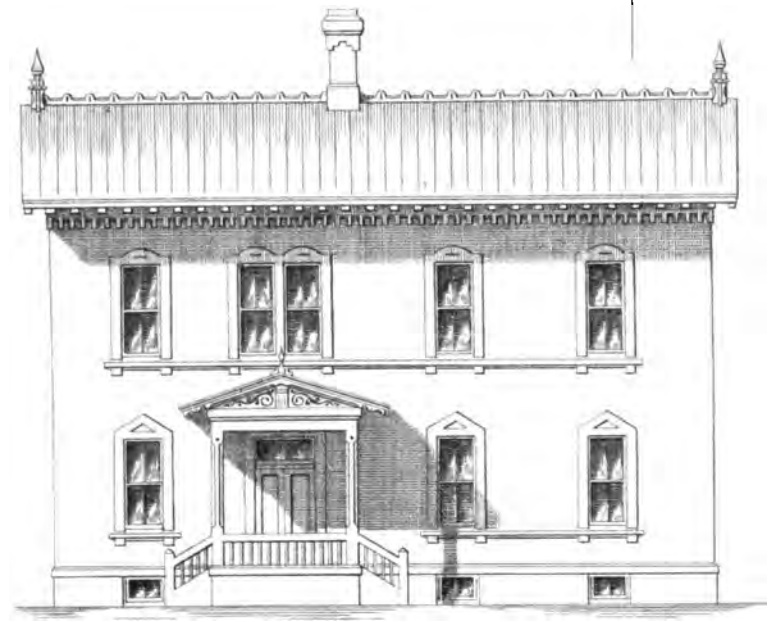

SIDE ELEVATION

1/16 inch to the foot

FIRST FLOOR PLAN

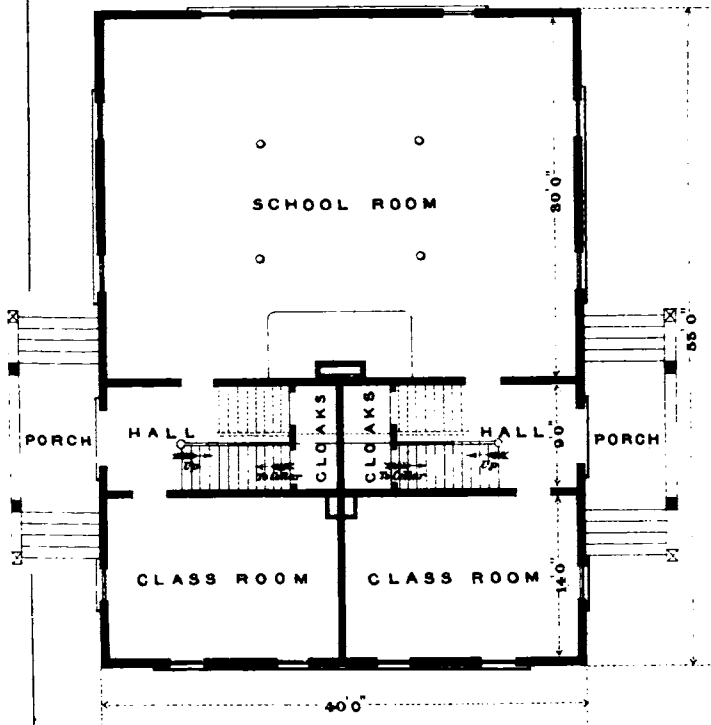

SECOND FLOOR PLAN

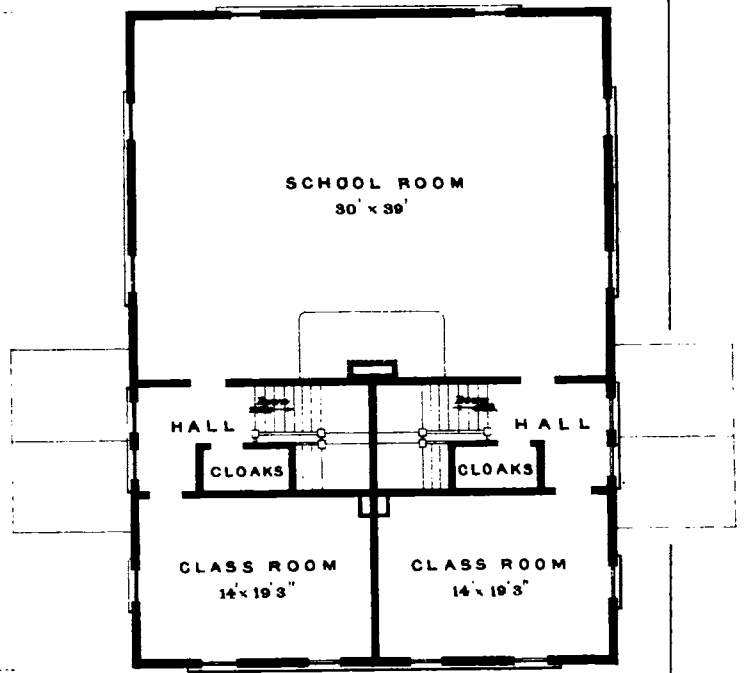



DETAILS

1/2 inch to the foot

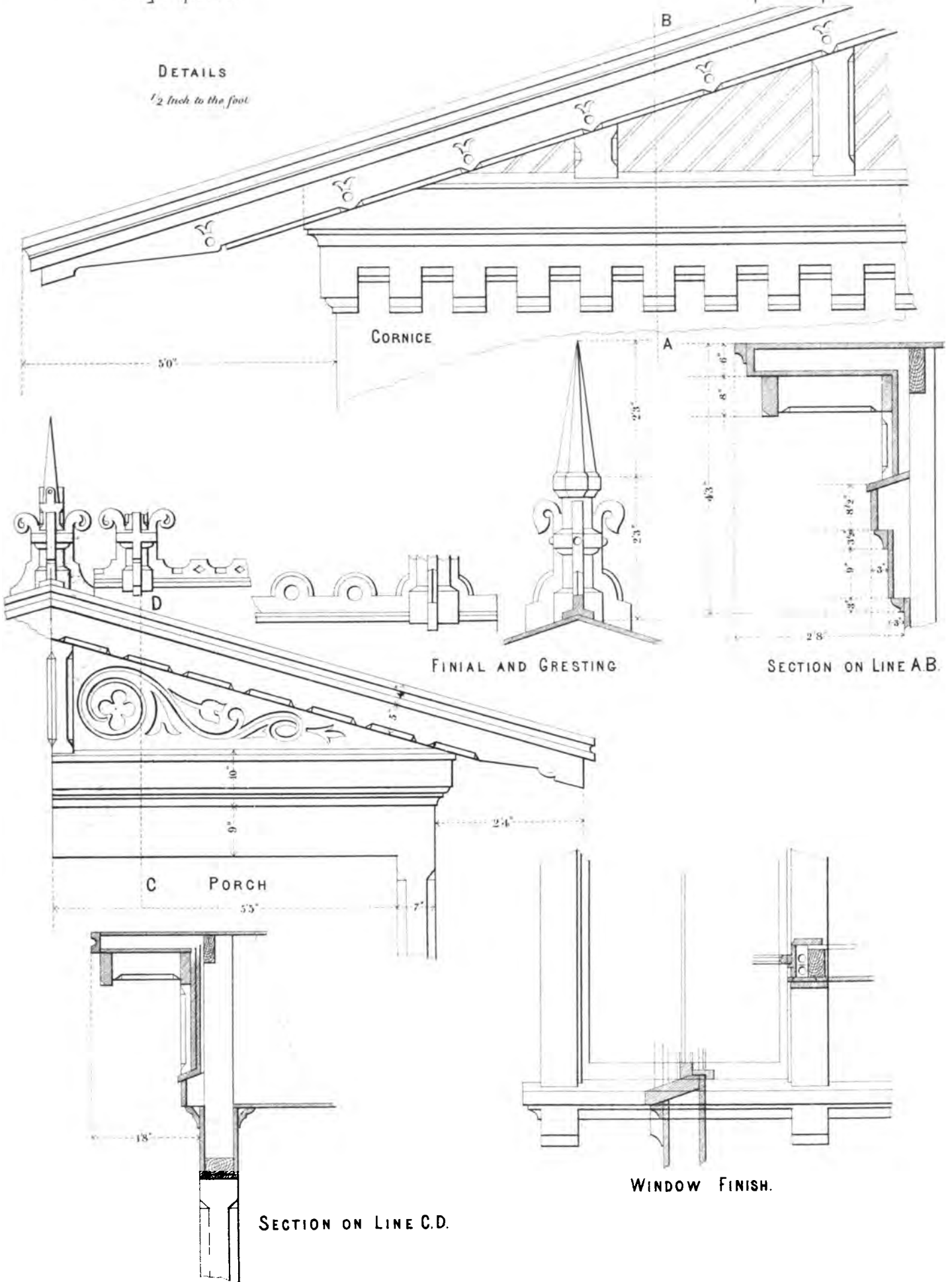

DESIGN NO. 12.

Plates Nos. 36, 37, 38, 39 and 40.

A town or village School-house, for four classes, of fifty-six pupils each, with large room in the third story, designed for those exercises in which two or more classes engage in common.

A great part of the specification for Design No. 13 will apply equally well to this design, and this consideration, in addition to the full detailed drawings given, seems to make a general description unnecessary.

It will be noticed, however, that the roof in this design differs essentially from all the others given in this book, in that this roof stands entirely upon the third floor beams, and is only connected with the plates through those beams. In carrying out this arrangement the girders in the third floor should run lengthwise the building, the beams carrying the partitions under the end upper plates being doubled, and the projecting pieces necessary to carry the end steep roof being secured to the double beams and to the end plates, and set at right angles to them. All the roofs are designed to be covered with slate.

The exterior should be painted with two shades of drab, the chamfers and similar parts of the finish being marked by using white paint.



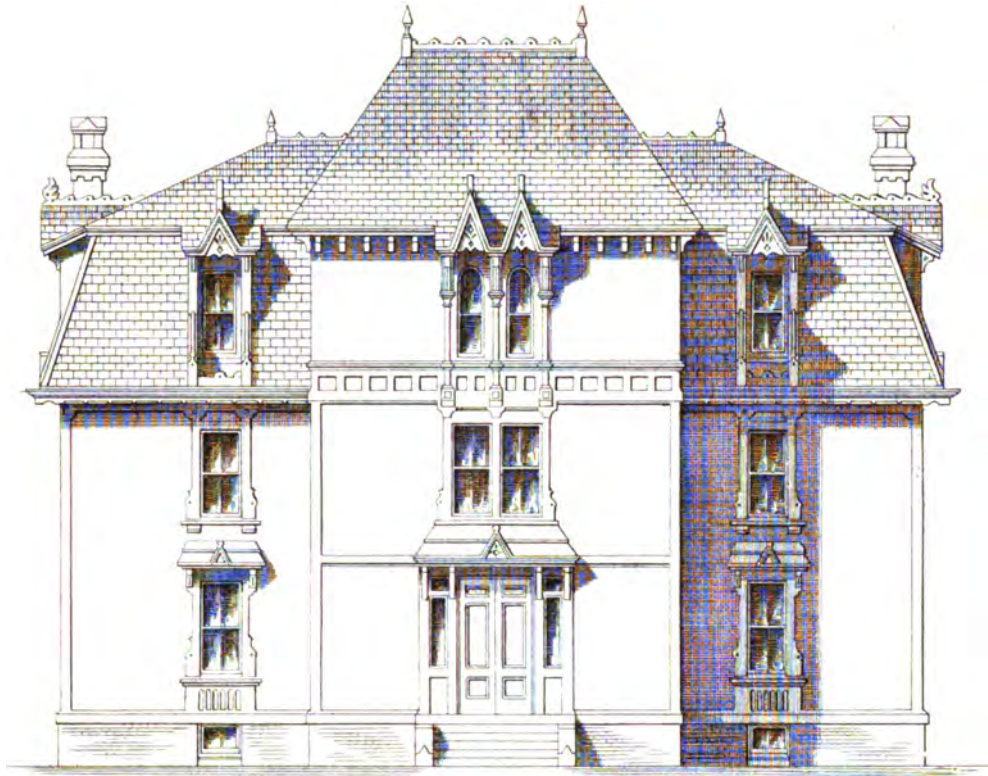

FRONT ELEVATION AND FIRST FLOOR PLAN

1/16 inch to the foot

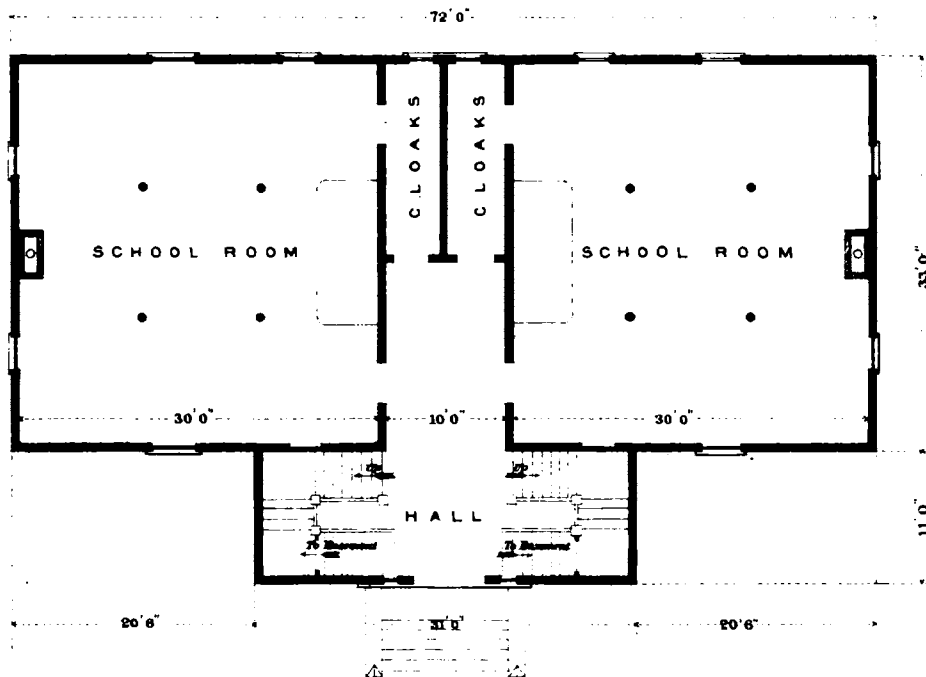

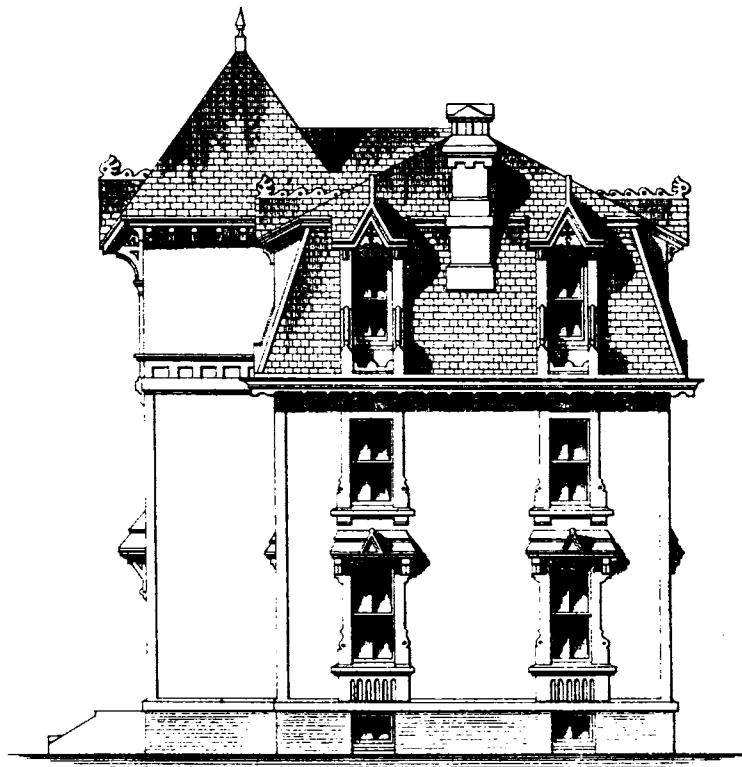

END ELEVATION AND SECOND FLOOR PLAN

1/16 inch to the foot

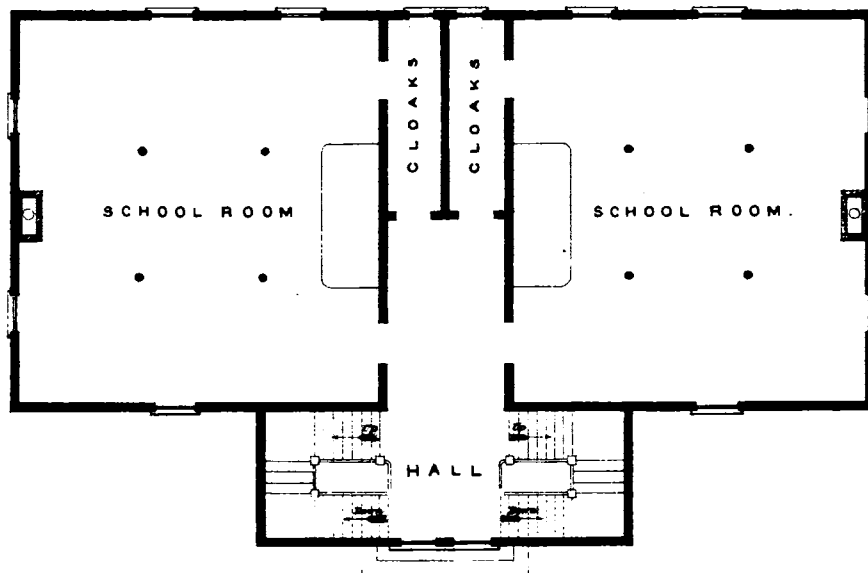

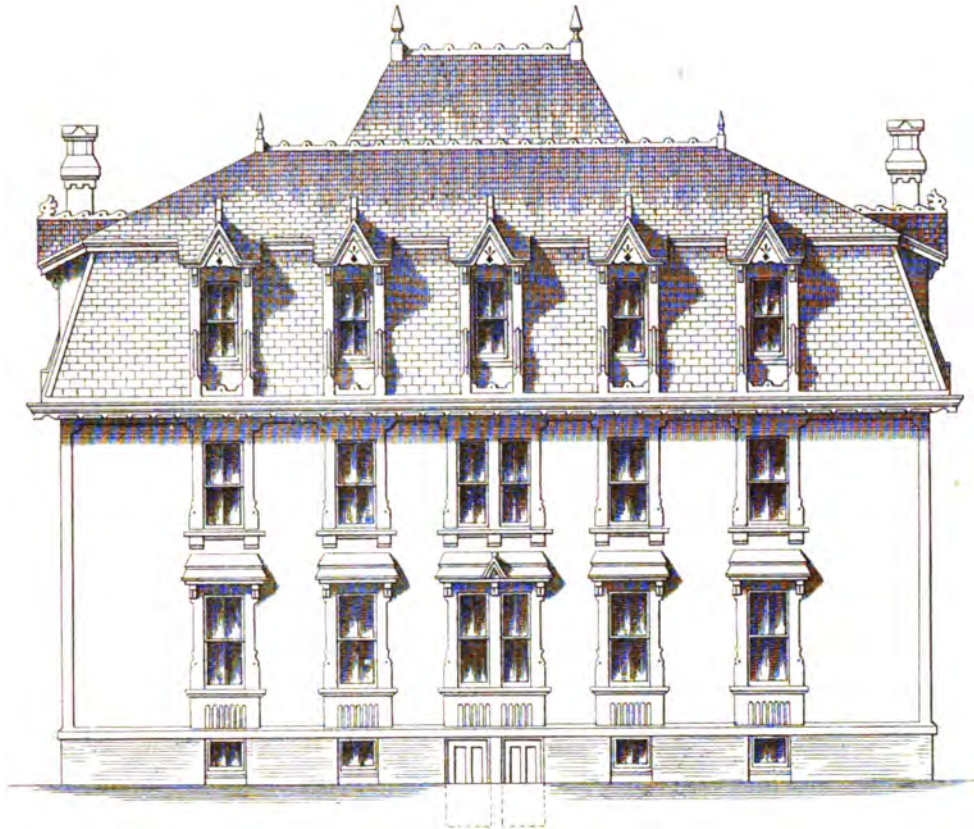

REAR ELEVATION AND THIRD FLOOR PLAN
1/16 inch to the foot

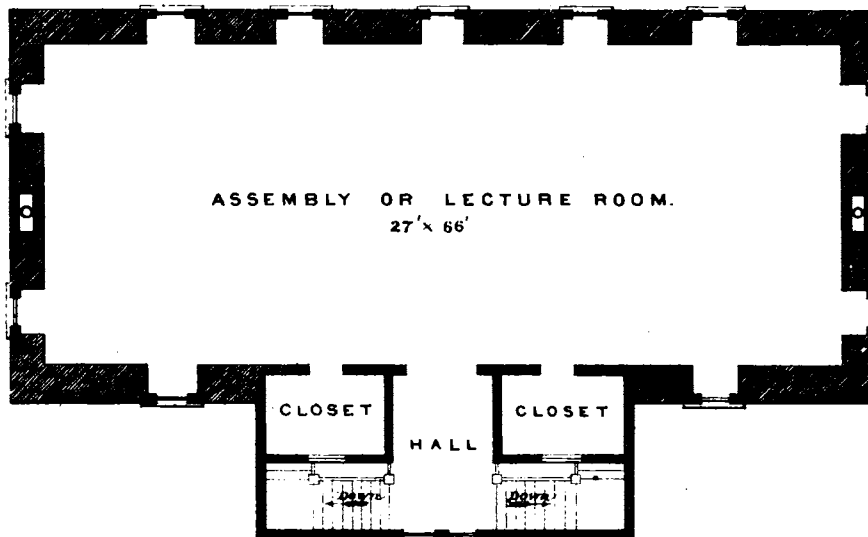



Design No. 12.

Plate No. 39.

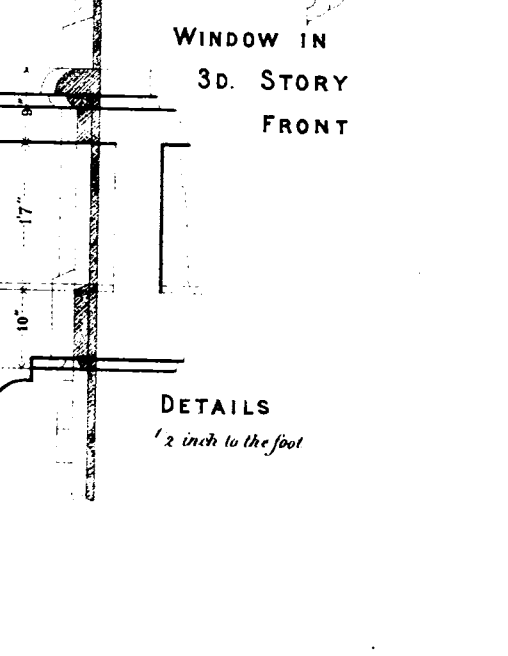
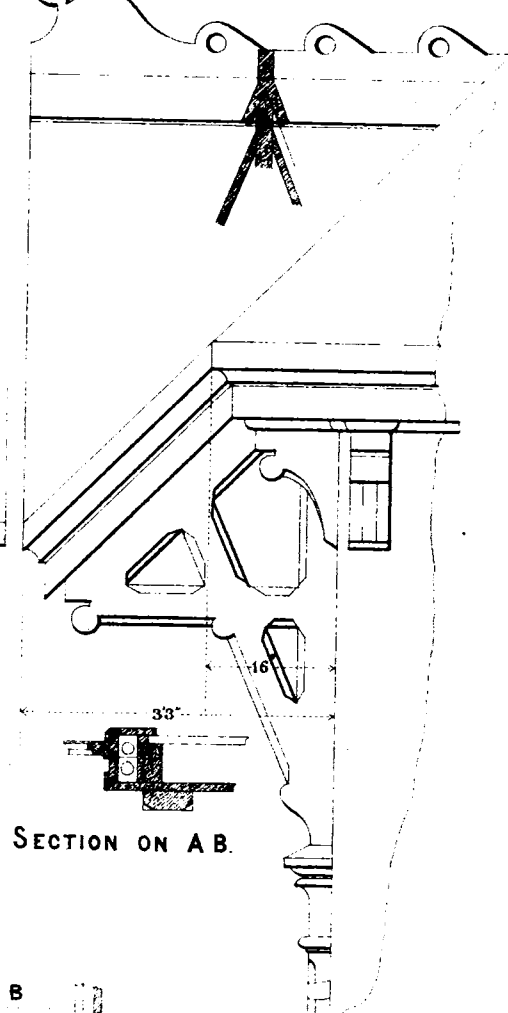
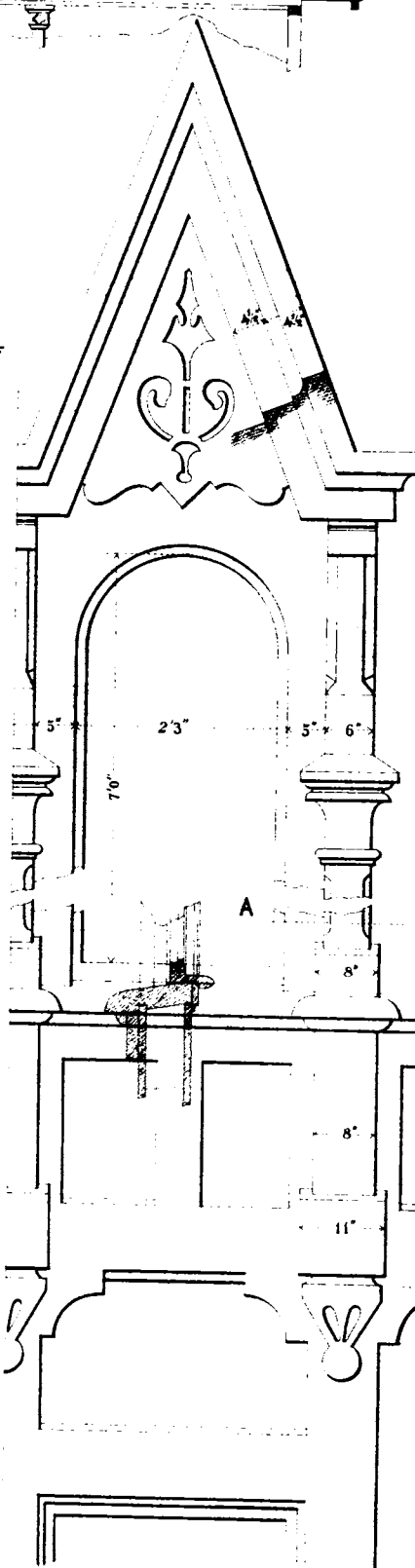
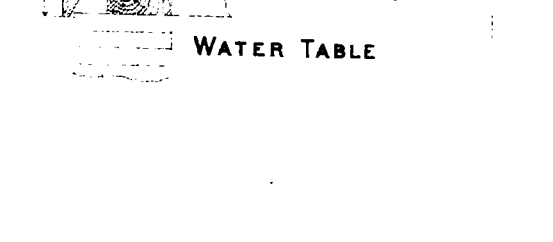
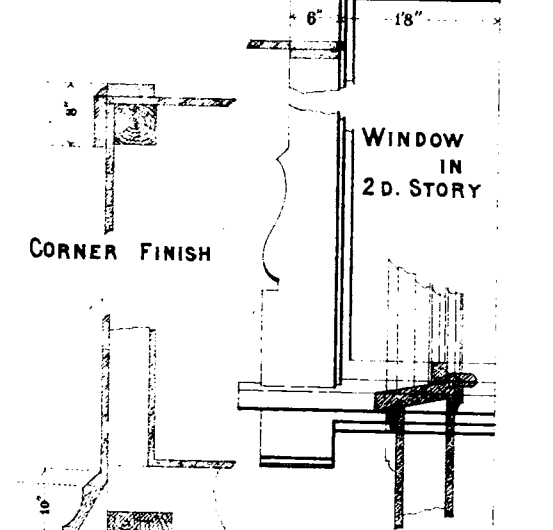
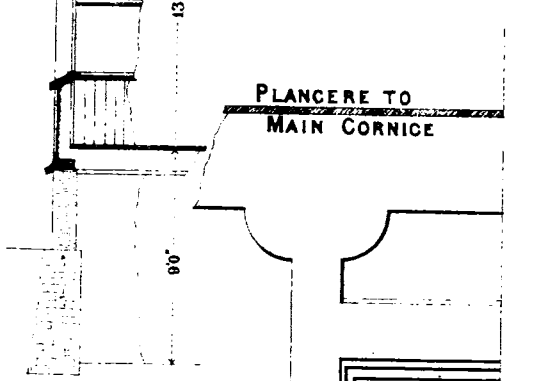
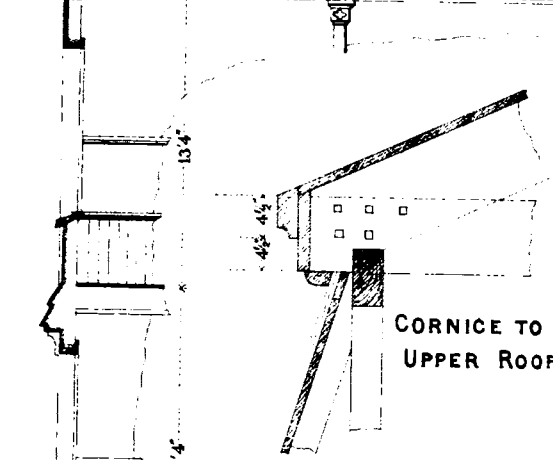
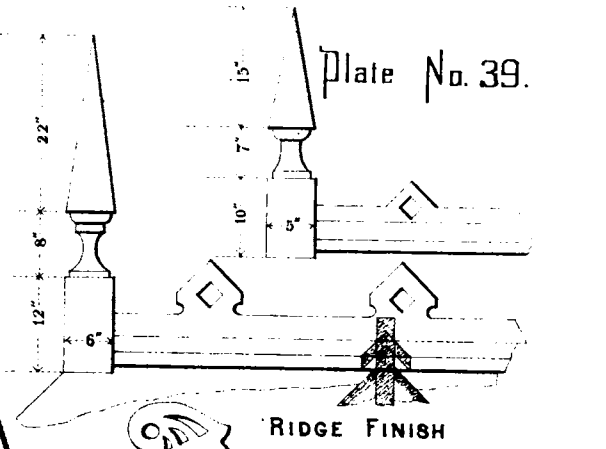
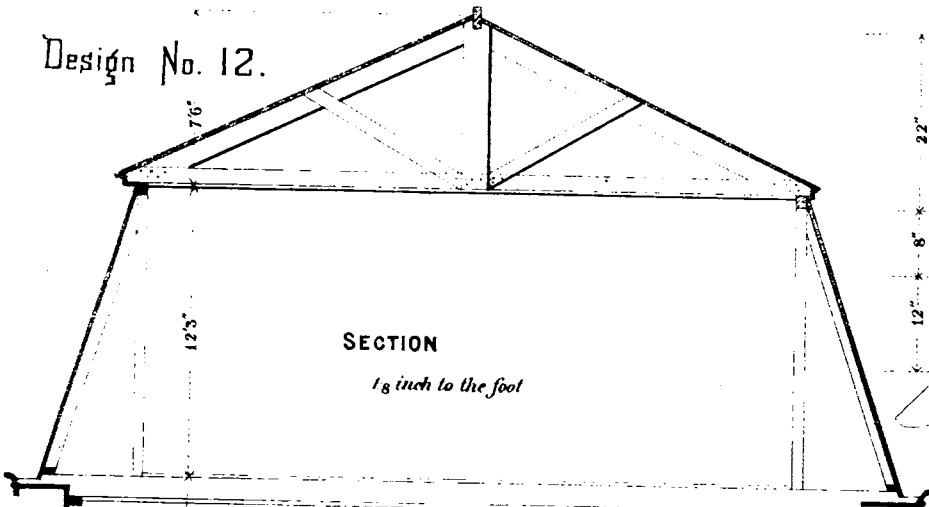



DETAILS 1/2 inch to the foot

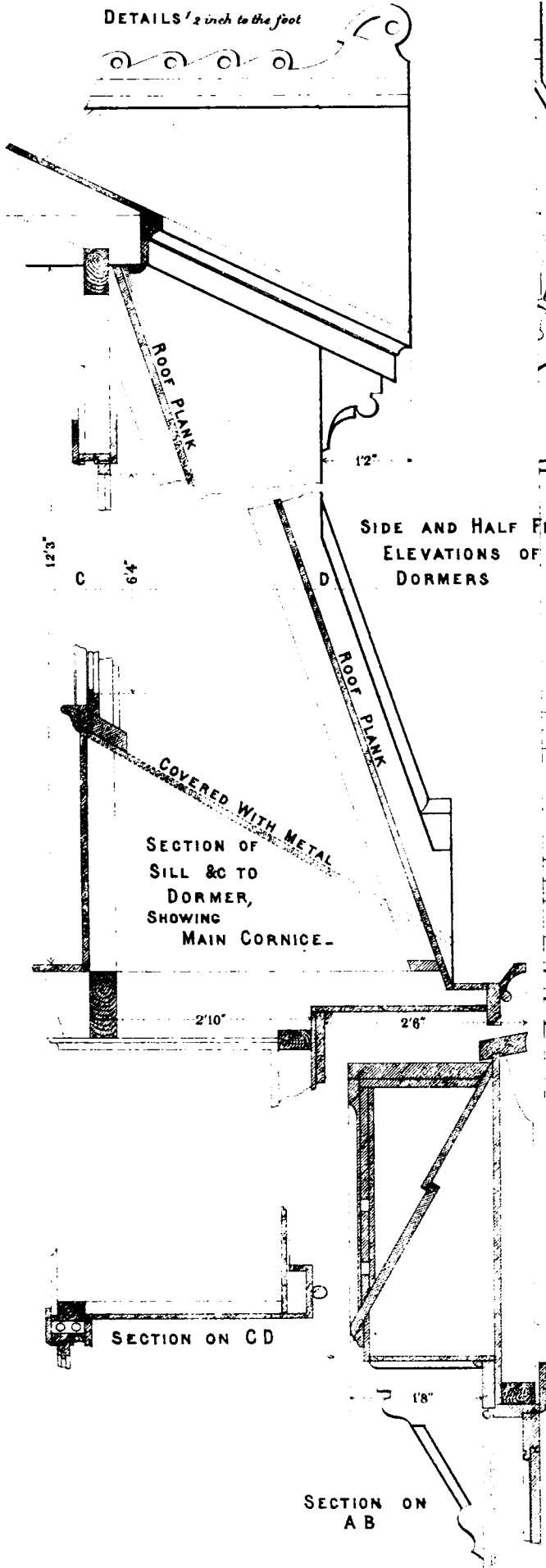

SIDE AND HALF FRONT ELEVATIONS OF DORMERS

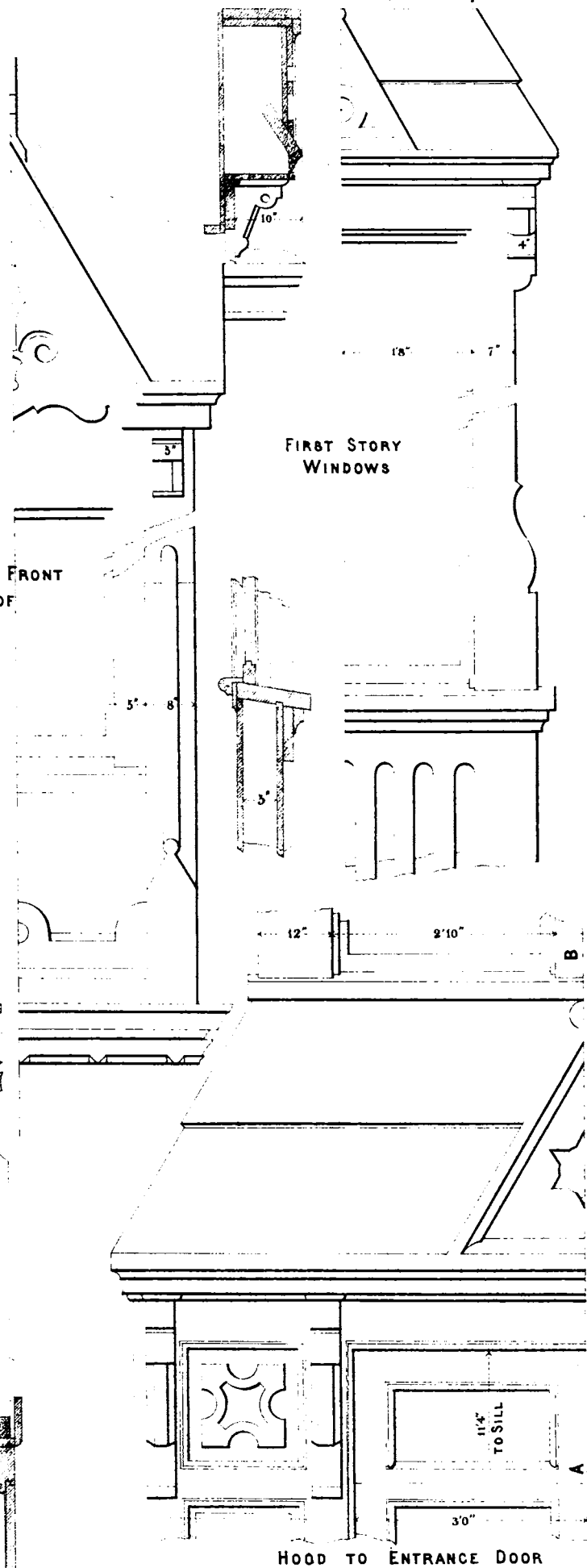



DESIGN NO. 13.

SPECIFICATION.

MASON'S WORK.

EXCAVATION. Excavate the ground to the depth required for the foundation walls, for the cellar and areas, and for all other works specified, and fill in around and above the same, after the works are set. Use all remaining earth for grading as directed. Excavate for the outside piers to the depth of $3\frac{1}{2}$ feet, and at least 3 feet deep for the drains, giving the latter a pitch of half an inch to the foot.

STONE WALLS. Build the cellar walls of large-sized angular stones, laid 2 feet thick in strong lime mortar, and point the wall full with lime mortar at the completion. Start these walls from a good firm foundation in the natural earth, carry them up to the grade of the thickness specified, and finish them with a good even surface upon the inside.

Build return walls at either side of the steps to the basement, to carry these steps.

Build stone foundations for the outside brick piers hereinafter called for, $3\frac{1}{2}$ feet high, finishing at the grade, and set large flat stone foundations (equivalent to 18 inches square), six inches thick, under each of the interior posts.

Carry up the jambs of the windows and doors in the basement true and plumb.

CUT-STONE. Provide dressed stone sills, 4 by 6 inches, for the basement windows, and flag stone curbs, 3 by 8 inches, for the walls enclosing the window areas.

Also, provide dressed stone steps to the basement, and curbs to the

walls enclosing them. The former to be 8 inches rise and 9 inches tread, and the latter to be 8 inches square.

CESSE-PPOOL AND DRAINS. Build a cess-pool 8 feet in diameter, with stone walls 6 feet high, laid dry, and starting from a level 12 feet below the finished grade. On these walls build a domed brick top, 8 inches thick, with man-hole 2 feet in diameter, enclosed by a wall of the same thickness, and covered, one foot below the grade, by a stone slab. The bricks in the dome, and surrounding the man-hole, to be laid in cement.

Set this cess-pool at least 50 feet away from the school-house, and connect with it the privy vault hereinafter described, by a 6-inch drain. Also, lay two 4-inch drains from the rain-water leaders on the rear of the building to the vault. The above drains to be laid with sound, well-burned earthen pipes, the interior diameter equalling that specified above, to be properly graded, trapped, and connected with the vault and cess-pool, and to be put together with cemented joints.

BRICK-WORK. Build the underpinning walls 3 feet high and 12 inches thick, the outer face being set 3 inches beyond the frame. Lay these walls with close and uniform joints, neatly pointed, and set the basement window frames (to be furnished by the carpenter) as by the plan.

Build a coal-slide, as shown on the drawing, with flag-stone bottom and cover, provided with the necessary iron fixtures.

PRIVY VAULT. Build the privy vault of the length given on the basement plan, and in the manner shown in Plate No. 10, finishing the interior with one good coat of cement.

PIERS. Build six brick piers, 8 by 8 inches, under the front part of the privy, and two piers of the same size to carry the porch floors.

AREAS. The walls enclosing the window areas, to be 8 inches thick. Provide and set gratings, made of $\frac{1}{4}$ by $\frac{3}{4}$ -inch iron bars placed 2 inches apart, over each of the window areas.

All the above specified brick-work is to be laid with mortar composed of the best cement mixed with equal quantities of screened sand.

- PARTITION WALLS.** The centre partition wall in the basement to be 12 inches thick, on 16-inch footing. Remaining walls in basement 8 inches thick, on 12-inch footings. Set door frames (furnished by the carpenter) as required by the plans.
- CHIMNEY.** Build the chimney as required by the plans and detailed drawings. Carry up two 8-inch piers, one at either side of the steps to the basement, and cover them 18 inches below the first floor with a stone slab 4 inches thick, to serve as a foundation for the chimney.
- Plaster all the flues evenly throughout on the inside, and finish above the roof as by the drawings, covering the ventilating flues with a 2-inch slab.
- Set funnel-irons in the basement story connecting with the central flue, and two ventilating registers in each school-room, one at the top and the other at the bottom of the room. (The registers to be furnished by the carpenter.)
- Let the top registers of the school-rooms at one end of the building, connect with one of the flues on the corresponding side of the chimney, and the bottom registers with the other flue. The ventilating registers to be of japanned iron of ornamental form, with centre-balance valves.
- FURNACE.** Provide the bricks and mortar required, and set a largest size hot air and hot water combination furnace, as located on the plan.
- MATERIALS FOR BRICK-WORK.** For all the above specified brick-work, use good hard-burned weather bricks, selecting the best of them for exposed work. Except where cement is required to be used, lay the brick-work with mortar composed of one-third fresh lime, and two-thirds clean, sharp sand.
- Level off the cellar-bottom, and finish it with cement grouting 3 inches thick. Finish the bottom of the window areas in the same manner, the finished surface to be 3 inches below the top of the window-sill.
- Give the interior of the basement two coats of lime wash.
- BRICK LINING FOR WALLS.** Line all the external walls with a course of pale bricks set edgewise, with courses set flatwise at intervals of every two feet in height. The inner face of this lining to be flush with the wall studding.

LATHING AND
PLASTERING

Lath all the ceilings, and the walls of the third story with sound laths, and break the heading joints at every sixth lath.

Plaster the ceiling of the basement with one good coat of brown mortar, floated and smoothed.

Plaster the remainder of the building with three coats, a brown coat, a "scratch" coat, and a finishing coat of lime and sand.

Run stucco cornices, 6 by 9 inches, in the school-rooms, and in the Assembly Room in the third story.

The walls on two sides of each of the school-rooms, and on one side of the Assembly Room, for a height of 3 feet above the level of the window-sills, are to be prepared for use as black-boards, by substituting for the third coat of plastering specified above, a coat formed of plaster of Paris or marble dust, mixed with lamp black, and trowelled down hard and smooth.

CARPENTER'S WORK.

FRAMING.

The several parts required in framing the walls are to be of the sizes given in Plate 32, the posts carrying the girders are to be doubled, the girders being set between them, and halved and bolted to them, as there shown.

Girders in the several floors, 6 by 10 inches, flooring beams 2 by 10 inches, framed to the girders with tusk and tenon.

All the flooring beams to be set 16 inches on centres, and bridged, and these carrying partitions to be doubled.

Studs in vertical partition, under the upper plate, 2 by 5 inches, upper plate, 5 by 8 inches.

Rafters in upper roof, 2 by 9 inches, and ceiling beams of the same size, framed with doubled suspension and truss braces, 1 by 9 inches, as in Plate 39, the whole well nailed together. The rafters in the curved roof to be of 2 inch plank, sawed to the arcs given on the drawings.

The two outer posts in the stairs are to be carried up the entire

height, and with two posts of the same size starting from a girder in the third floor, are to carry the belfry, and to be braced at the top as shown.

Set 6 inch turned chestnut posts, with caps and bases, to carry the several floors.

Sills for porch floors, 4 by 8 inches, and joists, 2 by 8 inches, plates 4 by 6 inches, and rafters, 2 by 6 inches.

All the timber required in framing is to be perfectly sound spruce, and all the framing is to be executed in the most skillful and substantial manner.

Furnish and put in all the iron bolts and nuts required in the execution of the framing.

EXTERIOR FINISH. Finish all the external walls as high up as the centre of the first story windows, with tongued and grooved $\frac{7}{8}$ inch sheathing, rebated at the joint, as by the detailed drawings, furred out from the studding $1\frac{1}{4}$ inches, and set in widths of not less than 9, nor more than 10 inches. Terminate this sheathing with projecting cap as by the drawing. Above this cap cover the walls with tongued and grooved $\frac{7}{8}$ inch sheathing, set in widths not exceeding 6 inches, upon the studding. The rusticated corners of the corner boards, the window casings in the second story, and the frieze, to project $1\frac{1}{4}$ inches beyond the sheathing last named, and the corner boards and frieze to finish with sunk panels.

Finish the water-table, belts, cornices, porches, dormers, and belfry, as by the drawings. Sheath up the ceiling of the porches and belfry, level with the planceer of the cornice of each of them, with narrow matched and beaded sheathing.

Floor of porches of $1\frac{1}{2}$ inch clear plank, tongued and grooved, set in widths of 4 inches, the joints coated with white lead paint. Treads of the steps of the same material, each tread in one piece. Risers $\frac{7}{8}$ inch thick.

PRIVIES.

The posts in the lattice work before the privies, and in the partition separating the passage way to them, to be of chestnut, 6 by 6 inches, set 3 feet in the ground.

The partition to be of planed and matched $1\frac{1}{4}$ inch stuff, nailed to rails of proper size, and carried up to the roof.

The latticed work to be formed of 1 by 2 inch pieces, also nailed to rails cut into the posts.

Sills to privies 3 by 6 inches. Floor joists 2 by 6 inches.

Walls formed of narrow matched sheathing, set vertically.

Floor of 1½ inch flooring, planed, tongued, and grooved.

Partitions as by the plan. Set cleated door to each division, with thumb-latch and box-lock, and put in each division a small window hung with butt hinges, and fastened open and shut with hasps.

Finish with risers, seats, and hinged flaps.

Roof as required for the upper roof of the school-house.

Paint all the wood work of the privies with three coats, of the shades required for the school-house, and shower fine sand in the last two coats.

ROOFS.

Cover all the roofs, including the bell deck, with planed, tongued, and grooved sound roofing boards. Set a scuttle 2 by 3 feet in the bell deck.

TIN WORK.

Finish all the roofs with tin, put on with standing joints. Line the gutters in the main cornice, and in the porch cornices with the same.

Put up four 4 inch rain water leaders, connecting two of them with the drains to the privy vault.

Put in the hot air pipes to the several school-rooms immediately over the furnace.

Use the best charcoal roofing tin for all the tin work, and paint that upon the outside three coats of best lead or zinc paint.

Furnish all the ventilating registers required to be set in the chimneys; also furnish and set all registers necessary for the hot air pipes.

FLOORS.

Lay all the floors with sound, thoroughly seasoned 1½ inch flooring, planed, tongued, and grooved, set in widths of 4 inches, blind nailed, and smoothed off after laying with a hand plane.

Build a teacher's platform to each school-room, to be 5 by 12 feet, raised 7½ inches above the floor. Use the same material that is required above for the flooring, and finish with a moulded edge.

Thresholds throughout of hard wood.

- STAIRS.** Build platform stairs from the basement to the third story, as required by the drawings. To be 5 feet in width, clear of the rail, above the basement. Details as given in plate 67, so far as strings, risers, and treads are concerned. Sheath up on the string with matched and beaded sheathing surmounted by rail similar to that shown in plate 67. Set a step ladder to communicate with the scuttle in the bell deck.
- PARTITIONS.** Set the partitions with 2 by 4 inch spruce studding placed 16 inches on centres, and bridged with one row of herring bone bridging. Double stud the door and other openings.
- Partitions separating the school-rooms, as shown in detail on Plate 50. Studs and partition caps 3 by 8 inches, the latter trussed over the door openings.
- Finish the window recesses in the third story with splayed jambs, as by the drawings.
- FURRING.** Cross-fur all the ceilings with sound 1 by 3 inch strips, set 16 inches on centres. Fur down the ceilings of the cloak-rooms to the height of 10 feet.
- WINDOWS.** Frames for basement windows of 2 inch plank.
- Sashes set into a rebate, hung with butt hinges, and fitted with wrought iron fastenings.
- Window frames above the cellar of the usual form for weighted sashes with hard wood pulley stiles.
- Sashes throughout 1½ inches thick, one to each window in the basement, and two to each window above the basement, the latter with lipped meeting rails.
- Glaze all the sashes with the best English or French sheet glass, 12 panes to the window.
- Hang all the sashes not otherwise provided for, with iron weights, 2 inch noiseless axle pulleys, and best Russian hemp sash cord, and fit them with most approved spring centre locks.
- BLINDS.** Provide and hang inside blinds to each of the windows in the school-rooms, and the assembly room.

To be of best chestnut, $1\frac{1}{8}$ inches thick, 8 panels to the window, with rolling shades.

DOORS.

Basement door frames of $2\frac{1}{2}$ inch plank, rebated for the door, and properly ironed to the brick and stone work. The doors in the partitions separating the school-rooms to be arranged as shown in Plate 50, and to be hung with iron weights, 3 inch pulleys or sheaves, and raw hide sash cord.

Principal entrance doors, 6 by 8 feet, with head light over them. To be 2 inches thick, each door in two parts, finished with raised mouldings.

Doors in the basement $3\frac{1}{2}$ by 7 feet. School room doors 4 by 8 feet, and doors to cloak room, $3\frac{1}{2}$ by 8 feet. All the doors, except as above, to be $1\frac{1}{2}$ inches thick, 4 panels each, with beveled stiles and rails. Hang all the doors not otherwise provided for, with loose-jointed $4\frac{1}{2}$ by $4\frac{1}{2}$ inch, iron butts, 3 to each door, and fit them with mortise locks and latches of the most approved manufacture, and with glass or metallic handles. Set two wrought iron flush bolts in one-half of each of the entrance doors. Above each of the doors in the first and second stories, set a blind, with rolling shades, to be 20 inches high, and of the same width as the door over which they are set.

WAINSCOT.

Sheath up the walls of the school-rooms and the assembly-room to the level of the window sills, those of the cloak-room to the height of 6 feet, and those of the halls to the height of three feet, with matched and beaded sheathing, $3\frac{1}{2}$ inches wide, set vertically, and blind nailed. Surmount this sheathing with a moulded cap, made wide in the school-rooms, and hollowed out upon the upper side.

Set a neat moulding at the upper edge of the black board.

WINDOW AND DOOR CASINGS.

Finish all the windows and doors with beaded casings $6\frac{1}{2}$ inches wide, and moulded band.

Set moulded transoms between the doors and the blinds over them.

CLOTHES HOOKS.

Furnish and put into each of the cloak-rooms, 5 dozen double iron clothes hooks, with white metal numbers to designate them, from 1 to 60.

SEATS AND DESKS. Do all the labor required to set in place in each of the school-rooms, 56 grammar school seats and desks.

COAL-BIN. Build a coal-bin in the basement, as by the plan, with 2 inch plank, with 4 by 4 inch studs. Also put in the cold air box to the furnace. To be of planed and matched boards, arranged with valves so as to take the cold air from the basement, or from outside the building.

MATERIALS. All the doors and sashes to be of clear, perfectly seasoned, kiln dried, white pine.

All the exterior finishing stock to be of sound, seasoned white pine.

The interior finishing material, except for the floors, to be of sound seasoned chestnut, free from bad knots, cracks and holes.

Floors of sound, seasoned pine or spruce.

PAINTING. Stop, knot, and paint all the exterior finish, and the doors and sashes throughout, with three coats of the best linseed oil paint.

Grain the entrance doors to imitate black walnut, and the inside doors and sashes in imitation of oak, and finish all grained work with one coat of the best varnish. Give all the interior chestnut work two coats of the best linseed oil.

The last coat of paint upon the curved roofs, to have two tints of lead color laid upon the alternate strips of tin, the upper roof being painted with the darker tint.

The last coat upon the wood finish to have two tints of umber, or umber and yellow ochre.

Furnish all the materials required for the execution of the work, except the furnace and the furniture of the school-rooms, and do all the labor necessary to carry out the design, and to fulfill the evident intent and meaning of the drawings referred to, and this specification.

The materials to be in all respects up to the standard herein called for, and the labor to be performed in the most workmanlike manner.



Design No. 13.

Plate No. 41.





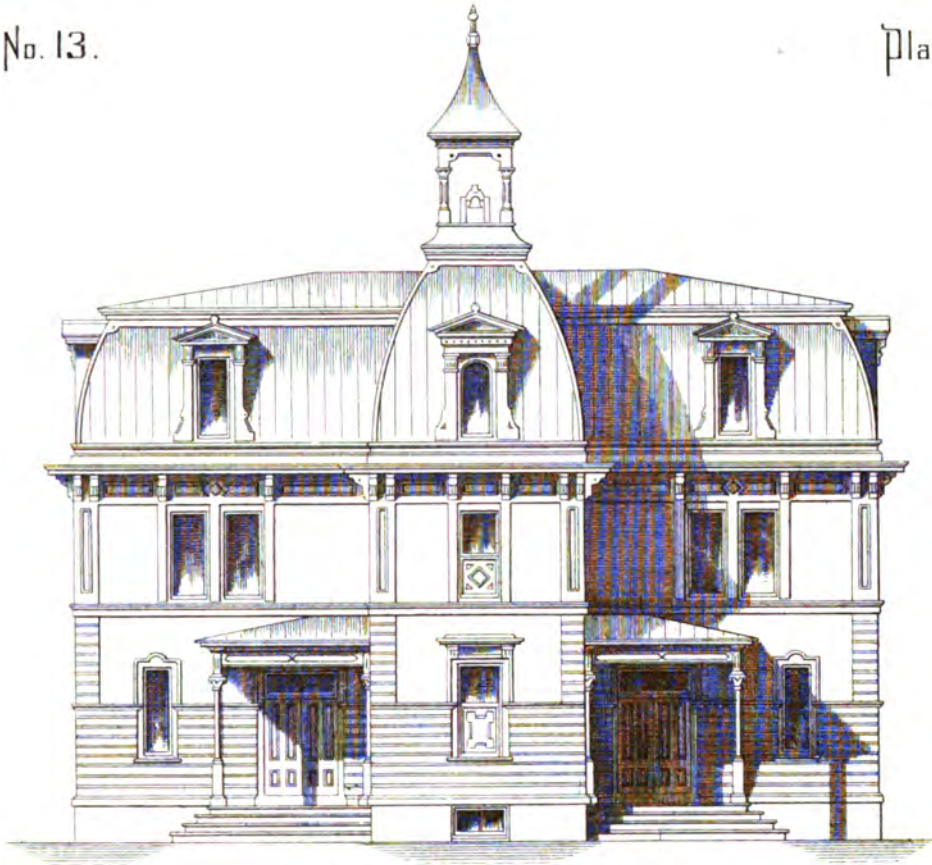

FRONT ELEVATION AND FIRST FLOOR PLAN
1/16 inch to the foot

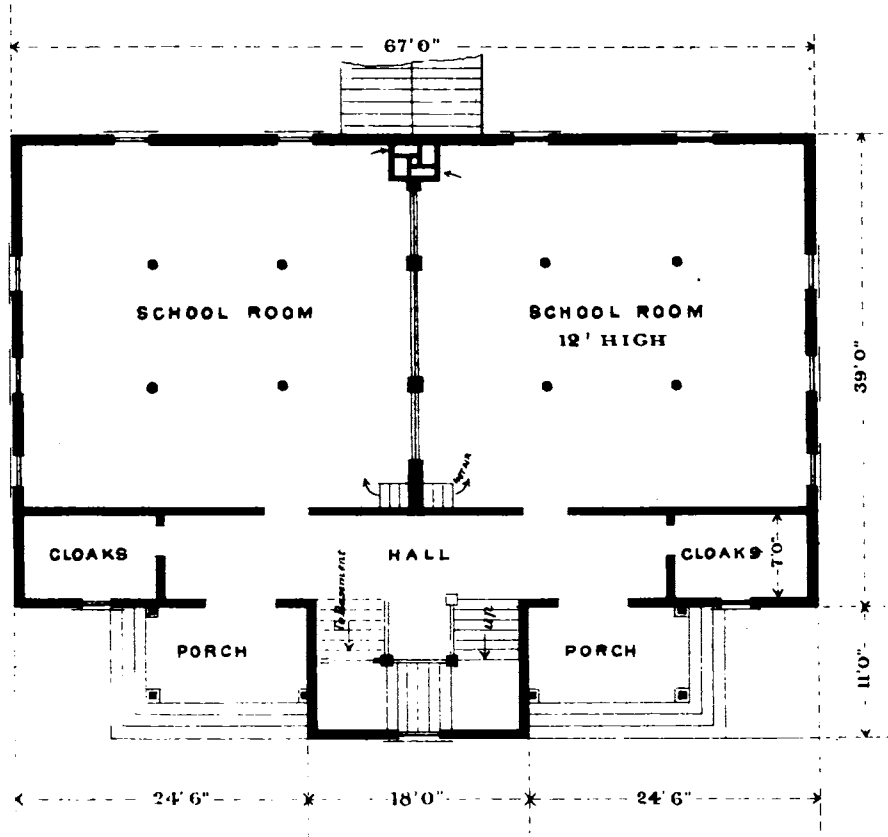



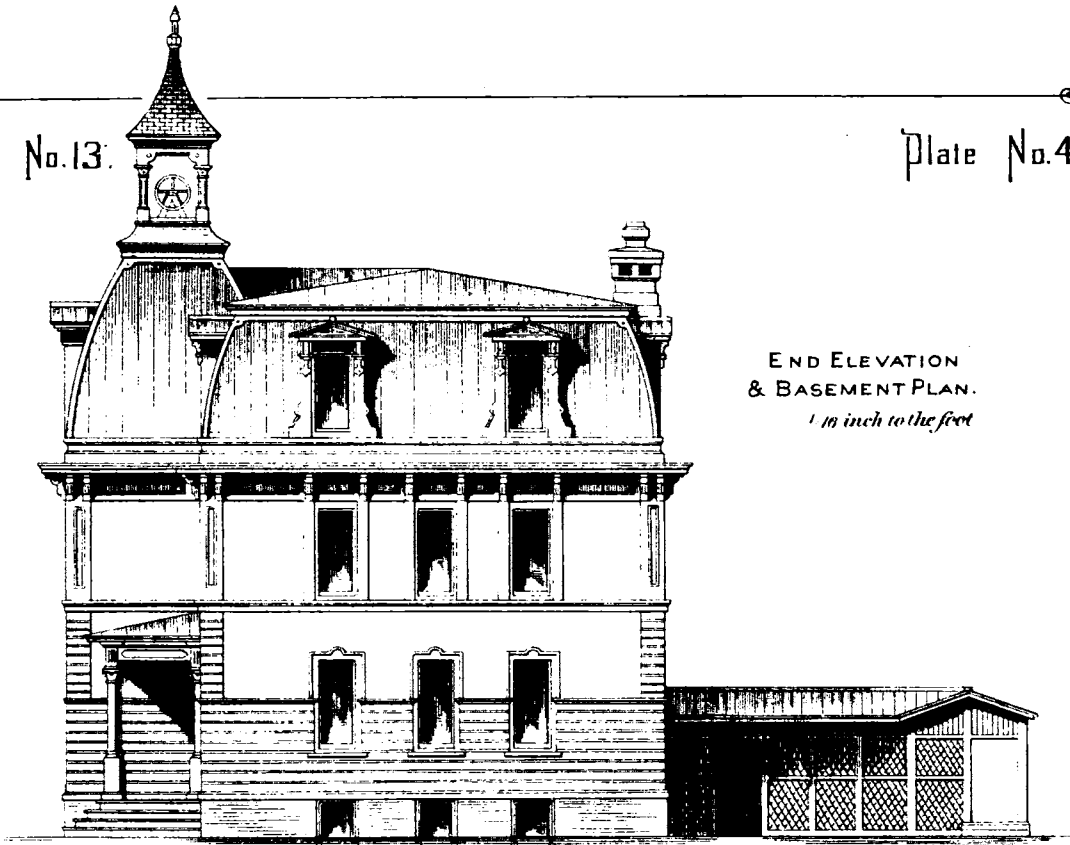

END ELEVATION
& BASEMENT PLAN.
1/16 inch to the foot

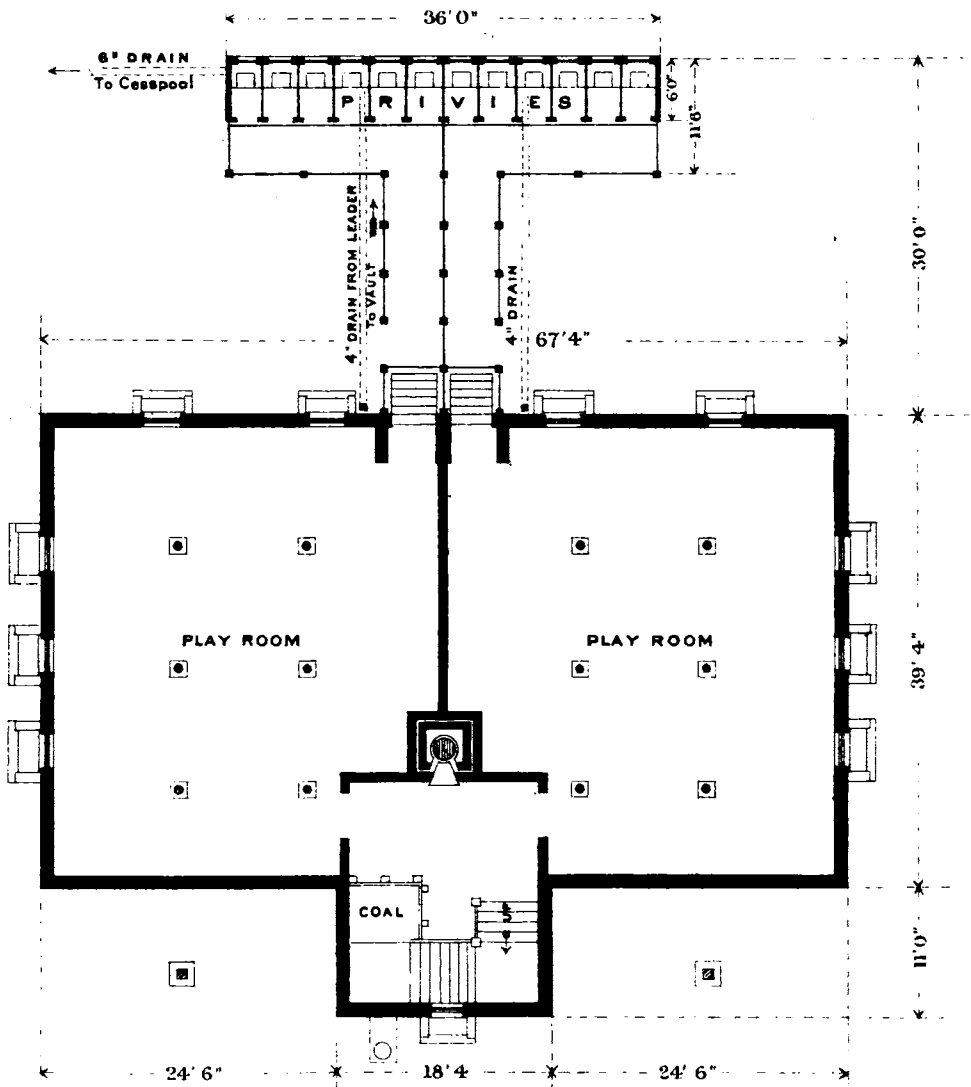



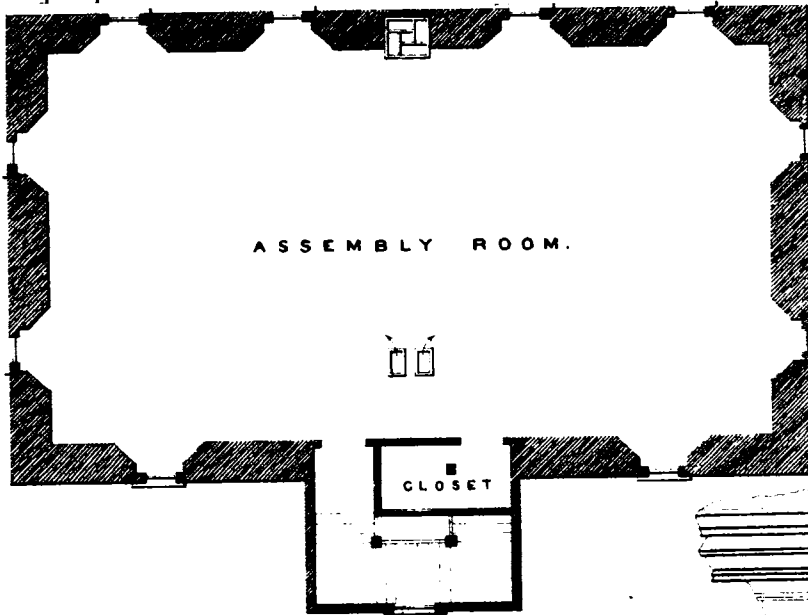

PLAN OF SECOND AND THIRD STORIES.
1/16 inch to the foot

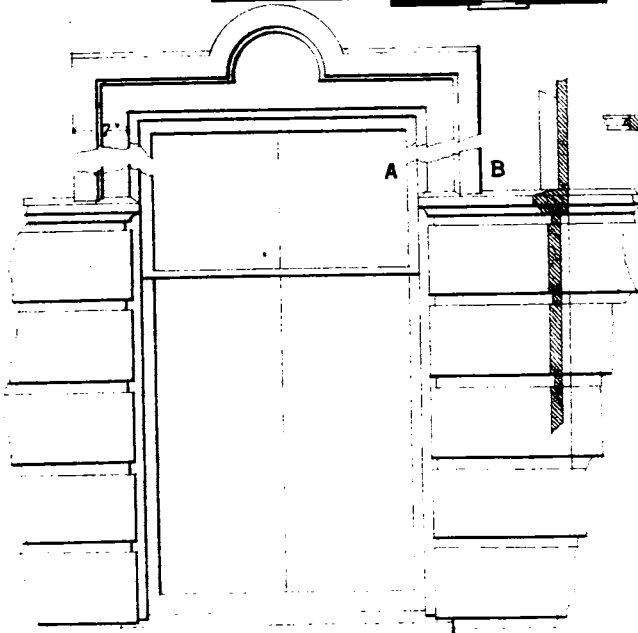
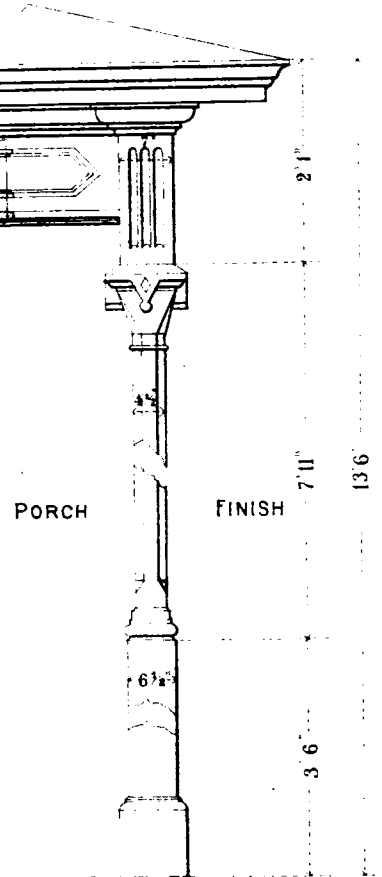
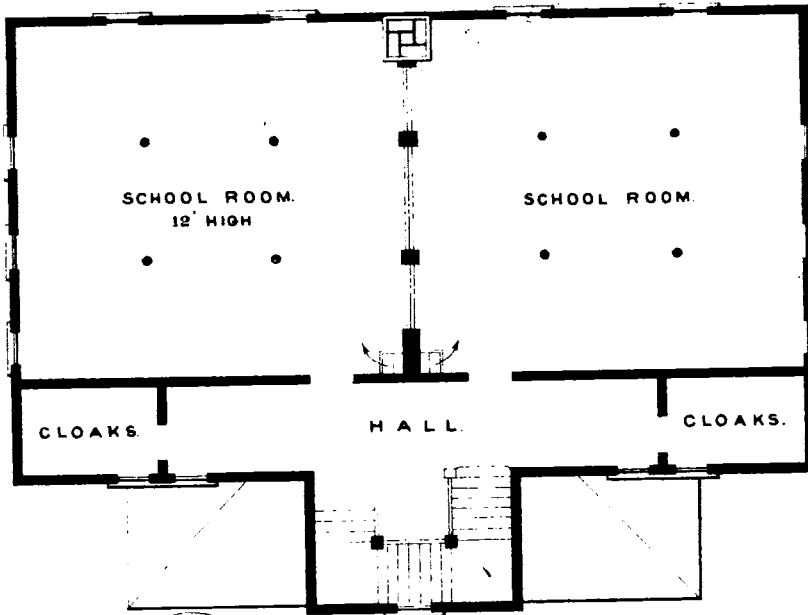

FIRST STORY WINDOWS

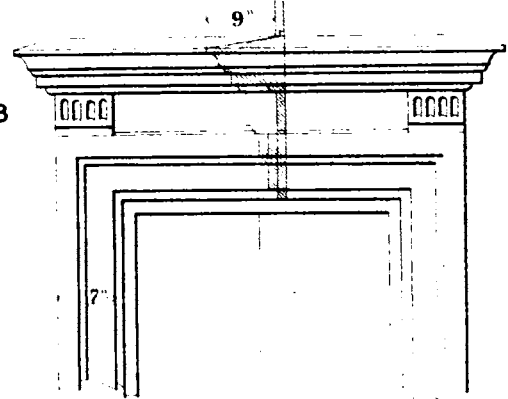
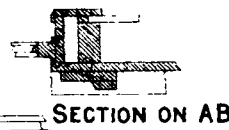

WINDOW HEAD
FIRST STORY OF TOWER

DETAILS *1/2 inch to the foot*



SECTION OF FRAMING OF MAIN ROOF
WITH SIDE ELEVATION OF DORMER

RADIUS 25'
CENTRE ON LINE AB

CENTRE LINE

SECTION OF DORMER ON CENTRE LINE

B
FRONT OF DORMER

CORNICE

FINISH FOR SECOND STORY WINDOWS

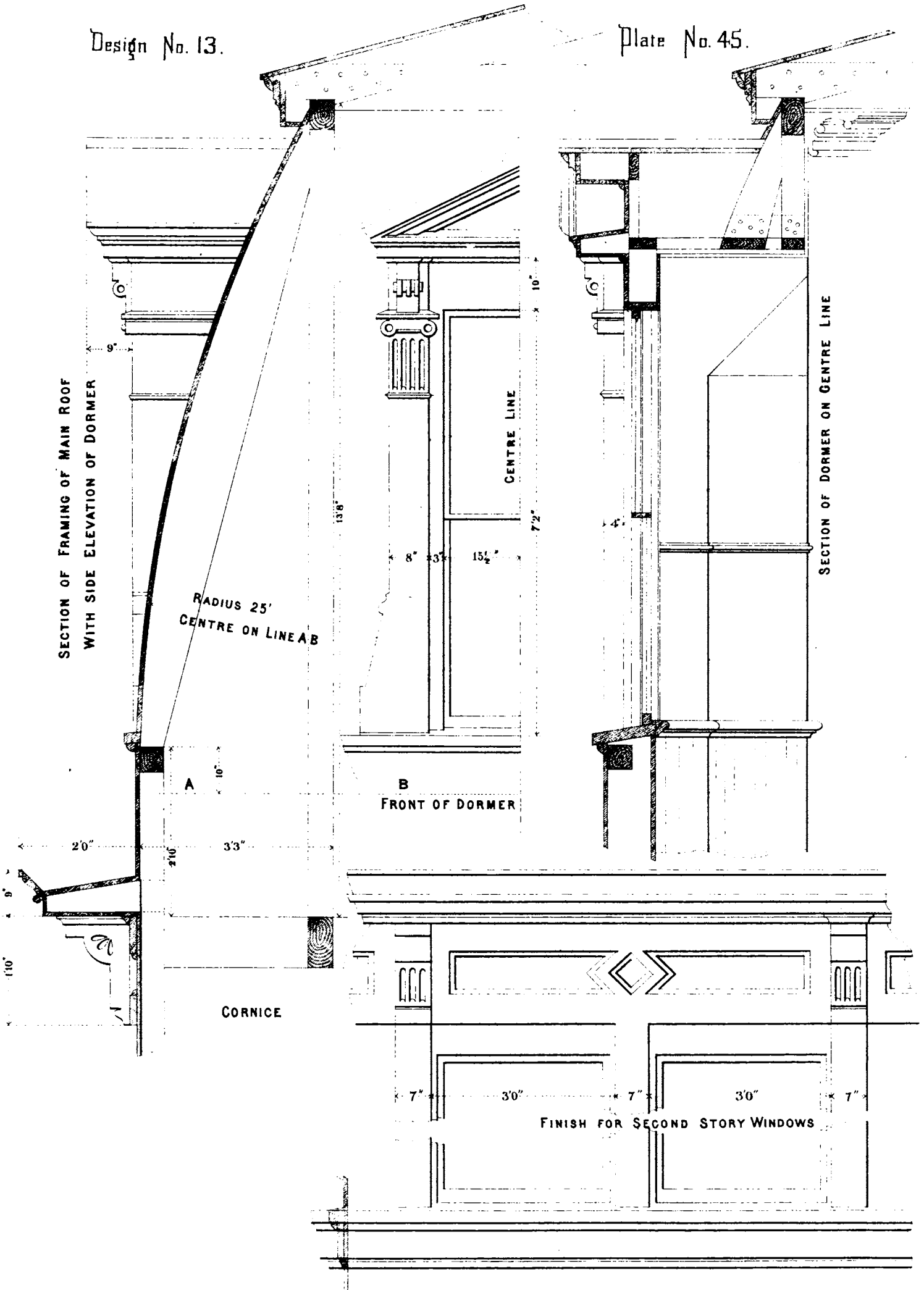

Design No. 13.

Plate No. 46.

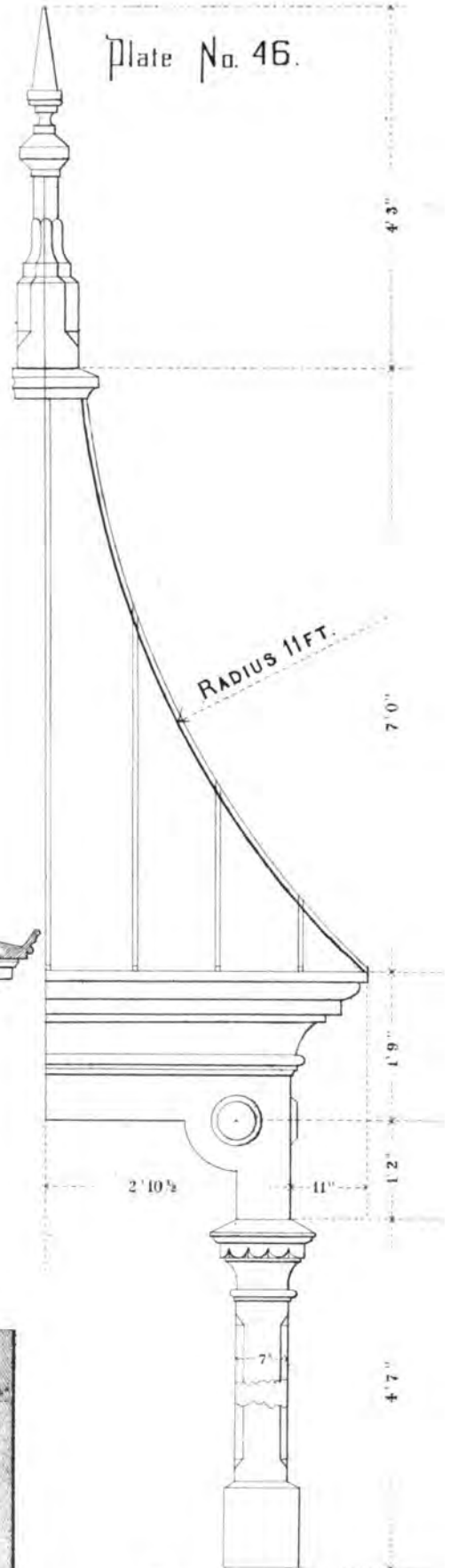
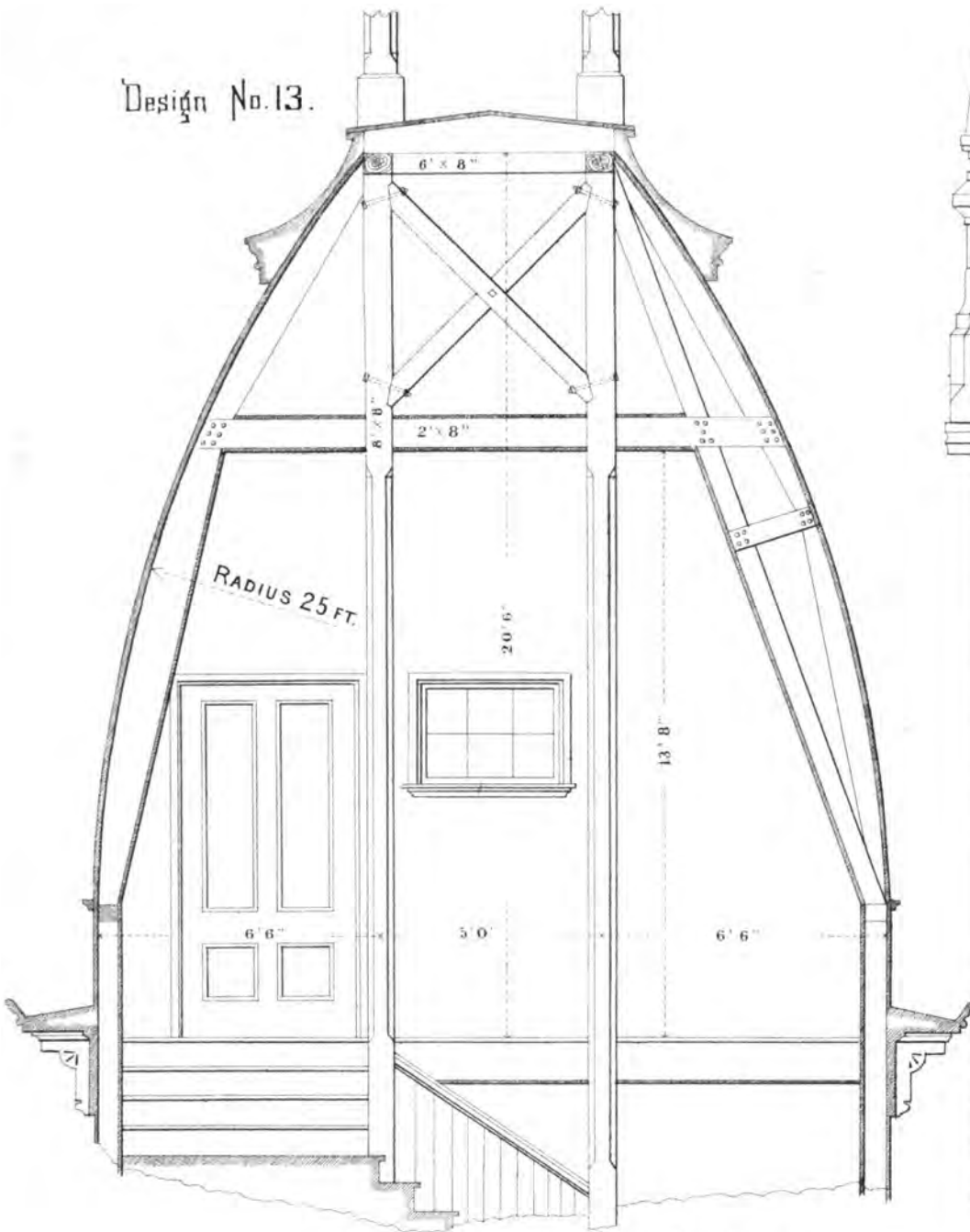

SECTION OF TOWER ROOF.
SHOWING FRAMING
1/4 inch to the foot.

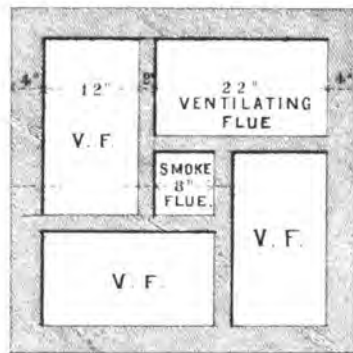
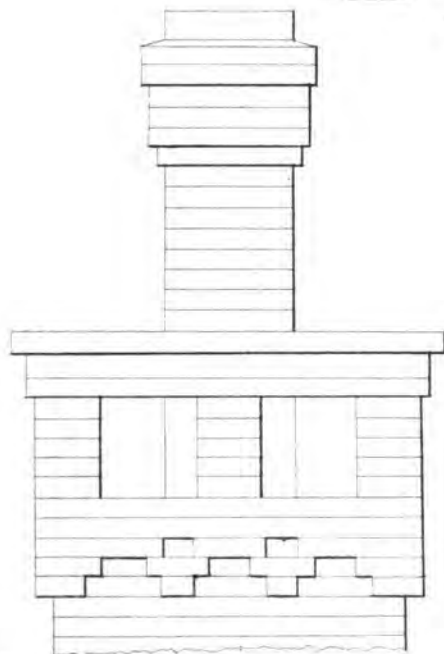

ELEVATION OF CHIMNEY TOP
& SECTION OF SHAFT.

BELFRY FINISH.

1/2 inch to the foot

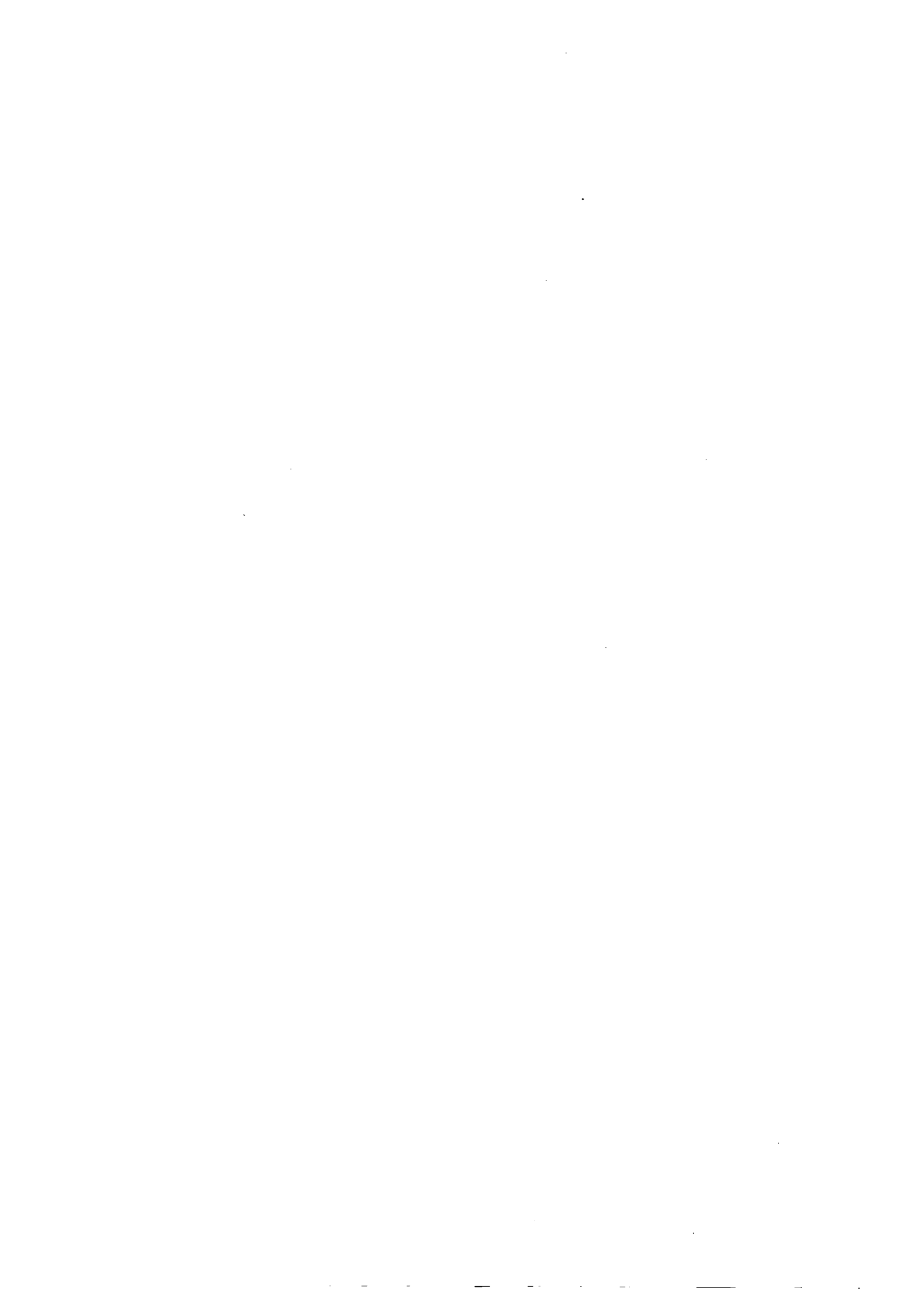

DESIGN NO. 14.

Plates 47, 48, 49 and 50.

A TOWN School-house with two rooms upon each floor.

This design differs from the preceding, in that all the accommodations are contained within a simple rectangular building, broken only by the veranda and the bell-tower.

The arrangement by which the two rooms upon each floor are thrown into one, is a favorite one in some parts of the country, and possesses many advantages. A method of accomplishing this result by means of doors hung with weights, is given in detail.

The plan of the basement, and the connection with the outside privies, are substantially the same as in the preceding design.

The walls are covered with narrow-matched siding, and the principal parts of the exterior finish have a projection of 3 inches.

All frame buildings of this class should have a lining of brick, or of lath and plaster, set between the exterior lining and the plastered wall.

The steep roof may be covered either with shingles or slate, the upper roof being tinned and finished with a gutter at the edge.

The iron cresting and finials should be painted dark blue, and set off with lines and touches of vermillion.

The posts and plate of the veranda, and the larger and projecting parts of the wall-finish, should be stained to imitate old oak. The remaining parts of the exterior finish should be painted with two shades of buff, or some other agreeable yellowish tint.

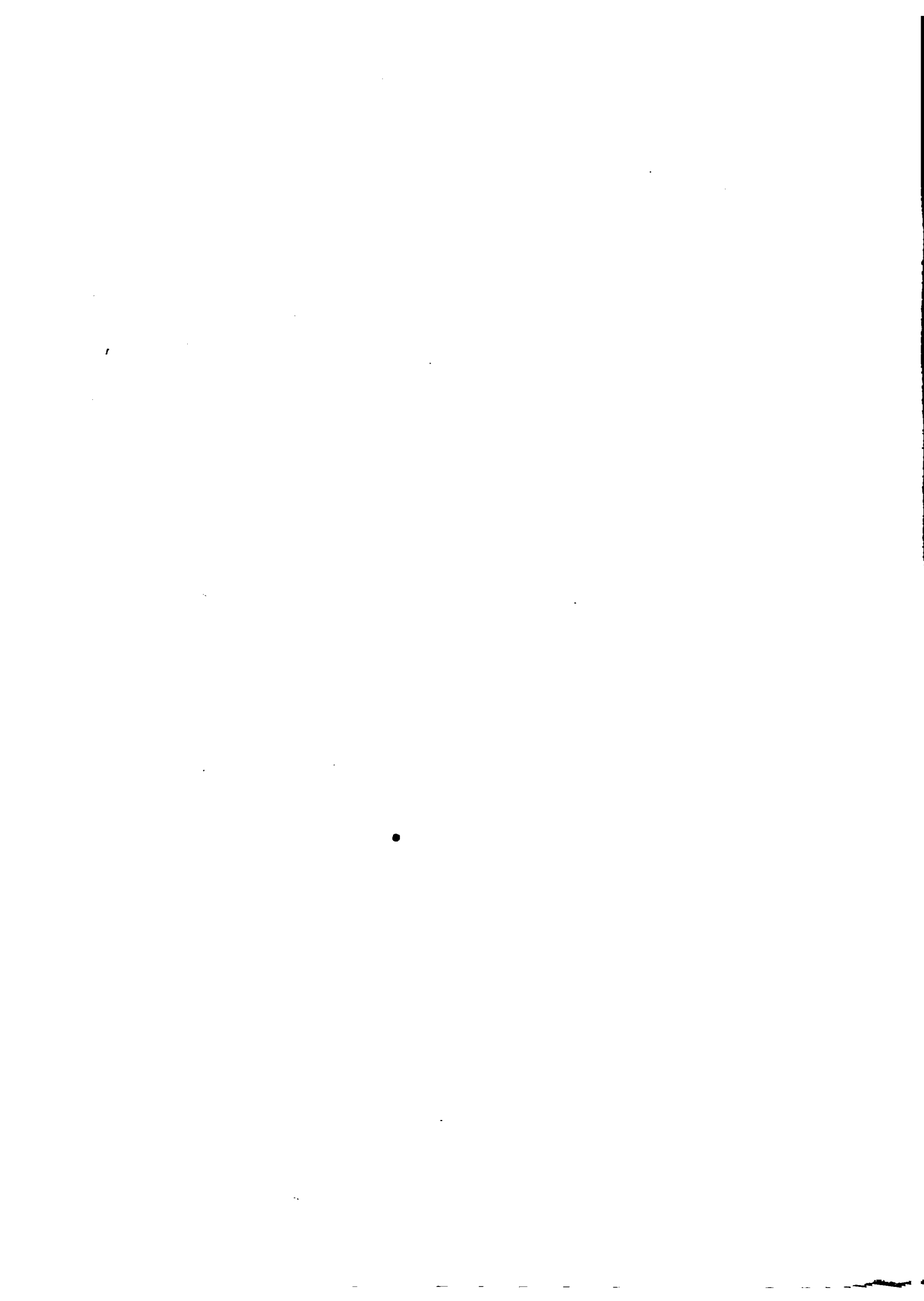

FRONT AND END ELEVATIONS

1/16 inch to the foot

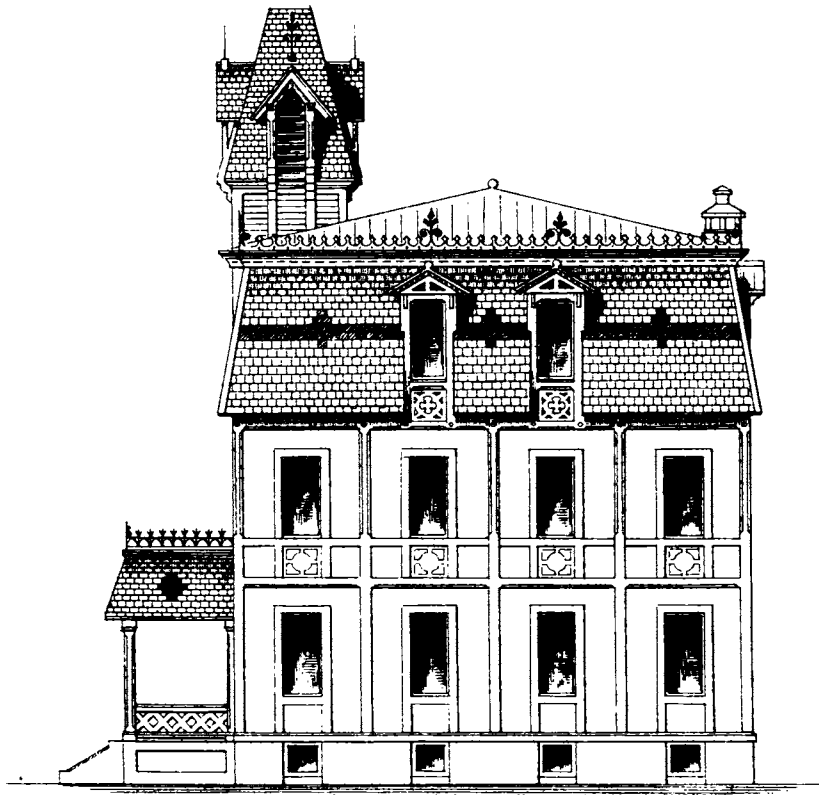
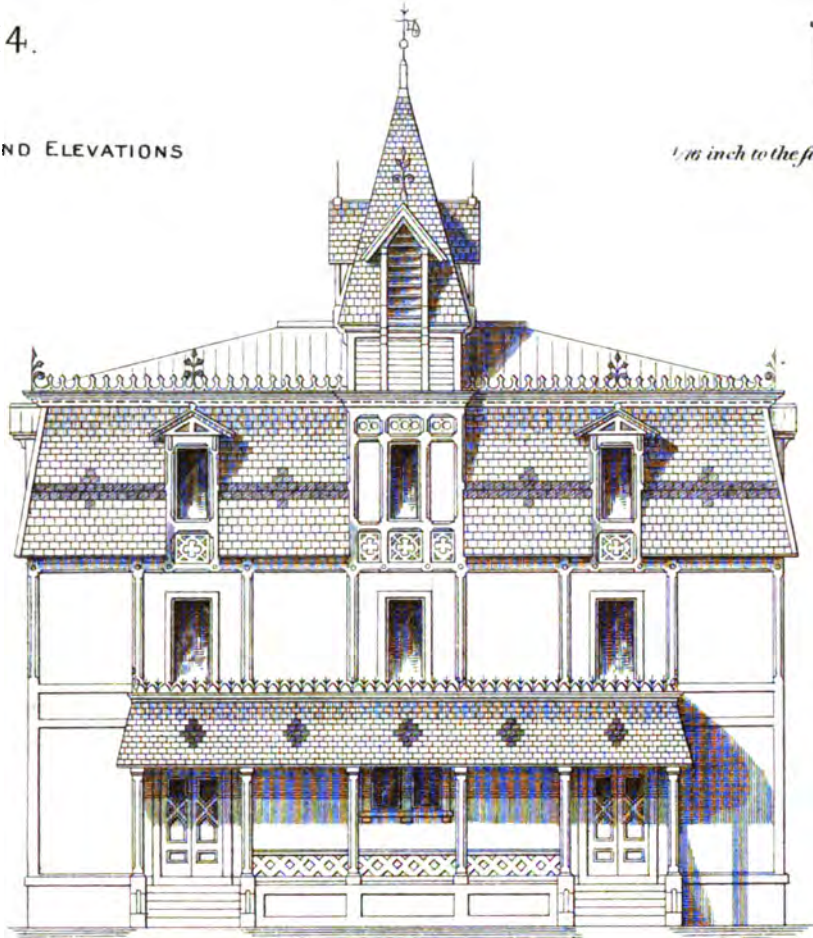



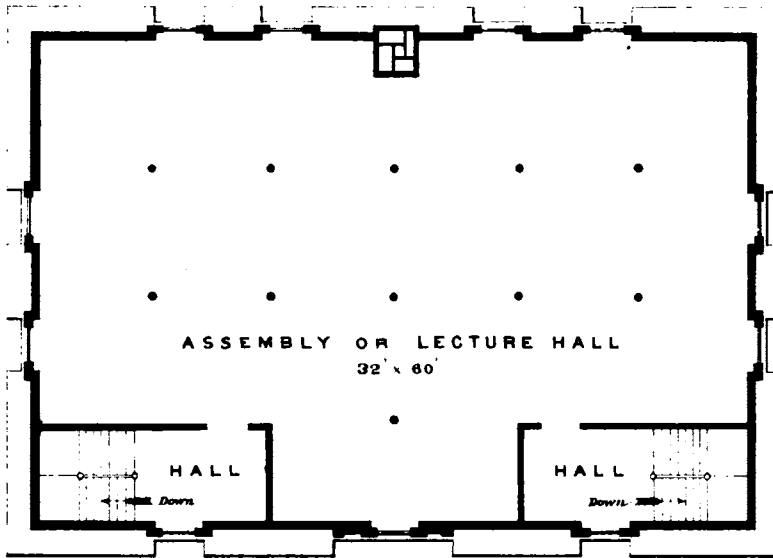

THIRD FLOOR.

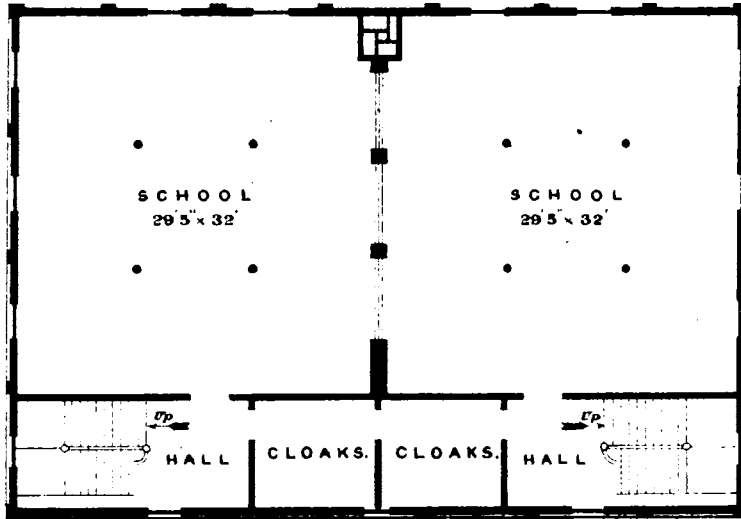

SECOND FLOOR.

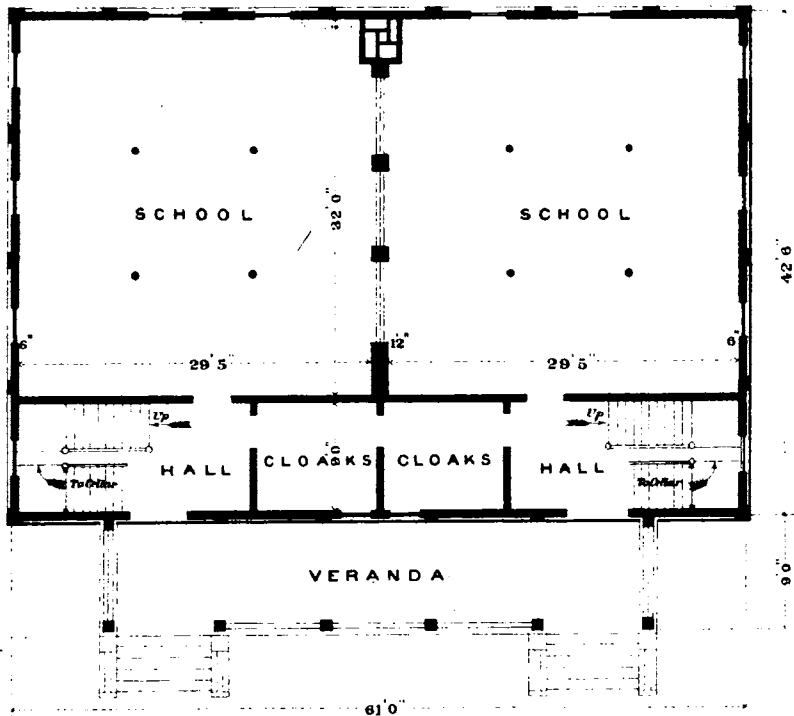

FIRST FLOOR.



1/2 Inch to the foot

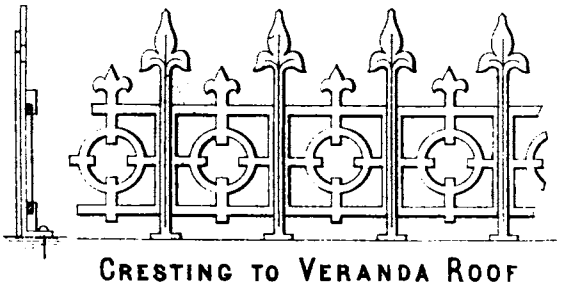
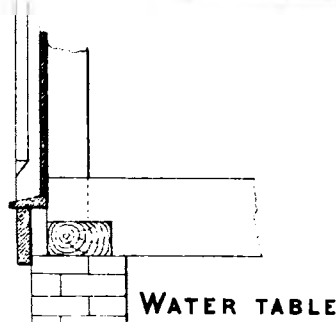
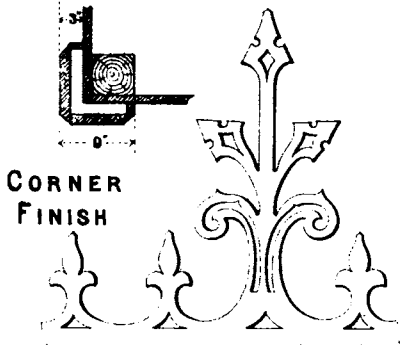
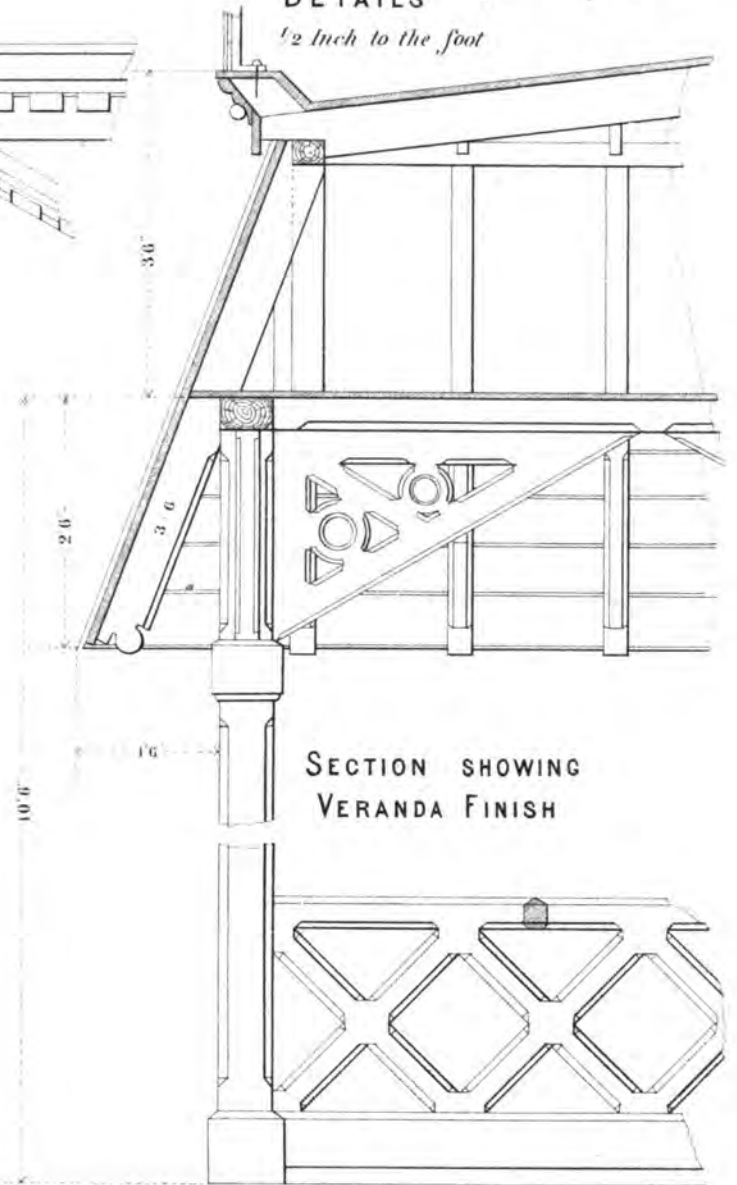
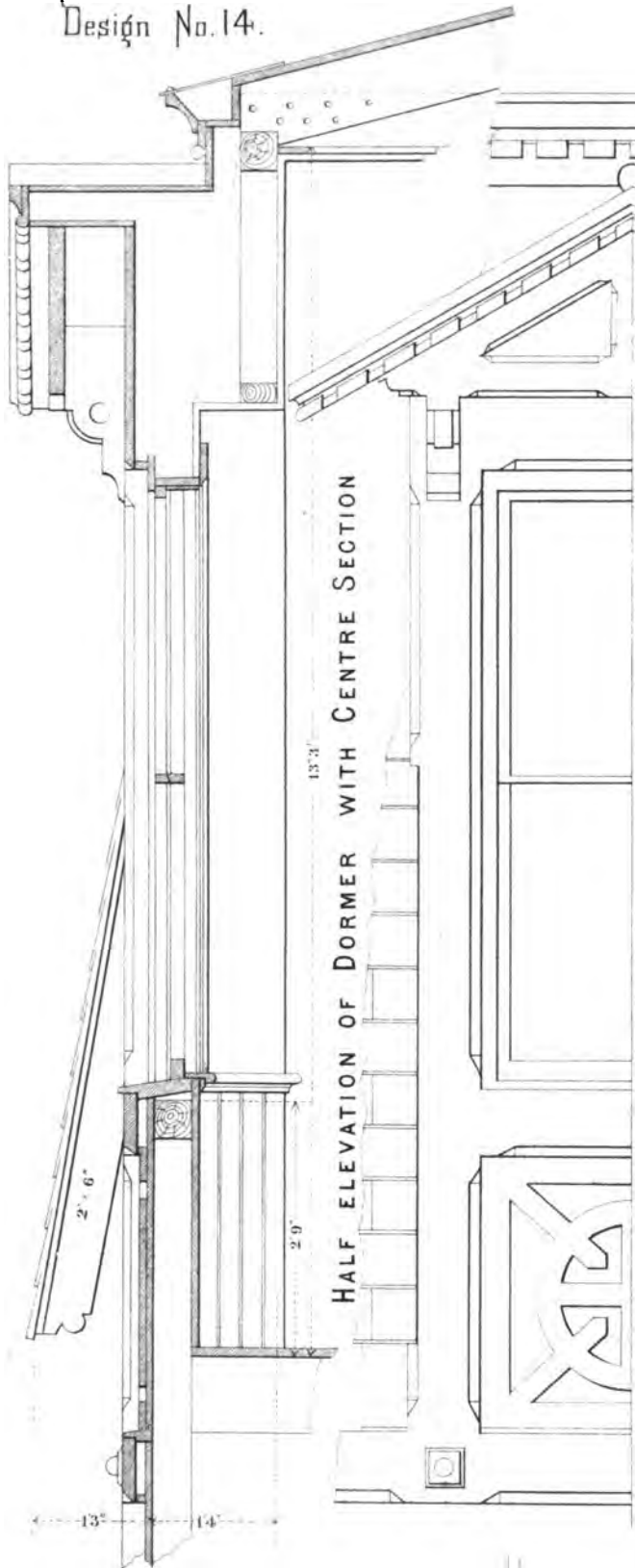



DETAILS $\frac{1}{2}$ Inch to the foot

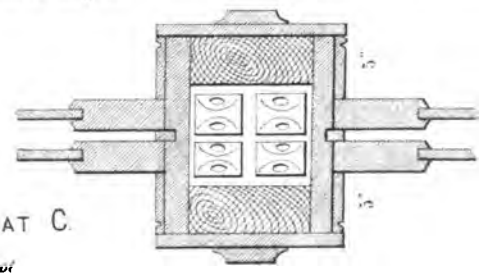
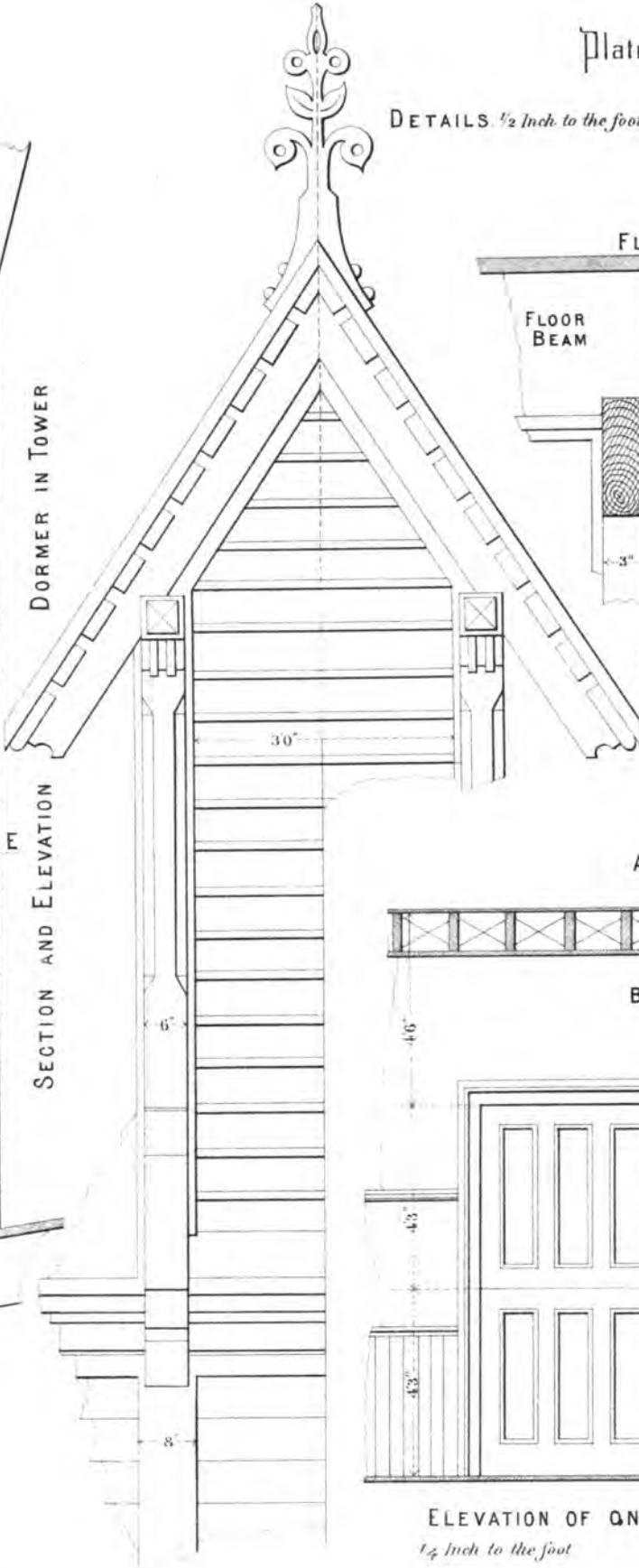
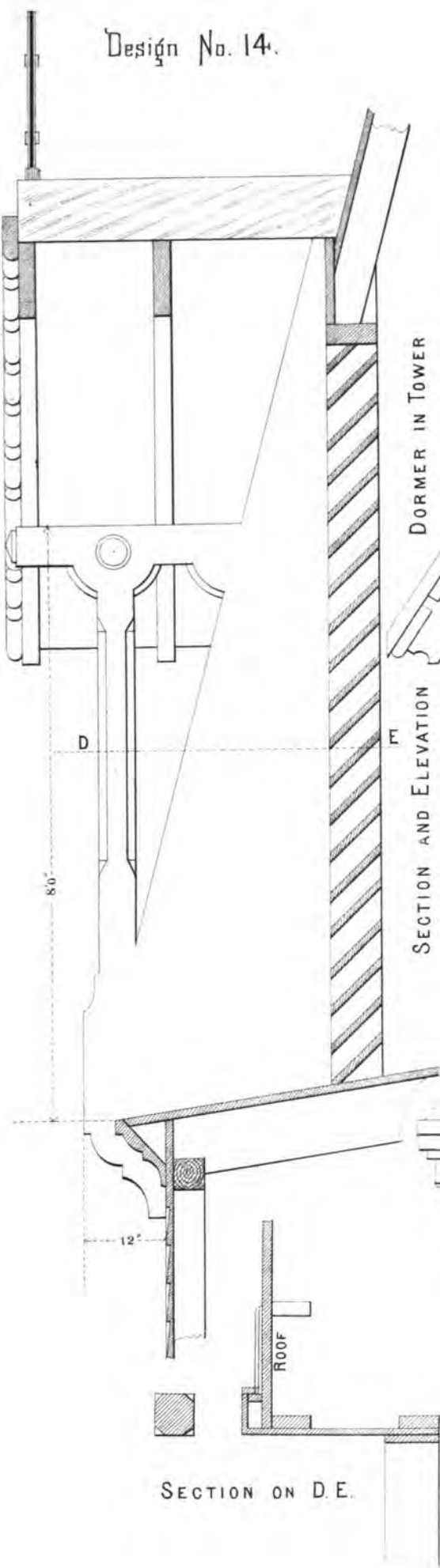

SECTION AT C.
 $\frac{1}{4}$ Inch to the foot



DESIGN NO. 15.
SPECIFICATION.

MASON'S WORK.

EXCAVATION. Excavate for the foundation walls to the depth shown, and for the external piers to the depth of 3 feet.

Level off the bottom of the trenches for the walls, and ram them down so as to secure a good even and firm surface.

DRAINS. Excavate for, and set drains as follows: One 8-inch drain from within the cellar to the cess-pool hereinafter specified, with 6-inch branches starting from beneath the water-closets in the basement, and a 6-inch branch from the privy vault, and two 4-inch drains from the rain-water leaders on the rear, to the privy vault. All of the drains to be of best earthen pipe, well burned and glazed, set with a grade of at least $\frac{1}{4}$ -inch to the foot, with cemented joints. Fit all the drains with traps, and properly connect them with the brick and stone-work. (For arrangement and details of privies, see Design 3, Plate 10, and Design 13, Plate 43.)

CESS-POOL. Cess-pool to be built with good stone, laid dry. To be 10 feet in diameter and 10 feet extreme depth, the bottom being 12 feet below the grade.

The stone walls to be 6 feet high, finished with brick domed top, terminating in man-hole $2\frac{1}{2}$ feet in diameter, covered with stone slab 4 inches thick. Brick-work 8 inches thick, laid in cement, and plastered $\frac{1}{2}$ inch thick upon the outside with cement. The cess-pool to be set as far away from the building as the size of the lot will permit.

- WELL.** Dig and stone-up a well in the cellar as by the plan. To be 3 feet in diameter, of the depth required to secure an unfailing supply of water, covered level with the cellar floor with a 4-inch slab, provided with cast-iron cover 18 inches in diameter, secured to the stone with hinges and a padlock.
- CONCRETE.** Set concrete footings to the foundation walls, $3\frac{1}{2}$ feet wide and 1 foot thick. The concrete to be formed of four parts of screened gravel, no stone being larger than an egg, two parts of clean sand, and one part of well-burned lime, the last ground fine. Mix dry, add water enough to bring the concrete to the consistency of mortar, and set immediately. Puddle the concrete to a uniform surface, and allow it to dry before setting the stone-work upon it.
- STONE WALLS.** Build the foundation walls of the heights shown on the drawings and $2\frac{1}{2}$ feet thick. Use angular quarried stone well bedded and jointed in mortar, the internal joints neatly finished where exposed to view, and the whole left with a good level surface for the brick-work.
- AREAS.** The walls enclosing the areas before the basement windows, to be 8 inches thick, of good hard-burned brick laid in best cement mortar. Cover with coarse hammered curb-stones, 6 by 8 inches, rebated for iron-work.
Plaster the outside of these area walls with best cement.
- STEPS.** Build brick walls 16 inches to carry the steps to the cellar, as required for the area walls.
Set proper stone foundations for the steps to the principal story.
- GROUTING.** Level off the cellar bottom and finish it, as well as the bottom of the window areas, with cement grouting at least 3 inches thick.
- PRIVIES.** Build the privy vaults with hard-burned bricks laid in cement. Sizes to be as in Design No. 14. For details, see Design 3, Plate 10. Build foundation walls for privies 8 inches thick, starting from 12-inch footings at least $2\frac{1}{2}$ feet below the grade. To be of good hard-burned bricks laid in cement mortar. Plaster the interior of privy vaults with two good coats of best cement.

GRADING. Excavate for all the above work, and after the several parts are set, fill up to the grade with earth well rammed, using the earth remaining for making up the levels about the building.

Remove the turf at the commencement, and preserve it for use at the completion.

CUT-STONE WORK.

GRANITE. Sills to principal entrance doors 8 by 16 inches, beveled $1\frac{1}{2}$ inches.

Steps to basement 8 inches rise and 9 inches tread.

Curb to these steps 8 by 8 inches.

Sills for basement windows 5 by 10 inches. The above, as well as the curbs to the areas, to be of granite, coarse hammered.

Set flag-stone slabs 4 feet wide, and as long as the width of the steps to each flight of steps to the principal story.

SAND STONE. Water-table course to be $7\frac{1}{2}$ inches high and 6 inches wide, with 2-inch wash.

Sill-course to first story windows 5 inches high, 10 inches wide, and beveled up $1\frac{1}{2}$ inches at the windows, and 4 inches wide elsewhere, carried completely around the building. Caps to first story windows 8 by 10 inches.

Sill-course to second story windows $7\frac{1}{2}$ inches high, 12 inches wide, and beveled up $1\frac{1}{2}$ inches at the windows, 6 inches wide elsewhere. To project 2 inches, and finish with coved edge at the bottom.

Caps for the second story windows as by the detail drawings, with 4-inch lintel finished with sunk panels behind a brick arch, with skew backs and keystone 4 inches thick.

Stone belt forming the *facia* of the main cornice 8 inches high, cut out for the gutter, and secured by two $1\frac{1}{2}$ by $\frac{1}{4}$ -inch iron clamps to each stone.

All of the above window-dressings and belt-courses, to be of the best sand-stone, accurately jointed, with tooled bed and joint, and rubbed face.

EXTERIOR
BRICK WALLS. The exterior walls to be 16 inches thick, solid, up to the water-table. Above the water-table to be 14 inches thick, and to consist of an 8-inch outer wall, a 2-inch air-space, and a 4-inch inner wall. But build the wall

solid for the width of 2 feet where it carries girders, and bond the outer and inner parts at intervals of 16 inches.

**PARTITION
WALLS.**

Partition walls in basement to be 8 inches thick on 12-inch footings. Build a ledge on these walls to carry one end of flooring-beams for the halls and class-rooms, and set, on the cellar floor, proper brick foundations for the outer ends and the centres of those beams.

INTERIOR BRICK.

Interior brick piers 16 inches square, with 24-inch footings. Provide with flag-stone slabs 16 by 16 and 3 inches at the top, and set 4 of the same in each pier, at equal intervals.

Exterior piers 8 by 8 inches, on stone foundations sunk 3 feet. Use cement mortar for all the piers.

Chimney flues 2 by 3½ feet, used also as ventilating flues. Walls 8 inches thick. In each of the chimneys set an earthen pipe 8 inches in diameter, to serve as a smoke-pipe, and secure it to the inner side of the chimney-flue by iron straps. Set the ventilating registers, hereinafter specified, and do all cutting away of brick-work required in setting hot-water pipes.

Plaster the flues smoothly on the inside throughout.

Finish the windows with 8-inch reveals, those in the second story formed in part of two 4-inch reveals, as by the detail drawings. Set wood lintels, 6 by 8 inches, over the inner side of window openings, to be furnished by the carpenter.

**MATERIALS FOR
BRICK-WORK.**

Execute all of the above specified brick-work with good hard-burned, well-formed bricks, selecting the best for faced work. Lay all bricks, unless otherwise directed herein, with mortar composed of one-third fresh well-burned lime, and two-thirds clean sand. Finish all exposed brick-work with close, uniform, and neatly-struck joints.

Provide all the centres required for arches. Set the bricks in the arches over the second story windows with their length in the direction of the radius of the arch, and cut them so as to make the joints of uniform width.

LATHING AND PLASTERING. Lath the ceiling of the basement story, the outer walls of the rooms in it, and the walls, ceilings and partitions in the rest of the building, throughout, with good sound pine laths, free from knots and bark.

Plaster the ceiling of the "cellar" with one good coat of hair mortar, floated and smoothed.

Plaster the remaining walls, ceilings, and partitions, throughout, with two good coats, the first of hair-mortar floated to an even and true surface, and the last of hard-finish white mortar trowelled down hard and smooth.

For the black-boards, substitute for the second coat named above, a coat of black mortar suitable for the purpose.

Run stucco cornices 6 by 8 inches in the two school-rooms and in the assembly room, and finish the projecting angles with $1\frac{1}{2}$ -inch beads.

TINNER'S AND PLUMBER'S WORK.

GUTTERS. Line the gutters in the cornices with tin. Carry that in the gutter of the main cornice up 6 inches under the slating, and work a $1\frac{1}{2}$ by $\frac{1}{4}$ -inch iron rod into the outer edge of it.

Set galvanized iron straps to secure the *facia* of the upper cornice to the roof. To be set 2 feet apart.

TIN-ROOF. Cover the upper roof and the roof of the porches with tin, put on with standing lock-joints. Flash the porch roofs, where they meet the vertical wall, with 4 lb. sheet lead.

Paint all exterior tin-work with two good coats of the best metallic roofing paint.

RAIN-WATER LEADERS. Put up, with proper iron hold-fasts, two 4-inch leaders on the rear of the building connecting with the drains, and put in four 4-inch 18 oz. copper leaders, well clenched and soldered, to connect the gutters at either side of the towers with the tanks in the second story, two to each tank.

TANKS.

The tanks in the second story, over the cloak-rooms, will be 6 by 6 by 3 feet each, and that in the class-room in the basement will be $4\frac{1}{2}$ by 2 by $1\frac{1}{2}$ feet.

Line all these tanks with sheet lead, 4 lbs. to the foot, well-soldered and secured to the sides. Extend the lining of the tank in the basement over the whole of the top of the table of which it forms a part.

Put in 5-inch 18 oz. copper overflow pipes from the tanks in the second story to the drains below, well clenched and soldered, and firmly secured to the walls.

WATER-CLOSETS.

Put in two best constructed pan water-closets in the basement, as by the plan. To have white Wedgewood-ware basins and receivers, with brass cup and handle, and to be supplied from the tanks above, each through strong lead pipes.

Put in 6 lb. lead trapped soil-pipe, and 4-inch cast-iron soil-pipes to connect with the drains.

URINAL.

Put in one Wedgewood-ware urinal, with $\frac{3}{4}$ -inch strong lead supply-pipe, fitted with brass cock, and $1\frac{1}{2}$ -inch waste-pipe to the drain.

WASH-BOWLS.

Put in each of the cloak-rooms in the first and second stories, a 14-inch Wedgewood-ware, marble pattern basin.

Supply them through strong $\frac{1}{2}$ -inch lead pipes, and put in proper overflow and waste-pipes to the drains.

Finish with white marble top and wall-pieces, the former 2 feet by 20 inches, and the latter 12 inches high.

The basins to have silver-plated upright basin-cocks and silver-plated plugs, chains, strainers, and overflow.

Put in a $\frac{3}{4}$ -inch strong lead pipe from the nearest tank, to the tank in the class-room, with brass cock, and 2-inch waste-pipe to the drain.

PUMPS.

Set two $2\frac{1}{2}$ -inch brass cylinder lift and force-pumps in the basement, drawing water from the well through $1\frac{1}{2}$ -inch lead pipes, and connected with the tanks in the second story by extra strong $1\frac{1}{2}$ -inch lead pipes. Set one of these pumps next the tank in the basement class-room, with brass cock

in the discharging-pipe to empty into the tank, and the other in the hall at the opposite end of the basement.

Provide the pipes leading to the wash-bowls with filters, and arrange for emptying the tanks into the drains.

Trap all the pipes connecting with the drains.

REGISTERS.

Provide ventilating registers for the several rooms, four to each room and the assembly room, and two to each class-room. Each to be 12 by 16 inches, of ornamental pattern of japanned iron, with swivel valves complete.

MATERIALS.

The tin required for the foregoing work is to be of the best quality of charcoal tin, XX thickness, and all of the other materials are to be the best of the several kinds specified.

(It is designed to heat the building by means of steam radiators supplied by pipes from a boiler in the basement, the pipes being carried up in the chimney-flues as far as practicable.)

CARPENTER'S WORK.**FRAME.**

Timber as by the list given below, all of sound square-edged spruce, except as otherwise specified.

Girders (four to each floor) 8 by 10 inches.

Flooring-beams 2 by 10 inches, set 16 inches on centres, framed with tusk and tenon, and bridged with sound 1 by 3-inch strips. Headers and trimmers at cellar windows 4 by 10 inches, and around stairways, 5 by 10 inches.

Double the beams carrying partitions.

Flooring-beams for the halls and class-room in the basement, of 3 by 6-inch sound pine or chestnut, set 18 inches on centres.

Wall plate 4 by 10 inches. Upper plates 6 by 8 inches. Studs carrying upper plates, 2 by 6 inches, 16 inches on centres.

In the alcoves of the assembly room, set, on the girders in the floor, 6 by 6-inch chamfered chestnut posts, to carry the upper plates.

Rafters to steep roof 2 by 6 inches, set 18 inches on centres.

Rafters for upper roof 2 by 9 inches, with 2 by 9-inch ties, and 1 by 8-inch doubled suspension pieces and braces, the whole spiked together in the most thorough manner. Rafters set 18 inches on centres.

Studding for tower 5 by 5 inches at the corners, 3 by 5 inches for the windows, and 2 by 5 inches for the rest. Cut in six 3 by 5-inch braces, and nail them well.

Rafters for tower-roof 2 by 8 inches, set 18 inches off centres, with 2 by 6-inch ceiling pieces. Cut in 2 by 5-inch nailing pieces horizontally between the studs, not more than 3 feet apart.

Sills for porches 4 by 8 inches, and flooring joists 2 by 8 inches, set 18 inches on centres. To be of sound pine or chestnut. Posts for the same 6 by 6 inches, plates 6 by 6 inches, and rafters 3 by 6 inches, all of selected pine free from shakes, sap, pitch, and bad knots, planed and chamfered.

Plates and rafters required for the dormer windows 2 by 6 inches.

Execute all the framing required in the most substantial and skillful manner.

Posts in the school-rooms to carry the girders of 6 by 6-inch selected chestnut, chamfered, and finished with moulded capitals and bases.

Furnish timber lintels 6 by 8 inches, for all the window and door-openings.

ROOFS. Cover the roof throughout with sound seasoned roofing-plank, planed $1\frac{1}{8}$ inches thick, and matched. Bead the under side of the roofing to the porches.

SLATING. Finish the steep roofs, the roofs of the towers and of the dormers, with the best black or purple Pennsylvania or Vermont slate, laid with 3-inch lap, over stout roofing felt.

Flash the hips, valleys, and all other parts requiring it, with stout zinc, and make all roofs weather-proof.

EXTERIOR FINISH. Floors for porches of 3 by $1\frac{1}{2}$ -inch pine, planed, matched, and put down with painted joints.

Sheath down to the ground below the floors, with narrow pieces, and finish between the columns with railing, as by the plans. Sheath-up the

vertical walls below the pointed roofs with pine 5 inches wide, planed and matched, and form the corners and belts of 1½-inch pine.

Plane and chamfer the exposed parts of the rafters to the dormer windows and pointed roofs, and finish them as required by the detail drawings. Put on 3-inch ridge rolls, and finials as by the drawings.

Case up a gutter in the upper cornice.

WINDOWS.

The frames for the short cellar windows to be of 2-inch plank rebated for the sash. For the long cellar windows, and for all the windows above the cellar, to be of the usual box form, with cherry or Southern pine pulley-stiles.

Sills 2½ inches thick, rebated.

The windows in the higher pointed roof to be fitted with shades, with ornamental outer edge.

Sashes throughout to be 1½ inches thick, one sash to each of the shorter cellar windows, and two sashes to the remaining windows, weather-lipped at the meeting rail.

Glaze all the sashes throughout with best double-thick English or French sheet glass, with six panes to each sash.

Hang the short cellar windows with 3-inch iron butts, and fasten them open and shut with strong iron buttons.

Provide iron gratings, consisting of ½-inch bars, set 3 inches apart in 1½ by ½-inch side pieces, for all the cellar window areas, also screens of ½-inch iron wire in strong wooden frames for the cellar windows.

Hang all the sashes in the long cellar windows, and in the windows above the cellar, with best 2-inch axle-pulleys, cast-iron weights, and best Russian hemp sash-cord, and fit them with most approved spring-centre fasts.

FLOORS.

Lay the floors throughout, including those in the basement halls and class-room, with sound, perfectly-seasoned pine or spruce flooring, free from shakes, cracks, and bad knots, 3 by 1½ inches, planed, matched, blind-nailed, and smoothed off after laying.

Build the teachers' platforms of the same materials and of the sizes given on the plans.

Finish them with rounded edge and coved moulding beneath.

Thresholds of cherry or Southern pine.

Lay a floor of 1-inch sound pine or spruce, planed and matched, on the ceiling joists in the top of the tower, and case up a scuttle, 3 by 4 feet, in the same.

Provide neat and strong step-ladder to this floor.

PARTITIONS.

Set the partitions throughout as required by the plans. Studs for partitions enclosing the water-closets in the basement 2 by 4 inches. For all other partitions, 2 by 5 inches, and in the partitions above the basement story, bridged.

Make the projecting angles solid, and double-stud the doors. Studding to be of sound spruce.

FURRING.

Fur out the external walls of the halls and class-room in the basement, and all the external walls above the basement. Fur down all the ceilings. Use for all the furring, sound 1 by 3-inch strips, set 16 inches on centres.

The ceilings of the cloak-rooms may be furred down to 10 feet clear height.

STAIRS.

Build the stairs, from bottom to top, with 2½ by 10-inch string pieces, beaded at the lower edge, three of them to each flight, 1½-inch treads finished with half-round edge and ¾-inch rises.

Tongue the riser to the tread at both edges. The outer string-pieces to be of the full size given, the risers and treads being tongued into it.

Set 7-inch turned posts at the angles, and case-up on the outer string 3 feet high, with beaded sheathing 3 inches wide, finished with 2½ by 4½-inch moulded rail.

Frame the landings with 3 by 6-inch pieces, planed and beaded at the lower edges.

The posts and rails to be of the best black walnut, and all the remaining work in the stairs of best chestnut.

Plane and bead the stringers, and the under side of the risers, treads, and landings.

Stairs to be 4 feet wide in the clear.

DOORS.

Make the principal entrance doors 5 feet wide, by the height given on the plans, and $2\frac{1}{2}$ inches thick.

To be cut off at the height required to permit them to clear the stairs, the upper part being stationary, and glazed as required for the windows.

The lower part to be double, each half hung with three $4\frac{1}{2}$ by $4\frac{1}{2}$ -inch iron butts, one half being fitted with shove-bolts at top and bottom, and the other half with most approved mortise latch and lever-lock.

These doors to be finished with raised mouldings.

Entrance doors to basement to be 2 inches thick, hung with $4\frac{1}{2}$ by $4\frac{1}{2}$ inch iron butts, and fitted with mortise latches and large-sized rim-locks.

The above doors to be made of best clear pine, thoroughly seasoned.

The inside doors throughout to be of best chestnut, $1\frac{1}{4}$ inches thick, with raised panels (four to each), and bevelled stiles and rails. Above the basement story to be 3 feet 4 inches by $8\frac{1}{2}$ feet, and to have at the top an opening 2 feet high, fitted with blind in two panels, with swivel shades.

The doors in the basement to be 3 by 7 feet.

Hang all the inside doors with $4\frac{1}{2}$ by $4\frac{1}{2}$ -inch iron butts, three to each, and fit them with most approved mortise locks and latches, with bronze metal handles and facings, using the same style of handles and facings, for the fastenings of the outside doors.

INTERIOR FINISH.

DOORS AND
WINDOWS.

Finish all the doors and windows throughout with plain casings $7\frac{1}{2}$ inches wide, and band 3 inches wide, the latter with coved inner edge.

Provide all the windows in the school-rooms, class-rooms, and assembly room, with framed inside blinds $1\frac{1}{4}$ inches thick. To have eight panels to the window, with swivel shades, and to be hung and fastened in the best manner.

CLOAK-ROOMS.

Sheath up the cloak-rooms to the height of 6 feet from the floor, with matched and beaded sheathing, set vertically and finished with moulded cap.

Put up in each cloak-room forty strong double iron clothes hooks, with white metal numbers to each.

SCHOOL-ROOMS. Finish the walls of the school and class-rooms as high as the windows, with beaded sheathing 3 inches wide, set vertically, blind-nailed, and terminated with moulded cap, projecting $2\frac{1}{2}$ inches, hollowed out at the top.

Put up at the top of the black-boards (6 feet from the floor) a scotia and torus moulding.

The black-boards to extend entirely around the walls of the class-rooms, and to occupy the two longer sides of the school-rooms.

The class-room in the basement to be provided with apparatus shelves enclosed by sliding glass doors. The part indicated for that purpose on the plan, to have cupboards $2\frac{1}{2}$ feet high, next the floor, the apparatus shelves to be above them, the glazed doors extending to the ceiling and terminating with moulded cornice.

Finish the cupboards with paneled doors, shelves as directed, and twelve shallow dovetailed drawers.

Case up the tank in this room as required for the walls, and make, in connection with it, a cupboard with shelves.

Provide all the above-named doors, windows and drawers, with most approved bronzed iron fittings.

TANKS. Build the tanks of sound seasoned pine plank, tongued and grooved, properly ironed together, and secured in place.

Those in the second story (two in number) to be set in the top of the cloak-rooms next the outer wall.

That in the basement class-room to be set as by the plan. Cover the cupboard at the end of this tank with $1\frac{1}{2}$ -inch matched pine with raised edges.

Finish the water-closets in the basement with black walnut riser, cover, and flap, the last-named with brass hinges.

Sheath-up under the wash-bowls with materials similar to those required for the walls of the cloak-rooms, and set panel door to the cupboard thus formed.

Do all cutting away of wood-work required by the plumbers during their work, and repair the same afterward.

Case up neatly all water-pipes exposed to view.

PRIVIES.

Build privies as shown by the plans of Design No. 14.

Walls to be of matched and battened sheathing, with tinned or slated roof. Tight board fence dividing the passage-way to them, with screens formed of lattice-work.

Doors $1\frac{1}{4}$ inches thick, $2\frac{1}{2}$ by 7 feet, fitted with rim locks.

Paint all the wood and tin-work about the privies with three good coats of lead and oil paint, and shower fine sand in the last two coats.

MATERIALS.

For the sashes use the best clear, perfectly seasoned white pine.

For all the exterior wood-finish use sound, thoroughly-seasoned white pine, free from sap, shakes, cracks, pitch, holes, and bad knots.

For all interior finish, unless otherwise specified herein, use sound seasoned chestnut, free from holes, cracks, and bad knots.

PAINTING.

Paint all the exterior wood-work three times with the best Union white lead and pure boiled linseed oil.

Grain both sides of the entrance doors to imitate black walnut, and finish them with one coat of the best varnish.

Give the finishing coat on the porches, dormers and roof-finish, two tints, as directed.

Tint the window frames below the roof to imitate freestone, and shower fine sand in the last two coats.

Rub down smooth and finish with oil, all the interior hard wood-work, and grain the window-sashes upon the inside in imitation of white oak.

FURNITURE.

Set, in each school-room, 80 single desks and chairs, to be furnished by the committee in charge of the building.

Finish and complete all labor necessary to carry out the evident meaning of the plans referred to and this specification, and provide all materials required, unless otherwise stated herein. The materials to be the best of the several kinds specified, and the labor to be done in the most skillful manner.

Leave all the work sound, clean and perfect at the completion.



FRONT ELEVATION AND PRINCIPAL FLOOR PLAN

1/16 inch to the foot

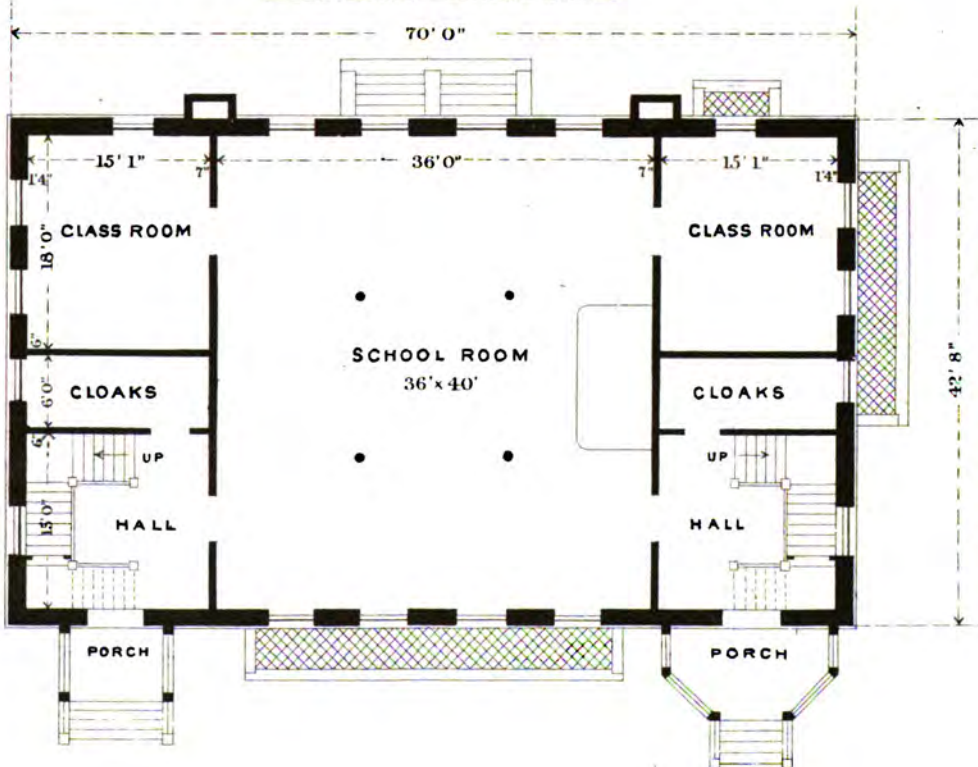

END ELEVATION AND SECOND STORY PLAN

1/16 inch to the foot

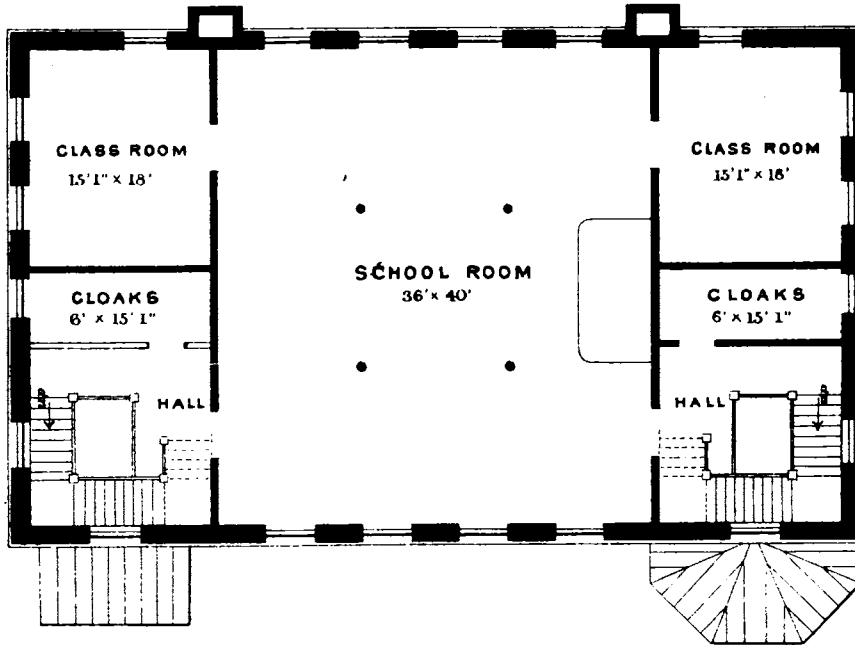
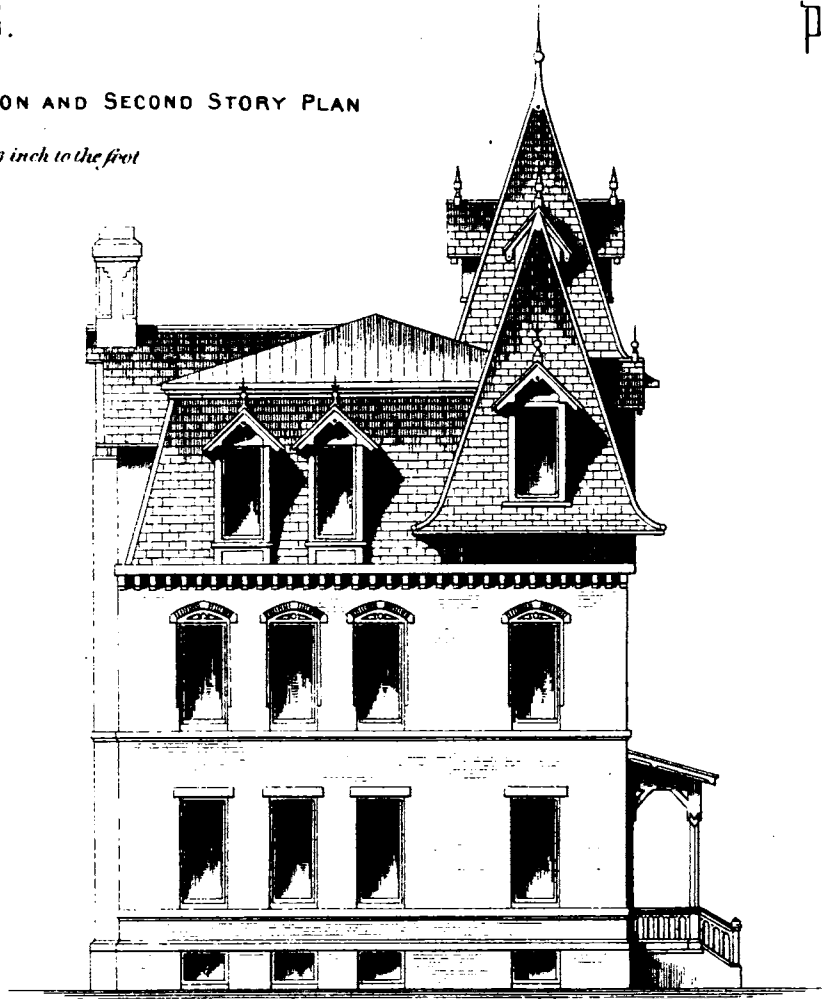

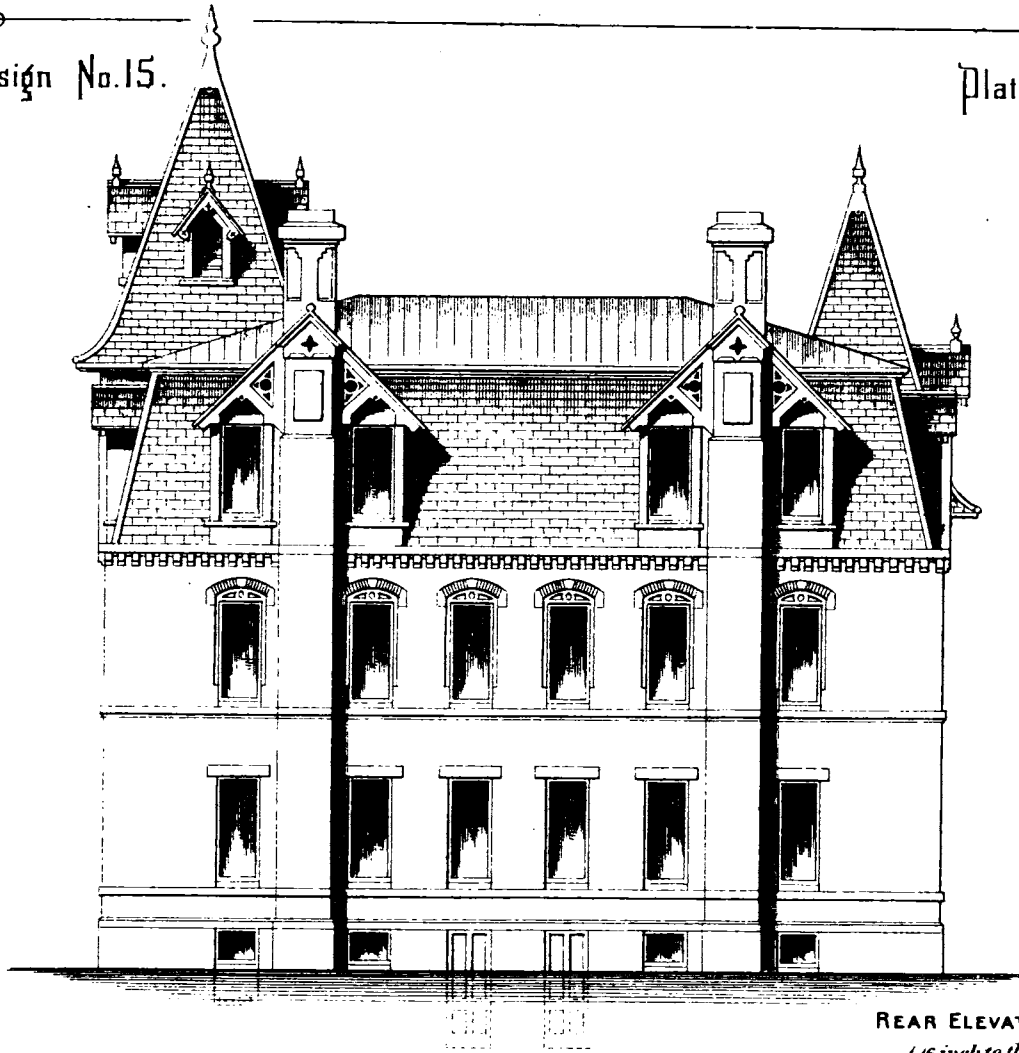

REAR ELEVATION
1/16 inch to the foot

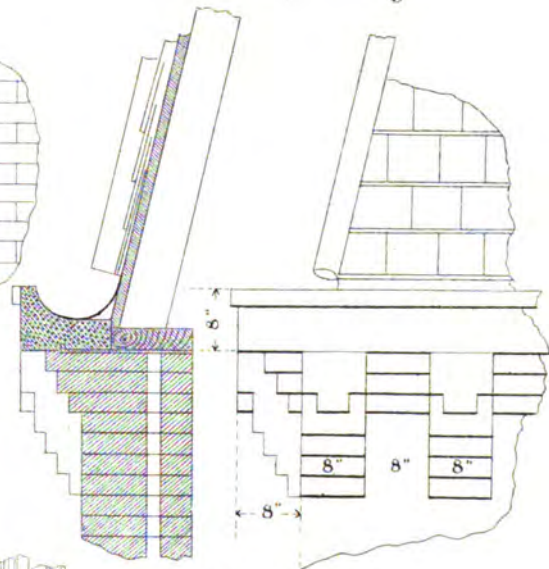
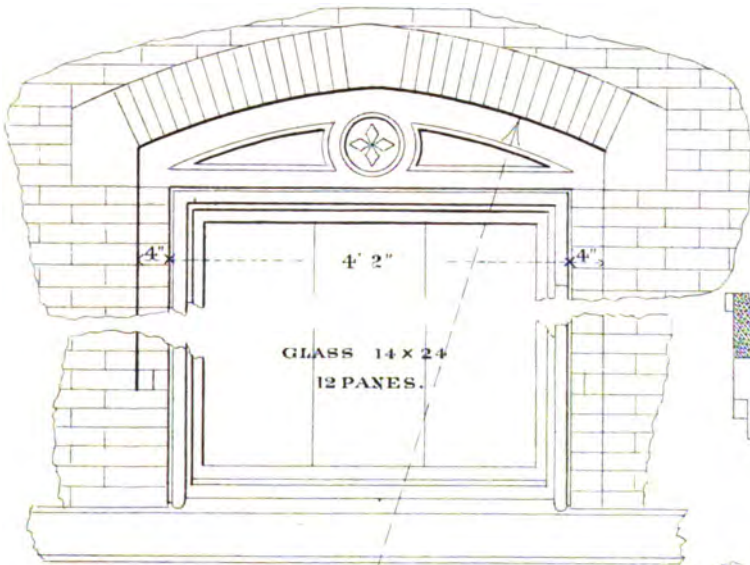

MAIN CORNICE

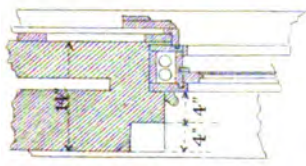

SECTION OF JAMB.

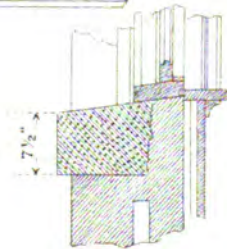

SECTION OF SILL

DETAILS *1/2 inch to the foot*

SECOND STORY WINDOWS.



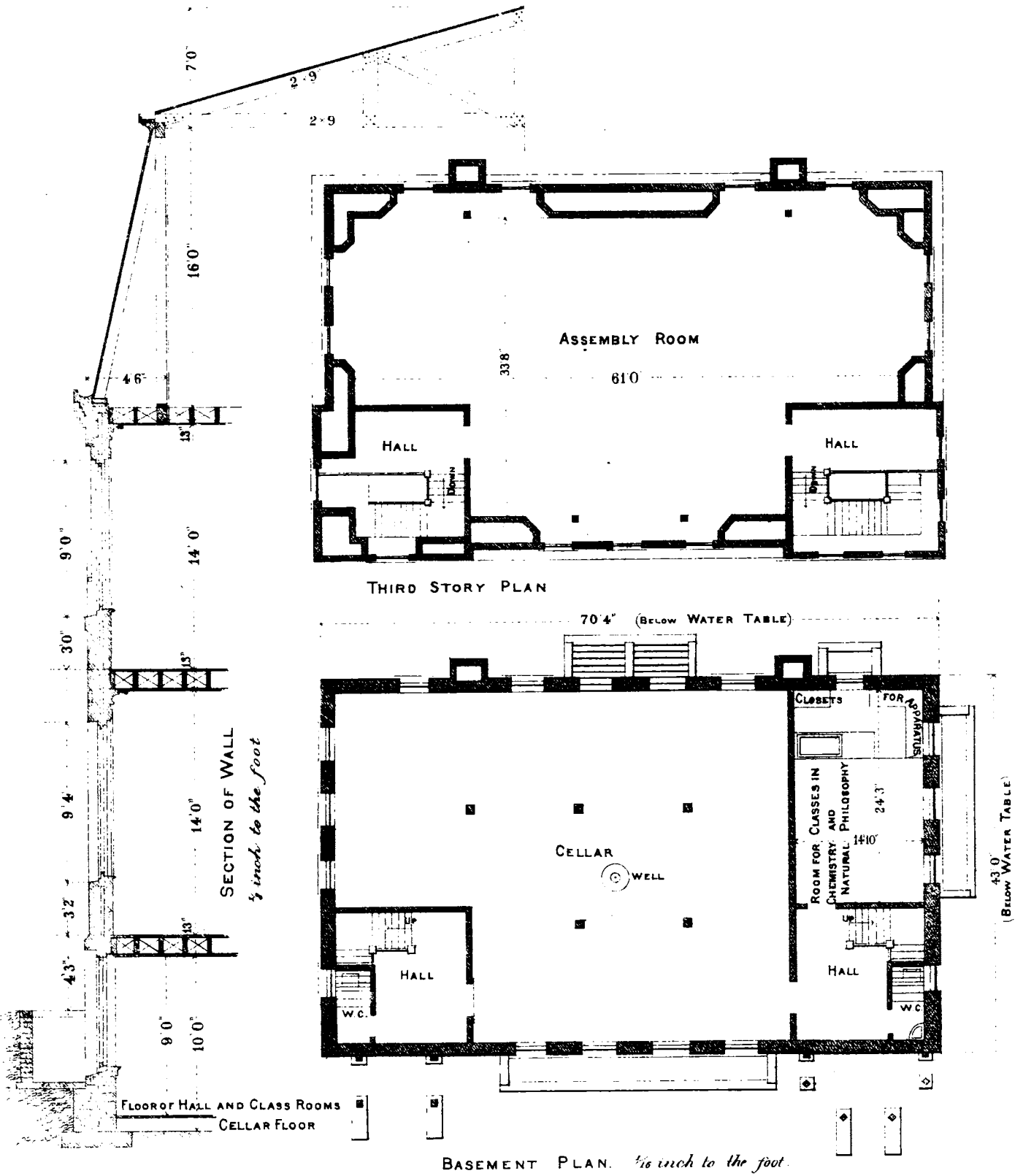

CHIMNEY AND
DROMERS CONNECTED WITH IT

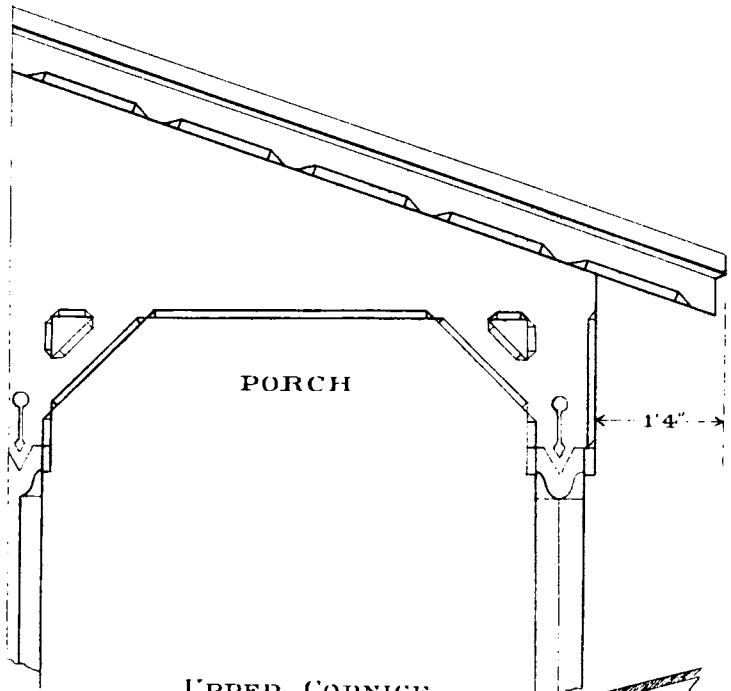

UPPER CORNICE
MAIN ROOF

Projects 10"

TOWER CORNICE

1'2" 3'7" 8"

A

B

SECTION ON A. B.
1 in. to the Foot.

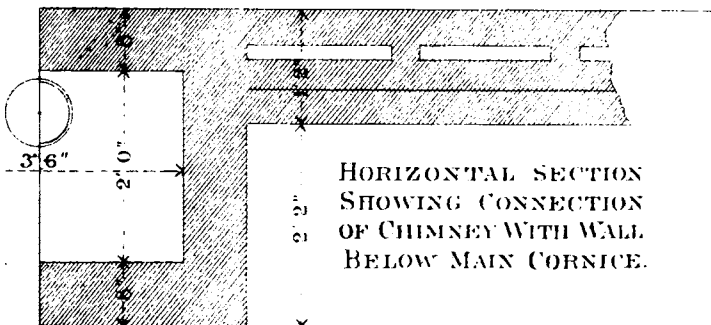

HORIZONTAL SECTION
SHOWING CONNECTION
OF CHIMNEY WITH WALL
BELOW MAIN CORNICE.

DESIGN NO. 16.

Plates 56, 57, 58, 59, and 60.

THIS design shows a frame building adapted to the uses of a town school.

Each room in the principal story and the second story, is large enough to accommodate 56 pupils, a number which is generally considered the greatest that should be assigned to one teacher.

The partitions are arranged so as to permit the three rooms to be thrown into one, when required. The third story may be treated in the same way, if desired, but is represented in the plan as being left entire.

Water-closets for the teachers' use are set in the basement, those for the pupils being outside the building, with passages to them from the basement, as shown in previous designs.

The arrangement of the ventilating apparatus is more complete than any before given in this work. The principles here employed were used by Mr. L. W. Leeds, of New York, for a school-house in Massachusetts, which came under the notice of the author of this book, and since the method will probably be best understood if the description is directed toward one portion of the system, the work in and immediately below the second floor will be selected for that description.

Under the cloak-rooms and the passages in the second story, a box is formed by furring down the first story ceiling to the height of 12 feet, and this box is divided by a vertical partition in the centre. The half of this box next the first story school-rooms serves as the ventilating duct for the upper part of these rooms, two registers being set in the wall for the purpose of opening and closing the connection. The half of the box next the hall serves as the ventilating duct for the lower part of the second story school-rooms, the connection being made through registers set in the floor opening into wooden tubes carried between the flooring-beams to the duct named (shown by dotted lines in the first story plan). The same system is carried out in the other stories, and all the ducts terminate in the vertical shaft in the centre, which is also divided into two parts, one for the top, and the other for the bottom ventilation.

This shaft is carried up above the roof, as shown by the drawings, and is covered by a roof of its own, with large openings beneath.

It encloses the chimney, the heat from which would furnish sufficient propelling power to the air in the ducts to secure good ventilation, when the heating apparatus were in use. At other times it would be necessary to derive the power from gas-jets burning in the shaft, or from a small stove set in a continuation of it.

The partitions at either side of the chimney, dividing the vertical shaft, should be built of brick, to avoid danger from fire.

The ceilings of the halls are furred down to the same height as those in the cloak-rooms and passages.

Design No. 16.

Plate No. 56.

FRONT ELEVATION
AND PRINCIPAL FLOOR PLAN
1/32 inch to the foot

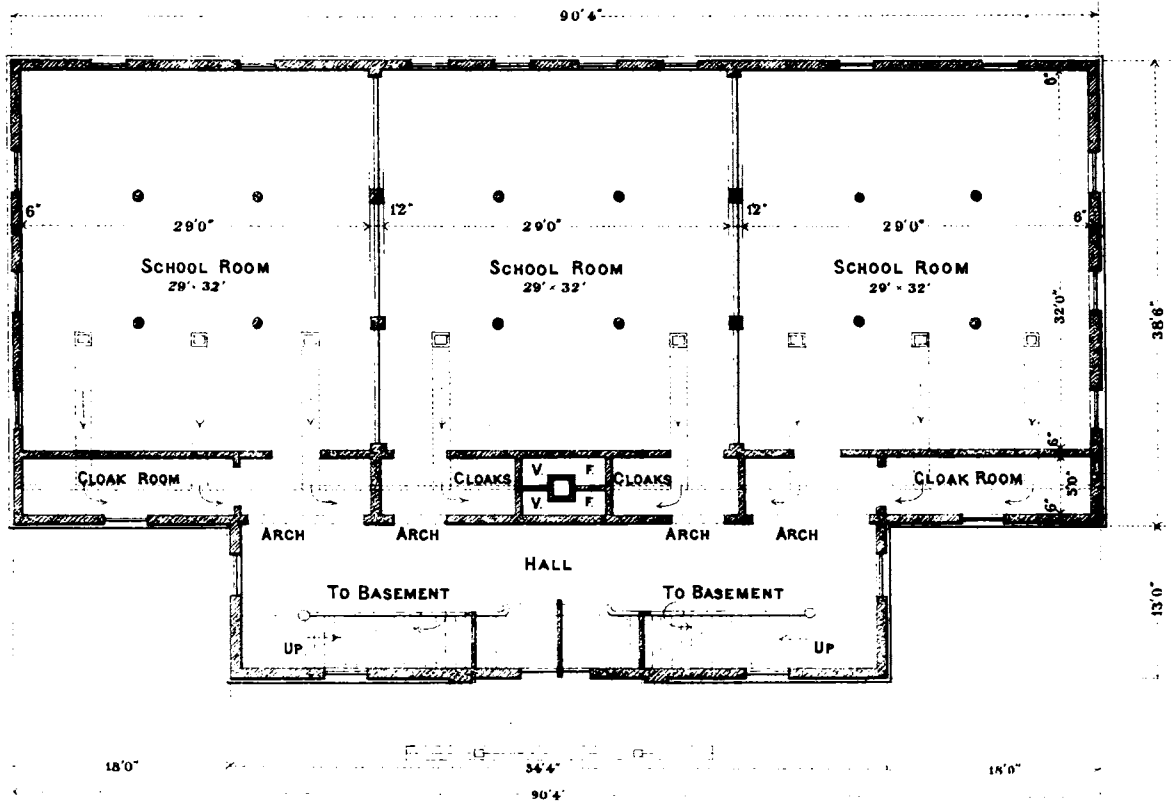
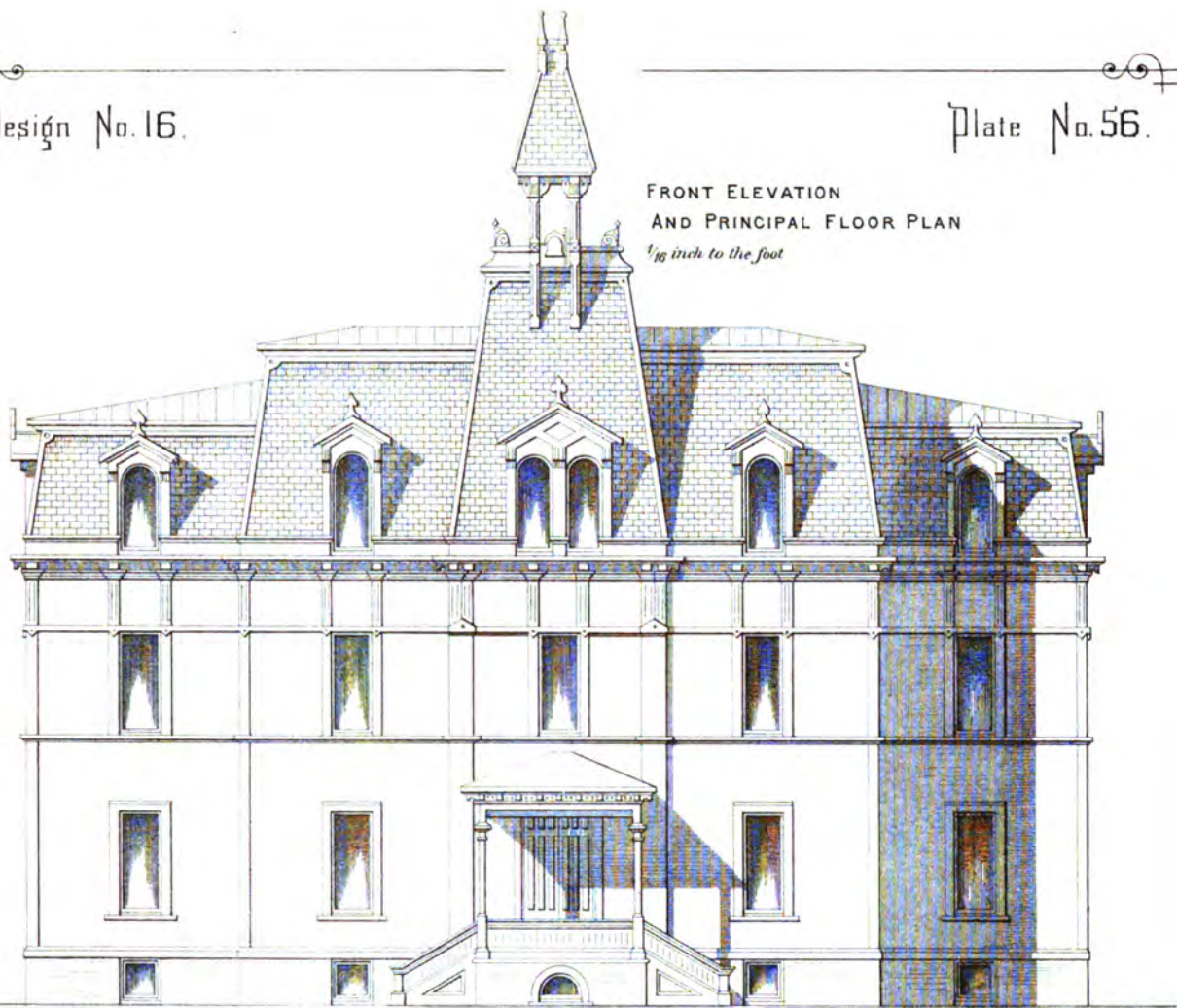

END ELEVATION AND BASEMENT PLAN
1/16 inch to the foot

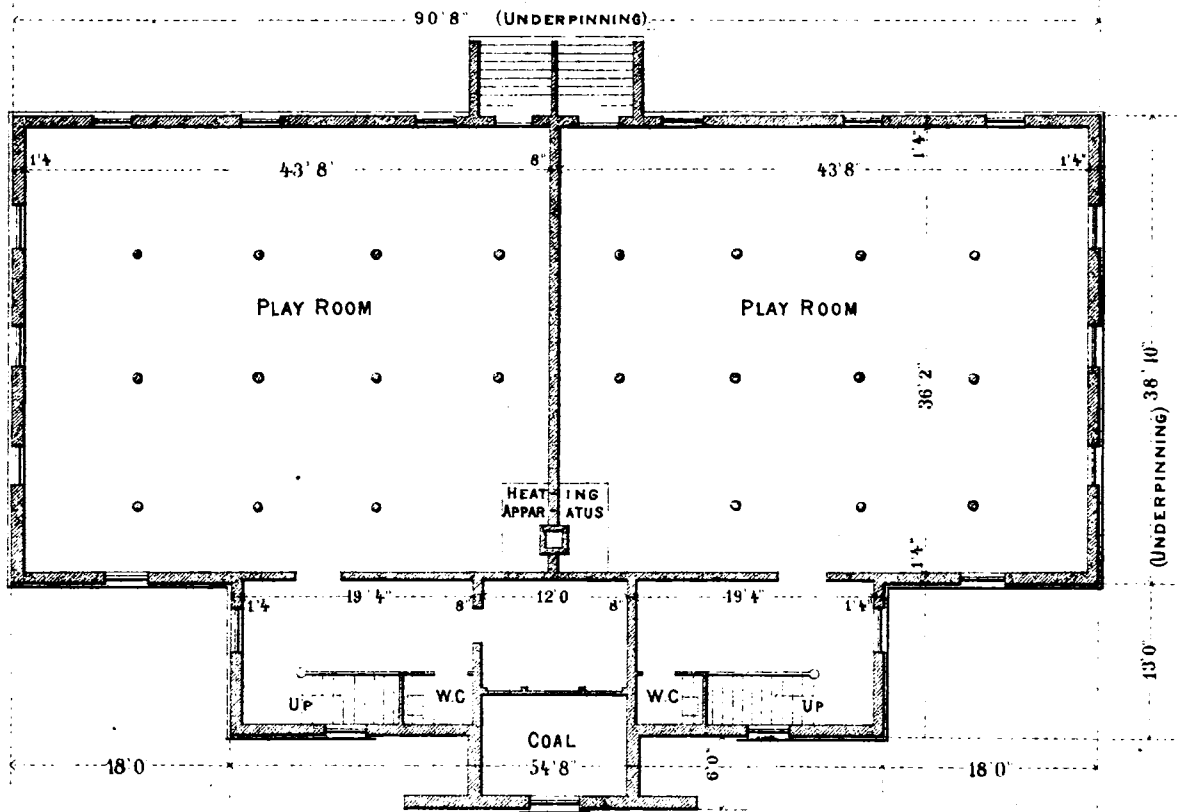
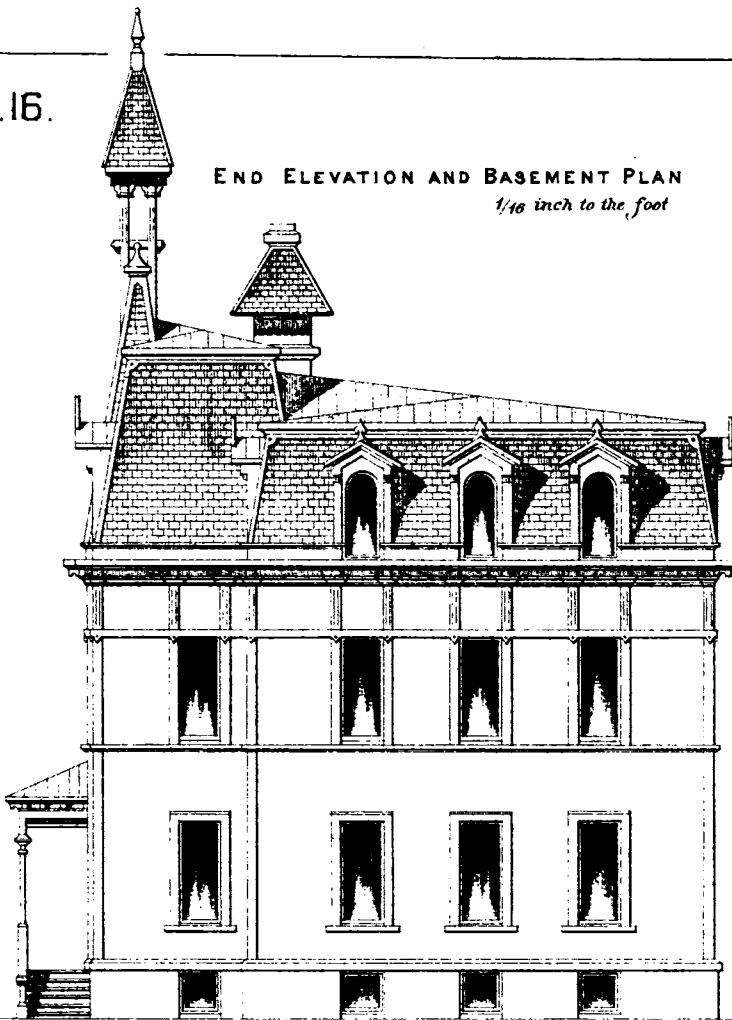

SECOND AND THIRD STORY PLANS.
1/8 inch to the foot.

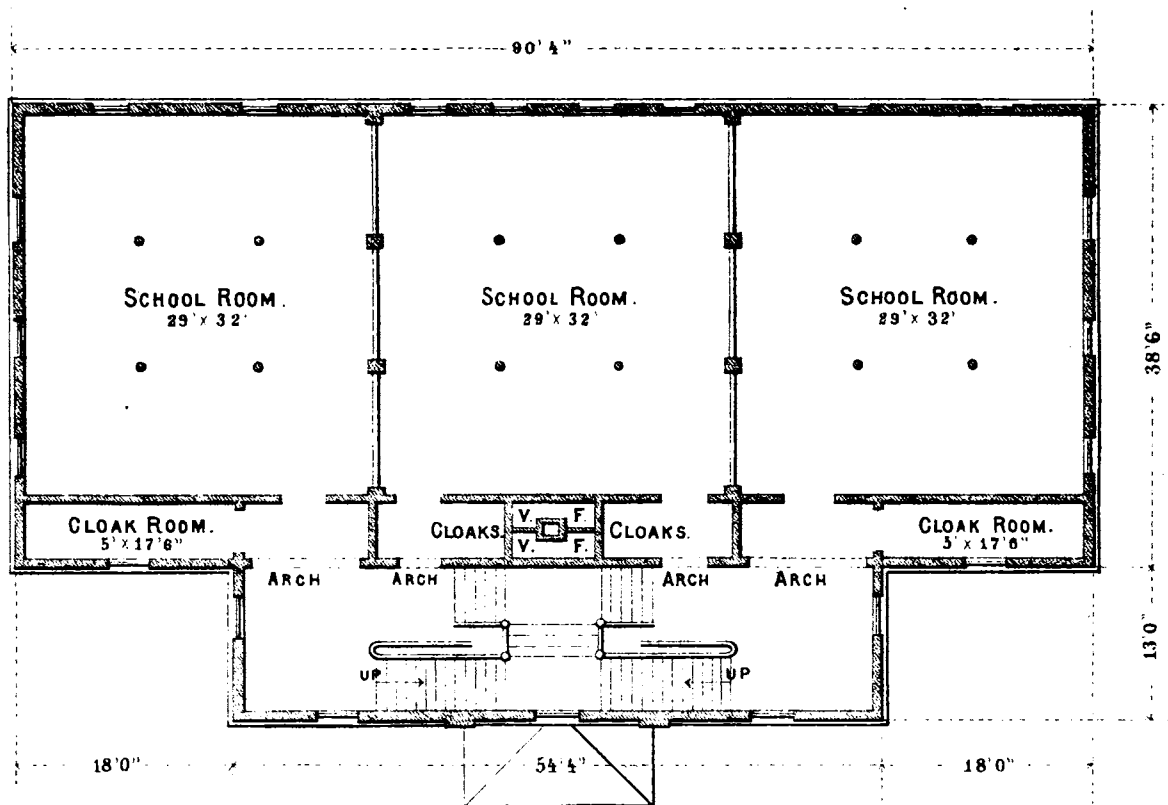
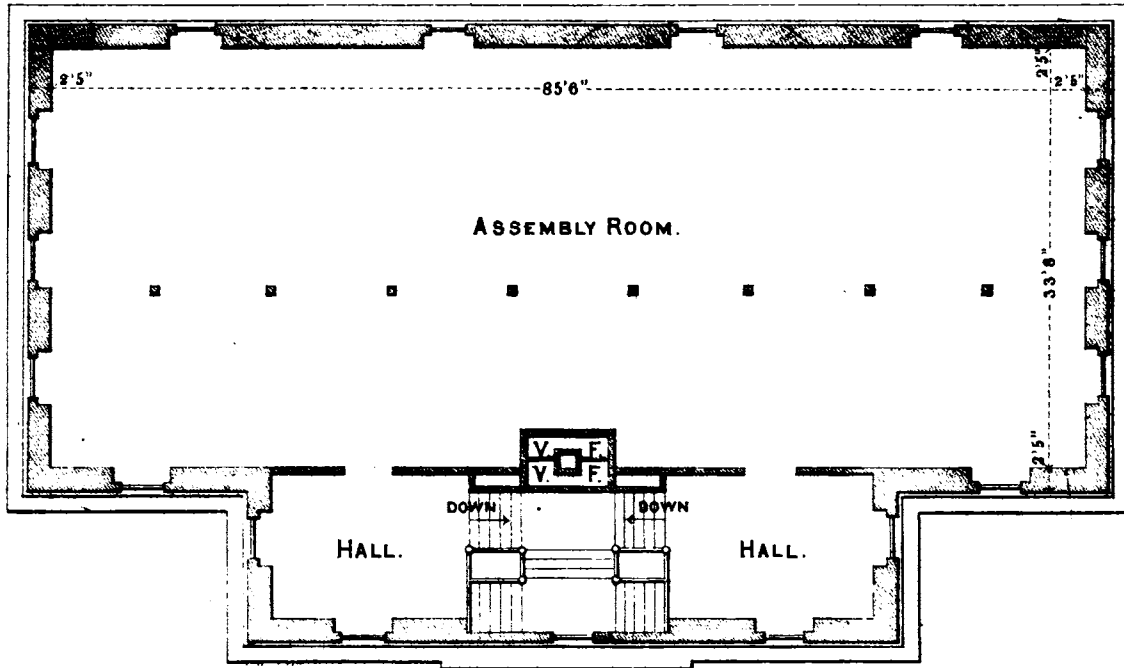

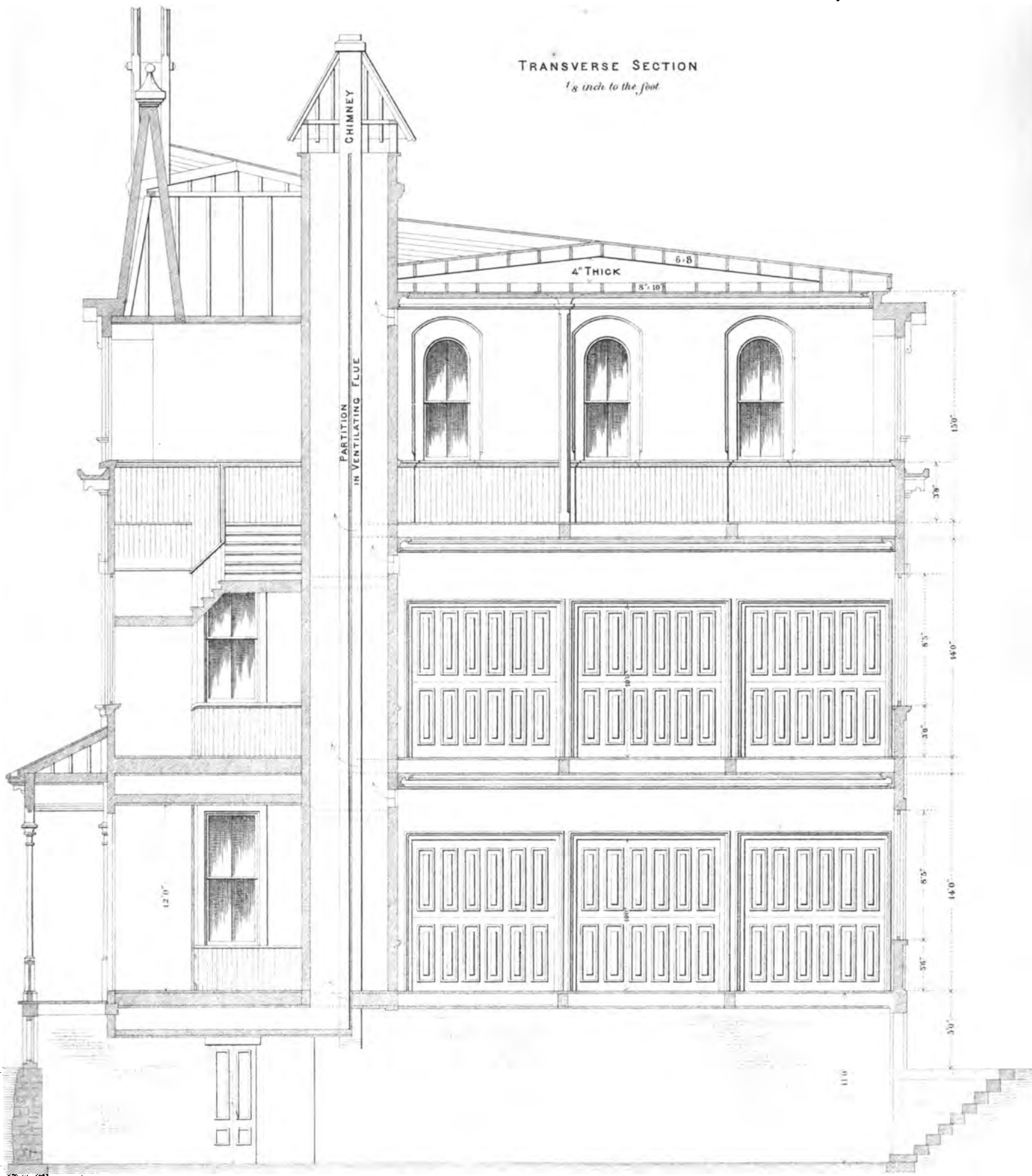

TRANSVERSE SECTION
1/8 inch to the foot

CHIMNEY
PARTITION
IN VENTILATING FLUE

4" THICK

6:8

8' 10"

12' 0"

13' 0"

3' 6"

8' 3"

14' 0"

3' 0"

6' 5"

14' 0"

3' 6"

3' 0"

110



DETAILS.

1/2 INCH TO THE FOOT.

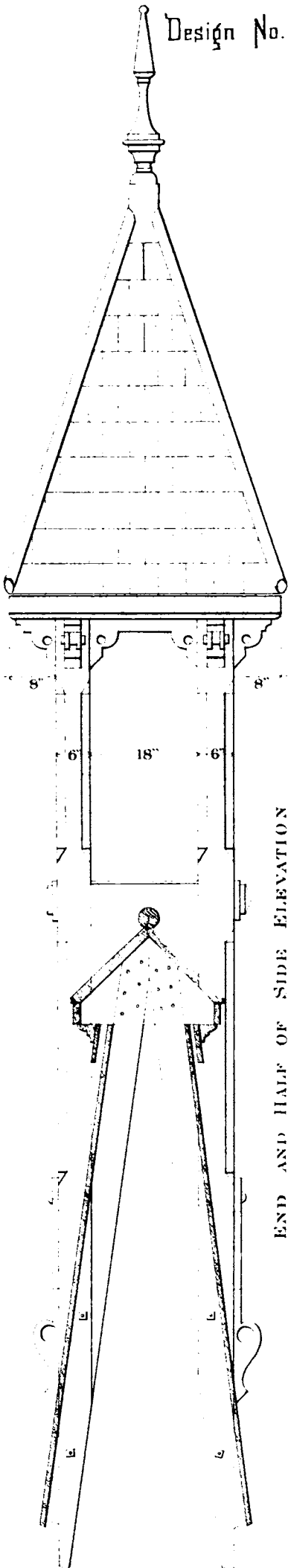

END AND HALF OF SIDE ELEVATION

BELL TOWER.

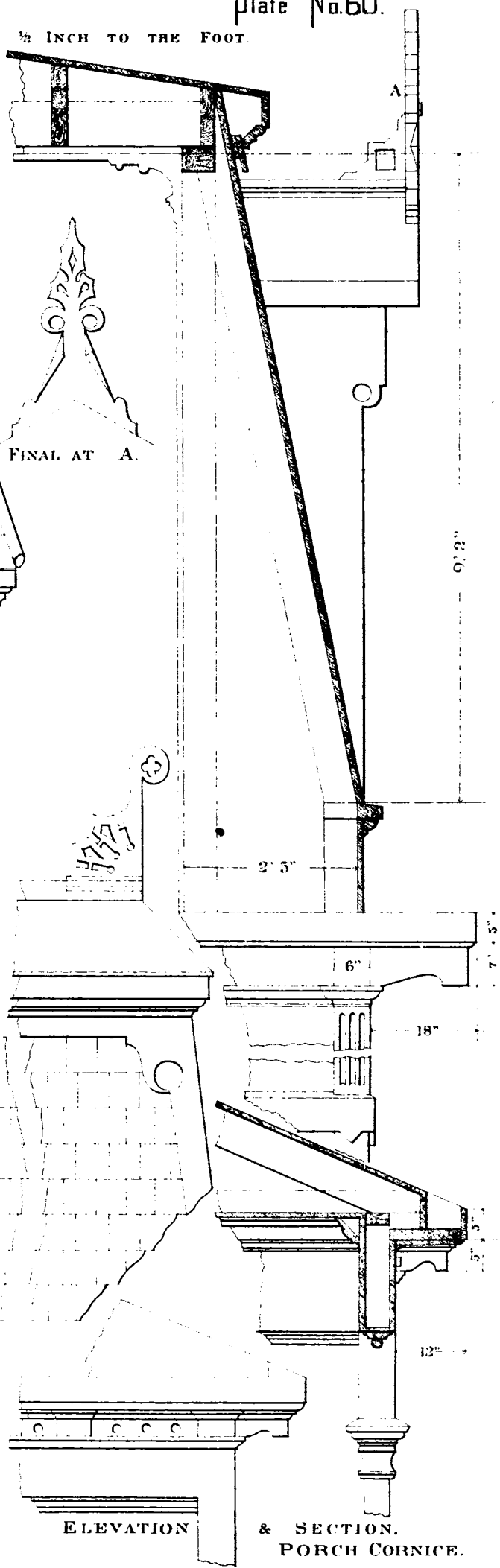
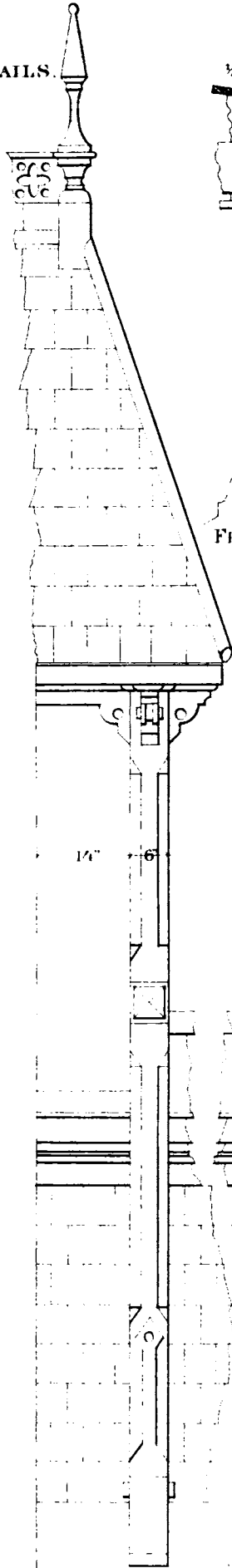

ELEVATION

& SECTION.
PORCH CORNICE.



DESIGN NO. 17.

Plates 61, 62, 63, 64, 65 and 66.

THIS design exhibits a town School-house, to accommodate a school of eight classes of 56 pupils each.

The accommodations might be increased to twelve classes, by dividing the third story as the other stories are divided. In that case the partitions should be arranged as shown in Design 16, so as to adapt the third story rooms for the use of larger classes.

This design is intended to be executed in brick, with cut-stone finish for the windows and for the belt-courses.

The small rooms at either side of the stairs are cut in two by floors level with the landings in the stairs, the upper portions serving as closets for the teachers' use.

The lavatories in the basement are also designed for the use of the teachers.

The detailed drawing in Plate No. 65 shows the expedient adopted to secure the ventilation of the lower part of the school-rooms, the flues shown in the drawing connecting with one side of the chimney, while the ventilating registers set at the top of the rooms connect with the other side, the partition separating the two parts of the chimney containing the smoke-flue. The heating is designed to be effected by using steam apparatus, the vertical pipes being set in the chimneys.



Design No. 17.

Plate No. 61.

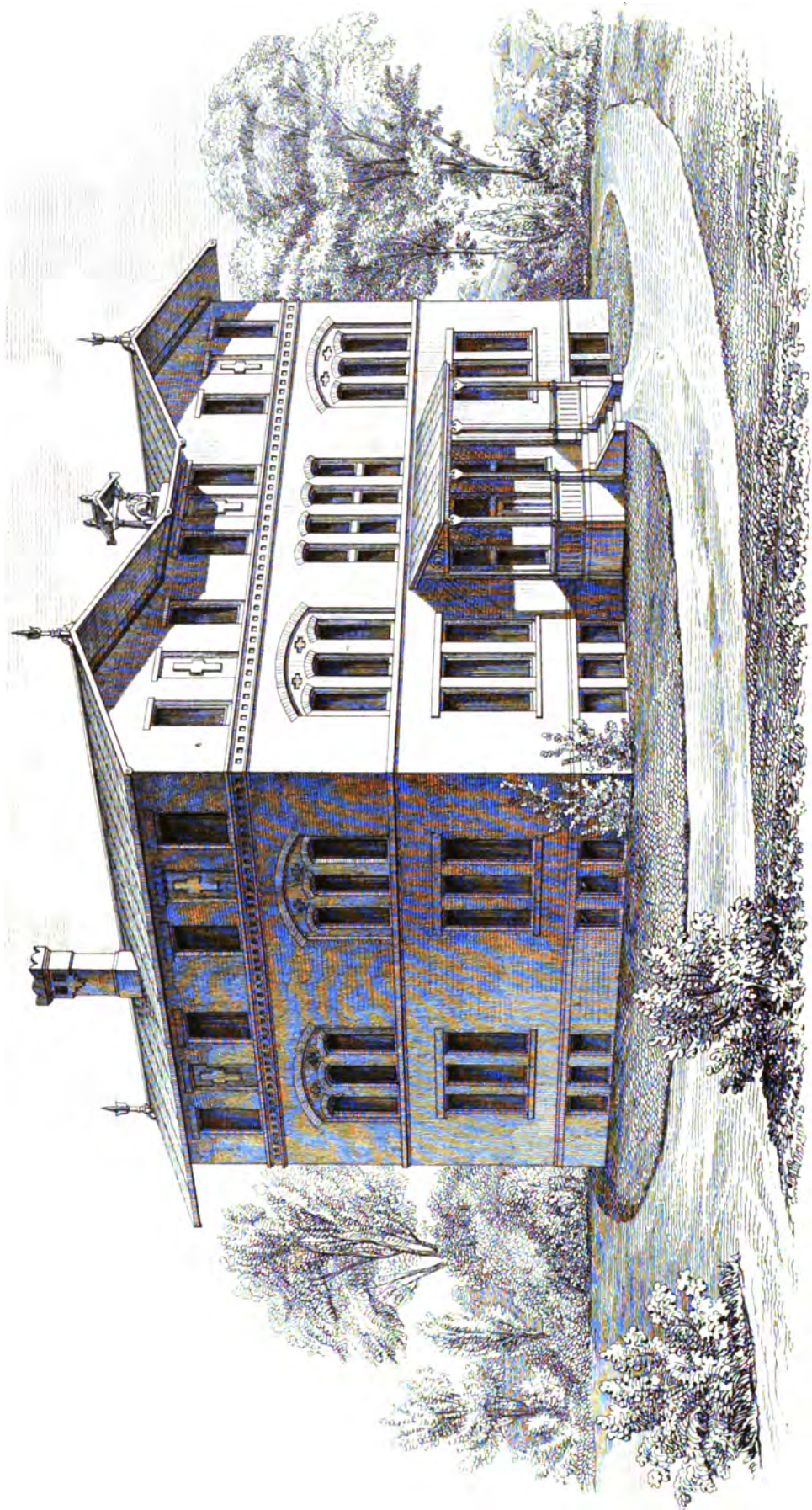



ELEVATION AND PRINCIPAL FLOOR PLAN *1/16 inch to the foot*

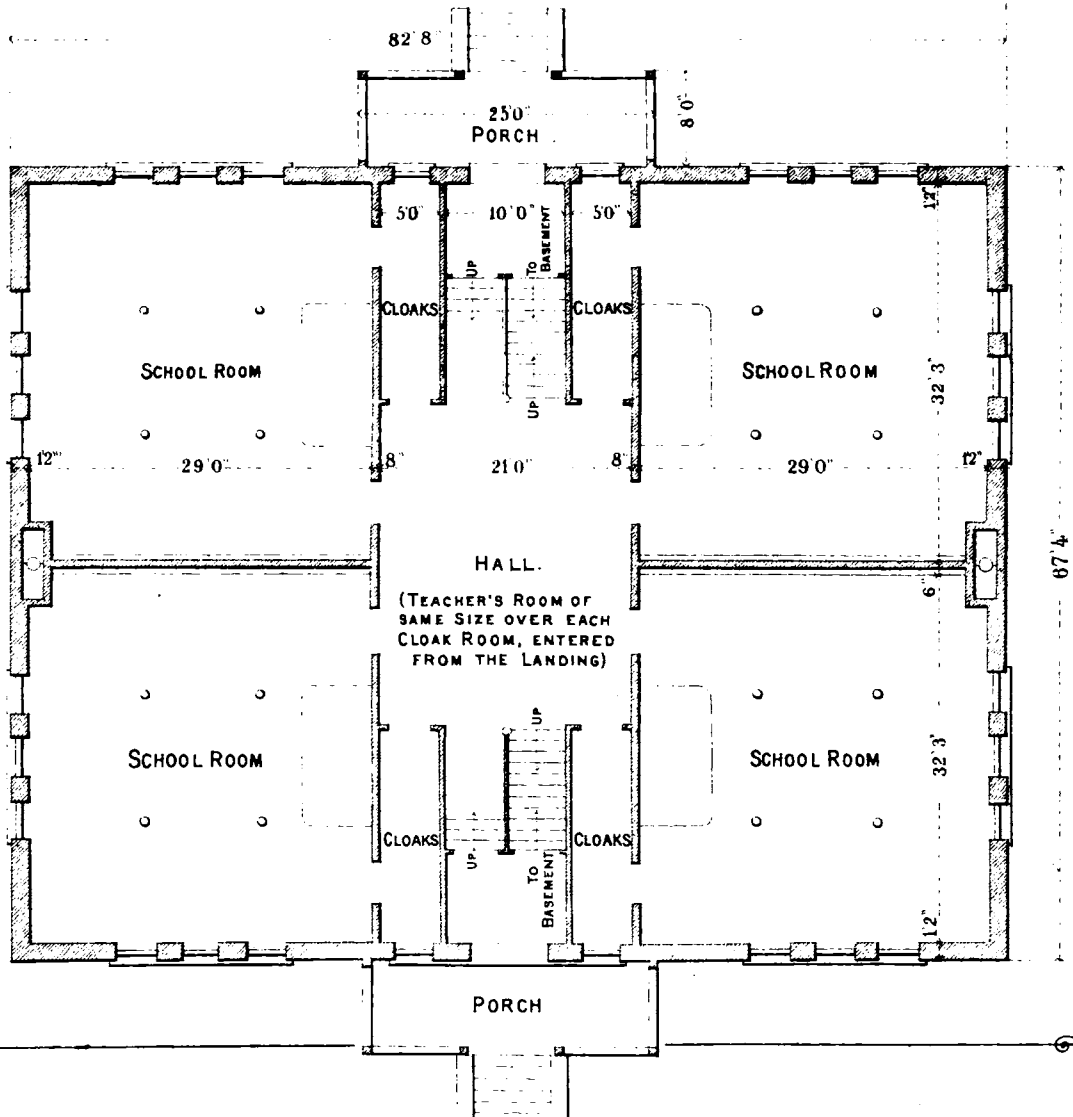
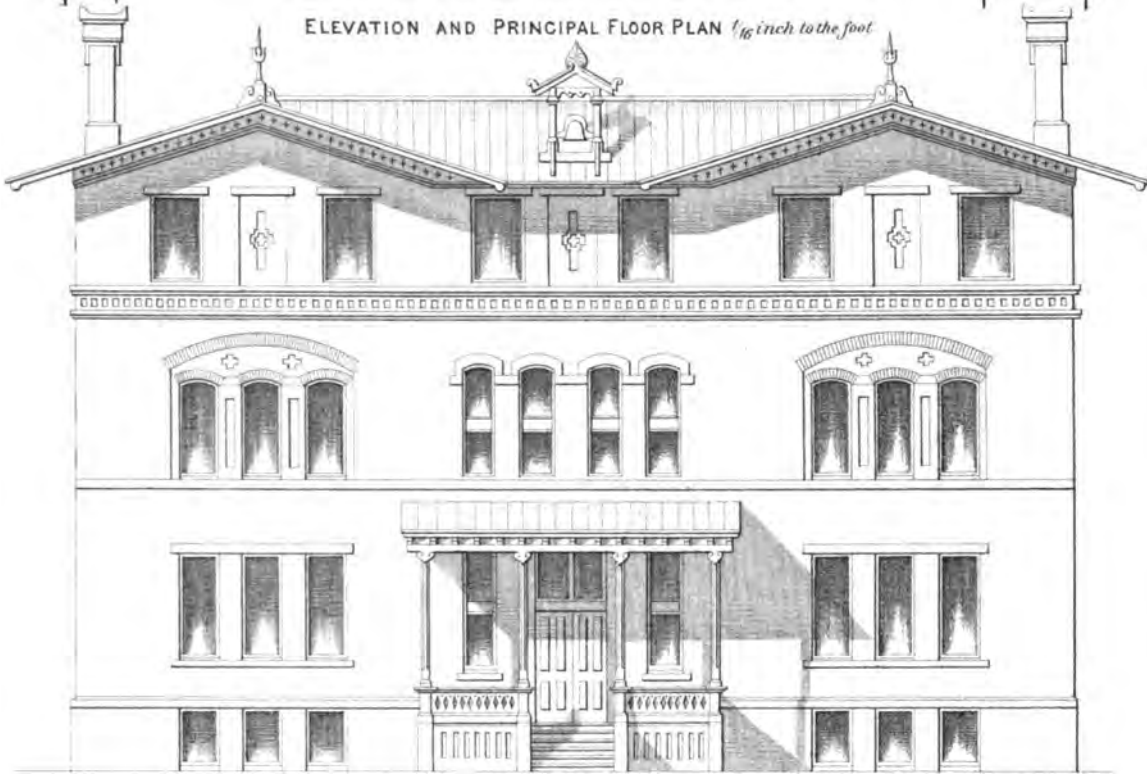



ELEVATION AND BASEMENT PLAN
1/16 inch to the foot

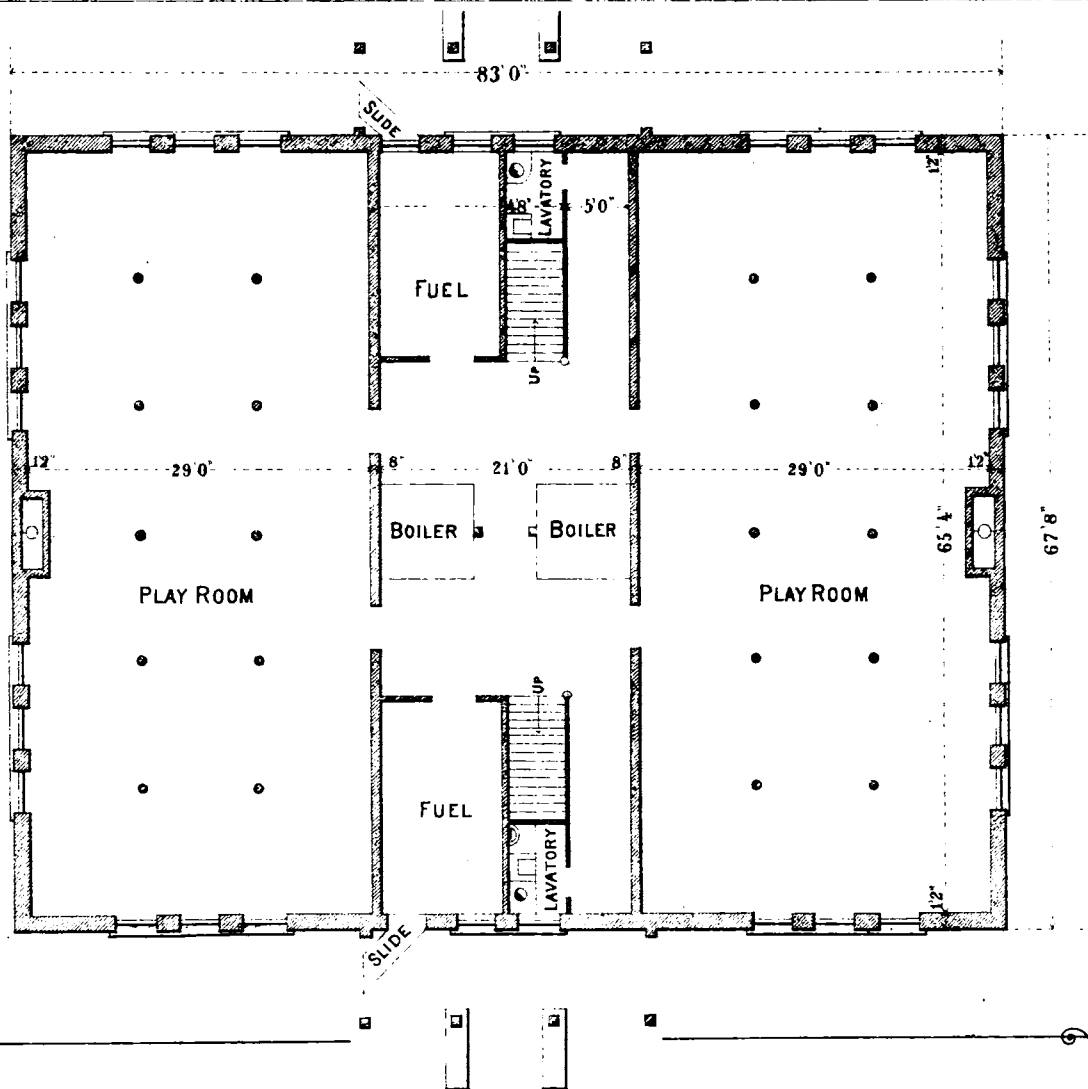
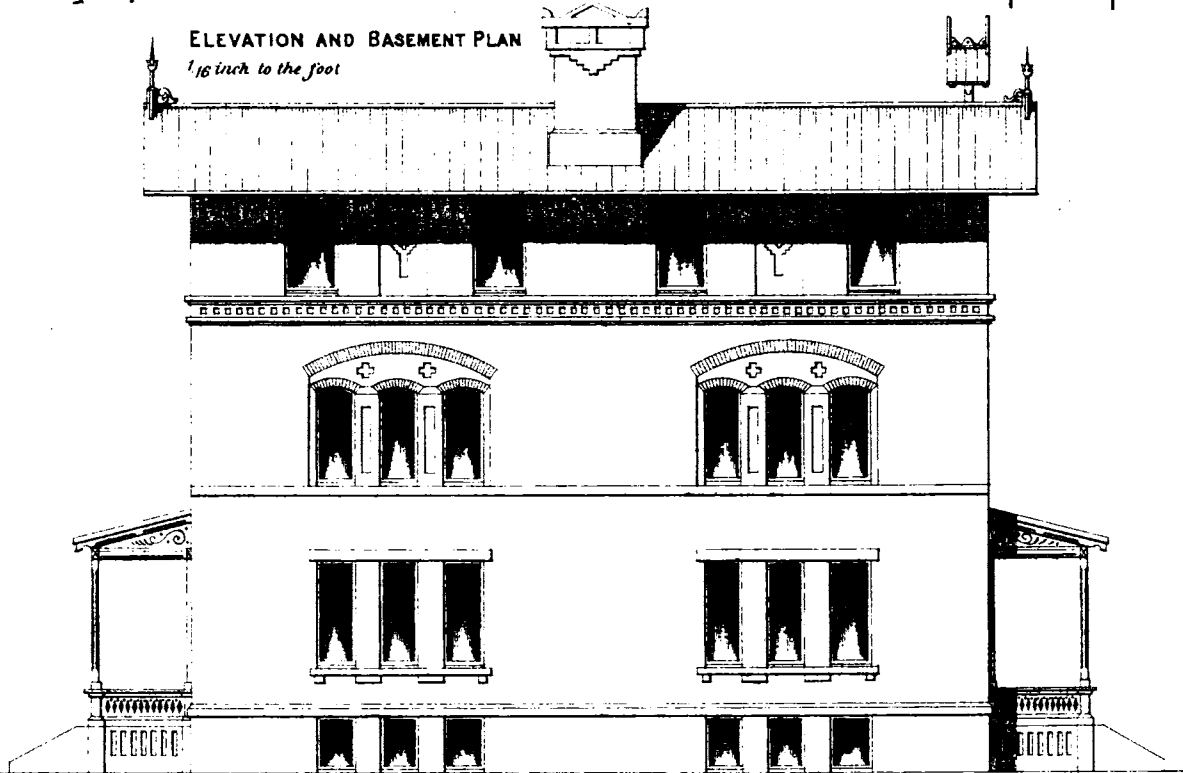



SECOND AND THIRD FLOOR PLANS.
1/16 inch to the foot.

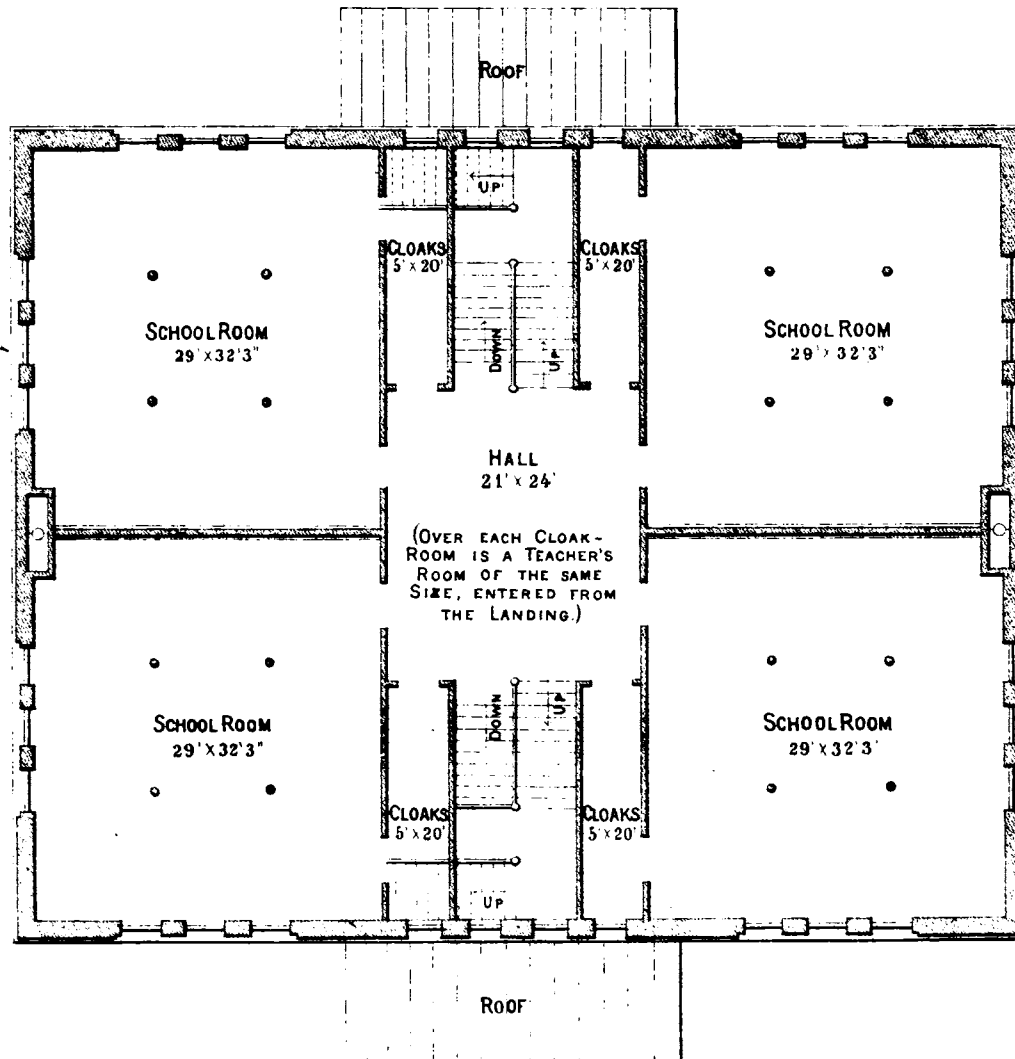
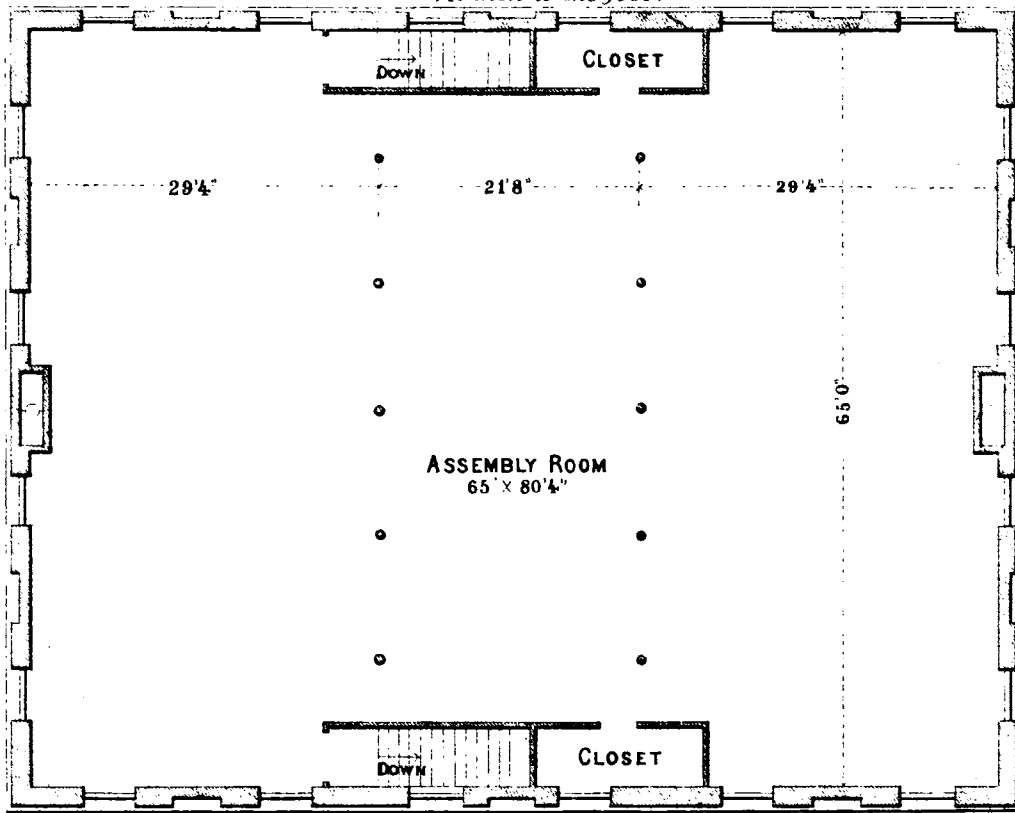



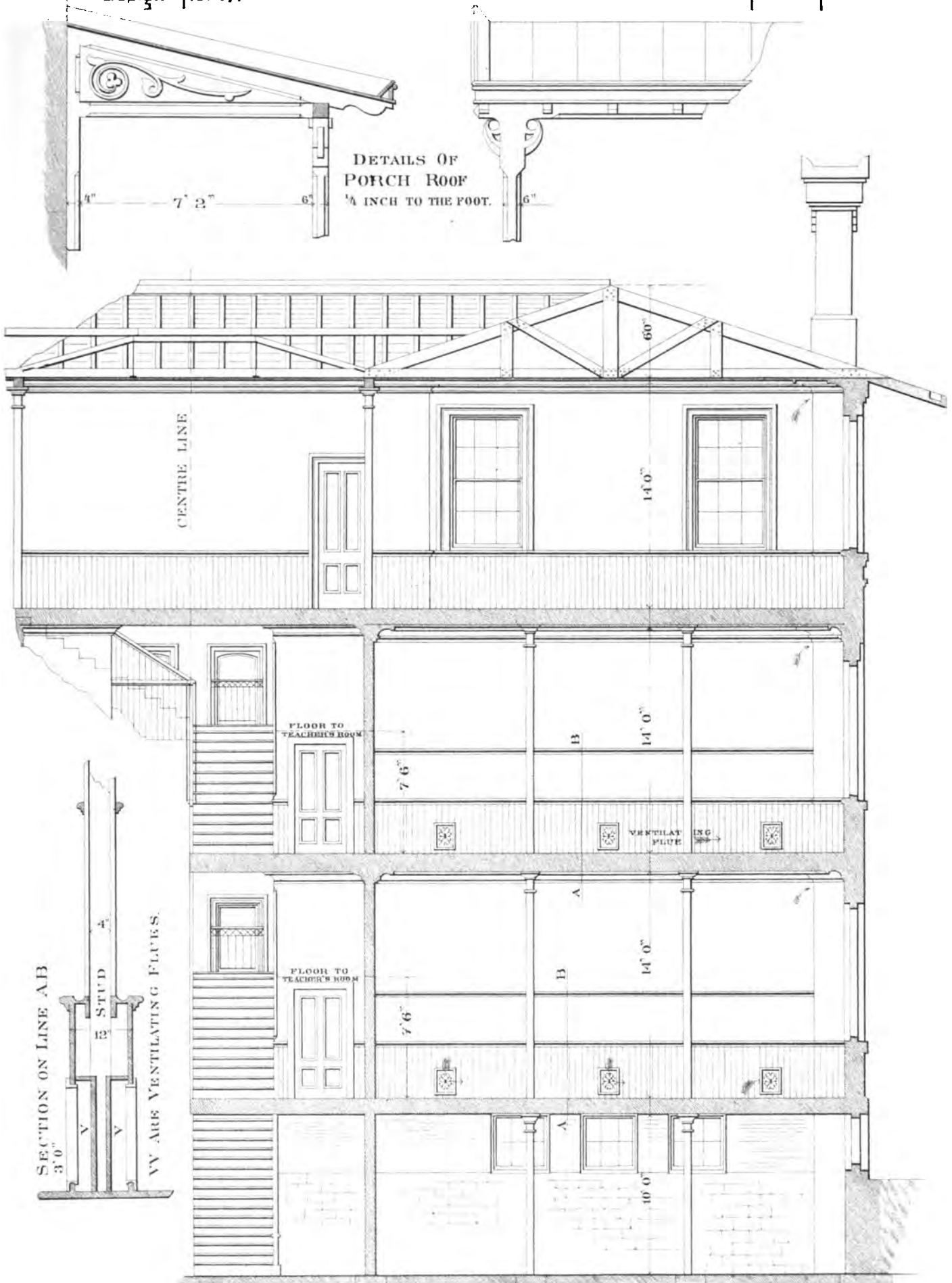

HALF LONGITUDINAL SECTION 1/8 INCH TO THE FOOT.

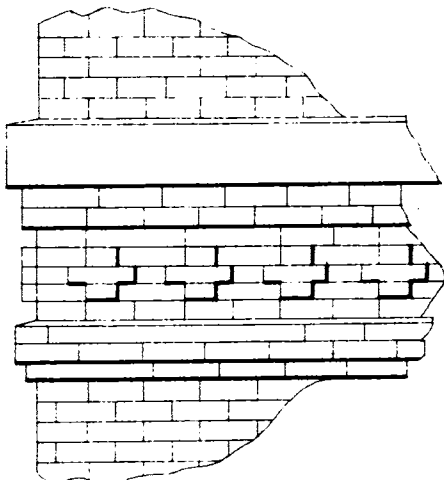

BELT BELOW 3^d STORY WINDOWS

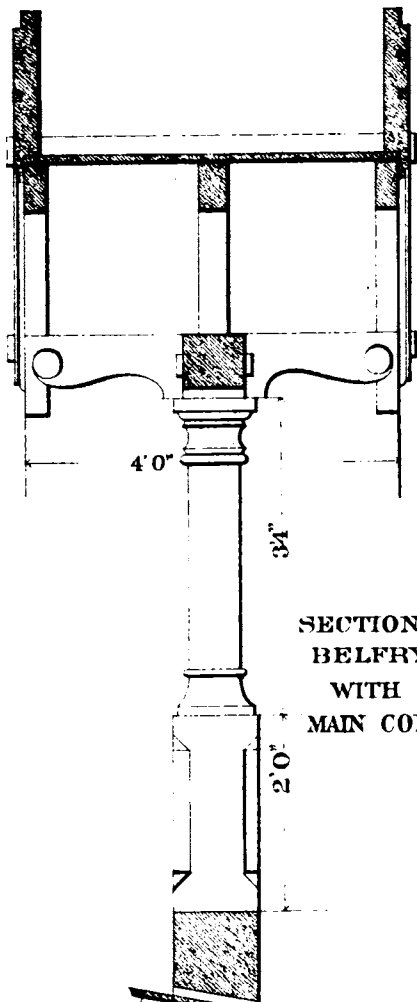
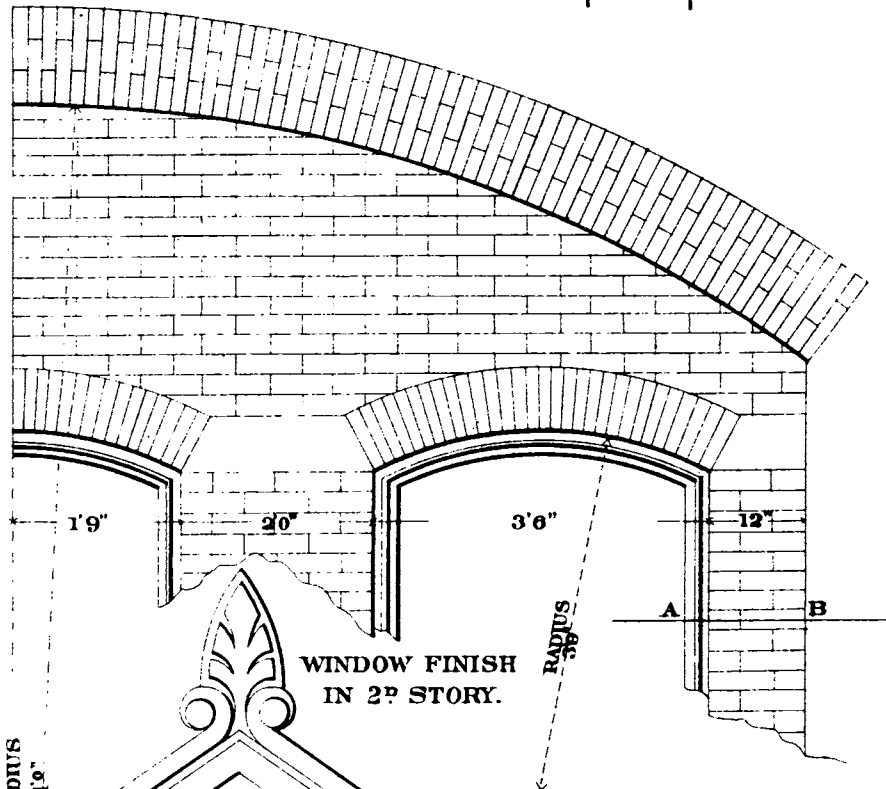

SECTION OF BELFRY, WITH MAIN CORNICE.

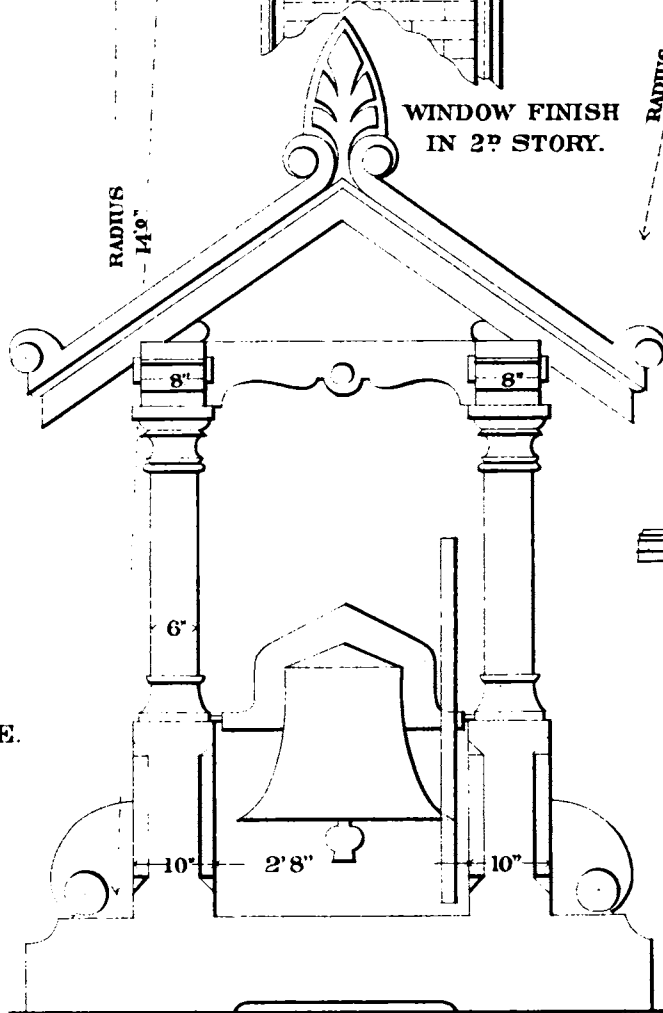

ELEVATION OF BELFRY

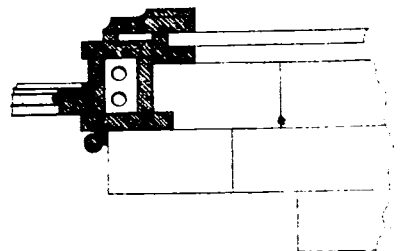

SECTION ON LINE AB. IN TO THE FOOT.

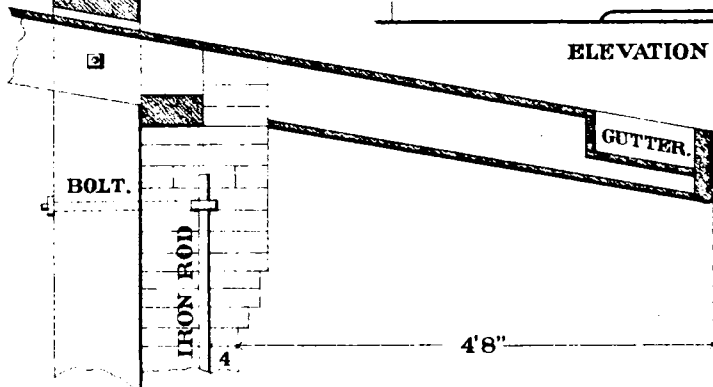

DETAILS. 1/2 INCH TO THE FOOT.

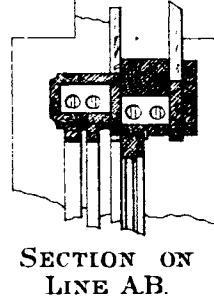
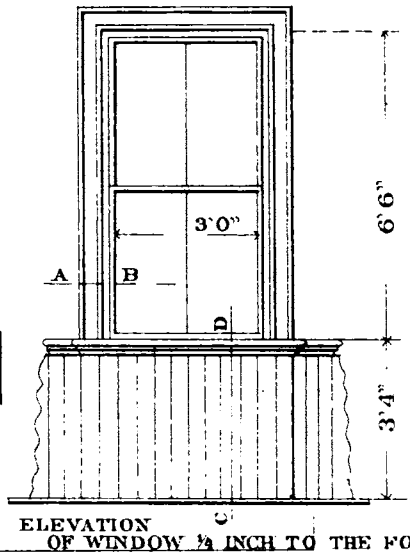
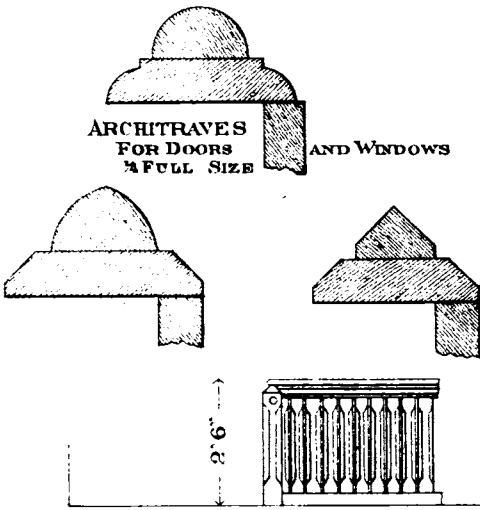

3/4 INCH TO THE FOOT.
SECTION ON LINE CD
SHOWING BLINDS LOWERED
INTO BOX.

